



**CONFORMANCE TEST REPORT
FOR
FCC Part 15, subpart D**

Report No.: 17-07-MAS-112-01

Client: Lightspeed Technologies Inc.
Product: TRX-POD
Model: POD
FCC ID: ORV-LSP0D

Manufacturer/supplier: REOR ELECTRONICS CO., LTD.

Date test item received: 2017/07/20
Date test campaign completed: 2017/08/15
Date of issue: 2017/08/24

The test result only corresponds to the tested sample. It is not permitted to copy this report, in part or in full, without the permission of the test laboratory.
Total number of pages of this test report: 85 pages
Total number of pages of photos: External photos 3 pages
Internal photos 4 pages
Setup photos 5 pages



Test Engineer	Checked By	Approved By
 John Li	 Falcon Shi	 Jerry Huang

Table of Contents Page

- 1 GENERAL INFORMATION 4**
- 1.1 Testing Laboratory 4
- 1.2 Client Information 4
- 1.3 Manufacturer 4
- 2 TEST INFORMATION..... 5**
- 2.1 Description of Tested Device(s)..... 5
- 2.2 Test Environment 5
- 3 TEST REPORT SUMMARY 6**
- 3.1 Test Summary 6
- 3.2 Other Comments 7
- 4 TEST SETUP..... 8**
- 4.1 Frequency and Timing Measurements 8
- 4.2 Conducted Emission Tests 8
- 4.3 Radiated Emission Tests 9
- 4.4 Power line Conducted Tests 9
- 4.5 Monitoring Tests 10
- 5 TEST EQUIPMENT LIST..... 11**
- 6 TEST RESULT 12**
- 6.1 Cross Reference 12
- 6.2 Field Strength Calculation..... 16
- 6.3 Labeling Requirements 17
- 6.4 Power line Conducted Emissions 18
- 6.5 Result Data Calculation..... 21
- 6.6 Antenna Requirement 22
- 6.7 Digital Modulation Techniques 23
- 6.8 Peak Transmit Power 24
- 6.9 Power Spectral Density..... 28
- 6.10 Antenna Gain..... 32
- 6.11 Automatic discontinuation of transmission..... 32
- 6.12 Safety exposure levels 33
- 6.13 Emission Bandwidth B 34
- 6.14 Monitoring time 38
- 6.15 Monitoring threshold 39

6.16 Maximum transmit period	40
6.17 System Acknowledgement	42
6.18 Least Interfered Channel, LIC	47
6.19 Random waiting	54
6.20 Monitoring bandwidth and reaction time	55
6.21 Monitoring antenna	62
6.22 Monitoring threshold relaxation	63
6.23 Duplex system LBT	64
6.24 Co-located device LBT	65
6.25 Fair Access	66
6.26 Emissions inside and outside the subband	67
6.27 Frame period and jitter	80
6.28 Carrier frequency stability	84

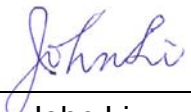
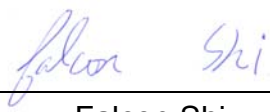
1 GENERAL INFORMATION

1.1 Testing Laboratory

Name: Electronic Testing Center, Taiwan
Address: No.8, Lane 29, Wenming Rd. Guishan Dist.
Taoyuan City 33383, Taiwan, R.O.C.
Telephone: 886-3-3280026
Fax: 886-3-3276188
NVLAP lab registration #: 200133-0
FCC Registration Number: TW0371, TW1112
Industry Canada Site IC 2949A-2
Registration Number:

1.2 Client Information

Name: Lightspeed Technologies Inc.
Address: 11509 SW Herman Road, Tualatin, OR 97062, USA
Telephone: 503-684-5538
Contact person: Mike Frost

1.3 Manufacturer

Name: REOR ELECTRONICS CO., LTD.
Address: 5F., No. 122, Cioahe Rd., Jhonghe Dist., New Taipei City
23558, Taiwan.

2 TEST INFORMATION

2.1 Description of Tested Device(s)

The tested equipment is a DECT Handset that complies with ETSI EN 300175. The frequencies have been reprogrammed to comply with the FCC and IC requirements to an Isochronous UPCS device after FCC Part 15D and Industry Canada RSS-213 Issue 3.

The EUT is a responding device as described in ANSI C63.17-2013 and is designed to operate together with a DECT base station, which is then the initiating device.

Frequency Channel	Frequency	Test Frequency
CH4	1921.536 MHz	F _L
CH3	1923.264 MHz	-
CH2	1924.992 MHz	F _M
CH1	1926.720 MHz	-
CH0	1928.448 MHz	F _H

2.2 Test Environment

Normal test condition

Temperature:	20 - 25 °C
Relative humidity:	55 - 75%

Extreme test condition (declared by manufacturer)

Please see the manufacturer declaration form.

3 TEST REPORT SUMMARY**3.1 Test Summary**

Requirement	FCC Paragraph #	Required	Customer Declaration	Test Pass
Cross Reference	15.33 (a), 15.309(b)	<input checked="" type="checkbox"/>	<input type="checkbox"/>	<input checked="" type="checkbox"/>
Labeling requirements	15.311,15.19(a)(3)	<input checked="" type="checkbox"/>	<input checked="" type="checkbox"/>	<input type="checkbox"/>
Power line Conducted Emission	15.315,15.207	<input checked="" type="checkbox"/>	<input checked="" type="checkbox"/>	<input checked="" type="checkbox"/>
Antenna Requirement	15.317, 15.203	<input checked="" type="checkbox"/>	<input checked="" type="checkbox"/>	<input type="checkbox"/>
Digital Modulation Techniques	15.319(b)	<input checked="" type="checkbox"/>	<input checked="" type="checkbox"/>	<input type="checkbox"/>
Peak transmit Power	15.319(c)	<input checked="" type="checkbox"/>	<input type="checkbox"/>	<input checked="" type="checkbox"/>
Power Spectral Density	15.319(d)	<input checked="" type="checkbox"/>	<input type="checkbox"/>	<input checked="" type="checkbox"/>
Antenna gain	15.319(e)	<input checked="" type="checkbox"/>	<input checked="" type="checkbox"/>	<input type="checkbox"/>
Automatic discontinuation of transmission	15.319(f)	<input checked="" type="checkbox"/>	<input checked="" type="checkbox"/>	<input type="checkbox"/>
Safety exposure levels	15.319(i)	<input checked="" type="checkbox"/>	<input type="checkbox"/>	<input checked="" type="checkbox"/>
Emission Bandwidth	15.323(a)	<input checked="" type="checkbox"/>	<input type="checkbox"/>	<input checked="" type="checkbox"/>
Monitoring time	15.323(c)(1)	<input checked="" type="checkbox"/>	<input type="checkbox"/>	<input checked="" type="checkbox"/>
Monitoring threshold	15.323(c)(2)	<input checked="" type="checkbox"/>	<input checked="" type="checkbox"/>	<input type="checkbox"/>
Maximum transmit period	15.323(c)(3)	<input checked="" type="checkbox"/>	<input type="checkbox"/>	<input checked="" type="checkbox"/>
System acknowledgement	15.323(c)(4)	<input checked="" type="checkbox"/>	<input type="checkbox"/>	<input checked="" type="checkbox"/>
Least Interfered Channel, LIC	15.323(c)(5)	<input checked="" type="checkbox"/>	<input type="checkbox"/>	<input checked="" type="checkbox"/>
Random waiting	15.323(c)(6)	<input checked="" type="checkbox"/>	<input checked="" type="checkbox"/>	<input type="checkbox"/>
Monitoring bandwidth and reaction time	15.323(c)(7)	<input checked="" type="checkbox"/>	<input type="checkbox"/>	<input checked="" type="checkbox"/>
Monitoring antenna	15.323(c)(8)	<input checked="" type="checkbox"/>	<input checked="" type="checkbox"/>	<input type="checkbox"/>
Monitoring threshold relaxation	15.323(c)(9)	<input checked="" type="checkbox"/>	<input type="checkbox"/>	<input checked="" type="checkbox"/>
Duplex system LBT	15.323(c)(10)	<input checked="" type="checkbox"/>	<input checked="" type="checkbox"/>	<input type="checkbox"/>
Co-located device LBT	15.323(c)(11)	<input checked="" type="checkbox"/>	<input checked="" type="checkbox"/>	<input type="checkbox"/>
Fair access	15.323(c)(12)	<input checked="" type="checkbox"/>	<input checked="" type="checkbox"/>	<input type="checkbox"/>
Emissions inside and outside the subband	15.323(d)	<input checked="" type="checkbox"/>	<input type="checkbox"/>	<input checked="" type="checkbox"/>
Frame period and jitter	15.323(e)	<input checked="" type="checkbox"/>	<input type="checkbox"/>	<input checked="" type="checkbox"/>
Carrier frequency stability	15.323(f)	<input checked="" type="checkbox"/>	<input type="checkbox"/>	<input checked="" type="checkbox"/>

3.2 Other Comments

All measurements are traceable to national standards.

The tests were conducted on a sample of the equipment for the purpose of demonstrating compliance with FCC CFR47 Part 15, Paragraph 15.323 for Isochronous UPCS Devices and Industry Canada RSS-213 Issue 3.

The conducted test methods have been in accordance with ANSI C63.17-2013 where applicable. Radiated tests were conducted in accordance with ANSI C63.4-2014.

Where a test method specified in this Standard cannot be followed, a test method given in ANSI C63.17-2013 may be used by quoting the test section number. An equivalent alternative method may also be used provided that it is fully described in the test report.

Where a test is not practicable (e.g. the test for an access protocol of Section 4.3.4), the certification applicant may submit to Industry Canada the manufacturer's declaration that the access protocol has nevertheless been met in the design and prototype tests. Full justification as to why testing is not practicable should be given for Industry Canada's consideration.

A mid-band carrier frequency should normally be used for tests.

When an antenna conducted measurement is used to determine the RF output power of the device, the effective gain of the antenna intended for the device must be stated, based on measurement or on data from the antenna manufacturer. Any antenna gain in excess of 3 dBi (3 dB above isotropic gain) shall be added to the measured RF output power before using the power limits specified in this standard.

Accessories and peripheral equipment that are normally required to be connected to the device in actual use, shall be so connected with representative cable lengths for the tests. Only one test using representative peripherals and accessories is required. The emission tests shall be performed with the device and accessories configured in a manner which tends to produce the maximum level of emissions within the range of variations that can be expected under normal operating conditions.

4 TEST SETUP

4.1 Frequency and Timing Measurements

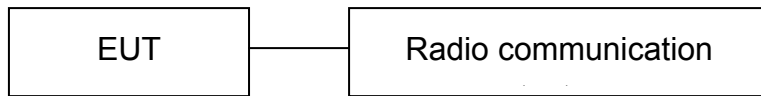

Test Set-up 1

This setup is used for measuring Frame repetition stability, Jitter, Carrier frequency stability at normal and extreme temperatures.

4.2 Conducted Emission Tests

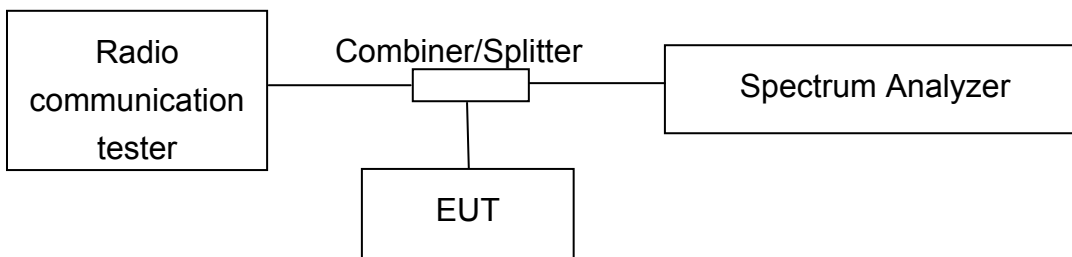

Test Set-up 2

This setup is used for all conducted emission tests.

4.3 Radiated Emission Tests

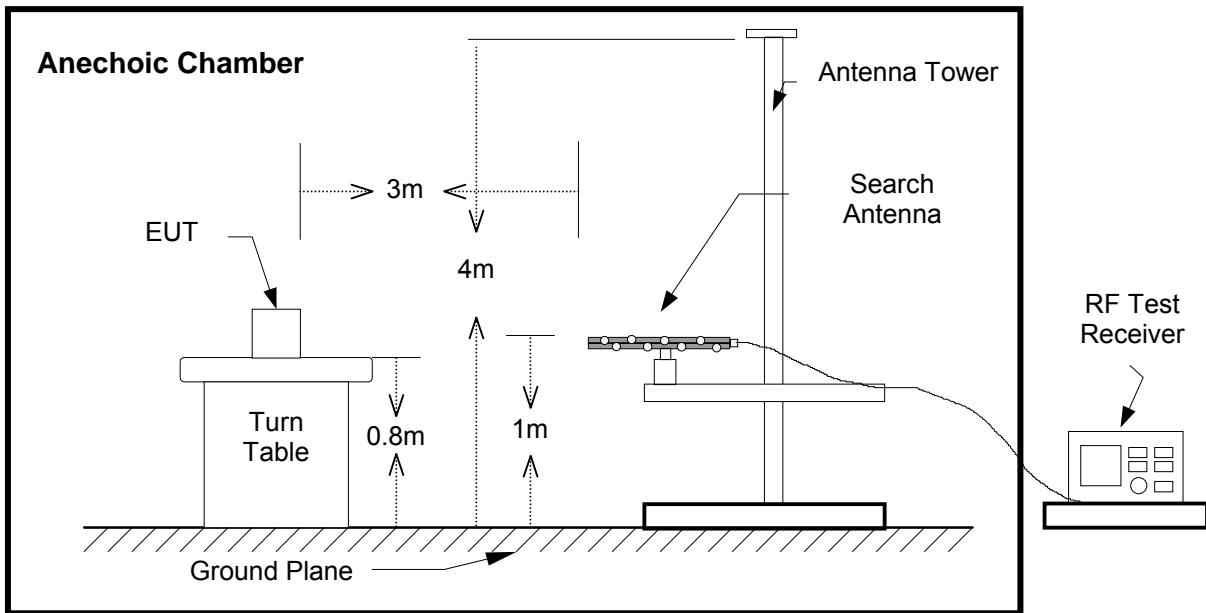

Test Set-Up 3

This test setup is used for all radiated emissions tests. For frequencies below 30 MHz the measuring distance is 10 m, for all other frequencies it is 3 m. Emissions above 1 GHz were measured with the Spectrum Analyzer, Horn Antenna and the preamplifier after the antenna.

4.4 Power line Conducted Tests

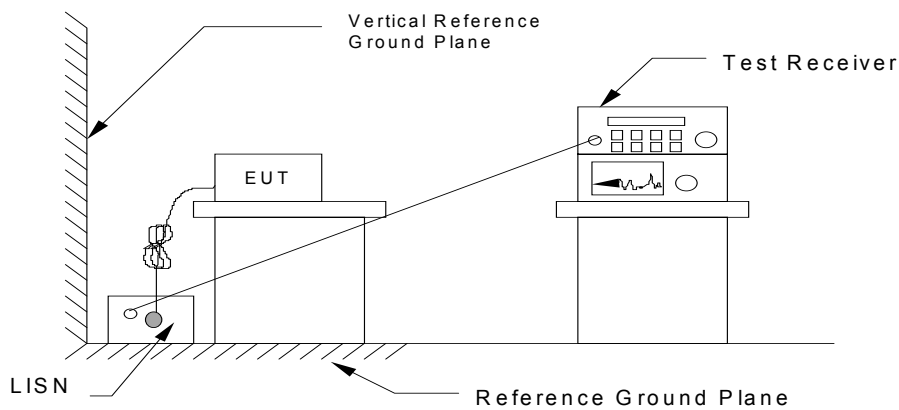

Test Set-Up 4

4.5 Monitoring Tests

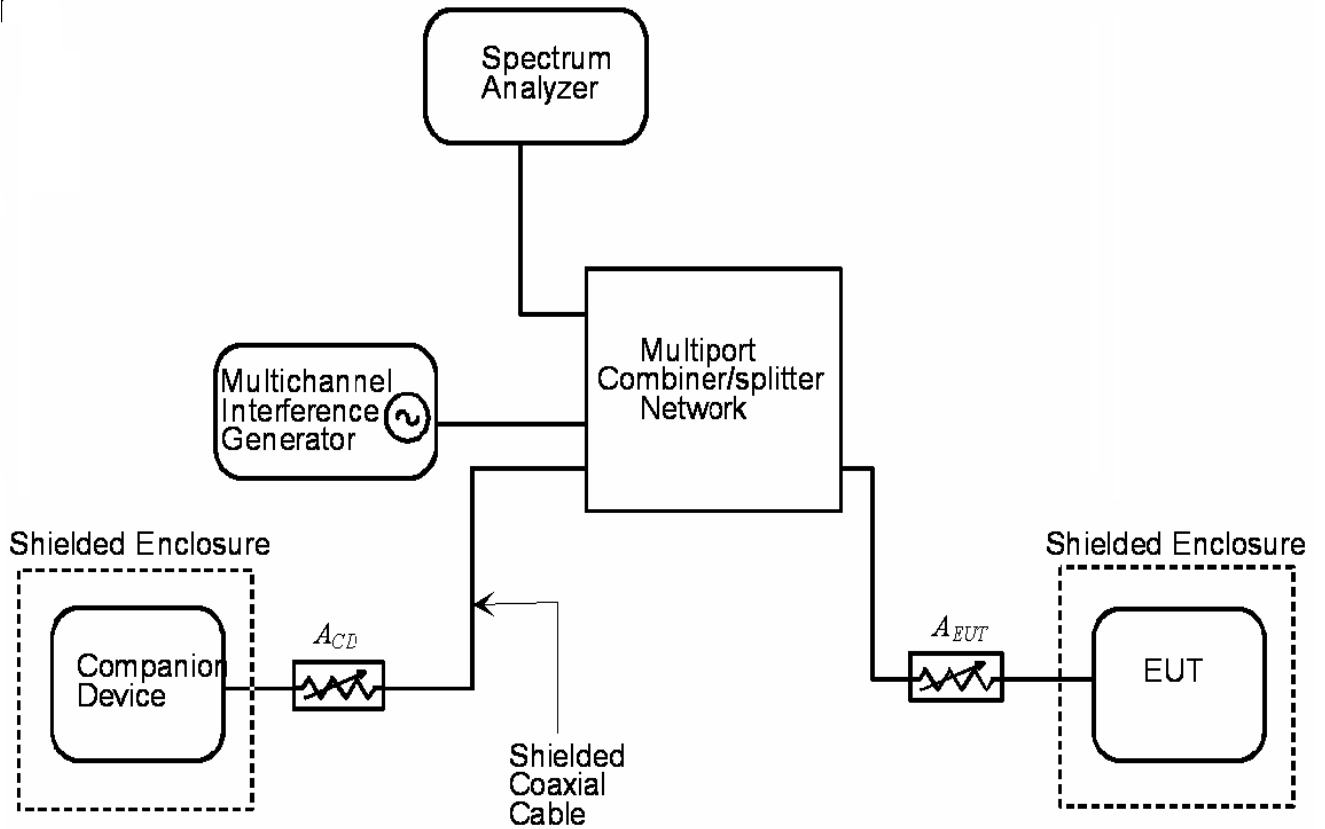

Test Set-Up 5

This test setup is used for all Monitoring and Time and Spectrum Access Procedure tests.

Companion Device	A _{CD} (dB)	EUT	A _{EUT} (dB)
Base	50	Handset	0
Handset	30	Base	0

5 TEST EQUIPMENT LIST

To facilitate inclusion on each page of the test equipment used for related tests, each item of test equipment and ancillaries are identified (numbered) by the Test Laboratory.

Equipment	Manufacturer	Model No.	S/N	Calibration Date (MM/DD/YY)	Next Calibration Date (MM/DD/YY)
EMI Test Receiver	R&S	ESCI	13054418-001	01/16/2017	01/15/2018
BiLog Antenna	ETC	MCTD 2786B	BLB17F04016	02/15/2017	02/14/2018
Horn Antenna	EMCO	3115	13059201-001	11/09/2016	11/08/2017
Horn Antenna	EMCO	3116	13059202-001	10/18/2016	10/17/2017
PRE-Amplifier	Agilent	8449B	13040709-001	01/10/2017	01/09/2018
Spectrum Analyzer	Agilent	E4446A	13052013-001	10/18/2016	10/17/2017
Spectrum Analyzer	R&S	FSU46	13040904-001	01/10/2017	01/09/2018
Radio Communication Tester	Rohde & Schwarz	CTS60	13046802-002	10/11/2016	10/10/2017
RF Downconverter	National Instruments	PXI-5600	E35372	05/08/2017	05/07/2018
RF Downconverter	National Instruments	PXI-5600	E224BD	05/08/2017	05/07/2018
64 MS/s Digitizer	National Instruments	PXI-5620	E34BOB	05/08/2017	05/07/2018
64 MS/s Digitizer	National Instruments	PXI-5620	E22946	05/08/2017	05/07/2018
100 MS/s AWG OSP	National Instruments	PXI-5441	E32987	05/08/2017	05/07/2018
8-Bit 250 MS/s Digitizer	National Instruments	PXI-5114	E41FBC	05/08/2017	05/07/2018
8-Bit 250 MS/s Digitizer	National Instruments	PXI-5114	E41FBE	05/08/2017	05/07/2018
RF Upconverter	National Instruments	PXI-5610	E35372	05/08/2017	05/07/2018
Loop Antenna	EMCO	6512	13054104-001	09/01/2016	08/31/2017
PRE-Amplifier	EMCI	PA303N	13040720-001	12/09/2016	12/08/2017

6 TEST RESULT

6.1 Cross Reference

6.1.1 Standard Applicable:

15.309(b)

The requirements of Subpart D apply only to the radio transmitter contained in the PCS device. Other aspects of the operation of a PCS device may be subject to requirements contained elsewhere in this Chapter. In particular, a PCS device that includes digital circuitry not directly associated with the radio transmitter also is subject to the requirements for unintentional radiators in Subpart B.

15.109(a)

For unintentional device, according to **FCC §15.109(a)**, the field strength of radiated emissions from unintentional except for class A digital device radiators at a distance of 3 meters shall not exceed the following values:

Frequency MHz	Distance Meters	Radiated μ V/m	Radiated dB μ V/m
30 - 88	3	100	40.0
88 - 216	3	150	43.5
216 - 960	3	200	46.0
above 960	3	500	54.0

For intentional radiator device, according to §15.209(a), the emissions from an intentional radiator shall not exceed the field strength levels specified in the following table:

Frequency (MHz)	Field Strength (microvolts/meter)	Measurement Distance (meters)
0.009 - 0.490	2400/F(kHz)	300
0.490 - 1.705	24000/F(kHz)	30
1.705 - 30.0	30	30
30 - 88	100 **	3
88 - 216	150 **	3
216 - 960	200 **	3
Above 960	500	3

** Except as provided in paragraph (g), fundamental emissions from intentional radiators operating under this Section shall not be located in the frequency bands 54-72 MHz, 76-88 MHz, 174-216 MHz or 470-806 MHz. However, operation within these frequency bands is permitted under other sections of this Part, e.g., Sections 15.231 and 15.241.

6.1.2 Test Results:

This requirement is not applicable because test sample do not include digital circuitry which is not direct associated with the radio transmitter	<input type="checkbox"/>
For test results according to FCC part 15 subpart B, see the EMC report as attached	<input type="checkbox"/>
For test results according to FCC part 15 subpart B, see the measurement data as follow	<input checked="" type="checkbox"/>
This requirement is covered by results of power line conducted emission test according to FCC 15.315	<input checked="" type="checkbox"/>
Radiated measurement to evaluate simultaneous transmission operations with DECT + IEEE802.15.4 ZigBee.	<input type="checkbox"/>

Note: For radiated test, if EUT is a handset, rotate the EUT in turns with three orthogonal axes to determine the axis of maximum emission as a worse case.

Condition: Radiated_30-1000MHz

Polarization: Vertical

No.	Frequency (MHz)	Reading (dBuV/m)	Detector	Corrected dB/m	Result (dBuV/m)	Limit (dBuV/m)	Margin (dB)
1	32.9100	42.86	peak	-3.11	39.75	40.00	-0.25
2	62.7251	54.28	QP	-14.86	39.12	40.00	-0.88
3	99.8400	47.97	peak	-10.52	37.45	43.50	-6.05
4	198.7800	44.86	peak	-8.06	36.80	43.50	-6.70
5	303.5400	46.08	peak	-3.30	42.78	46.00	-3.22
6	313.2400	45.26	peak	-3.10	42.16	46.00	-3.84
7	1730.7692	55.98	peak	-9.3	46.7	54.0	-7.3
8	3831.7308	62.25	peak	-1.6	60.7	74.0	-13.3
9	3831.7308	33.52	avg	-1.6	31.9	54.0	-22.1
10	7698.7179	52.68	peak	4.2	56.9	74.0	-17.1
11	7698.7179	34.28	avg	4.2	38.5	54.0	-15.5

B. below 30MHz

Frequency (MHz)	. Reading (dBuV/m) Peak	Duty (dB)	Factor (dB)	Result @3m (dBuV/m)			Limit @3m (dBuV/m)	
				Peak	QP	AVG	Peak	AVG
Radiated emission frequencies from 9 kHz to 30 MHz were too low to be measured.								

- Note: 1. Place of Measurement: Measuring site of the ETC.
 2. The measurements of radiated emission frequencies from 9kHz to 30MHz were greater than 20dB below the limit.
 3. The estimated measurement uncertainty of the result measurement is
 ±4.2dB (9kHz ≤ f ≤ 30MHz).
 ±4.6dB (30MHz ≤ f < 300MHz).
 ±4.4dB (300MHz ≤ f < 1000MHz).
 ±4.1dB (1GHz ≤ f < 18GHz).
 ±4.4dB (18GHz ≤ f ≤ 40GHz).

6.2 Field Strength Calculation

The field strength is calculated by adding the Antenna Factor, High Pass Filter Loss(if used) and Cable Loss, and subtracting the Amplifier Gain (if any) from the measured reading. The basic equation calculation is as follows:

$$\mathbf{Result = Reading + Corrected Factor}$$

where

$$\text{Corrected Factor} = \text{Antenna Factor} + \text{Cable Loss} + \text{High Pass Filter Loss} - \text{Amplifier Gain}$$

6.3 Labeling Requirements

6.3.1 Standard Applicable: FCC 15.19 , RSS-Gen

The FCC Identifier shall be displayed on the label, and the device(s) shall bear the following statement in a conspicuous location on the device or in the user manual if the device is too small:

Operation is subject to the following two conditions: (1) this device may not cause harmful interference, and (2) this device must accept any interference received, including interference that may cause undesired operation.

The label itself shall be of a permanent type, not a paper label, and shall last the lifetime of the equipment.

6.3.2 Result

See separate documents showing the label design and the placement of the label on the EUT.

6.4 Power line Conducted Emissions

6.4.1 Standard Applicable:

15.315

An unlicensed PCS device that is designed to be connected to the public utility (AC) power line must meet the limits specified in Section 15.207.

15.207(a)

For an intentional radiator that is designed to be connected to the public utility (AC) power line, the radio frequency voltage that is conducted back onto the AC power line on any frequency or frequencies within the band 150 kHz to 30 MHz shall not exceed the limits in the following table, as measured using a 50 μ H/50 ohms line impedance stabilization network (LISN). Compliance with the provisions of this paragraph shall be based on the measurement of the radio frequency voltage between each power line and ground at the power terminal. The lower limit applies at the boundary between the frequency ranges.

Frequency MHz	Quasi Peak dB μ V	Average dB μ V
0.15 - 0.5	66-56*	56-46*
0.5 - 5.0	56	46
5.0 - 30.0	60	50

*Decreases with the logarithm of the frequency.

RSS-213 5.4

The limits of AC power line conducted emissions are given in RSS-Gen, Section 8.

6.4.2 Measurement Procedure

ANSI C63.4-2014 using 50 μ H/50 ohms LISN.

6.4.3 Test Results: Complies

Measurement Data: See attached graph, (Peak detector).

Highest measured value (L1 and N):

All emissions were below the QP and Average limits when measured with Peak detector.

The test was performed with the EUT in standby charging and repeated with the EUT transmitting in speakerphone mode and charging.

Conducted Emission Test

File: pp Data: #17 Date: 2017/8/7 Temperature: 20 °C
Time: PM 02:16:29 Humidity: 58 %

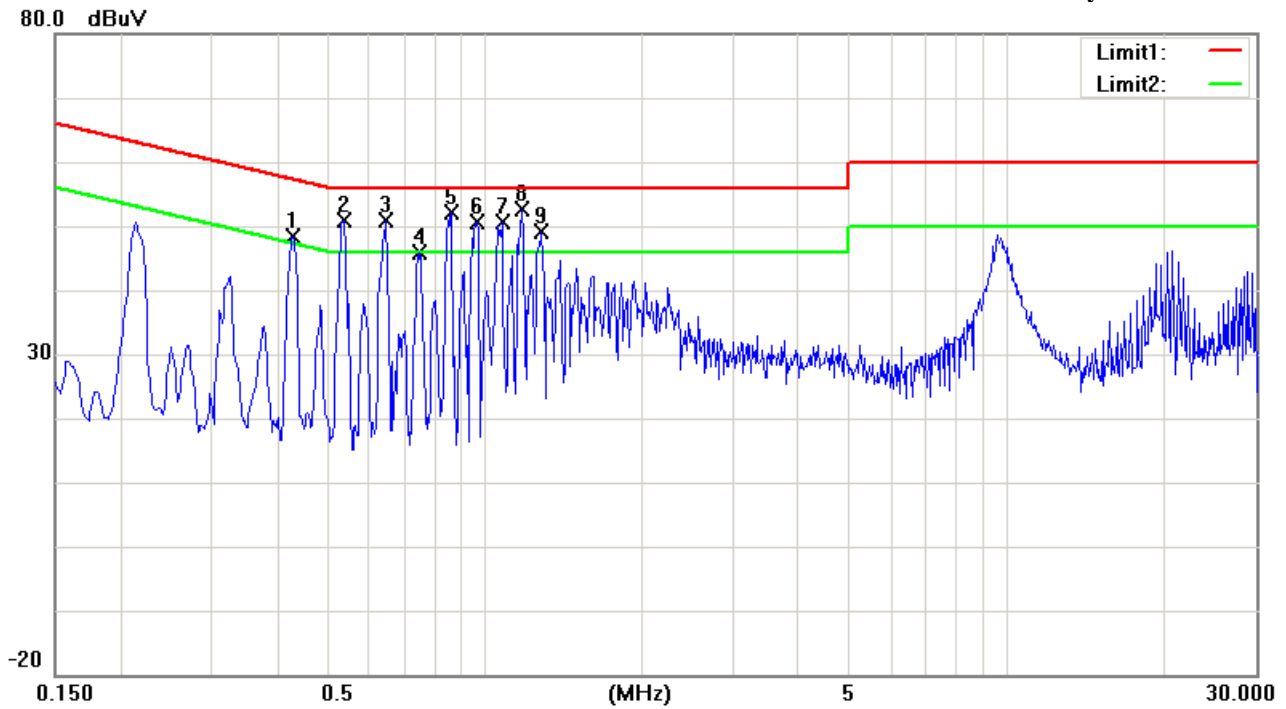

Condition : Phase: N

No.	Frequency (MHz)	Reading (dBuV)	Detector	Corrected dB	Result (dBuV)	Limit (dBuV)	Margin (dB)
1	0.4302	38.00	QP	9.65	47.65	57.25	-9.60
2	0.4302	32.66	AVG	9.65	42.31	47.25	-4.94
3	0.5385	40.15	QP	9.65	49.80	56.00	-6.20
4	0.5385	33.94	AVG	9.65	43.59	46.00	-2.41
5	0.6451	38.39	QP	9.65	48.04	56.00	-7.96
6	0.6451	32.57	AVG	9.65	42.22	46.00	-3.78
7	0.7546	33.39	QP	9.67	43.06	56.00	-12.94
8	0.7546	26.46	AVG	9.67	36.13	46.00	-9.87
9	0.8610	40.37	QP	9.67	50.04	56.00	-5.96
10	0.8610	32.71	AVG	9.67	42.38	46.00	-3.62
11	0.9676	40.28	QP	9.67	49.95	56.00	-6.05
12	0.9676	33.46	AVG	9.67	43.13	46.00	-2.87
13	1.0665	38.02	QP	9.67	47.69	56.00	-8.31
14	1.0665	30.21	AVG	9.67	39.88	46.00	-6.12
15	1.1833	40.88	QP	9.67	50.55	56.00	-5.45
16	1.1833	32.57	AVG	9.67	42.24	46.00	-3.76
17	1.2616	33.12	QP	9.68	42.80	56.00	-13.20
18	1.2616	12.85	AVG	9.68	22.53	46.00	-23.47

- Note: 1. "****" means the value was too low to be measured.
 2. If the data table appeared symbol of "----" means the Q.P. value is under the limit of AVG. so, the AVG. value doesn't need to be measured.
 3. The estimated measurement uncertainty of the result measurement is ±2.5dB.

6.5 Result Data Calculation

The result data is calculated by adding the LISN Factor to the measured reading. The basic equation with a sample calculation is as follows:

$$\text{RESULT} = \text{READING} + \text{LISN FACTOR (Included Cable Loss)}$$

6.6 Antenna Requirement

6.6.1 Standard Applicable: FCC 15.317, 15.203. RSS-Gen 6.7

Does the EUT have detachable antenna?

Yes

No

If detachable, is the antenna connector non-standard?

Yes

No

The tested equipment has only integral antennas. The conducted tests were performed on a sample with a temporary antenna connector.

6.7 Digital Modulation Techniques

6.7.1 Standard Applicable: FCC 15.319(b), RSS-213 5.1

All transmissions must use only digital modulation techniques.

6.7.2 Result: Meets the requirement

Please see the declaration provided by applicant.

6.8 Peak Transmit Power

6.8.1 Standard Applicable: FCC 15.319(c) & (e) same as RSS-213 5.6

(c) Peak transmit power shall not exceed 100 microwatts multiplied by the square root of the emission bandwidth in hertz. Peak transmit power must be measured over any interval of continuous transmission using instrumentation calibrated in terms of an rms-equivalent voltage. The measurement results shall be properly adjusted for any instrument limitations, such as detector response times, limited resolution bandwidth capability when compared to the emission bandwidth, sensitivity, etc., so as to obtain a true peak measurement for the emission in question over the full bandwidth of the channel.

(e) The peak transmit power shall be reduced by the amount in decibels that the maximum directional gain of the antenna exceeds 3 dBi.

RSS-213 4.3.1 Peak Transmit Power

The transmitter shall be modulated with digital sequence(s) representative of those encountered in a real system operation. The peak transmit power shall be measured and recorded.

6.8.2 Measurement procedure

Measurement method according to ANSI C63.17-2013 paragraph 6.1.2

6.8.3 Test Results: Complies

Measurement Data:

Test Date : Jul. 12, 2017

Temperature : 20 °C

Humidity : 58%

Channel	Frequency (MHz)	Maximum Peak Output Power (dBm)	Limit (dBm)
F _L	1921.536	14.36	20.84
F _M	1924.992	14.37	20.84
F _H	1928.448	14.40	20.84

Limit:

Conducted: $5 \text{ Log (B)} - 10 = 20.81 \text{ dBm}$

Where B is the emission bandwidth in Hz measured at 26 dBm.

Maximum Peak Output Power: CH FL

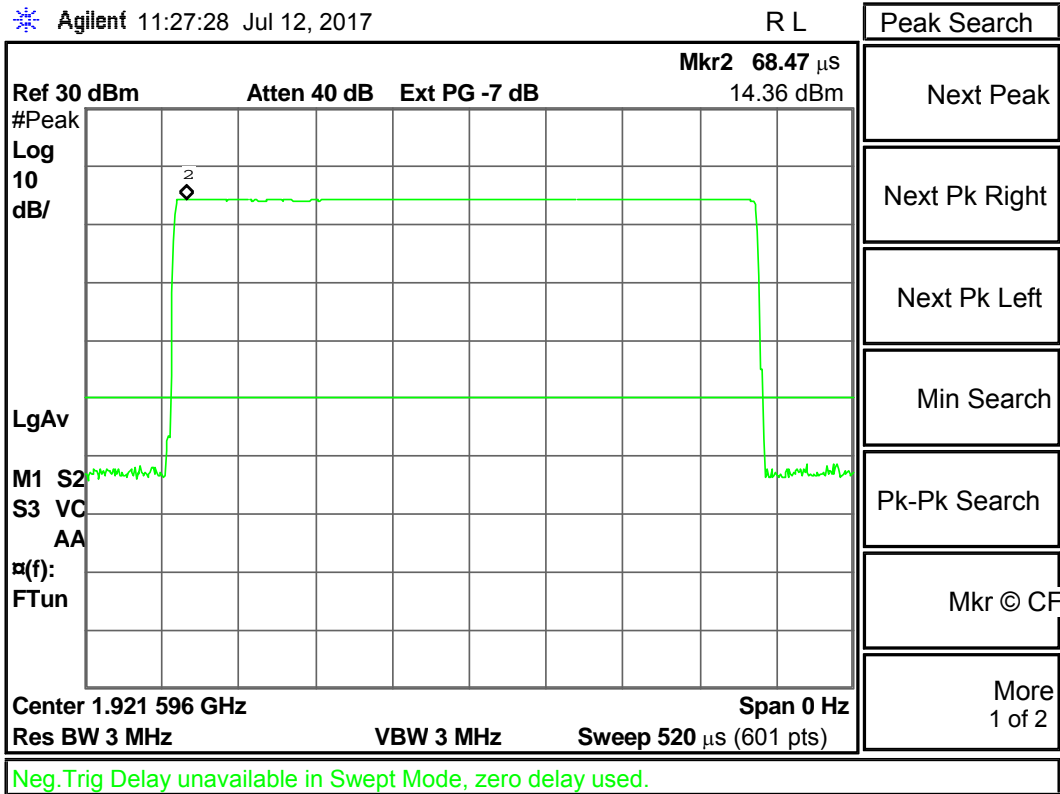

Maximum Peak Output Power: CH Fm

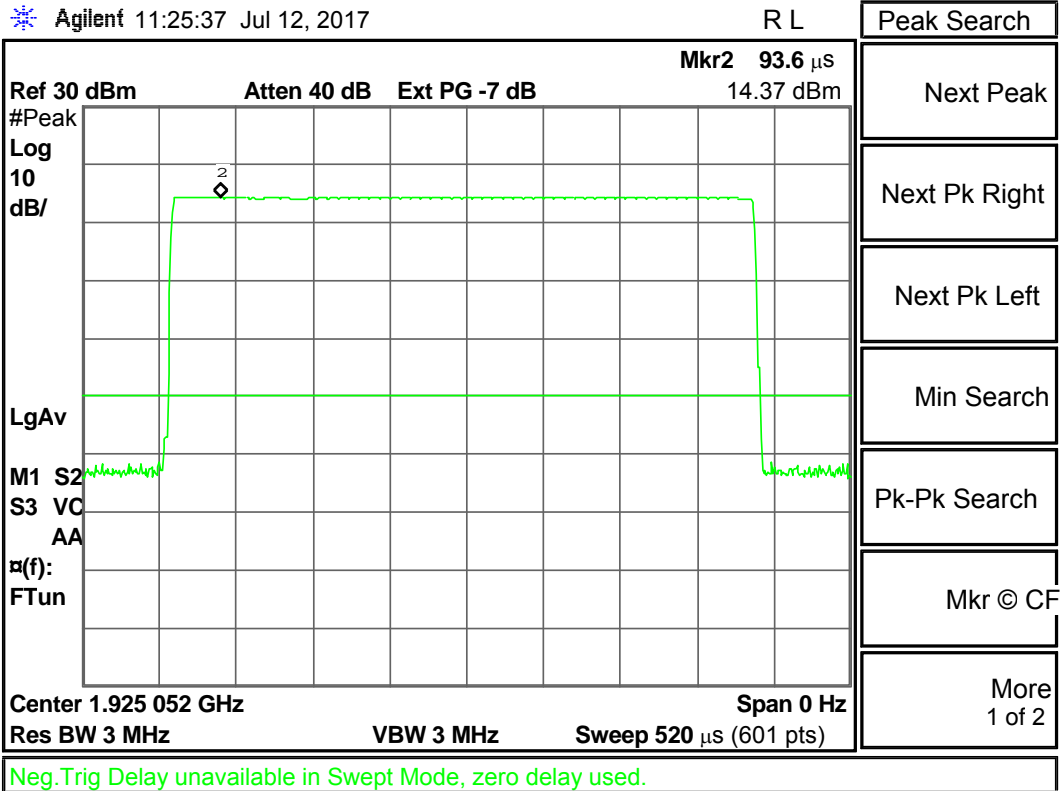

Maximum Peak Output Power: CH F_H

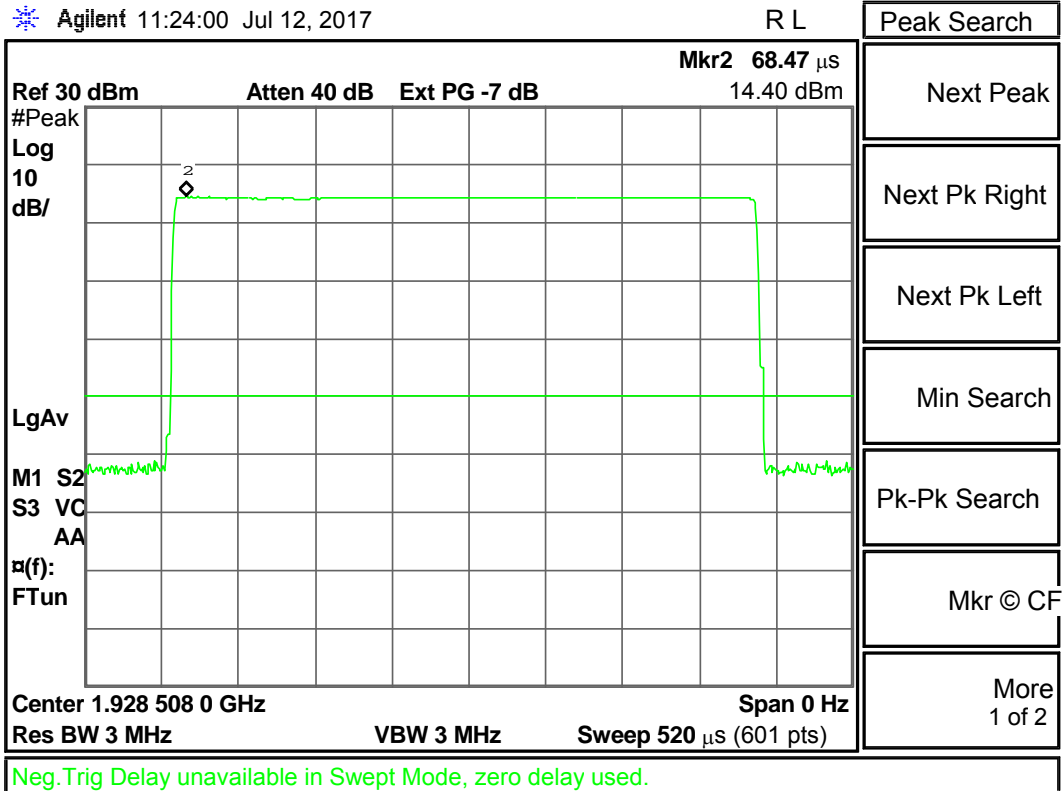

6.9 Power Spectral Density

6.9.1 Standard Applicable: FCC 15.319(d)

Power spectral density shall not exceed 3 milliwatts in any 3 kHz bandwidth as measured with a spectrum analyzer having a resolution bandwidth of 3 kHz.

RSS-213 5.7 Peak Power Spectral Density Test

The peak-hold power spectral density of transmitters shall not exceed 12 mW per any 3 kHz bandwidth. As an alternative to the peak-hold power spectral density, the time-averaged power spectral density may be measured and it shall not exceed 3 mW per any 3 kHz bandwidth.

6.9.2 Measurement procedure

Measurement method according to ANSI C63.17-2013 paragraph 6.1.5

6.9.3 Test Results: Complies

Measurement Data:

Test Date : Jul. 12, 2017

Temperature : 20 °C

Humidity : 58%

Channel	Frequency (MHz)	Power Spectral Density (dBm)	Limit (dBm)
FL	1921.524	-13.05	4.77
F _M	1924.998	-12.99	4.77
F _H	1928.454	-12.94	4.77

Power Spectral Density: CH FL

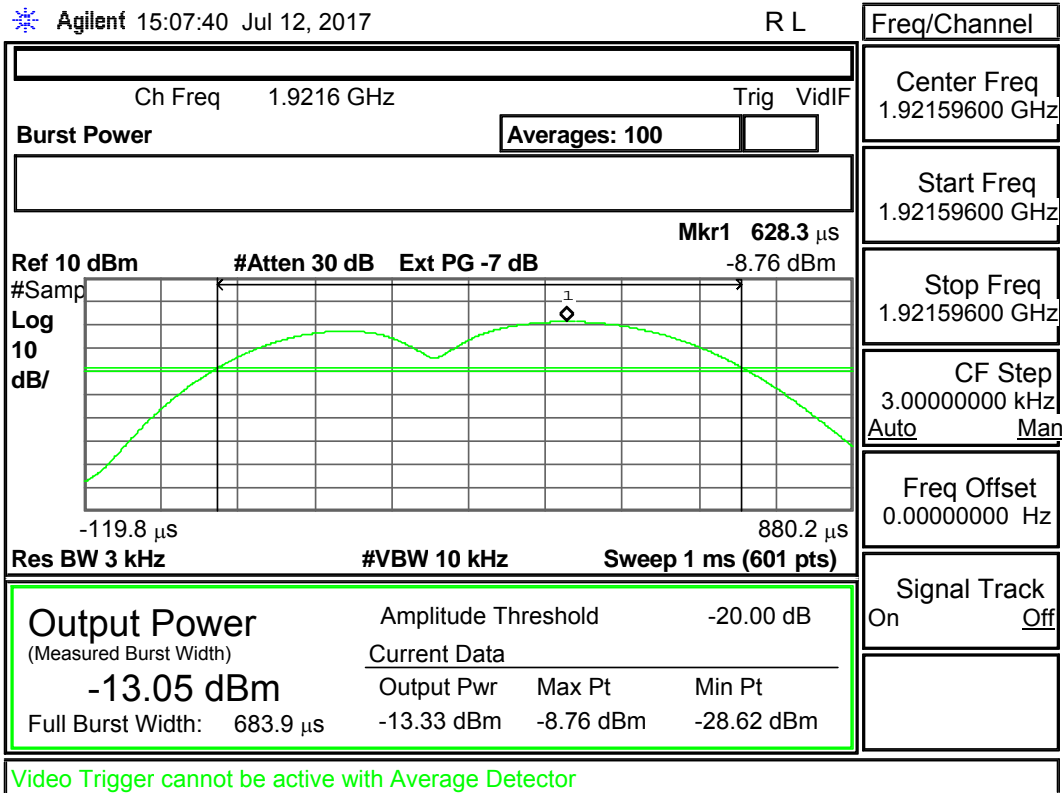

Power Spectral Density: CH Fm

Agilent 15:22:34 Jul 12, 2017 R L

Ch Freq 1.92505 GHz Trig VidIF		Peak Search Next Peak Next Pk Right Next Pk Left Min Search Pk-Pk Search Mkr © CF More 1 of 2																		
Burst Power Averages: 100																				
Ref 10 dBm #Atten 30 dB Ext PG -7 dB Mkr1 381.7 μs -10.35 dBm																				
#Samp -1 Log 10 dB/																				
-198.8 μs #VBW 10 kHz Sweep 1 ms (601 pts) 801.2 μs																				
Res BW 3 kHz																				
<table border="1" style="width: 100%; border-collapse: collapse;"> <tr> <td style="width: 35%;">Output Power (Measured Burst Width)</td> <td style="width: 35%;">Amplitude Threshold</td> <td style="width: 30%; text-align: right;">-20.00 dB</td> </tr> <tr> <td style="text-align: center;">-12.99 dBm</td> <td>Current Data</td> <td></td> </tr> <tr> <td>Full Burst Width: 695.5 μs</td> <td>Output Pwr</td> <td>Max Pt</td> </tr> <tr> <td></td> <td>-12.61 dBm</td> <td>-10.35 dBm</td> </tr> <tr> <td></td> <td></td> <td>Min Pt</td> </tr> <tr> <td></td> <td></td> <td>-30.15 dBm</td> </tr> </table>			Output Power (Measured Burst Width)	Amplitude Threshold	-20.00 dB	-12.99 dBm	Current Data		Full Burst Width: 695.5 μs	Output Pwr	Max Pt		-12.61 dBm	-10.35 dBm			Min Pt			-30.15 dBm
Output Power (Measured Burst Width)	Amplitude Threshold		-20.00 dB																	
-12.99 dBm	Current Data																			
Full Burst Width: 695.5 μs	Output Pwr	Max Pt																		
	-12.61 dBm	-10.35 dBm																		
		Min Pt																		
		-30.15 dBm																		
Video Trigger cannot be active with Average Detector																				

Power Spectral Density: CH F_H

Agilent 15:30:50 Jul 12, 2017 R L

Ch Freq 1.92851 GHz Trig VidIF		Meas Setup																	
Burst Power		Avg Number 100																	
Averages: 100		On Off																	
		Avg Mode Exp Repeat																	
		Average Type Log RMS																	
Ref 10 dBm #Atten 30 dB Ext PG -7 dB Mkr1 663.3 μs -8.96 dBm		Threshold Lvl -20.00 dB																	
Res BW 3 kHz #VBW 10 kHz Sweep 1 ms (601 pts)		Abs Rel																	
<table border="1" style="width: 100%; border-collapse: collapse;"> <tr> <td colspan="2">Output Power</td> <td colspan="2">Amplitude Threshold -20.00 dB</td> </tr> <tr> <td colspan="2">(Measured Burst Width)</td> <td colspan="2">Current Data</td> </tr> <tr> <td colspan="2" style="text-align: center;">-12.94 dBm</td> <td>Output Pwr</td> <td>Max Pt</td> </tr> <tr> <td>Full Burst Width: 680.5 μs</td> <td>-13.69 dBm</td> <td>-8.96 dBm</td> <td>Min Pt -28.87 dBm</td> </tr> </table>		Output Power		Amplitude Threshold -20.00 dB		(Measured Burst Width)		Current Data		-12.94 dBm		Output Pwr	Max Pt	Full Burst Width: 680.5 μs	-13.69 dBm	-8.96 dBm	Min Pt -28.87 dBm	Meas Method Measured Burst Width	
		Output Power		Amplitude Threshold -20.00 dB															
(Measured Burst Width)		Current Data																	
-12.94 dBm		Output Pwr	Max Pt																
Full Burst Width: 680.5 μs	-13.69 dBm	-8.96 dBm	Min Pt -28.87 dBm																
		Burst Width 680.5 μs																	
		Auto Man																	
		Optimize Ref Level																	

Video Trigger cannot be active with Average Detector

6.10 Antenna Gain

6.10.1 Standard Applicable: FCC 15.323(e)

The peak transmit power shall be reduced by the amount in decibels that the maximum directional gain of the antenna exceeds 3 dBi.

6.10.2 Results: Meets the requirement

The antenna gain value provided by manufacturer is -2 dBi.

6.11 Automatic discontinuation of transmission

6.11.1 Standard Applicable: FCC 15.319(f) same as 5.2

The device shall automatically discontinue transmission in case of either absence of information to transmit or operational failure. These provisions are not intended to preclude transmission of control and signaling information or use of repetitive codes used by certain digital technologies to complete frame or burst intervals.

6.11.2 Procedure

Please see the declaration provided by applicant.

6.11.3 Results: Meets the requirement

6.12 Safety exposure levels

6.12.1 Standard Applicable: FCC 15.319(i) › RSS-Gen 3.2

UPCS devices are subject to the radio frequency radiation exposure requirements specified in FCC parts 1.1307 (b), 2.1091 and 2.1093, as appropriate. All equipment shall be considered to operate in a “general population / uncontrolled environment. For portable devices tests according to IEEE 1528 are requested, if applicable.

6.12.2 Measurement procedure

Consideration of radio frequency radiation exposure for EUT is done as

SAR test according OET65c (for PP)	<input checked="" type="checkbox"/>
MPE calculation as below (for FP, Repeater)	<input type="checkbox"/>

SAR test results: See SAR test report.

MPE calculation: not applicable

6.13.3 Results : Complies

6.13 Emission Bandwidth B

6.13.1 Standard Applicable: FCC 15.323(a) , RSS-213 5.6

The 26 dB Bandwidth B shall be larger than 50 kHz and less than 2.5 MHz.

6.13.2 Measurement procedure

Measurement method according to ANSI C63.17-2013 paragraph 6.1.3

6.13.2 Results: Complies

Measurement Data:

Test Date : Jul. 12, 2017

Temperature : 20 °C

Humidity : 58%

Channel	Frequency (MHz)	26 dB Bandwidth (MHz)
FL	1921.536	1.47
F _M	1924.992	1.49
FH	1928.448	1.49

26 dB Bandwidth B: CH FL

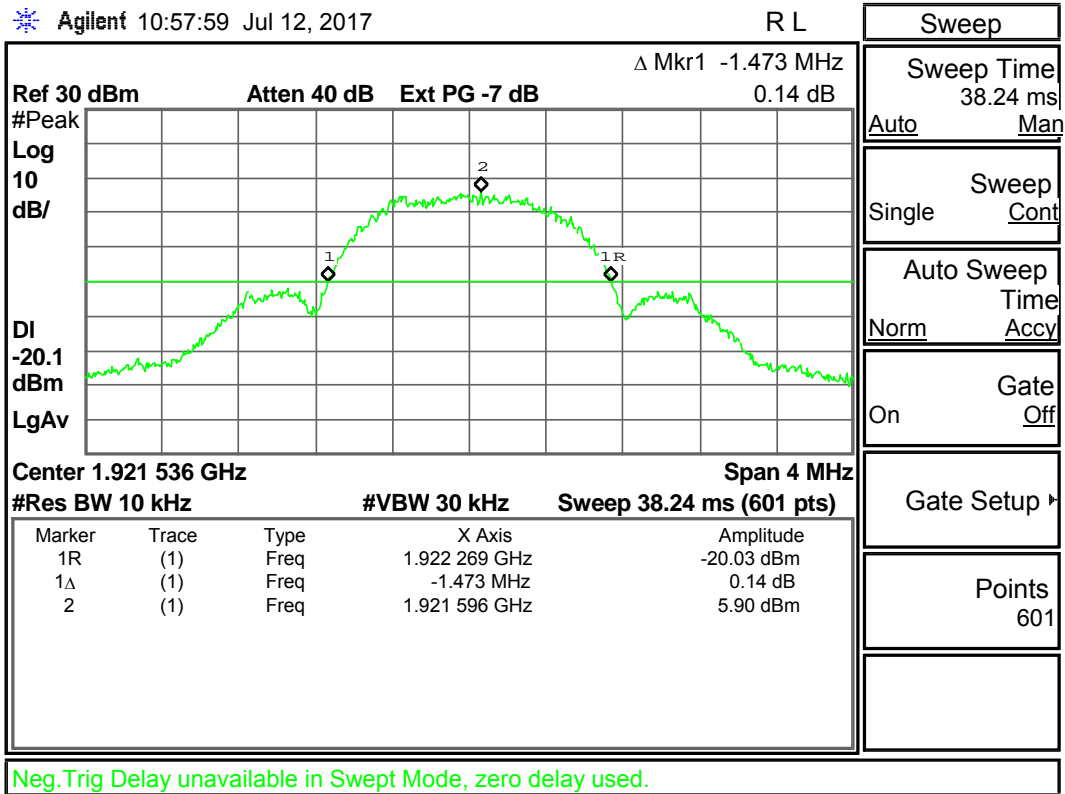

26 dB Bandwidth B: CH Fm

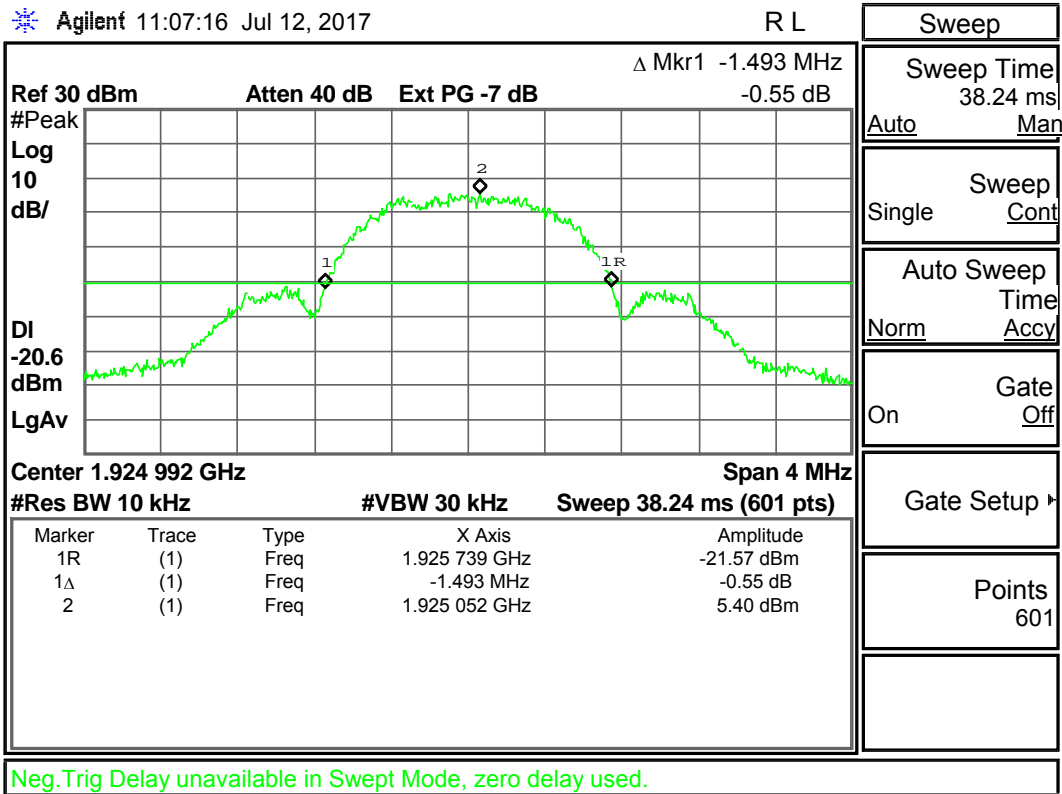

26 dB Bandwidth B: CH FH

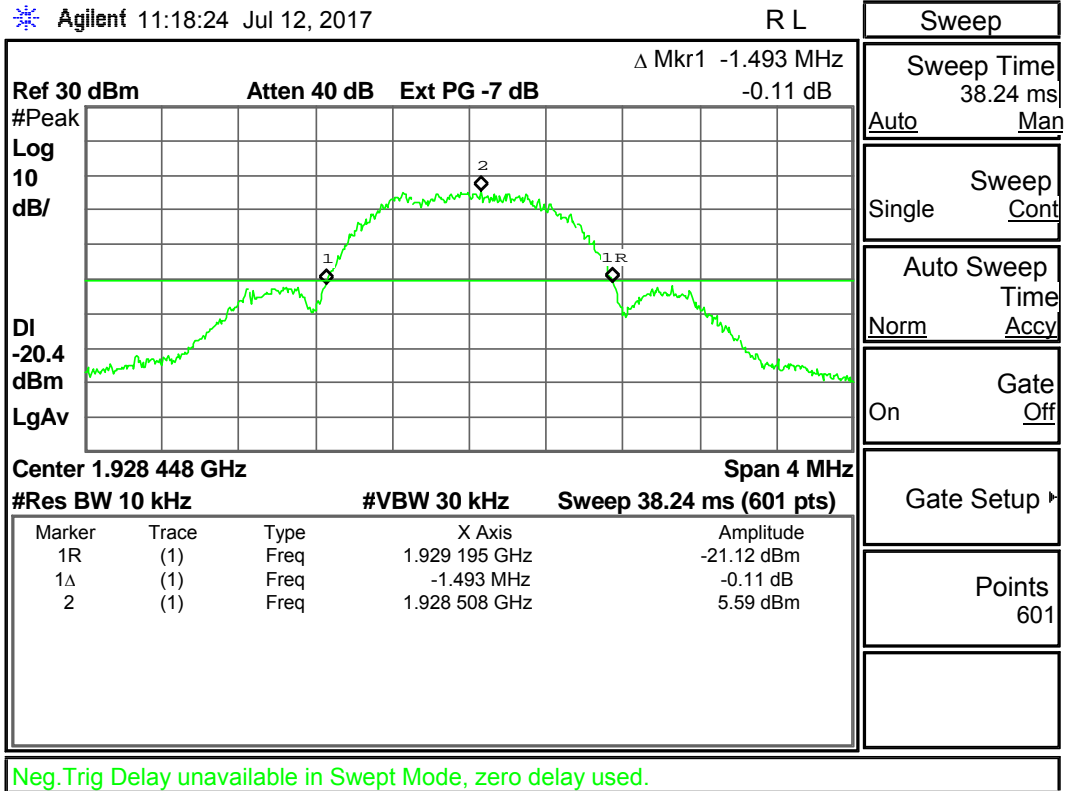

6.14 Monitoring time

6.14.1 Standard Applicable: FCC 15.323(c)(1) same as RSS-213 5.2(1)

Immediately prior to initiating transmission, devices must monitor the combined time and spectrum window in which they intend to transmit. For a period of at least 10 milliseconds for systems designed to use a 10 millisecond or shorter frame period or at least 20 milliseconds for systems designed to use a 20 millisecond frame period.

6.14.2 Measurement procedure

Measurement method according to ANSI C63.17-2013 paragraph 7.3.3

6.14.2 Results: Complies

EUT monitors the combined time and spectrum window prior to initiation of transmission.

Measurement Data:

This requirement is covered by results of Least Interfered Channel (LIC) test according to FCC 15.323(c) (5)	<input checked="" type="checkbox"/>
--	-------------------------------------

6.15 Monitoring threshold

6.15.1 Standard Applicable: FCC 15.323(c)(2) same as RSS-213 5.2(2)

The monitoring threshold must not be more than 30 dB above the thermal noise power for a bandwidth equivalent to the emission bandwidth of the device.

6.15.2 Measurement procedure

Measurement method according to ANSI C63.17-2013 paragraph 7.3.1

6.15.3 Result: Not apply

Note: For EUT which support LIC there is no need to measure lower threshold because it is automatically met by LIC Procedure.

6.16 Maximum transmit period

6.16.1 Standard Applicable: FCC 15.323(C) (3)

Occupation of the same combined time and spectrum windows by a device or group of cooperating devices continuously over a period of time longer than 8 hours is not permitted without repeating the access criteria.

RSS-213 5.2(3)

If no signal above the threshold level is detected, transmission may commence and continue with the same bandwidth in the monitored time and spectrum windows without further monitoring. Occupation of the same combined time and spectrum windows by a device or group of cooperating devices continuously over a period of time longer than 8 h is not permitted without repeating the access criteria.

6.16.2 Measurement procedure

Measurement method according to ANSI C63.17-2013 paragraph 8.2.2

6.16.3 Test Results: Complies

Measurement Data:

Test Date : Jul. 12, 2017

Temperature : 20 °C

Humidity : 58%

	Observation	Limit
Maximum transmission time	3 hours 43 minutes	8 hours

Start to transmission time and Cease of transmission time:

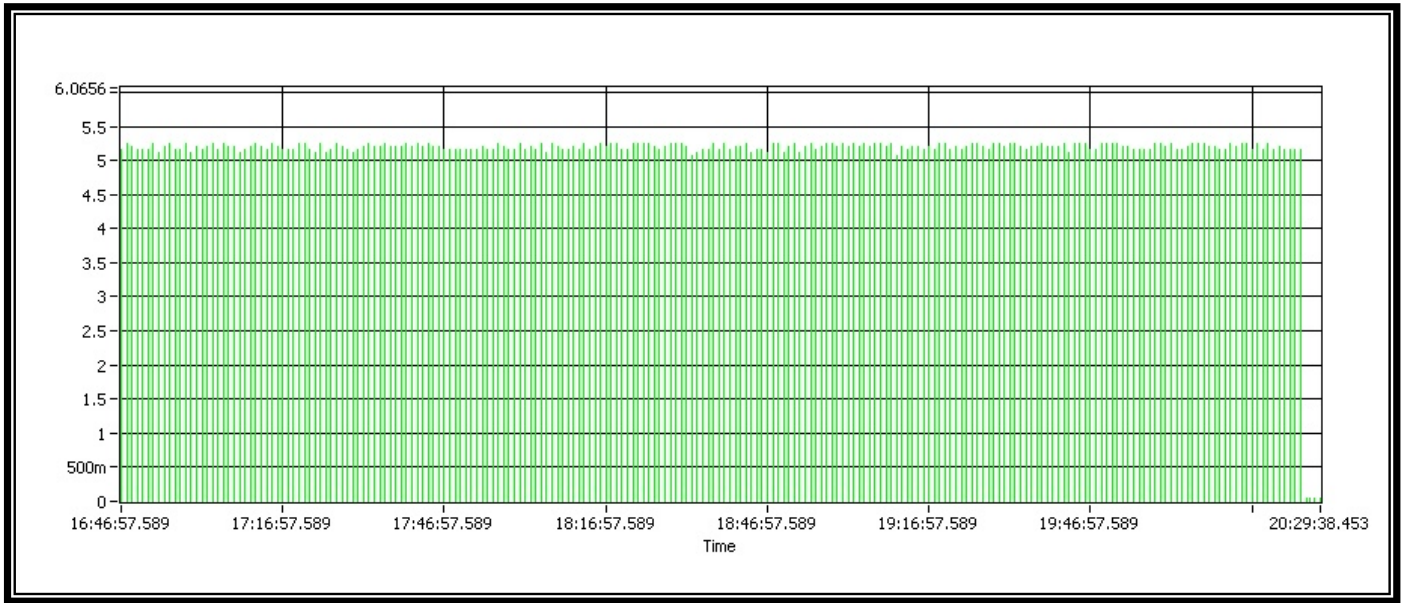

6.17 System Acknowledgement

6.17.1 Standard Applicable: FCC 15.323 (c)(4) same as RSS-213 5.2(4)

Once access to specific combined time and spectrum windows is obtained an acknowledgement from a system participant must be received by the initiating transmitter within one second or transmission must cease. Periodic acknowledgements must be received at least every 30 seconds or transmission must cease. Channels used exclusively for control and signaling information may transmit continuously for 30 seconds without receiving an acknowledgement, at which time the access criteria must be repeated.

6.17.2 Measurement procedure

Measurement method according to ANSI C63.17-2013 paragraph 8

6.17.3 Results: Complies

Measurement Data

Unacknowledged transmission:

Limit:

Requirement	Value
Change of access criteria for control information	30 s
Pause length	> 10 ms
Change of access channel	mandatory

Result:

Test Date : Jul. 12, 2017

Temperature : 20 °C

Humidity : 58%

Requirement	Time	Verdict
Change of access criteria for control information	----	n.a.
Pause length	----	n.a.
Change of access channel	----	n.a.

Connection acknowledgement:

Limit:

Requirement	Value
Connection acknowledgement	1 s
Termination of transmission	30 s

Result:

Test Date : Jul. 12, 2017Temperature : 20 °CHumidity : 58%

Requirement	Time observed	Verdict
Connection acknowledgement	5 ms	Pass
Termination of transmission	5.01s	Pass

Comment: Connection acknowledgement

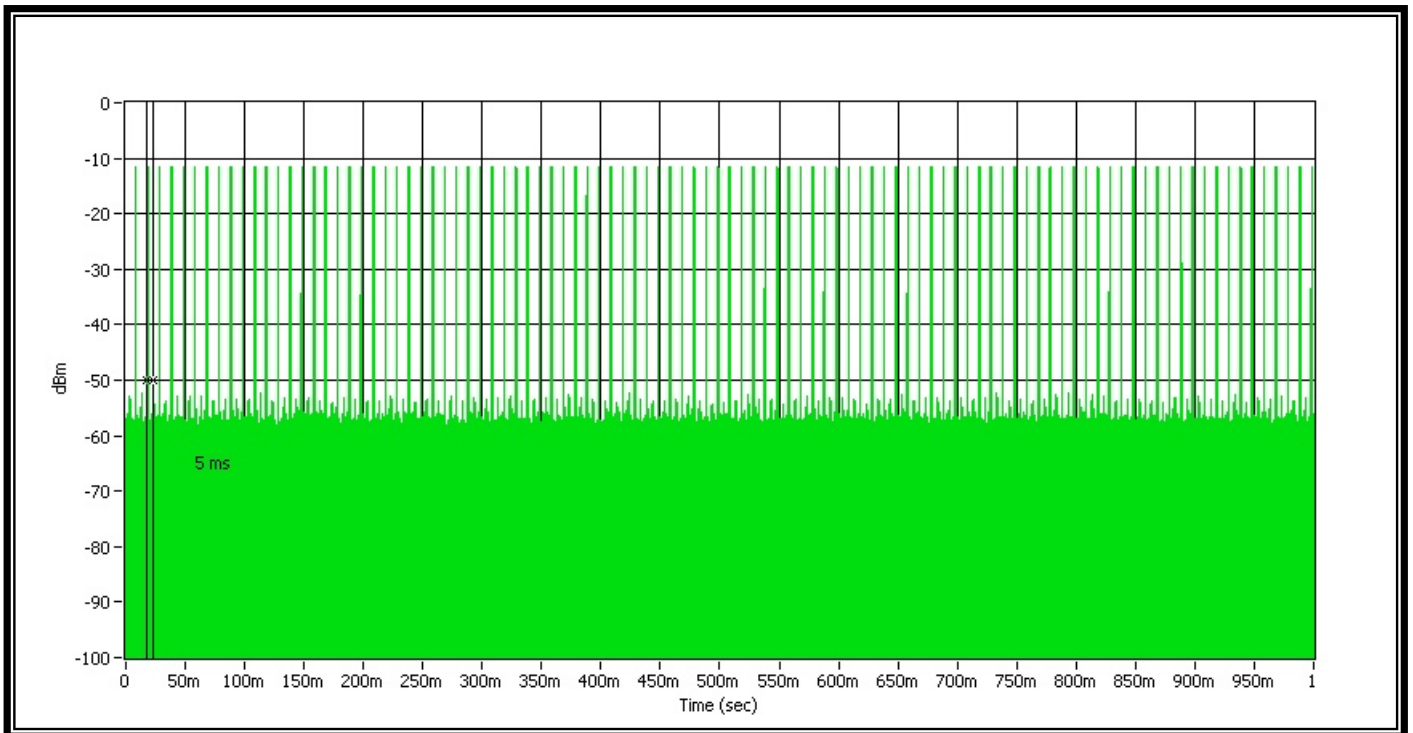
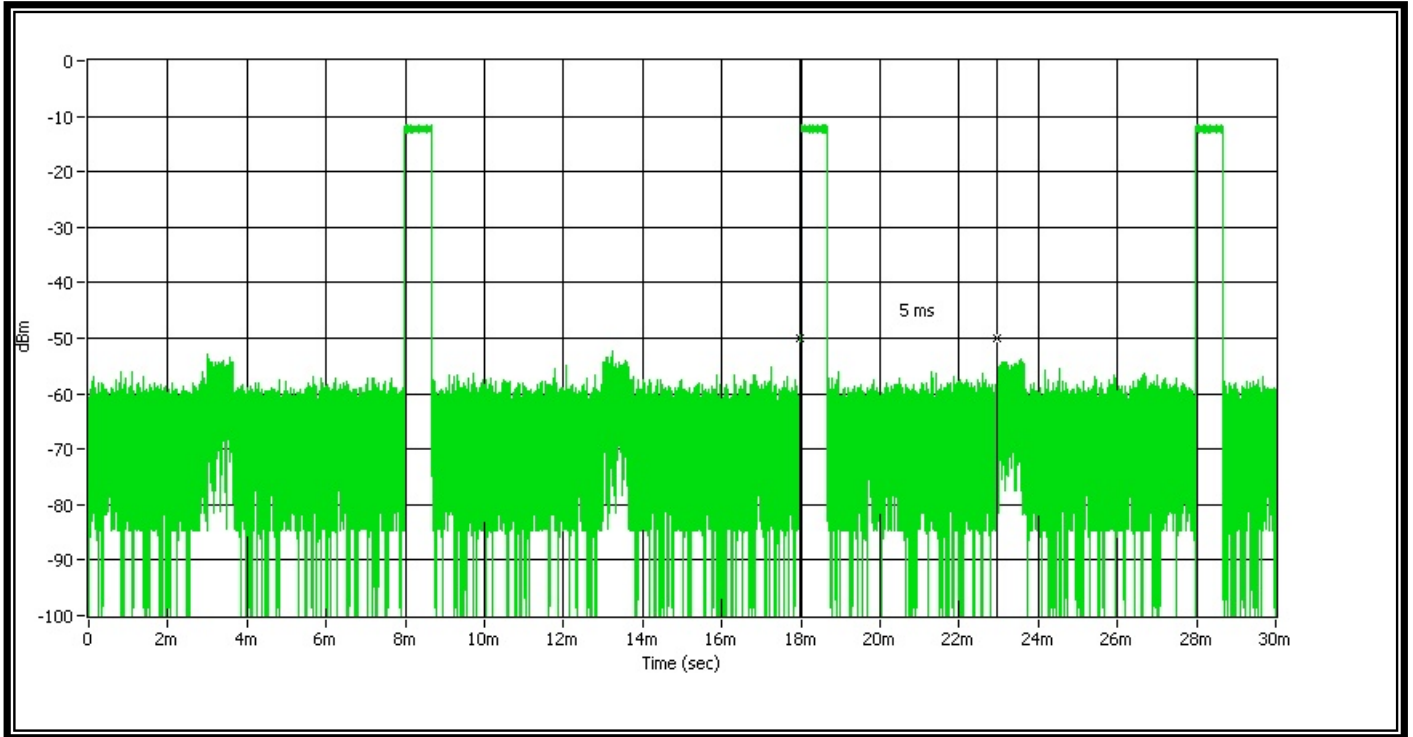

Comment: Termination of transmission

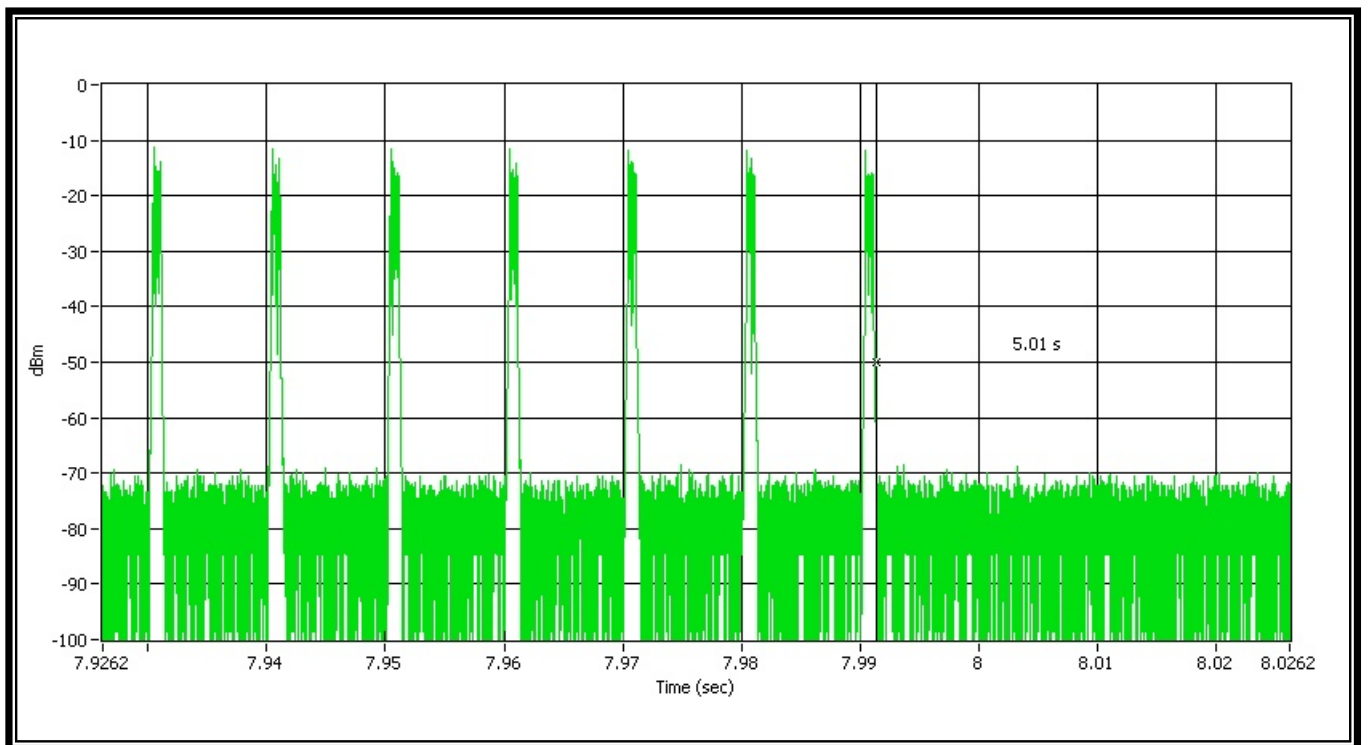
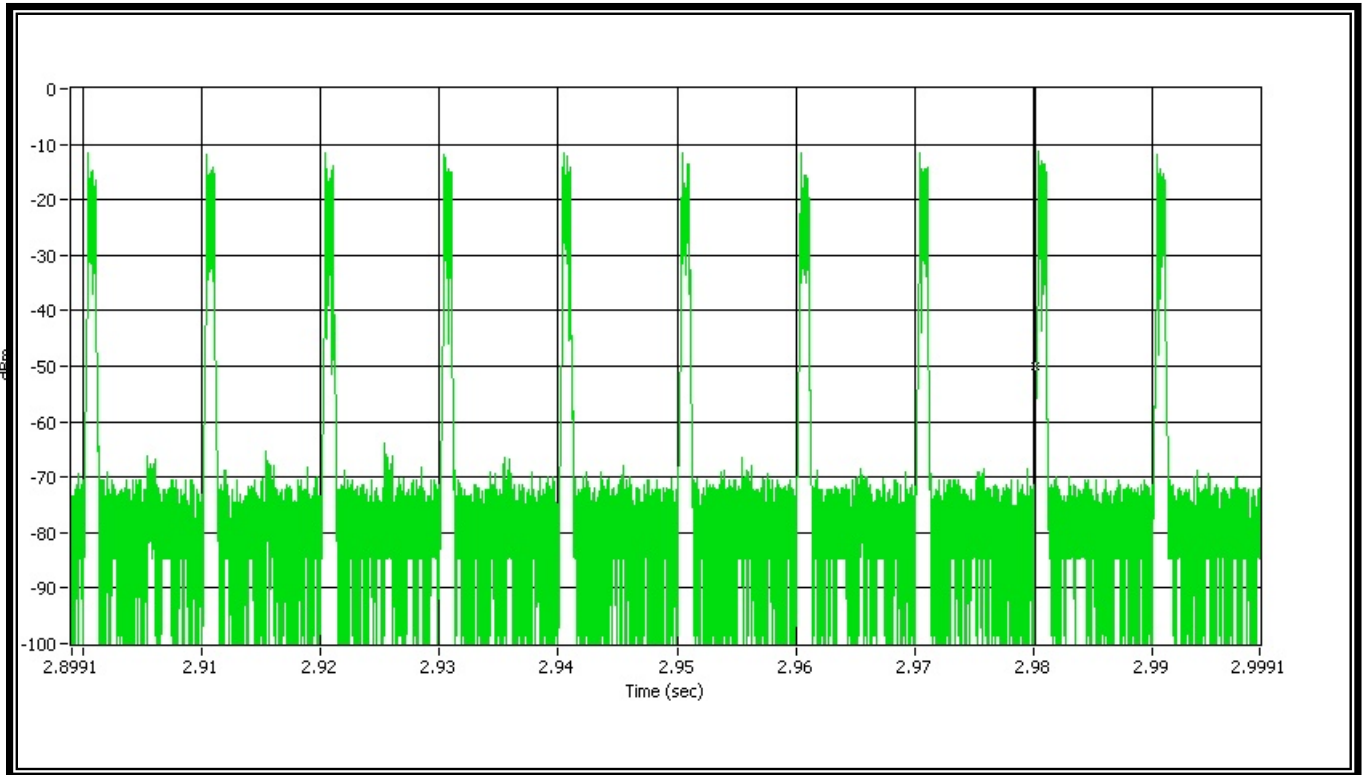

Comment: Termination of transmission

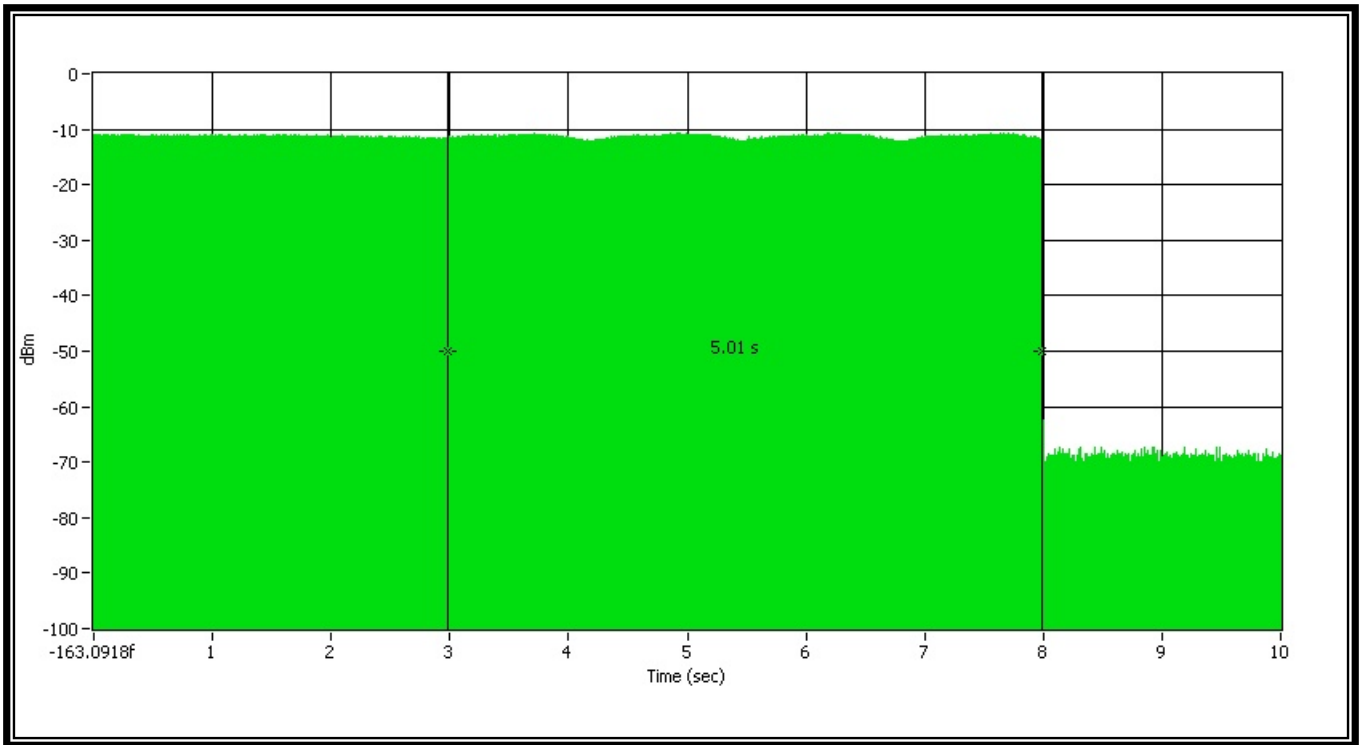

6.18 Least Interfered Channel, LIC

6.18.1 Standard Applicable: FCC 15.323(c) (5) same as RSS-213 5.2

If access to spectrum is not available as determined by the above, and a minimum of 20 duplex system access channels are defined for the system, the time and spectrum windows with the lowest power level may be accessed. A device utilizing the provisions of this paragraph must have monitored all access channels defined for its system within the last 10 seconds and must verify, within the 20 milliseconds (40 milliseconds for devices designed to use a 20 milliseconds frame period) immediately preceding actual channel access that the detected power of the selected time and spectrum windows is no higher than the previously detected value. The power measurement resolution for this comparison must be accurate to within 6 dB. No device or group of co-operating devices located within 1 meter of each other shall during any frame period occupy more than 6 MHz of aggregate bandwidth, or alternatively, more than one third of the time and spectrum windows defined by the system.

6.18.2 Measurement procedure

Measurement method according to ANSI C63.17-2013 paragraph 7.3.2, 7.3.3, 7.3.4

6.18.3 Results: Complies

Measurement Data

Test Date : Jul. 12, 2017

Temperature : 20 °C

Humidity : 58%

Calculation of monitoring threshold limits:

Threshold: $T = 15 \log B - 184 + 50 - P$ (dBm)
 B = emission bandwidth (Hz)
 P = peak transmit power (dBm)

Calculated thresholds:

TL: Lower threshold (dBm)	-55.9
---------------------------	-------

Limit:

Used results	Emission bandwidth (MHz)	1.47
	Peak transmit power (dBm)	14.40
$T_L + U_M = -55.9 + 6 = -49.9$ (dBm)		

Result:

Least interfered channel	Pass
--------------------------	------

Note 1: The Threshold is applicable for systems which have defined a minimum of 40 duplex system access channels.

Note 2: f1=1921.536 MHz, f2=1928.448MHz

Comment: 7.3.2b

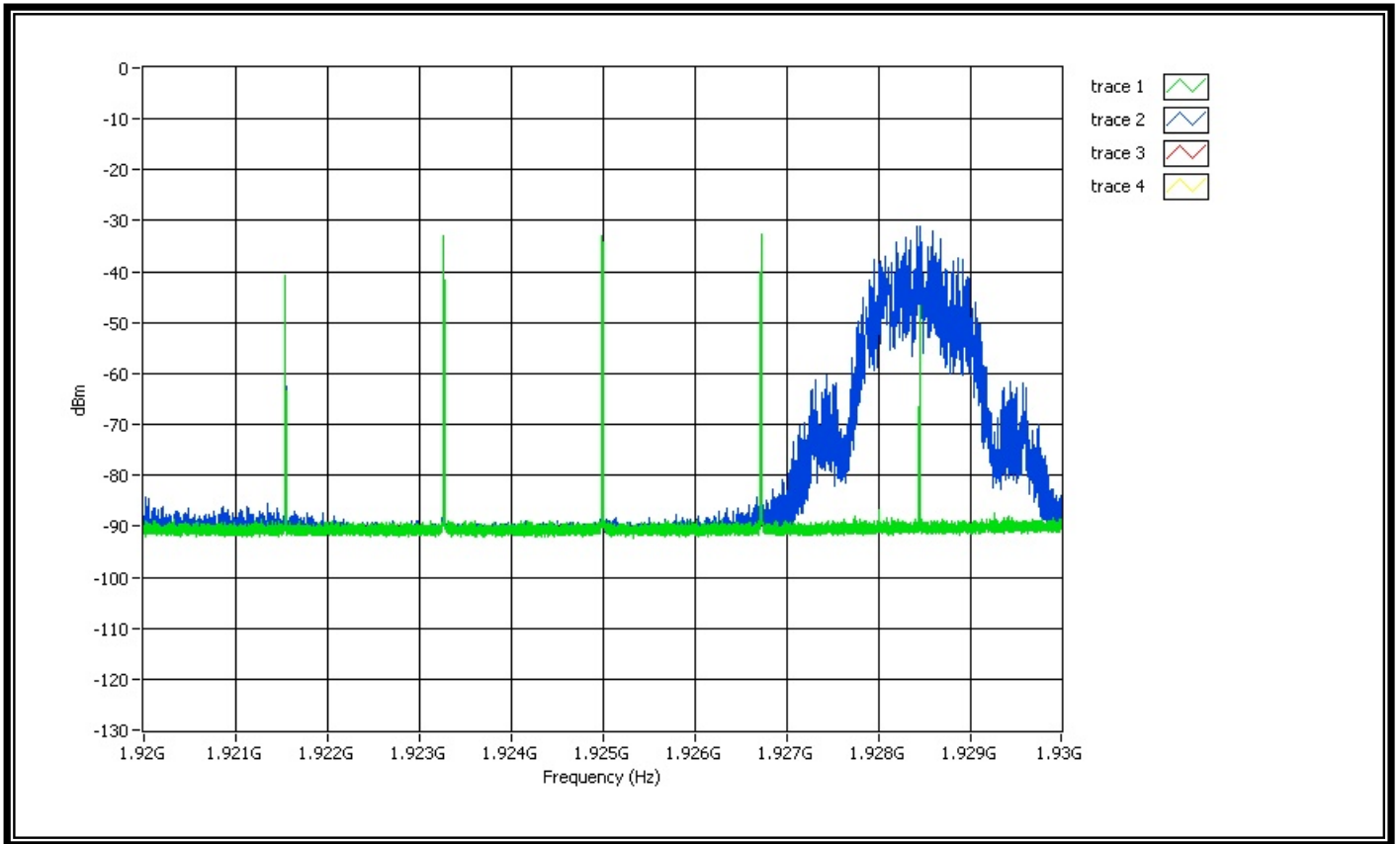

Comment1: Trace1 (green) shows the interference profile.

Comment2: Trace2 (blue) shows the EUT transmissions are occurring.

Comment3: The EUT always transmits on f2 (the carrier with the lower interference level) and so meets the requirement.

Comment: 7.3.2c

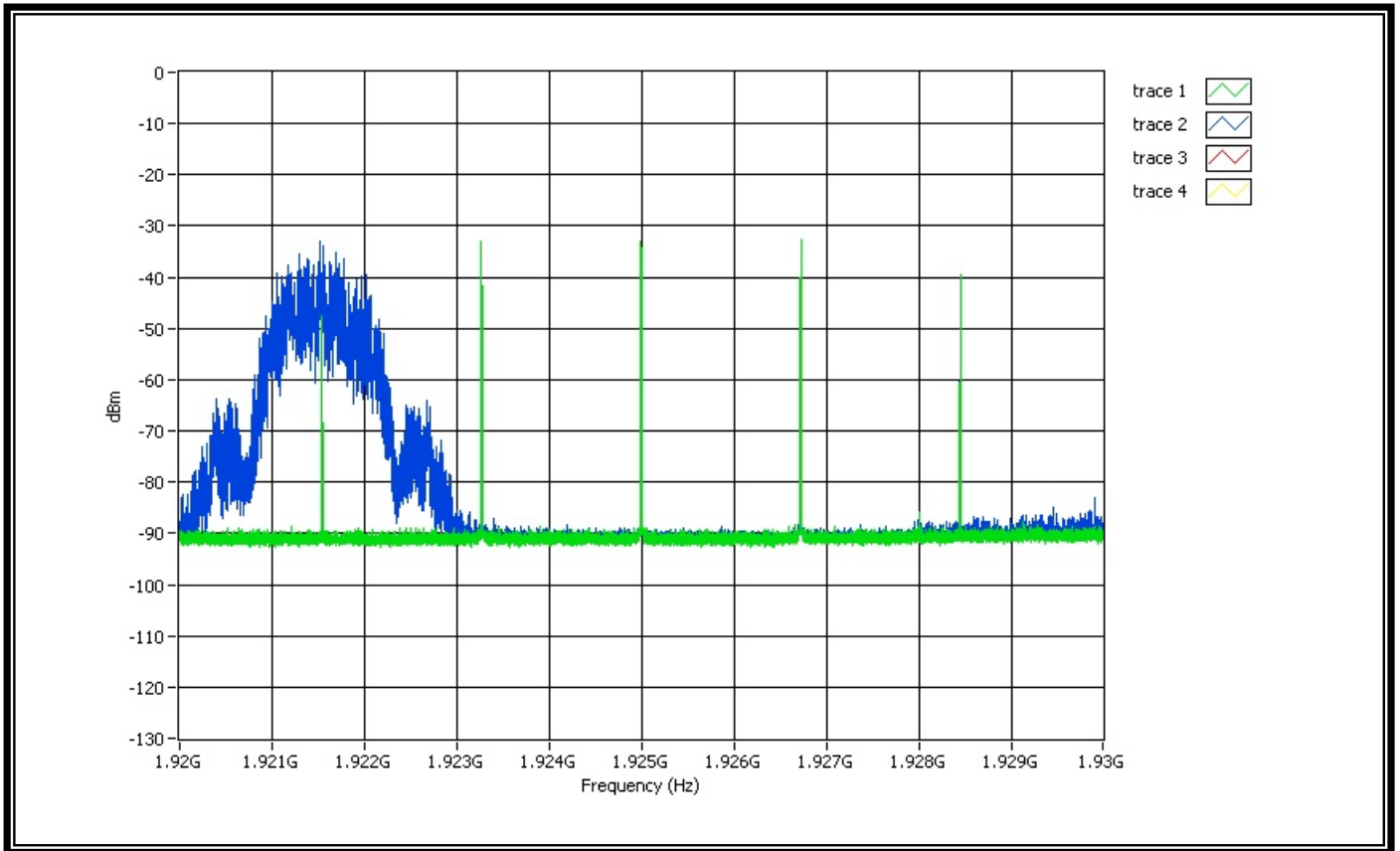

Comment1: Trace1 (green) shows the interference profile.

Comment2: Trace2 (blue) shows the EUT transmissions are occurring.

Comment3: The EUT always transmits on f1 (the carrier with the lower interference level) and so meets the requirement.

Comment: 7.3.2d

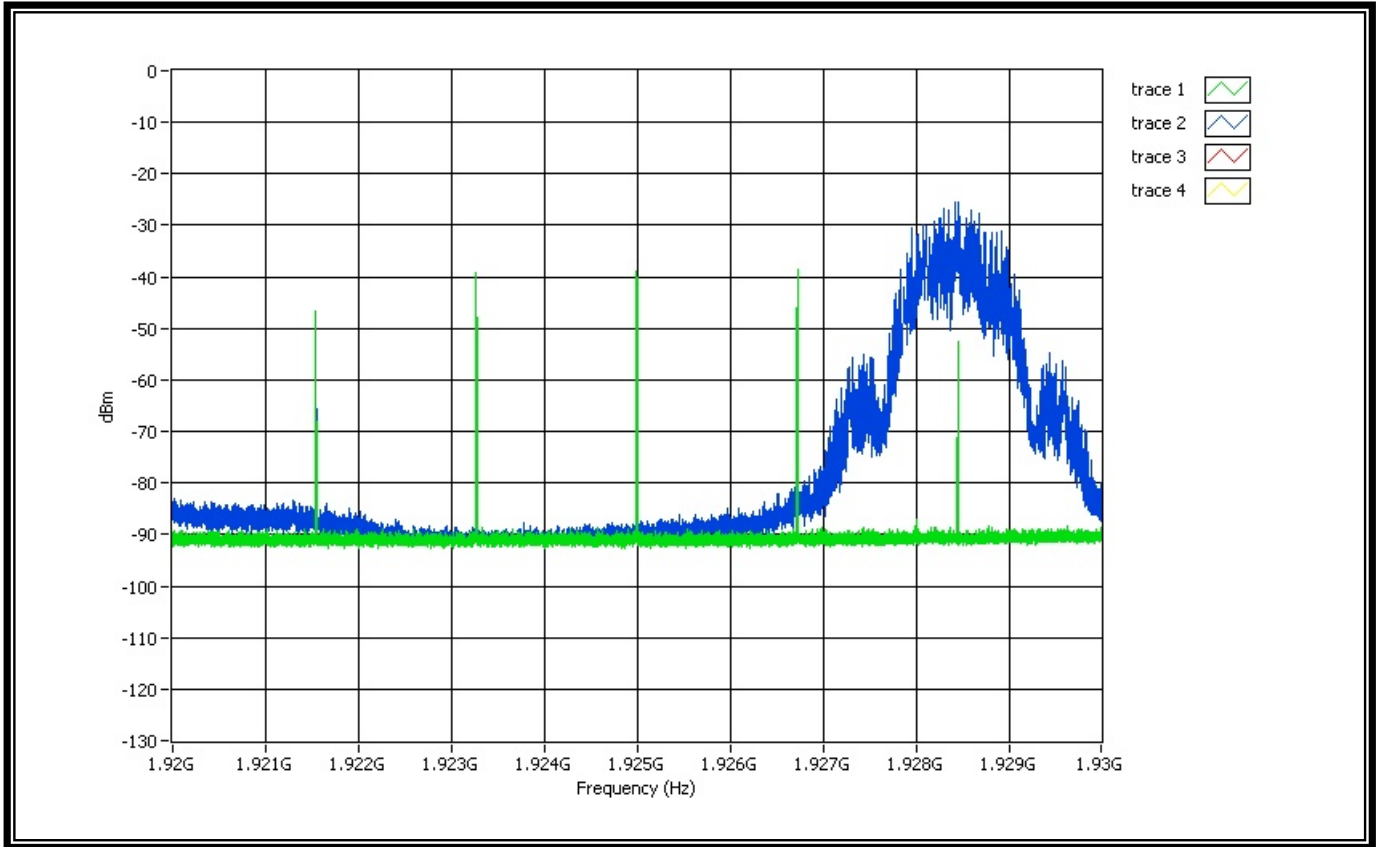

Comment1: Trace1 (green) shows the interference profile.

Comment2: Trace2 (blue) shows the EUT transmissions are occurring.

Comment3: The EUT always transmits on f2 (the carrier with the lower interference level) and so meets the requirement.

Comment: 7.3.2e

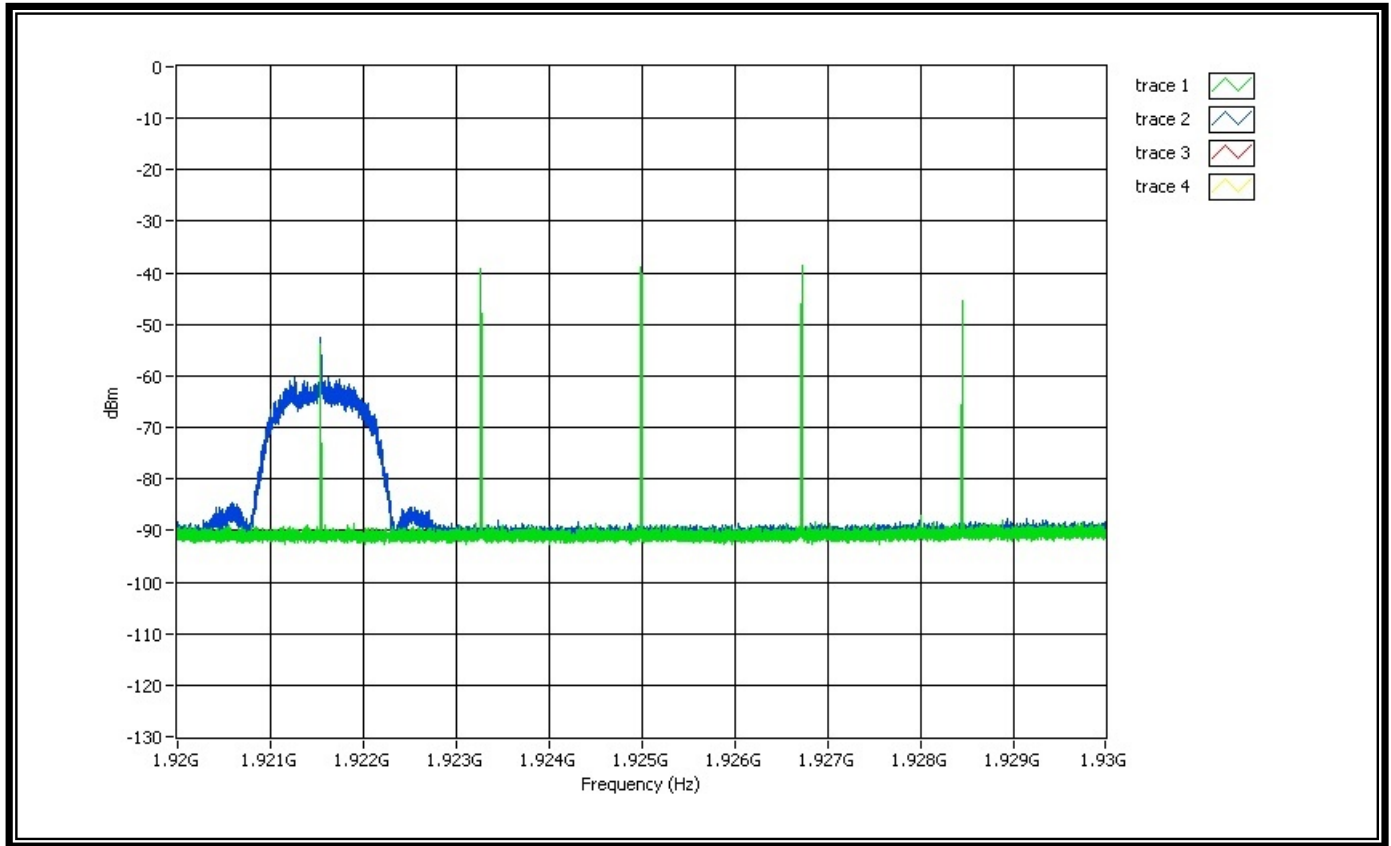

Comment1: Trace1 (green) shows the interference profile.

Comment2: Trace2 (blue) shows the EUT transmissions are occurring.

Comment3: The EUT always transmits on f1 (the carrier with the lower interference level) and so meets the requirement.

Comment: 7.3.3

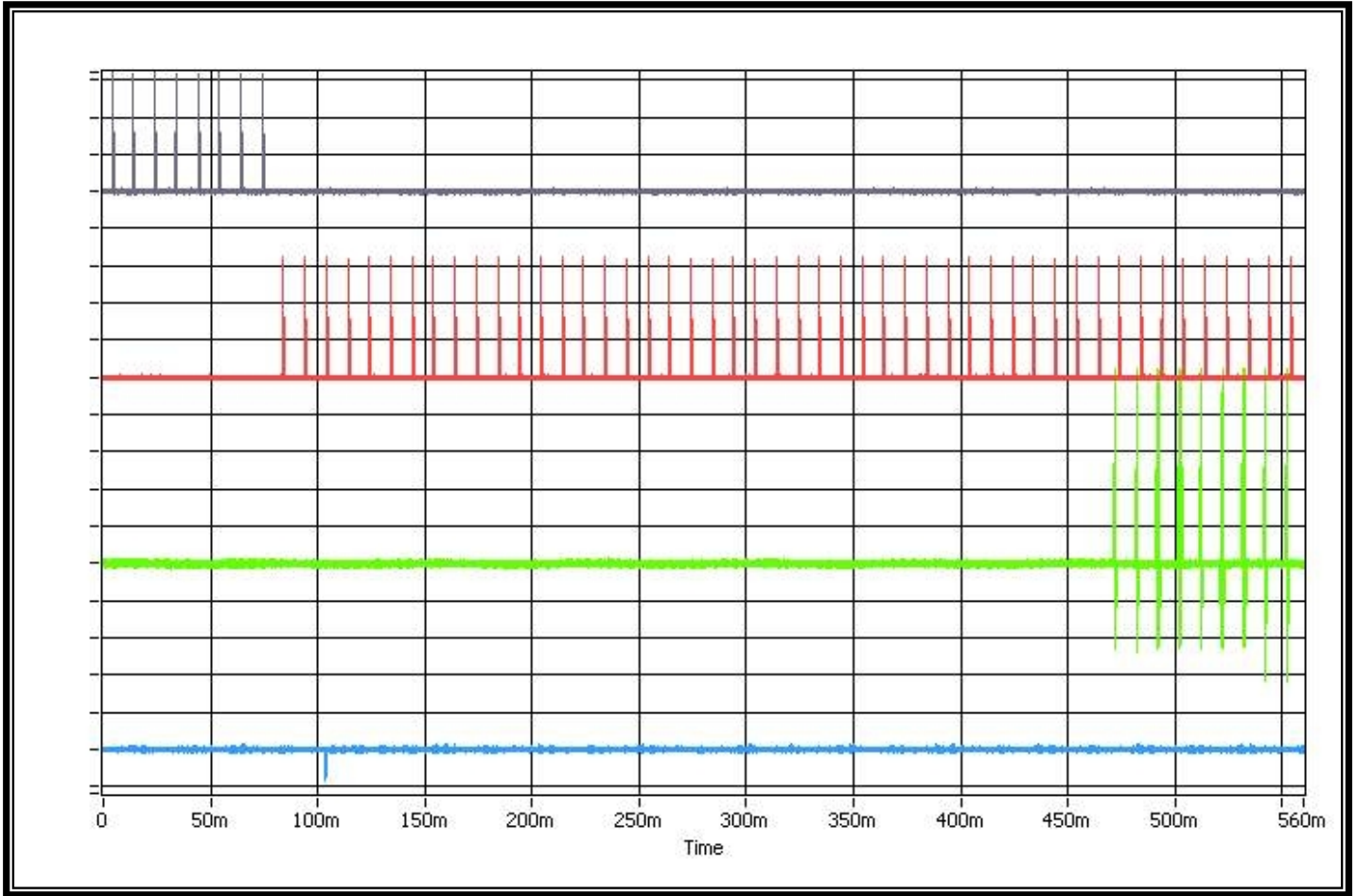

- Comment1: Trace1 (deep blue, top) shows interference on f1.
- Comment2: Trace2 (red, 2nd from top) shows the interference on f2.
- Comment3: Trace3 (green, 3rd from top) shows EUT transmissions on f1.
- Comment4: Trace4 (light blue, 4th from top) shows the signal to the handset to trigger the transmissions.
- Comment5: Set interference on all system carriers except f2, at a level of T_L+U_M , in-band per carrier.
- Comment6: Apply interference on f2 at a level of T_L+U_M+20 , in-band, and immediately remove all interference from f1 and immediately (but not sooner than 20 ms after the interference on f2 is applied) cause the EUT to attempt transmission.
- Comment7: The EUT transmits on f1 and so meets the requirement.

Comment: 7.3.4 (Zoom in)

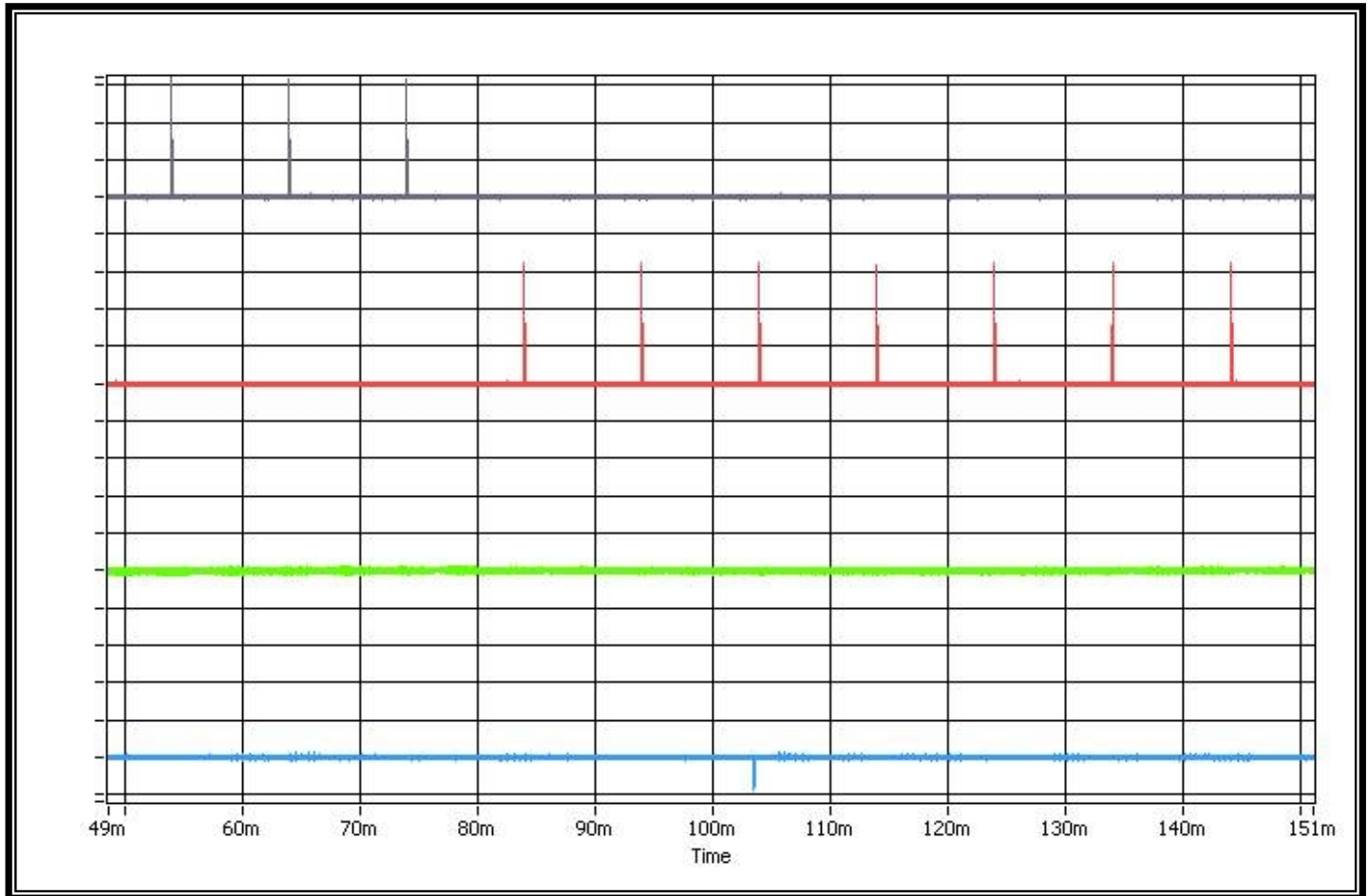

Comment1: Trace1 (deep blue, top) shows interference on f1.

Comment2: Trace2 (red, 2nd from top) shows the interference on f2.

Comment3: Trace3 (green, 3rd from top) shows EUT transmissions on f1.

Comment4: Trace4 (light blue, 4th from top) shows the signal to the handset to trigger the transmissions.
The signal is not sooner than 20 ms after the interference on f2 is applied.

6.19 Random waiting

6.19.1 Standard Applicable: FCC 15.323 (c)(6) same as RSS-213 5.2(6)

If the selected combined time and spectrum windows are unavailable, the device may either monitor and select different windows or seek to use the same window after waiting an amount of time, randomly chosen from a uniform random distribution between 10 and 150 milliseconds, commencing when the channel becomes available.

6.19.2 Measurement procedure

Measurement method according to ANSI C63.17-2013 paragraph 8.1.3

6.19.3 Results:

The manufacturer declares that this provision is not utilized by the EUT.

6.20 Monitoring bandwidth and reaction time

6.20.1 Standard Applicable: FCC 15.323(c)(7)

The monitoring system band width must be equal to or greater than the emission band width of the intended transmission and have a maximum reaction time less than $50 \times \text{SQRT}(1.25/\text{emission band width in MHz})$ microseconds for signals at the applicable threshold level but shall not be required to be less than 50 microsecond. If a signal is detected that is 6 dB or more above the applicable threshold level, the maximum reaction time shall be $35 \times \text{SQRT}(1.25/\text{emission band width in MHz})$ microseconds but shall not be required to be less than 35 microseconds.

RSS-213 5.2(7)

The monitoring system bandwidth must be equal to or greater than the occupied bandwidth of the intended transmission. **Note:** Testing of the monitoring system bandwidth is not required if the designed bandwidth from the manufacturer is available and given in the test report.

The monitor shall have a maximum reaction time less than $50\sqrt{1.25/\text{occupied bandwidth in MHz}}$ microseconds for signals at the applicable threshold level but shall not be required to be less than 50 microseconds.

If a signal is detected that is 6 dB or more above the threshold level, the maximum reaction time shall be $35\sqrt{1.25/\text{occupied bandwidth in MHz}}$ microseconds but shall not be required to be less than 35 microseconds.

6.20.2 Measurement procedure

Measurement method according to ANSI C63.17-2013 paragraph 7.5

6.20.3 Results: Meets the requirement

Measurement Data

Calculation of applied pulse width and maximum reaction time:

For emission bandwidth > 1.25MHz, the pulse width is always 35us and 50us.

Used results	Emission bandwidth B (MHz)	1.45 MHz
Maximum reaction time and pulse width	$50\sqrt{1.25/B}$ (μs)	46.4 μs
	$35\sqrt{1.25/B}$ (μs)	32.5 μs

Result:

Test Date : Jul. 18, 2017

Temperature : 20 °C

Humidity : 58%

Pulse width (μs)	Connection
$50 \mu\text{s}$ or $50\sqrt{1.25/B}$	no
$35 \mu\text{s}$ or $35\sqrt{1.25/B}$	no

Comment: 50us

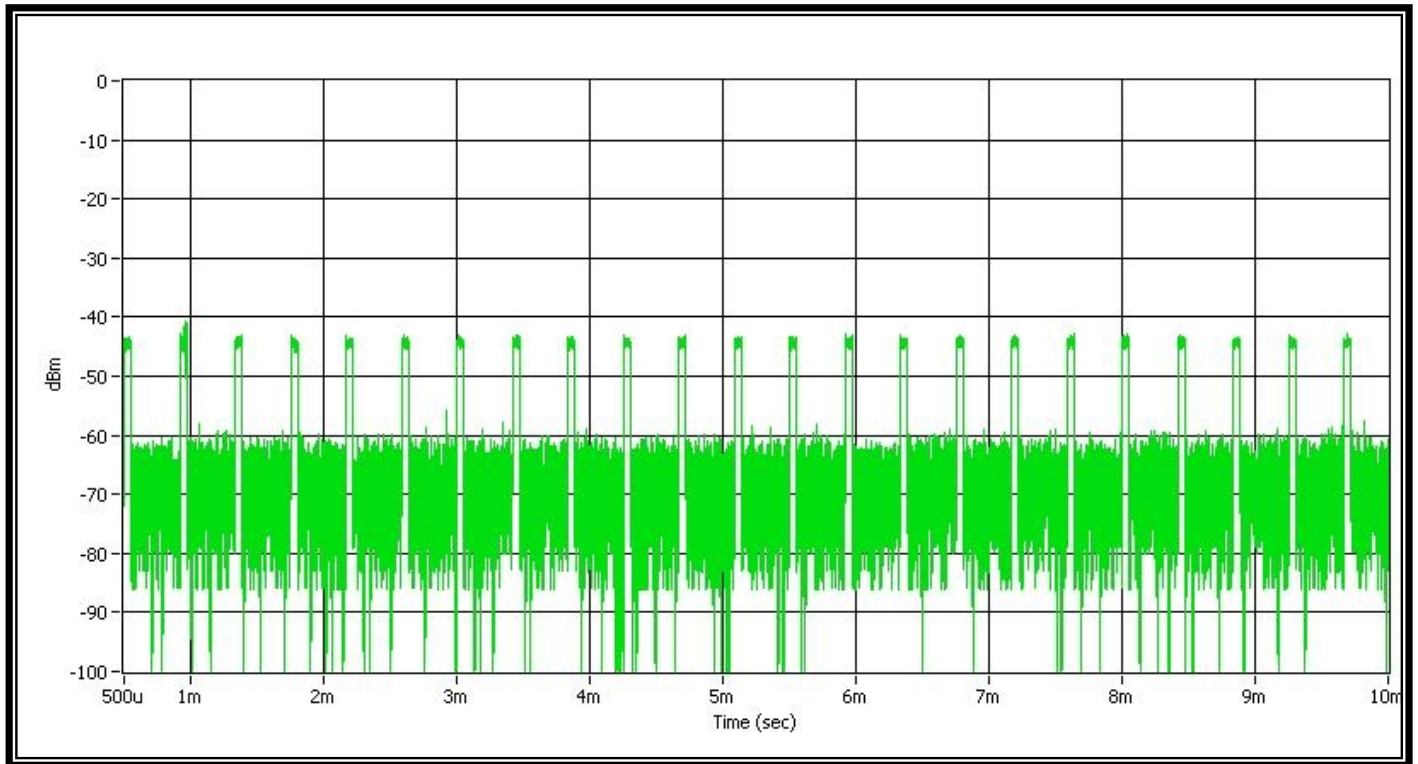

Comment: 50us (Zoom in)

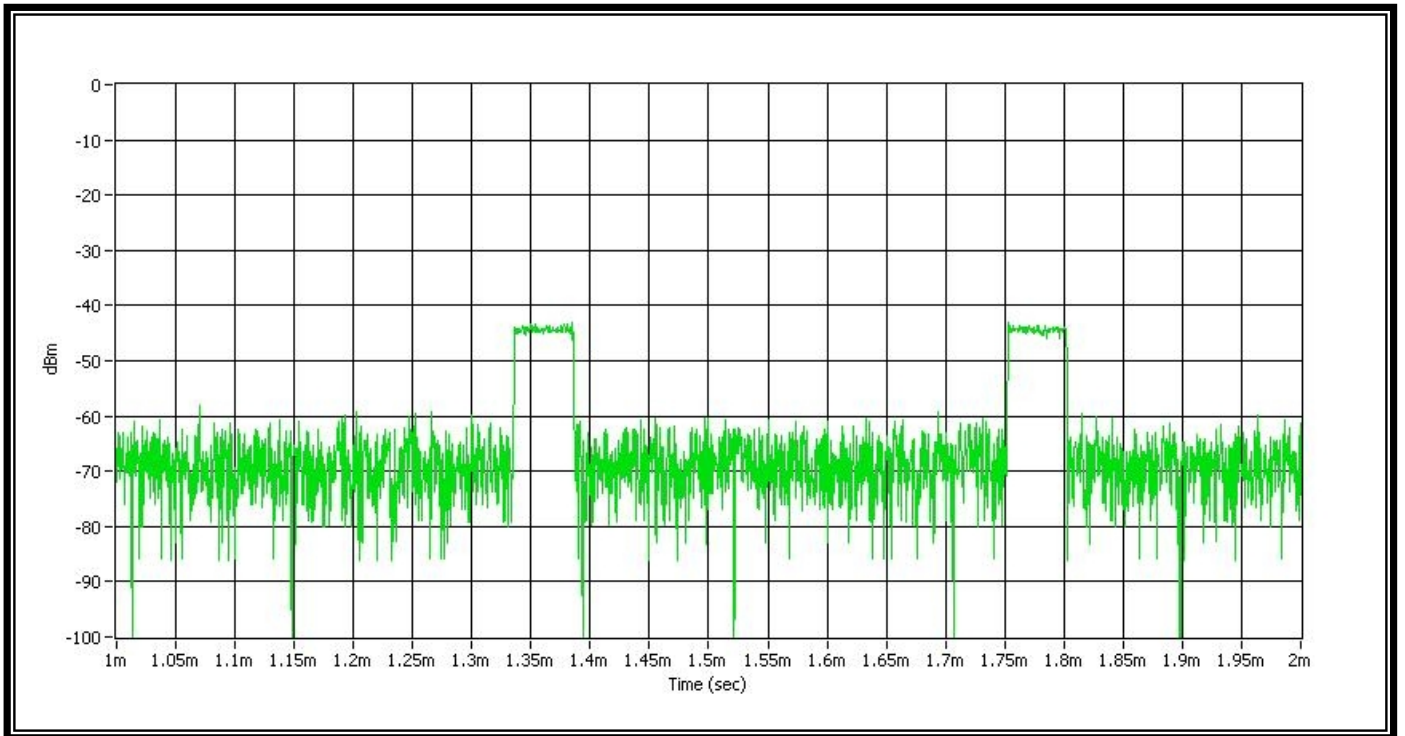

Comment: 50us (5 carriers)

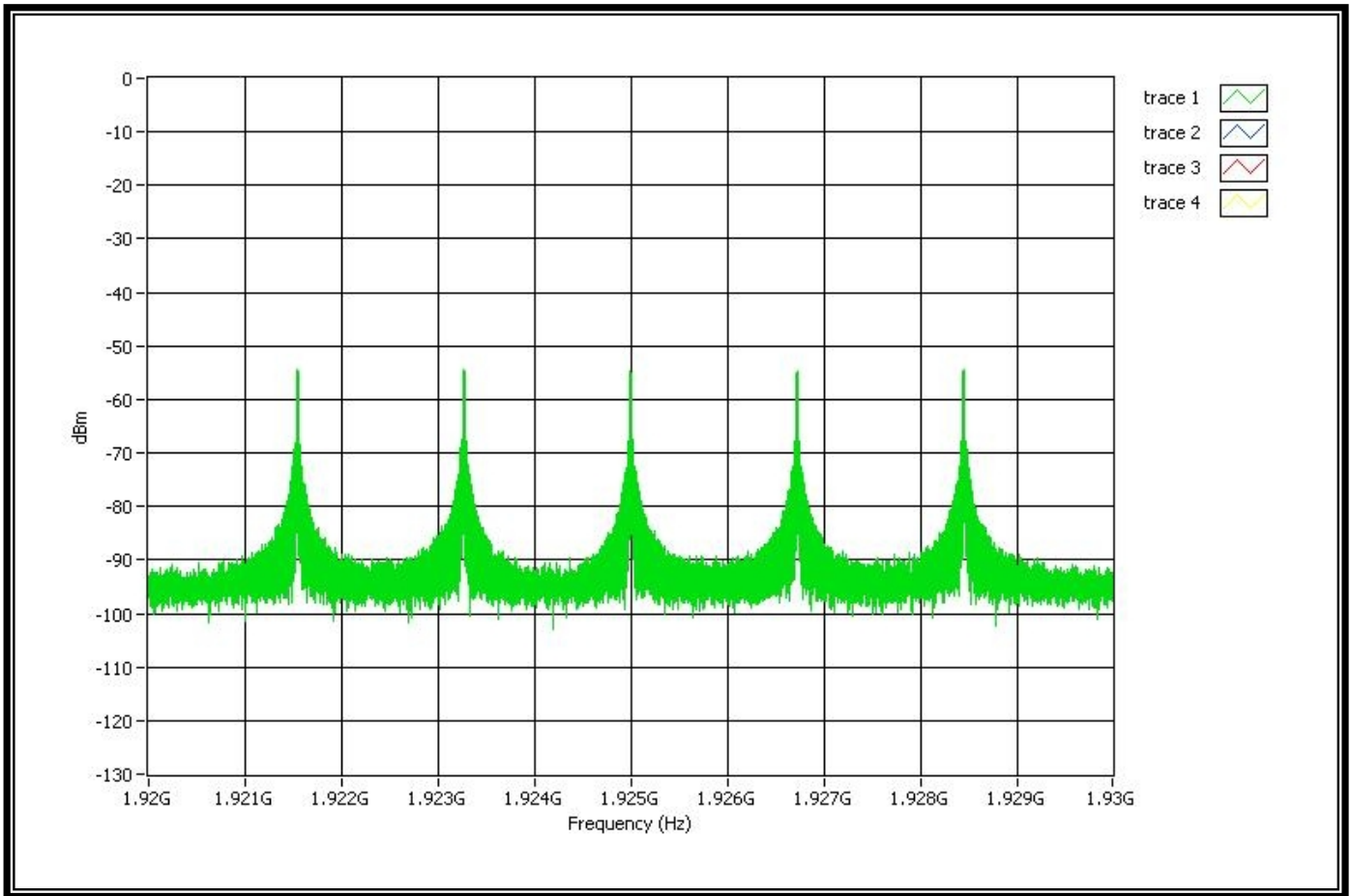

Comment: 35us

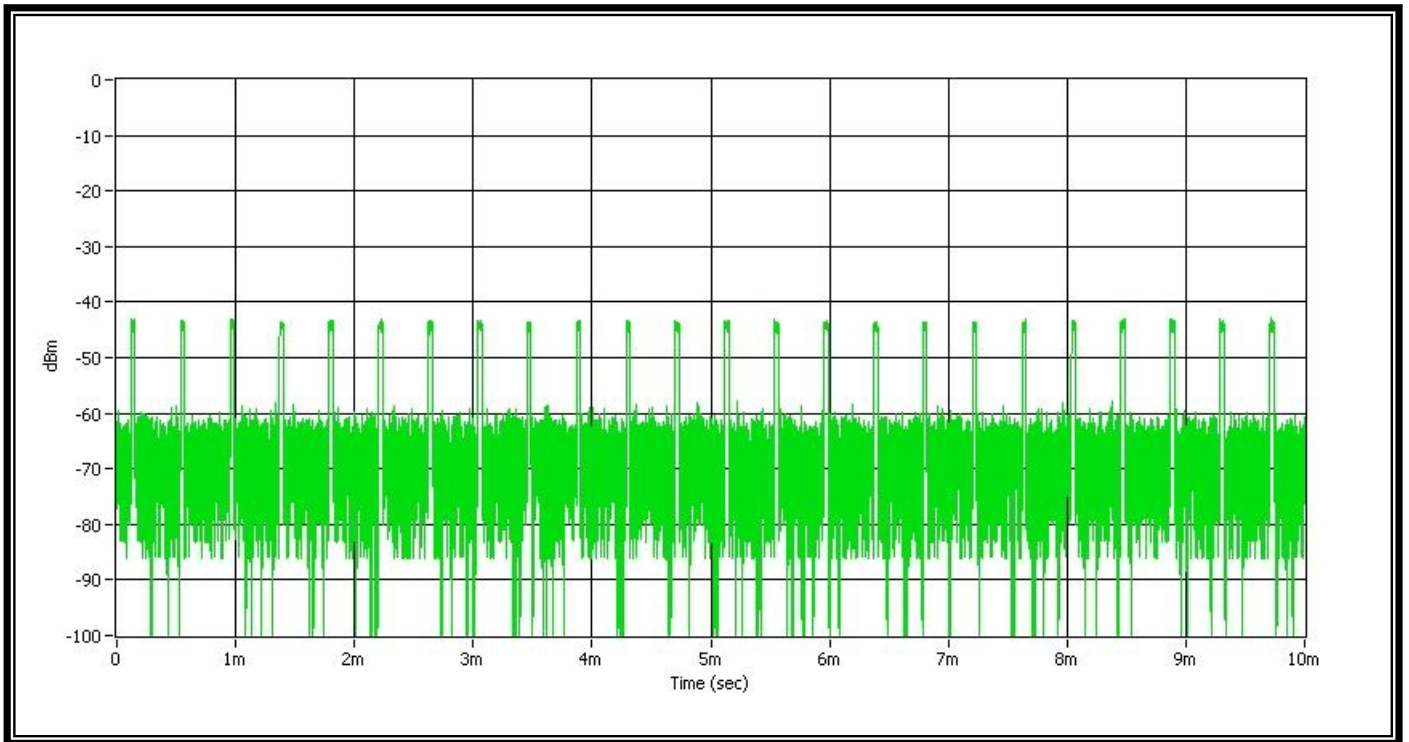

Comment: 35us (Zoom in)

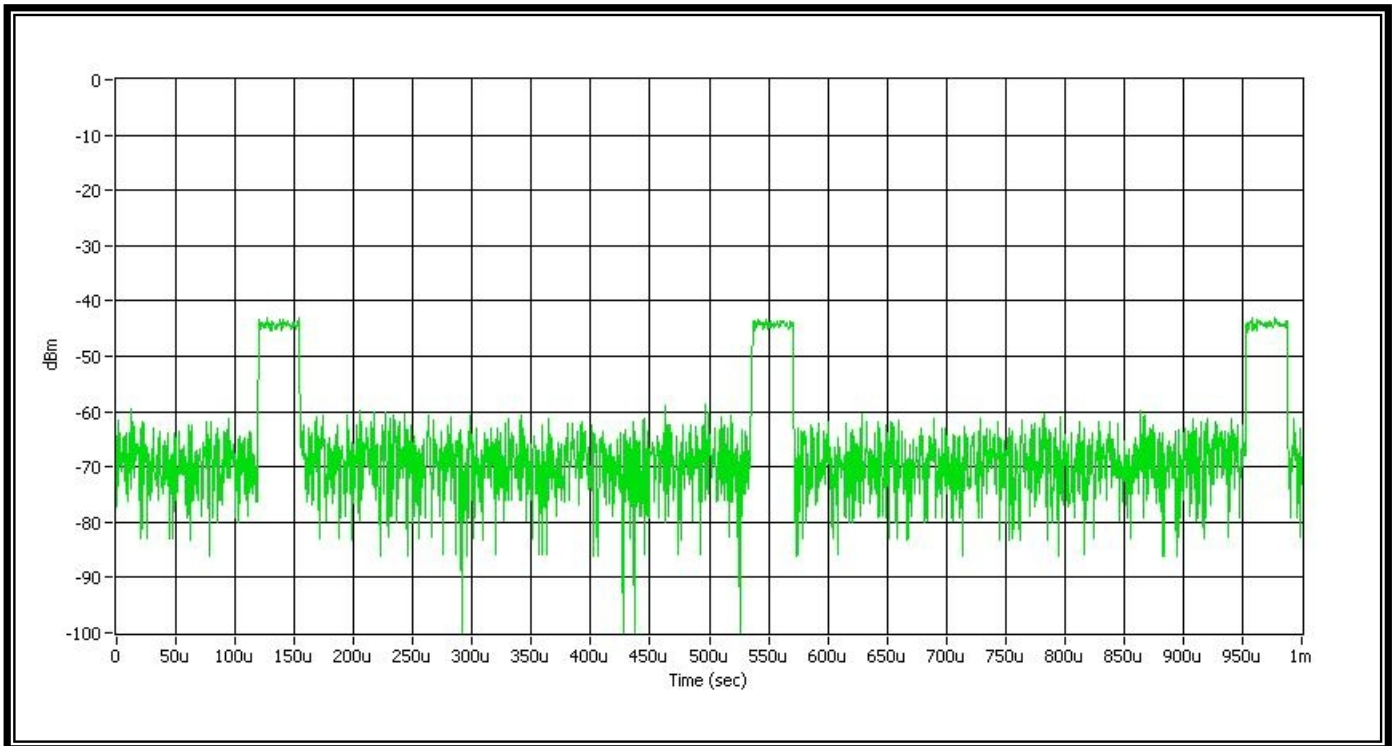

Comment: 35us (5 carriers)

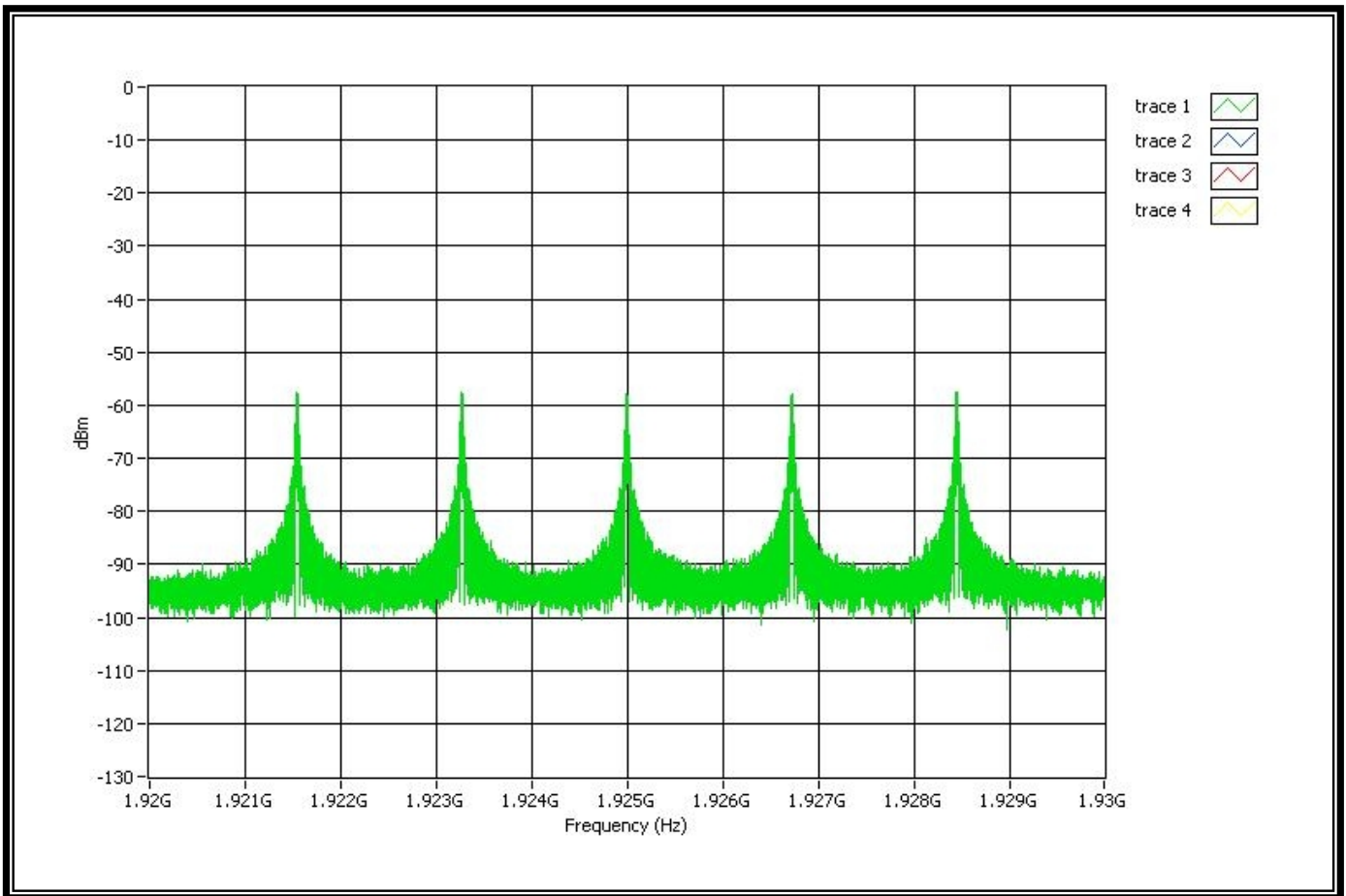

6.21 Monitoring antenna

6.21.1 Standard Applicable: FCC 15.323(c) (8)

The monitoring system shall use the same antenna used for transmission, or an antenna that yields equivalent reception at that location.

RSS-213 5.2(8)

The monitoring system shall use the same antenna used for transmission, or an antenna that yields equivalent reception at that location. Note: A monitoring antenna of the same model (and manufacturer) as the transmitting antenna is considered equivalent. An antenna not of the same model but of the same type (e.g. both are horn antennas of different manufacturers) is considered equivalent if the main beam antenna gains are within 3 dB of each other. Both antennas are to be installed to point at the same general coverage area.

6.21.2 Measurement procedure

Measurement method according to ANSI C63.17-2013 paragraph 4

6.21.3 Results: Complies

The EUT uses the same antennas for transmission and reception as for monitoring.

6.22 Monitoring threshold relaxation

6.22.1 Standard Applicable: FCC 15.323(c)(9)

Devices that have a power output lower than the maximum permitted under the rules can increase their monitoring detection threshold by one decibel for each one decibel that the transmitter power is below the maximum permitted.

RSS-213 5.2(9)

Devices that have a power output lower than the maximum permitted under this standard may increase their detection threshold by 1 dB for each 1 dB that the transmitter power is below the maximum permitted.

6.22.2 Measurement procedure

Measurement method according to ANSI C63.17-2013 paragraph 4

6.22.3 Results: Complies

Measurement Data:

This requirement is covered by results of Least Interfered Channel (LIC) test according to FCC 15.323(c) (5)	☒
--	---

6.23 Duplex system LBT

6.23.1 Standard Applicable: FCC 15.323(c) (10)

An initiating device may attempt to establish a duplex connection by monitoring both its intended transmit and receive time and spectrum windows. If both the intended transmit and receive time and spectrum windows meet the access criteria, then the initiating device can initiate a transmission in the intended transmit time and spectrum window. If the power detected by the responding device can be decoded as a duplex connection signal from the initiating device, then the responding device may immediately begin transmitting on the receive time and spectrum window monitored by the initiating device.

RSS-213 5.2 (10)

A device initiating a communication (hereafter called an initiating device) may attempt to establish a duplex connection by monitoring both its intended transmit and receive time and spectrum windows. If both the intended transmit and receive time and spectrum windows meet the access criteria, then the initiating device can initiate a transmission in the intended transmit time and spectrum window. If the power detected by the responding device can be decoded as a duplex connection signal from the initiating device, then the responding device may immediately begin transmitting in the receive time and spectrum window monitored by the initiating device.

6.23.2 Measurement procedure

Measurement method according to ANSI C63.17-2013, clause 8.3
This test is required for equipment that uses the access criteria in FCC 15.323(c)(10).

6.23.3 Test Results:

The manufacturer declares that this provision is not utilized by the EUT.

6.24 Co-located device LBT

6.24.1 Standard Applicable: FCC 15.323 (c)(11) same as RSS-213 5.2 (11)

An initiating device that is prevented from monitoring during its intended transmit window due to monitoring system blocking from the transmissions of a co-located (within one meter) transmitter of the same system, may monitor the portions of the time and spectrum windows in which they intend to receive over a period of at least 10 milliseconds. The monitored time and spectrum window must total at least 50 percent of the 10 millisecond frame interval and the monitored spectrum must be within 1.25 MHz of the center frequency of channel(s) already occupied by that device or co-located co-operating device. If the access criteria is met for the intended receive time and spectrum window under the above conditions, then transmission in the intended transmit window by the initiating device may commence.

6.24.2 Measurement procedure

Measurement method according to ANSI C63.17-2013 paragraph 8.4

6.24.3 Results:

The manufacturer declares that this provision is not utilized by the EUT.

6.25 Fair Access

6.25.1 Standard Applicable: FCC 15.323 (c)(12)

The provisions of (c) (10) or (c) (11) shall not be used to extend the range of spectrum occupied over space or time for the purpose of denying fair access to spectrum for other devices.

RSS-213 5.2 (12)

The provisions of paragraphs 5.2(10) and (11) shall not be used to extend the range of spectrum occupied over space or time for the purpose of denying fair access to spectrum to other devices.

6.25.2 Results:

The manufacturer declares that EUT does not work in a mode which denies fair access to spectrum for other devices.

6.26 Emissions inside and outside the subband

6.26.1 Standard Applicable: FCC 15.323(d)

Emissions outside the band shall be attenuated below a reference power of 112 milliwatts as follows: 30 dB between the band and 1.25 MHz above or below the band; 50 dB between 1.25 and 2.5 MHz above or below the band; and 60 dB at 2.5 MHz or greater above or below the band. Emissions inside the band must comply with the following emission mask: In the bands between 1B and 2B measured from the center of the emission bandwidth the total power emitted by the device shall be at least 30 dB below the transmit power permitted for that device; in the bands between 2B and 3B measured from the center of the emission bandwidth the total power emitted by an intentional radiator shall be at least 50 dB below the transmit power permitted for that radiator; in the bands between 3B and the band edge the total power emitted by an intentional radiator in the measurement bandwidth shall be at least 60 dB below the transmit power permitted for that radiator. B” is defined as the emission bandwidth of the device in hertz. Compliance with the emission limits is based on the use of measurement instrumentation employing peak detector function with an instrument resolution bandwidth approximately equal to 1.0 percent of the emission bandwidth of the device under measurement.

RSS-213 5.8.1

Emissions outside the band 1920-1930 MHz shall be attenuated below a reference power of 112 mW (-9.5 dBW) by at least:

- 30 dB between the band edges and 1.25 MHz above and below the band edges;
- 50 dB between 1.25 MHz and 2.5 MHz above or below the band edges; and
- 60 dB at 2.5 MHz or greater above or below the band edges.

RSS-213 5.8.2

Emissions inside the band 1920-1930 MHz shall be attenuated below the transmit power permitted for that device, as follows:

- 30 dB between the frequencies 1B and 2B measured from the centre of the occupied bandwidth;
- 50 dB between the frequencies 2B and 3B measured from the centre of the occupied bandwidth;
- 60 dB between the frequencies 3B and band edges;

where B is the occupied bandwidth in hertz.

6.26.2 Measurement procedure

Measurement method according to ANSI C63.17-2013 paragraph 6.1.6

6.26.3 Results: Complies

Measurement Data:

See plots.

Note: Photos of worst-case display follow:

In-band Unwanted Emissions: CH FL

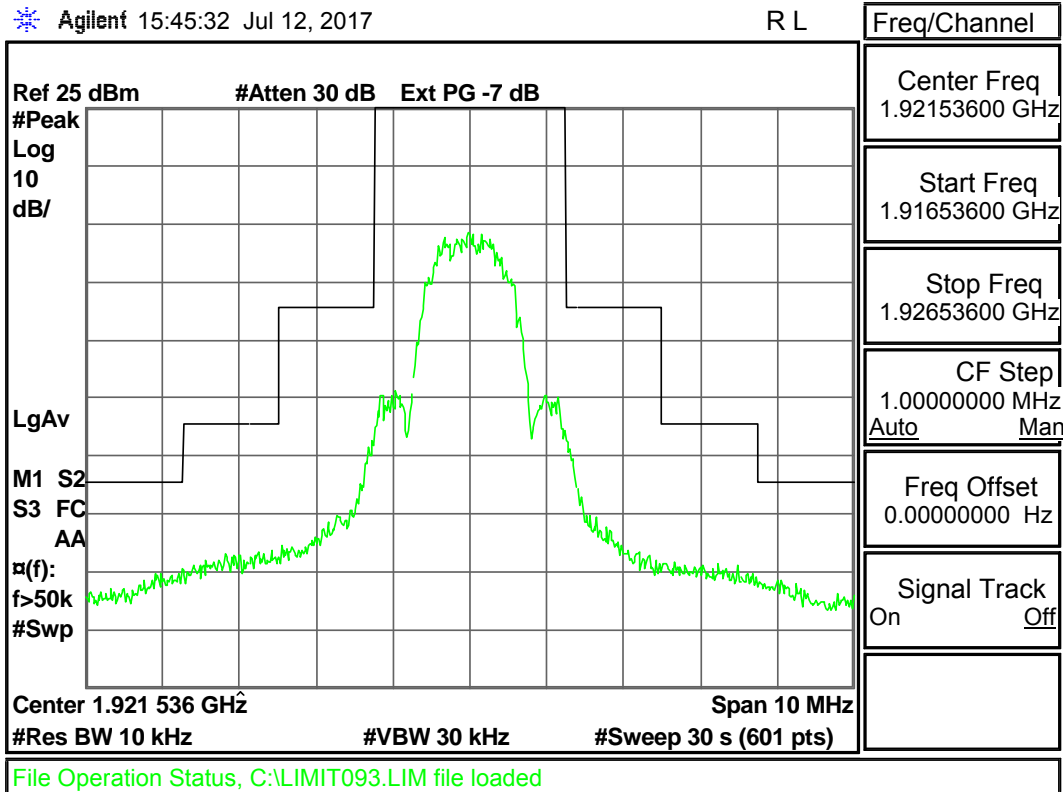

In-band Unwanted Emissions: CH Fm

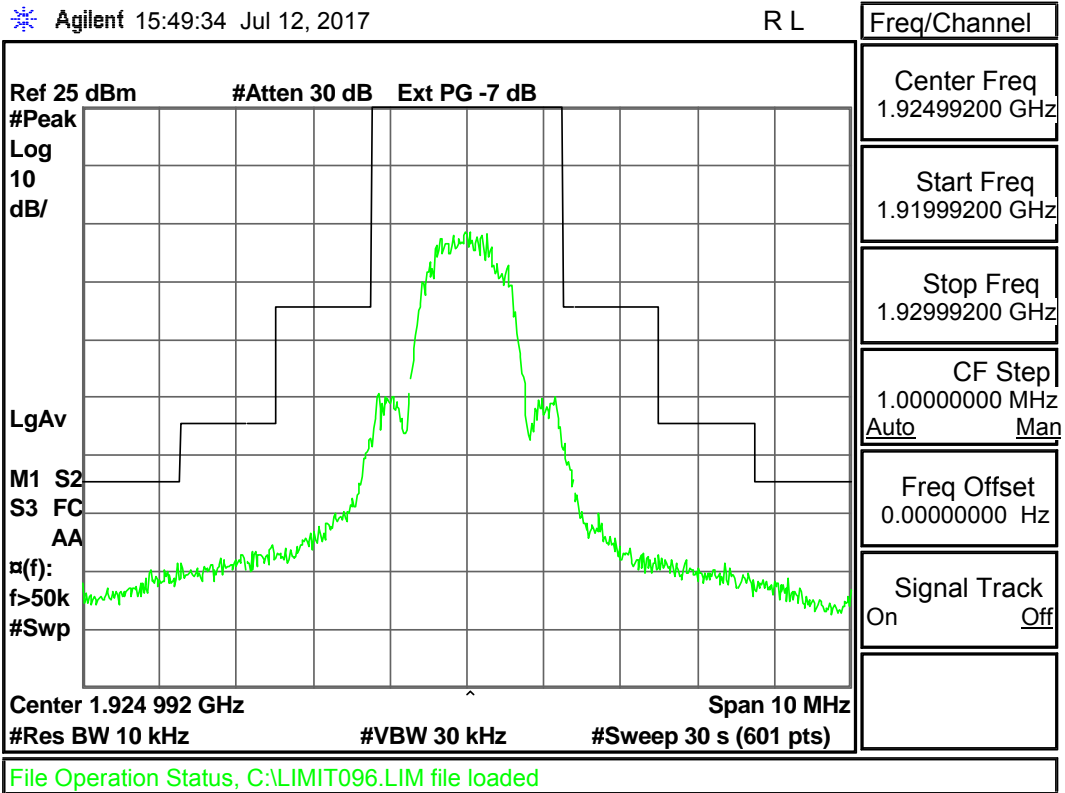

In-band Unwanted Emissions: CH F_H

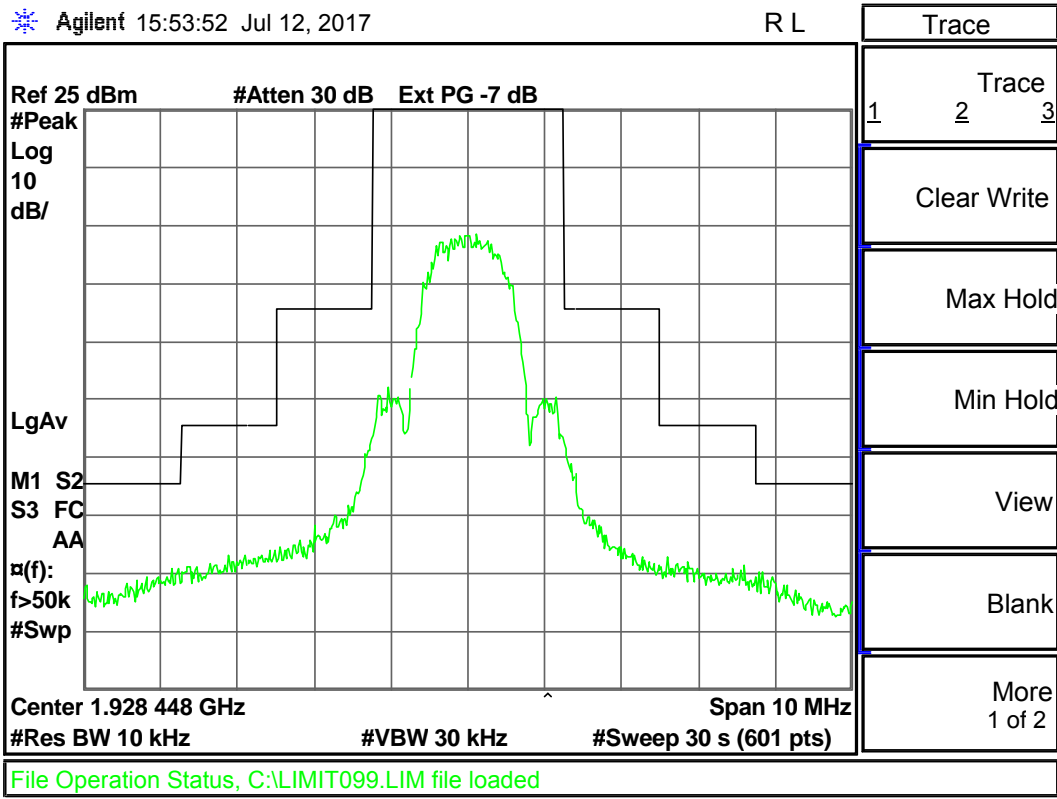

Out-of-band Unwanted Emissions: CH FL

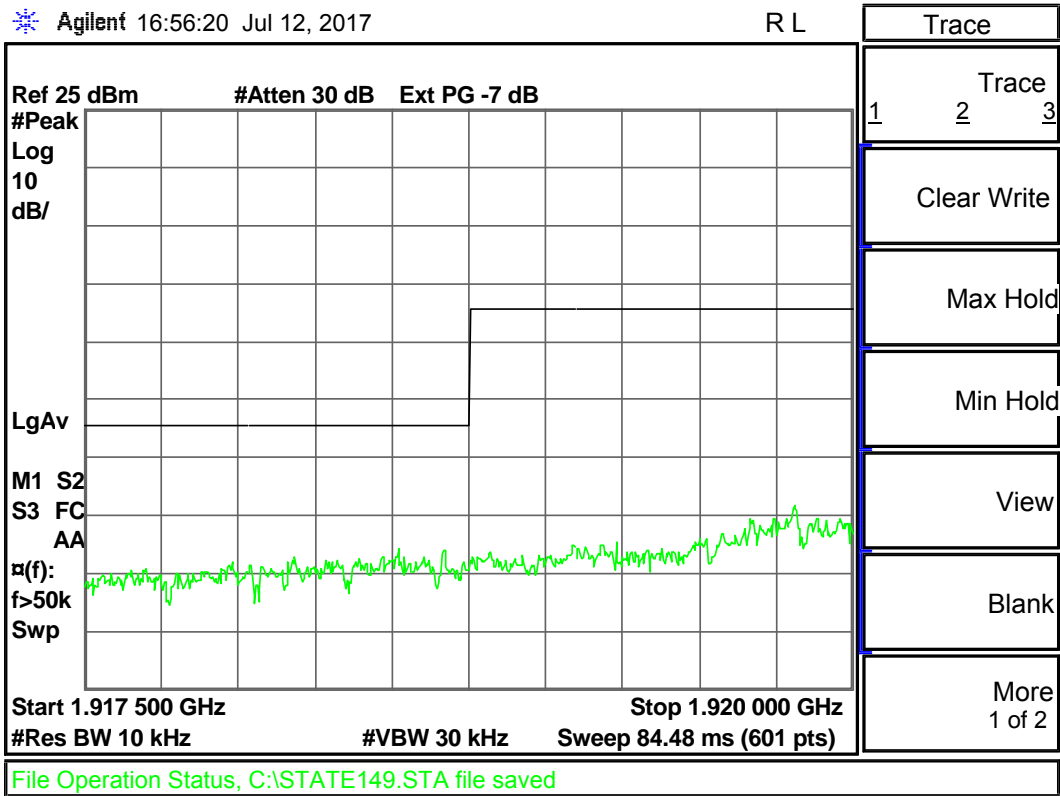

Out-of-band Unwanted Emissions: CH FL

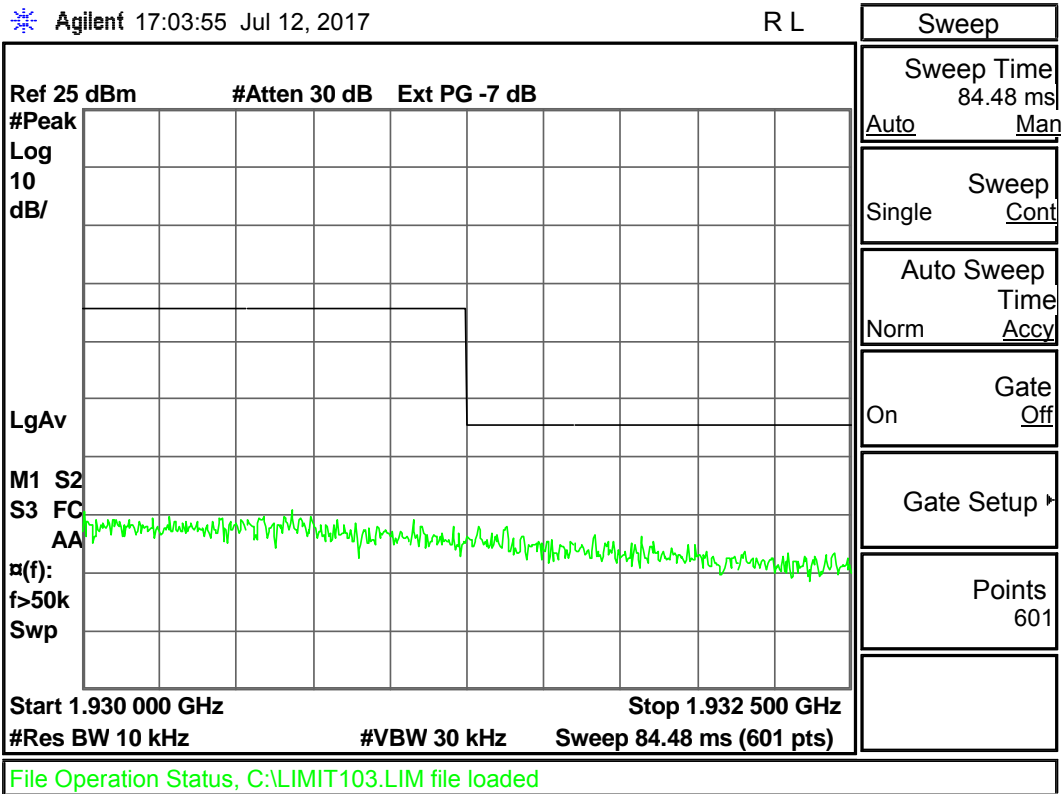

Out-of-band Unwanted Emissions: CH FL

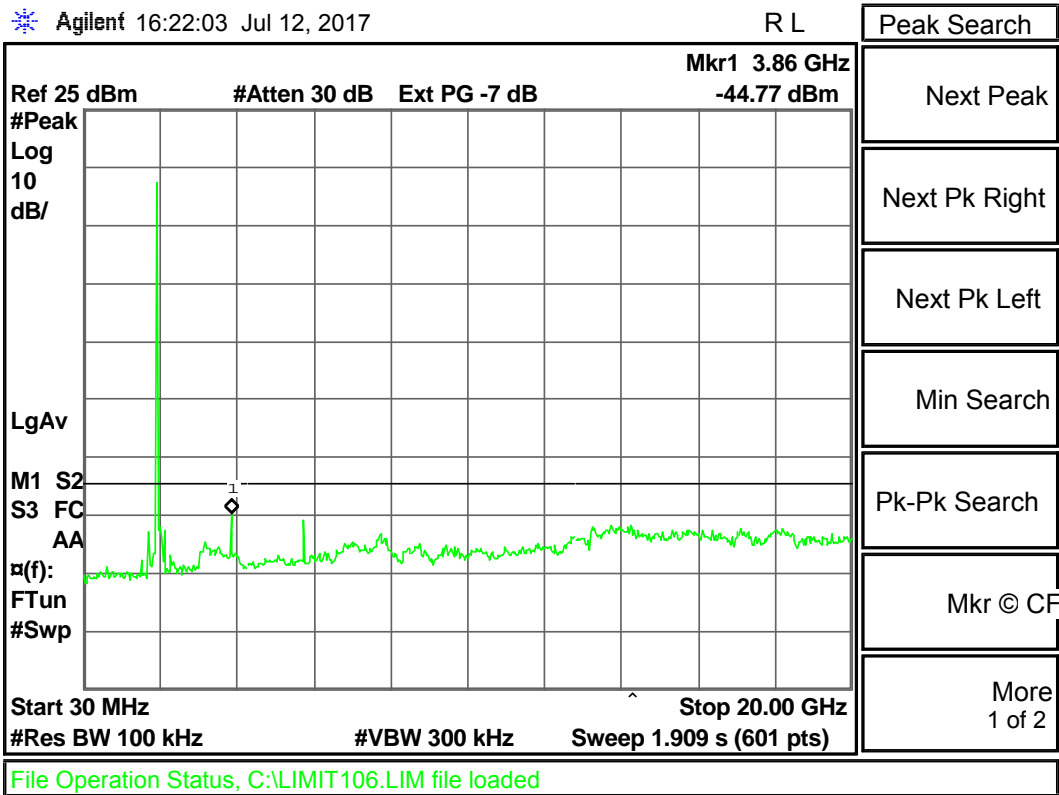

Out-of-band Unwanted Emissions: CH Fm

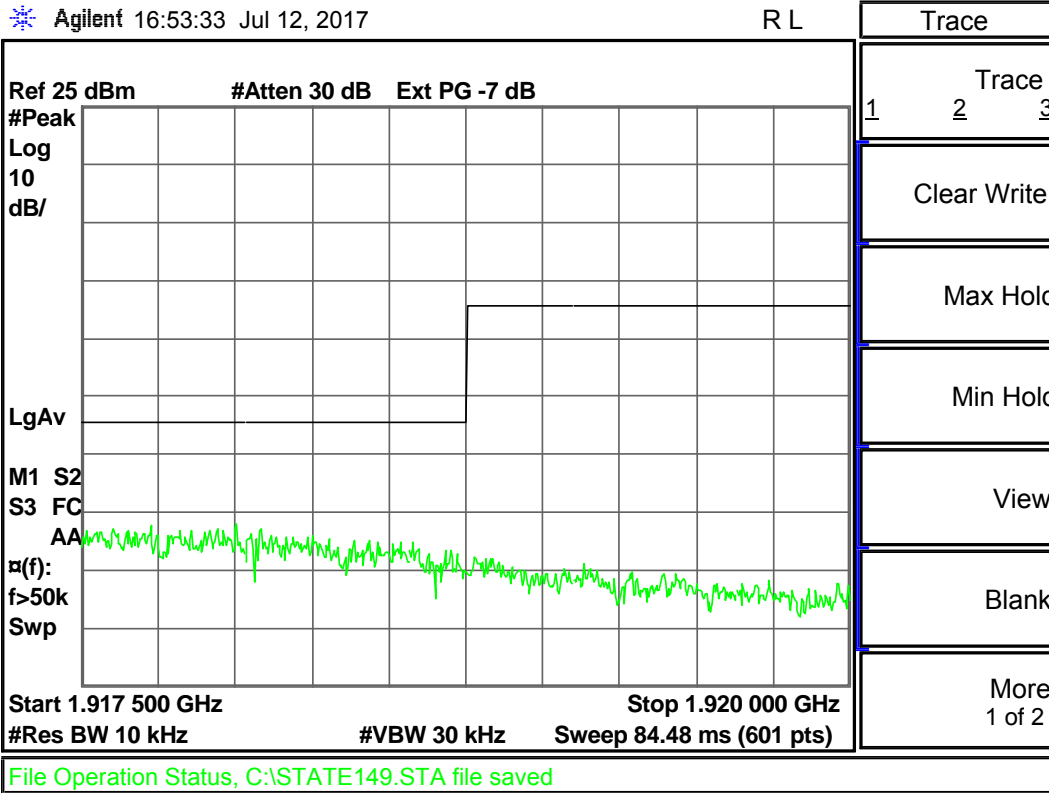

Out-of-band Unwanted Emissions: CH Fm

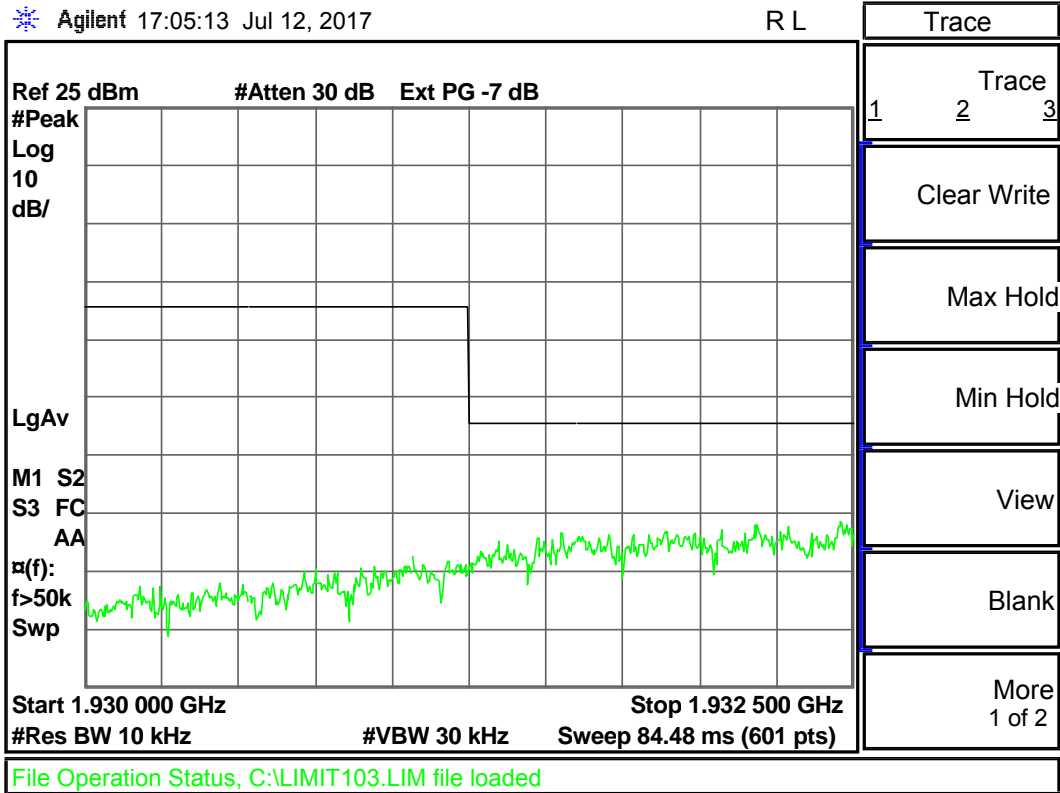

Out-of-band Unwanted Emissions: CH Fm

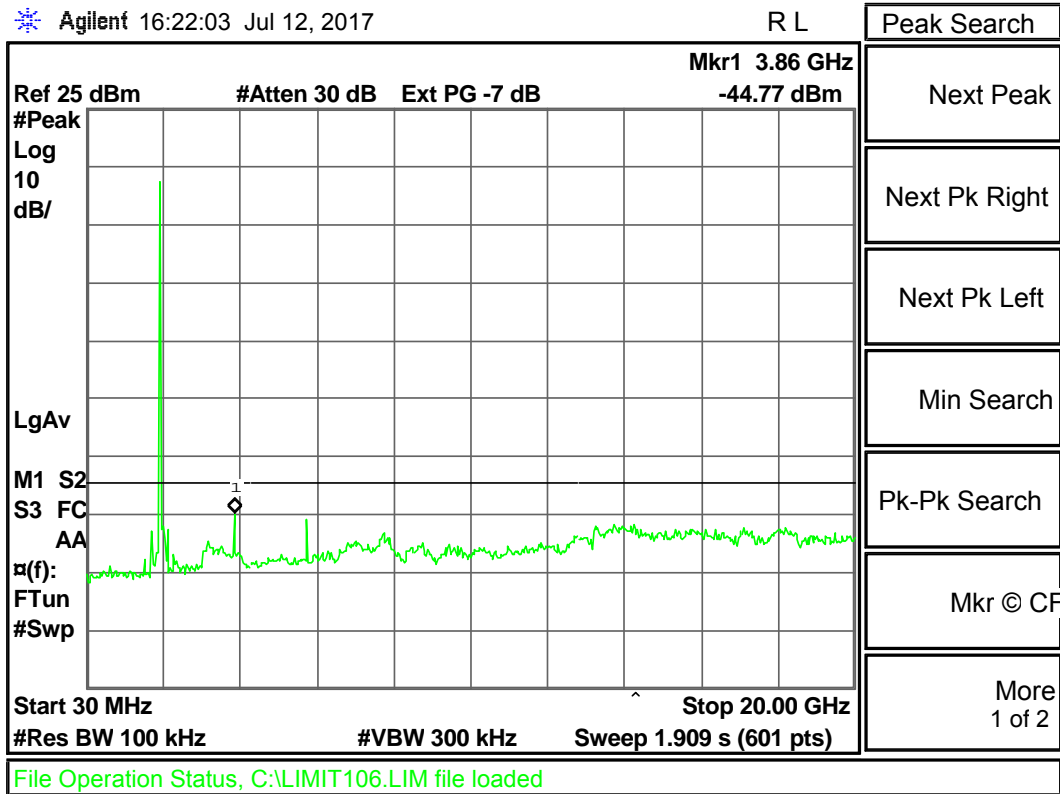

Out-of-band Unwanted Emissions: CH FH

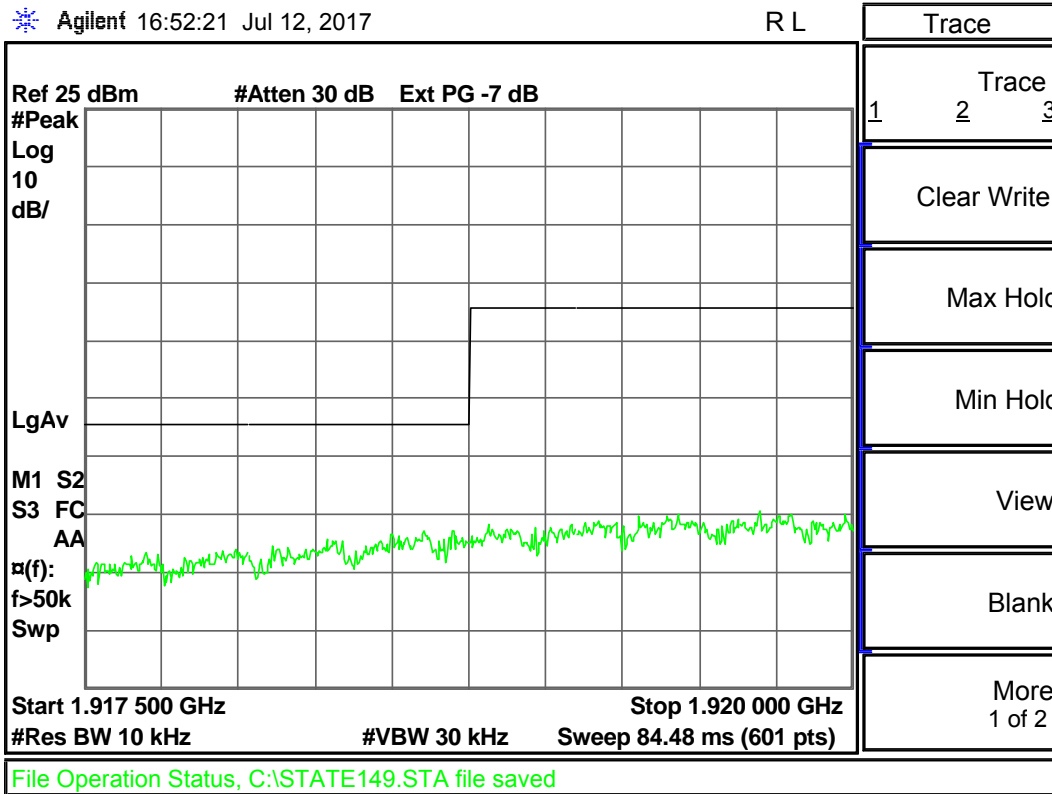

Out-of-band Unwanted Emissions: CH FH

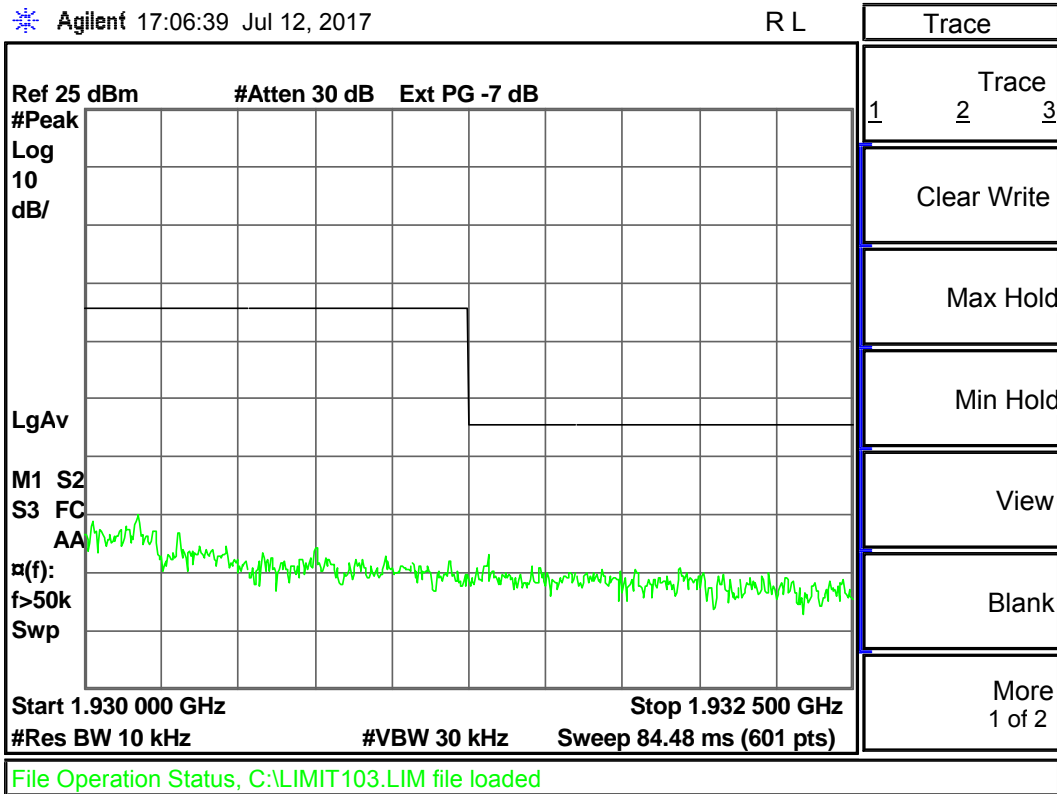

Out-of-band Unwanted Emissions: CH FH

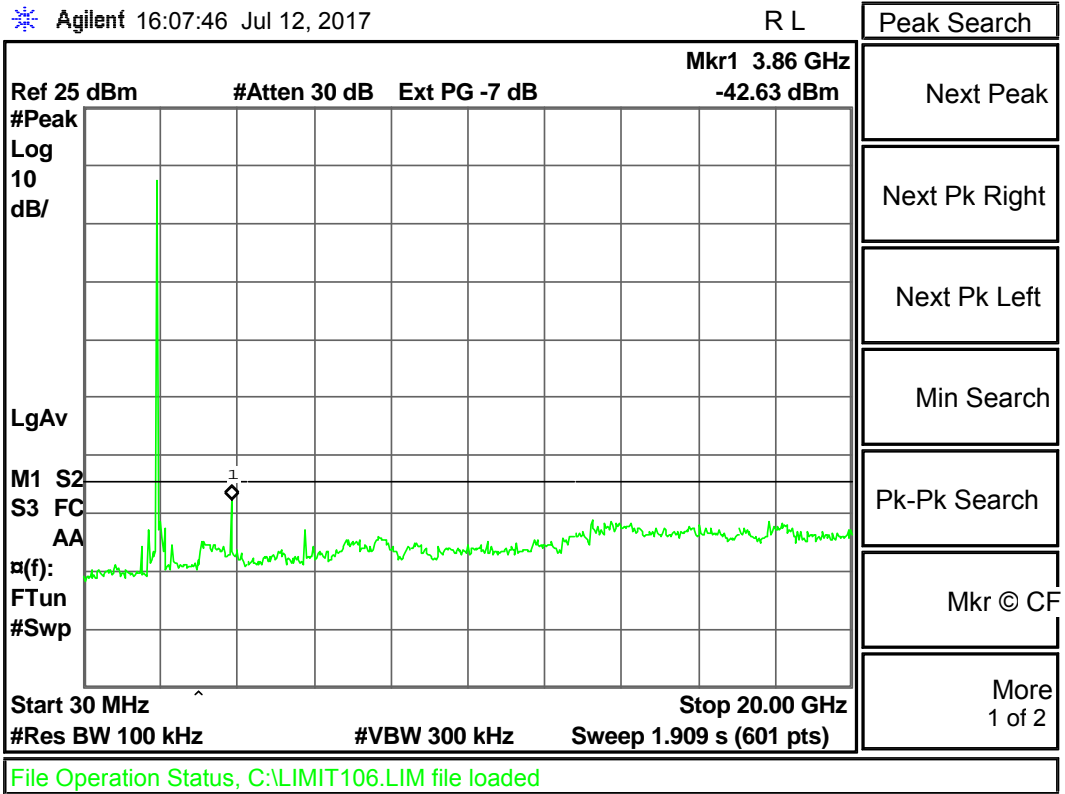

6.27 Frame period and jitter

6.27.1 Standard Applicable: FCC 15.323(e)

The frame period (a set of consecutive time slots in which the position of each time slot can be identified by reference to a synchronizing source) of an intentional radiator operating in these subbands shall be 20 milliseconds/X where X is a positive whole number. Each device that implements time division for the purposes of maintaining a duplex connection on a given frequency carrier shall maintain a frame repetition rate with a frequency stability of at least 50 parts per millions (ppm). Each device which further divides access in time in order to support multiple communication links on a given frequency carrier shall maintain a frame repetition rate with a frequency stability of at least 10 ppm. The jitter (time-related, abrupt, spurious variations in the duration of the frame interval) introduced at the two ends of such a communication link shall not exceed 25 microseconds for any two consecutive transmissions. Transmissions shall be continuous in every time and spectrum window during the frame period defined for the device.

RSS-213 5.2 (13)

The frame period (a set of consecutive time slots in which the position of each time slot can be identified by reference to a synchronizing source) of an intentional radiator operating in this sub-band shall be 20 ms/X where X is a positive whole number.

Each device that implements time division for the purpose of maintaining a duplex connection on a given frequency carrier shall maintain a frame repetition rate with a frequency stability of at least 50 parts per million (ppm).

Each device that further divides access in time in order to support multiple communication links on a given frequency carrier shall maintain a frame repetition rate with a frequency stability of at least 10 ppm.

The jitter (time-related, abrupt, spurious variations in the duration of the frame interval) introduced at the 2 ends of such a communication link shall not exceed 25 μ s for any 2 consecutive transmissions.

Transmissions shall be continuous in every time and spectrum window during the frame period defined for the device.

6.27.2 Measurement Requirement:

- Frame frequency stability \leq 50 ppm
- TDMA frame frequency stability \leq 10 ppm (That translates to frequency drift of 19.2 kHz/slot for 1920 MHz carrier)
- Frame jitter \leq 25 μ s

6.27.3 Test Results: Complies

Measurement Data:

Test Date : Jul. 12, 2017Temperature : 20 °CHumidity : 58%

a) TDMA frame frequency stability (frequency drift)

Channel No.	Frequency Drift (KHz/ slot)					Limit of Δ (KHz/ slot)
	min	mean	max	Δ min	Δ max	
Fm	-5	0	9	-5	9	±19.2

$\Delta \text{ min} = \text{min} - \text{Avg of mean}$

$\Delta \text{ max} = \text{max} - \text{Avg of mean}$

Photo of worst-case of Frequency Drift display follows:

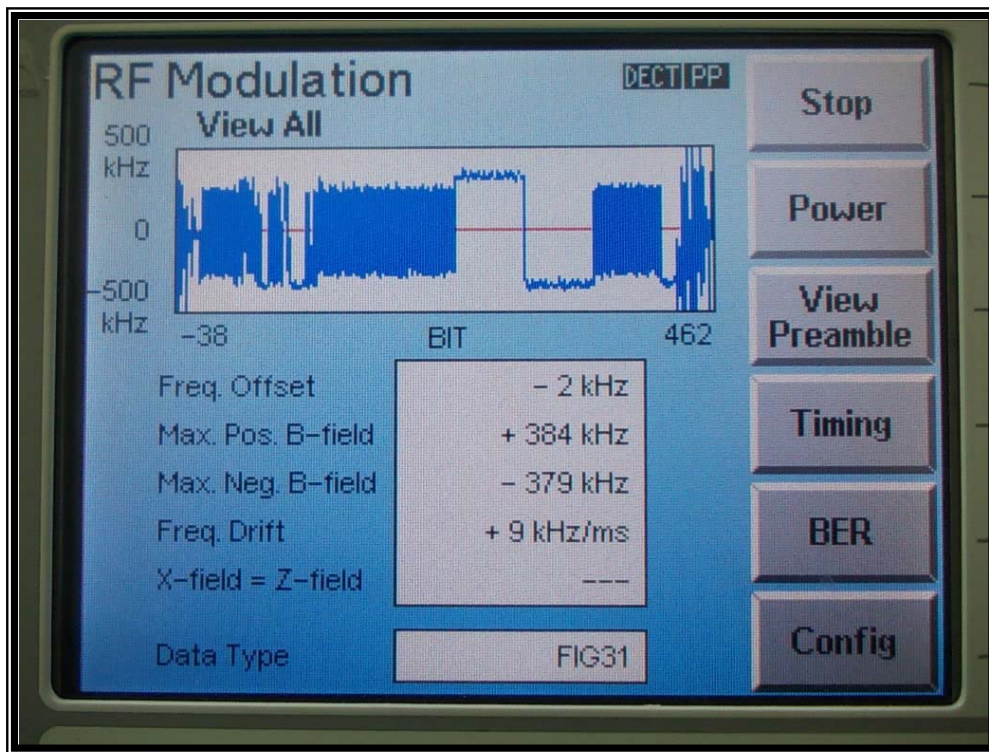

b) Frame jitter

Test Date : Jul. 12, 2017

Temperature : 20 °C

Humidity : 58%

Channel No.	Frame Jitter (uS)					Limit of Δ (uS)
	min	mean	max	Δ min	Δ max	
F _M	-0.10	0	0.12	-0.10	0.12	± 25

Δ min = min - Avg of mean

Δ max = max - Avg of mean

Photo of worst-case of TDMA Frame Jitter display follows:

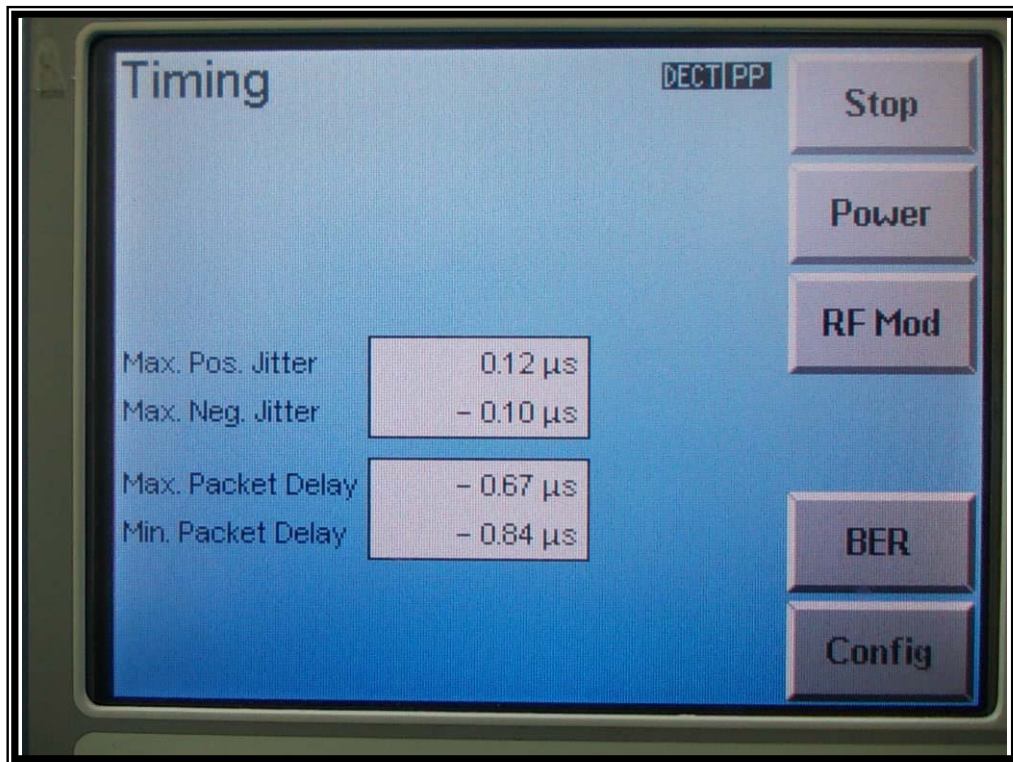

6.28 Carrier frequency stability

6.28.1 Standard Applicable: FCC 15.323(f)

The frequency stability of the carrier frequency of the intentional radiator shall be maintained within ± 10 ppm over 1 hour or the interval between channel access monitoring, whichever is shorter. The frequency stability shall be maintained over a temperature variation of $- 0^{\circ}\text{C}$ to $+50^{\circ}\text{C}$ at normal supply voltage, and over a variation in the primary supply voltage of 85 percent to 115 percent of the rated supply voltage at a temperature of 20°C . For equipment that is capable only of operating from a battery, the frequency stability tests shall be performed using a new battery without any further requirement to vary supply voltage.

RSS-213 6.2 Frequency Stability

The carrier frequency stability shall be maintained within ± 10 ppm ($\pm 0.001\%$).

6.28.2 Measurement Requirement:

- Carrier frequency stability ≤ 10 ppm over 1 hour or interval between channel access monitoring, whichever is shorter (That translates to frequency drift of 19.2 kHz for 1920 MHz carrier)
- Carrier frequency stability over $+10^{\circ}\text{C}$ to $+40^{\circ}\text{C}$ at normal supply voltage, and over 85% to 115% of rated supply voltage (voltage variation not required for battery operated device)

6.28.3 Test Results: Complies

Measurement Data:

Test Date : Jul. 12, 2017

Temperature : 20 °C

Humidity : 58%

a) Carrier Frequency Stability over time

Channel No.	Frequency Offset (kHz)					Limit of Δ (kHz)
	min	mean	max	Δ min	Δ max	
F _M	-2	0	2	-2	2	± 19.2

Δ min = min - Avg of mean

Δ max = max - Avg of mean

Test was conducted for duration longer than 1 hour. Photo of worst-case of Frequency offset display follows:



b) Carrier Frequency Stability over temperature

Channel No.	Frequency Offset (kHz)					Limit of Δ (kHz)
	Mean of low temp. (10°C)	Mean of normal temp. (25°C)	Mean of high temp. (40°C)	Δ low	Δ high	
FM	2	0	-4	2	-4	± 19.2

Δ low = Mean of low temp. - Mean of normal temp.

Δ high = Mean of high temp. - Mean of normal temp.