



**SAR (Specific Absorption Rate) Evaluation Report
for
Industry Canada RSS-102 Issue 4
and
FCC KDB 865664 D01**

Report No.: 13-10-MAS-229-04

Client: **Lightspeed Technologies Inc.**
Product: **Flexmike**
Model: **FM**
FCC ID: **ORV-LSFM**
IC ID: **1732B-LSFM**

Manufacturer/supplier: **REOR ELECTRONICS CO., LTD.**



Date test item received: 2013/10/23
Date test campaign completed: 2013/11/06
Date of issue: 2013/11/06
Test Result: Compliance Not Compliance

Statement of Compliance:

The SAR values measured for the test sample are below the maximum recommended level of 1.6 W/kg averaged over any 1g tissue according to Industry Canada RSS-102 (Issue 4, 2010) and FCC KDB 865664 D01 SAR Measurement 100MHz to 6 GHz v01r01.

The test result only corresponds to the tested sample. It is not permitted to copy this report, in part or in full, without the permission of the test laboratory.

Total number of pages of this test report: 77 pages

Test Engineer	Checked by	Approved by
 Perry Lin	 Perry Lin	 James Cheng

The testing described in this report has been carried out to the best of our knowledge and ability, and our responsibility is limited to the exercise of reasonable care. This certification is not intended to believe the sellers from their legal and/or contractual obligations.

Applicant Information

Client : Lightspeed Technologies Inc.

Address : 11509 SW Herman Rd., Tualatin, OR 97062, U.S.A

Manufacturer : REOR ELECTRONICS CO., LTD.

Address : 5F, No. 122, Caohe Rd., Jhonghe Dist., New Taipei City
235, Taiwan.

EUT : Flexmike

Model No. : FM

Standard Applied : Industry Canada RSS-102 Issue 4 (March, 2010)
FCC KDB 865664 D01 SAR Measurement 100MHz to 6 GHz
v01r01.(May 28, 2013)
IEEE Standard 1528-2003

Test Location : Electronics Testing Center, Taiwan (www.etc.org.tw)

No.8, Lane 29, Wenming RD., LeShan Tsuen, GuiShan
Shiang, Taoyuan County 33383, Taiwan, R.O.C.

The Mobility Enhanced Cordless devices is in compliance with the FCC Report and Order 93-326 and Health Canada Safety Code 6, and the tests were performed according to the FCC KDB 865664 D01 and RSS-102 for uncontrolled exposure.

Table of Contents

EXECUTIVE SUMMARY	5
1 GENERAL INFORMATION	6
1.1 Description of Equipment Under Test	6
1.2 Photograph of EUT	6
1.3 Environment Conditions	7
1.4 Test Standards	7
1.4.1 RF Exposure Limits (According to ECR 1999/519/EC).....	7
1.5 The SAR Measurement Procedure for Mobile	8
1.5.1 General Requirements	8
1.5.2 Phantom Requirements	8
1.5.3 Test Positions	8
1.5.4 Test Procedures	8
2 DESCRIPTION OF THE TEST EQUIPMENT.....	9
2.1 Test Equipment List	9
2.2 DASY4 Measurement System Diagram	10
2.3 DASY4 Measurement Server	12
2.4 DAE (Data Acquisition Electronics).....	13
2.5 Phantom.....	14
2.6 Device Holder	15
2.7 Specifications of Probes	15
2.8 Measurement Procedures in DASY4	16
2.9 Simulating Liquids	16
2.10 Justification for Extended SAR Dipole Calibrations	17
2.11 System Performance Check	18
2.11.1 Purpose.....	18
2.11.2 System Performance Check Setup	18
2.11.3 Result of System Performance Check	18
3 RESULTS	19
3.1 Summary of Test Results	19
3.2 1900MHz.....	19
3.3 Measurement Position	20
3.3.1 EUT Position A	20
3.3.2 EUT Position B	20
3.3.3 EUT Position C	21
3.3.4 EUT Position D.....	21
4 DESCRIPTION OF THE TEST PROCEDURE	22

4.1 Scan Procedure.....	22
4.2 SAR Averaging Methods.....	22
4.3 Data Storage.....	22
4.4 Data Evaluation.....	23
5 MEASUREMENT UNCERTAINTY (300MHz~3GHz)	25
6 REFERENCES	26
7 ANNEX : TEST RESULTS OF DASY4 (REFER TO ANNEX).....	26

Executive Summary

The product FM is a Flexmike operating in the 1920 ~ 1930 MHz frequency range. The measurements was conducted by ETC and carried out with the dosimetric assessment system – DASY4.

The measurements of handset were conducted according to FCC KDB865664 D01 [Reference 5] for evaluating compliance with requirements of FCC Report and Order 96-326 [Reference 3] and also according to Industry Standard RSS-102 Issue 4 [Reference 8] for evaluating compliance with requirements of Health Canada Safety Code 6[Reference 9].

The PP under test was set to TBR6 mode and established a connection with FP emulator. The specific FP emulator can setup a TBR6 connection with handset on different combination of carrier and time-slot in loopback of handset with PSRBS data type.

Another important factor is the Crest Factor when applying SAR testing to DECT. It is usually declared by customer or we would use a spectrum to scan the duty cycle in time domain when transmitting in case laking such information. It was 1:24 for this sample.

1 General Information

1.1 Description of Equipment Under Test

EUT Type	Flexmike
Model Name	FM
Hardware version	N/A
Software version	N/A
Tx Frequency	1921.536 MHz ~ 1928.448 MHz
Rx Frequency	1921.536 MHz ~ 1928.448 MHz
Antenna Type	Internal Type
Device Category	Portable
RF Exposure Environment	General Population / Uncontrolled
Power supply	Adapter: S006MU0500100 Input:100-240VAC , 50/60Hz , 300mA Output: 5V..... 1000mA Battery:2AA × 2
Crest Factor	24

1.2 Photograph of EUT



1.3 Environment Conditions

Item	Target	Measured
Ambient Temperature (°C)	15 ~ 30	24 ± 1
Temperature of Simulant (°C)	20 ~ 24	24 ± 1
Relative Humidity(% RH)	30 ~ 70	60 ~ 70

1.4 Test Standards

According to the FCC order “Guidelines for Evaluating the Environmental Effects of RF Radiation”, for consumer products, the SAR limit is **1.6W/kg** for an uncontrolled environment and **8.0W/kg** for an occupational/controlled environment. The equipment under test should be evaluated at maximum output power (radiated from the antenna) under “worst-case” conditions for intended or normal operation, incorporating normal antenna operating positions, equipment under test peak performance frequencies and positions for maximum RF power coupling.

1.4.1 RF Exposure Limits (According to ECR 1999/519/EC)

	Whole-Body	Partial-Body	Arms and Legs
Population/Uncontrolled Environments (W/kg)	0.08	1.6	4.0
Occupational/Controlled Environments (W/kg)	0.4	8.0	20.0

Notes:

1. Population/Uncontrolled Environments: Locations where there is the exposure of individuals who have no sense or control of their exposure.
2. Occupational/Controlled Environments: Locations where there is exposure that may be incurred by people who have knowledge of the potential for exposure.
3. Whole-Body: SAR is averaged over the entire body.
4. Partial-Body: SAR is averaged over any 1g of tissue volume as defined in specification.
5. Arms and Legs: SAR is averaged over 10g of tissue volume as defined in specification.

1.5 The SAR Measurement Procedure for Mobile

1.5.1 General Requirements

The test should be performance in a laboratory without influence on SAR measurements by ambient RF sources and any reflection from the environment inside. The ambient temperature should be kept in the range of 18°C to 25°C with a maximum variation within $\pm 2^\circ\text{C}$ during the test.

1.5.2 Phantom Requirements

The phantoms used in test are simplified representations of the human head and body as a specific shaped container for the head or body simulating liquids. The physical characteristics of the phantom models should resemble the head and the body of a mobile user since the shape is a dominant parameter for exposure. The shell of the phantom should be made of low loss and low permittivity material and the thickness tolerance should be less than 0.2 mm. In addition, the phantoms should provide simulations of both right and left hand operations.

1.5.3 Test Positions

Due to there are basically six planes in the base unit under test. To exclude the bottom side from normal operating, here totally are four positions to conduct the SAR test. There are front side, right side, left side and rear side respectively.

1.5.4 Test Procedures

The SAR test should be performed with four test positions as mentioned above. To use the center frequency of each available operating band to apply SAR measurements on four test positions via a speech connection set-up with a DECT/FP simulator.

2 Description of the Test Equipment

The measurements were performed using an automated near-field scanning system, DASY4 software, manufactured by Schmid & Partner Engineering AG (SPEAG) in Switzerland. The SAR extrapolation algorithm used in all measurements on the test device was the ‘worst case extrapolation’ algorithm.

2.1 Test Equipment List

Equipment	Manufacturer	Type	S/N	Calibration Expiry
Robot	Staubli	RX90B L	F03/5W16A1/A/01	(not necessary)
Robot Controller	Staubli	CS7MB	F03/5W16A1/C/01	(not necessary)
Teach Pendant	Staubli	-----	D221340061	(not necessary)
DAE4	Schmid & Partner Engineering AG	-----	629	2014-08-20
E-field Probe	Schmid & Partner Engineering AG	EX3DV4	3943	2014-08-01
Dipole Validation Kit	Schmid & Partner Engineering AG	D1900V2	5d054	2014-09-30
DIGITAL RADIO TESTER	Rohde & Schwarz	CTS 60	1094.0006.60 Sr.100584	2014-09-10
Universal Radio Communication Tester	Rohde & Schwarz	CMU200	101006	2014-05-05
Thermo-Hygro.meter	TFA	-----	-----	2014-07-01
Directional Coupler	Amplifier Research	DC7420	310569	2014-09-15
DASY4 Software	Schmid & Partner Engineering AG	-----	Version 4.6B23	To automatically control the robot and perform the SAR measurement
SEMCAD Software	Schmid & Partner Engineering AG	-----	Version 1.8B160	Post-processing and report management
Signal Generator	Agilent	83640B	3844A01143	2014-09-26
Amplifier	Mini-Circuits	ZHL-42W	D111704-01-02	2014-09-22
Power Meter	BOONTON	4532-0102	136601	2014-06-20
Power Sensor	BOONTON	51011-EMC	32861	2014-07-03
S-Parameter Network Analyzer	Agilent	8753ES	MY40001340	2014-02-15
Calibration Kit	Agilent	85033C	2920A03287	(not necessary)
Dielectric Probe Kit	Agilent	85070E	MY44300101	(not necessary)

2.2 DASY4 Measurement System Diagram

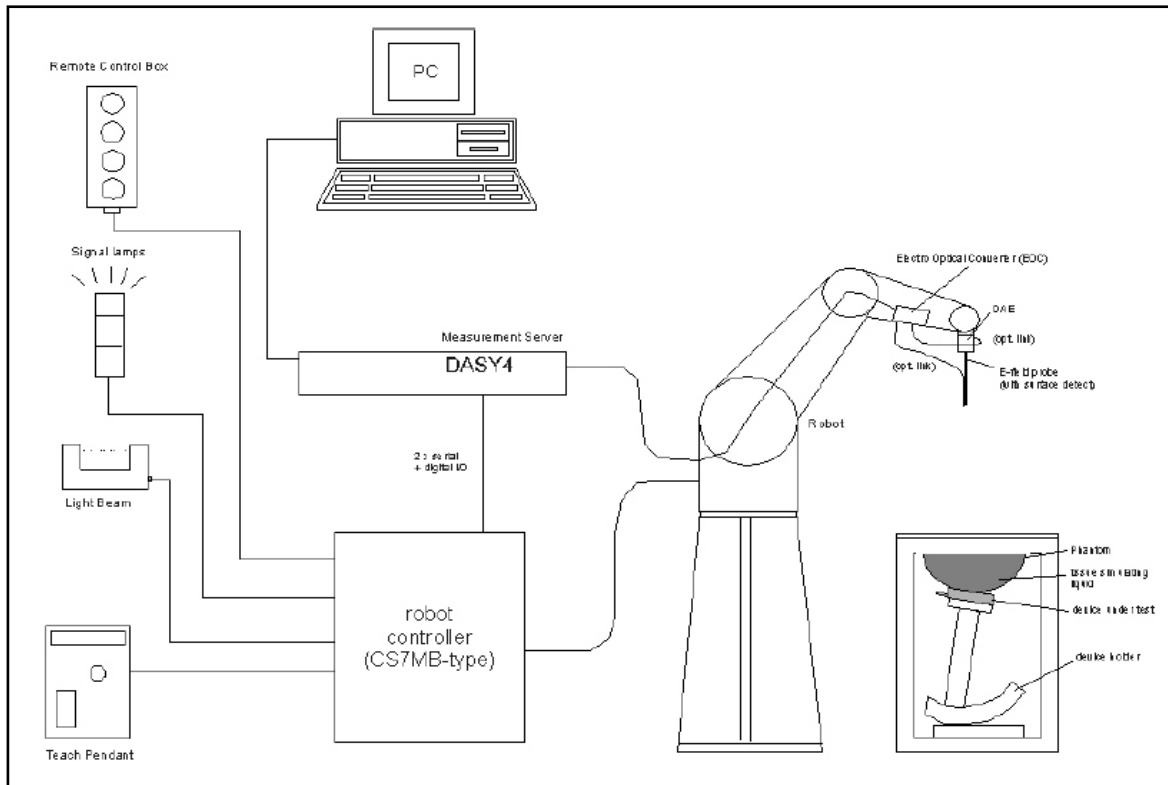

Fig. 4 The DASY4 Measurement System



Fig. 5 The DASY4 System Photo

The DASY4 system consists of the following items:

- A fixed-on-ground high precision 6-axis robot with controller and software and an arm extension for moving the Data Acquisition Electronics (DAE) and Probe.
- A dosimetric probe, an isotropic E-field probe optimized and calibrated for usage in head or body tissue simulating liquids. Some of the probes are equipped with an optical surface detector system.
- A Data Acquisition Electronic (DAE) performing the signal amplification, signal multiplexing, AD-conversion, offset measurements, mechanical surface detection, collision detection, etc. DAE is powered with standard or rechargeable batteries. The signal is optically transmitted to the EOC.
- A unit to operate the optical surface detector which is connected to Electro-Optical Coupler (EOC).
- The EOC performs the conversion from the optical into a digital electric signal of the DAE. The EOC is connected to the DASY4 measurement server.
- The DASY4 measurement server performing all real-time data evaluation for field measurements and surface detection, controlling robot movements and handling safety operation. A computer with operating Windows 2000 is used for server.
- DASY4 software and SEMCAD data evaluation software are installed in PC.
- Remote control with teach panel and additional circuitry for robot safety such as warning lamps, etc.
- The generic twin phantom enabling the testing of left-hand and right-hand usage.
- The device holder for handheld mobile phones.
- Tissue simulating liquid mixed well according to the given recipes.
- System validation dipoles is used to validate the proper functioning of the system

2.3 DASY4 Measurement Server



Fig. 6 DASY4 Measurement Server

The DASY4 measurement server is based on a PC/104 CPU board with a 166MHz low-power pentium, 32MB chipdisk and 64MB RAM. The necessary circuits for communication with either the DAE4 (or DAE3) electronic box as well as the 16-bit AD-converter system for optical detection and digital I/O interface are contained on the DASY4 I/O-board, which is directly connected to the PC/104 bus of the CPU board.

The measurement server performs all real-time data evaluation for field measurements and surface detection, controls robot movements and handles safety operation. The PC-operating system cannot interfere with these time critical processes. All connections are supervised by a watchdog, and disconnection of any of the cables to the measurement server will automatically disarm the robot and disable all program-controlled robot movements. Furthermore, the measurement server is equipped with two expansion slots which are reserved for future applications. Please note that the expansion slots do not have a standardized pinout and therefore only the expansion cards provided by SPEAG can be inserted. Expansion cards from any other supplier could seriously damage the measurement server.

2.4 DAE (Data Acquisition Electronics)



Fig. 7 DAE Photo

Some probes are equipped with an optical multifiber line, ending at the front of the probe tip. This line is connected to the EOC box on the robot arm and provides automatic detection of the phantom surface. Half of the fibers are connected to a pulsed infrared transmitter, the other half to a synchronized receiver. If the probe approaches the surface, the reflection from the surface produces a coupling from the transmitting to the receiving fibers. This reflection increases during the approach, reaches a maximum and then decreases. If the probe perpendicularly touches the surface, the coupling is zero. The distance of the coupling maximum to the surface is independent of the surface reflectivity and largely independent of the surface to probe angle. The DASY4 software reads the reflection during a software approach and looks for the maximum using a 2nd order fitting. The approach is stopped upon reaching the maximum.

The optical surface detection works in transparent liquids and on diffuse reflecting surfaces with a repeatability of better than ± 0.1 mm. The distance of the maximum depends on the fiber and the surrounding media. It is typically 1.0mm to 2.0mm in tissue simulating mixtures. The distance can be measured with the surface check job (described in the reference guide).

2.5 Phantom

SAM Twin Phantom V4.0:

The phantom used for all tests i.e. for both system performance checking and device testing, was the twinheaded "SAM Twin Phantom V4.0", manufactured by SPEAG. The phantom conforms to the requirements of IEEE 1528 - 2003.

SAM Phantom ELI4:

Phantom for compliance testing of handheld and body mounted wireless devices in the frequency range of 30 MHz to 6 GHz. ELI4 is fully compatible with the latest draft of the standard IEC 62209-2. ELI4 has been optimized regarding its performance and can be integrated into our standard phantom tables. A cover prevents evaporation of the liquid.



Fig. 8 SAM Twin Phantom and ELI4 Phantom

2.6 Device Holder

The device was placed in the device holder (illustrated below) that is supplied by SPEAG as an integrated part of the Dasy system.



Fig. 9 Device holder supplied by SPEAG

2.7 Specifications of Probes

The E-Field Probes EX3DV4, manufactured and calibrated annually by Schmid & Partner Engineering AG with following specification are used for the dosimetric measurements.

EX3DV4:

- Dynamic range: $10 \mu\text{W/g} \sim 100 \text{mW/g}$
- Tip diameter: 2.5 mm
- Probe linearity: $\pm 0.2 \text{ dB}$ (30MHz to 3 GHz)
- Axial isotropy: $\pm 0.2 \text{ dB}$
- Spherical isotropy: $\pm 0.4 \text{ dB}$
- Distance from probe tip to dipole centers: 1.0 mm
- Calibration range: 900MHz/1750MHz/1900MHz/2000MHz/2450MHz for head simulating liquid and 5200MHz/5800MHz for head and body simulating liquids.

2.8 Measurement Procedures in DAS4

Step 1

Establish a call in EUT at the maximum power level with a base station simulator via air interface.

Step 2

To measure the local E-field value at a fixed location which value will be taken as a reference value for calculating a possible power drift.

Step 3

To measure the SAR distribution with a grid with spacing of 15 mm x 15 mm and kept with a constant distance to the inner surface of the phantom. Additional all peaks within 3 dB of the maximum SAR are searched.

Step 4

At these points (maximum number of SAR peaks is two), a cube of 32 mm x 32 mm x 30 mm is applied to and measured with 5 x 5 x 7 points. With these measured data, a peak spatial-average SAR value can be calculated by SEMCAD software.

Step 5

Repetition of the E-field measurement at the fixed location mentioned in Step 1 to make sure the two results differ by less than ± 0.2 dB.

2.9 Simulating Liquids

Liquid Recipe for this test report is as following:

1900MHz band

Ingredient	% by weight
Water	40.4
Diethylene Glycol Butyl Ether(DGBE)	0
Salt	0.5
Sugar	59.1

2.10 Justification for Extended SAR Dipole Calibrations

Usage of SAR dipoles calibrated less than 2 years ago but more than 1 year ago were confirmed in maintaining return loss (<-20dB, within 20% of prior calibration) and impedance (within 5 ohm from prior calibration) requirements per extended calibrations in KDB 450824:

Extended Dipole Calibration Data

D1900V2 SN:5d054 (Heard)				
Date of Measurement	Return Loss	$\Delta\%$	Impedance	$\Delta\Omega$
2012/10/01	-25.3dB	---	53.9 Ω	---
2013/10/01	-26.3dB	-5	55.1 Ω	+1.2
D1900V2 SN:5d054 (Body)				
Date of Measurement	Return Loss	$\Delta\%$	Impedance	$\Delta\Omega$
2012/10/01	-25.8dB	---	49.7 Ω	---
2013/10/01	-27.4dB	-6	51.3 Ω	+1.6

2.11 System Performance Check

2.11.1 Purpose

1. To verify the simulating liquids are valid for testing.
2. To verify the performance of testing system is valid for testing.

2.11.2 System Performance Check Setup

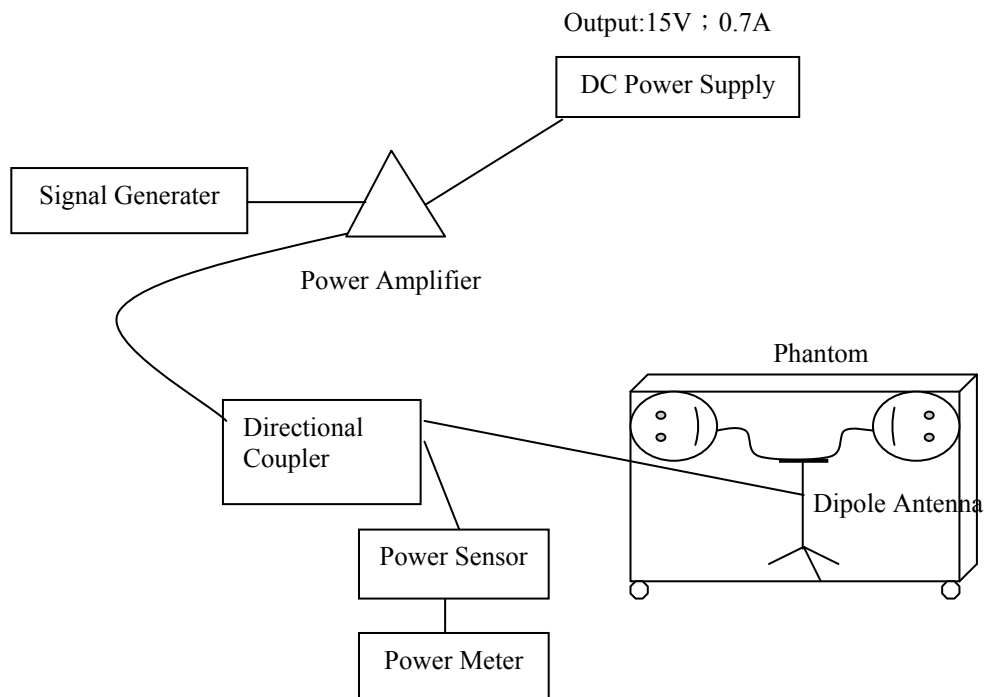

Note :

1. Power Meter is used to make sure whether the input power is 250mW for reference signal.
2. Power Amplifier is used to input the measured power to dipole antenna.

2.11.3 Result of System Performance Check

Diepole Antenna: D1900V2 (S/N: 5d054)

Date of Measurement And Reference Value	SAR@1g [W/kg]	Dielectric Parameters		Temperature [°C]
		ϵ_r	σ [S/m]	
Body1900MHz Recommended Value	10 ±10% [9.00~ 11.00]	53.3 ± 5% [50.635~55.965]	1.52 ± 5% [1.444~1.596]	22.0 ± 2 [20 ~ 24]
2013-11-05	10.9	53.9	1.58	22.3

3 Results

3.1 Summary of Test Results

No deviations from the technical specification(s) were ascertained in the course of the tests performed.	<input checked="" type="checkbox"/>
The deviations as specified in this chapter were ascertained in the course of the tests performed.	<input type="checkbox"/>

3.2 1900MHz

Frequency		Measurement Position (Flat)	Conducted Power (dBm)			SAR@1g [W/kg]	Power Drift (dB)	Note
CH	MHz		Before	After	Drift			
2	1924.992	A-Mid	14.82	14.81	-0.1	0.122	0.122	Worst
2	1924.992	B-Mid	14.80	14.79	-0.1	0.00149	0.106	
2	1924.992	C-Mid	14.81	14.79	-0.2	0.0423	0.106	
2	1924.992	D-Mid	14.80	14.79	-0.1	0.00636	0.137	
0	1928.448	A-High	14.90	14.88	-0.2	0.137	0.189	
4	1921.536	A-Low	14.77	14.76	-0.1	0.137	0.172	Largest

The Max Body SAR@1900MHz@1g was 0.137 W/kg, less than limitation of 1.6 W/kg.

3.3 Measurement Position

3.3.1 EUT Position A



At Position A, the EUT front side to the SAM Twin phantom distance is 0 mm.

3.3.2 EUT Position B

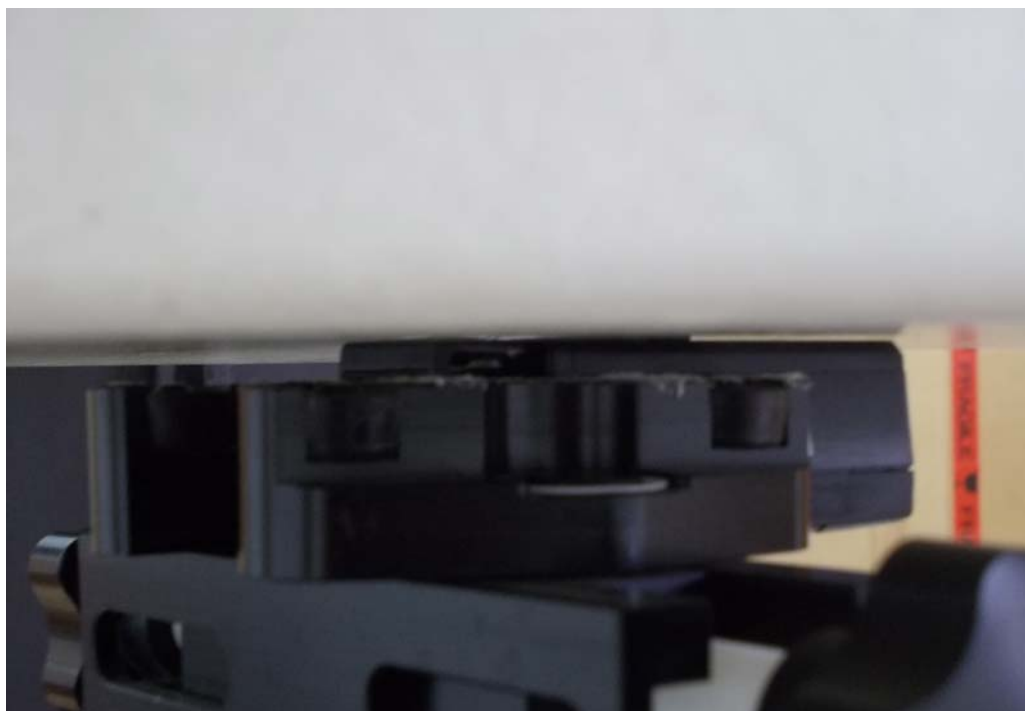

At Position B, the EUT rear side to the SAM Twin phantom distance is 0 mm.

3.3.3 EUT Position C

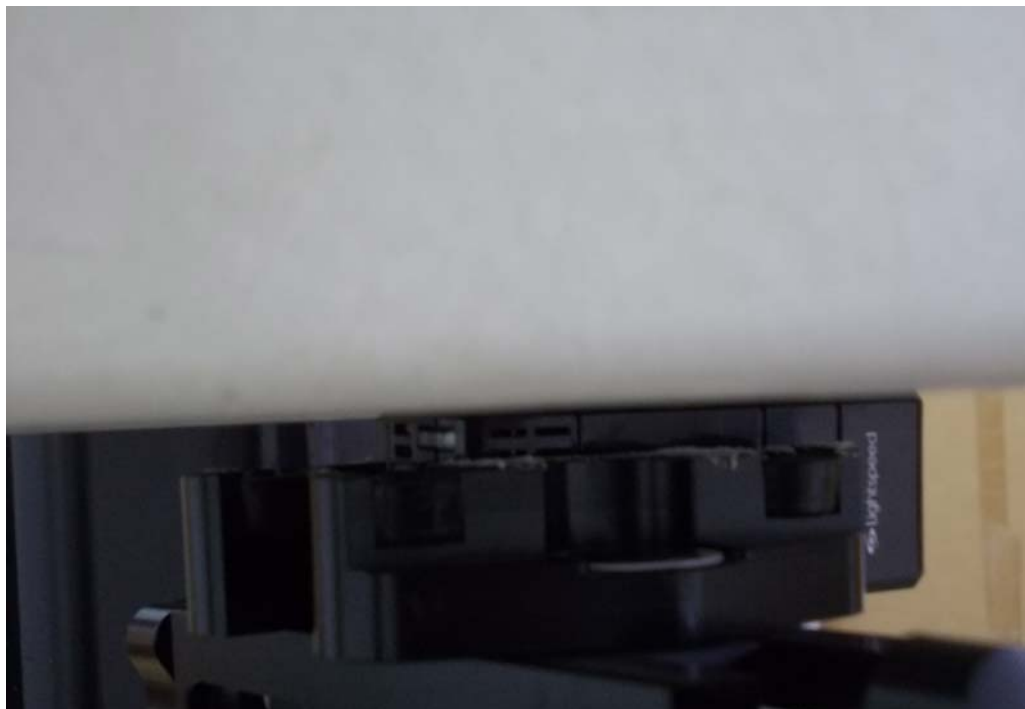

At Position C, the EUT right side to the SAM Twin phantom distance is 0 mm.

3.3.4 EUT Position D



At Position D, the EUT left side to the SAM Twin phantom distance is 0 mm.

4 Description of the Test Procedure

4.1 Scan Procedure

First coarse scans were used for determination of the field distribution. Next a cube scan, 5x5x7 points covering a volume of 32x32x30mm was performed around the highest E-field value to determine the averaged SAR value. Drift was determined by measuring the same point at the start of the coarse scan and again at the end of the cube scan.

4.2 SAR Averaging Methods

The maximum SAR value was averaged over a cube of tissue using interpolation and extrapolation. The interpolation, extrapolation and maximum search routines within Dasy4 are all based on the modified Quadratic Shepard's method (Robert J. Renka, "Multivariate Interpolation Of Large Sets Of Scattered Data", University of North Texas ACM Transactions on Mathematical Software, vol. 14, no. 2, June 1988, pp. 139-148).

The interpolation scheme combines a least-square fitted function method with a weighted average method. A trivariate 3-D / bivariate 2-D quadratic function is computed for each measurement point and fitted to neighboring points by a least-square method. For the cube scan, inverse distance weighting is incorporated to fit distant points more accurately. The interpolating function is finally calculated as a weighted average of the quadratics.

In the cube scan, the interpolation function is used to extrapolate the Peak SAR from the deepest measurement points to the inner surface of the phantom.

4.3 Data Storage

The DASY4 software stores the assessed data from the data acquisition electronics as raw data (in microvolt readings from the probe sensors), together with all the necessary software parameters for the data evaluation (probe calibration data, liquid parameters and device frequency and modulation data) in measurement files with the extension .DA4. The postprocessing software evaluates the desired unit and format for output each time the data is visualized or exported. This allows verification of the complete software setup even after the measurement and allows correction of erroneous parameter settings.

The measured data can be visualized or exported in different units or formats, depending on the selected probe type (e.g., [V/m], [A/m] or [W/kg]). Some of these units are not available in certain situations or give meaningless results, e.g., a SAR-output in a lossless media will always be zero. Raw data can also be exported to perform the evaluation with other software packages.

4.4 Data Evaluation

The DASY4 postprocessing software (SEMCAD) automatically executes the following procedures to calculate the field units from the microvolt readings at the probe connector. The parameters used in the evaluation are stored in the configuration modules of the software:

Probe parameters:	- Sensitivity	$Norm_i, a_{i0}, a_{i1}, a_{i2}$
	- Conversion factor	$ConvF_i$
	- Diode compression point	dcp_i
Device parameters:	- Frequency	f
	- Crest factor	cf
Media parameters:	- Conductivity	σ
	- Density	ρ

These parameters must be set correctly in the software. They can be found in the component documents or they can be imported into the software from the configuration files issued for the DASY components. In the direct measuring mode of the multimeter option, the parameters of the actual system setup are used. In the scan visualization and export modes, the parameters stored in the corresponding document files are used.

The first step of the evaluation is a linearization of the filtered input signal to account for the compression characteristics of the detector diode. The compensation depends on the input signal, the diode type and the DC-transmission factor from the diode to the evaluation electronics. If the exciting field is pulsed, the crest factor of the signal must be known to correctly compensate for peak power. The formula for each channel can be given as:

$$V_i = U_i + U_i^2 \cdot \frac{cf}{dcp_i} \quad (20.1)$$

with V_i	= compensated signal of channel i	(i = x, y, z)
U_i	= input signal of channel i	(i = x, y, z)
cf	= crest factor of exciting field	(DASY parameter)
dcp_i	= diode compression point	(DASY parameter)

From the compensated input signals the primary field data for each channel can be evaluated:

$$\begin{aligned} \text{E - fieldprobes :} \quad E_i &= \sqrt{\frac{V_i}{Norm_i \cdot ConvF}} \\ \text{H - fieldprobes :} \quad H_i &= \sqrt{V_i} \cdot \frac{a_{i0} + a_{i1}f + a_{i2}f^2}{f} \end{aligned}$$

with V_i	= compensated signal of channel i	(i = x, y, z)
$Norm_i$	= sensor sensitivity of channel i	(i = x, y, z)
	$\mu\text{V}/(\text{V}/\text{m})^2$ for E-field Probes	
$ConvF$	= sensitivity enhancement in solution	
a_{ij}	= sensor sensitivity factors for H-field probes	
f	= carrier frequency [GHz]	
E_i	= electric field strength of channel i in V/m	
H_i	= magnetic field strength of channel i in A/m	

The RSS value of the field components gives the total field strength (Hermitian magnitude):

$$E_{tot} = \sqrt{E_x^2 + E_y^2 + E_z^2}$$

The primary field data are used to calculate the derived field units.

$$SAR = E_{tot}^2 \cdot \frac{\sigma}{\rho \cdot 1'000}$$

with SAR	= local specific absorption rate in mW/g
E_{tot}	= total field strength in V/m
σ	= conductivity in [mho/m] or [Siemens/m]
ρ	= equivalent tissue density in g/cm ³

Note that the density is set to 1, to account for actual head tissue density rather than the density of the tissue simulating liquid.

5 Measurement Uncertainty (300MHz~3GHz)

Error Description	Unc. value ±%	Prob. Dist.	Div.	C_i (1g)	C_i (10g)	Std. Unc. ±% (1g)	Std. Unc. ±% (10g)	$\nu_i (v_{eff})$
Measurement System								
Probe Calibration	±6.6	N	1	1	1	±6.6	±6.6	∞
Axial Isotropy	±0.3	R	$\sqrt{3}$	0.7	0.7	±0.1	±0.1	∞
Hemispherical Isotropy	±1.3	R	$\sqrt{3}$	0.7	0.7	±0.5	±0.5	∞
Boundary Effects	±0.5	R	$\sqrt{3}$	1	1	±0.3	±0.3	∞
Linearity	±0.3	R	$\sqrt{3}$	1	1	±0.2	±0.2	∞
System Detection Limits	±1.0	R	$\sqrt{3}$	1	1	±0.6	±0.6	∞
Readout Electronics	±0.3	N	1	1	1	±0.3	±0.3	∞
Response Time	±0.8	R	$\sqrt{3}$	1	1	±0.5	±0.5	∞
Integration Time	±2.6	R	$\sqrt{3}$	1	1	±1.5	±1.5	∞
RF Ambient Conditions	±3.0	R	$\sqrt{3}$	1	1	±1.7	±1.7	∞
Probe Positioner	±0.4	R	$\sqrt{3}$	1	1	±0.2	±0.2	∞
Probe Positioning	±2.9	R	$\sqrt{3}$	1	1	±1.7	±1.7	∞
Max. SAR Evaluation	±1.0	R	$\sqrt{3}$	1	1	±0.6	±0.6	∞
Test Sample Related								
Test Sample Positioning	±2.9	N	1	1	1	±2.9	±2.9	145
Device Holder Uncertainty	±3.6	N	1	1	1	±3.6	±3.6	5
SAR Drift Measurement	±5.0	R	$\sqrt{3}$	1	1	±2.9	±2.9	∞
Phantom and Setup								
Phantom Uncertainty	±4.0	R	$\sqrt{3}$	1	1	±2.3	±2.3	∞
Liquid Conductivity(target)	±5.0	R	$\sqrt{3}$	0.64	0.43	±1.8	±1.2	∞
Liquid Conductivity(meas.)	±2.5	N	1	0.64	0.43	±1.6	±1.1	∞
Liquid Permittivity(target)	±5.0	R	$\sqrt{3}$	0.6	0.49	±1.7	±1.4	∞
Liquid Permittivity(meas.)	±2.5	N	1	0.6	0.49	±1.5	±1.2	∞
Combined Std. Uncertainty						±10.0	±9.7	330
Expanded STD Uncertainty (k=2)						±19.9	±19.4	

6 References

1. [IEEE Std C95.1-2005]

Safety Levels with Respect to Human Exposure to Radio Frequency Electromagnetic Fields, 3 kHz to 300 GHz. The Institute of Electrical and Electronics Engineers, Inc. (IEEE), 2005.

2. [IEEE Std C95.3-1992]

Recommended Practice for the Measurement of Potentially Hazardous Electromagnetic Fields - RF and Microwave". The Institute of Electrical and Electronics Engineers, Inc. (IEEE), 1992.

3. [FCC Report and Order 96-326]

Federal Communications Commission, "Report and order: Guidelines for evaluating the environmental effects of radiofrequency radiation", Tech. Rep. FCC 96-326, 1996.

4. [FCC OET Bulletin 65]

Evaluating Compliance with FCC Guidelines for Human Exposure to Radiofrequency Electromagnetic Fields. OET Bulletin 65 Edition 97-01, August 1997. Federal Communications Commission (FCC), Office of Engineering & Technology. (OET)

5. [FCC KDB 865664 D01 SAR Measurement 100 MHz to 6 GHz v01r01]

Additional Information for Evaluating Compliance of Mobile and Portable Device with FCC Limits for Human Exposure to Radiofrequency Emissions. KDB 865664 D01 SAR Measurement. Federal Communications Commission (FCC), Office of Engineering & Technology. (OET)

6. [DASY 4]

Schmid & Partner Engineering AG: DASY 4 Manual, September 2005.

7. [IEEE 1528-2003]

IEEE Std 1528-2003: IEEE Recommended Practice for Determining the Peak Spatial-Average Specific Absorption Rate (SAR) in the Human Head from Wireless Communications Devices: Measurement Techniques. 1528-2003, 19th December, 2003, The Institute of Electrical and Electronics Engineers, Inc. (IEEE).

8. [RSS-102, Issue 2]

Radio Standards Specification 102, Radio Frequency Exposure Compliance of Radiocommunication Apparatus (All Frequency Bands) sets out the requirements and measurement techniques used to evaluate radio frequency (RF) exposure compliance of radiocommunication apparatus designed to be used within the vicinity of the human body. November, 2005. Industry Canada.

9. [Health Canada Safety Code 6]

Canada's Safety Code 6: Limits of Human Exposure to Radiofrequency Electromagnetic Fields in the Frequency Range from 3 kHz to 300 GHz (99-EHD-237)

7 Annex : Test Results of DASY4 (Refer to ANNEX)

ANNEX

Index of Annex

ANNEX A: CONSTRUCTION PHOTOS OF EUT.....	28
ANNEX B: SAR RESULTS.....	33
ANNEX C: DIPOLE CERTIFICATE.....	45
ANNEX D: PROBE CERTIFICATE.....	53

ANNEX A: CONSTRUCTION PHOTOS OF EUT

1. Outside view 1 of EUT



2. Outside view 2 of EUT



3. Inside view 1 of EUT



4. Inside view 2 of EUT

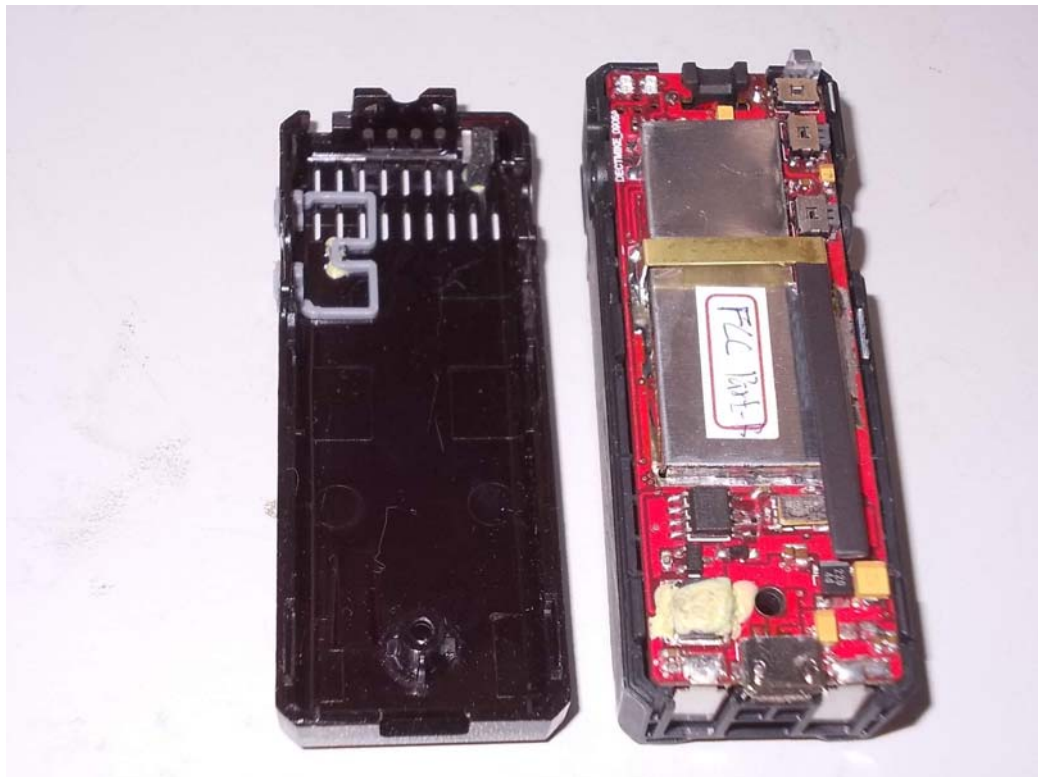

5. Inside view 3 of EUT



6. Antenna 1

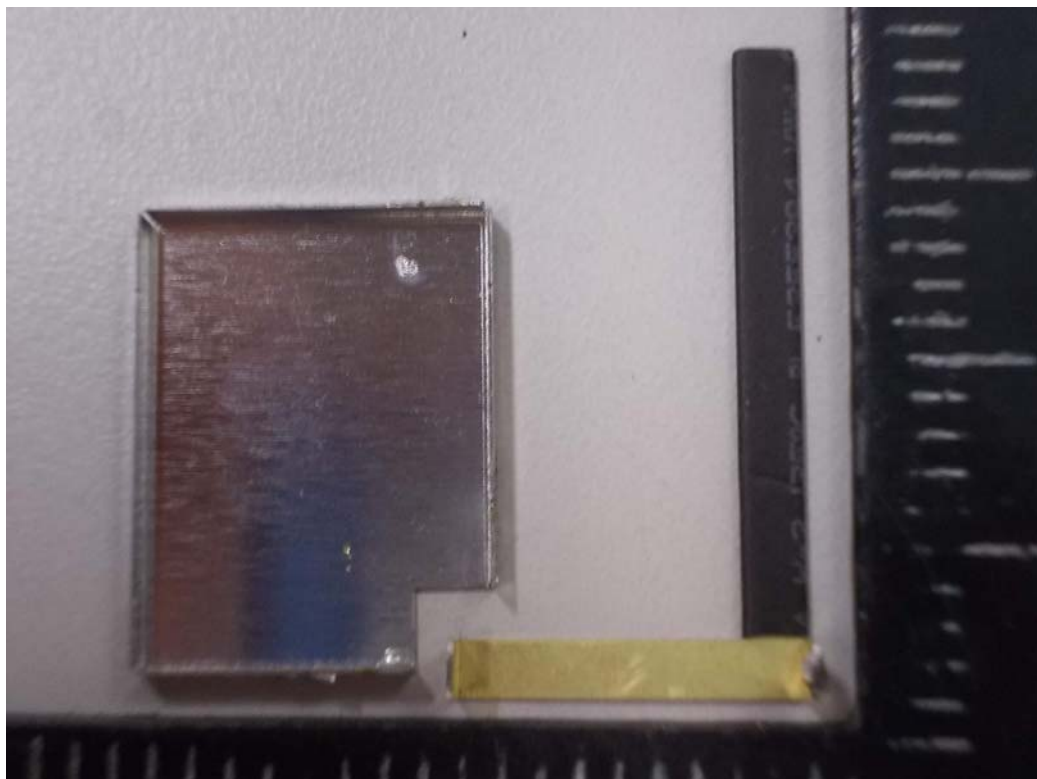

7. Antenna 2

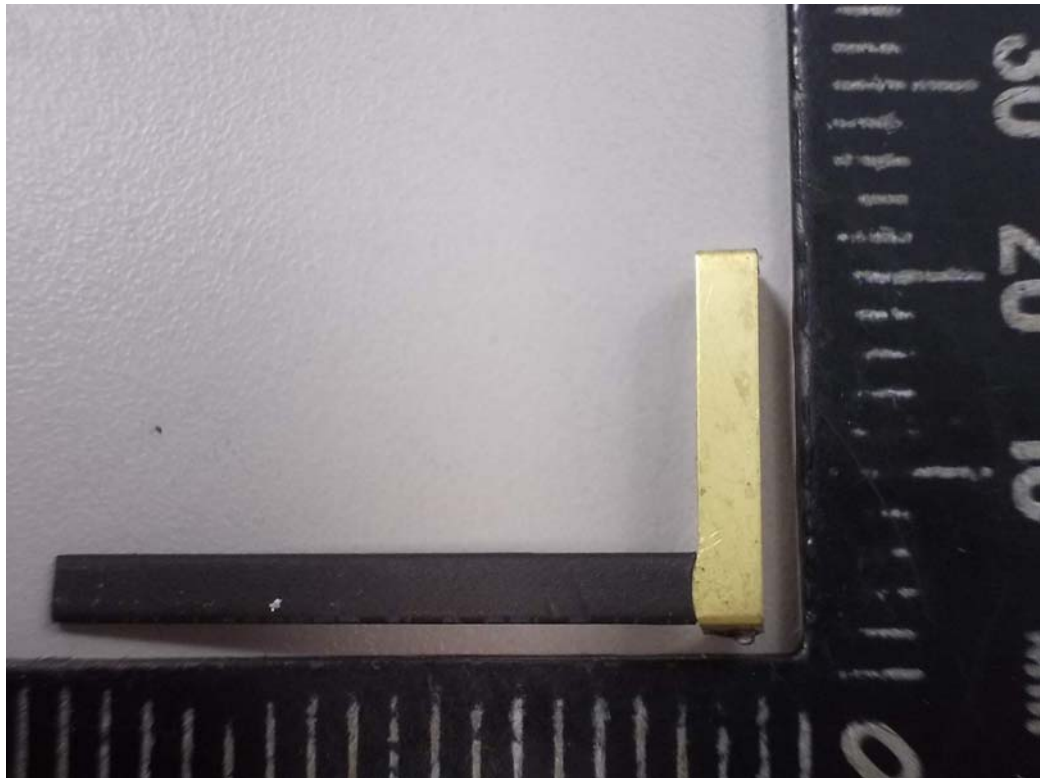

8. Front view of PCB

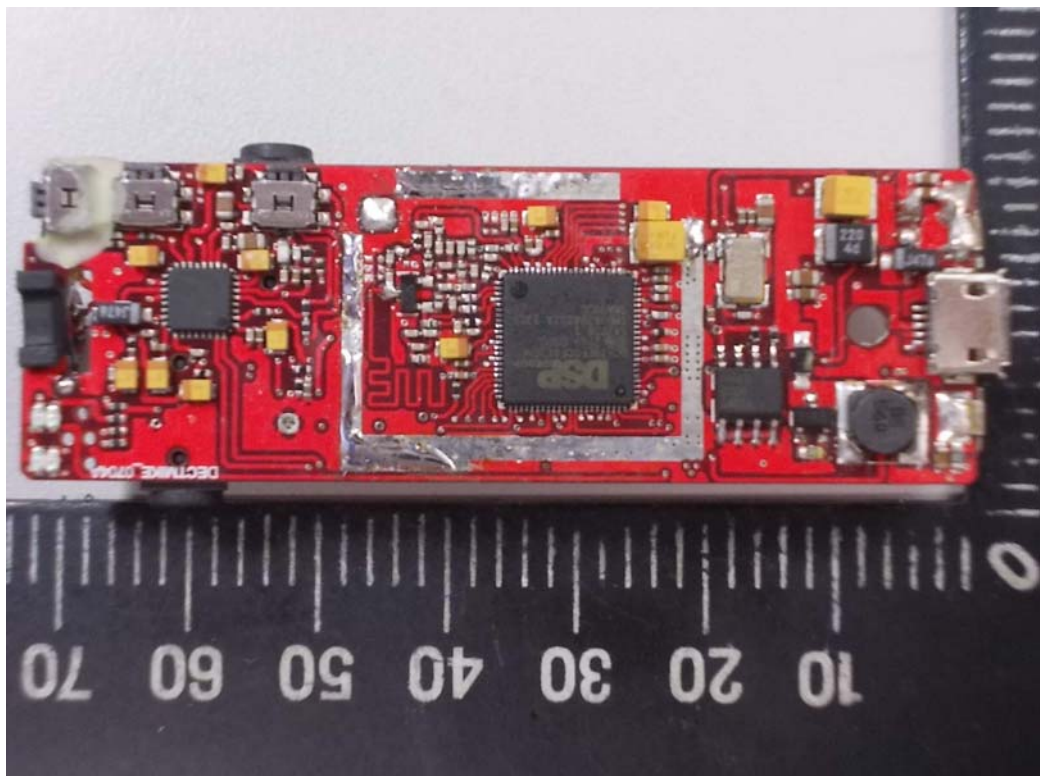

9. Rear view of PCB

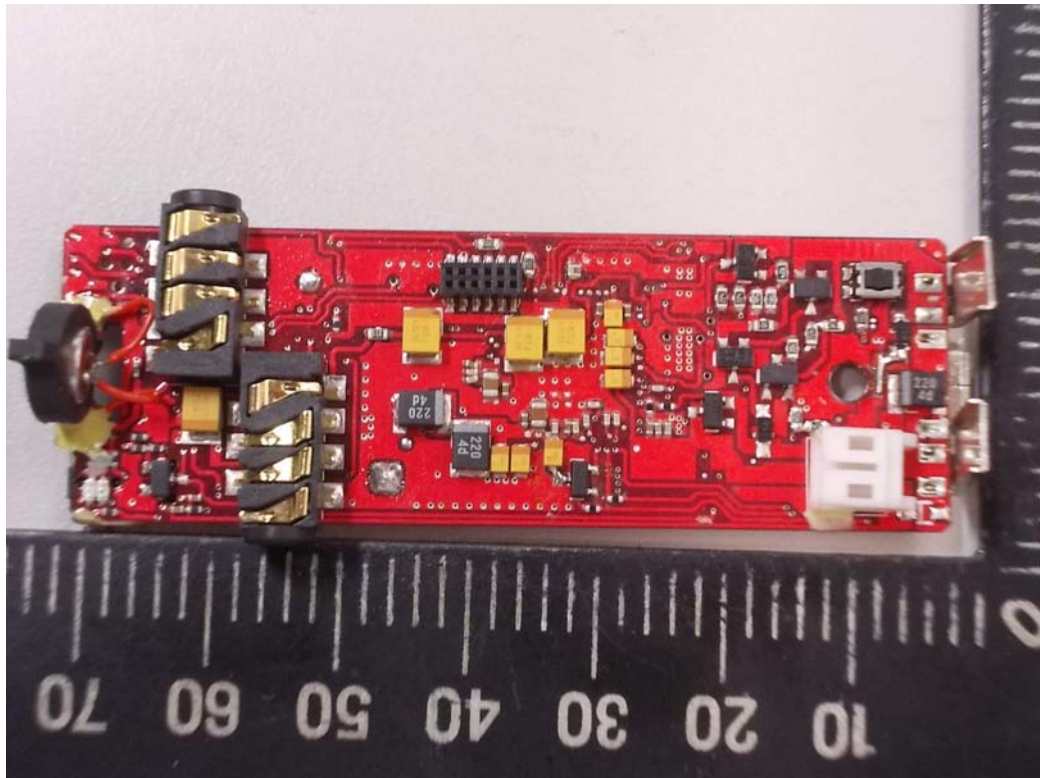

ANNEX B: SAR RESULTS

System Performance Check Body

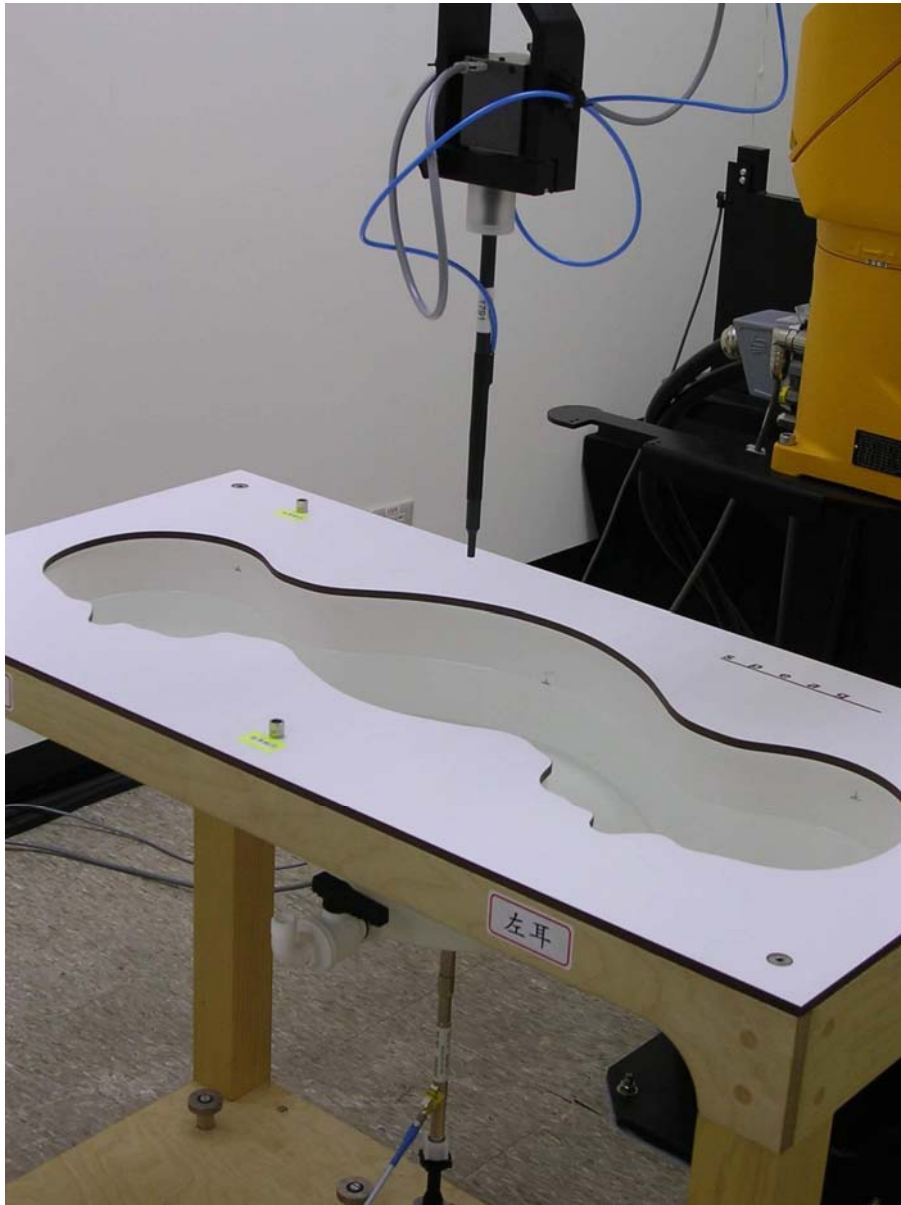

Date/Time: 2013/11/5 AM 10:13:01

Test Laboratory: Electronics Testing Center, Taiwan
File Name: [SPC.da4](#)

DUT: Dipole 1900 MHz; Type: D1900V2; Serial: D1900V2 - SN:xxx
Program Name: Unnamed Program

Communication System: CW; Frequency: 1900 MHz; Duty Cycle: 1:1
Medium parameters used (interpolated): $f = 1900$ MHz; $\sigma = 1.58$ mho/m; $\epsilon_r = 53.9$; $\rho = 1000$ kg/m³
Phantom section: Flat Section

DASY4 Configuration:
- Probe: EX3DV4 - SN3943; ConvF(7.95, 7.95, 7.95); Calibrated: 2013/8/29
- Sensor-Surface: 4mm (Mechanical Surface Detection)
- Electronics: DAE4 Sn629; Calibrated: 2013/8/21
- Phantom: SAM 12; Type: SAM V4.0; Serial: TP:1281
- Measurement SW: DASY4, V4.7 Build 80; Postprocessing SW: SEMCAD, V1.8 Build 186

SPC/Area Scan (31x71x1): Measurement grid: dx=15mm, dy=15mm

Maximum value of SAR (interpolated) = 14.1 mW/g

SPC/Zoom Scan (7x7x7)/Cube 0: Measurement grid: dx=5mm, dy=5mm, dz=5mm
Reference Value = 83.3 V/m; Power Drift = 0.149 dB
Peak SAR (extrapolated) = 20.3 W/kg
SAR(1 g) = 10.9 mW/g; SAR(10 g) = 5.56 mW/g

Maximum value of SAR (measured) = 12.3 mW/g

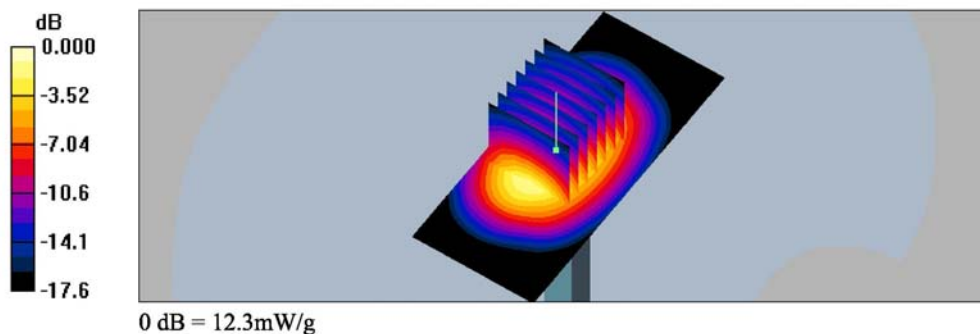

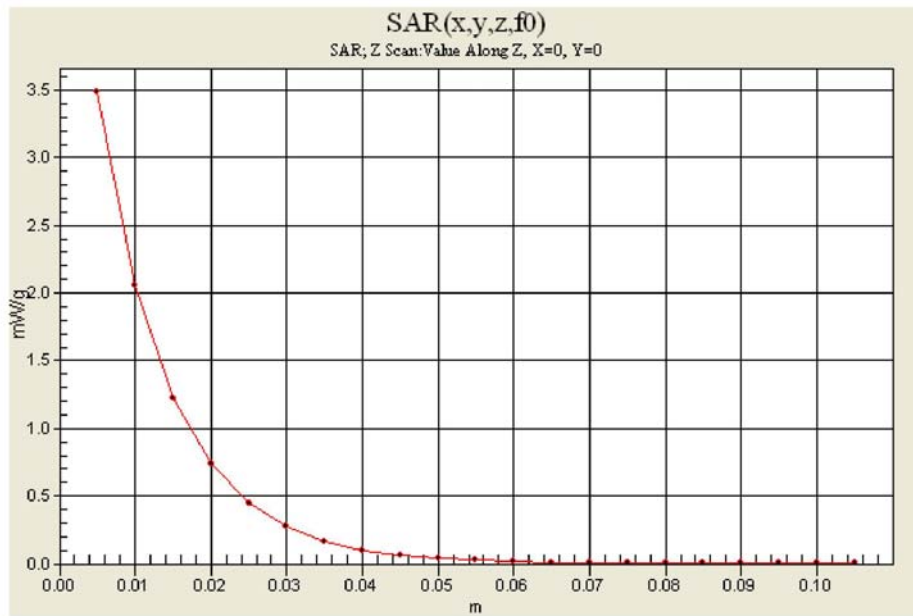

Body

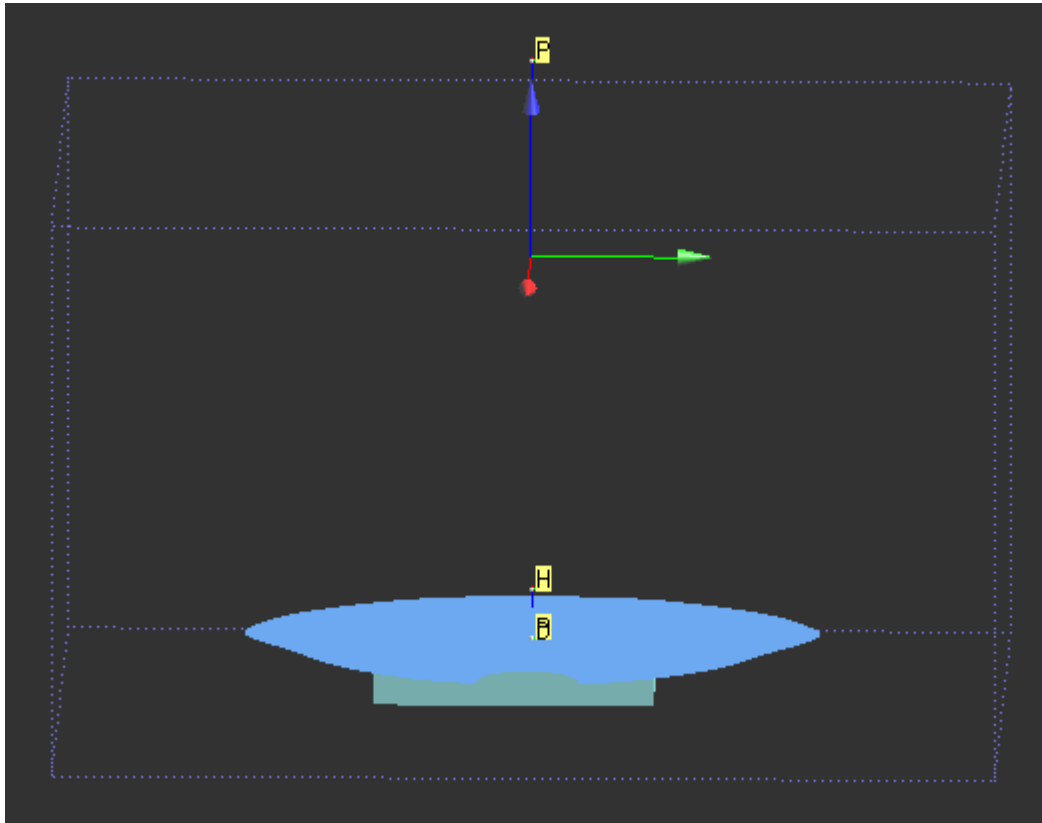

Date/Time: 2013/11/5 AM 10:43:06

Test Laboratory: Electronics Testing Center, Taiwan
File Name: [PP-Side A&B.da4](#)

DUT: n/a; Type: PP; Serial: n/a
Program Name: Unnamed Program

Communication System: US DECT-1900; Frequency: 1925 MHz; Duty Cycle: 1:24
Medium parameters used: $f = 1925$ MHz; $\sigma = 1.6$ mho/m; $\epsilon_r = 53.9$; $\rho = 1000$ kg/m³
Phantom section: Flat Section

DASY4 Configuration:

- Probe: EX3DV4 - SN3943; ConvF(7.95, 7.95, 7.95); Calibrated: 2013/8/29
- Sensor-Surface: 4mm (Mechanical Surface Detection)
- Electronics: DAE4 Sn629; Calibrated: 2013/8/21
- Phantom: SAM 12; Type: SAM V4.0; Serial: TP:1281
- Measurement SW: DASY4, V4.7 Build 80; Postprocessing SW: SEMCAD, V1.8 Build 186

Side A-MID/Area Scan (41x81x1): Measurement grid: dx=15mm, dy=15mm
Maximum value of SAR (interpolated) = 0.130 mW/g

Side A-MID/Zoom Scan (5x5x7)/Cube 0: Measurement grid: dx=8mm, dy=8mm, dz=5mm
Reference Value = 8.61 V/m; Power Drift = 0.122 dB
Peak SAR (extrapolated) = 0.298 W/kg
SAR(1 g) = 0.122 mW/g; SAR(10 g) = 0.051 mW/g
Maximum value of SAR (measured) = 0.145 mW/g

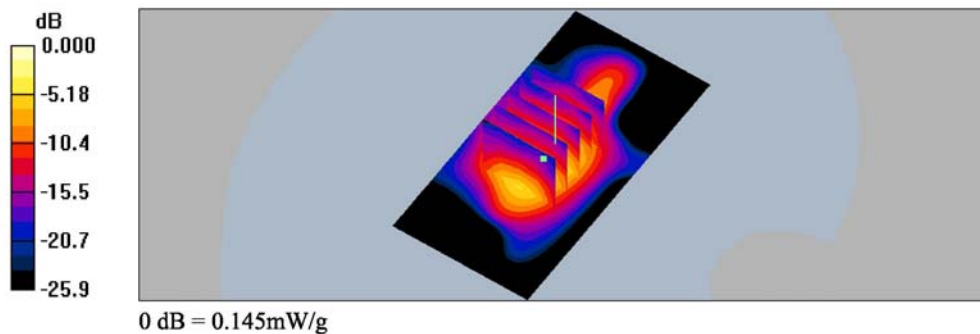

Date/Time: 2013/11/5 AM 11:01:34

Test Laboratory: Electronics Testing Center, Taiwan
File Name: [PP-Side A&B.da4](#)

DUT: n/a; Type: PP; Serial: n/a
Program Name: Unnamed Program

Communication System: US DECT-1900; Frequency: 1925 MHz; Duty Cycle: 1:24
Medium parameters used: $f = 1925$ MHz; $\sigma = 1.6$ mho/m; $\epsilon_r = 53.9$; $\rho = 1000$ kg/m³
Phantom section: Flat Section

DASY4 Configuration:
- Probe: EX3DV4 - SN3943; ConvF(7.95, 7.95, 7.95); Calibrated: 2013/8/29
- Sensor-Surface: 4mm (Mechanical Surface Detection)
- Electronics: DAE4 Sn629; Calibrated: 2013/8/21
- Phantom: SAM 12; Type: SAM V4.0; Serial: TP:1281
- Measurement SW: DASY4, V4.7 Build 80; Postprocessing SW: SEMCAD, V1.8 Build 186

Side B-MID/Zoom Scan (5x5x7)/Cube 0: Measurement grid: dx=8mm, dy=8mm, dz=5mm
Reference Value = 1.03 V/m; Power Drift = 0.106 dB
Peak SAR (extrapolated) = 0.004 W/kg
SAR(1 g) = 0.00149 mW/g; SAR(10 g) = 0.000744 mW/g

Maximum value of SAR (measured) = 0.002 mW/g

Side B-MID/Area Scan (41x81x1): Measurement grid: dx=15mm, dy=15mm
Maximum value of SAR (interpolated) = 0.003 mW/g

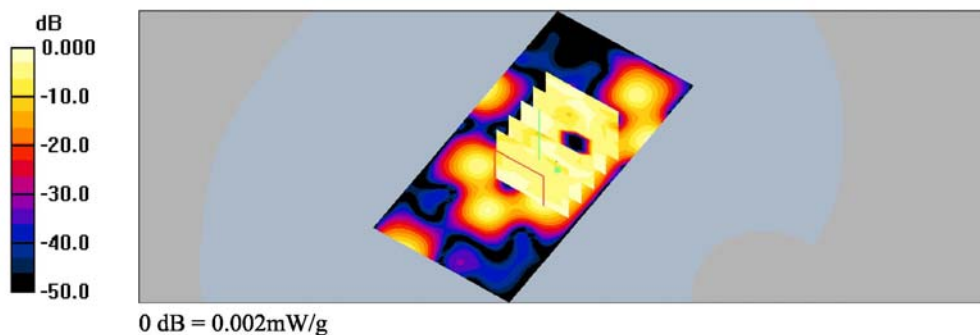

Date/Time: 2013/11/5 AM 11:10:37

Test Laboratory: Electronics Testing Center, Taiwan
File Name: [PP-Side C&D.da4](#)

DUT: n/a; Type: PP; Serial: n/a
Program Name: Unnamed Program

Communication System: US DECT-1900; Frequency: 1925 MHz; Duty Cycle: 1:24
Medium parameters used: $f = 1925$ MHz; $\sigma = 1.6$ mho/m; $\epsilon_r = 53.9$; $\rho = 1000$ kg/m³
Phantom section: Flat Section

DASY4 Configuration:

- Probe: EX3DV4 - SN3943; ConvF(7.95, 7.95, 7.95); Calibrated: 2013/8/29
- Sensor-Surface: 4mm (Mechanical Surface Detection)
- Electronics: DAE4 Sn629; Calibrated: 2013/8/21
- Phantom: SAM 12; Type: SAM V4.0; Serial: TP:1281
- Measurement SW: DASY4, V4.7 Build 80; Postprocessing SW: SEMCAD, V1.8 Build 186

Side C-MID/Area Scan (41x81x1): Measurement grid: dx=15mm, dy=15mm
Maximum value of SAR (interpolated) = 0.063 mW/g

Side C-MID/Zoom Scan (5x5x7)/Cube 0: Measurement grid: dx=8mm, dy=8mm, dz=5mm
Reference Value = 2.72 V/m; Power Drift = 0.106 dB
Peak SAR (extrapolated) = 0.093 W/kg
SAR(1 g) = 0.042 mW/g; SAR(10 g) = 0.019 mW/g
Maximum value of SAR (measured) = 0.050 mW/g

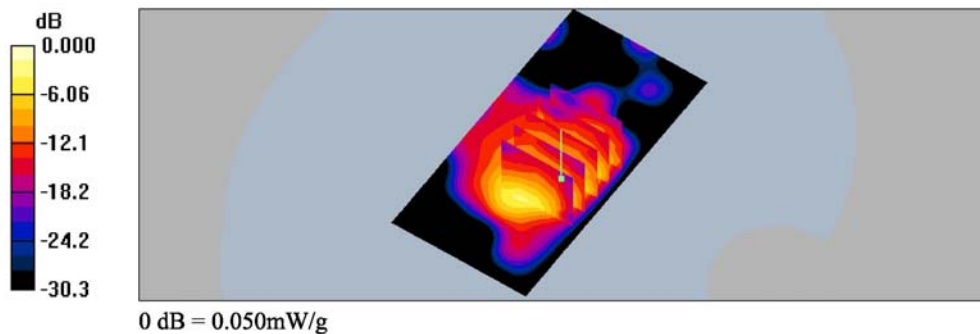

Date/Time: 2013/11/5 AM 11:24:23

Test Laboratory: Electronics Testing Center, Taiwan
File Name: [PP-Side C&D.da4](#)

DUT: n/a; Type: PP; Serial: n/a
Program Name: Unnamed Program

Communication System: US DECT-1900; Frequency: 1925 MHz; Duty Cycle: 1:24
Medium parameters used: $f = 1925$ MHz; $\sigma = 1.6$ mho/m; $\epsilon_r = 53.9$; $\rho = 1000$ kg/m³
Phantom section: Flat Section

DASY4 Configuration:

- Probe: EX3DV4 - SN3943; ConvF(7.95, 7.95, 7.95); Calibrated: 2013/8/29
- Sensor-Surface: 4mm (Mechanical Surface Detection)
- Electronics: DAE4 Sn629; Calibrated: 2013/8/21
- Phantom: SAM 12; Type: SAM V4.0; Serial: TP:1281
- Measurement SW: DASY4, V4.7 Build 80; Postprocessing SW: SEMCAD, V1.8 Build 186

Side D-MID/Area Scan (41x81x1): Measurement grid: dx=15mm, dy=15mm
Maximum value of SAR (interpolated) = 0.023 mW/g

Side D-MID/Zoom Scan (5x5x7)/Cube 0: Measurement grid: dx=8mm, dy=8mm, dz=5mm
Reference Value = 0.459 V/m; Power Drift = 0.137 dB
Peak SAR (extrapolated) = 0.015 W/kg
SAR(1 g) = 0.00636 mW/g; SAR(10 g) = 0.00232 mW/g

Maximum value of SAR (measured) = 0.007 mW/g

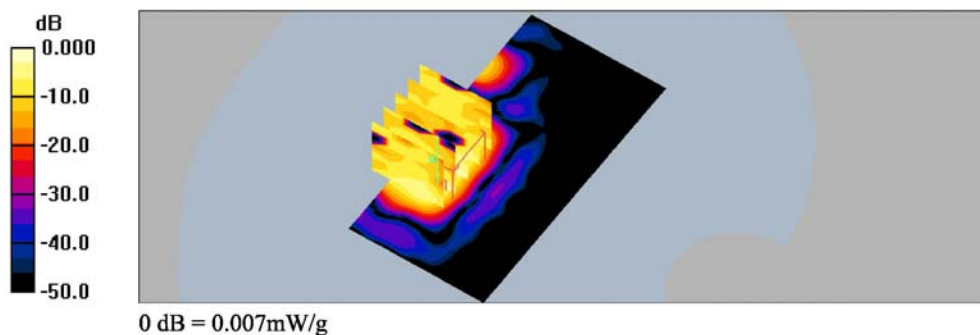

Date/Time: 2013/11/5 AM 11:46:59

Test Laboratory: Electronics Testing Center, Taiwan
File Name: [PP-Side A&B.da4](#)

DUT: n/a; Type: PP; Serial: n/a
Program Name: Unnamed Program

Communication System: US DECT-1900; Frequency: 1928.5 MHz; Duty Cycle: 1:24
Medium parameters used (interpolated): $f = 1928.5$ MHz; $\sigma = 1.61$ mho/m; $\epsilon_r = 53.9$; $\rho = 1000$ kg/m³
Phantom section: Flat Section

DASY4 Configuration:
- Probe: EX3DV4 - SN3943; ConvF(7.95, 7.95, 7.95); Calibrated: 2013/8/29
- Sensor-Surface: 4mm (Mechanical Surface Detection)
- Electronics: DAE4 Sn629; Calibrated: 2013/8/21
- Phantom: SAM 12; Type: SAM V4.0; Serial: TP:1281
- Measurement SW: DASY4, V4.7 Build 80; Postprocessing SW: SEMCAD, V1.8 Build 186

Side A-HIGH/Zoom Scan (5x5x7)/Cube 0: Measurement grid: dx=8mm, dy=8mm, dz=5mm
Reference Value = 5.05 V/m; Power Drift = 0.189 dB
Peak SAR (extrapolated) = 0.337 W/kg
SAR(1 g) = 0.137 mW/g; SAR(10 g) = 0.056 mW/g
Maximum value of SAR (measured) = 0.173 mW/g

Side A-HIGH/Area Scan (41x81x1): Measurement grid: dx=15mm, dy=15mm

Maximum value of SAR (interpolated) = 0.177 mW/g

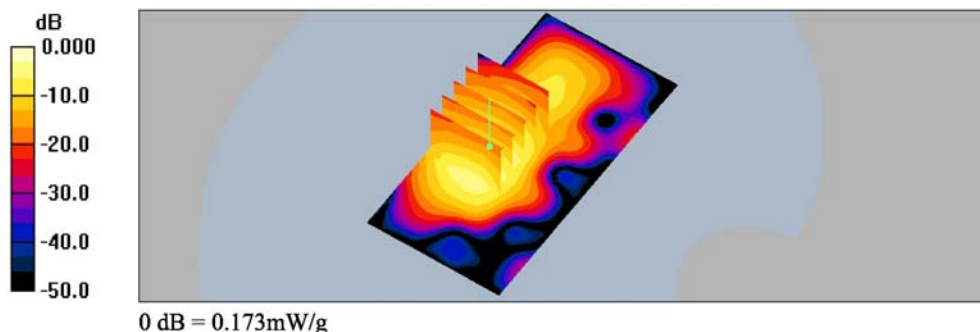

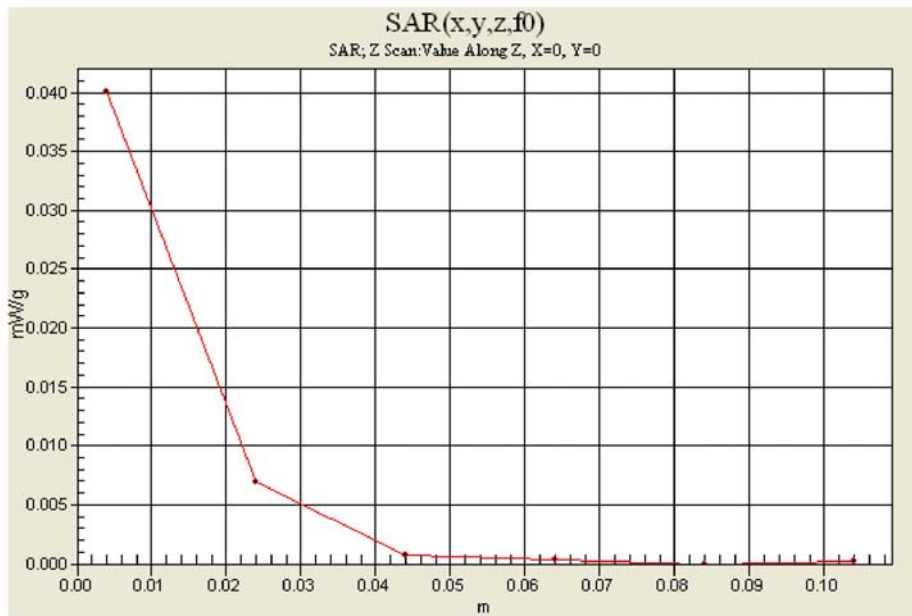

Date/Time: 2013/11/5 AM 12:01:00

Test Laboratory: Electronics Testing Center, Taiwan
File Name: [PP-Side A&B.da4](#)

DUT: n/a; Type: PP; Serial: n/a
Program Name: Unnamed Program

Communication System: US DECT-1900; Frequency: 1921.5 MHz; Duty Cycle: 1:24
Medium parameters used: $f = 1922$ MHz; $\sigma = 1.6$ mho/m; $\epsilon_r = 53.9$; $\rho = 1000$ kg/m³
Phantom section: Flat Section

DASY4 Configuration:

- Probe: EX3DV4 - SN3943; ConvF(7.95, 7.95, 7.95); Calibrated: 2013/8/29
- Sensor-Surface: 4mm (Mechanical Surface Detection)
- Electronics: DAE4 Sn629; Calibrated: 2013/8/21
- Phantom: SAM 12; Type: SAM V4.0; Serial: TP:1281
- Measurement SW: DASY4, V4.7 Build 80; Postprocessing SW: SEMCAD, V1.8 Build 186

Side A-LOW/Zoom Scan (5x5x7)/Cube 0: Measurement grid: dx=8mm, dy=8mm, dz=5mm
Reference Value = 4.88 V/m; Power Drift = 0.172 dB
Peak SAR (extrapolated) = 0.337 W/kg
SAR(1 g) = 0.137 mW/g; SAR(10 g) = 0.056 mW/g
Maximum value of SAR (measured) = 0.174 mW/g

Side A-LOW/Area Scan (41x81x1): Measurement grid: dx=15mm, dy=15mm
Maximum value of SAR (interpolated) = 0.179 mW/g

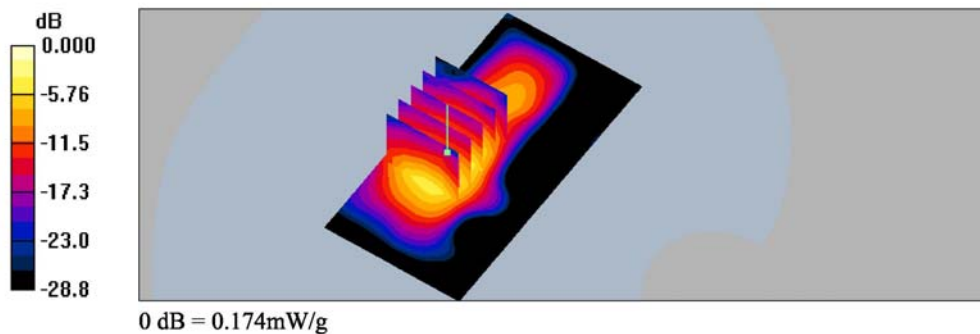

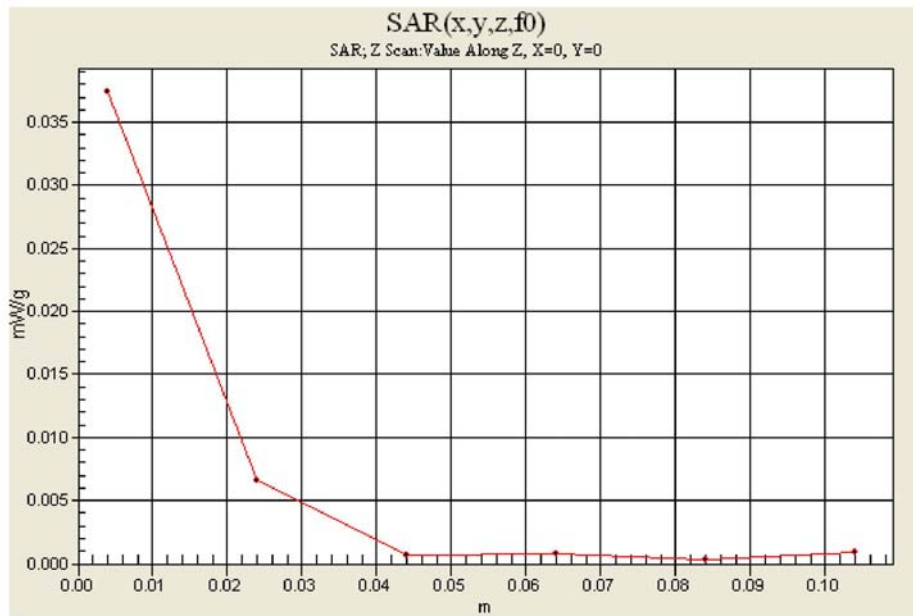

ANNEX C: DIPOLE CERTIFICATE

**Calibration Laboratory of
 Schmid & Partner
 Engineering AG**
 Zeughausstrasse 43, 8004 Zurich, Switzerland



S Schweizerischer Kalibrierdienst
C Service suisse d'étalonnage
S Servizio svizzero di taratura
S Swiss Calibration Service

Accredited by the Swiss Accreditation Service (SAS)
 The Swiss Accreditation Service is one of the signatories to the EA
 Multilateral Agreement for the recognition of calibration certificates

Accreditation No.: **SCS 108**

Client **ETC (Auden)**

Certificate No: **D1900V2-5d054_Oct12**

CALIBRATION CERTIFICATE			
Object	D1900V2 - SN: 5d054		
Calibration procedure(s)	QA CAL-05.v8 Calibration procedure for dipole validation kits above 700 MHz		
Calibration date:	October 01, 2012		
<p>This calibration certificate documents the traceability to national standards, which realize the physical units of measurements (SI). The measurements and the uncertainties with confidence probability are given on the following pages and are part of the certificate.</p> <p>All calibrations have been conducted in the closed laboratory facility: environment temperature (22 ± 3)°C and humidity < 70%.</p> <p>Calibration Equipment used (M&TE critical for calibration)</p>			
Primary Standards	ID #	Cal Date (Certificate No.)	Scheduled Calibration
Power meter EPM-442A	GB37480704	05-Oct-11 (No. 217-01451)	Oct-12
Power sensor HP 8481A	US37292783	05-Oct-11 (No. 217-01451)	Oct-12
Reference 20 dB Attenuator	SN: 5058 (20k)	27-Mar-12 (No. 217-01530)	Apr-13
Type-N mismatch combination	SN: 5047.2 / 06327	27-Mar-12 (No. 217-01533)	Apr-13
Reference Probe ES3DV3	SN: 3205	30-Dec-11 (No. ES3-3205_Dec11)	Dec-12
DAE4	SN: 601	27-Jun-12 (No. DAE4-601_Jun12)	Jun-13
Secondary Standards	ID #	Check Date (in house)	Scheduled Check
Power sensor HP 8481A	MY41092317	18-Oct-02 (in house check Oct-11)	In house check: Oct-13
RF generator R&S SMT-06	100005	04-Aug-99 (in house check Oct-11)	In house check: Oct-13
Network Analyzer HP 8753E	US37390585 S4206	18-Oct-01 (in house check Oct-11)	In house check: Oct-12
Calibrated by:	Name Claudio Leubler	Function Laboratory Technician	Signature
Approved by:	Name Katja Pokovic	Technical Manager	
			Issued: October 2, 2012
This calibration certificate shall not be reproduced except in full without written approval of the laboratory.			

**Calibration Laboratory of
Schmid & Partner
Engineering AG**
Zeughausstrasse 43, 8004 Zurich, Switzerland



S Schweizerischer Kalibrierdienst
C Service suisse d'étalonnage
S Servizio svizzero di taratura
S Swiss Calibration Service

Accredited by the Swiss Accreditation Service (SAS)
The Swiss Accreditation Service is one of the signatories to the EA
Multilateral Agreement for the recognition of calibration certificates

Accreditation No.: **SCS 108**

Glossary:

TSL	tissue simulating liquid
ConvF	sensitivity in TSL / NORM x,y,z
N/A	not applicable or not measured

Calibration is Performed According to the Following Standards:

- IEEE Std 1528-2003, "IEEE Recommended Practice for Determining the Peak Spatial-Averaged Specific Absorption Rate (SAR) in the Human Head from Wireless Communications Devices: Measurement Techniques", December 2003
- IEC 62209-1, "Procedure to measure the Specific Absorption Rate (SAR) for hand-held devices used in close proximity to the ear (frequency range of 300 MHz to 3 GHz)", February 2005
- Federal Communications Commission Office of Engineering & Technology (FCC OET), "Evaluating Compliance with FCC Guidelines for Human Exposure to Radiofrequency Electromagnetic Fields; Additional Information for Evaluating Compliance of Mobile and Portable Devices with FCC Limits for Human Exposure to Radiofrequency Emissions", Supplement C (Edition 01-01) to Bulletin 65

Additional Documentation:

- DASY4/5 System Handbook

Methods Applied and Interpretation of Parameters:

- Measurement Conditions:* Further details are available from the Validation Report at the end of the certificate. All figures stated in the certificate are valid at the frequency indicated.
- Antenna Parameters with TSL:* The dipole is mounted with the spacer to position its feed point exactly below the center marking of the flat phantom section, with the arms oriented parallel to the body axis.
- Feed Point Impedance and Return Loss:* These parameters are measured with the dipole positioned under the liquid filled phantom. The impedance stated is transformed from the measurement at the SMA connector to the feed point. The Return Loss ensures low reflected power. No uncertainty required.
- Electrical Delay:* One-way delay between the SMA connector and the antenna feed point. No uncertainty required.
- SAR measured:* SAR measured at the stated antenna input power.
- SAR normalized:* SAR as measured, normalized to an input power of 1 W at the antenna connector.
- SAR for nominal TSL parameters:* The measured TSL parameters are used to calculate the nominal SAR result.

The reported uncertainty of measurement is stated as the standard uncertainty of measurement multiplied by the coverage factor $k=2$, which for a normal distribution corresponds to a coverage probability of approximately 95%.

Measurement Conditions

DASY system configuration, as far as not given on page 1.

DASY Version	DASY5	V52.8.2
Extrapolation	Advanced Extrapolation	
Phantom	Modular Flat Phantom	
Distance Dipole Center - TSL	10 mm	with Spacer
Zoom Scan Resolution	dx, dy, dz = 5 mm	
Frequency	1900 MHz ± 1 MHz	

Head TSL parameters

The following parameters and calculations were applied.

	Temperature	Permittivity	Conductivity
Nominal Head TSL parameters	22.0 °C	40.0	1.40 mho/m
Measured Head TSL parameters	(22.0 ± 0.2) °C	40.6 ± 6 %	1.37 mho/m ± 6 %
Head TSL temperature change during test	< 0.5 °C	----	----

SAR result with Head TSL

SAR averaged over 1 cm ³ (1 g) of Head TSL	Condition	
SAR measured	250 mW input power	9.63 mW / g
SAR for nominal Head TSL parameters	normalized to 1W	39.2 mW / g ± 17.0 % (k=2)

SAR averaged over 10 cm ³ (10 g) of Head TSL	condition	
SAR measured	250 mW input power	5.09 mW / g
SAR for nominal Head TSL parameters	normalized to 1W	20.6 mW / g ± 16.5 % (k=2)

Body TSL parameters

The following parameters and calculations were applied.

	Temperature	Permittivity	Conductivity
Nominal Body TSL parameters	22.0 °C	53.3	1.52 mho/m
Measured Body TSL parameters	(22.0 ± 0.2) °C	52.5 ± 6 %	1.54 mho/m ± 6 %
Body TSL temperature change during test	< 0.5 °C	----	----

SAR result with Body TSL

SAR averaged over 1 cm ³ (1 g) of Body TSL	Condition	
SAR measured	250 mW input power	10.0 mW / g
SAR for nominal Body TSL parameters	normalized to 1W	39.6 mW / g ± 17.0 % (k=2)

SAR averaged over 10 cm ³ (10 g) of Body TSL	condition	
SAR measured	250 mW input power	5.32 mW / g
SAR for nominal Body TSL parameters	normalized to 1W	21.1 mW / g ± 16.5 % (k=2)

Appendix

Antenna Parameters with Head TSL

Impedance, transformed to feed point	53.9 Ω + 4.0 j Ω
Return Loss	- 25.3 dB

Antenna Parameters with Body TSL

Impedance, transformed to feed point	49.7 Ω + 5.1 j Ω
Return Loss	- 25.8 dB

General Antenna Parameters and Design

Electrical Delay (one direction)	1.199 ns
----------------------------------	----------

After long term use with 100W radiated power, only a slight warming of the dipole near the feedpoint can be measured.

The dipole is made of standard semirigid coaxial cable. The center conductor of the feeding line is directly connected to the second arm of the dipole. The antenna is therefore short-circuited for DC-signals. On some of the dipoles, small end caps are added to the dipole arms in order to improve matching when loaded according to the position as explained in the "Measurement Conditions" paragraph. The SAR data are not affected by this change. The overall dipole length is still according to the Standard.

No excessive force must be applied to the dipole arms, because they might bend or the soldered connections near the feedpoint may be damaged.

Additional EUT Data

Manufactured by	SPEAG
Manufactured on	March 19, 2004

DASY5 Validation Report for Head TSL

Date: 01.10.2012

Test Laboratory: SPEAG, Zurich, Switzerland

DUT: Dipole 1900 MHz; Type: D1900V2; Serial: D1900V2 - SN: 5d054

Communication System: CW; Frequency: 1900 MHz

Medium parameters used: $f = 1900$ MHz; $\sigma = 1.37$ mho/m; $\epsilon_r = 40.6$; $\rho = 1000$ kg/m³

Phantom section: Flat Section

Measurement Standard: DASY5 (IEEE/IEC/ANSI C63.19-2007)

DASY52 Configuration:

- Probe: ES3DV3 - SN3205; ConvF(5.01, 5.01, 5.01); Calibrated: 30.12.2011;
- Sensor-Surface: 3mm (Mechanical Surface Detection)
- Electronics: DAE4 Sn601; Calibrated: 27.06.2012
- Phantom: Flat Phantom 5.0 (front); Type: QD000P50AA; Serial: 1001
- DASY52 52.8.2(969); SEMCAD X 14.6.6(6824)

Dipole Calibration for Head Tissue/Pin=250 mW, d=10mm/Zoom Scan (7x7x7)/Cube 0:

Measurement grid: dx=5mm, dy=5mm, dz=5mm

Reference Value = 94.066 V/m; Power Drift = 0.06 dB

Peak SAR (extrapolated) = 17.034 mW/g

SAR(1 g) = 9.63 mW/g; SAR(10 g) = 5.09 mW/g

Maximum value of SAR (measured) = 11.7 W/kg

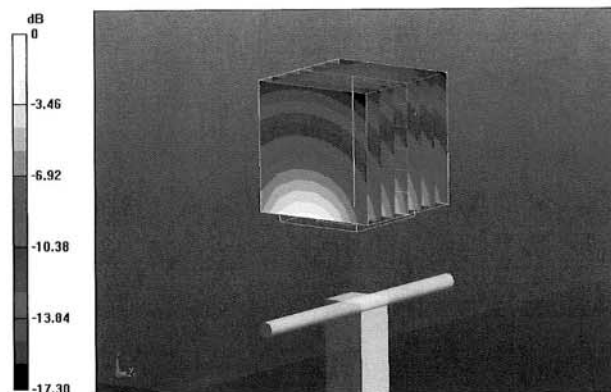

0 dB = 11.7 W/kg = 21.36 dB W/kg

Impedance Measurement Plot for Head TSL

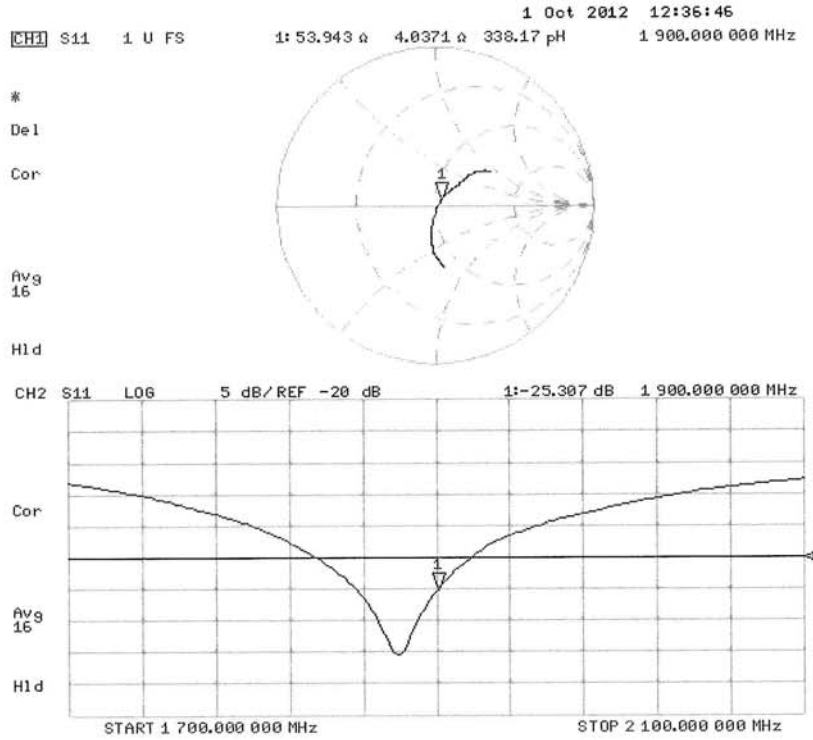

DASY5 Validation Report for Body TSL

Date: 01.10.2012

Test Laboratory: SPEAG, Zurich, Switzerland

DUT: Dipole 1900 MHz; Type: D1900V2; Serial: D1900V2 - SN: 5d054

Communication System: CW; Frequency: 1900 MHz

Medium parameters used: $f = 1900$ MHz; $\sigma = 1.54$ mho/m; $\epsilon_r = 52.5$; $\rho = 1000$ kg/m³

Phantom section: Flat Section

Measurement Standard: DASY5 (IEEE/IEC/ANSI C63.19-2007)

DASY52 Configuration:

- Probe: ES3DV3 - SN3205; ConvF(4.62, 4.62, 4.62); Calibrated: 30.12.2011;
- Sensor-Surface: 3mm (Mechanical Surface Detection)
- Electronics: DAE4 Sn601; Calibrated: 27.06.2012
- Phantom: Flat Phantom 5.0 (back); Type: QD000P50AA; Serial: 1002
- DASY52 52.8.2(969); SEMCAD X 14.6.6(6824)

Dipole Calibration for Body Tissue/Pin=250 mW, d=10mm/Zoom Scan (7x7x7)/Cube 0:

Measurement grid: dx=5mm, dy=5mm, dz=5mm

Reference Value = 94.066 V/m; Power Drift = 0.05 dB

Peak SAR (extrapolated) = 17.527 mW/g

SAR(1 g) = 10 mW/g; SAR(10 g) = 5.32 mW/g

Maximum value of SAR (measured) = 12.6 W/kg

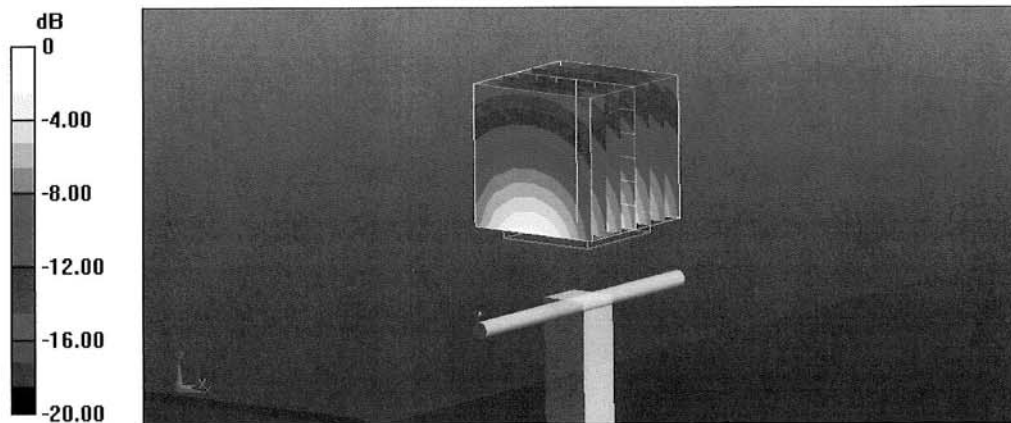

0 dB = 12.6 W/kg = 22.01 dB W/kg

Impedance Measurement Plot for Body TSL

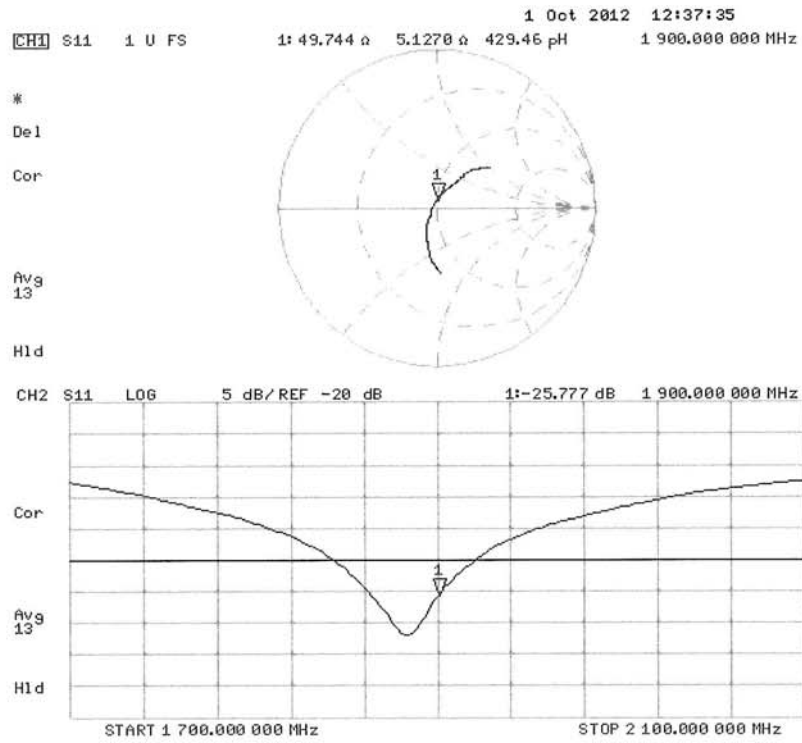

ANNEX D: PROBE CERTIFICATE

**Calibration Laboratory of
 Schmid & Partner
 Engineering AG**
 Zeughausstrasse 43, 8004 Zurich, Switzerland



S Schweizerischer Kalibrierdienst
C Service suisse d'étalonnage
S Servizio svizzero di taratura
S Swiss Calibration Service

Accredited by the Swiss Accreditation Service (SAS)
 The Swiss Accreditation Service is one of the signatories to the EA
 Multilateral Agreement for the recognition of calibration certificates

Accreditation No.: **SCS 108**

Client **ETC (Auden)**

Certificate No: **EX3-3943_Aug13**

CALIBRATION CERTIFICATE

Object: **EX3DV4 - SN:3943**

Calibration procedure(s): **QA CAL-01.v8, QA CAL-14.v3, QA CAL-23.v4, QA CAL-25.v4
 Calibration procedure for dosimetric E-field probes**

Calibration date: **August 2, 2013**

This calibration certificate documents the traceability to national standards, which realize the physical units of measurements (SI).
 The measurements and the uncertainties with confidence probability are given on the following pages and are part of the certificate.

All calibrations have been conducted in the closed laboratory facility: environment temperature (22 ± 3)°C and humidity < 70%.

Calibration Equipment used (M&TE critical for calibration)

Primary Standards	ID	Cal Date (Certificate No.)	Scheduled Calibration
Power meter E4419B	GB41293874	04-Apr-13 (No. 217-01733)	Apr-14
Power sensor E4412A	MY41498087	04-Apr-13 (No. 217-01733)	Apr-14
Reference 3 dB Attenuator	SN: S5054 (3c)	04-Apr-13 (No. 217-01737)	Apr-14
Reference 20 dB Attenuator	SN: S5277 (20x)	04-Apr-13 (No. 217-01735)	Apr-14
Reference 30 dB Attenuator	SN: S5129 (30b)	04-Apr-13 (No. 217-01738)	Apr-14
Reference Probe ES3DV2	SN: 3013	28-Dec-12 (No. ES3-3013_Dec12)	Dec-13
DAE4	SN: 660	31-Jan-13 (No. DAE4-660_Jan13)	Jan-14
Secondary Standards	ID	Check Date (in house)	Scheduled Check
RF generator HP 8648C	US3642U01700	4-Aug-99 (in house check Apr-13)	In house check: Apr-15
Network Analyzer HP 8753E	US37390585	18-Oct-01 (in house check Oct-12)	In house check: Oct-13

	Name	Function	Signature
Calibrated by:	Katja Pokovic	Technical Manager	
Approved by:	Niels Kuster	Quality Manager	

Issued: August 2, 2013

This calibration certificate shall not be reproduced except in full without written approval of the laboratory.

Calibration Laboratory of
Schmid & Partner
Engineering AG
Zeughausstrasse 43, 8004 Zurich, Switzerland



S Schweizerischer Kalibrierdienst
C Service suisse d'étalonnage
S Servizio svizzero di taratura
S Swiss Calibration Service

Accredited by the Swiss Accreditation Service (SAS)

Accreditation No.: **SCS 108**

The Swiss Accreditation Service is one of the signatories to the EA Multilateral Agreement for the recognition of calibration certificates

Glossary:

TSL	tissue simulating liquid
NORM _{x,y,z}	sensitivity in free space
ConvF	sensitivity in TSL / NORM _{x,y,z}
DCP	diode compression point
CF	crest factor (1/duty_cycle) of the RF signal
A, B, C, D	modulation dependent linearization parameters
Polarization φ	φ rotation around probe axis
Polarization ϑ	ϑ rotation around an axis that is in the plane normal to probe axis (at measurement center), i.e., $\vartheta = 0$ is normal to probe axis

Calibration is Performed According to the Following Standards:

- IEEE Std 1528-2003, "IEEE Recommended Practice for Determining the Peak Spatial-Averaged Specific Absorption Rate (SAR) in the Human Head from Wireless Communications Devices: Measurement Techniques", December 2003
- IEC 62209-1, "Procedure to measure the Specific Absorption Rate (SAR) for hand-held devices used in close proximity to the ear (frequency range of 300 MHz to 3 GHz)", February 2005

Methods Applied and Interpretation of Parameters:

- NORM_{x,y,z}**: Assessed for E-field polarization $\vartheta = 0$ ($f \leq 900$ MHz in TEM-cell; $f > 1800$ MHz: R22 waveguide). NORM_{x,y,z} are only intermediate values, i.e., the uncertainties of NORM_{x,y,z} does not affect the E²-field uncertainty inside TSL (see below ConvF).
- NORM(f)_{x,y,z}** = NORM_{x,y,z} * frequency_response (see Frequency Response Chart). This linearization is implemented in DASY4 software versions later than 4.2. The uncertainty of the frequency response is included in the stated uncertainty of ConvF.
- DCP_{x,y,z}**: DCP are numerical linearization parameters assessed based on the data of power sweep with CW signal (no uncertainty required). DCP does not depend on frequency nor media.
- PAR**: PAR is the Peak to Average Ratio that is not calibrated but determined based on the signal characteristics
- A_{x,y,z}; B_{x,y,z}; C_{x,y,z}; D_{x,y,z}; VR_{x,y,z}; A, B, C, D** are numerical linearization parameters assessed based on the data of power sweep for specific modulation signal. The parameters do not depend on frequency nor media. VR is the maximum calibration range expressed in RMS voltage across the diode.
- ConvF and Boundary Effect Parameters**: Assessed in flat phantom using E-field (or Temperature Transfer Standard for $f \leq 800$ MHz) and inside waveguide using analytical field distributions based on power measurements for $f > 800$ MHz. The same setups are used for assessment of the parameters applied for boundary compensation (alpha, depth) of which typical uncertainty values are given. These parameters are used in DASY4 software to improve probe accuracy close to the boundary. The sensitivity in TSL corresponds to NORM_{x,y,z} * ConvF whereby the uncertainty corresponds to that given for ConvF. A frequency dependent ConvF is used in DASY version 4.4 and higher which allows extending the validity from ± 50 MHz to ± 100 MHz.
- Spherical isotropy (3D deviation from isotropy)**: in a field of low gradients realized using a flat phantom exposed by a patch antenna.
- Sensor Offset**: The sensor offset corresponds to the offset of virtual measurement center from the probe tip (on probe axis). No tolerance required.

EX3DV4 – SN:3943

August 2, 2013

Probe EX3DV4

SN:3943

Manufactured: May 2, 2013
Calibrated: August 2, 2013

Calibrated for DASY/EASY Systems
(Note: non-compatible with DASY2 system!)

EX3DV4– SN:3943

August 2, 2013

DASY/EASY - Parameters of Probe: EX3DV4 - SN:3943

Basic Calibration Parameters

	Sensor X	Sensor Y	Sensor Z	Unc (k=2)
Norm ($\mu\text{V}/(\text{V}/\text{m})^2$) ^A	0.44	0.47	0.47	± 10.1 %
DCP (mV) ^B	101.7	104.4	103.9	

Modulation Calibration Parameters

UID	Communication System Name		A dB	B dB $\sqrt{\mu\text{V}}$	C	D dB	VR mV	Unc ^C (k=2)
0	CW	X	0.0	0.0	1.0	0.00	155.9	±2.5 %
		Y	0.0	0.0	1.0		164.0	
		Z	0.0	0.0	1.0		160.9	

The reported uncertainty of measurement is stated as the standard uncertainty of measurement multiplied by the coverage factor k=2, which for a normal distribution corresponds to a coverage probability of approximately 95%.

^A The uncertainties of NormX,Y,Z do not affect the E²-field uncertainty inside TSL (see Pages 5 and 6).

^B Numerical linearization parameter: uncertainty not required.

^C Uncertainty is determined using the max. deviation from linear response applying rectangular distribution and is expressed for the square of the field value.

EX3DV4– SN:3943

August 2, 2013

DASY/EASY - Parameters of Probe: EX3DV4 - SN:3943

Calibration Parameter Determined in Head Tissue Simulating Media

f (MHz) ^C	Relative Permittivity ^F	Conductivity (S/m) ^F	ConvF X	ConvF Y	ConvF Z	Alpha	Depth (mm)	Unct. (k=2)
835	41.5	0.90	10.22	10.22	10.22	0.46	0.81	± 12.0 %
900	41.5	0.97	9.97	9.97	9.97	0.27	1.00	± 12.0 %
1750	40.1	1.37	8.61	8.61	8.61	0.35	0.83	± 12.0 %
1810	40.0	1.40	8.39	8.39	8.39	0.65	0.62	± 12.0 %
2000	40.0	1.40	8.36	8.36	8.36	0.46	0.72	± 12.0 %
2450	39.2	1.80	7.55	7.55	7.55	0.24	1.09	± 12.0 %

^C Frequency validity of ± 100 MHz only applies for DASY v4.4 and higher (see Page 2), else it is restricted to ± 50 MHz. The uncertainty is the RSS of the ConvF uncertainty at calibration frequency and the uncertainty for the indicated frequency band.

^F At frequencies below 3 GHz, the validity of tissue parameters (ϵ and σ) can be relaxed to ± 10% if liquid compensation formula is applied to measured SAR values. At frequencies above 3 GHz, the validity of tissue parameters (ϵ and σ) is restricted to ± 5%. The uncertainty is the RSS of the ConvF uncertainty for indicated target tissue parameters.

EX3DV4- SN:3943

August 2, 2013

DASY/EASY - Parameters of Probe: EX3DV4 - SN:3943

Calibration Parameter Determined in Body Tissue Simulating Media

f (MHz) ^C	Relative Permittivity ^F	Conductivity (S/m) ^F	ConvF X	ConvF Y	ConvF Z	Alpha	Depth (mm)	Unct. (k=2)
835	55.2	0.97	10.37	10.37	10.37	0.34	1.03	± 12.0 %
900	55.0	1.05	10.19	10.19	10.19	0.48	0.82	± 12.0 %
1750	53.4	1.49	8.21	8.21	8.21	0.31	0.97	± 12.0 %
1810	53.3	1.52	8.03	8.03	8.03	0.35	0.90	± 12.0 %
2000	53.3	1.52	8.05	8.05	8.05	0.35	0.93	± 12.0 %
2450	52.7	1.95	7.48	7.48	7.48	0.80	0.55	± 12.0 %
5200	49.0	5.30	4.45	4.45	4.45	0.45	1.90	± 13.1 %
5300	48.9	5.42	4.18	4.18	4.18	0.50	1.90	± 13.1 %
5600	48.5	5.77	3.90	3.90	3.90	0.50	1.90	± 13.1 %
5800	48.2	6.00	4.01	4.01	4.01	0.55	1.90	± 13.1 %

^C Frequency validity of ± 100 MHz only applies for DASY v4.4 and higher (see Page 2), else it is restricted to ± 50 MHz. The uncertainty is the RSS of the ConvF uncertainty at calibration frequency and the uncertainty for the indicated frequency band.

^F At frequencies below 3 GHz, the validity of tissue parameters (ϵ and σ) can be relaxed to ± 10% if liquid compensation formula is applied to measured SAR values. At frequencies above 3 GHz, the validity of tissue parameters (ϵ and σ) is restricted to ± 5%. The uncertainty is the RSS of the ConvF uncertainty for indicated target tissue parameters.