

Classroom Audio System



User Manual  
Preliminary



# TABLE OF CONTENTS

---

SECTION 1:	4	Important safety instructions
<b>Overview</b>	5	System components and unpacking
	6	Standard components & Optional accessories
	7	Front panel controls & indicators
	8	Rear panel controls & connections
	9	Flexmike controls and connections
SECTION 2:	10	Charging the Flexmike
<b>Daily Operation</b>	11	Operating the Flexmike
	12	Using Flexmike as wireless audio link
	12	Output to Assistive Listening Device (ALD)
	13	Audio integration
	17	<b>Daily Operation Instructions</b>
SECTION 3:	18	Sharemike: Controls & Connections
<b>Optional Accessories</b>	19	Sharemike: Charging
	20	Sharemike: Initial Set-up
	21	Media Connector controls and connections
	23	Using the Media Connector
	24	Flexcat audio pods for small group instruction
SECTION 4:	25	Battery replacement
<b>Maintenance and Troubleshooting</b>	27	Troubleshooting
	28	Tips to obtain optimal audio performance
SECTION 6:	29	Warranty statement
<b>Warranty, Safety and Specifications</b>	30	Safety warnings and certifications
	34	System specifications

# IMPORTANT SAFETY INSTRUCTIONS

1. Read these instructions.
2. Keep these instructions.
3. Heed all warnings.
4. Follow all instructions.
5. Do not use the apparatus near water.
6. Clean only with dry cloth.
7. Do not block any ventilation openings. Install in accordance with the manufacturer's instructions.
8. Do not install near any heat sources such as radiators, heat registers, stoves, or other apparatus (including amplifiers) that produce heat.
9. Do not defeat the safety purpose of the polarized or grounding-type plug. A polarized plug has two blades with one wider than the other. A grounding-type plug has two blades and a third grounding prong. The wide blade or the third prong is provided for your safety. If the provided plug does not fit into your outlet, consult an electrician for replacement of the obsolete outlet.
10. Protect the power cord from being walked on or pinched particularly at plugs, convenience receptacles, and the point where they exit from the apparatus.
11. Only use attachments/ accessories specified by the manufacturer.
12. Use only with a cart, stand, tripod, bracket or table specified by the manufacturer, or sold with the apparatus. When a cart is used, use caution when moving the cart/apparatus combination to avoid injury from tip-over. 
13. Unplug this apparatus during lightning storms or when unused for long periods of time.
14. Refer all servicing to qualified service personnel. Servicing is required when the apparatus has been damaged in any way, such as power-supply cord or plug is damaged, liquid has been spilled or objects have fallen into the apparatus, the apparatus has been exposed to rain or moisture, does not operate normally, or has been dropped.
15. When the mains plug or appliance coupler is used as the disconnect device, it shall remain readily operable.
16. Please keep the unit in a good ventilation environment.
17. **WARNING:** To reduce the risk of fire or electric shock, do not expose this apparatus to rain or moisture.
18. Apparatus shall not be exposed to dripping or splashing and no objects filled with liquids, such as vases, shall be placed on the apparatus.
19. Warning - battery pack shall not be exposed to excessive heat such as sunshine, fire or the like.

## SECTION 1:

# OVERVIEW

## SYSTEM COMPONENTS AND UNPACKING

The standard configuration of the 955 Access will contain:

955 Access and Power  
Supply

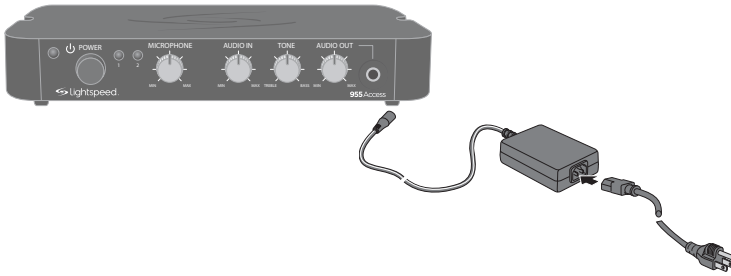

Flexmike  
Classroom  
Microphone



Flexmike Wall  
Charger & Charging  
Cable



**PLEASE NOTE:** The 955 Access and any wireless components (microphones, Media Connector, pods) are registered together at the factory and are labeled as such with ID numbers. Please keep all components together as a system. Moving them from one system or room to another will result in the need to re-register them to function.

Additional system labels are included in the back of this manual should you add components, or if one of your original components should need to be replaced.

5. Warranty, Safety  
& Specifications

4. Maintenance &  
Troubleshooting

3. Optional Accessories

2. Set Up & Use /  
Daily Operation

1. Overview

## SYSTEM COMPONENTS AND UNPACKING CONT'D

### Speakers

Systems can be configured with a variety of different speaker types, including the following:

TCQ (x 1)

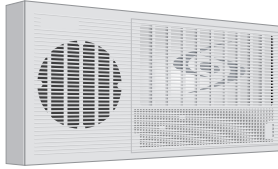

DRQ (x 4)

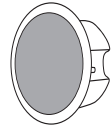

WMQ (x 4)

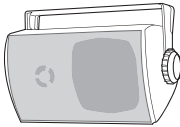

4jCS (x4)  
(plenum rated)

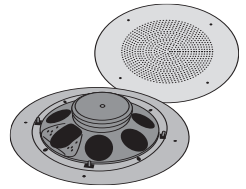

## Standard Components

955 Access	Wireless audio system
24V-2.5A-NA	24V/2.5A power supply, U.S. and Canada
24V-2.5A-__	24V/2.5A power supply, specify country
USB2-NA	Transmitter wall charger, power supply, U.S. and Canada
USB-MCB	USB Type A-Micro B charging cable for Flexmike
AD-USB3DC	International charging/power adaptor
FM	Flexmike classroom microphone with battery pack and lanyard
NH2.4V	AA NiMH rechargeable battery pack for Flexmike, one per Flexmike
FL	Flexmike lavalier cord
SPEAKERS	As ordered.

## Optional Accessories

FCAD-4	Flexcat for small group instruction*
SM	Handheld microphone with battery pack
NH2APK	AA NiMH rechargeable battery pack for Sharemike, one per Sharemike
USBDC	Charging cable for Sharemike
MCA	Media Connector with Access
USB2-NA	Transmitter wall charger, power supply, U.S. and Canada
USB-MCB	USB Type A-Micro B power cable for Media Connector
USB3DC	International transmitter charging adaptor
5V-1.0-__	5V charging power supply

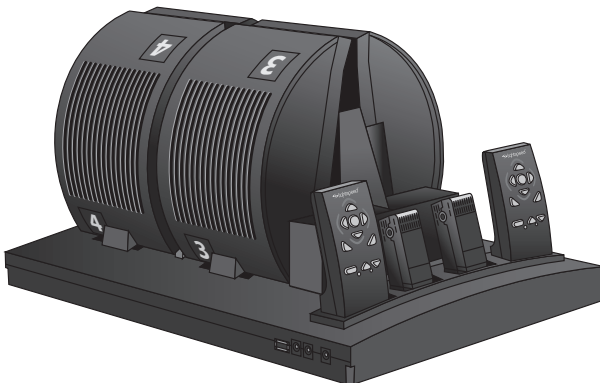

\*For further information on Flexcat for small group instruction, please visit [www.lightspeed-tek.com](http://www.lightspeed-tek.com)

5. Warranty, Safety & Specifications

4. Maintenance & Troubleshooting

3. Optional Accessories

2. Set Up & Use / Daily Operation

1. Overview

## FRONT PANEL CONTROLS & INDICATORS

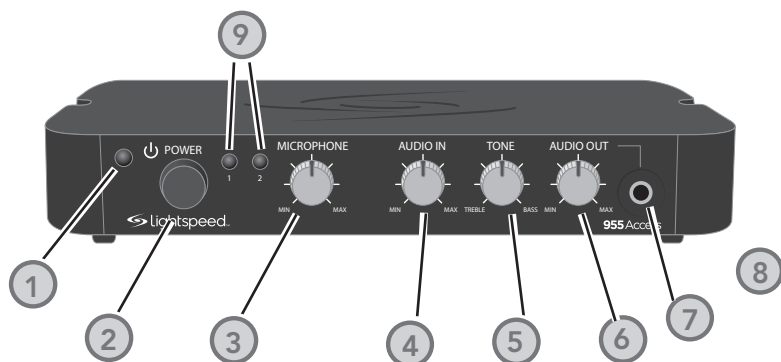

1. **POWER LIGHT:** This light will turn blue when power is on.
2. **POWER BUTTON:** Press and hold this push button to turn the system power on or off.
3. **MICROPHONE VOLUME CONTROL:** Controls the volume level of the microphones.
4. **AUDIO IN VOLUME CONTROL:** Controls the volume level of the audio sources connected to the audio inputs on back of the 955 Access.
5. **TONE CONTROL:** Adjusts the audio tone adding more bass or treble for a more rich or more crisp tone.
6. **AUDIO OUT VOLUME CONTROL:** Controls the volume level of the audio output
7. **AUDIO OUTPUT JACK:** 3.5mm stereo connector for connecting to an assisted listening device (ALD) or to a computer for recording.
8. **MIC 1 & MIC 2:** Microphone link and registration indicators.
  - a. Solid green indicates an audio link has been established.
  - b. Flashing amber indicates registration is in process.
9. **SYSTEM ID LABEL:** On bottom of unit (not shown) to identify it with registered components.



# REAR PANEL CONTROLS AND CONNECTIONS

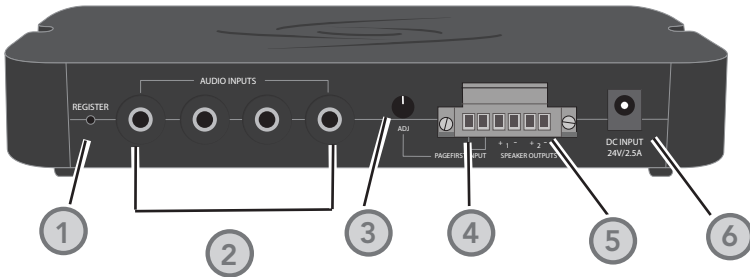

- 1. REGISTRATION:** Press this button if there is a new component, such as a microphone, to be registered.
- 2. AUDIO INPUTS:** 3.5mm stereo connectors for connecting classroom audio sources to be played through audio system.
- 3. PAGING ADJ:** Use the ADJ control to adjust the sensitivity of PageFirst if needed.
- 4. PAGEFIRST INPUT:** Connect the input from the optional PageFirst sensor here when interfacing with a building's paging system.

- 5. SPEAKER OUTPUTS:** This euro-block connector is used to connect the 955 Access to the loudspeaker(s). Up to two 8-ohm speakers can be connected to each output.

Note: Wiring to these terminals should follow the Class 2 wiring methods as outlined in the National Electric Code.

- 6. DC POWER:** Plug the power supply (24V/2.5A) into this jack.

5. Warranty, Safety & Specifications

4. Maintenance & Troubleshooting

3. Optional Accessories

2. Set Up & Use / Daily Operation

1. Overview

# FLEXMIKE CONTROLS AND CONNECTIONS

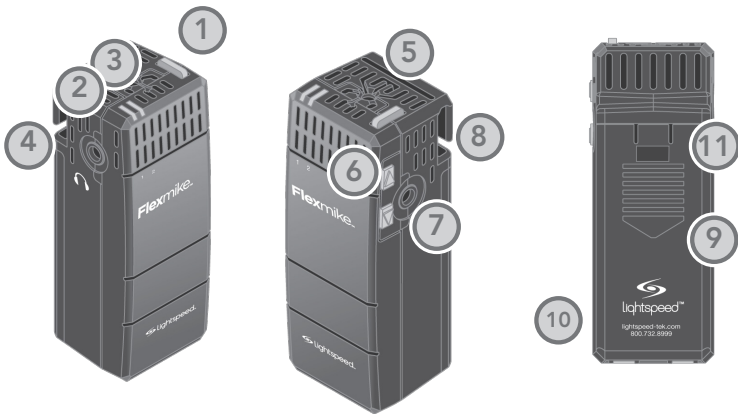

1. **POWER/MUTE SWITCH:** press and hold to power on, press to mute, press and hold to power off.
2. **MIC 1 STATUS:** lighted to indicate microphone is registered as MIC 1
  - Blue: solid = normal operation; Blue: flashing = linking in progress
  - Red: solid = muted; Red: flashing = muted while linking in progress
3. **MIC 2 STATUS:** when using a second microphone, this LED is lighted to indicate microphone is registered as MIC 2 (same behavior as MIC 1 status light above)
4. **EARBUD CONNECTION\*:** connect the earbud for monitoring (\*for use with Flexcat Pods only)
5. **CHARGING/LOW BATTERY INDICATOR:** lights red when charging, green when fully charged. When in operation, turns red to indicate low battery.
6. **MICROPHONE VOLUME UP/DOWN**
7. **AUDIO INPUT:** connect audio source to send to 955 Access
8. **LANYARD INTERFACE:** insert the lanyard into this hook to wear the Flexmike.
9. **BATTERY DOOR:** remove the battery door to replace the rechargeable battery pack
10. **REGISTRATION:** (inside battery compartment - not shown) only used when adding or replacing Flexmike.
11. **SYSTEM ID LABEL**

SECTION 2:

# DAILY OPERATION



1. Overview

2. Set Up & Use /  
Daily Operation

3. Optional Accessories

4. Maintenance &  
Troubleshooting

5. Warranty, Safety  
& Specifications

# 1. CHARGING THE FLEXMIKE

Before use, the Flexmike should be charged. It will take 8-9 hours for the Flexmike to obtain a full charge. A fully charged Flexmike will last for up to 8 hours of use. If microphones are used daily, they should be charged each night – microphones can be left charging constantly for up to 2 weeks without causing degradation to battery life.

When plugged into a charger, a red light on the Flexmike indicates the battery pack is charging. A green light indicates that charging is complete and a full charge has been reached. See Troubleshooting section for more information.

Replacement NiMH battery packs may only be purchased through Lightspeed Technologies (part # NH2.4V). Do not attempt to charge with other battery packs. They can overheat and expand creating a significant hazard and damaging the microphone (this is not covered by warranty).

1. Plug wall charger into an electrical outlet.
2. Plug the USB charging cable(s) into the wall charger.
3. Plug the micro USB end of the charging cable into USB port on the bottom of the Flexmike.
4. The charging light on top of the Flexmike will turn red to indicate charging is in progress.
5. When the Flexmike is fully charged, the light on the mic will change to green.

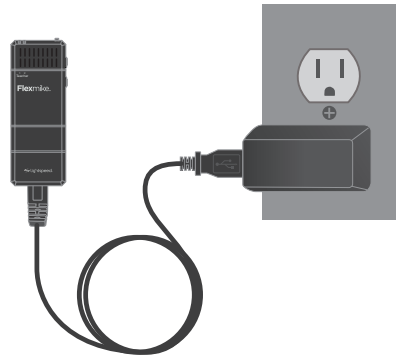

6. Hang the Flexmike on the lanyard opposite the magnetic clasp.

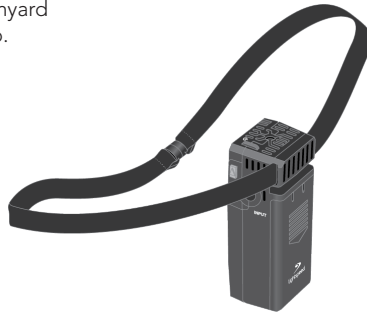

## 2. OPERATING THE FLEXMIKE

Once the Flexmike is charged, follow these steps to set it up for use.

1. Remove the Flexmike from the charging cable and put it on by connecting the magnetic clasps behind your neck. The Flexmike will automatically power on and mute when it is removed from the charger. This will automatically power on the 955 Access as well.
2. The microphone volume on the Flexmike is set at the factory to the mid point.
3. While speaking in a normal voice, fine-tune the microphone volume on the front of the 955 Access up or down. Proper volume level should be as follows:
  - Your voice should be clearly heard by another person on the other side of the room.
  - You should barely be able to hear your own voice.
  - There should not be any audio “feedback” or squealing outside of 2-3 feet (if there is, turn the volume down slightly).

**REMEMBER:** This equipment supplements the user’s voice so they are able to speak in a conversational tone. Having the volume set too high will result in feedback and listener fatigue.

4. Once initial volume level is set, walk around the room and listen for overall audio quality.
5. If further fine-tuning is required, you may need to adjust the Tone Control on the front of the 955 Access.



5. Warranty, Safety & Specifications

4. Maintenance & Troubleshooting

3. Optional Accessories

2. Set Up & Use / Daily Operation

1. Overview

### 3. USING FLEXMIKE AS WIRELESS AUDIO LINK

The Flexmike includes a 3.5mm audio input jack to connect to an audio source like a laptop or MP3 player. The Flexmike will transmit the audio signal to be played through the system.

If your system includes two Flexmikes, you can use one mic for instruction and the second mic to transmit audio through the system.

1. Plug your external audio equipment (for example, laptop), into the input on the Flexmike labeled "INPUT" using a 3.5mm patch cable (not included).

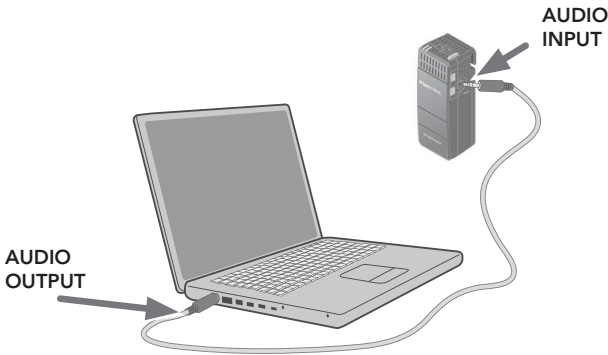

## 4. OUTPUT TO PERSONAL ASSISTIVE LISTENING DEVICE (ALD)

1. Turn the AUDIO OUT volume control on the front panel all the way down (fully counterclockwise).
2. Determine the size and type of audio input jack on the device as many manufacturers' products differ in connector size and shape. Many Personal FM transmitters require a 3.5 mm to 3.5 mm patch cable (part# MSC3535, not included).
3. Connect a patch cable from the personal FM's microphone jack or AUX input to AUDIO OUT jack on the 955 Access:

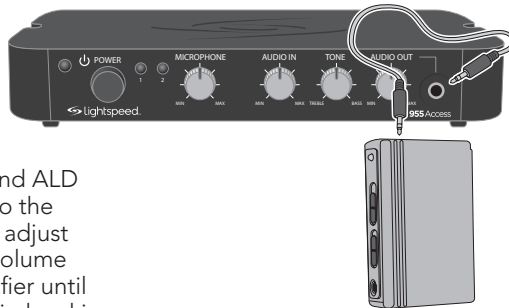

4. With the amplifier and ALD turned on, speak into the Flexmike and slowly adjust the corresponding volume control on the amplifier until the appropriate audio level is obtained in the Personal FM receiver.
5. It may be necessary to adjust the volume on the Personal FM receiver to achieve appropriate volume level.

5. Warranty, Safety & Specifications

4. Maintenance & Troubleshooting

3. Optional Accessories

2. Set Up & Use / Daily Operation

1. Overview

# DAILY OPERATION INSTRUCTIONS

## 1. At start of day, unplug the microphone from the charging cable and put on.

- The microphone will default to the Mute position, the status will turn to red.
- Place the microphone around your neck.
- Press the power/mute button, the light will turn blue, indicating the microphone is active and ready to use.
- Adjust volume with the UP/DOWN buttons if necessary.
- If Flexmike needs to be powered down for some time, press and hold the power button. To power Flexmike again, press and hold the power button until the blue light begins to blink.



## 2. Private conversations.

- Mute the Flexmike during private conversations by momentarily pressing the power button. When muted, the blue light turns red.
- When conversation is over, momentarily press the power button again to unmute the Flexmike.

## 3. End of day.

- Remove the Flexmike from around your neck.
- Plug the Flexmike into the charging cable and ensure the wall charger is plugged in to an outlet.
- The Flexmike will stay powered on during charging, but will automatically be muted.
- It is not necessary to turn off the 955 Access as it will automatically power down after 2 hours without activity.
- If you do want to manually power it down, press and hold the power button on the front of the 955 Access. If the 955 Access is powered down, then when Flexmike is removed from charging the next day, it will automatically power the 955 Access on.





## SECTION 3:

# OPTIONAL ACCESSORIES

## SHAREMIKE: CONTROLS & CONNECTIONS

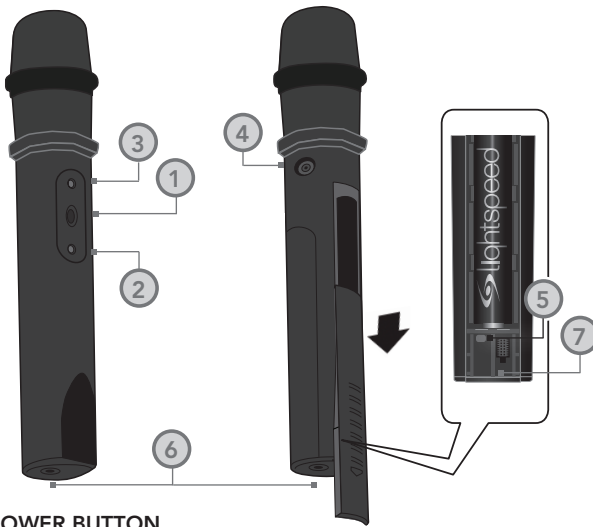

### 1. POWER BUTTON

**2. MIC 2 LIGHT:** This light indicates operation status when ShareMike is registered as MIC 2 (Standard)

- Blue: solid = normal operation; blinking - link in process
- Red: solid = muted

**3. MIC 1 LIGHT:** This light indicates battery/charging status when ShareMike is registered as MIC 2

- Red: flashing = low battery
- Red: solid = charging
- Green: solid = charging complete

**NOTE:** The functions of these lights are reversed when a ShareMike is registered as MIC 1.

**4. AUDIO INPUT:** plug a laptop, MP3 player or other audio device into this jack to wirelessly transmit the audio signal to be played through the system.

**5. REGISTRATION BUTTON:** Located in the battery compartment, only used when adding or replacing ShareMike.

**6. CHARGER INPUT:** Plug the charging cable from the ShareMike charger into this jack.

### 7. SYSTEM ID LABEL

## SHAREMIKE: CHARGING

1. Make sure the charger is plugged into a wall outlet. Connect one end of the charging cable into the jack labeled CHARGE on the bottom of the Sharemike.
2. Plug the other end into the USB jack of the wall charger.
3. If the Sharemike is registered as MIC 2, the MIC 1 light on the microphone will glow red to indicate charging.
4. Leave the Sharemike plugged in overnight (8-10 hours) to obtain a full charge. The light will turn green when charging is complete.
5. If Sharemike is registered as MIC 1, low battery and charging indicator will be the MIC 2 light.
6. During charging the blue light will stay on.



**PLEASE NOTE:** *The Access Link and Microphone(s) are registered together at the factory. If you have purchased a Sharemike with your Access Link, keep all components together as a system. Moving them from one system, or room, to another will result in the need to re-register.*

# SHAREMIKE: INITIAL SET-UP

1. Ensure the 955 Access is on. The blue light on the front of the 955 Access will glow.
2. Turn on the ShareMike by pressing and holding the power button until the LED lights.
3. Grip the barrel in the center section.
4. While speaking in a normal voice, increase the volume on the 955 Access MICROPHONE VOLUME knob until your voice is barely audible.

**REMEMBER:** This equipment is designed to supplement and distribute the user's voice so they are able to speak in a conversational tone. Having the volume set too high will result in feedback and listener fatigue.



5. Warranty, Safety & Specifications

4. Maintenance & Troubleshooting

3. Optional Accessories

2. Set Up & Use / Daily Operation

1. Overview

## OPTIONAL PAGEFIRST KIT

This optional feature for 955 Access interfaces with an independent classroom paging system. When the page is broadcast, all audio from the system is muted, ensuring important school-wide messages are never missed. Please note that PageFirst is not compatible with telephone or IP-based paging systems.

How it works:

1. PageFirst sensor clip is hung around a lead wire attached to the classroom paging speaker.
2. The clip is hard-wired to the amplifier.
3. As a page is broadcast, the sensor clip detects the audio signal through induction and immediately mutes the amplifier.
4. When the page is over, the audio from the amplifier returns to normal volume level.

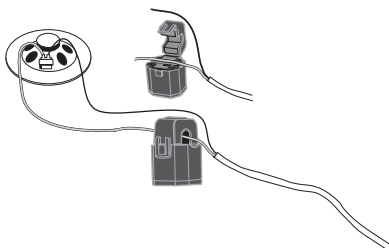

## MEDIA CONNECTOR CONTROLS AND CONNECTIONS

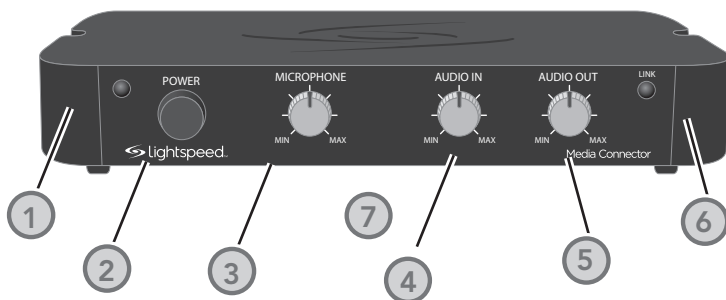

1. **POWER LIGHT:** This light will turn blue when power is on.
2. **POWER BUTTON:** Press and hold this pushbutton to turn the system power on or off.
3. **MICROPHONE VOLUME CONTROL:** Controls the volume level of the microphones.
4. **AUDIO IN VOLUME CONTROL:** Controls the volume level of the connected audio sources.
5. **AUDIO OUT VOLUME CONTROL:** Adjusts the audio signal level output through the ALD audio output connector.
6. **AUDIO LINK LIGHT:** The green light blinks when a link is being established. The light is solid green when the link is established.
7. **SYSTEM ID LABEL:** On bottom of unit

# MEDIA CONNECTOR CONTROLS AND CONNECTIONS CONT'D

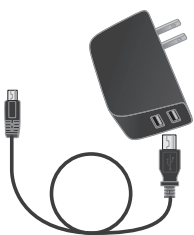
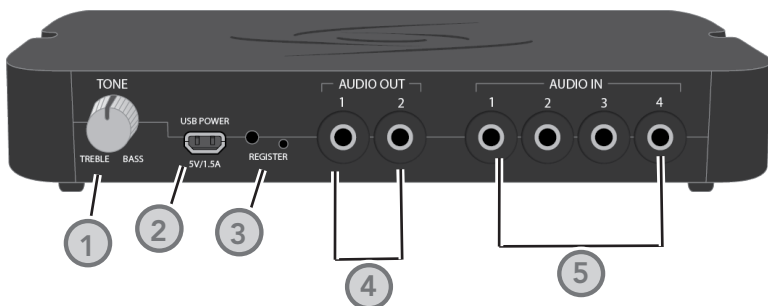

USB power adaptor and charging cable

- 1. TONE CONTROL:** Adjusts the audio tone, adding more bass or treble for a more rich or crisp sounds.
- 2. USB POWER INPUT:** Plug the micro USB end of the power cable into this USB port.
- 3. REGISTRATION PUSHBUTTON & LIGHT:** Pushing the registration button in conjunction with the registration button on the 955 Access will cause the two units to synchronize as an operating system. The registration light stops blinking and the link light is solid when a link is established. This is only used when adding or replacing a Media Connector.
- 4. TWO AUDIO OUTPUTS:** 3.5mm stereo jacks send audio signal to external equipment such as a recorder or an assistive listening device.
- 5. FOUR AUDIO INPUTS:** Connect standard audio devices to any of the 3.5mm stereo inputs. A provided cable allows connectivity to RCA stereo outputs common on DVD players and televisions.

# USING THE MEDIA CONNECTOR

The Media Connector, when paired together with the system, becomes the primary volume control for the microphones and audio sources you've connected.

1. Plug the micro USB end of the power cable into the USB port on the back of the Media Connector. Plug the other end of the cable into the USB power adaptor. Alternatively, the USB cable could be plugged into a computer for power.
2. Connect the audio source(s) to the Media Connector using the 3.5mm cables provided.
3. Set the audio source volume to provide sound through the audio system.
4. Use the AUDIO IN volume control on the front of the Media Connector to increase or decrease the audio source sound level.

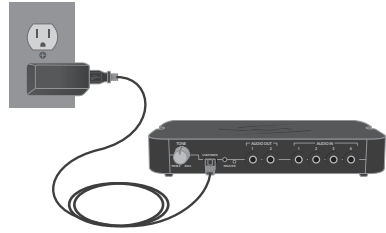

NOTE: when a Media Connector is paired with a 955 Access, microphone volume and tone control levels are locked out. Microphone volume and tone control levels default to the Media Connector controls to avoid multiple control points for the same functions.

## NORMALIZING AUDIO SOURCE VOLUME LEVELS

Use the Media Connector as the master audio volume control for the classroom. When two or more audio sources are connected, you will need to normalize volume settings by setting all connected audio sources to the same sound level while leaving the Media Connector AUDIO IN volume control set to its center setting. The Media Connector is an audio mixer using a master volume control to adjust the volume of all audio sources at once. Use the following procedure to set audio source volumes:

1. Connect the multimedia audio sources to the Media Connector using the 3.5mm cables provided.
2. Set the AUDIO IN volume control on the Media Connector to its center position.
3. Turn on an audio source that does not have an accessible audio level control. (DVD, VCR player)
4. Adjust the Media Connector AUDIO IN volume control so the audio level playing through the speaker is appropriate for the classroom.
5. Turn off the first audio source.
6. Turn on the second audio source. Use its volume control to balance the audio output to the same audio level played through the speaker as the first source.
7. Repeat steps 5 and 6 for the remaining audio sources.
8. Now, the Media Connector's AUDIO IN volume can be used to increase or decrease the volume level for all audio sources as desired.

# OPTIONAL MEDIA CONNECTOR: Audio Integration

The MCA is designed to integrate with the 955 Access and multiple audio sources, allowing other instructional technologies to be clearly heard throughout the classroom.

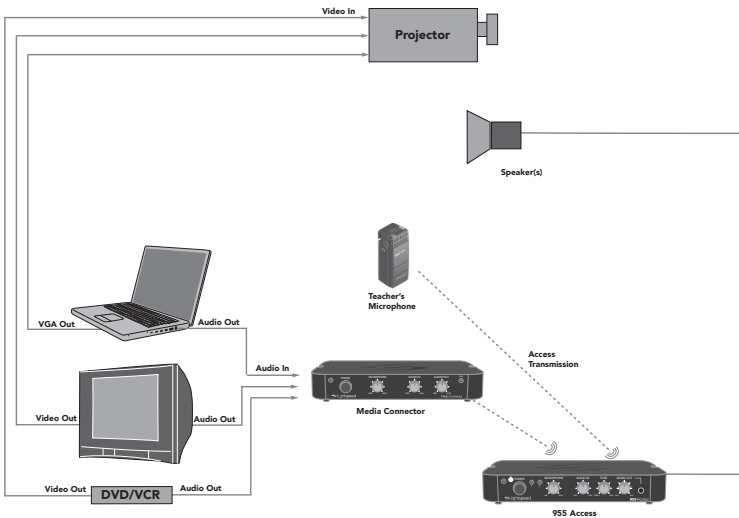

## OTHER OPTIONAL ACCESSORIES

TK250F	Noise-canceling headset microphone
MSC3535	3.5mm to 3.5mm stereo audio cable
PFSC50	PageFirst Sensor Clip with speaker wire

5. Warranty, Safety & Specifications

4. Maintenance & Troubleshooting

3. Optional Accessories

2. Set Up & Use / Daily Operation

1. Overview

## FLEXCAT AUDIO PODS FOR SMALL GROUP INSTRUCTION

Flexcat is a flexible two-way communication system that can be seamlessly added to the 955 Access classroom audio system to foster and facilitate small group instruction. With the small group audio pods and remote, Flexcat opens up communication and interaction between the teacher and student groups, including:

- Teacher monitoring of individual small groups
- Direct instruction to each independent group
- Student group sharing with the whole class
- Reinforce and redirect group activities

If your 955 Access system was configured with Flexcat pods, please refer to the Flexcat user guide for operation and setup instructions.

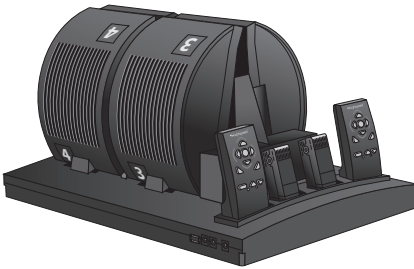



## SECTION 4:

# MAINTENANCE & TROUBLESHOOTING

## BATTERY REPLACEMENT

### Replacement of battery pack in Flexmike. (Part # NH2.4V)

1. Slide the battery door open.
2. Carefully pull the battery pack away from the Flexmike and disconnect the cable.



3. Connect the cable of the new battery pack as shown and insert the battery pack into the compartment.
4. Slide the cover back on and snap into place.
5. Connect the Flexmike to a charging cable and plug into the wall charger to charge the battery pack.

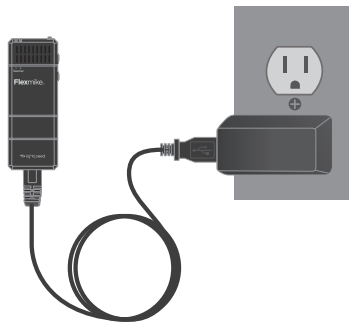

5. Warranty, Safety & Specifications

4. Maintenance & Troubleshooting

3. Optional Accessories

2. Set Up & Use / Daily Operation

1. Overview

## BATTERY REPLACEMENT, CONT'D

### Replacement of battery pack in Sharemike. (Part # NH2APK)

1. Slide the battery door open.
2. Carefully remove the battery pack from the Sharemike.



3. Insert the new battery pack into the compartment. Ensure proper polarity is observed.
4. Slide the cover back on and snap into place.
5. Connect the Sharemike to a charging cable and plug into the wall charger to charge the battery pack.



# TROUBLESHOOTING

**Note:** Most problems are directly related to low battery power. Please run through the “Battery Check” items first. For remaining troubleshooting, use known good, fully-charged batteries.

**PROBLEM:** Most Problems are related to low battery power.

**SOLUTION:** Battery Check

- Confirm batteries are charged each night. A blinking red light on the power button indicates a low battery.
- Confirm proper batteries are used. The Flexmike requires the Lightspeed NH2.4V rechargeable battery pack. The Sharemike requires the Lightspeed BA-NH2APK rechargeable battery pack.
- Make sure the microphones obtain a full charge. A full charge takes 8-9 hours.
- When plugging the charging cable into the transmitter, ensure the red charging light turns on. The green light will turn on when a full charge is reached.

**PROBLEM:** Microphone doesn't indicate a “Ready” signal (solid blue or red light)

**SOLUTION:** Follow these steps to ensure the system is ready to use.

- Ensure the power button on the microphone is turned on. Once turned on, the blue light should begin blinking.
- Power the microphone off, then on again after a few seconds. Wait for up to 30 seconds for the blue light to turn solid, indicating READY for operation.

**PROBLEM:** Low Volume or Feedback

**SOLUTION:** Follow these steps to eliminate low volume or feedback.

- Check microphone volume level on the 955 Access. If the volume is too high, feedback will occur. Adjust accordingly.
- Check input volume level on the 955 Access. If the volume is too high, feedback will occur. Adjust accordingly.
- Adjust the volume level on the Flexmike.

**PROBLEM:** No Sound From speaker and wireless components.

**SOLUTION:** Follow these steps to produce sound from 955 Access.

- Confirm that the blue POWER light located on the front panel of the 955 Access is on.
- Confirm the microphone is powered on and linked to the 955 Access. The mic 1 status light will be green on the 955 Access indicating the microphone is linked.
- Confirm that the microphone is turned on. There will be a solid blue light on the top of microphone to indicate it is powered on and ready.

**If you review these instructions and still have questions, call Lightspeed Technical Services at 800.732.8999, 5 a.m. – 5 p.m., PST. Customers outside the U.S. should contact their local reseller.**

5. Warranty, Safety & Specifications

4. Maintenance & Troubleshooting

3. Optional Accessories

2. Set Up & Use / Daily Operation

1. Overview

## TROUBLESHOOTING CONT'D

- Confirm that microphone is not muted. A solid red light on the top of microphone will indicate it is muted.
- Check speaker connections on the 955 Access. Make sure the cables are properly connected (see page 9 of this manual or the Installation Guide for more information).
- Check volume level of 955 Access. Make sure that the microphone volume level on 955 Access is not turned down all the way. Slowly turn up the volume level while talking into the microphone.

## TIPS TO OBTAIN OPTIMUM AUDIO PERFORMANCE

- Speak in a natural voice. A normal conversational speech level will provide an adequate signal. It is not necessary to increase the intensity of your voice—the audio system provides adequate amplification (approximately 5 – 10 dB) above ambient room noises.
- Avoid wearing jewelry that may rub or bump against the microphone.
- Mute the Flexmike during private conversations with a student, parent, or other classroom visitor. You can tell the mic is muted when the light turns red.
- Recharge microphones each night. When recharged nightly, operating time (actual usage) for the microphones will last through a typical school day.

## SECTION 5:

# WARRANTY, SAFETY & SPECIFICATIONS

## FIVE-YEAR LIMITED WARRANTY

Lightspeed Classroom Audio Access Systems are guaranteed against malfunction due to defects in materials and workmanship for a period of FIVE (5) YEARS, beginning at the date of the purchase invoice. If such malfunction occurs, the product will be repaired or replaced (at Lightspeed's option) without charge during the warranty period.

Lightspeed's Warranty Exchange Program applies to all classroom audio systems within the five (5) year warranty period. If a classroom audio product or component has an issue that requires service, a refurbished replacement will immediately be sent to the customer to minimize downtime. Customers will receive the exchange product(s) or component(s) within 2-3 days. A prepaid return label will be included with exchanged products so original malfunctioned equipment can be returned to Lightspeed. Any exchanged equipment will remain covered under the original five (5) year warranty.

1. Warranty on Access microphones is FIVE (5) YEARS.
2. Warranty on Lightspeed NiMH rechargeable batteries is one (1) year.
3. A prepaid shipping label will be provided by Lightspeed for warranty repairs within the United States. Customers outside the U.S. should refer to the Lightspeed website ([www.lightspeed-tek.com](http://www.lightspeed-tek.com)) for warranty repair instructions.
4. Warranty does not extend to finish, appearance items, or malfunctions due to abuse or operation other than specified conditions, nor does it extend to incidental or consequential damages. Repair by other than Lightspeed or its authorized service agencies will void this warranty. Information on authorized service agencies is available from Lightspeed Technologies, Inc.

**Our Service Department (800.732.8999, 5 a.m. – 5 p.m., PST) will handle all your repair/replacement needs. Customers outside the U.S. should contact their local reseller.**

# SAFETY WARNINGS AND CERTIFICATIONS



The lightning flash with arrowhead symbol inside an equilateral triangle is intended to alert the user to the presence of non insulated "hazardous voltage" within the product's enclosure, which may be of sufficient magnitude to induce a risk of electric shock to persons.



The exclamation mark inside an equilateral triangle is intended to alert the user to the presence of important operating and maintenance (servicing) instruction in the literature accompanying this product.



**USE A LIGHTSPEED  
SUPPLIED BATTERY ONLY**

## CERTIFICATIONS



This product is listed to UL standards and requirements for electrical safety by Underwriters Laboratories Inc.



This product conforms with the essential requirements of the following European Union Directives: 2004/108/EC Electromagnetic Compatibility (EMC) and 2006/95/EC Low Voltage Directive (LVD).



Lightspeed Technologies launched a formal product recycle program in Europe that complies with the European Union Directive 2002/96/EC on Waste Electrical and Electronic Equipment ("WEEE Directive"). Please visit our website at [www.Lightspeed-tek.com](http://www.Lightspeed-tek.com) for more information.



This product is manufactured using lead-free processes and is free of other materials harmful to the environment. It conforms to the most stringent new European guidelines for consumer products (RoHS).

# PRÉCAUTIONS DE SÉCURITÉ ET CERTIFICATIONS



**ATTENTION**  
RISQUE D'ÉLECTROCUTION  
NE PAS OUVRIR



**CONFORMÉMENT AUX NORMES D'INSTALLATION APPLICABLES, CE PRODUIT DOIT ÊTRE INSTALLÉ PAR UNE PERSONNE FAMILIARISÉE AVEC LA CONCEPTION ET LE FONCTIONNEMENT DU PRODUIT ET CONSCIENTE DES RISQUE ENCOURUS.**



L'éclair flèche dans un triangle équilatéral avertit l'utilisateur de la présence d'une "tension dangereuse" non isolée à l'intérieur de l'appareil, qui peut être d'une ampleur suffisante pour constituer un risque d'électrocution.



Le point d'exclamation contenu dans un triangle équilatéral avertit l'utilisateur de la présence d'importantes instructions d'exploitation et de maintenance dans la documentation qui accompagne ce produit.



**UTILISEZ UNIQUEMENT LA BATTERIE LIGHTSPEED FOURNIE**

## CERTIFICATIONS



Ce produit est certifié conforme aux normes et aux exigences UL en matière de sécurité électrique par Underwriters Laboratories Inc.



Ce produit est conforme aux principales exigences des directives de l'Union Européenne suivantes : 2004/108/EC Electromagnetic Compatibility (EMC) and 2006/95/EC Low Voltage Directive (LVD).



Lightspeed Technologies a lancé un programme de recyclage de produits en Europe conformément à la directive de l'Union Européenne 2002/96/CE relative aux déchets d'équipements électriques et électroniques (directive « DEEE »). Veuillez visiter notre page Web [www.Lightspeed-tek.com](http://www.Lightspeed-tek.com) pour plus de renseignements.



Ce produit est fabriqué en utilisant des processus sans plomb ni aucune autre matière nuisible à l'environnement. Il est conforme aux nouvelles règles européennes les plus strictes en matière de biens de consommation (RoHS).

## FCC Notice to user

This device complies with Part 15 of the FCC Rules. Operation is subject to the following two conditions:

- (1) This device may not cause harmful interference; and
- (2) This device must accept any interference received, including interference that may cause undesired operation.

This equipment has been tested and found to comply with the limits for a Class B digital device, pursuant to Part 15 of the FCC Rules. These limits are designed to provide reasonable protection against harmful interference in a residential installation.

This equipment generates, uses, and can radiate radio frequency energy and, if not installed and used in accordance with the instructions, may cause harmful interference to radio communications. However, there is no guarantee that interference will not occur in a particular installation.

If this equipment does cause harmful interference to radio or television reception, which can be determined by turning the equipment off and on, the user is encouraged to try to correct the interference by one or more of the following measures:

- Reorient or relocate the receiving antenna (that is, the antenna for radio or television that is receiving the interference).
- Reorient or relocate and increase the separation between the telecommunications equipment and receiving antenna.
- Connect the telecommunications equipment into an outlet on a circuit different from that to which the receiving antenna is connected.

## FCC RF Radiation Exposure Statement

This device (Access Link) complies with the FCC RF radiation exposure limits set forth for an uncontrolled environment. This device should be installed and operated with a minimum distance of 20cm between the radiator (Access Link) and any part of your body.

For body worn operation, the portable part (Flexmike) has been tested and meets FCC RF exposure guidelines.

This device must not be co-located or operating in conjunction with any other antenna or transmitter. The changes or modifications not expressly approved by the party responsible for compliance could void the user's authority to operate the equipment.

## Notice to Canada User

### English

This device complies with Industry Canada licence exempt RSS standard(s).

Operation is subject to the following two conditions:

- (1) this device may not cause interference, and
- (2) this device must accept any interference, including interference that may cause undesired operation of the device.

### French

Le présent appareil est conforme aux CNR d'Industrie Canada applicables aux appareils radio exempts de licence.

L'exploitation est autorisée aux deux conditions suivantes :

- (1) l'appareil ne doit pas produire de brouillage, et
- (2) l'utilisateur de l'appareil doit accepter tout brouillage radioélectrique subi, même si le brouillage est susceptible d'en compromettre le fonctionnement

## RF Radiation Exposure Statement

### English

Your mobile device is a radio transmitter and receiver. It is designed not to exceed the limits for exposure to radio waves (radio frequency electromagnetic fields) recommended by international guidelines. The guidelines were developed by Health Canada and include a substantial safety margin designed to assure the safety of all persons, regardless of age and health.

### French

Votre appareil mobile est un émetteur-récepteur radio. Il est conçu pour ne pas dépasser les limites d'exposition aux ondes radio (champs électromagnétiques de fréquence radio) recommandées par les directives internationales. Les lignes directrices ont été élaborées par Santé Canada et comprennent une marge de sécurité importante destinée à assurer la sécurité de toutes les personnes, indépendamment de l'âge et de la santé.



## NOTICE FOR USB

NOTE: Lightspeed is not responsible for any changes or modifications not expressly approved by the party responsible for compliance. Such modifications could void the user's authority to operate the equipment.

NOTE: This equipment has been tested and found to comply with the limits for a Class B digital device, pursuant to part 15 of the FCC Rules. These limits are designed to provide reasonable protection against harmful interference in a residential installation. This equipment generates, uses and can radiate radio frequency energy and, if not installed and used in accordance with the instructions, may cause harmful interference to radio communications. However, there is no guarantee that interference will not occur in a particular installation. If this equipment does cause harmful interference to radio or television reception, which can be determined by turning the equipment off and on, the user is encouraged to try to correct the interference by one or more of the following measures:

- Reorient or relocate the receiving antenna.
- Increase the separation between the equipment and receiver.
- Connect the equipment into an outlet on a circuit different from that to which the receiver is connected.
- Consult the dealer or an experienced radio/TV technician for help.

## EU DECLARATION OF CONFORMITY



### EU Declaration of Conformity According to EC LVD Directive 2006/42/EC

**Manufacturer:** Lightspeed Technologies, Inc.

**Address:** 11509 SW Herman Rd,  
Tualatin, Oregon 97062

*We herewith declare that the following systems comply with the appropriate basic safety and health requirements of the Directive based on its design and type, as brought into circulation by us. In case of alteration of the system, not agreed upon by us, this declaration will lose its validity.*

**Products:** Redcat Access, Flexmike, Flexcat Pod, Flexcat Charging Station,  
Flexcat Hand Remote Control, Media Connector Access, Sharemike, Topcat, Access Link

**Model Numbers:** LSRCA 1881, LSFM 1881, FCP 1881, FCCS, FCHRC, LSMCA 1881,  
LSSM 1881, LSTCA 1881, LSAL 1881

As appropriate, products conform to the following EU standards listed:

**Safety Standards:** IEC/EN 60065 and amendments

**EMC/RF Standards:** EN301 406 V2.1 (2009-07)

EN 301489-1/-6  
EN 301489-1/-17  
EN 50371 (2002)  
EN 50385 (2002)  
EN 300 328  
EN 55022  
EN 55024  
AS/NZ CISPER 22  
AS/NZ 4268

The Technical Construction File is available to proper authorities and the product is CE marked.

Lightspeed Representative:

Michael Frost, Compliance Engineer

Date: 02/18/2015



P/N: 085-0013-02

LIGHTSPEED TECHNOLOGIES / 11509 SW HERMAN ROAD / TUALATIN, OR 97062 / 800.732.8999 / WWW.LIGHTSPEED-TEK.COM

5. Warranty, Safety  
& Specifications

4. Maintenance &  
Troubleshooting

3. Optional Accessories

2. Set Up & Use /  
Daily Operation

1. Overview

## SYSTEM SPECIFICATIONS

### 955 ACCESS

Frequency response:	120 Hz - 8 kHz
DC power Input:	24V/2.5A
Power output:	40 Watts total (20 W/channel)
Total harmonic distortion	<1% @ 10W
Wireless communication:	Access Technology (1.9 GHz + RF4CE)
Tone control:	1 bass/treble control
Audio inputs:	Four (4) 3.5mm stereo w/ volume control
Audio output:	3.5mm stereo w/ volume control
PageFirst input:	Euroblock
Audio Link indicators:	2 indicators for Flexmike 1 and 2
Device Registration:	Push button for pod(s), Flexmike(s), Sharemike, Media Connector, and remote(s)
Dimensions (W x H x D):	7.6" x 5" x 1.13" (193 x 127 x 29mm)
Weight:	9.6 oz. (272g)

### FLEXMIKE (1-2):

Description:	pendant-style microphone
Earbud lanyard:	magnetic clasp with integrated earbud
Wireless communication:	Access Technology (1.9 GHz)
Audio distortion:	<1%
Integrated microphone:	uni-directional electret
Earbud output:	3.5mm
Audio input:	3.5mm
Volume control:	+/- 6 dB
Battery power:	2.5V NiMH battery pack
Battery life:	8 hours (fully charged)
Charging:	2 contacts for cradle charging
USB connection:	type Micro-B for charging and audio
Power:	on/off switch
Registration:	push button for registration with Access Link
Dimensions (L x W x H):	2.9" x 1.1" x 1.0" (74 x 28 x 25mm)
Weight:	1.8 oz (51g)

## SHAREMIKE

Description:	Handheld microphone
Wireless communication:	Access Technology (1.9 GHz)
Audio distortion:	<1%
Integrated microphone:	uni-directional dynamic
Audio input:	3.5mm
Battery power:	2 AA NiMH battery pack
Battery life:	8 hours (fully charged)
Charging:	5V charging jack
Power:	on/off button
Registration:	push button for registration with Access Link
Dimensions (L x W x H):	2.25" x 2.25" x 8.75" (57.2 x 57.2 x 222.3mm)
Weight:	7.36 oz (209g)

## MEDIA CONNECTOR

USB Power:	5V micro-B USB connector
Wireless communication:	Access Technology (1.9 GHz + RF4CE)
Tone control:	1 bass/treble control
Audio input:	3.5mm stereo (x4) w/ master volume
Audio output:	3.5mm stereo (X2) mixed w/ volume control
Audio Link indicator:	1 LED on front panel
Registration indicator	1 LED on back panel
Device Registration:	Push button for Access Link
Dimensions (W x H x D):	7.6" x 5" x 1.13" (193 x 127 x 29mm)
Weight:	9.6 oz. (272g)



A C - M N 9 5 5 A

**LIGHTSPEED TECHNOLOGIES**

11509 SW HERMAN ROAD / TUALATIN, OR 97062

TOLL FREE: 800.732.8999 / PHONE: 503.684.5538 / FAX: 503.684.3197

LIGHTSPEED-TEK.COM