



Shenzhen GTI Technology Co., Ltd.

1-2/F., Building 2, Jiaquan Building, Guanlan High-Tech Park, Shenzhen, Guangdong, China

Tel: +86-755- 27521059

Fax: +86-755- 27521011

TEST REPORT

Product Name : Bluetooth Speaker

Trademark : N.A

Model/Type reference : Mosaic

Listed Model(s) : N.A

FCC ID : OR8-MOSAIC

Test Standards : **FCC Part 15.247: Operation within the bands 902-928 MHz, 2400-2483.5 MHz and 5725-5850 MHz**

Report No. : GTI20180248F -2

Applicant : Microlab Electronics Co., Ltd

Address of applicant : South Baozi Rd., Shenzhen Microlab Industrial Park,
Shenzhen 518122, China

Date of Receipt : Feb. 18, 2018

Date of Test Date : Feb. 19, 2018- Feb. 28, 2018

Data of issue. : Mar. 02, 2018

Test result	Pass *
--------------------	---------------

* In the configuration tested, the EUT complied with the standards specified above

Shenzhen General Testing & Inspection Technology Co., Ltd.

1-2/F., Building 2, Jiaquan Building, Guanlan High-Tech Park, Shenzhen, Guangdong, China

Tel.: (86)755-27521059

Fax.: (86)755-27521011

Http://www.sz-ctc.org.cn



For anti-fake verification, please visit the official website of Certification and Accreditation Administration of the People's Republic of China : yz.cncaic.cn

GENERAL DESCRIPTION OF EUT	
Equipment:	Bluetooth Speaker
Model Name:	Mosaic
Manufacturer:	Microlab Electronics Co., Ltd
Manufacturer Address:	South Baozi Rd., Shenzhen Microlab Industrial Park, Shenzhen 518122, China
Power Rating:	Input:5VDC, 500mA (form PC)

Compiled By:



(Zaki Zhang)

Reviewed By:



(Gavin Shi)

Approved By:



(Walter Chen)

This test report may be duplicated completely for legal use with the approval of the applicant. It should not be reproduced except in full, without the written approval of our laboratory. The client should not use it to claim product endorsement by GTI. The test results in the report only apply to the tested sample. The test report shall be invalid without all the signatures of testing engineers, reviewer and approver. Any objections must be raised to GTI within 15 days since the date when the report is received. It will not be taken into consideration beyond this limit.

Shenzhen General Testing & Inspection Technology Co., Ltd.

1-2/F., Building 2, Jiaquan Building, Guanlan High-Tech Park, Shenzhen, Guangdong, China

Tel.: (86)755-27521059

Fax.: (86)755-27521011

Http://www.sz-ctc.org.cn

Table of Contents

Page

1. SUMMARY	4
1.1. TEST STANDARDS.....	4
1.2. TEST DESCRIPTION.....	4
1.3. TEST FACILITY	5
1.4. MEASUREMENT UNCERTAINTY	5
2. GENERAL INFORMATION	6
2.1. ENVIRONMENTAL CONDITIONS	6
2.2. GENERAL DESCRIPTION OF EUT	6
2.3. DESCRIPTION OF TEST MODES	7
2.1. MEASUREMENT INSTRUMENTS LIST	8
3. TEST CONDITIONS AND RESULTS	9
3.1. CONDUCTED EMISSION MEASUREMENT.....	9
3.2. RADIATED EMISSION	13
3.3. MAXIMUM CONDUCTED OUTPUT POWER.....	16
3.4. POWER SPECTRAL DENSITY	18
3.5. 6dB BANDWIDTH.....	20
3.6. BAND EDGE COMPLIANCE OF RF EMISSION.....	23
3.7. ANTENNA REQUIREMENT.....	27
4. EUT TEST PHOTO	28
5. PHOTOGRAPHS OF EUT CONSTRUCTIONAL	29

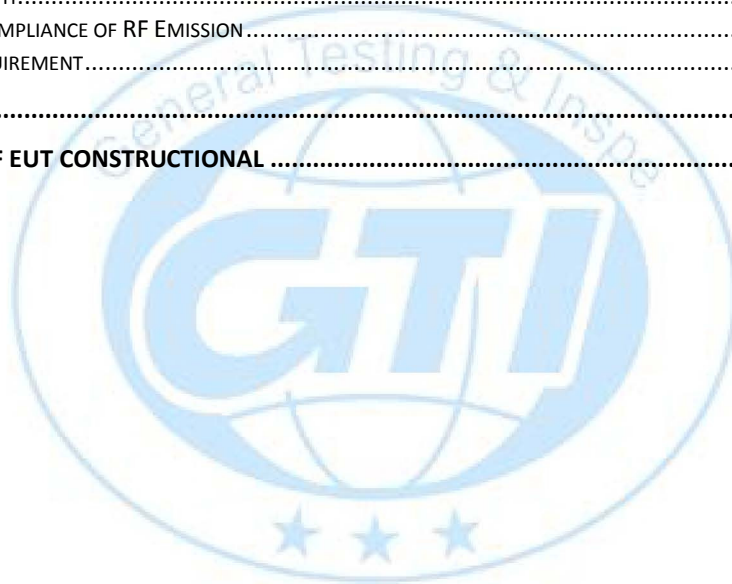

1. SUMMARY

1.1. Test Standards

The tests were performed according to following standards:

FCC Rules Part 15.247: Frequency Hopping, Direct Spread Spectrum and Hybrid Systems that are in operation within the bands of 902-928 MHz, 2400-2483.5 MHz, and 5725-5850 MHz

ANSI C63.10-2013: American National Standard for Testing Unlicensed Wireless Devices

558074 D01 DTS Meas Guidance v01: Guidance for Performing Compliance Measurements on Digital Transmission Systems (DTS) Operating Under §15.247

1.2. Test Description

FCC PART 15 15.247		
FCC Part 15.207	AC Power Conducted Emission	PASS
FCC Part 15.247(a)(2)	6dB Bandwidth	PASS
FCC Part 15.247(d)	Spurious RF Conducted Emission	N/A
FCC Part 15.247(b)	Maximum Peak Output Power	PASS
FCC Part 15.247(e)	Power Spectral Density	PASS
FCC Part 15.205/ 15.209	Radiated Emissions	PASS
FCC Part 15.247(d)	Band Edge	PASS
FCC Part 15.203/15.247 (b)	Antenna Requirement	PASS

.Note 1:EUT is battery power supply. conducted emission is not need

1.3. Test Facility

1.3.1 Address of the test laboratory

Shenzhen General Testing & Inspection Technology Co., Ltd.

Add: 1-2/F., Building 2, Jiaquan Building, Guanlan High-Tech Park, Shenzhen, Guangdong, China

1.3.2 Laboratory accreditation

The test facility is recognized, certified, or accredited by the following organizations:

IC Registration No.: 9783A

The 3m alternate test site of Shenzhen GTI Technology Co., Ltd. EMC Laboratory has been registered by Certification and Engineer Bureau of Industry Canada for the performance of with Registration NO.: 9783A on Jan, 2016.

FCC-Registration No.: 951311

Shenzhen GTI Technology Co., Ltd. EMC Laboratory has been registered and fully described in a report filed with the (FCC) Federal Communications Commission. The acceptance letter from the FCC is maintained in our files. Registration 951311, Aug 26, 2017

1.4. Measurement Uncertainty

The data and results referenced in this document are true and accurate. The reader is cautioned that there may be errors within the calibration limits of the equipment and facilities. The measurement uncertainty was calculated for all measurements listed in this test report acc. to CISPR 16 - 4 Specification for radio disturbance and immunity measuring apparatus and methods – Part 4: Uncertainty in EMC Measurements and is documented in the Shenzhen General Testing & Inspection Technology Co., Ltd quality system acc. to DIN EN ISO/IEC 17025. Furthermore, component and process variability of devices similar to that tested may result in additional deviation. The manufacturer has the sole responsibility of continued compliance of the device.

Hereafter the best measurement capability for General Testing & Inspection laboratory is reported:

Test Items	Measurement Uncertainty	Notes
Transmitter power conducted	0.57 dB	(1)
Transmitter power Radiated	2.20 dB	(1)
Conducted spurious emission 9KHz-40 GHz	1.60 dB	(1)
Radiated spurious emission 9KHz-40 GHz	2.20 dB	(1)
Conducted Emission 9KHz-30MHz	3.39 dB	(1)
Radiated Emission 30~1000MHz	4.24 dB	(1)
Radiated Emission 1~18GHz	5.16 dB	(1)
Radiated Emission 18-40GHz	5.54 dB	(1)
Occupied Bandwidth	-----	(1)

(1) This uncertainty represents an expanded uncertainty expressed at approximately the 95% confidence level using a coverage factor of k=1.96.

2. GENERAL INFORMATION

2.1. Environmental conditions

During the measurement the environmental conditions were within the listed ranges:

Temperature:	15~35°C
Relative Humidity:	30~75 %
Air Pressure:	950~1050mba

2.2. General Description of EUT

Product Name:	Bluetooth Speaker
Model/Type reference:	Mosaic
Power supply:	Input:5VDC, 500mA (form PC)
Hardware version:	V1.1
Software version:	V1.1
Bluetooth:	
Supported type:	Version 4.0 for low Energy
Modulation:	GFSK
Operation frequency:	2402MHz to 2480MHz
Channel number:	40
Channel separation:	2 MHz
Antenna type:	PCB Antenna
Antenna gain:	0dBi

Note: For a more detailed features description, please refer to the manufacturer's specifications or the User's Manual.

2.3. Description of Test Modes

Peripherals Devices:

OUTSIDE SUPPORT EQUIPMENT						
No.	Equipment	Model	Serial No.	Manufacture	Trade name	Remark
1	AC Adapter	FJ-SW0504 000U	/	SHENZHEN FUJIA APPLANCE CO.,LTD	/	Input:100-240V, 50/60Hz, 1.5A MAX Output: 5V, 4A
2	phone	iPhone 6 plus	A1524	Apple	Apple	/

Note: All the above equipment /cable were placed in worse case position to maximize emission signals during emission test.

Operation Frequency

The Applicant provides communication tools software to control the EUT for staying in continuous transmitting (Duty Cycle more than 98%) mode for testing.

BT 4.0

Channel	Frequency (MHz)
00	2402
02	2404
03	2406
:	:
20	2442
:	:
37	2476
38	2478
39	2480

2.1.Measurement Instruments List

Maximum Conducted Output Power					
Item	Test Equipment	Manufacturer	Model No.	Serial No.	Calibrated until
1	Power Meter	Anritsu	ML2487B	110553	Jan. 04,2019
2	Power Sensor	Anritsu	MA2411B	100345	Jan. 04,2019
3	Spectrum Analyzer	R&S	FSU26	100105	Jan. 04,2019

Power Spectral Density / 6dB Bandwidth / Band Edge Compliance of RF Emission / Spurious RF Conducted Emission					
Item	Test Equipment	Manufacturer	Model No.	Serial No.	Calibrated until
1	Spectrum Analyzer	R&S	FSU26	100105	Jan. 04,2019

Conducted Emission					
Item	Test Equipment	Manufacturer	Model No.	Serial No.	Calibrate until
1	LISN	R&S	ENV216	101112	Jan. 04,2019
2	LISN	R&S	ENV216	101113	Jan. 04,2019
3	EMI Test Receiver	R&S	ESCI	100920	Jan. 04,2019
4	Cable	Schwarzbeck	AK9515E	33156	Jan. 04,2019

Radiated Emission					
Item	Test Equipment	Manufacturer	Model No.	Serial No.	Calibrated until
1	EMI Test Receiver	R&S	ESCI	100658	Jan. 04,2019
2	High pass filter	micro-tranics	HPM50111	34202	Jan. 04,2019
3	Log-Bicon Antenna	Schwarzbeck	CBL6141A	4180	Jan. 04,2019
4	Ultra-Broadband Antenna	ShwarzBeck	BBHA9170	25841	Jan. 04,2019
5	Loop Antenna	LAPLAC	RF300	9138	Jan. 04,2019
6	Spectrum Analyzer	Rohde & Schwarz	FSU	100105	Jan. 04,2019
7	Horn Antenna	Schwarzbeck	BBHA 9120D	647	Jan. 04,2019
8	Pre-Amplifier	HP	8447D	1937A03050	Jan. 04,2019
9	Pre-Amplifier	EMCI	EMC05183 5	980075	Jan. 04,2019
10	Antenna Mast	UC	UC3000	N/A	N/A
11	Turn Table	UC	UC3000	N/A	N/A
12	Cable Below 1GHz	Schwarzbeck	AK9515E	33155	Jan. 04,2019
13	Cable Above 1GHz	Hubersuhner	SUCOFLEX1 02	DA1580	Jan. 04,2019

Note: 1. The Cal.Interval was one year.

2. The cable loss has calculated in test result which connection between each test instruments.

3. TEST CONDITIONS AND RESULTS

3.1. CONDUCTED EMISSION MEASUREMENT

Limit

POWER LINE CONDUCTED EMISSION (Frequency Range 150KHz-30MHz)

FREQUENCY (MHz)	Limit (dBuV)	
	Quasi-peak	Average
0.15 -0.5	66 - 56 *	56 - 46 *
0.50 -5.0	56.00	46.00
5.0 -30.0	60.00	50.00

Note:

- (1) The tighter limit applies at the band edges.
- (2) The limit of " * " marked band means the limitation decreases linearly with the logarithm of the frequency in the range.

The following table is the setting of the receiver

Receiver Parameters	Setting
Attenuation	10 dB
Start Frequency	0.15 MHz
Stop Frequency	30 MHz
IF Bandwidth	9 kHz

Test Procedure

1. The EUT was placed 0.8 meters from the horizontal ground plane with EUT being connected to the power mains through a line impedance stabilization network (LISN). All other support equipments powered from additional LISN(s). The LISN provide 50 Ohm/ 50uH of coupling impedance for the measuring instrument.
2. Interconnecting cables that hang closer than 40 cm to the ground plane shall be folded back and forth in the center forming a bundle 30 to 40 cm long.
3. I/O cables that are not connected to a peripheral shall be bundled in the center. The end of the cable may be terminated, if required, using the correct terminating impedance. The overall length shall not exceed 1 m. Repeat above procedures until all frequency measurements have been completed.
4. LISN at least 80 cm from nearest part of EUT chassis.
5. For the actual test configuration, please refer to the related Item –EUT Test Photos.

Test Configuration

For the actual test configuration, please refer to the related Item –EUT Test Photos.

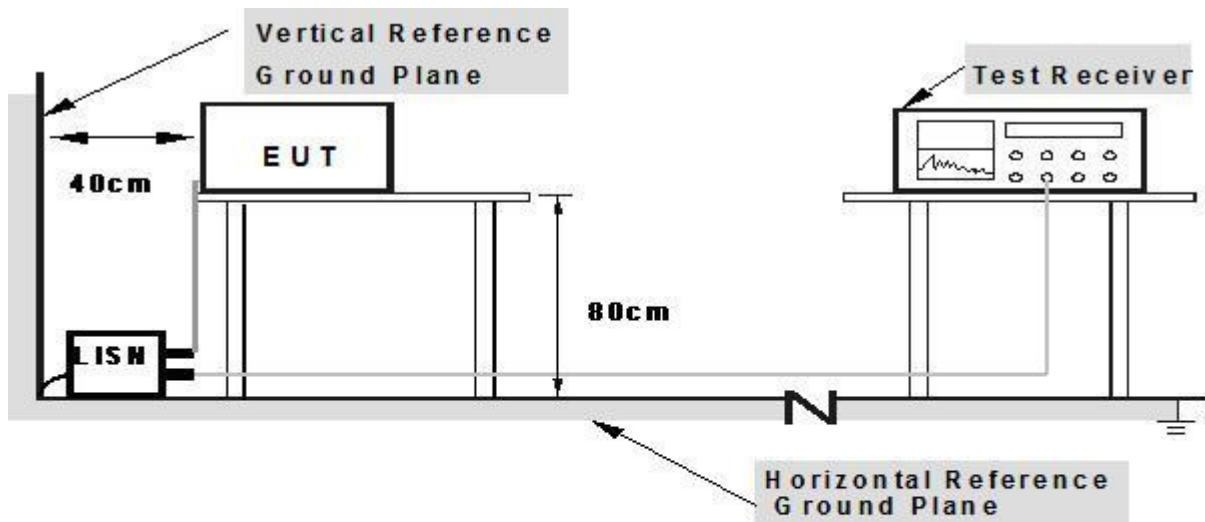

Note: 1.Support units were connected to second LISN.

2.Both of LISNs (AMN) are 80 cm from EUT and at least 80 from other units and other metal planes



Test Results

TEST RESULTS

Temperature :	23.5 °C	Relative Humidity :	60%
Pressure :	101 Kpa	Test Date :	2018-02-20
Test Mode :	Mode 1	Phase :	L
Test Voltage :	AC 120V/60Hz		

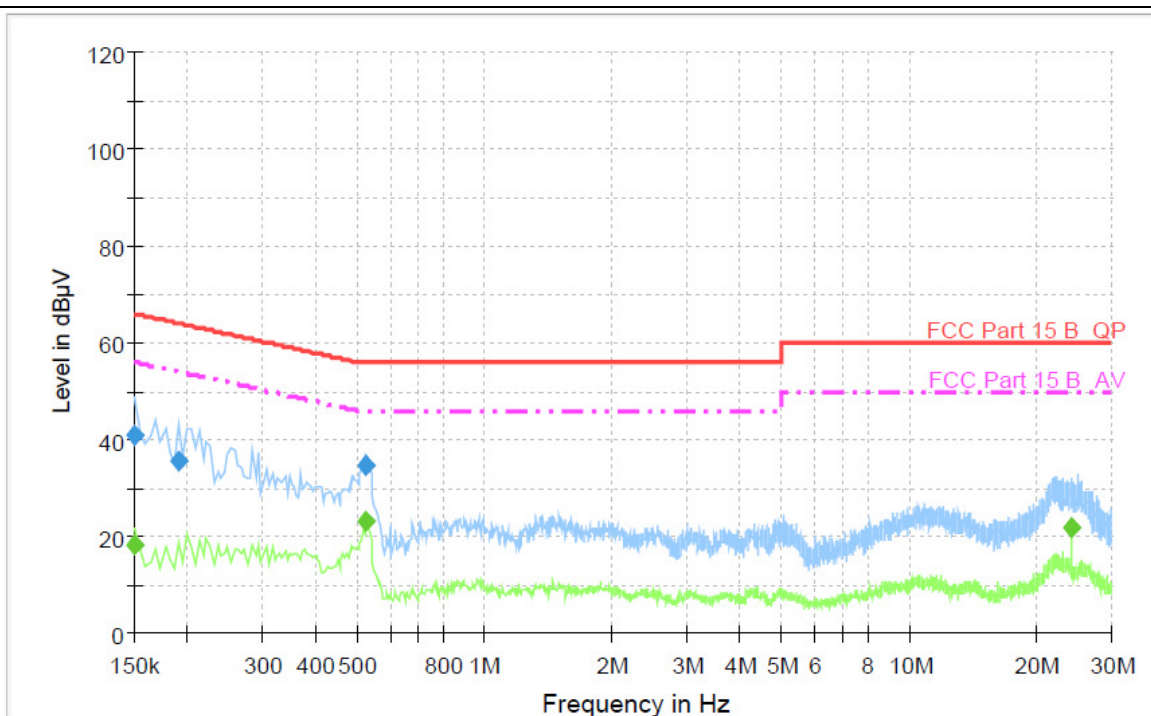

Final Measurement Detector 1

Frequency (MHz)	QuasiPeak (dBµV)	Meas. Time (ms)	Bandwidth (kHz)	Filter	Line	Corr. (dB)	Margin (dB)	Limit (dBµV)	Comment
0.150000	41.0	1000.000	9.000	Off	L1	10.0	25.0	66.0	
0.190500	35.5	1000.000	9.000	Off	L1	10.0	28.5	64.0	
0.528000	34.7	1000.000	9.000	Off	L1	9.8	21.3	56.0	

Final Measurement Detector 2

Frequency (MHz)	Average (dBµV)	Meas. Time (ms)	Bandwidth (kHz)	Filter	Line	Corr. (dB)	Margin (dB)	Limit (dBµV)	Comment
0.150000	18.1	1000.000	9.000	Off	L1	10.0	37.9	56.0	
0.528000	23.3	1000.000	9.000	Off	L1	9.8	22.7	46.0	
24.198000	21.9	1000.000	9.000	Off	L1	10.0	28.1	50.0	

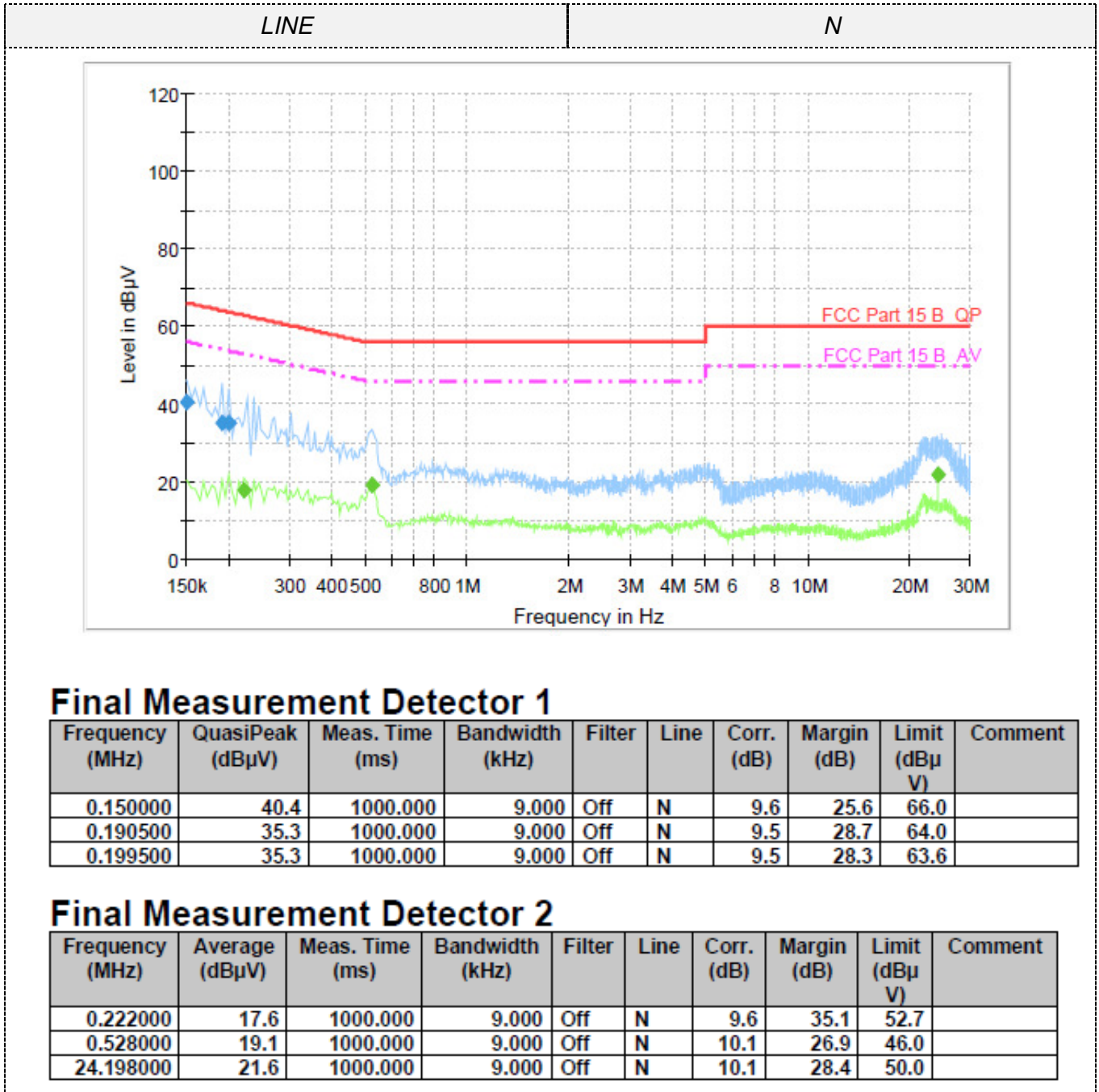

3.2. Radiated Emission

Limit

For intentional device, according to § 15.209(a), the general requirement of field strength of radiated emission from intentional radiators at a distance of 3 meters shall not exceed the following table. According to § 15.247(d), in any 100kHz bandwidth outside the frequency band in which the EUT is operating, the radio frequency power that is produced by the intentional radiator shall be at least 20dB below that in the 100kHz bandwidth within the band that contains the highest level of desired power.

The frequency spectrum above 1 GHz for Transmitter was investigated. All emission not reported are much lower than the prescribed limits. Set the RBW=1MHz, VBW=3MHz for Peak Detector while the RBW=1MHz, VBW=10Hz for Average Detector, Readings are both peak and average values. The pre-test have done for the EUT in three axes and found the worst emission at position shown in test setup photos.

Frequency (MHz)	Distance (Meters)	Radiated (dBuV/m)	Radiated (µV/m)
0.009-0.49	3	20log(2400/F(KHz))+40log(300/3)	2400/F(KHz)
0.49-1.705	3	20log(24000/F(KHz))+ 40log(30/3)	24000/F(KHz)
1.705-30	3	20log(30)+ 40log(30/3)	30
30-88	3	40.0	100
88-216	3	43.5	150
216-960	3	46.0	200
Above 960	3	54.0	500

Test Procedure

- The EUT was placed on a turn table which is 0.8m above ground plane..
- Maximum procedure was performed by raising the receiving antenna from 1m to 4m and rotating the turn table from 0°C to 360°C to acquire the highest emissions from EUT
- And also, each emission was to be maximized by changing the polarization of receiving antenna both horizontal and vertical.
- Repeat above procedures until all frequency measurements have been completed.

Field Strength Calculation

The field strength is calculated by adding the Antenna Factor and Cable Factor and subtracting the Amplifier Gain and Duty Cycle Correction Factor (if any) from the measured reading. The basic equation with a sample calculation is as follows:

$$FS = RA + AF + CL - AG$$

Where	FS = Field Strength	CL = Cable Attenuation Factor (Cable Loss)
	RA = Reading Amplitude	AG = Amplifier Gain
	AF = Antenna Factor	

For example

Frequency (MHz)	FS (dBµV/m)	RA (dBµV/m)	AF (dB)	CL (dB)	AG (dB)	Transd (dB)
150.00	40	58.1	12.2	1.6	31.90	-18.1

Transd=AF +CL-AG

Test Configuration

For the actual test configuration, please refer to the related Item –EUT Test Photos.

Frequency range 9 KHz – 30MHz

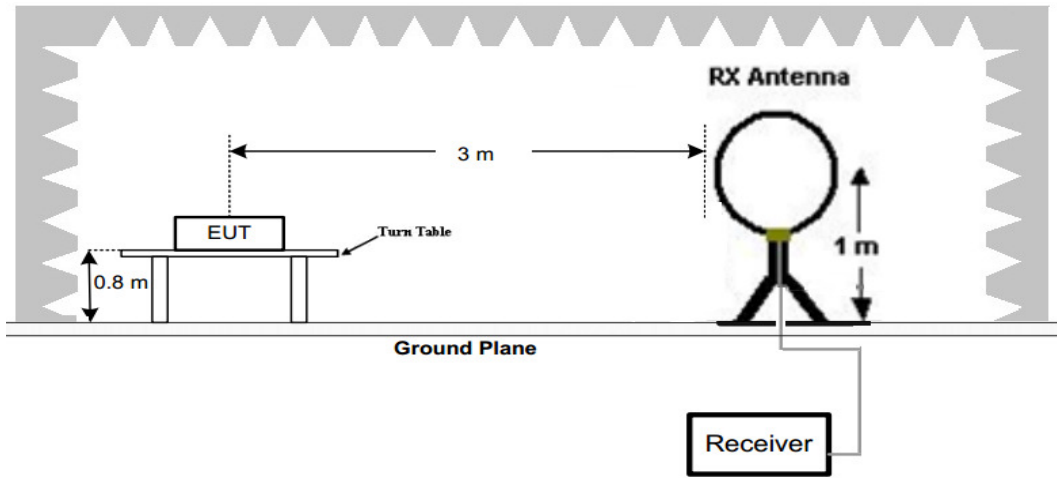

Frequency range 30MHz – 1000MHz

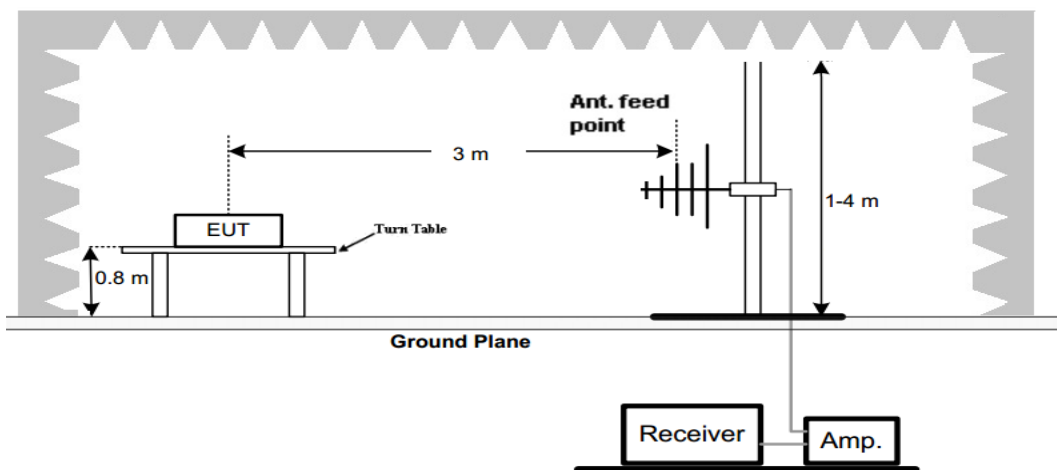

Frequency range above 1GHz-25GHz

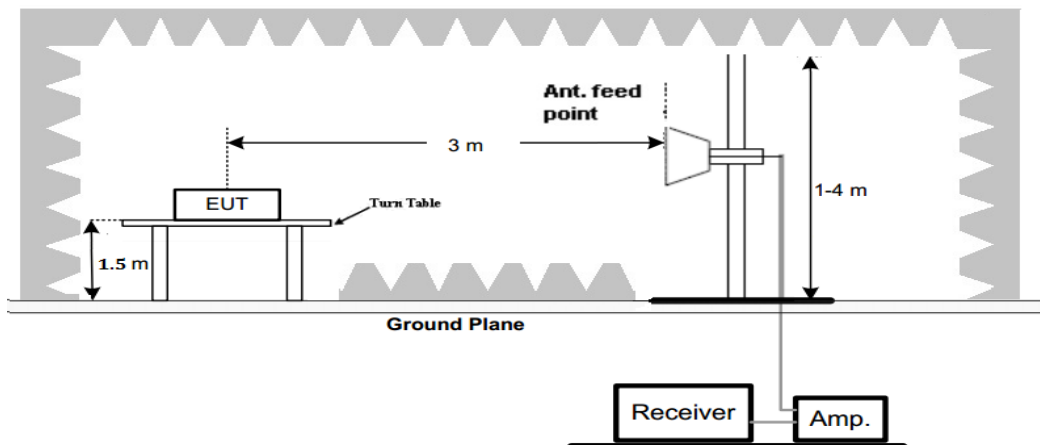

Test Results

Remark:

1. We tested three channels for each mode and recorded worst case at low channel of BT 4.0 mode from 30MHz to 1GHz.

For 9 KHz-30MHz

The test results of 9kHz-30MHz is attenuated more than 20dB below the permissible limits, so the results don't record in the report.

For 30MHz-1GHz For BT 4.0 Low Channel

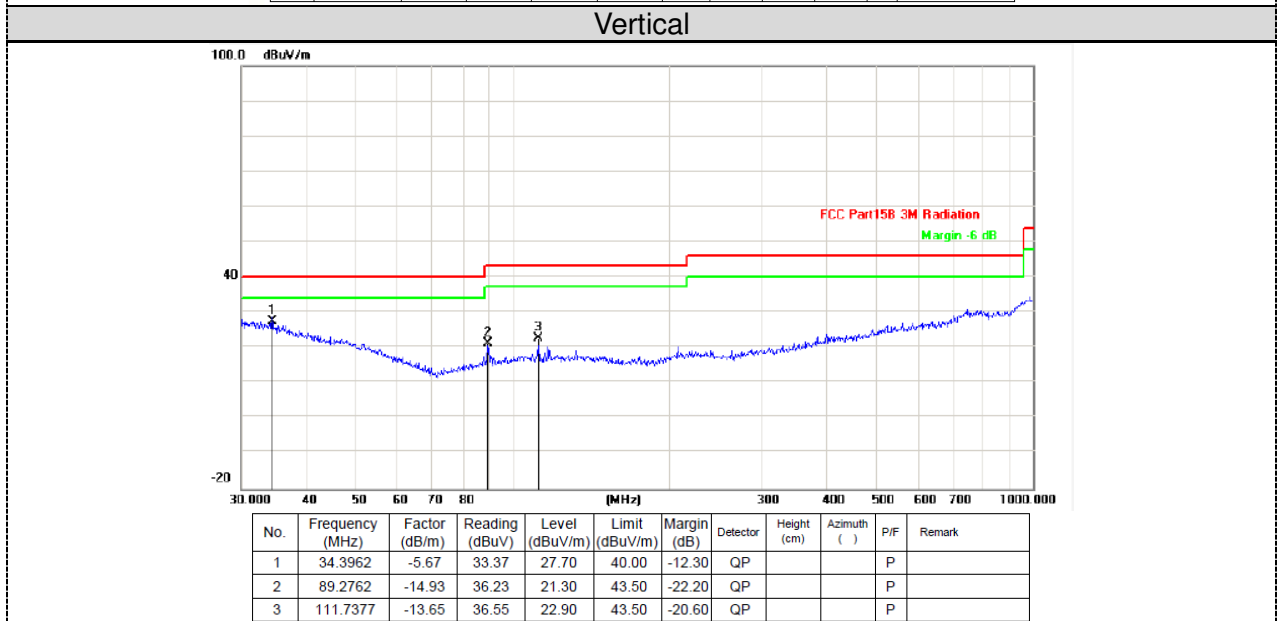
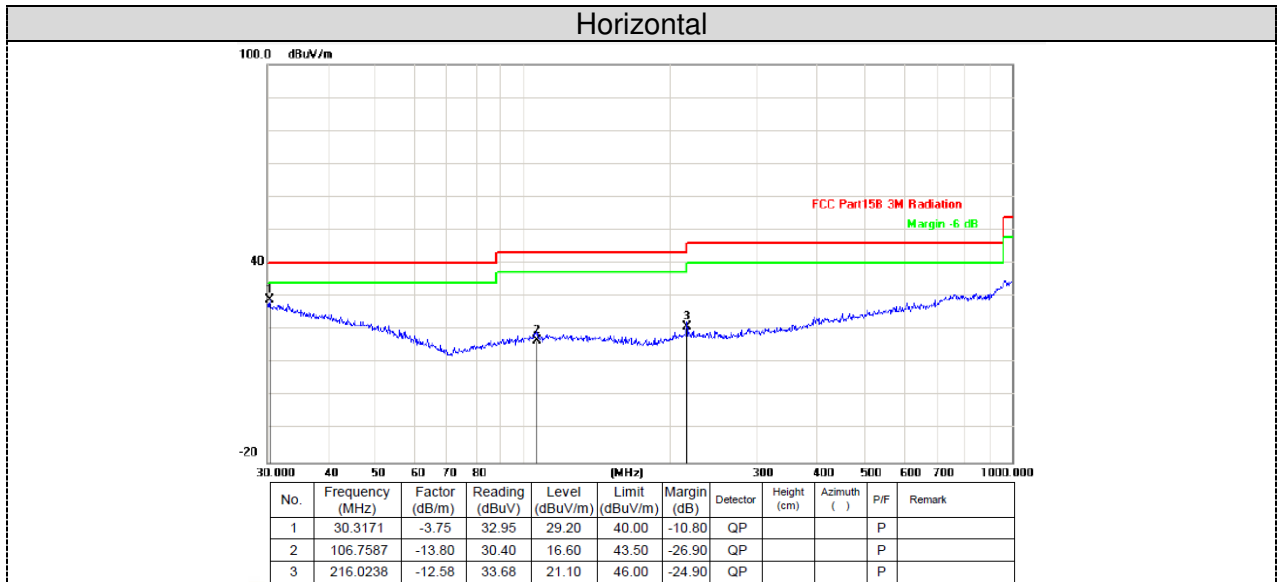

REMARKS:

1. Emission level (dBuV/m) = Raw Value (dBuV) + Correction Factor (dB/m)
2. Correction Factor (dB/m) = Antenna Factor (dB/m) + Cable Factor (dB) - Pre-amplifier Factor
3. Margin value = Limit value - Emission level.
4. -- Mean the PK detector measured value is below average limit.
5. The other emission levels were very low against the limit.

Above 1GHz emission please refer to C180303Z02-RP1 report

3.3. Maximum Conducted Output Power

Limit

30dBm for digital modulation systems.

Test Procedure

- maximum (average) conducted output power - Measurement using a RF average power meter
 1. Remove the antenna from the EUT and then connect a low loss RF cable from the antenna port to the Power Meter.
 2. Ensure EUT transmitting with a duty cycle $\geq 98\%$.
 3. Record the value of Power Meter.
- Maximum peak conducted output power
 1. Set the RBW \geq DTS bandwidth
 2. Set VBW $\geq 3 \times$ RBW.
 3. Set span $\geq 3 \times$ RBW
 4. Sweep time = auto couple.
 5. Detector = peak.
 6. Trace mode = max hold.
 7. Allow trace to fully stabilize.
 8. Use peak marker function to determine the peak amplitude level

Note: WIFI: Use the maximum (average) conducted output power test procedure
BT4.0: Use the maximum peak conducted output power test procedure

Test Configuration

- For Maximum conducted (average) output power



- For Maximum peak conducted output power

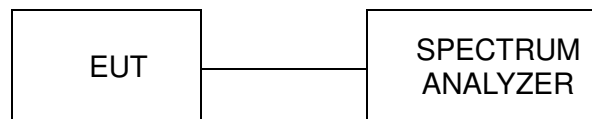

Test Results

BT4.0

Type	Channel	Output power PK(dBm)	Limit (dBm)	Result
BT4.0	00	-0.01	30.00	Pass
	20	2.40		
	39	3.97		

Note: The test results including the cable loss.

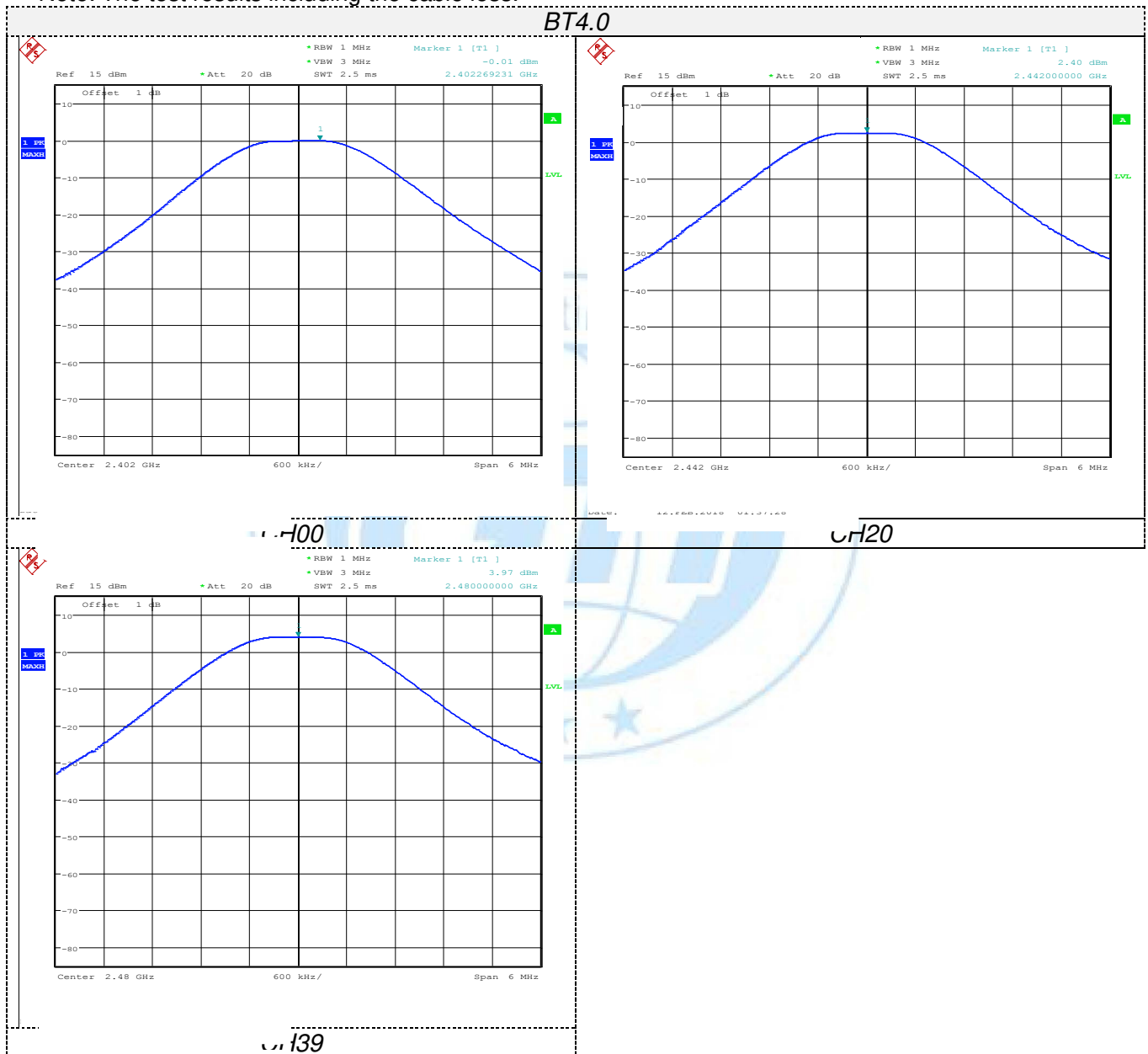

3.4. Power Spectral Density

Limit

For digitally modulated systems, the power spectral density conducted from the intentional radiator to the antenna shall not be greater than 8 dBm in any 3 kHz band during any time interval of continuous transmission.

Test Procedure

1. Use this procedure when the maximum (average) conducted output power was used to demonstrate compliance to the output power limit.
 - a) Set analyzer center frequency to DTS channel center frequency.
 - b) Set span to at least 1.5 times the OBW
 - c) RBW: $3 \text{ kHz} \leq \text{RBW} \leq 100 \text{ kHz}$.
 - d) VBW: $\geq 3 \times \text{RBW}$.
 - e) Detector: power averaging (RMS)
 - f) Sweep time: Auto couple.
 - g) Swoop points: $\geq 2 \times \text{span} / \text{RBW}$.
 - h) Trace mode = Average (100 traces)
 - i) Use the peak marker function to determine the maximum power level.
 - j) If measured value exceeds limit, reduce RBW (no less than 3 kHz) and repeat.

Note: This test procedure is used for WIFI in this report

2. This procedure shall be used if maximum peak conducted output power was used to demonstrate compliance to the output power limit.
 - a) Set analyzer center frequency to DTS channel center frequency.
 - b) Set the span to 1.5 times the DTS bandwidth.
 - c) Set the RBW to: $3 \text{ kHz} \leq \text{RBW} \leq 100 \text{ kHz}$.
 - d) Set the VBW $\geq 3 \times \text{RBW}$.
 - e) Detector = peak.
 - f) Sweep time = auto couple.
 - g) Trace mode = max hold.
 - h) Allow trace to fully stabilize.
 - i) Use the peak marker function to determine the maximum amplitude level within the RBW.
 - j) If measured value exceeds limit, reduce RBW (no less than 3 kHz) and repeat

Note: This test procedure is used for BT 4.0 in this report

Test Configuration

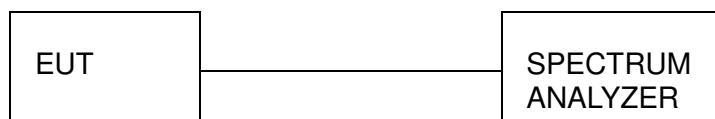

Test Results

BT4.0

Type	Channel	Power Spectral Density (dBm/100KHz)	Limit (dBm/100KHz)	Result
BT4.0	00	-1.97	8.00	Pass
	20	-1.92		
	39	-0.45		

Test plot as follows:

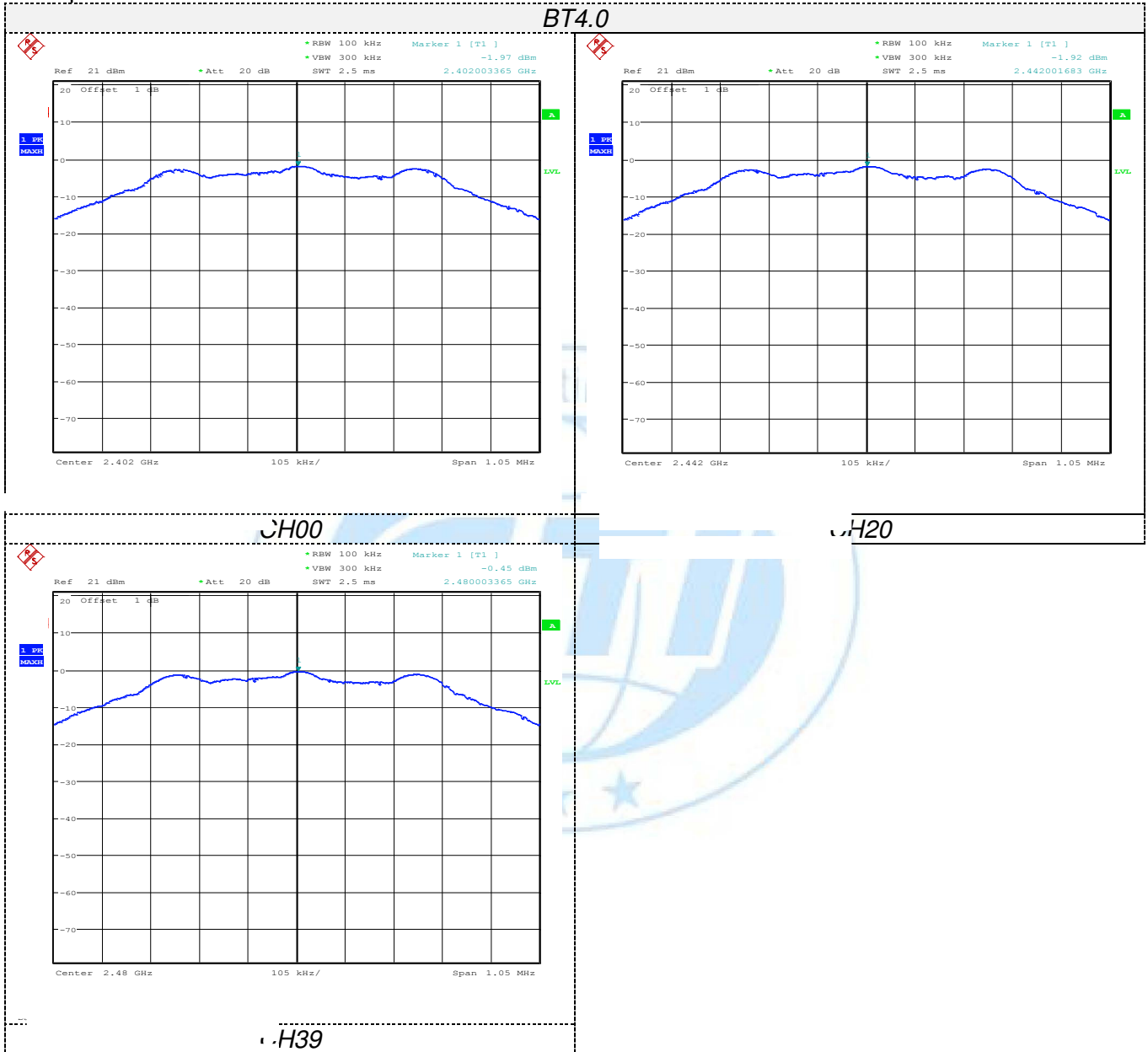

3.5.6dB Bandwidth

Limit

For digital modulation systems, the minimum 6 dB bandwidth shall be at least 500 kHz

Test Procedure

1. The transmitter output was connected to the spectrum analyzer.
2. Set SA as follow:
 - a) RBW: 100 kHz.
 - b) VBW: $\geq 3 \times$ RBW.
 - c) Detector: Peak.
 - d) Trace mode: max hold.
 - e) Sweep: auto couple.
3. Allow the trace to stabilize.
4. Measure the maximum width of the emission that is constrained by the frequencies associated with the two outermost amplitude points (upper and lower frequencies) that are attenuated by 6 dB relative to the maximum level measured in the fundamental emission.

Test Configuration



Test Results

BT4.0

Type	Channel	6dB Bandwidth (MHz)	99% OBW (MHz)	Limit (KHz)	Result
GFSK	00	0.688	1.053	≥500	Pass
	20	0.688	1.058		
	39	0.688	1.063		

Test plot as follows:

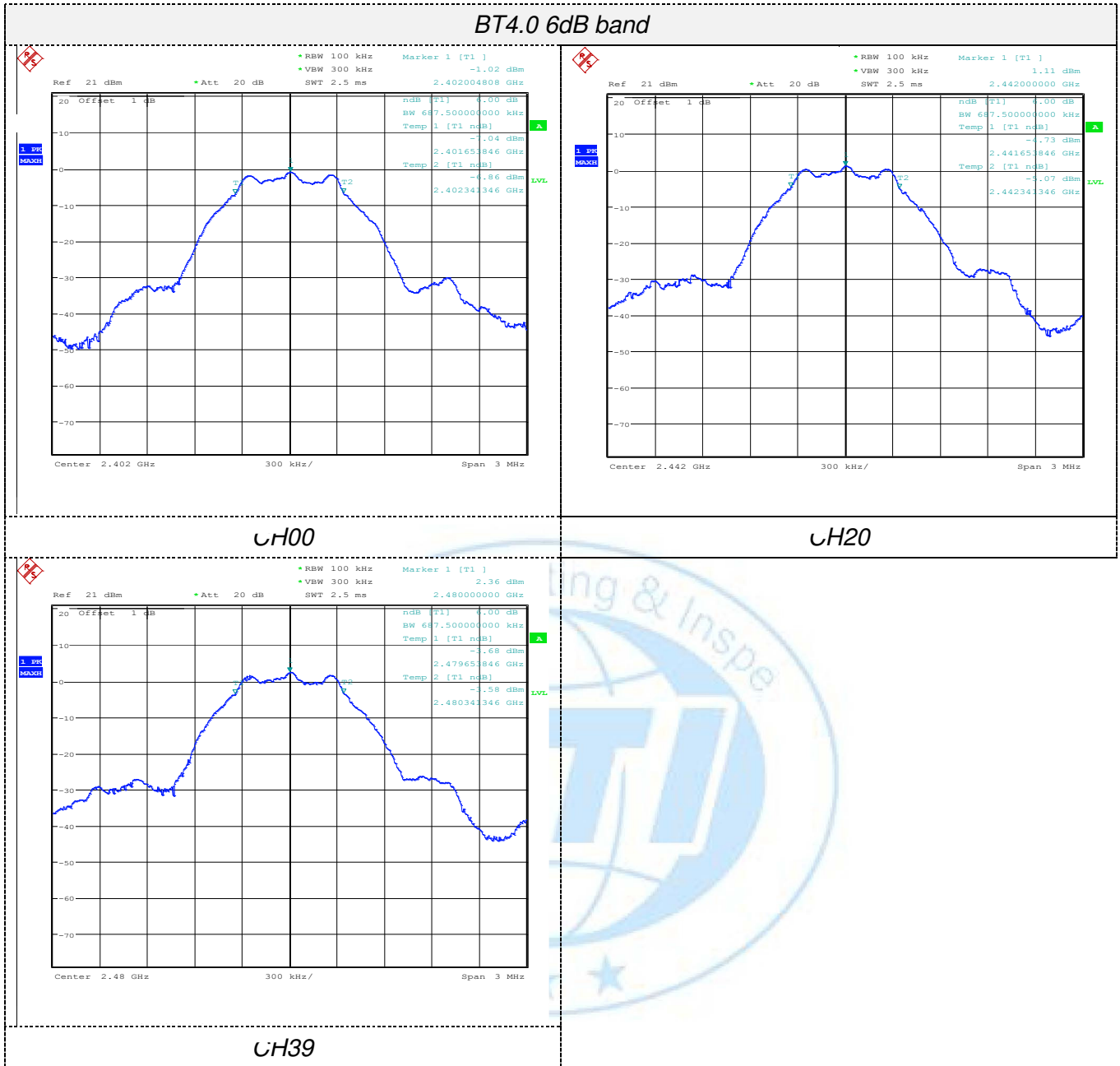

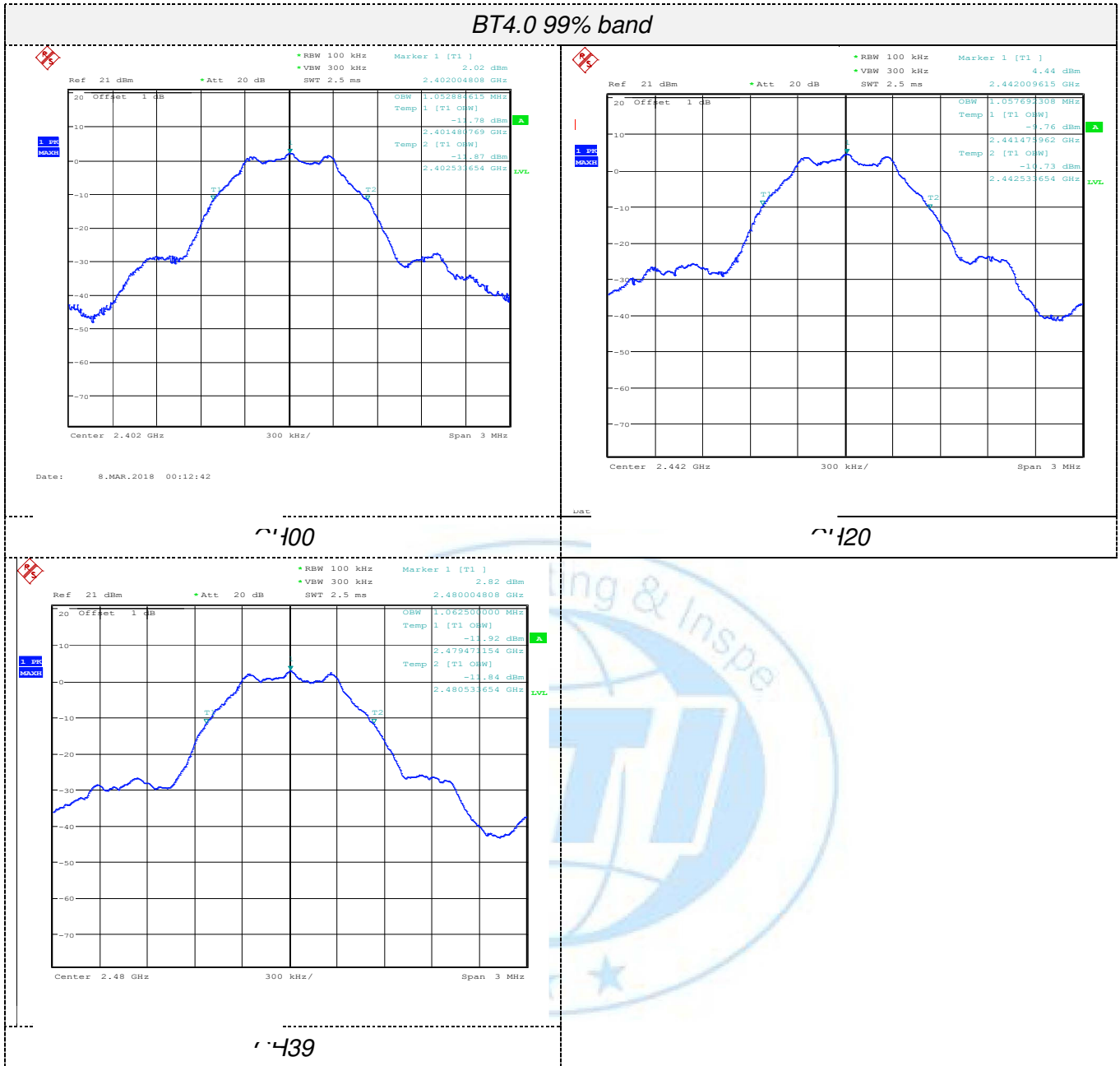

3.6. Band Edge Compliance of RF Emission

Limit

In any 100 kHz bandwidth outside the frequency band in which the spread spectrum or digitally modulated intentional radiator is operating, the radio frequency power that is produced by the intentional radiator shall be at least 20 dB below that in the 100 kHz bandwidth within the band that contains the highest level of the desired power, based on either an RF conducted or a radiated measurement, provided the transmitter demonstrates compliance with the peak conducted power limits. If the transmitter complies with the conducted power limits based on the use of RMS averaging over a time interval, as permitted under paragraph (b)(3) of this section, the attenuation required under this paragraph shall be 30 dB instead of 20 dB. Attenuation below the general limits specified in §15.209(a) is not required. In addition, radiated emissions which fall in the restricted bands, as defined in §15.205(a), must also comply with the radiated emission limits specified in §15.209(a) (see §15.205(c)).

Radiated emissions which fall in the restricted bands, as defined in § 15.205(a), must also comply with the radiated emission limits specified in § 15.209(a)

Test Procedure

Test Procedure for conducted method

- Use this procedure when the maximum (average) conducted output power was used to demonstrate compliance to the output power limit.
 1. Remove the antenna from the EUT and then connect to a low loss RF cable from the antenna port to a spectrum analyzer
 2. Turn on the EUT and make it operate in transmitting mode. Then set it to Low Channel and High Channel within its operating range, and make sure the instrument is operated in its linear range.
 3. Set spectrum analyzer RBW =100 kHz, VBW=300 kHz, Detector=RMS, Sweep point= $\geq 2 \times$ span / RBW, Sweep time=Auto, trace= Average(100 traces)
 4. Marker the highest point which fall into restricted frequency bands
 5. Repeat above procedures until all measured frequencies were complete.

Note: This test procedure is used for WIFI in this report

- This procedure shall be used if maximum peak conducted output power was used to demonstrate compliance to the output power limit.
 1. Remove the antenna from the EUT and then connect to a low loss RF cable from the antenna port to a spectrum analyzer
 2. Turn on the EUT and make it operate in transmitting mode. Then set it to Low Channel and High Channel within its operating range, and make sure the instrument is operated in its linear range.
 3. Set spectrum analyzer RBW =100 kHz, VBW=300 kHz, Detector=peak, Sweep time=Auto, trace=maxhold
 4. Marker the highest point which fall into restricted frequency bands
 5. Repeat above procedures until all measured frequencies were complete.

Note: This test procedure is used for BT4.0 in this report

Test Procedure for radiated method

1. The EUT was placed on the top of a rotating table 0.8 meters above the ground at a 3 meter anechoic chamber. The table was rotated 360 degrees to determine the position of the highest radiation.
2. The EUT was set 3 meters away from the interference receiving antenna, which was mounted on the top of a variable height antenna tower.
3. The antenna height is varied from one meter to four meters above the ground to determine the maximum value of the field strength. Both horizontal and vertical polarizations of the antenna are set to make the measurement.
4. For each suspected emission, the EUT was arranged to its worst case and then the antenna was tuned to heights from 1 meter to 4 meters and the rotatable table was turned from 0 degrees to 360 degrees to find the maximum reading.
5. The test-receiver system was set to Peak Detect Function and Specified Bandwidth with Maximum Hold Mode.
6. Place a marker at the end of the restricted band closest to the transmit frequency to show compliance. Also measure any emissions in the restricted bands. Save the spectrum analyzer plot. Repeat for each power and modulation for lowest and highest channel
7. Test the EUT in the lowest channel, the highest channel
8. The radiation measurements are performed in X, Y, Z axis positioning. And found the X axis positioning which it is worse case, only the test worst case mode is recorded in the report.
9. Repeat above procedures until all frequencies measured was complete.



Test Results

Conducted measurements

BT4.0			
Frequency (MHz)	Delta Peak to Band emission (dBc)	Limit (dBc)	Verdict
2375.508	-61.48	20	PASS
2493.364	-55.53	20	PASS

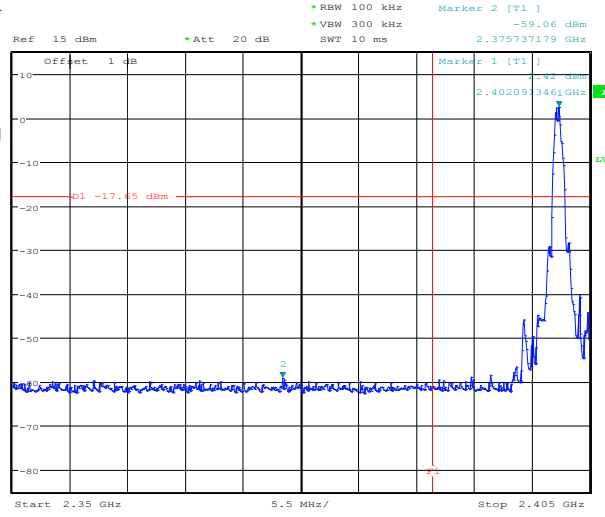

402

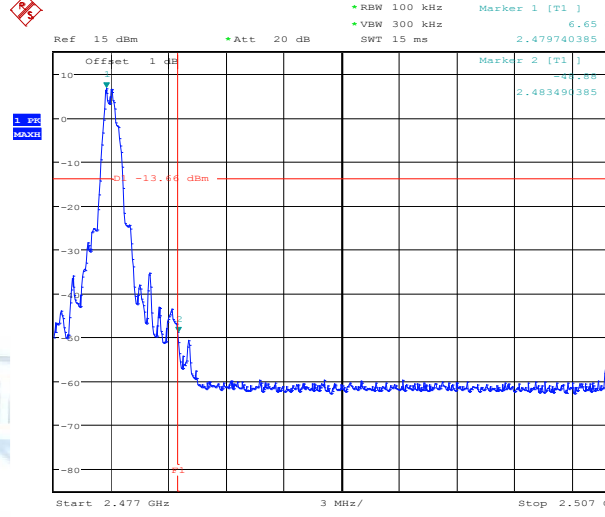

480



A. Radiated measurements

bt 4.0 GFSK

Polar	Frequenc y	Meter Reading	Pre-amplif ier	Cable Loss	Antenna Factor	Emission Level	Limits	Margin	Detector
(H/V)	(MHz)	(dBuV)	(dB)	(dB)	(dB/m)	(dBuV/m)	(dBuV/m)	(dB)	Type
H	2390.00	45.35	36.12	3.32	27.5	40.05	74	-33.95	PK
H	2390.00	35.42	36.12	3.32	27.5	30.12	54	-23.88	AV
V	2390.00	44.87	36.12	3.32	27.5	39.57	74	-34.43	PK
V	2390.00	34.39	36.12	3.32	27.5	29.09	54	-24.91	AV
2480MHz									
Polar	Frequenc y	Meter Reading	Pre-amplif ier	Cable Loss	Antenna Factor	Emission Level	Limits	Margin	Detector
(H/V)	(MHz)	(dBuV)	(dB)	(dB)	(dB/m)	(dBuV/m)	(dBuV/m)	(dB)	Type
H	2483.50	44.82	36.12	3.32	27.5	39.52	74	-34.48	PK
H	2483.50	33.12	36.12	3.32	27.5	27.82	54	-26.18	AV
V	2483.50	45.75	36.12	3.32	27.5	40.45	74	-33.55	PK
V	2483.50	34.72	36.12	3.32	27.5	29.42	54	-24.58	AV

REMARKS:

1. Emission level (dBuV/m) =Raw Value (dBuV)+Correction Factor (dB/m)
2. Correction Factor (dB/m) = Antenna Factor (dB/m)+Cable Factor (dB)-Pre-amplifier Factor
3. Margin value = Limit value- Emission level.
4. -- Mean the PK detector measured value is below average limit.
5. The other emission levels were very low against the limit.

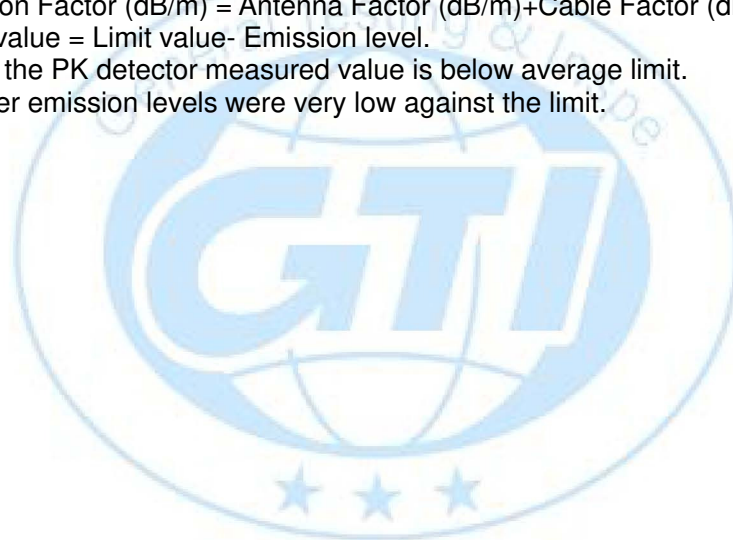

3.7. Antenna Requirement

Standard Applicable

For intentional device, according to FCC 47 CFR Section 15.203:

An intentional radiator shall be designed to ensure that no antenna other than that furnished by the responsible party shall be used with the device. The use of a permanently attached antenna or of an antenna that uses a unique coupling to the intentional radiator, the manufacturer may design the unit so that a broken antenna can be replaced by the user, but the use of a standard antenna jack or electrical connector is prohibited

Result

The EUT's antenna used a Antenna, soldered on the PCB., The antenna's gain is 0 dBi. Complying with the standard requirement.

Test Result:

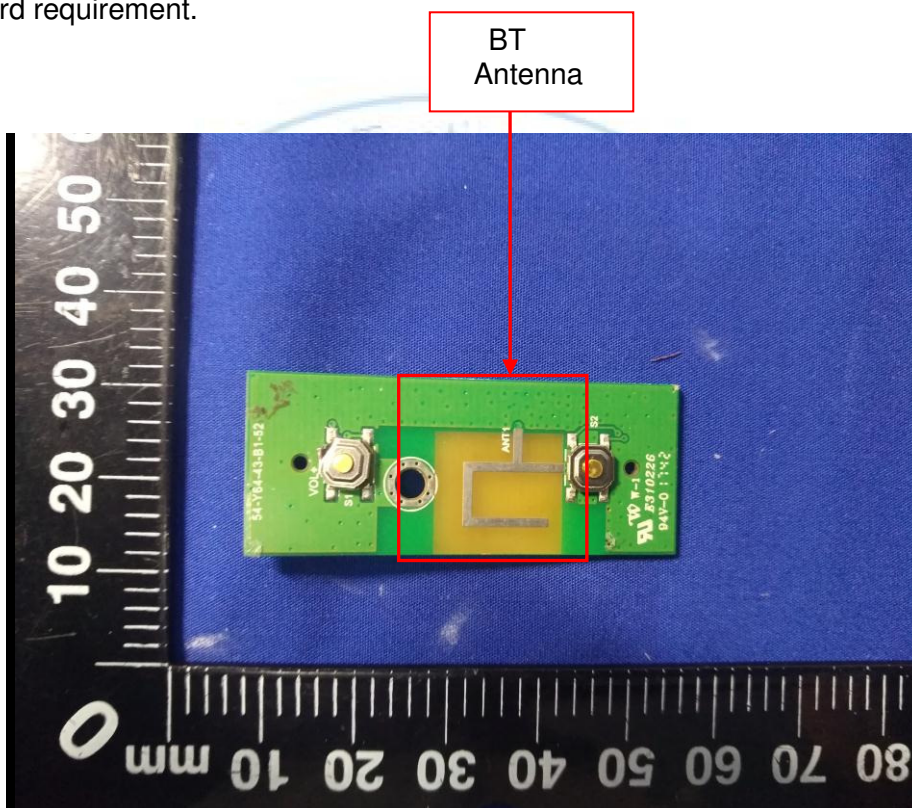

4. EUT TEST PHOTO

Conducted Emission



Radiated Emission

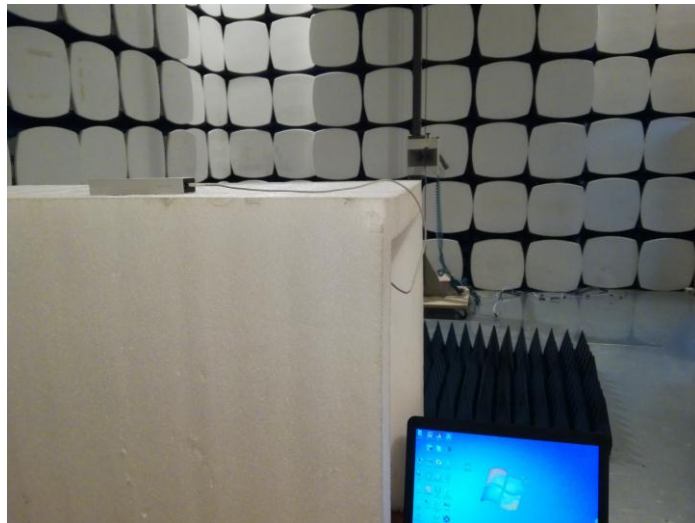
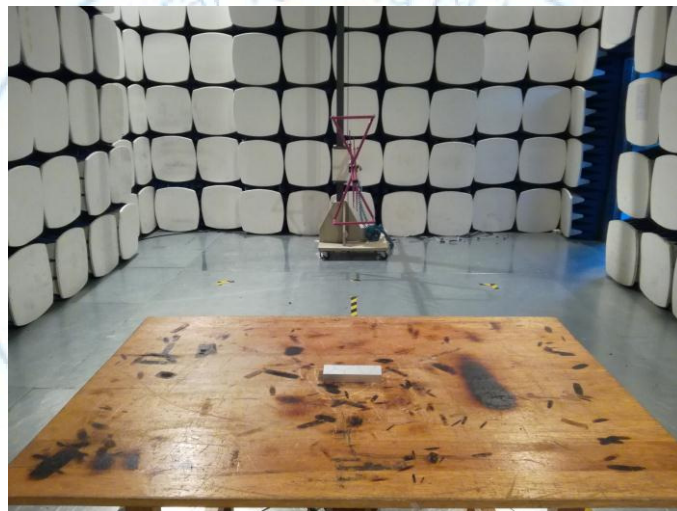

5. PHOTOGRAPHS OF EUT CONSTRUCTIONAL

External Photos of EUT Main Model

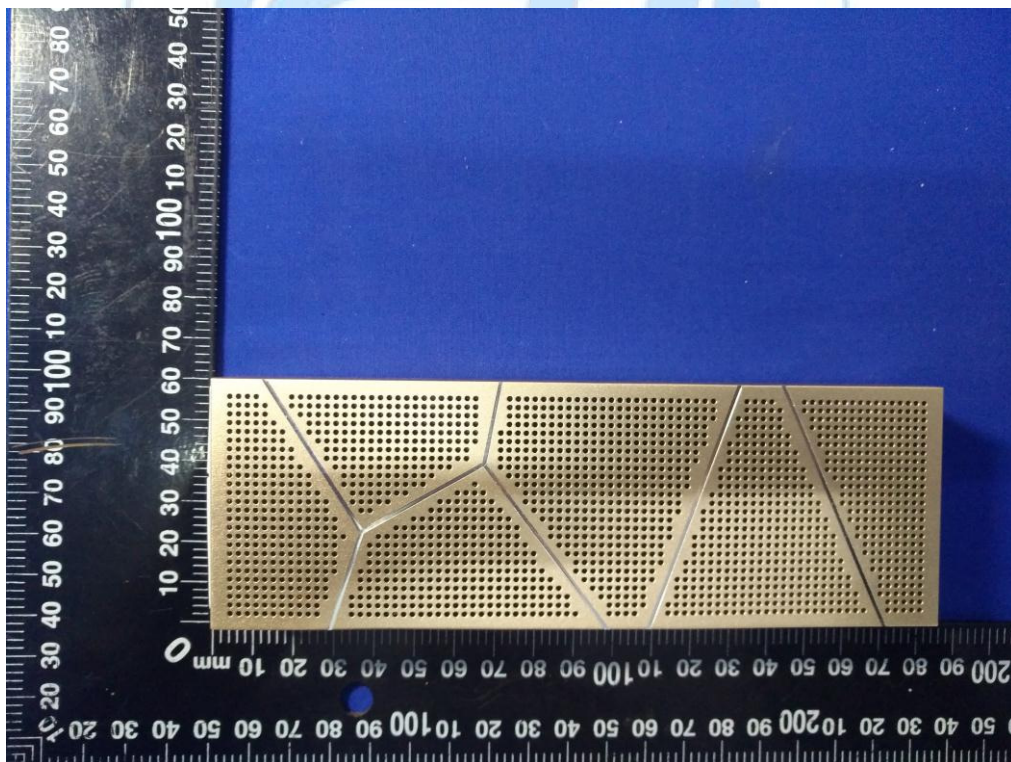
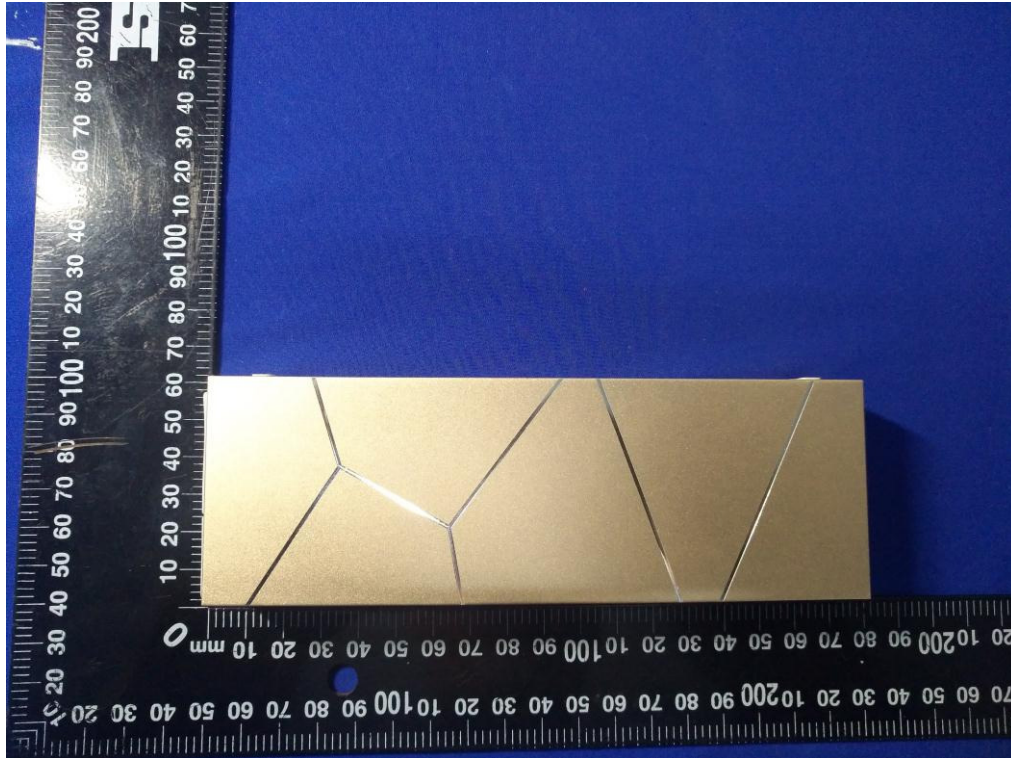

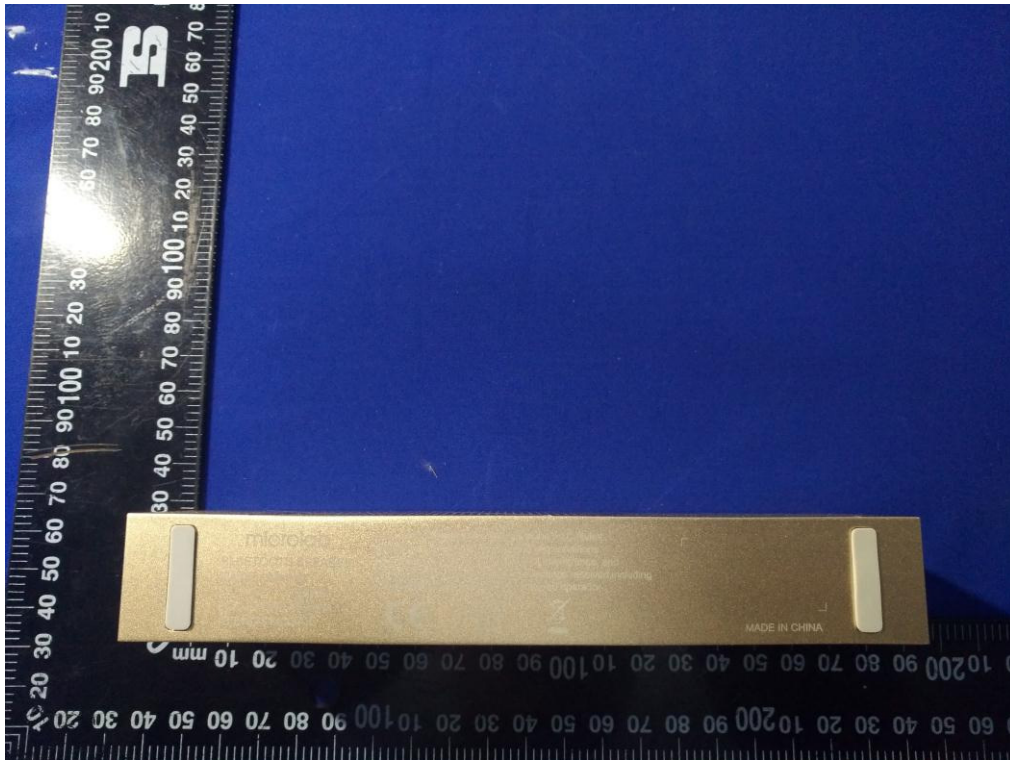

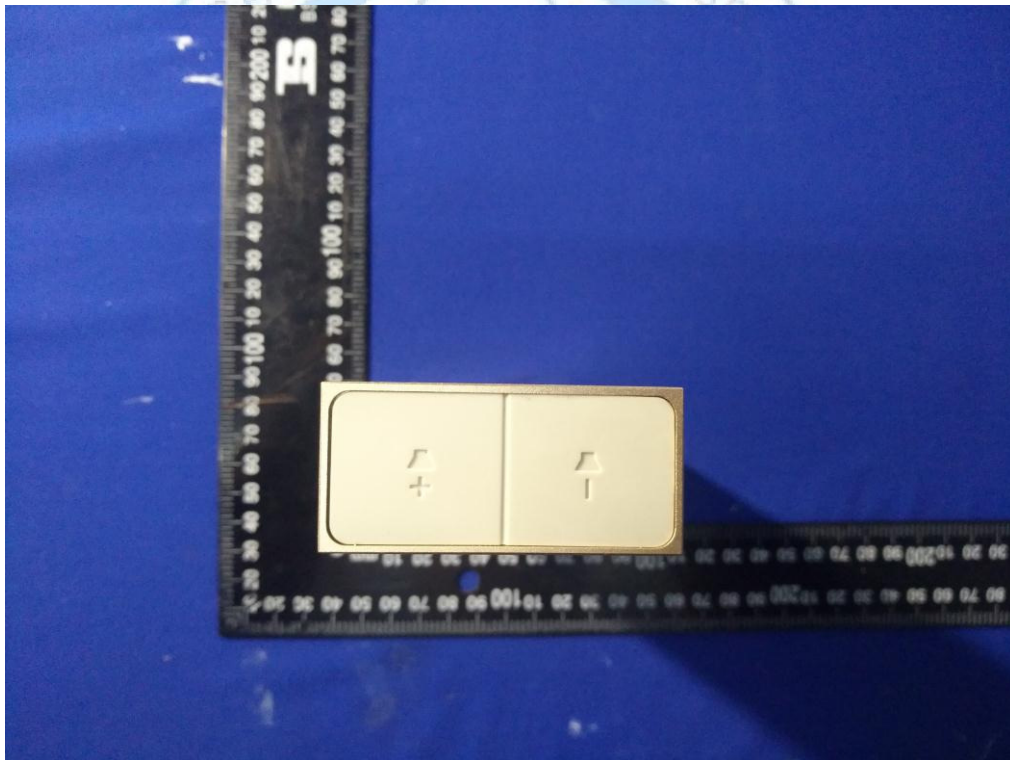

Internal Photos of EUT

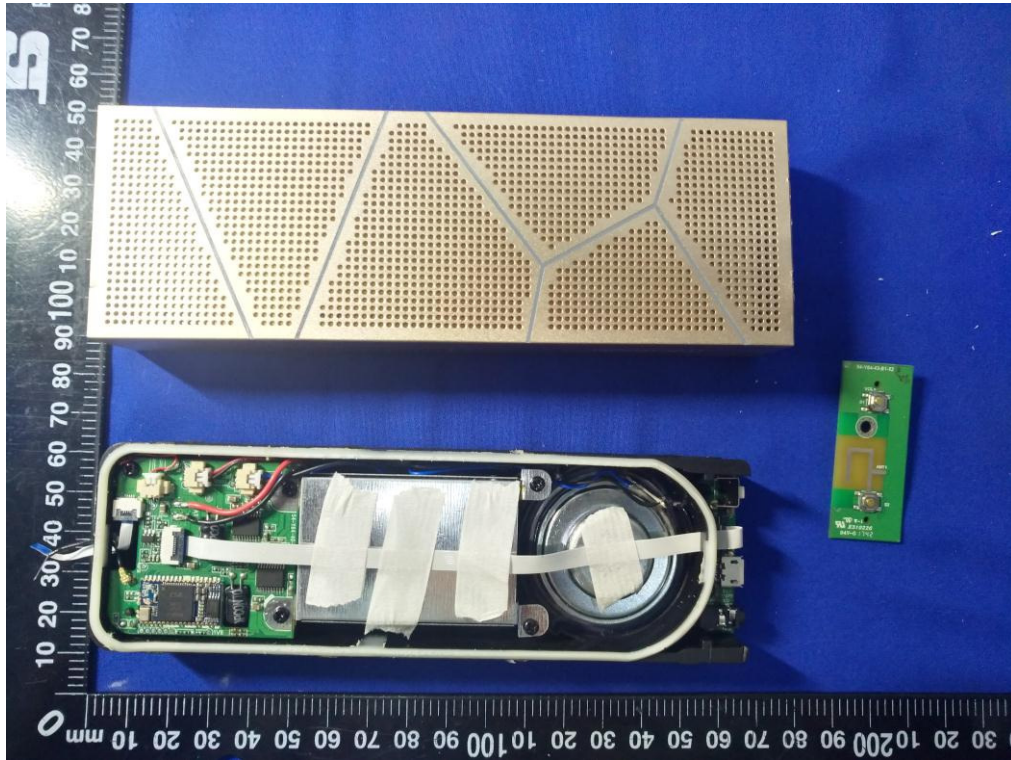

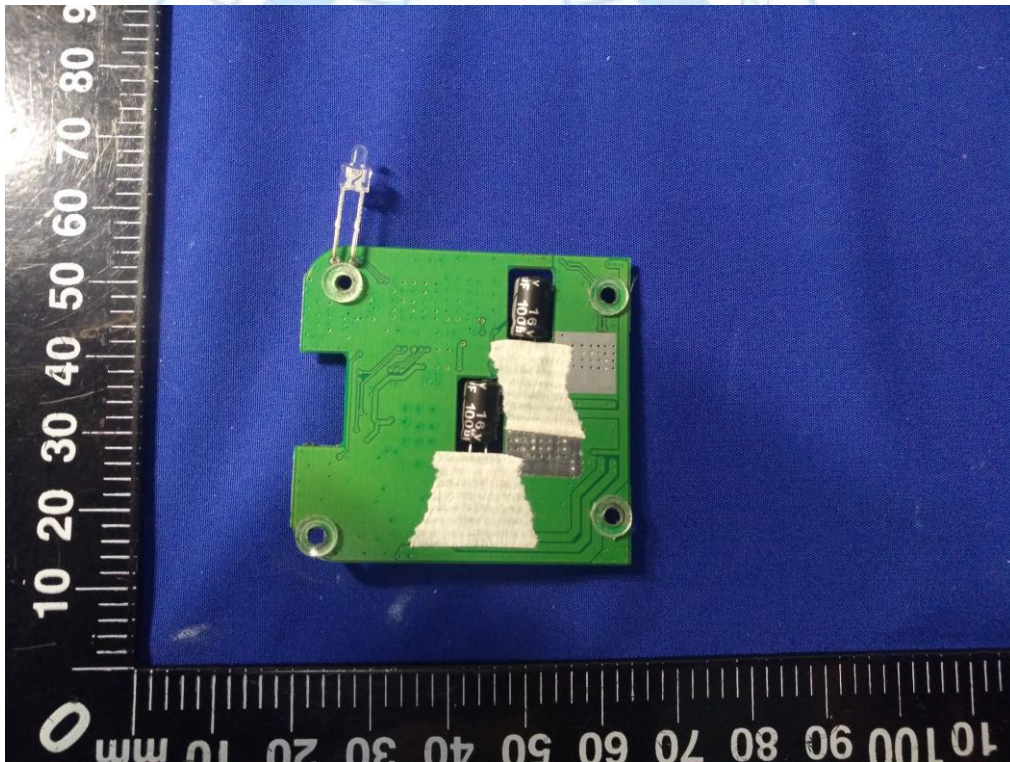
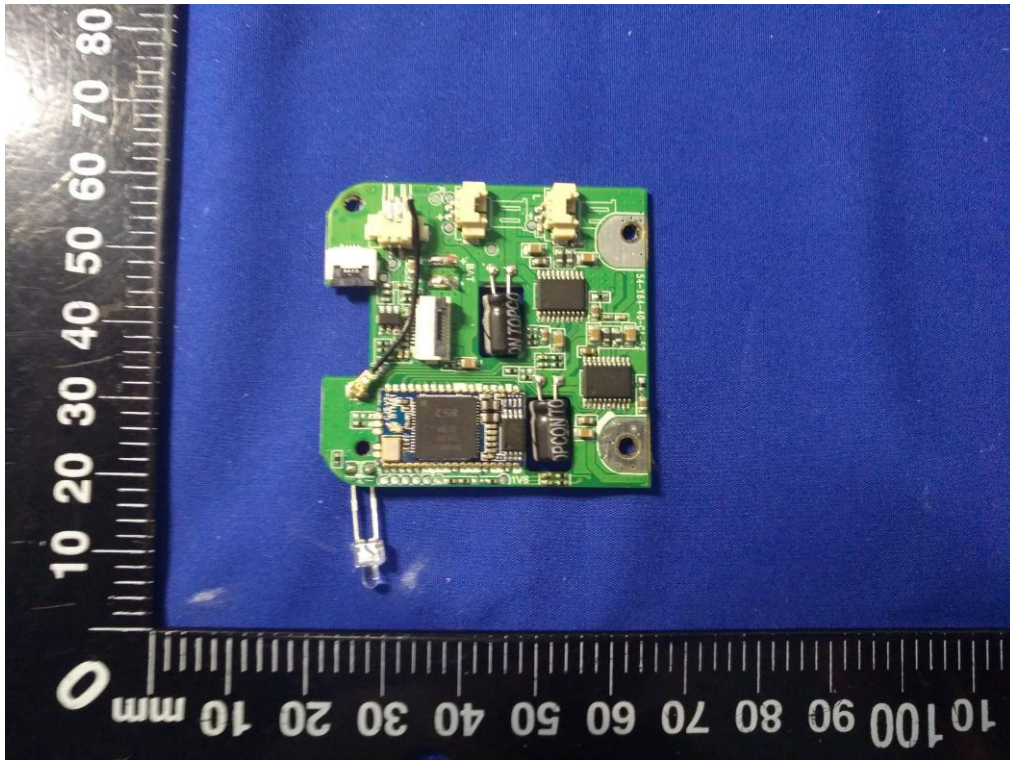

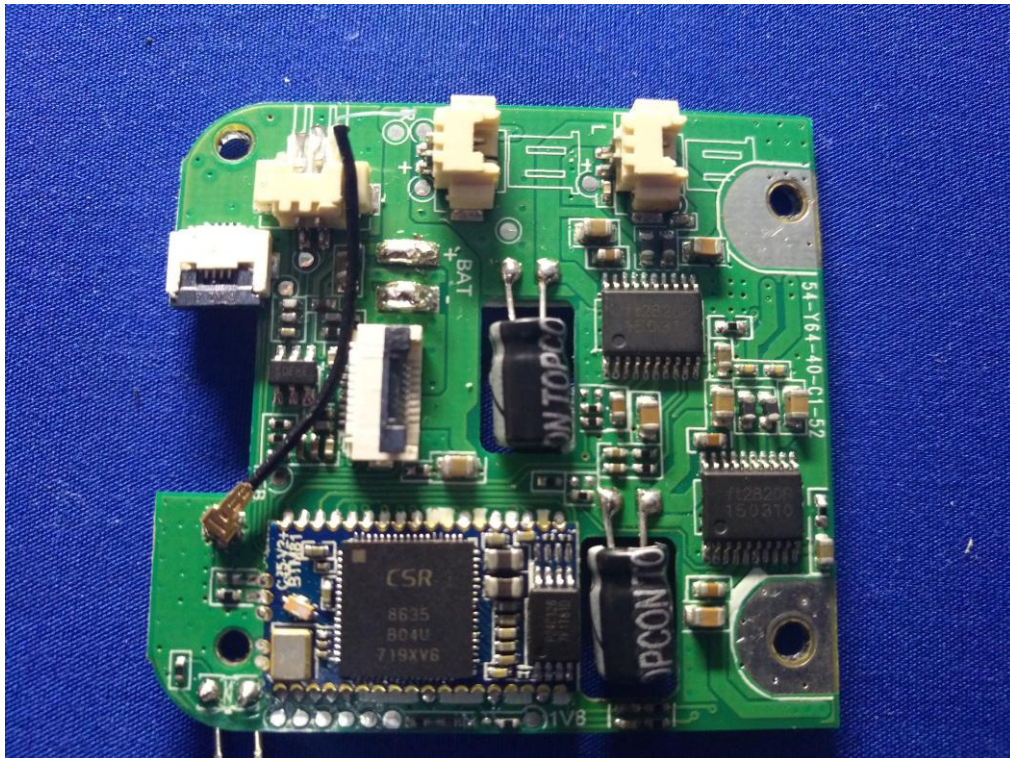

*****THE END*****

