



TEST REPORT

Nr. R23069001

Federal Communication Commission (FCC)

Report Reference No.	R23069001
Date of issue:	21.06.2023
Total number pages:	60
Customer name	Autec S.r.l.
Address	Via Pomaroli, 65 – 36030 Caldogno (VI) – Italy
Test specification:	
Standards	FCC Rules & Regulations, Title 47:2021 Part 15 paragraph(s): 203, 204, 205, 207, 209, 215 and 247
Non-standard test method	N/A
Test Report Form No.	15-247_Hopping_DEKRA
Test Report Form(s) Originator ...:	DEKRA Testing and Certification S.r.l.
Master TRF	2023-06
General disclaimer:	
The test results presented in this report relate only to the object tested. This report shall not be reproduced, except in full, without the written approval of DEKRA Testing and Certification S.r.l.	
(*) Test item description	Transceiver unit
(*) Trademark	Autec
(*) Manufacturer	Autec S.r.l.
(*) Model / Type reference	Model TWS Type NN1YH
(*) FCC ID	OQA-TWSNN1YH
(*) Rating(s)	9-36 Vdc
Report	
Tested by (name + signature)	M. Segalla 
Approved by (name + signature)	F. Marenda 

(*) information provided by the customer

1	Summary	
1	Summary.....	2
2	Reference standard	3
3	List of attachments.....	3
4	Deviation(s) from test specification	3
5	Testing location.....	3
6	General description of tested item and testing condition(s)	5
6.1	Photos of the test item.....	6
7	Verdict summary section	9
8	Test conditions	11
8.1	General.....	11
9	Test results	12
9.1	Antenna requirements	12
9.2	Conducted emission	13
9.3	Emissions in restricted frequency bands and in unrestricted frequency bands	19
9.4	20 dB bandwidth.....	39
9.5	Channel separation	42
9.6	Number of hopping channels.....	44
9.7	Time of occupancy	48
9.8	Band edge	51
9.9	Peak Output Power	55

2 Reference standard	
FCC Rules and Regulation Title 47 part 15:2021	--
3 List of attachments	
Attachment 1: Instruments list, measurement uncertainty, judgement of compliance and quality manual references	
4 Deviation(s) from test specification	
None	
5 Testing location	
DEKRA Testing and Certification S.r.l. Via della Fisica, 20 – 36016 Thiene (VI) – Italy Test site facility's FCC registration number: 182474	

<i>Revision index</i>	<i>Date</i>	<i>Change history</i>
1.0	21.06.2023	--

Testing and sampling:	
Date of receipt of test item	28.03.2023
Testing start date	08.06.2023
Testing end date	15.06.2023
Sampling procedure	Sample used for testing chosen by the customer; DEKRA Testing and Certification S.r.l. cannot be considered responsible for the selection of the sample
Internal identification	Adhesive label with the product number P230271
General remarks:	
This report shall not be reproduced, except in full, without the written approval of DEKRA Testing and Certification S.r.l. The test results presented in this report relate only to the object tested. "(see appended table)": refers to a table appended to the report. Throughout this report a comma is used as the decimal separator.	
Possible test case verdicts:	
Test case does not apply to the test object:	N/A (Not Applicable)
Test object does meet the requirement:	P (Pass)
Test object does not meet the requirement:	F (Fail)
Test object does not performed:	N/E (Not Executed)
Definition of symbols used in this test report:	
<input checked="" type="checkbox"/> Indicates that the listed condition, standard or equipment is applicable for this report. <input type="checkbox"/> Indicates that the listed condition, standard or equipment is not applicable for this report.	

6 General description of tested item and testing condition(s)

Description	Transceiver unit						
Model Number	Model TWS Type NN1YH						
FCC ID	OQA-TWSNN1YH						
Serial Number	--						
Brand name	Autec						
Frequency band	902 – 928 MHz						
Nominal frequencies	FL: 915,050 MHz	FM: 921,400 MHz	FH: 927,800 MHz				
Test power supply.....	Voltage and Frequency			Reference poles			
			N	L1	L2	L3	PE
	<input type="checkbox"/>	AC:	<input type="checkbox"/>	<input type="checkbox"/>	<input type="checkbox"/>	<input type="checkbox"/>	<input type="checkbox"/>
	<input type="checkbox"/>	AC:	<input type="checkbox"/>	<input type="checkbox"/>	<input type="checkbox"/>	<input type="checkbox"/>	<input type="checkbox"/>
<input checked="" type="checkbox"/>	DC: 24 V					<input type="checkbox"/>	
Pseudo randomly ordered list of hopping frequencies	See document tws_nn1yh_operational_description-rev0						
Type of equipment	<input checked="" type="checkbox"/> Transmitter unit <input checked="" type="checkbox"/> Receiver unit						
Type of station	<input type="checkbox"/> Portable station <input checked="" type="checkbox"/> Mobile station						
Test arrangements of EUT	<i>Intended operational arrangement(s) of EUT</i>			<i>Test arrangement (see basic standard)</i>			
	<input type="checkbox"/>	Table-top only		Table-top			
	<input type="checkbox"/>	Floor-standing only		Floor-standing			
	<input type="checkbox"/>	Can be floor-standing or table-top		Table-top			
	<input type="checkbox"/>	Rack mounted		In rack or table-top			
<input checked="" type="checkbox"/>	Other, for example wall mounted, ceiling mounted, handheld, body worn		Table-top				
Operating modes	No.	Operating mode of test item					
	1	EUT in continuous transmission at maximum power					
Declination of responsibility	<p>Information relating to the description of the sample, components list and software/hardware version (if reported) are provided by the customer. DEKRA Testing and Certification S.r.l. cannot be considered responsible for these information, for any other document sent by the customer and for any difference between the software version present in the tested sample and that present in the object intended for final sale.</p> <p>In some cases, the software in the tested sample is in a version dedicated exclusively to the test, and therefore does not represent the software installed in the final version of the product.</p>						

6.1 Photos of the test item

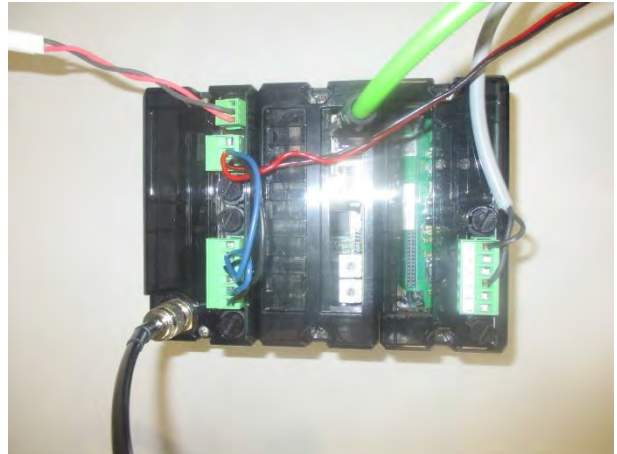
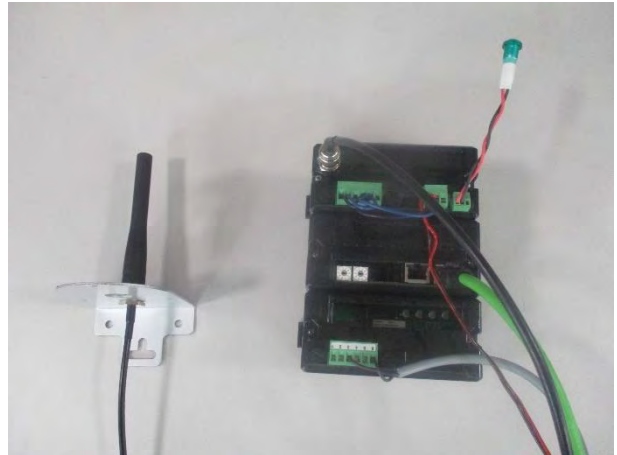
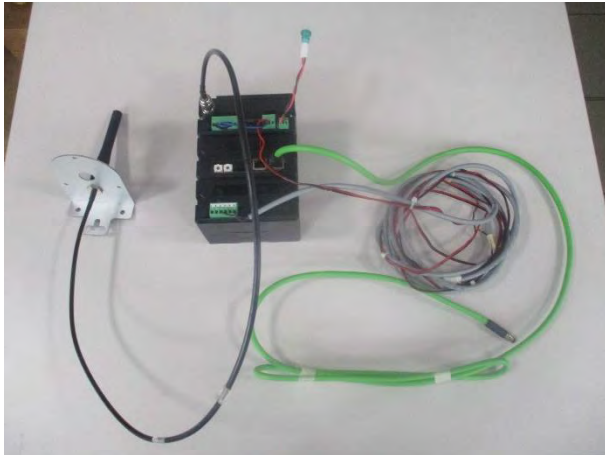

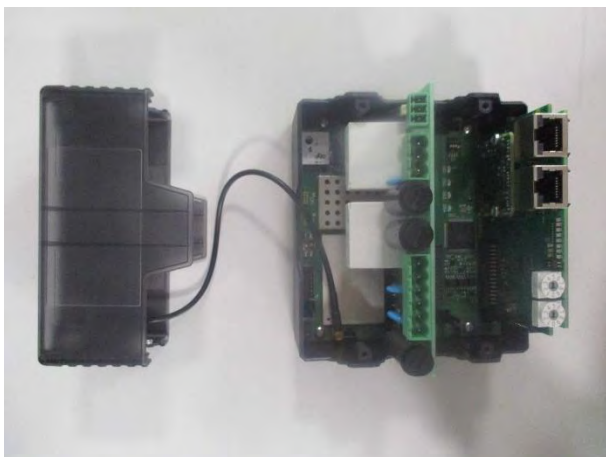
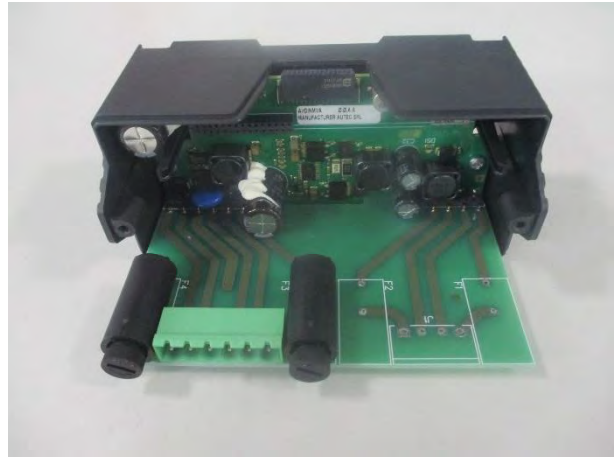

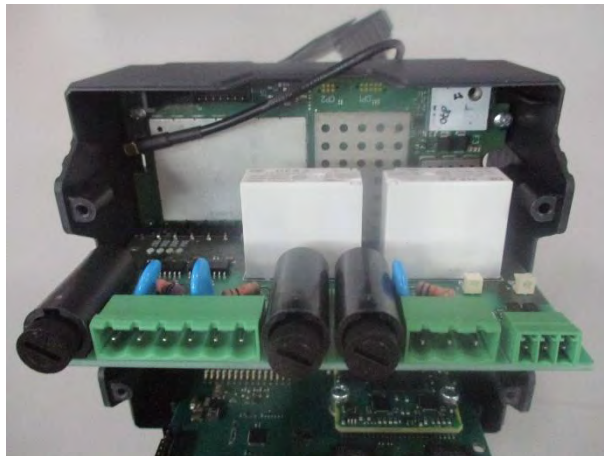

7 Verdict summary section

FCC Rules & Regulations, Title 47:2021			
Part 15 paragraph(s): 203, 204, 205, 207, 209, 215 and 247			
Clause	Requirement – Test case	Basic standard	Verdict
Part 15.247 (a) (1)	Pseudo randomly ordered list of hopping frequencies	--	P
Part 15.203	Antenna requirements	ANSI C63.10	P
Part 15.207	Conducted emissions	ANSI C63.10	P
Part 15.209	Radiated emissions and spurious emission	ANSI C63.10	P
Part 15.247	20 dB Bandwidth	ANSI C63.10	P
Part 15.247	Channel Separation	ANSI C63.10	P
Part 15.247	Number of Hopping Channel	ANSI C63.10	P
Part 15.247	Time of occupancy	ANSI C63.10	P
Part 15.247	Band edge	ANSI C63.10	P
Part 15.209 and 15.247	Peak Output Power	ANSI C63.10	P

Normative references	
Reference no.	Description
FCC Rules and Regulation Title 47 part 15:2021	--
KDB 558074 D01 15.247 Meas Guidance v05r02	Guidance for compliance measurements on Digital Transmission System, Frequency Hopping Spread Spectrum System, and Hybrid System Devices operating under section 15.247 of the FCC rules
ANSI C63.4:2014	American National Standard for Methods of Measuring of Radio-Noise Emissions from Low-Voltage Electrical and Electronic Equipment in the Range of 9 kHz – 40 GHz
ANSI C63.10:2013	American National Standard of Procedures for Compliance Testing of Unlicensed Wireless Devices

8 Test conditions

8.1 General

Environmental reference conditions..... :	The climatic conditions during the tests are within the limits specified by the manufacturer for the operation of the EUT and the test equipment. The climatic conditions during the tests were within the following limits:		
	Temperature	Humidity	Atmospheric pressure
	15 °C – 35 °C	30 % - 60 %	800 hPa – 1060 hPa
	If explicitly required in the basic standard or applied product standard the climatic values are recorded and documented separately in this test report.		
Measurement uncertainties :	Attachment 1		

9 Test results

9.1 Antenna requirements

Tested by	M. Segalla	
Test date	08.06.2023	
Reference standards.....	FCC Rules and Regulation; Titles 47 Part. 15.203 and 15.204	
Test specification	<p>An intentional radiator shall be designed to ensure that no antenna other than that furnished by the responsible party shall be used with the device. The use of a permanently attached antenna or of an antenna that uses a unique coupling to the intentional radiator shall be considered sufficient to comply with the provisions of this section. The manufacturer may design the unit so that a broken antenna can be replaced by the user, but the use of a standard antenna jack or electrical connector is prohibited. This requirement does not apply to carrier current devices or to devices operated under the provisions of §§ 15.211, 15.213, 15.217, 15.219, 15.221, or § 15.236. Further, this requirement does not apply to intentional radiators that must be professionally installed, such as perimeter protection systems and some field disturbance sensors, or to other intentional radiators which, in accordance with § 15.31(d), must be measured at the installation site. However, the installer shall be responsible for ensuring that the proper antenna is employed so that the limits in this part are not exceeded</p>	
Antenna type	<input type="checkbox"/>	Integral antenna
	<input checked="" type="checkbox"/>	External antenna
Antenna gain	1,227 dBi	
External R.F. power amplifier.....	Not Present	

9.2 Conducted emission

Tested by	M. Segalla	
Test date	15.06.2023	
Test location (stand).....	Shielded chamber (CMC A001)	
Reference standards.....	FCC Rules and Regulation; Titles 47 Part. 15.207 ANSI C63.10 cl. 6.2	
Test set-up description.....	<input checked="" type="checkbox"/>	Table top equipment set-up (80 cm above the reference ground plane)
	<input type="checkbox"/>	Floor standing equipment set-up (insulating material up to 12 mm thick)
	<input type="checkbox"/>	False floor installation equipment set-up (insulating material up to 34 cm above the reference ground plane)
Supplementary Test set-up description.....	--	
Test method applied.....	<input checked="" type="checkbox"/>	Artificial mains network, 50 μ H/50 Ω LISN
	<input type="checkbox"/>	Other:

Acceptance limits

<i>Frequency range (MHz)</i>	<i>dB(μV) Quasi-peak</i>	<i>dB(μV) Average</i>
0,15 to 0,50	66 to 56	56 to 46
0,5 to 5	56	46
5 to 30	60	50

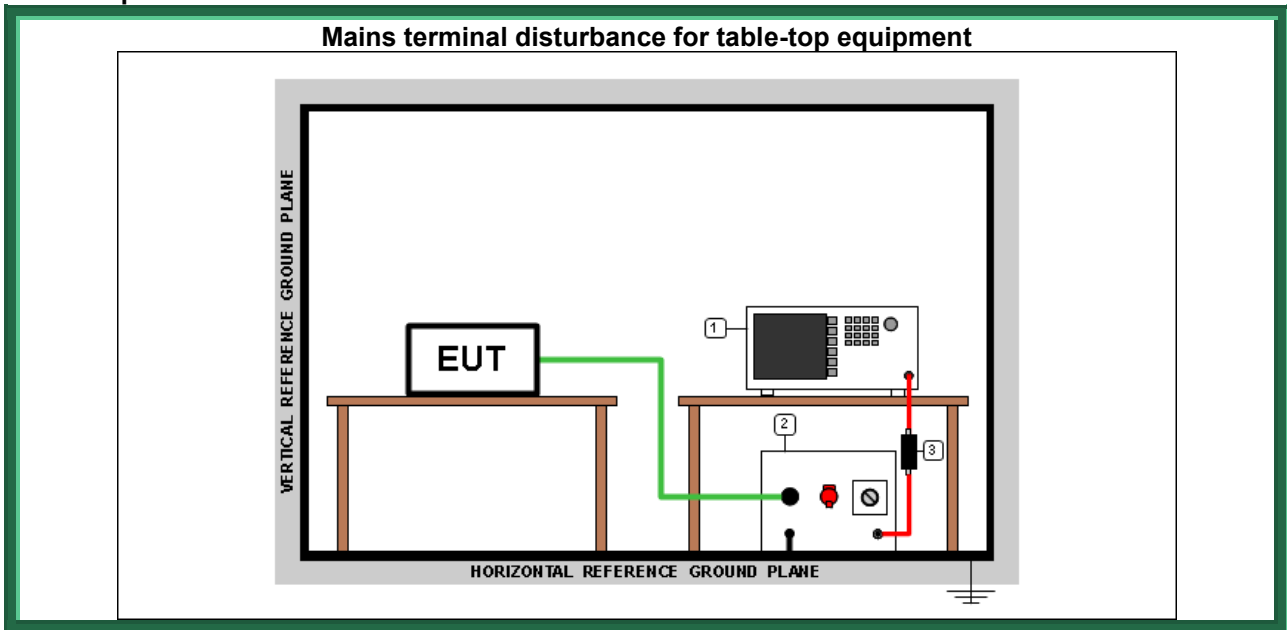
Test setup

Test setup PE001_01

Nr.	Id. Number	Manufacturer	Model	Description
3	CMC S010	Rohde & Schwarz	ESH3-Z2	Pulse limiter
2	CMC S200	Schwarzbeck	NSLK 8128	V-LISN
1	CMC S206	Rohde & Schwarz	ESCI 7	EMC Receiver 9KHz-7GHz

Result

Line	Frequency Range (MHz)	Graphs	Remarks	Result
N	0,15 – 30	G23069035	--	P
L1	0,15 – 30	G23069036	--	P

Remarks: tests performed on 120 Vac side of dedicated power unit Mean While S-60-24

Graphs Legend

PK: Peak; QP [1s] (quasi-peak at 1 second) values are marked with a +

AV: Average; AV [1s] (average at 1 second) values are marked with a X

Graphs

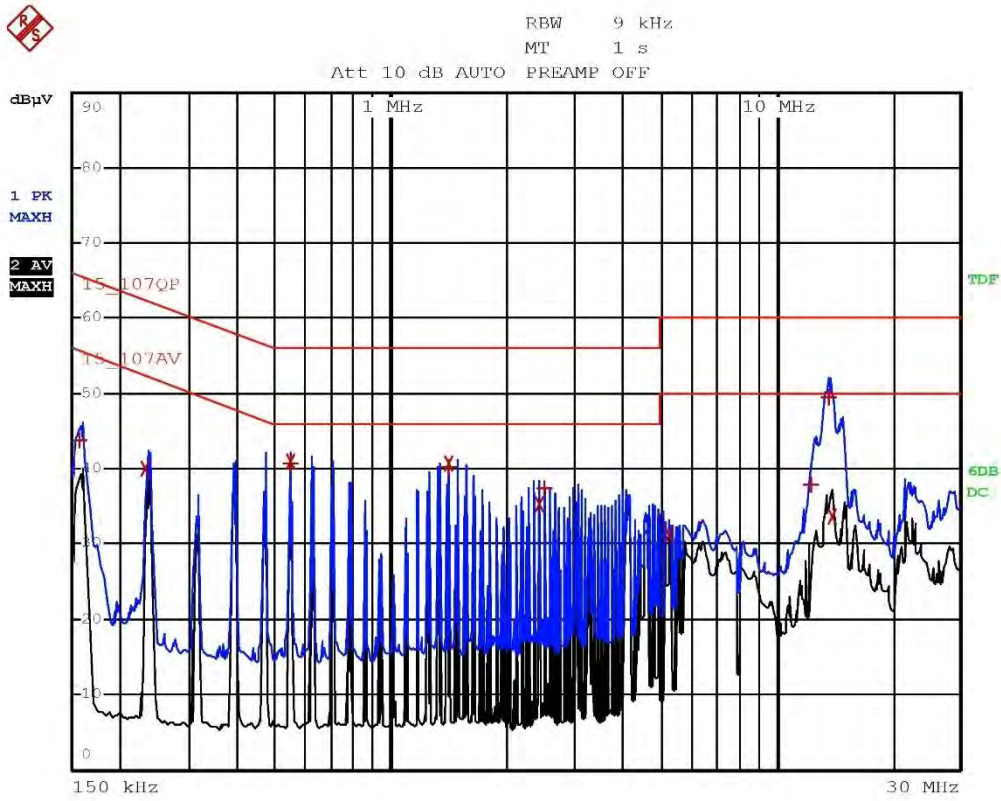

Segalla 23069035

EDIT PEAK LIST (Final Measurement Results)				
Trace1:		15_107QP		
Trace2:		15_107AV		
Trace3:		---		
TRACE		FREQUENCY	LEVEL dBμV	DELTA LIMIT dB
1	Quasi Peak	158 kHz	43.82	-21.74
2	Average	234 kHz	39.93	-12.37
1	Quasi Peak	550 kHz	40.74	-15.25
2	Average	550 kHz	41.02	-4.97
1	Quasi Peak	1.41 MHz	40.38	-15.61
2	Average	1.41 MHz	40.64	-5.35
2	Average	2.43 MHz	35.24	-10.75
1	Quasi Peak	2.506 MHz	37.46	-18.53
2	Average	5.246 MHz	31.26	-18.73
1	Quasi Peak	12.37 MHz	37.95	-22.04
1	Quasi Peak	13.7 MHz	49.37	-10.62
2	Average	14.03 MHz	33.68	-16.32

Segalla 23069035

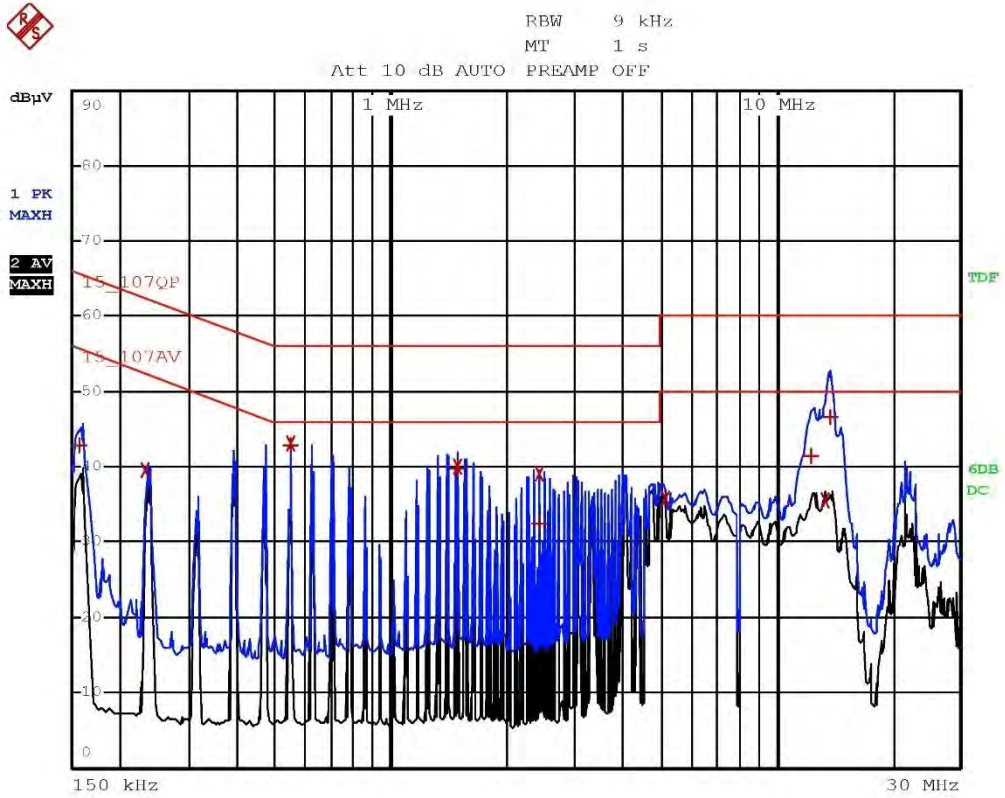

Segalla 23069036

EDIT PEAK LIST (Final Measurement Results)				
Trace1:	15_107QP			
Trace2:	15_107AV			
Trace3:	---			
TRACE	FREQUENCY	LEVEL dBμV	DELTA LIMIT dB	
1 Quasi Peak	158 kHz	42.84	-22.72	
2 Average	234 kHz	39.58	-12.72	
1 Quasi Peak	546 kHz	42.76	-13.23	
2 Average	546 kHz	43.04	-2.95	
1 Quasi Peak	1.486 MHz	39.90	-16.09	
2 Average	1.486 MHz	40.07	-5.92	
2 Average	2.421 MHz	39.07	-6.92	
1 Quasi Peak	2.426 MHz	32.48	-23.51	
2 Average	5.153 MHz	35.68	-14.31	
1 Quasi Peak	12.34 MHz	41.56	-18.43	
2 Average	13.35 MHz	35.54	-14.45	
1 Quasi Peak	13.82 MHz	46.70	-13.29	

Segalla 23069036

9.3 Emissions in restricted frequency bands and in unrestricted frequency bands

Tested by	M. Segalla	
Test date	09.06.2023	
Test location (stand)	Semi-anechoic chamber (CMC A070)	
Reference standards.....	FCC Rules and Regulation; Titles 47 Part. 15.209 ANSI C63.10 cl. 6.3, 6.4, 6.5 and 6.6	
Test set-up description.....	<input checked="" type="checkbox"/>	Table top equipment set-up (80 cm above the reference ground plane)
	<input type="checkbox"/>	Floor standing equipment set-up (insulating material up to 12 mm thick)
	<input type="checkbox"/>	False floor installation equipment set-up (insulating material up to 34 cm above the reference ground plane)
Supplementary test set-up description.....	--	
Test method applied	OATS or SAC with measurement distance [m]: 10 m for frequencies below 1 GHz 3 m for frequencies above 1 GHz	
Supplementary information	--	

Acceptance limits

Acceptance limits for emissions in restricted frequency bands ($f < 1000$ MHz)		
Frequency range (MHz)	Test distance (m)	Limits [dB(μ V/m)]
0,009 to 0,490	300	$20\log(2400/F(\text{kHz}))$
0,490 to 1,705	30	$20\log(24000/F(\text{kHz}))$
1,705 to 30	30	$20\log(30)$
30 to 88	3	$20\log(100)^{**}$
88 to 216	3	$20\log(150)^{**}$
216 to 960	3	$20\log(200)^{**}$
Above 960	3	$20\log(500)$

** : except as provided in paragraph (g), fundamental emissions from intentional radiators operating under this section shall not be located in the frequency bands 54 – 72 MHz, 76 – 88 MHz, 174 – 216 MHz or 470 – 806 MHz. However, operation within these frequency bands is permitted under other sections of this part, e.g., §§ 15.231 and 15.241.

Perimeter protection systems may operate in the 54 – 72 MHz and 76 – 88 MHz bands under the provisions of this section. The use of such perimeter protection systems is limited to industrial, business and commercial applications.

Remarks: the emission limits shown in the above table are based on measurements employing a CISPR quasi-peak detector except for the frequency bands 9 – 90 kHz and 110 – 490 kHz. Radiated emission limits in these two bands are based on measurements employing an average detector. The results have been extrapolated to the specified distance using an extrapolation factor

Acceptance limits for emissions in restricted frequency bands ($f \geq 1000$ MHz)			
Frequency (MHz)	Test distance (m)	AV limits [dB(μ V/m)]	Peak limits [dB(μ V/m)]
> 1000	3	54	74

The restricted frequency bands are listed in the following table

MHz	MHz	MHz	GHz
0,090 – 0,110	16,42 – 16,423	399,9 – 410	4,5 – 5,15
0,495 – 0,505	16,69475 – 16,69525	608 – 614	5,35 – 5,46
2,1735 – 2,1905	16,80425 – 16,80475	960 – 1240	7,25 – 7,75
4,125 – 4,128	25,5 – 25,67	1300 – 1427	8,025 – 8,5
4,17725 – 4,17775	37,5 – 38,25	1435 – 1626,5	9,0 – 9,2
4,20725 – 4,20775	73 – 74,6	1645,5 – 1646,5	9,3 – 9,5
6,215 – 6,218	74,8 – 75,2	1660 – 1710	10,6 – 12,7
6,26775 – 6,26825	108 – 121,94	1718,8 – 1722,2	13,25 – 13,4
6,31175 – 6,31225	123 – 138	2200 – 2300	14,47 – 14,5
8,291 – 8,294	149,9 – 150,05	2310 – 2390	15,35 – 16,2
8,362 – 8,366	156,52475 – 156,52525	2483,5 – 2500	17,7 – 21,4
8,37625 – 8,38675	156,7 – 156,9	2690 – 2900	22,01 – 23,12
8,41425 – 8,41475	162,0125 – 167,17	3260 – 3267	23,6 – 24,0
12,29 – 12,293	167,72 – 173,2	3332 – 3339	31,2 – 31,8
12,51975 – 12,52025	240 – 285	3345,8 – 3358	36,43 – 36,5
12,57675 – 12,57725	322 – 335,4	3600 – 4400	Above 38,6
13,36 – 13,41			

Acceptance limits for emissions in non-restricted frequency bands

In any 100 kHz bandwidth outside the frequency band in which the spread spectrum or digitally modulated intentional radiator is operating, the radio frequency power that is produced by the intentional radiator shall be at least 20 dB below that in the 100 kHz bandwidth within the band that contains the highest level of the desired power, based on either an RF conducted or a radiated measurement, provided the transmitter demonstrates compliance with the peak conducted power limits.

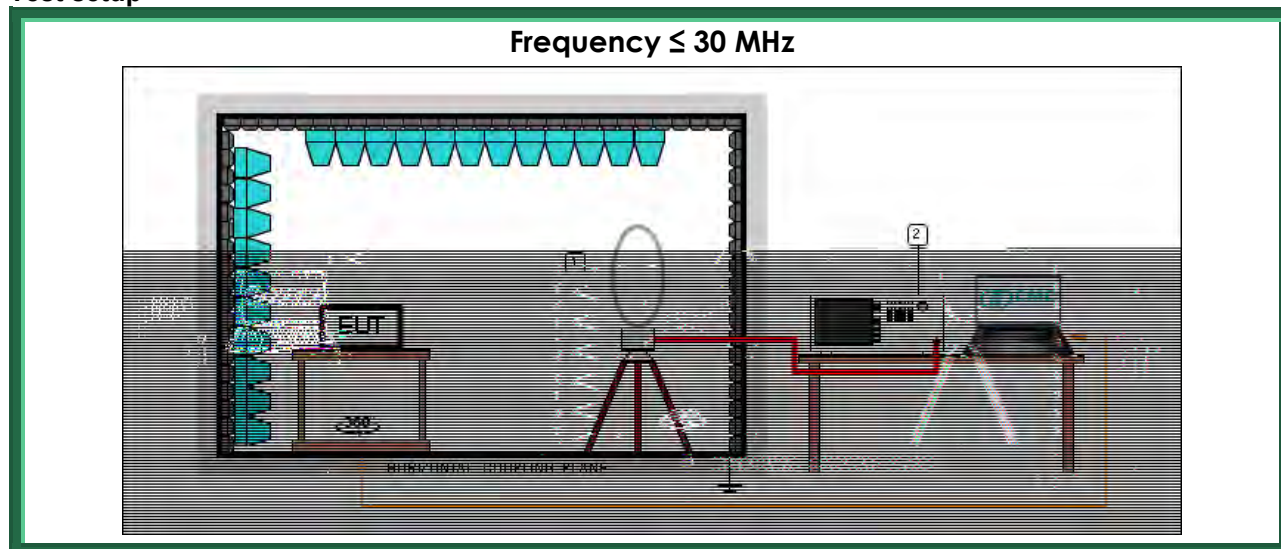
Test setup

Test setup PE004_01

Nr.	Id. Number	Manufacturer	Model	Description
2	CMC S353	Rohde & Schwarz	ESW26	EMI Test Receiver 1 Hz - 26.5 GHz
1	CMC S127	Schaffner	HLA6120	Loop Antenna 9kHz - 30MHz

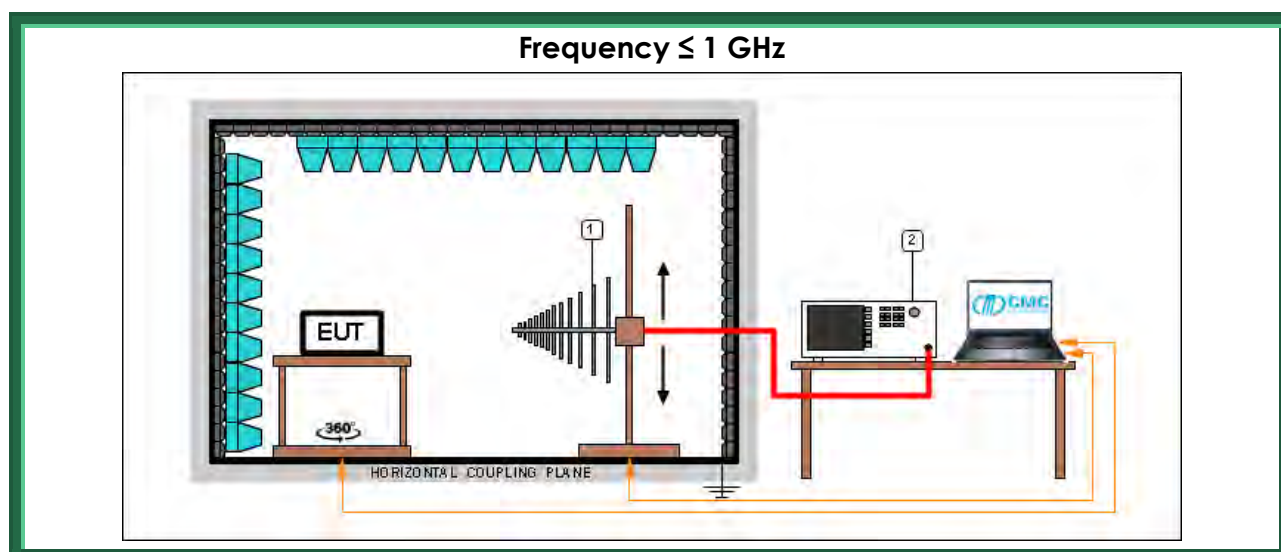

Test setup PE004_02

Nr.	Id. Number	Manufacturer	Model	Description
2	CMC S353	Rohde & Schwarz	ESW26	EMI Test Receiver 1 Hz - 26.5 GHz
1	CMC S271	Schwarzbeck	BBA 9106 + VHBB 9124	Broadband Antenna

Test setup PE004_03

Nr.	Id. Number	Manufacturer	Model	Description
2	CMC S353	Rohde & Schwarz	ESW26	EMI Test Receiver 1 Hz - 26.5 GHz
1	CMC S287	Schwarzbeck	VUSLP 9111B	Broadband Antenna

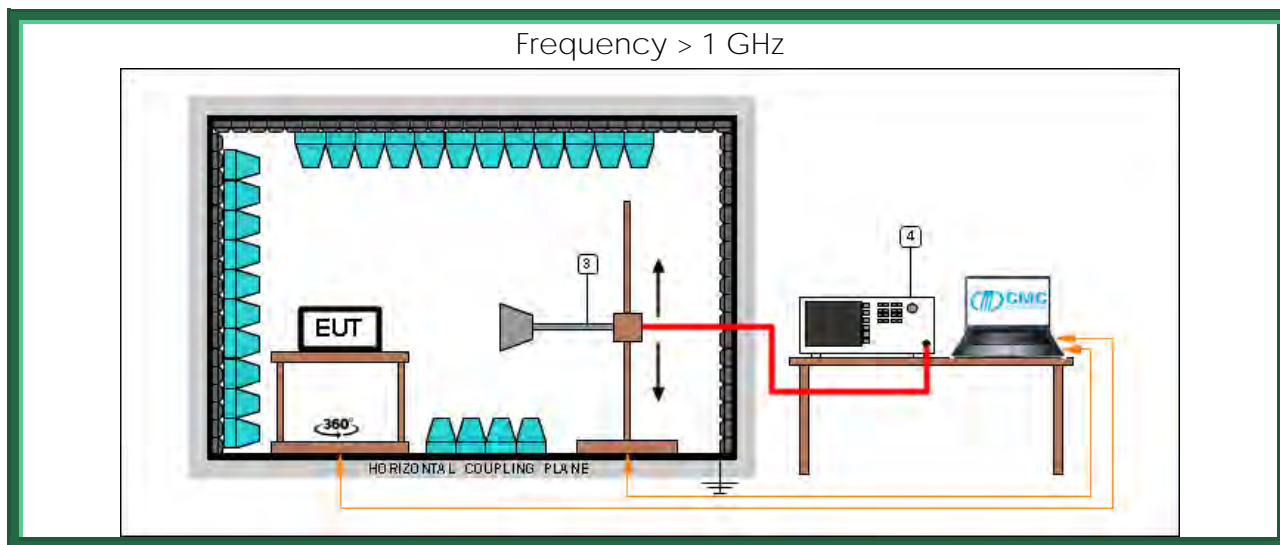

Test setup PE004_04

<i>Nr.</i>	<i>Id. Number</i>	<i>Manufacturer</i>	<i>Model</i>	<i>Description</i>
4	CMC S353	Rohde & Schwarz	ESW26	EMI Test Receiver 1 Hz - 26.5 GHz
3	CMC S108	Emco	3115	Waveguide antenna

Test setup PE004_05

<i>Nr.</i>	<i>Id. Number</i>	<i>Manufacturer</i>	<i>Model</i>	<i>Description</i>
4	CMC S353	Rohde & Schwarz	ESW26	EMI Test Receiver 1 Hz - 26.5 GHz
3	CMC S290	Schwarzbeck	BBHA 9170	Horn Antenna (15-40 GHz)

Result

<i>Transmission channel (MHz)</i>	<i>Polarization</i>	<i>Frequency Range (MHz)</i>	<i>Graphs</i>	<i>Result</i>
915,05	V	1000 – 10000	G23069001	P
915,05	H	1000 – 10000	G23069002	P
921,40	H	1000 – 10000	G23069003	P
921,40	V	1000 – 10000	G23069004	P
927,80	V	1000 – 10000	G23069005	P
927,80	H	1000 – 10000	G23069006	P
Worst case	Loop	0,009 – 30	G23069007	P
Worst case	V	30 – 300	G23069008	P
Worst case	H	30 – 300	G23069009	P
915,05	H	300 – 1000	G23069010	P
915,05	V	300 – 1000	G23069011	P
921,40	V	300 – 1000	G23069012	P
921,40	H	300 – 1000	G23069013	P
927,80	H	300 – 1000	G23069014	P
927,80	V	300 – 1000	G23069015	P

Remarks: EUT was tested in 3 orthogonal planes, graphs are related to the highest detected levels. Measurements at frequencies lower than 30 MHz have been performed with an EUT – antenna distance of 10 m. Measured values have been corrected with conversion factor $40\log(\text{test distance}/10)$ based on the measuring distance provided by the standard.

Measurements at frequencies higher than 30 MHz and lower than 1000 MHz have been performed with an EUT – antenna distance of 10 m. Measured values have been corrected with conversion factor $20\log(\text{test distance}/10)$ based on the measuring distance provided by the standard.

Peaks above the limits are caused by the nominal transmitting frequencies

Graphs Legend

PK: Peak; QP [1s] (quasi-peak at 1 second) values are marked with a +

AV: Average; AV [1s] (average at 1 second) values are marked with a X

Graphs

SegaLLa 23069001

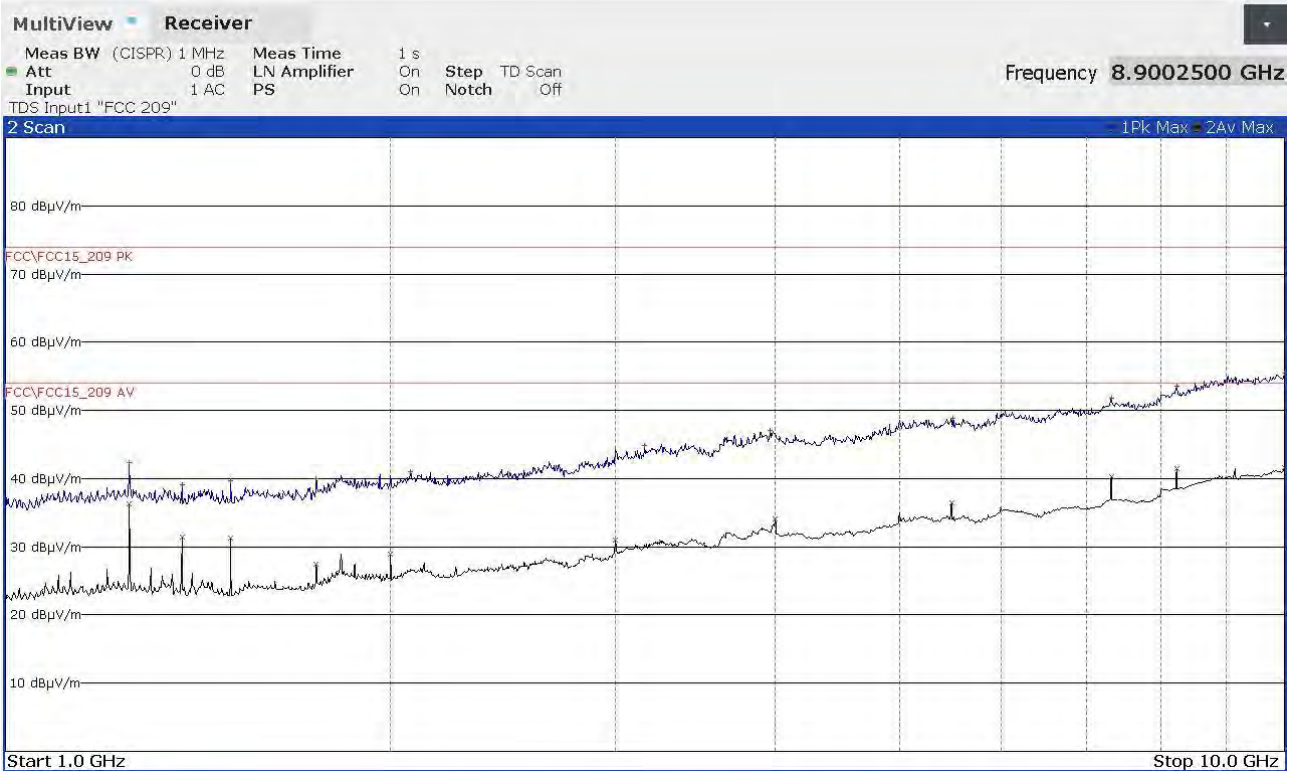

FINAL RESULT TABLE

MAX PEAK			AVERAGE		
Freq Hz	Lev dBuV/m	Margin dB	Freq Hz	Lev dBuV/m	Margin dB
1250000000	+42,33	-31,65	1250000000	+36,32	-17,66
1375000000	+39,05	-34,93	1375000000	+31,39	-22,59
1500000000	+39,74	-34,24	1500000000	+31,30	-22,68
1750000000	+39,95	-34,03	1750000000	+27,47	-26,51
2073250000	+40,97	-33,01	2000000000	+28,96	-25,02
3158500000	+44,82	-29,16	2998250000	+31,02	-22,96
3963750000	+47,02	-26,96	3999750000	+34,11	-19,87
5508250000	+48,82	-25,16	5490250000	+36,49	-17,49
7320250000	+51,82	-22,16	7320500000	+40,29	-13,69
8235500000	+53,54	-20,44	8235500000	+41,53	-12,45
9997250000	+55,45	-18,53	10000000000	+41,55	-12,43

23069001_2

Segalla 23069002

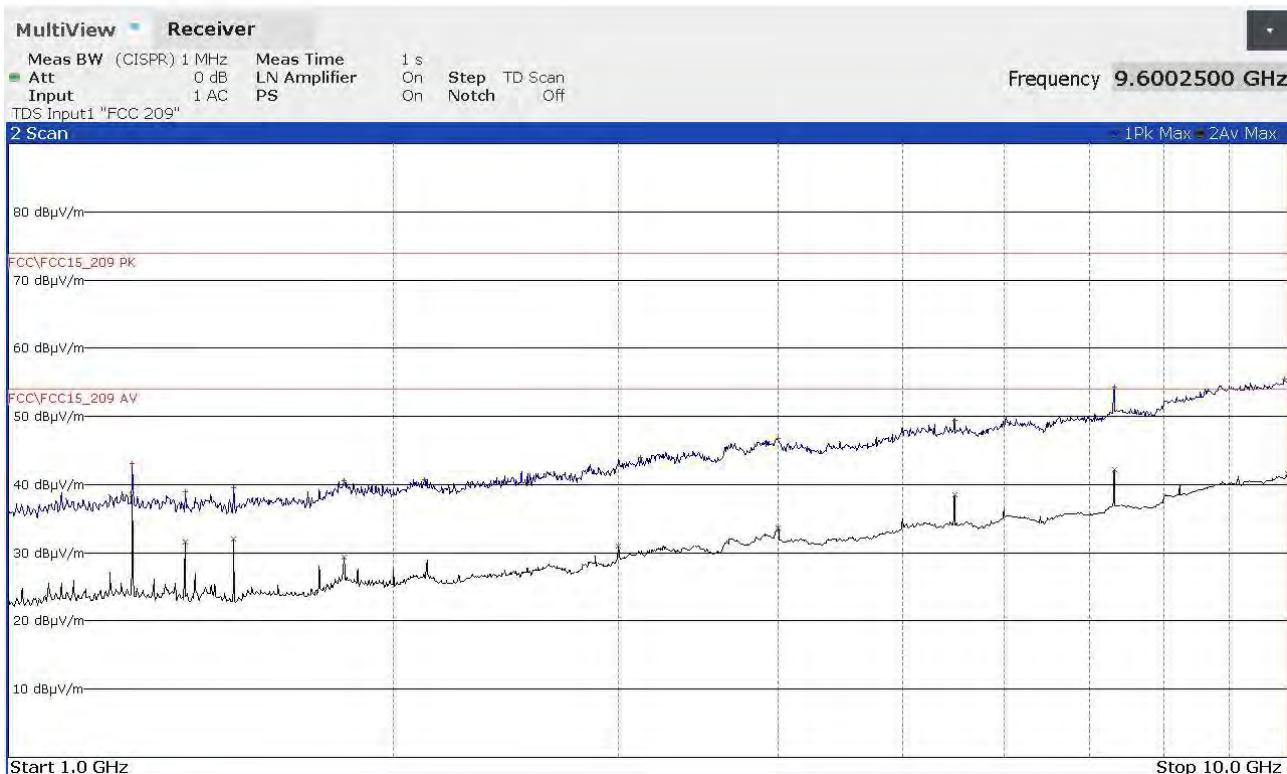

FINAL RESULT TABLE

MAX PEAK			AVERAGE		
Freq Hz	Lev dBuV/m	Margin dB	Freq Hz	Lev dBuV/m	Margin dB
1250000000	+43,12	-30,86	1250000000	+38,45	-15,53
1375000000	+38,97	-35,01	1375000000	+31,58	-22,40
1500000000	+39,57	-34,41	1500000000	+32,03	-21,95
1830250000	+40,58	-33,40	1830000000	+29,41	-24,57
2116250000	+40,73	-33,25	2998250000	+31,04	-22,94
3121750000	+43,97	-30,01	3999750000	+33,71	-20,27
3997000000	+46,72	-27,26	5490250000	+38,56	-15,42
5490500000	+49,40	-24,58	7320500000	+42,20	-11,78
7320500000	+54,24	-19,74	10000000000	+41,54	-12,44
9937250000	+55,46	-18,52			

23069002_2

Segalla 23069003

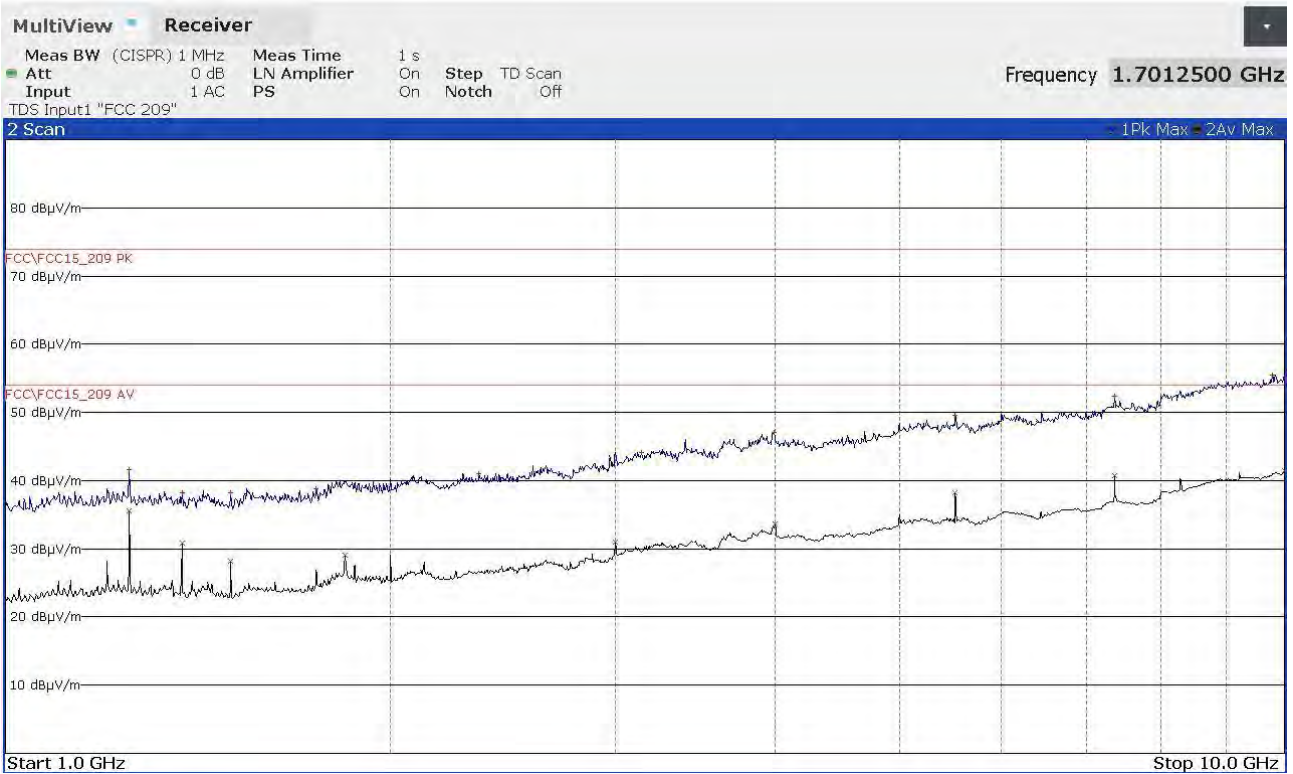

FINAL RESULT TABLE

MAX PEAK			AVERAGE		
Freq Hz	Lev dBuV/m	Margin dB	Freq Hz	Lev dBuV/m	Margin dB
1250000000	+41,68	-32,30	1250000000	+35,62	-18,36
1375250000	+38,16	-35,82	1375000000	+30,77	-23,21
1499750000	+38,28	-35,70	1500000000	+28,20	-25,78
1750250000	+38,83	-35,15	1842750000	+29,13	-24,85
2343000000	+41,08	-32,90	2998250000	+31,02	-22,96
3141000000	+44,17	-29,81	3999750000	+33,60	-20,38
3987000000	+47,05	-26,93	5528500000	+38,22	-15,76
5528250000	+49,64	-24,34	7371250000	+40,65	-13,33
7371250000	+52,43	-21,55	9999500000	+41,51	-12,47
9791250000	+55,49	-18,49			

23069003_2

Segalla 23069004

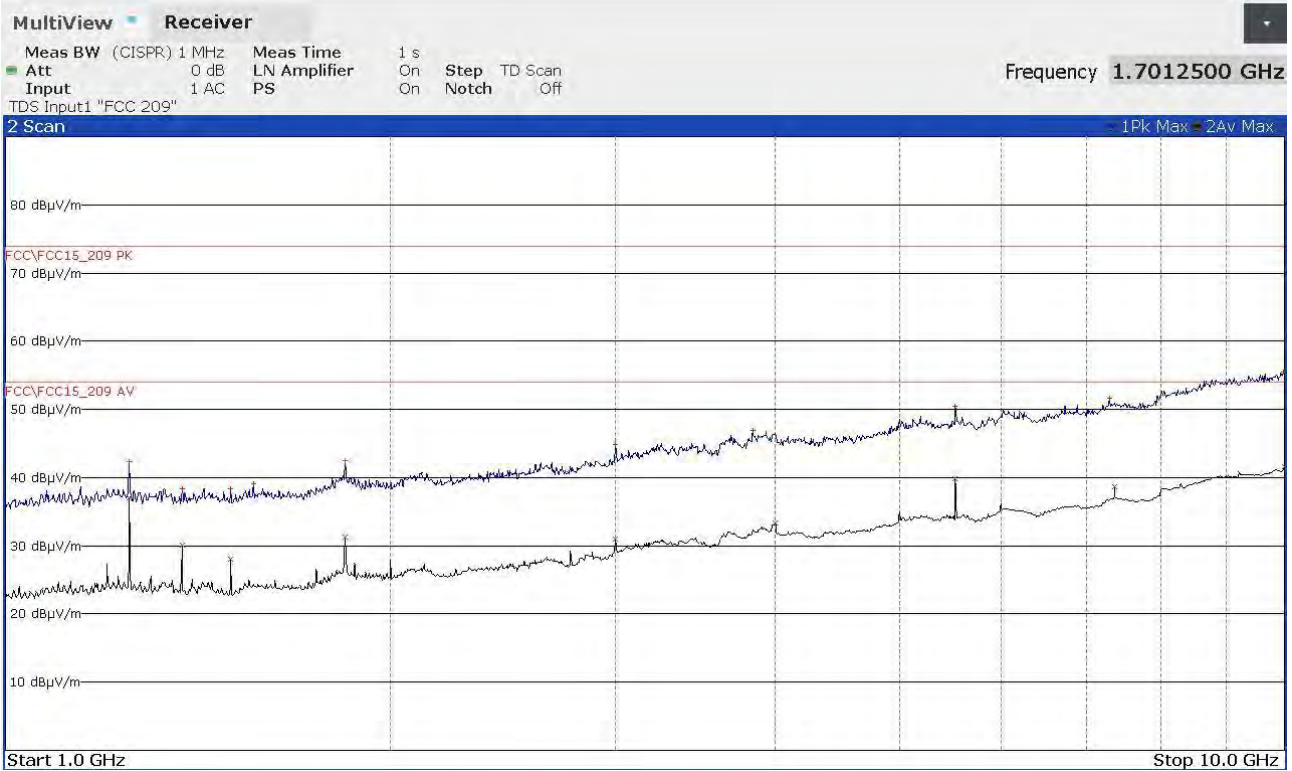

FINAL RESULT TABLE

MAX PEAK			AVERAGE		
Freq Hz	Lev dBuV/m	Margin dB	Freq Hz	Lev dBuV/m	Margin dB
1250000000	+42,29	-31,69	1250000000	+37,09	-16,89
1375000000	+38,37	-35,61	1375000000	+30,09	-23,89
1500000000	+38,32	-35,66	1500000000	+27,97	-26,01
1562750000	+39,14	-34,84	1842750000	+31,33	-22,65
1842750000	+42,49	-31,49	2998250000	+31,00	-22,98
2998750000	+44,89	-29,09	3999750000	+33,33	-20,65
3838250000	+46,91	-27,07	5528500000	+39,84	-14,14
5528500000	+50,44	-23,54	7371250000	+38,68	-15,30
7296500000	+51,57	-22,41	10000000000	+41,54	-12,44
9978500000	+55,44	-18,54			

23069004_2

Segalla 23069005

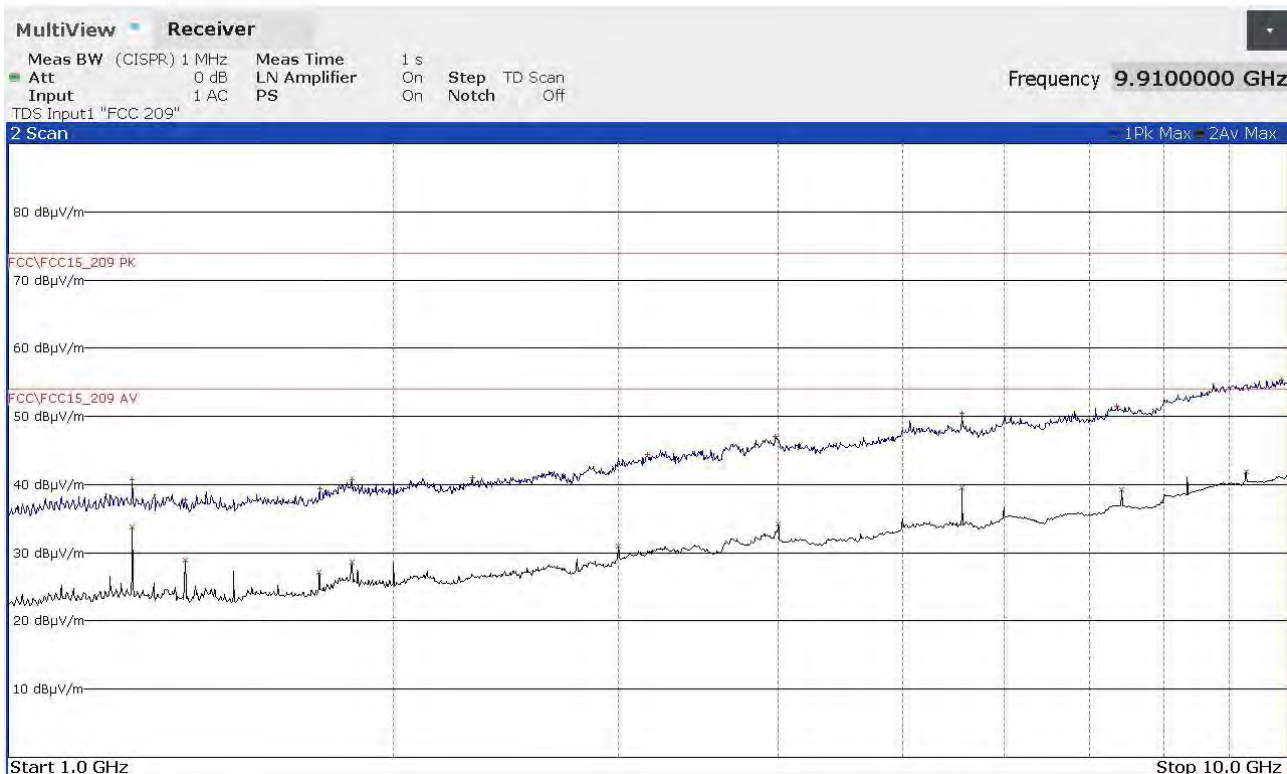

FINAL RESULT TABLE

MAX PEAK			AVERAGE		
Freq Hz	Lev dBuV/m	Margin dB	Freq Hz	Lev dBuV/m	Margin dB
125000000	+40,66	-33,32	125000000	+33,75	-20,23
137500000	+37,81	-36,17	137500000	+28,92	-25,06
175100000	+39,35	-34,63	175000000	+27,08	-26,90
185550000	+40,71	-33,27	185550000	+28,66	-25,32
230550000	+41,05	-32,93	299825000	+30,99	-22,99
315800000	+44,40	-29,58	399975000	+34,19	-19,79
397850000	+47,11	-26,87	556675000	+39,51	-14,47
556675000	+50,40	-23,58	742250000	+39,30	-14,68
735550000	+51,47	-22,51	927800000	+41,89	-12,09
989975000	+55,38	-18,60			

23069005_2

Segalla 23069006

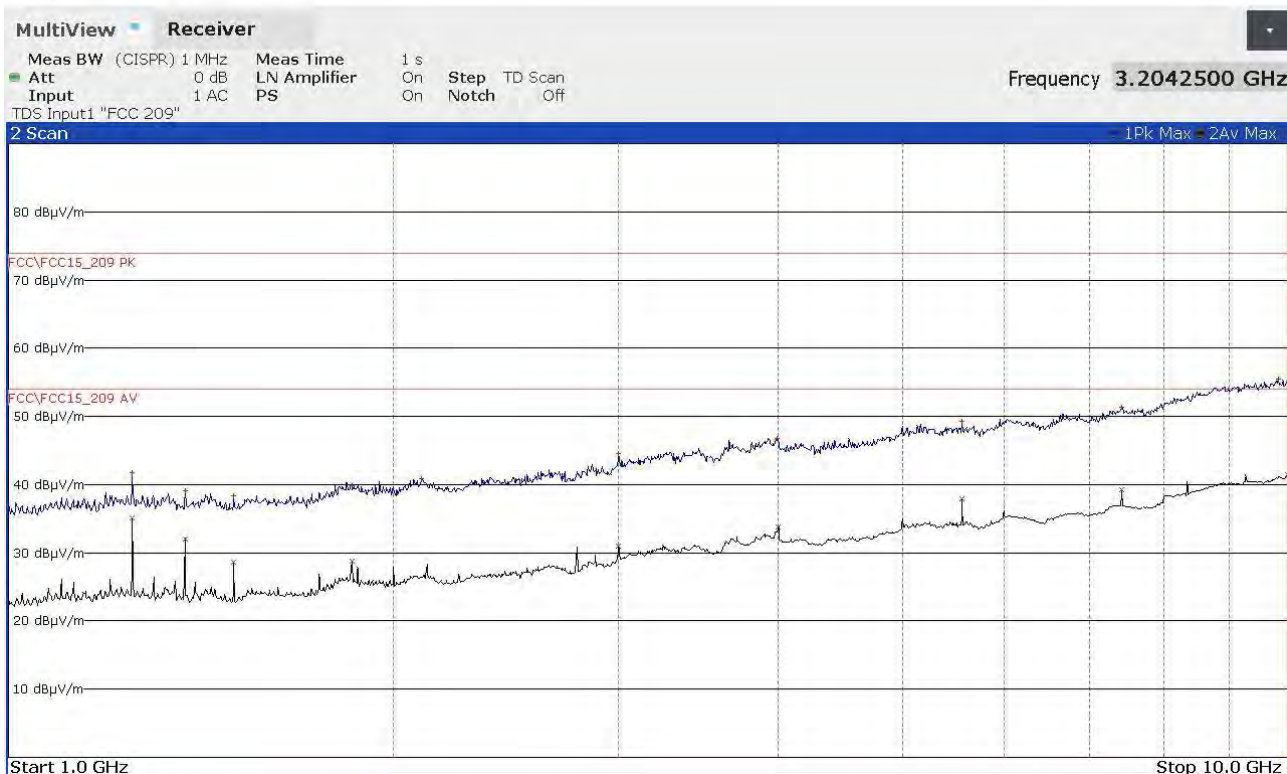

FINAL RESULT TABLE

MAX PEAK			AVERAGE		
Freq Hz	Lev dBuV/m	Margin dB	Freq Hz	Lev dBuV/m	Margin dB
1250000000	+41,73	-32,25	1250000000	+35,11	-18,87
1374750000	+39,14	-34,84	1375000000	+32,09	-21,89
1500000000	+38,41	-35,57	1500000000	+28,61	-25,37
1855500000	+39,83	-34,15	1855500000	+28,74	-25,24
2104750000	+40,91	-33,07	2999750000	+31,04	-22,94
2999250000	+44,54	-29,44	3999750000	+33,79	-20,19
3988750000	+46,83	-27,15	5566750000	+37,98	-16,00
5566750000	+49,26	-24,72	7422500000	+39,22	-14,76
7422500000	+51,37	-22,61	10000000000	+41,49	-12,49
9834500000	+55,45	-18,53			

23069006_2

Segalla 23069007

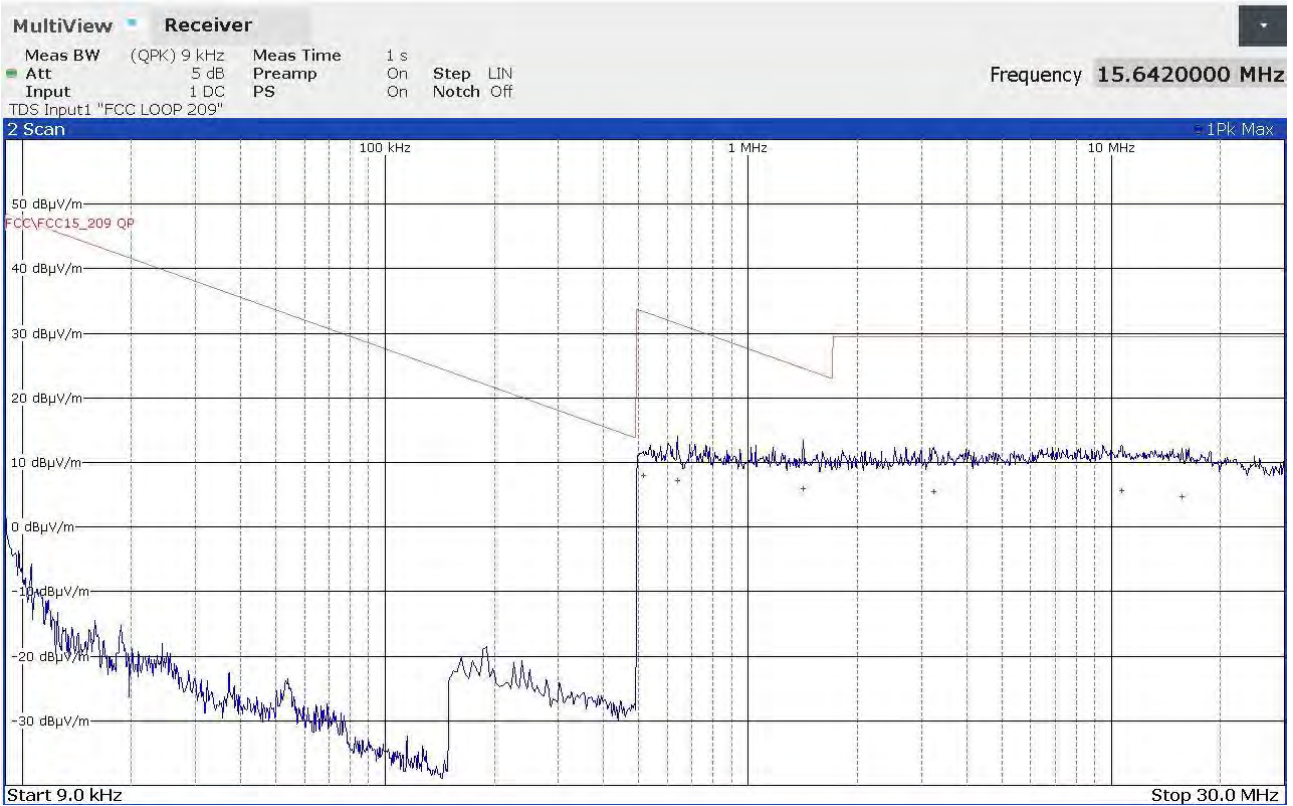

FINAL RESULT TABLE

QUASI PEAK

Freq Hz	Lev dBuV/m	Margin dB
514000	+8,05	-25,33
638000	+7,25	-24,26
1418000	+5,93	-18,64
3242000	+5,46	-24,08
10654000	+5,68	-23,86
15642000	+4,78	-24,76

23069007_2

Segalla 23069008

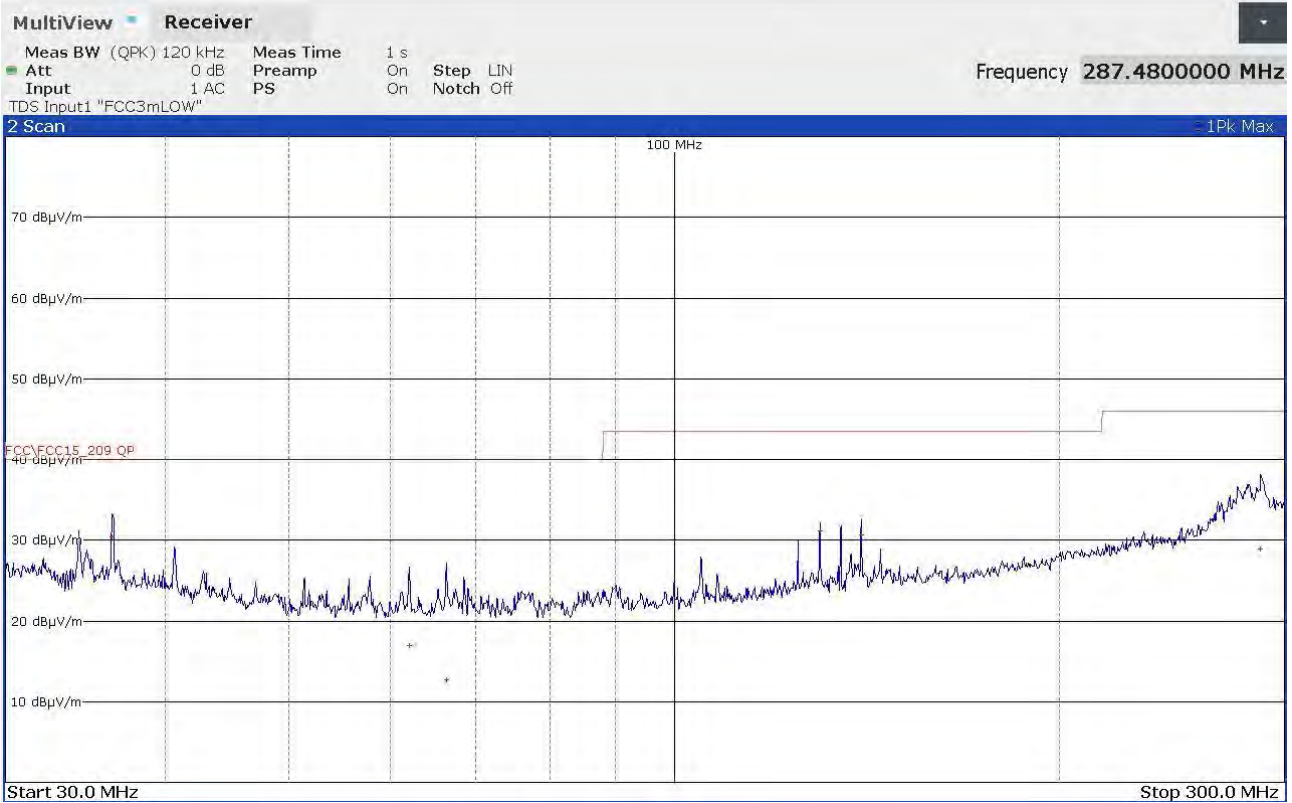

FINAL RESULT TABLE

QUASI PEAK		
Freq Hz	Lev dBuV/m	Margin dB
36360000	+30,46	-9,54
62040000	+16,90	-23,10
66360000	+12,76	-27,24
130000000	+31,13	-12,39
140000000	+30,62	-12,90
287480000	+28,88	-17,14

23069008_2

Segalla 23069009

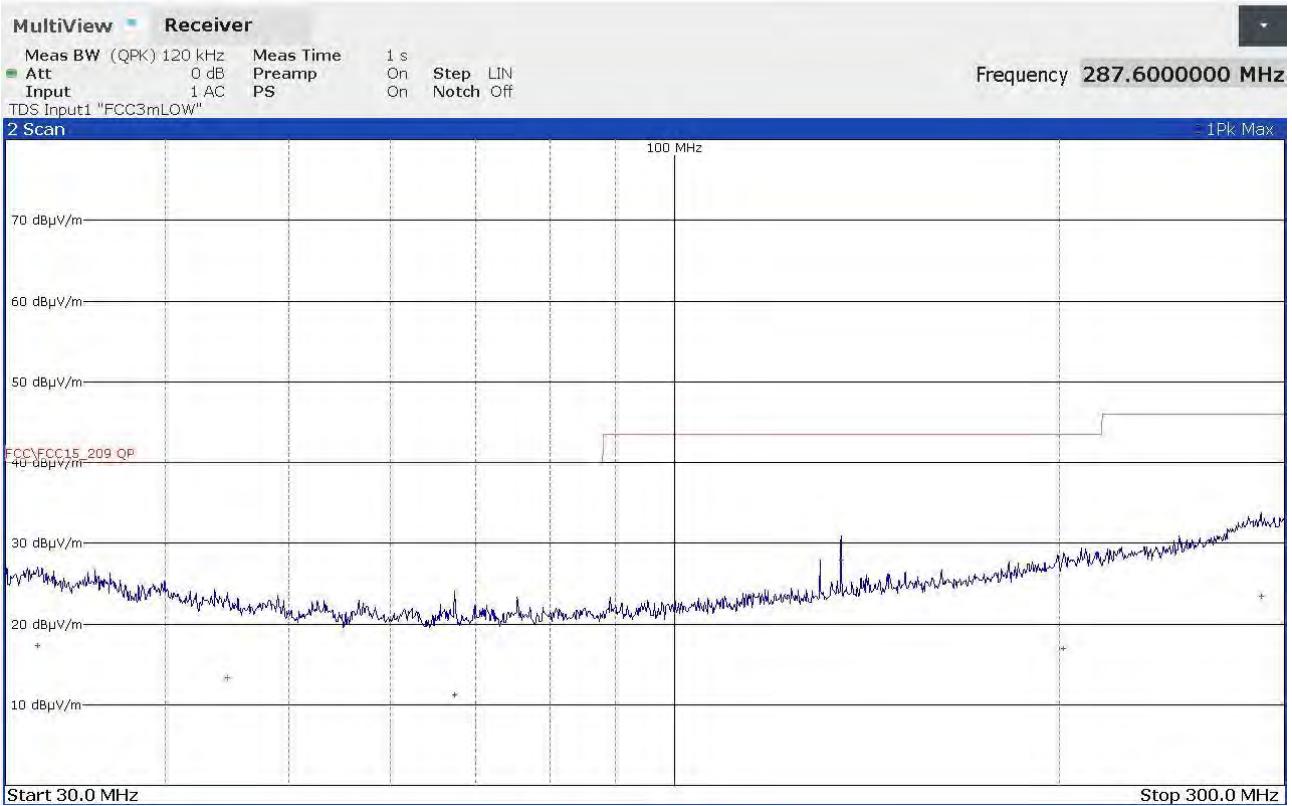

FINAL RESULT TABLE

QUASI PEAK		
Freq Hz	Lev dBuV/m	Margin dB
31800000	+17,26	-22,74
44760000	+13,33	-26,67
67360000	+11,26	-28,74
135000000	+27,96	-15,56
201600000	+16,94	-26,58
287600000	+23,41	-22,61

23069009_2

Segalla 23069010

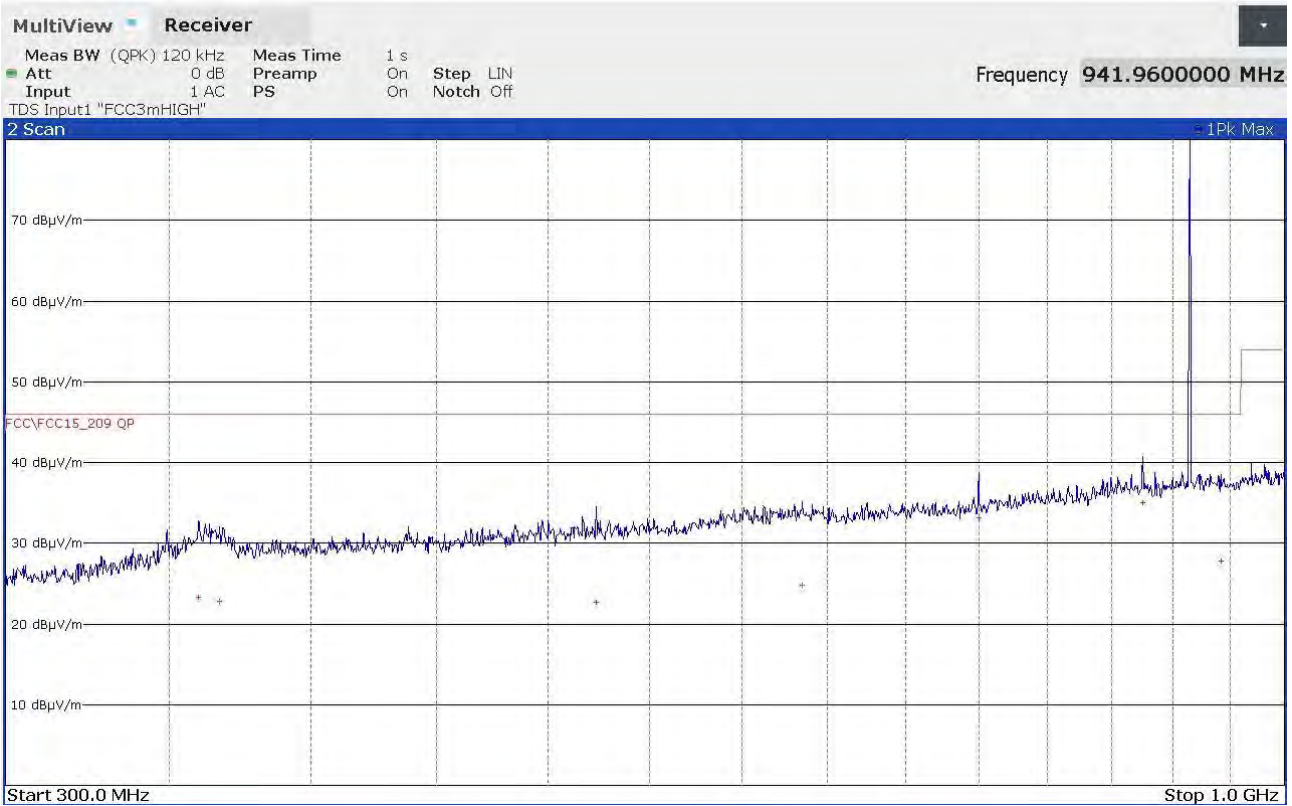

FINAL RESULT TABLE

QUASI PEAK		
Freq Hz	Lev dBuV/m	Margin dB
359880000	+23,33	-22,69
367040000	+22,76	-23,26
523120000	+22,62	-23,40
635280000	+24,78	-21,24
749960000	+33,09	-12,93
875040000	+35,07	-10,95
941960000	+27,73	-18,29

23069010_2

Segalla 23069011

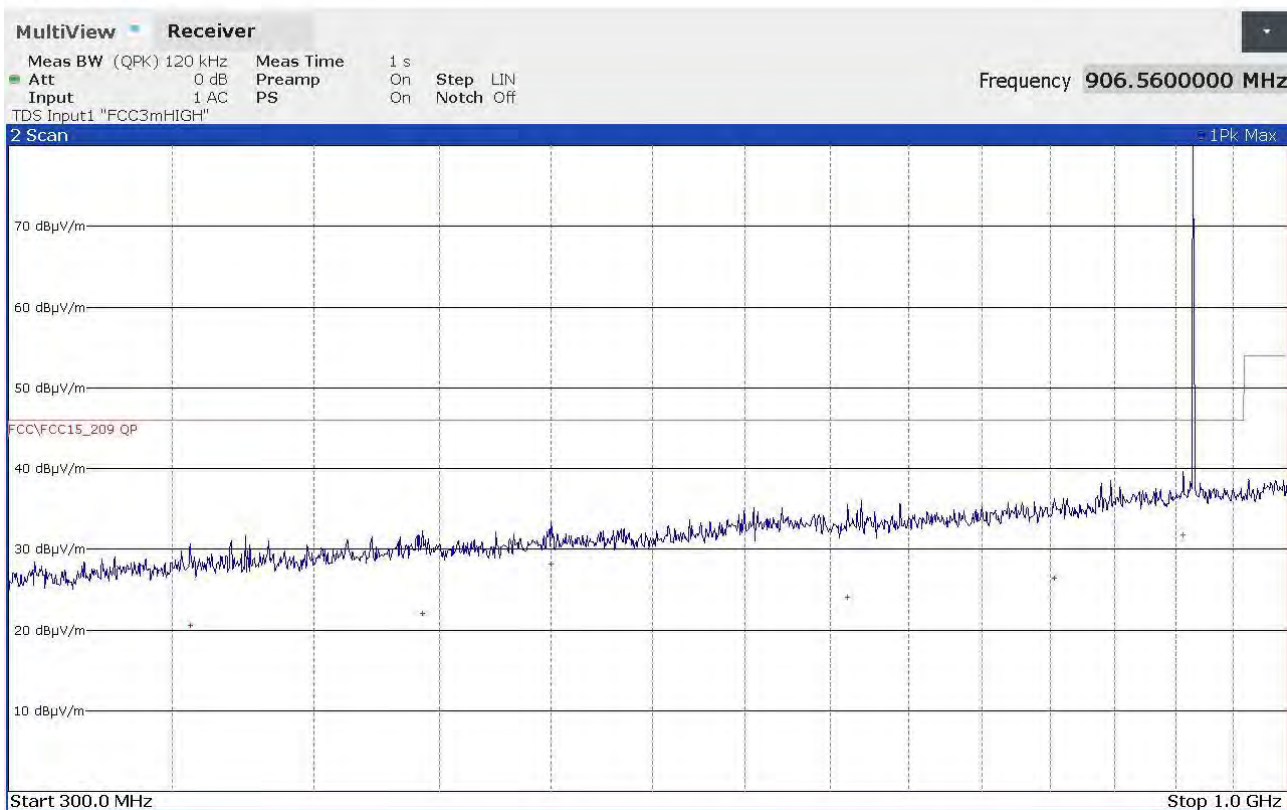

FINAL RESULT TABLE

QUASI PEAK		
Freq Hz	Lev dBuV/m	Margin dB
355880000	+20,57	-25,45
443000000	+22,05	-23,97
500040000	+28,10	-17,92
660960000	+24,04	-21,98
802840000	+26,40	-19,62
906560000	+31,81	-14,21

23069011_2

Segalla 23069012

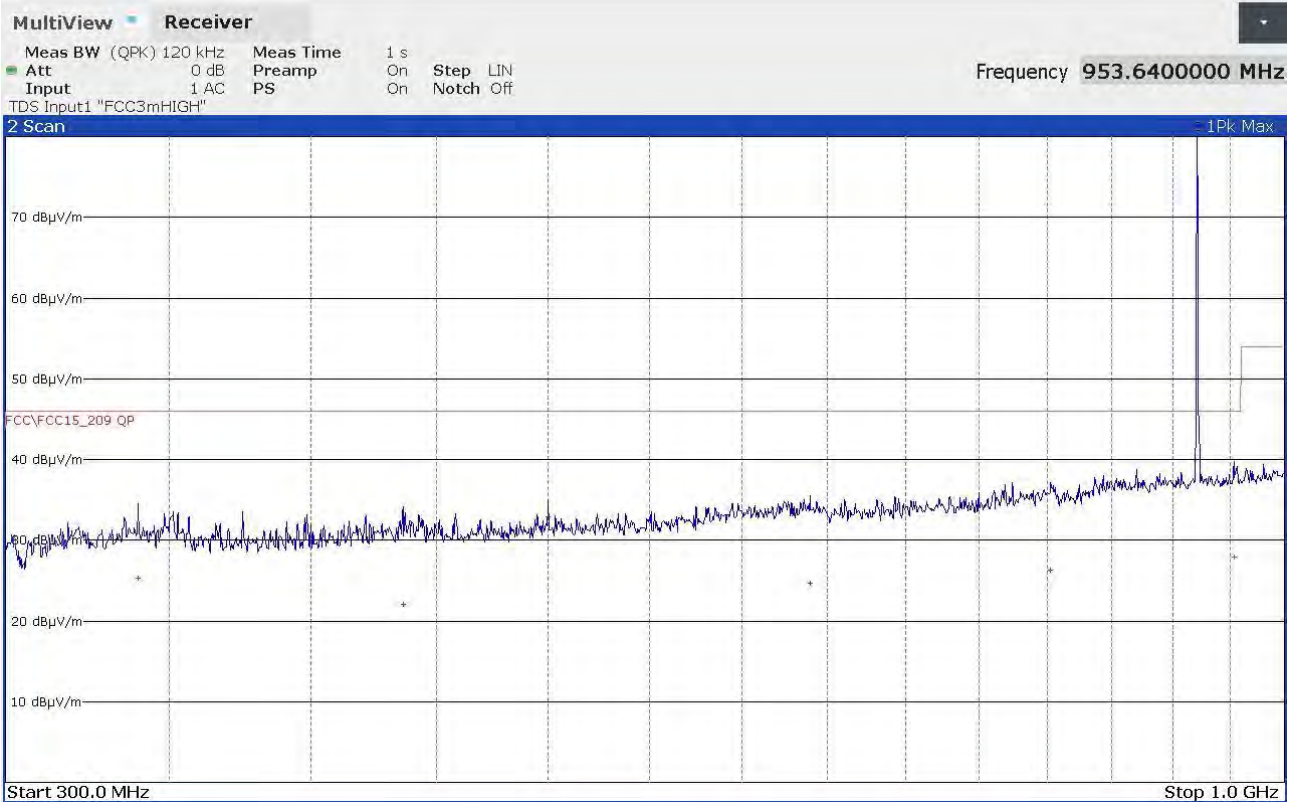

FINAL RESULT TABLE

QUASI PEAK		
Freq Hz	Lev dBuV/m	Margin dB
339960000	+25,27	-20,75
436160000	+22,04	-23,98
500000000	+32,88	-13,14
639960000	+24,69	-21,33
802320000	+26,29	-19,73
953640000	+27,88	-18,14

23069012_2

Segalla 23069013

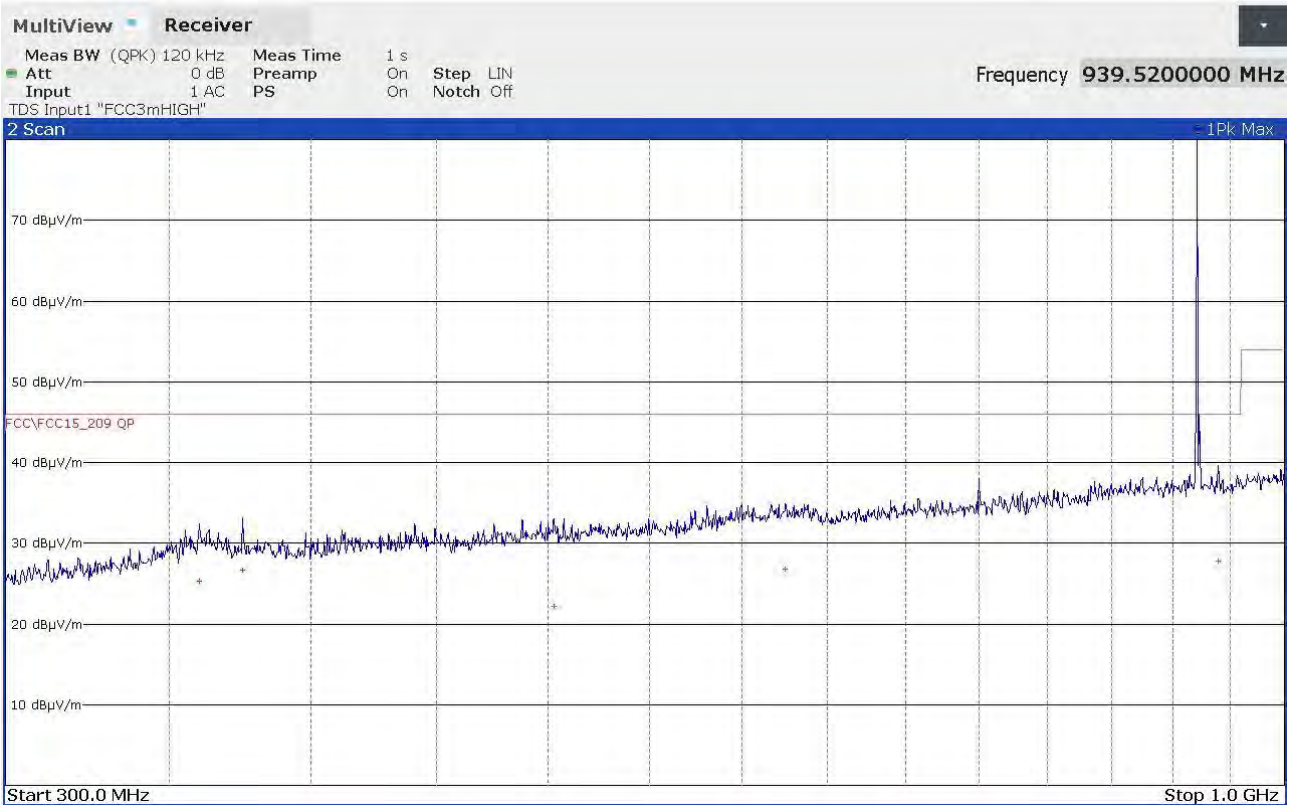

FINAL RESULT TABLE

QUASI PEAK		
Freq Hz	Lev dBuV/m	Margin dB
360040000	+25,26	-20,76
375000000	+26,70	-19,32
502560000	+22,17	-23,85
625040000	+26,83	-19,19
750000000	+34,78	-11,24
939520000	+27,85	-18,17

23069013_2

Segalla 23069014

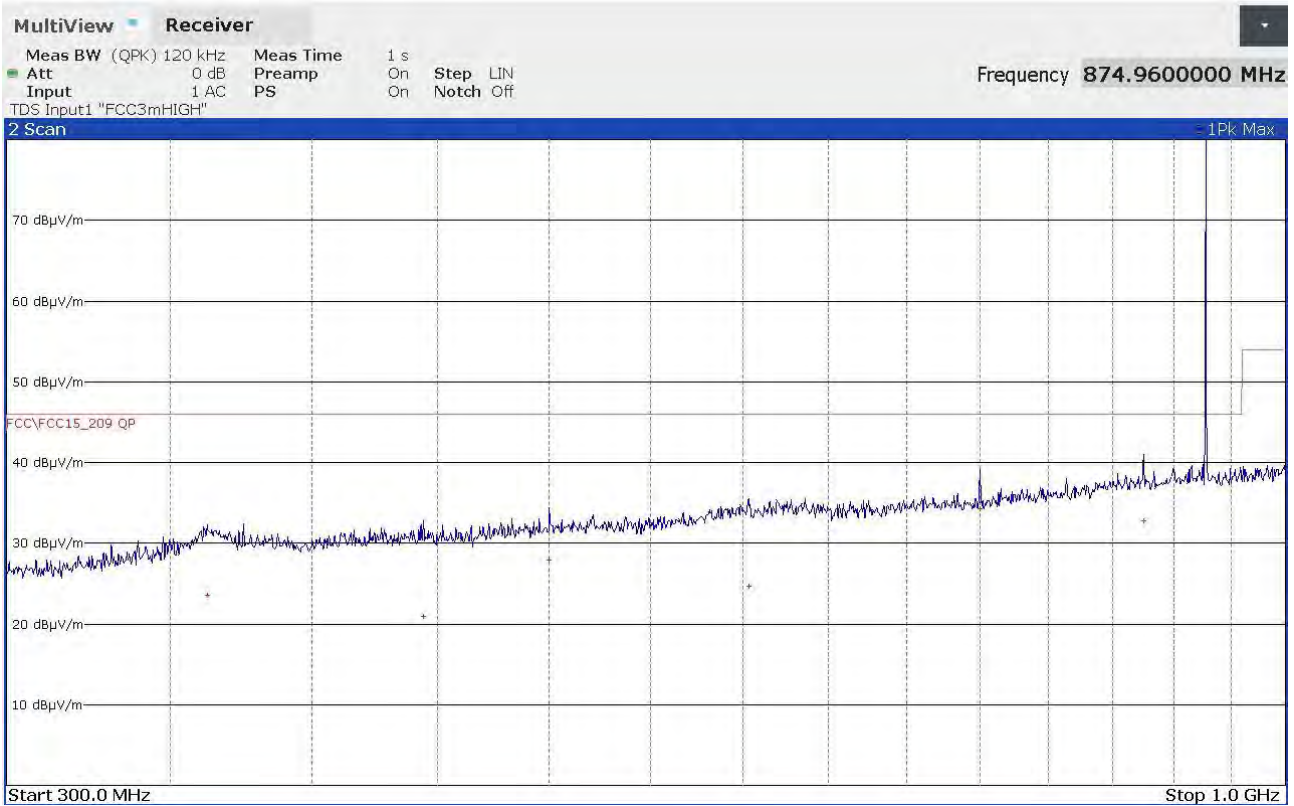

FINAL RESULT TABLE

QUASI PEAK		
Freq Hz	Lev dBuV/m	Margin dB
362440000	+23,54	-22,48
444280000	+20,95	-25,07
500000000	+27,96	-18,06
603240000	+24,65	-21,37
750000000	+34,25	-11,77
874960000	+32,79	-13,23

23069014_2

Segalla 23069015

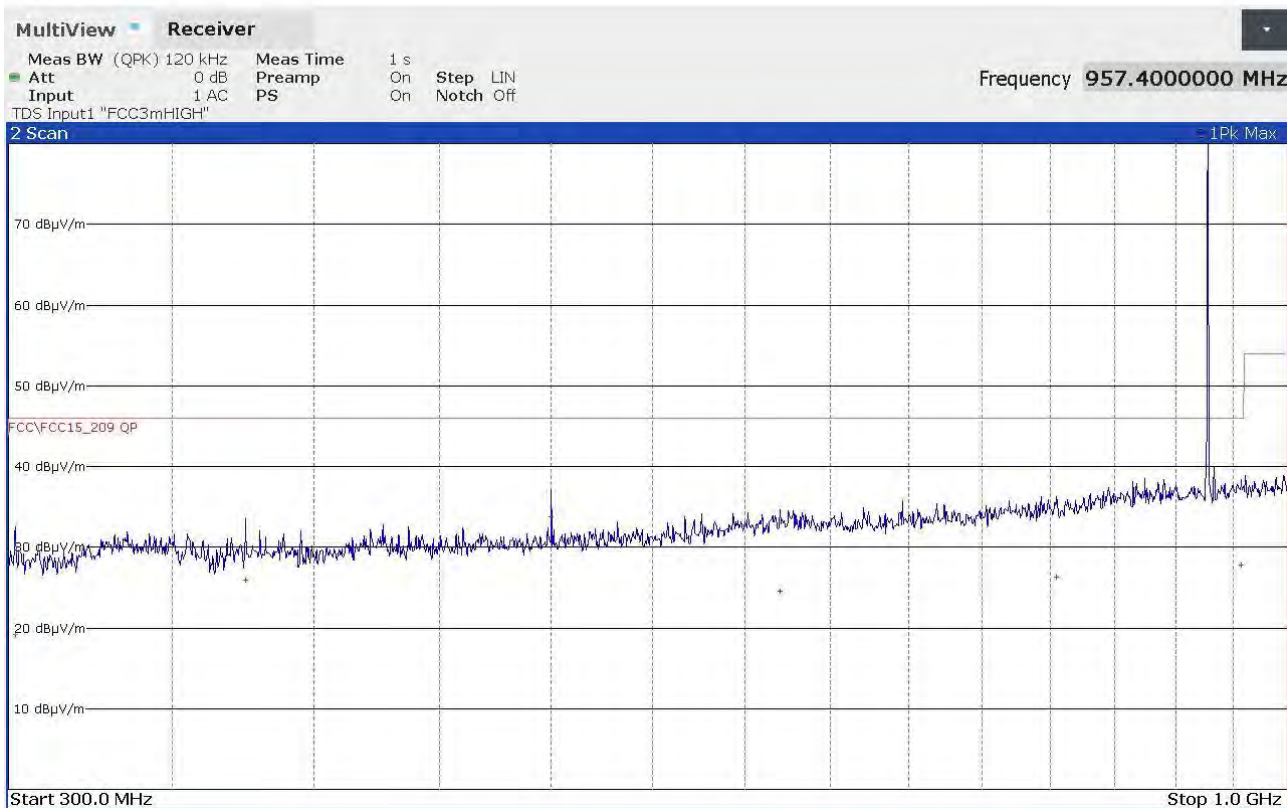

FINAL RESULT TABLE

QUASI PEAK		
Freq Hz	Lev dBuV/m	Margin dB
301880000	+19,21	-26,81
375000000	+25,98	-20,04
500000000	+33,74	-12,28
620360000	+24,60	-21,42
804720000	+26,24	-19,78
957400000	+27,82	-18,20

23069015_2

9.4 20 dB bandwidth

Tested by	M. Segalla
Test date	13.06.2023
Test location (stand)	Laboratory
Reference standards.....	FCC Rules and Regulation; Titles 47 Part. 15.215 (c) ANSI C63.10 cl. 7.8.7
Supplementary test set-up description.....	--
Supplementary information	--

Test setup

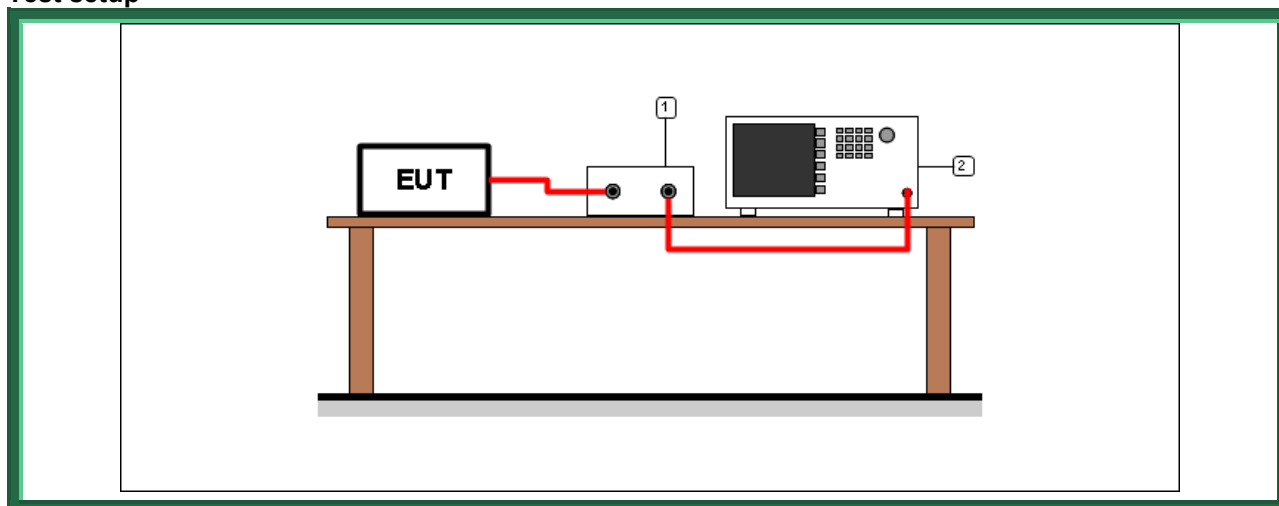

Test setup PR002_01

Nr.	Id. Number	Manufacturer	Model	Description
2	CMC S295	Rohde & Schwarz	FSW43	Spectrum Analyzer 43GHz
1	--	--	--	Cable + attenuator (calibrated before the test)

Result

Transmission channel (MHz)	Graphs	20 dB bandwidth (kHz)
915,05	G23069016	20,78
921,40	G23069020	20,73
927,80	G23069023	28,83

Graphs

Segalla 23069016



Segalla 23069020



Segalla 23069023



9.5 Channel separation

Tested by	M. Segalla
Test date	13.06.2023
Test location (stand)	Laboratory
Reference standards.....	FCC Rules and Regulation; Titles 47 Part. 15.247 KDB 558074 D01 15.247 Meas Guidance v05r02 cl. 9 b) ANSI C63.10 cl. 7.8.2
Supplementary test set-up description.....	--
Supplementary information	--

Acceptance limits

Frequency hopping systems shall have hopping channel carrier frequencies separated by a minimum of 25 kHz or the 20 dB bandwidth of the hopping channel, whichever is greater. Alternatively, frequency hopping systems operating in the 2400–2483.5 MHz band may have hopping channel carrier frequencies that are separated by 25 kHz or two-thirds of the 20 dB bandwidth of the hopping channel, whichever is greater, provided the systems operate with an output power no greater than 125 mW. The system shall hop to channel frequencies that are selected at the system hopping rate from a pseudo randomly ordered list of hopping frequencies. Each frequency must be used equally on the average by each transmitter. The system receivers shall have input bandwidths that match the hopping channel bandwidths of their corresponding transmitters and shall shift frequencies in synchronization with the transmitted signals.

Test setup

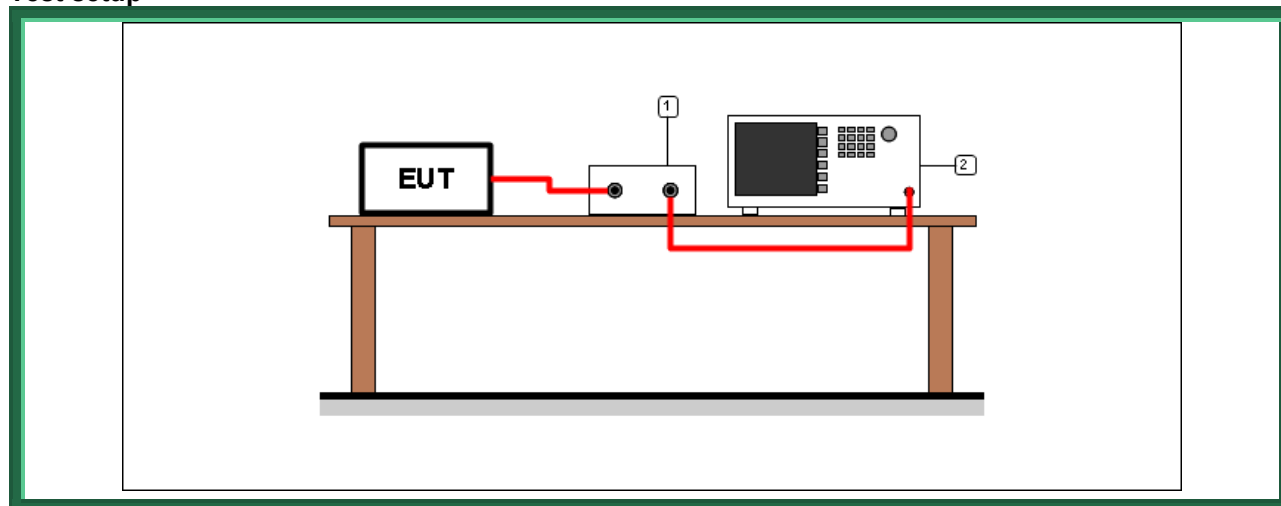

Test setup PR002_01

Nr.	Id. Number	Manufacturer	Model	Description
2	CMC S295	Rohde & Schwarz	FSW43	Spectrum Analyzer 43GHz
1	--	--	--	Cable + attenuator (calibrated before the test)

Result

Frequency band (MHz)	Graphs	Channel separation (kHz)	Minimum channel separation required (kHz)	Results
902 – 928	G23069028	100,5	25	Complies

Graphs

Segalla 23069028

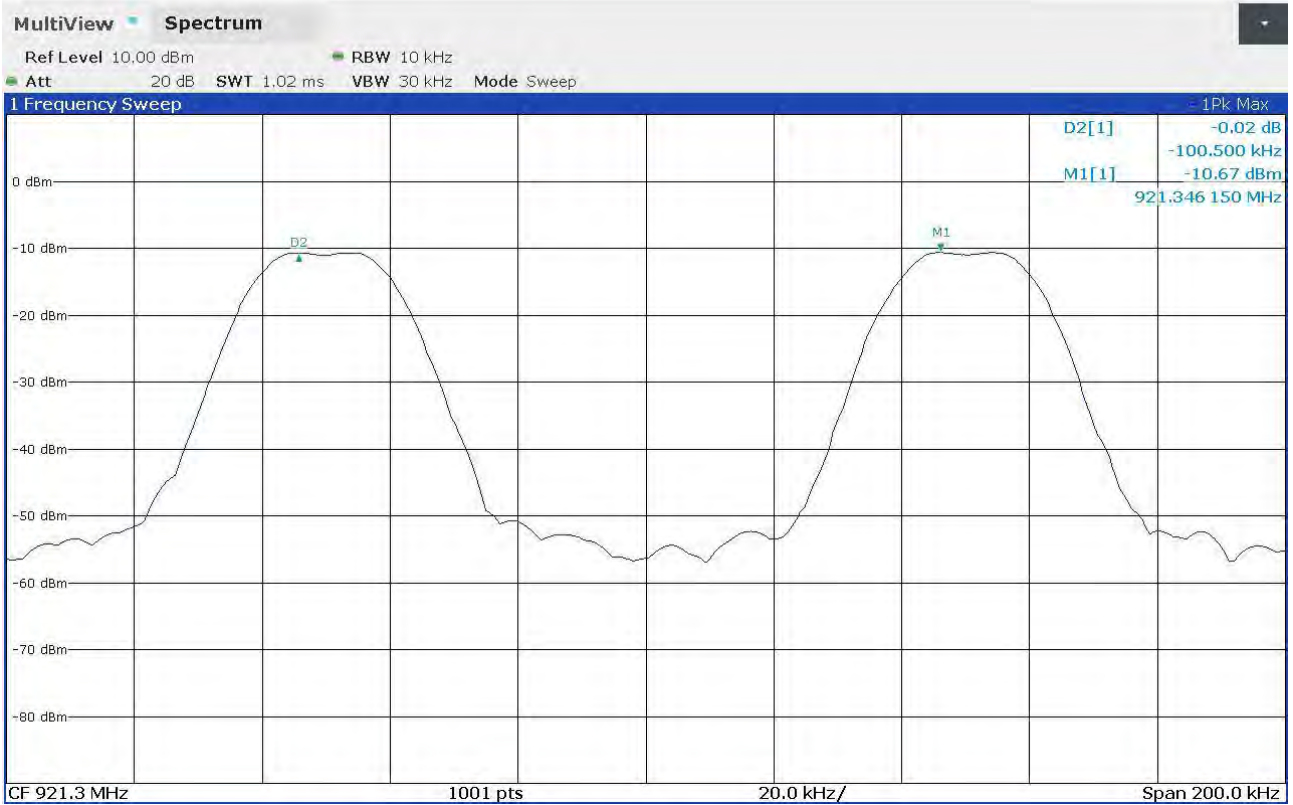

9.6 Number of hopping channels

Tested by	M. Segalla
Test date	13.06.2023
Test location (stand)	Laboratory
Reference standards.....	FCC Rules and Regulation; Titles 47 Part. 15.247 KDB 558074 D01 15.247 Meas Guidance v05r02 cl. 9 b) ANSI C63.10 cl. 7.8.3
Supplementary test set-up description.....	--
Supplementary information	--

Acceptance limits

For frequency hopping systems operating in the 902 – 928 MHz band: if the 20 dB bandwidth of the hopping channel is less than 250 kHz, the system shall use at least 50 hopping frequencies and the average time of occupancy on any frequency shall not be greater than 0,4 seconds within a 20 second period; if the 20 dB bandwidth of the hopping channel is 250 kHz or greater, the system shall use at least 25 hopping frequencies and the average time of occupancy on any frequency shall not be greater than 0,4 seconds within a 10 second period. The maximum allowed 20 dB bandwidth of the hopping channel is 500 kHz.

Test setup

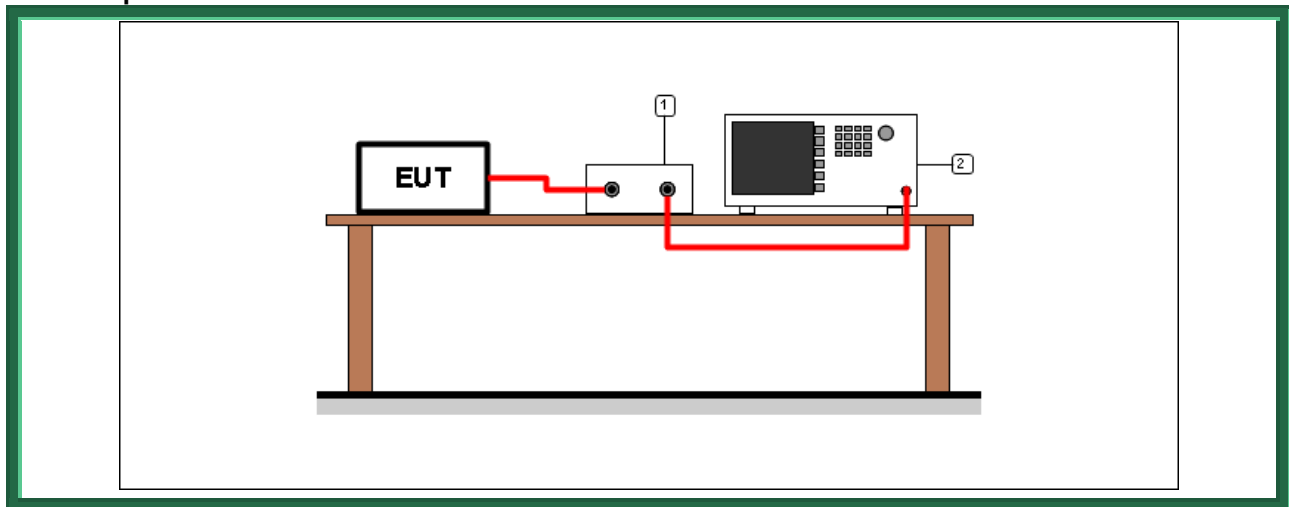

Test setup PR002_01				
Nr.	Id. Number	Manufacturer	Model	Description
2	CMC S295	Rohde & Schwarz	FSW43	Spectrum Analyzer 43GHz
1	--	--	--	Cable + attenuator (calibrated before the test)

Result

<i>Frequency band (MHz)</i>	<i>Graphs</i>	<i>Number of hopping channels</i>	<i>Minimum number of hopping channels required</i>	<i>Results</i>
902 – 928	G23069029 G23069030 G23069031	128	50	Complies

For laboratory tests a special programming is provided; anyway we deem it representative of any real world hopping sequence that can be programmed into the devices.

First, special programming allows fixed frequency measurements at min, med and max operating frequency; this is not available for series production units, but is required for testing.

Then two evenly spaced hopping sequences of 64 channels are provided, one including the min freq channel at 915,050 MHz, the other including the max freq channel at 927.800 MHz. Although they are not available for series production units, both these hopping sequences are suitable for valid measurements of FH timing parameters. In fact, FH Timing parameters measurements is not dependent on channel positioning

Graphs

Segalla 23069029

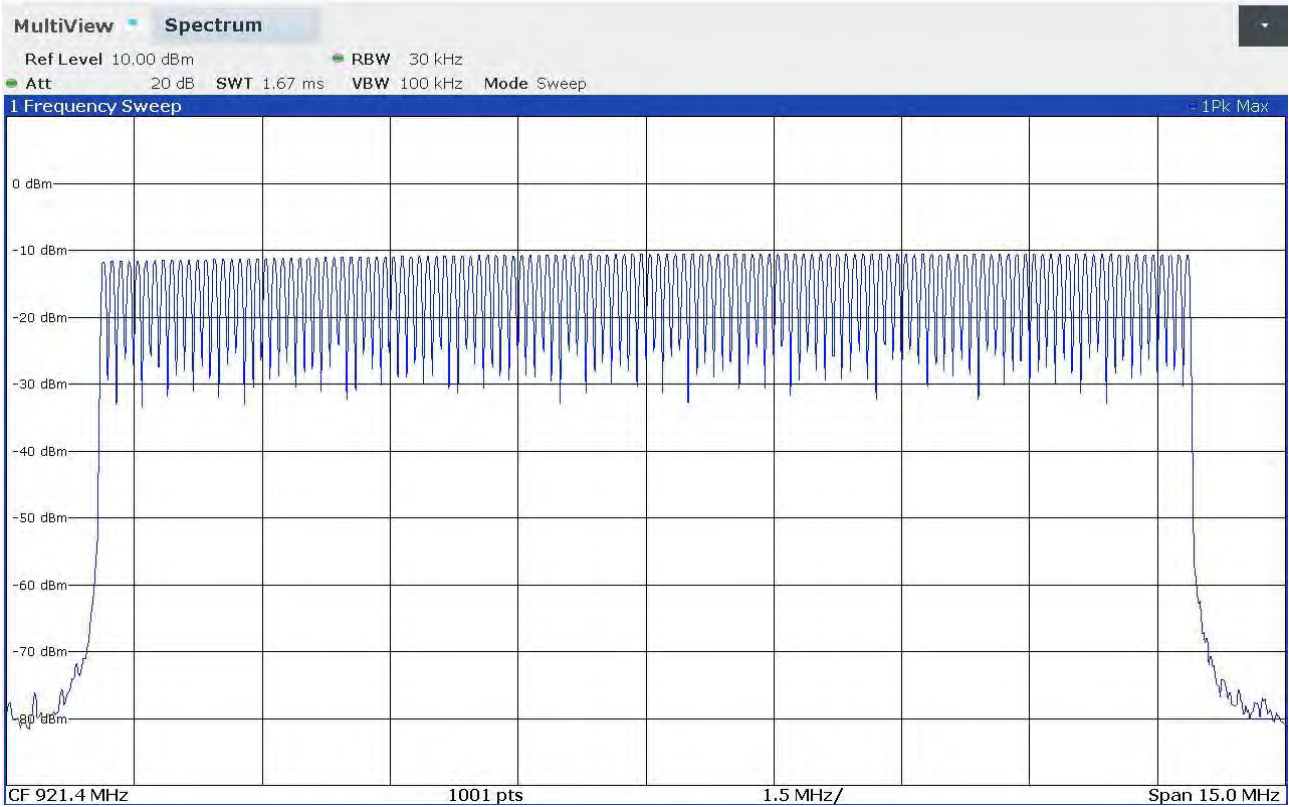

Segalla 23069030

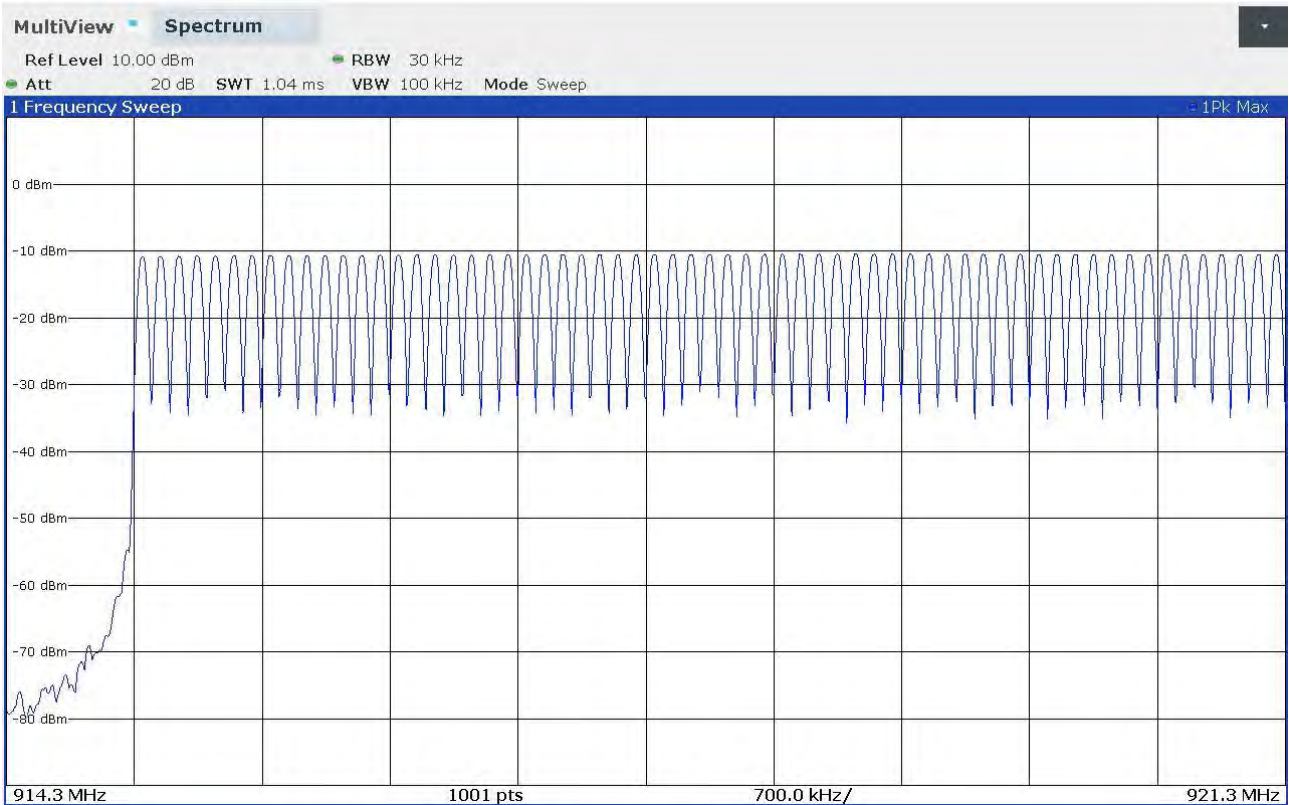

Segalla 23069031

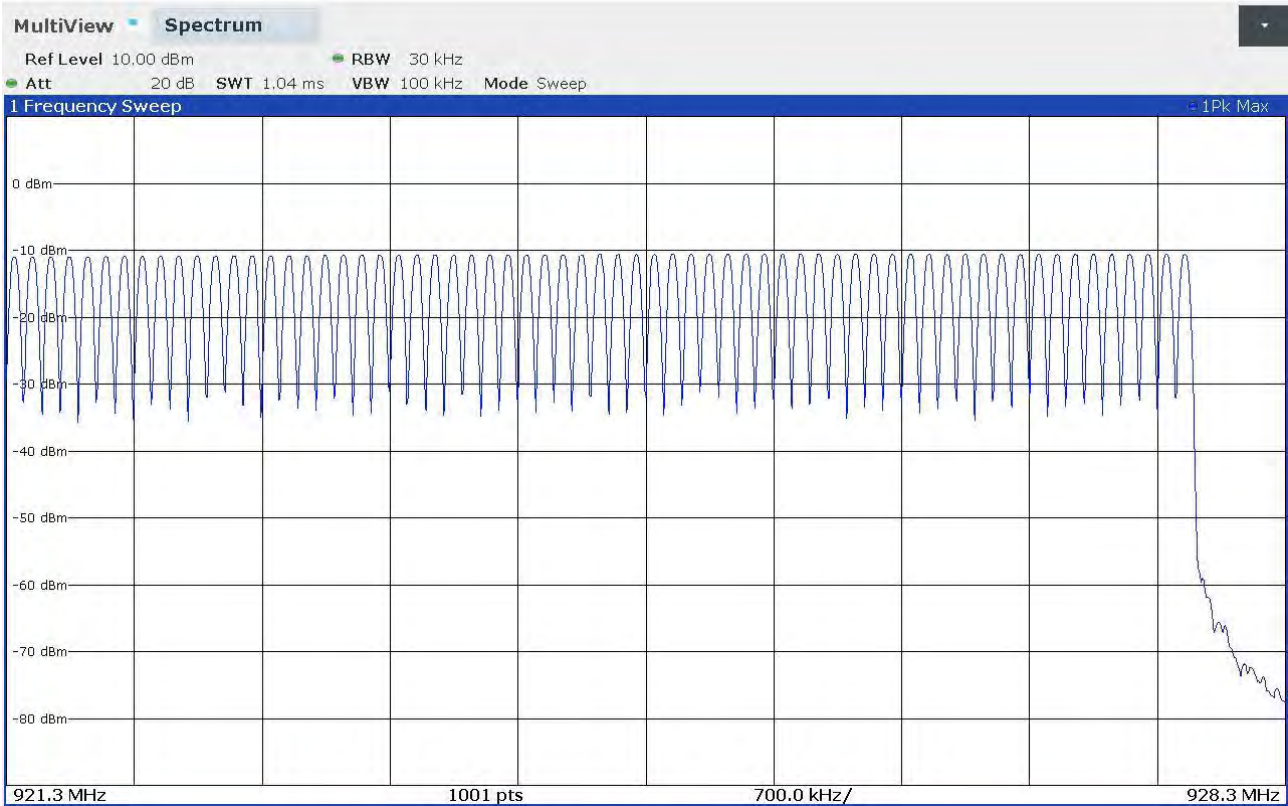

9.7 Time of occupancy

Tested by	M. Segalla
Test date	13.06.2023
Test location (stand)	Laboratory
Reference standards.....	FCC Rules and Regulation; Titles 47 Part. 15.247 KDB 558074 D01 15.247 Meas Guidance v05r02 cl. 9 b) ANSI C63.10 cl. 7.8.4
Supplementary test set-up description.....	--
Supplementary information	--

Acceptance limits

For frequency hopping systems operating in the 902 – 928 MHz band: if the 20 dB bandwidth of the hopping channel is less than 250 kHz, the system shall use at least 50 hopping frequencies and the average time of occupancy on any frequency shall not be greater than 0,4 seconds within a 20 second period; if the 20 dB bandwidth of the hopping channel is 250 kHz or greater, the system shall use at least 25 hopping frequencies and the average time of occupancy on any frequency shall not be greater than 0,4 seconds within a 10 second period. The maximum allowed 20 dB bandwidth of the hopping channel is 500 kHz.

Test setup

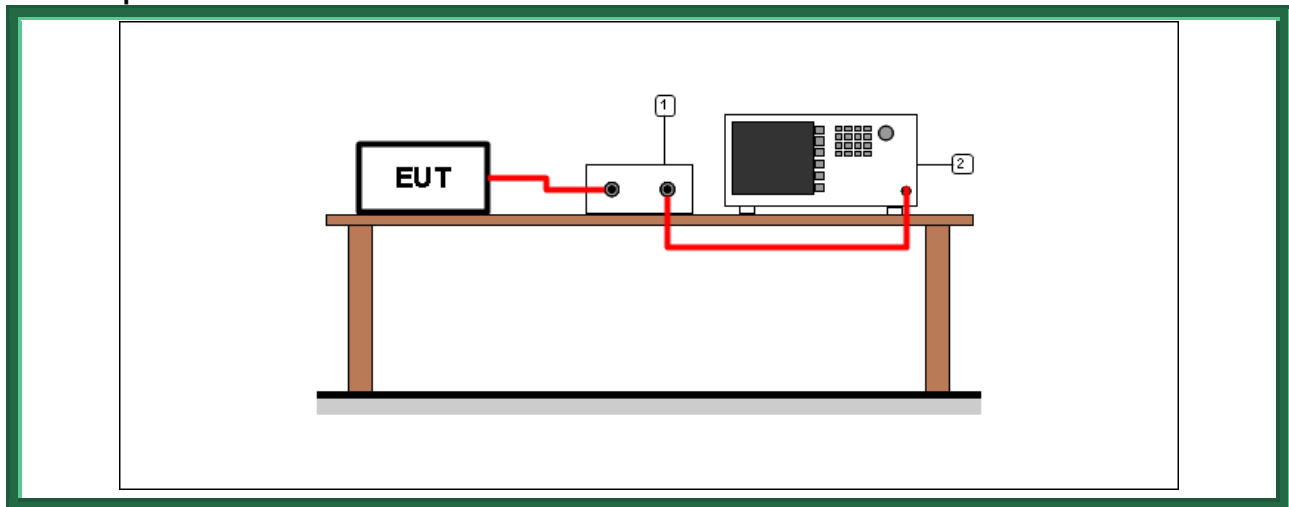

Test setup PR002_01				
Nr.	Id. Number	Manufacturer	Model	Description
2	CMC S295	Rohde & Schwarz	FSW43	Spectrum Analyzer 43GHz
1	--	--	--	Cable + attenuator (calibrated before the test)

Result

<i>Transmission channel (MHz)</i>	<i>Graphs</i>	<i>Dwell time (ms)</i>
921,2545	G23069032	24,10

<i>Transmission channel (MHz)</i>	<i>Graphs</i>	<i>Number of transmissions</i>	<i>Period</i>
921,2545	G23069033	4	20 s

Remarks: only the highest peaks have been considered. The lowest peaks are due to the auxiliary receiver unit

<i>Time of occupancy (Dwell time x Nr. transmissions)</i>	<i>Maximum allowed time of occupancy</i>	<i>Results</i>
96,40	400 ms	Complies

Graphs

Segalla 23069032

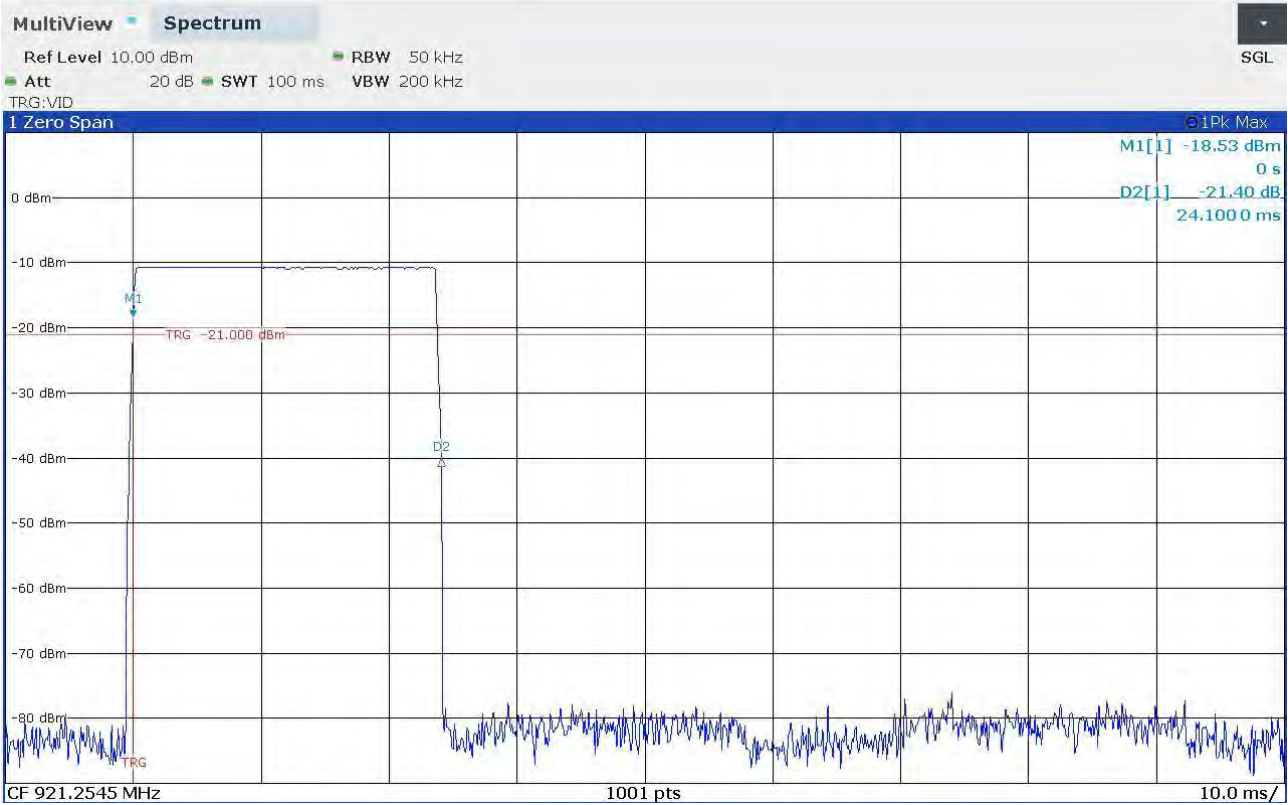

Segalla 23069033

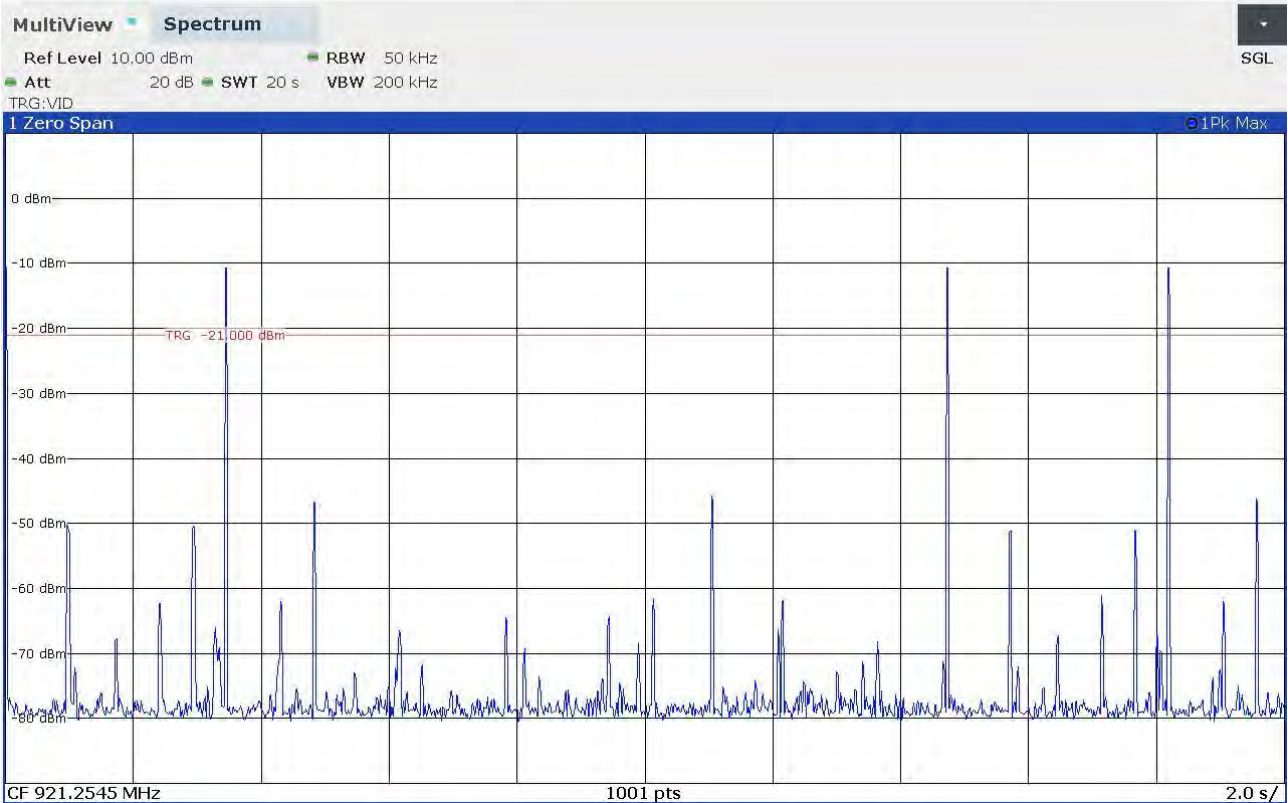

9.8 Band edge

Tested by	M. Segalla
Test date	13.06.2023
Test location (stand)	Laboratory
Reference standards.....	FCC Rules and Regulation; Titles 47 Part. 15.247 ANSI C63.10 cl. 7.8.6
Supplementary test set-up description.....	--
Supplementary information	--

Acceptance limits

In any 100 kHz bandwidth outside the frequency band in which the spread spectrum or digitally modulated intentional radiator is operating, the radio frequency power that is produced by the intentional radiator shall be at least 20 dB below that in the 100 kHz bandwidth within the band that contains the highest level of the desired power, based on either an RF conducted or a radiated measurement, provided the transmitter demonstrates compliance with the peak conducted power limits. If the transmitter complies with the conducted power limits based on the use of RMS averaging over a time interval, as permitted under paragraph (b)(3) of this section, the attenuation required under this paragraph shall be 30 dB instead of 20 dB. Attenuation below the general limits specified in § 15.209(a) is not required. In addition, radiated emissions which fall in the restricted bands, as defined in §15.205(a), must also comply with the radiated emission limits specified in § 15.209(a) (see § 15.205(c)).

Operation within the band 902 – 928 MHz.

Test setup

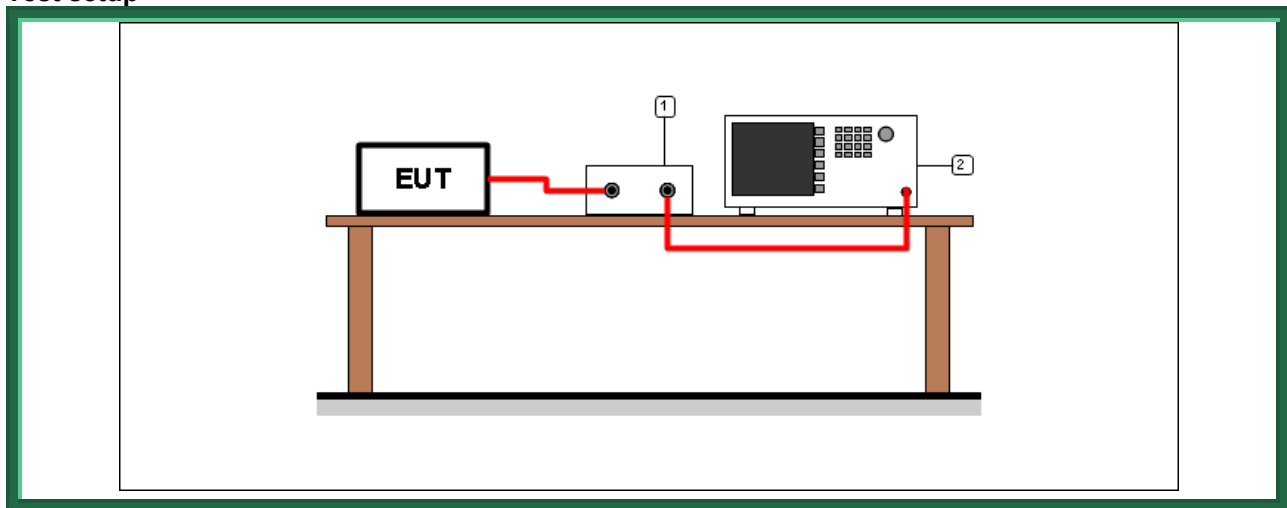

Test setup PR002_01				
Nr.	Id. Number	Manufacturer	Model	Description
2	CMC S295	Rohde & Schwarz	FSW43	Spectrum Analyzer 43GHz
1	--	--	--	Cable + attenuator (calibrated before the test)

Result

<i>Transmission channel (MHz)</i>	<i>Bandwidth</i>	<i>Graph(s) – Hopping</i>	<i>Results</i>	
915,050	100 kHz	G23069027	FL: 914,977 MHz	Complies
927,800	100 kHz	G23069034	FH: 927,846 MHz	Complies

<i>Transmission channel (MHz)</i>	<i>Bandwidth</i>	<i>Graph(s) – No hopping</i>	<i>Results</i>	
915,050	100 kHz	G23069019	FL: 914,887 MHz	Complies
927,800	100 kHz	G23069026	FH: 927,937 MHz	Complies

Graphs

Segalla 23069019

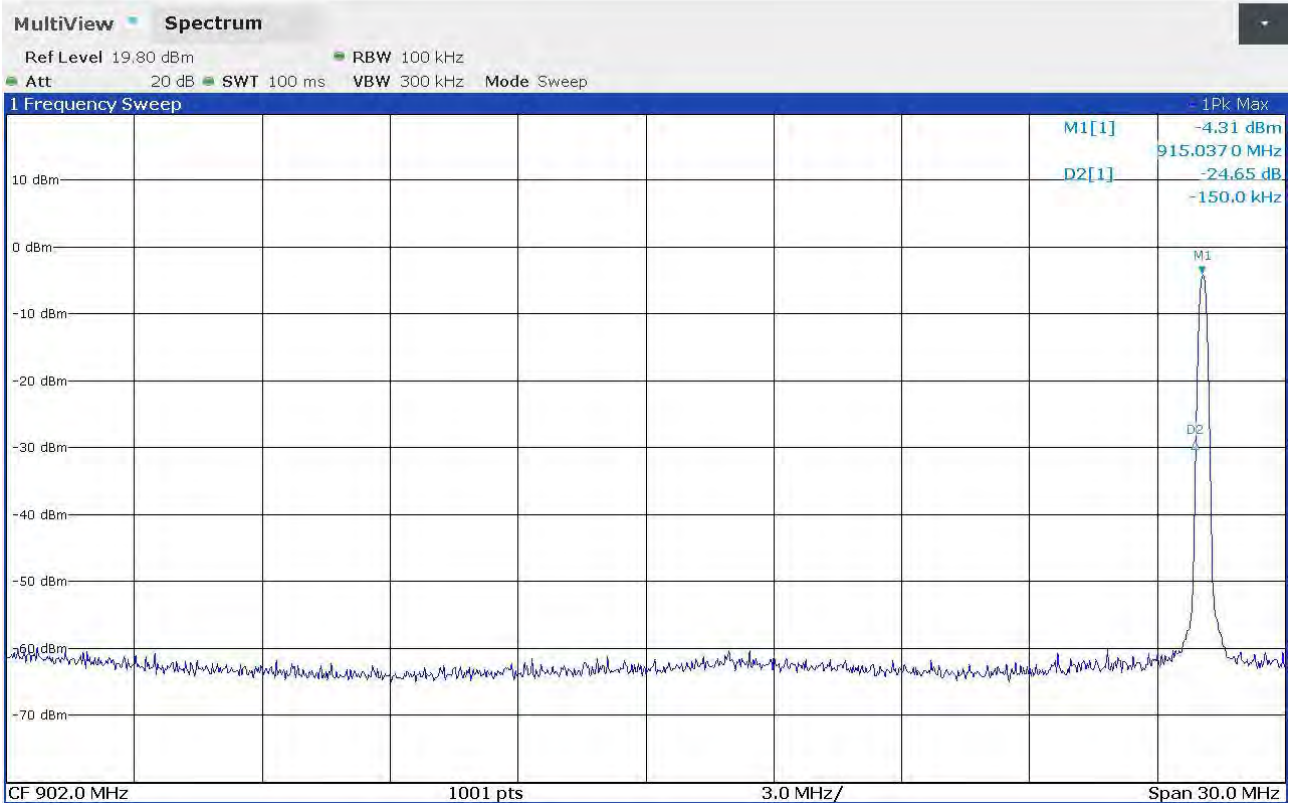

Segalla 23069026

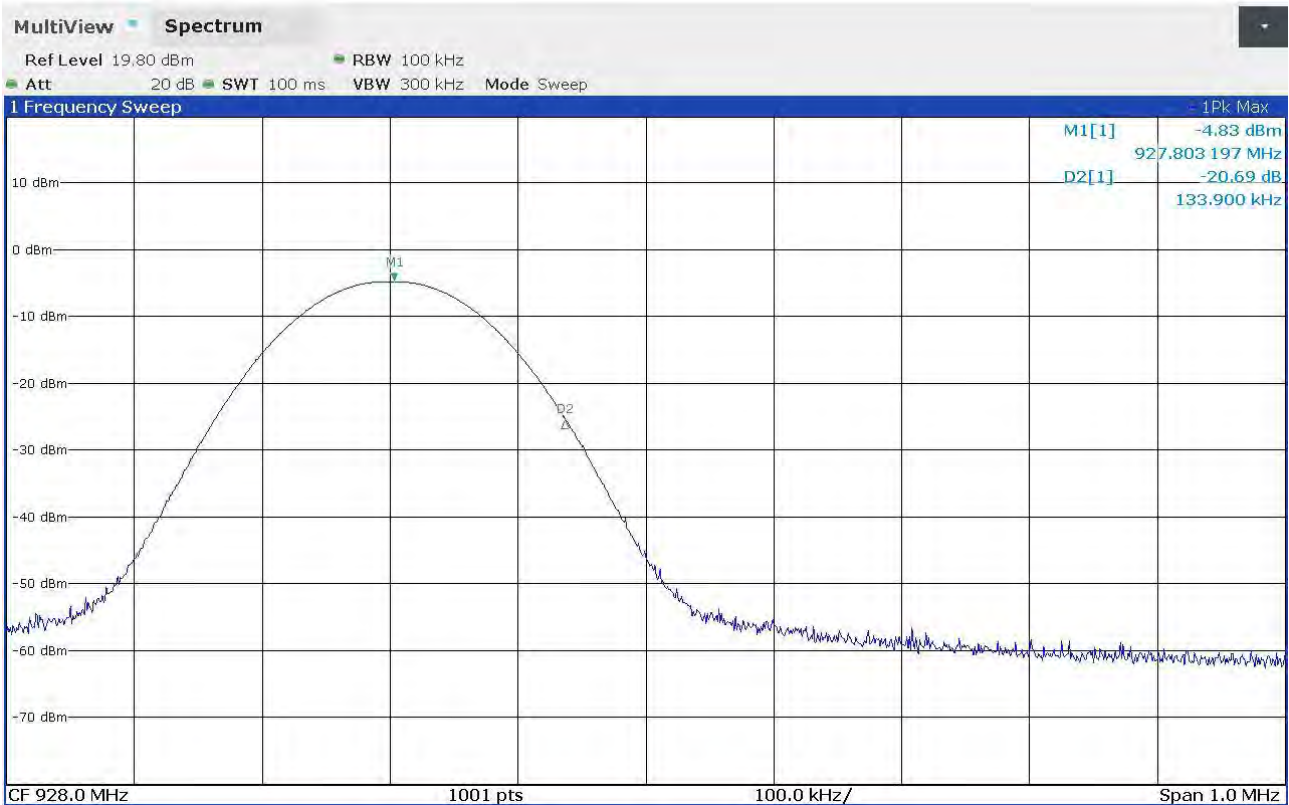

Segalla 23069027

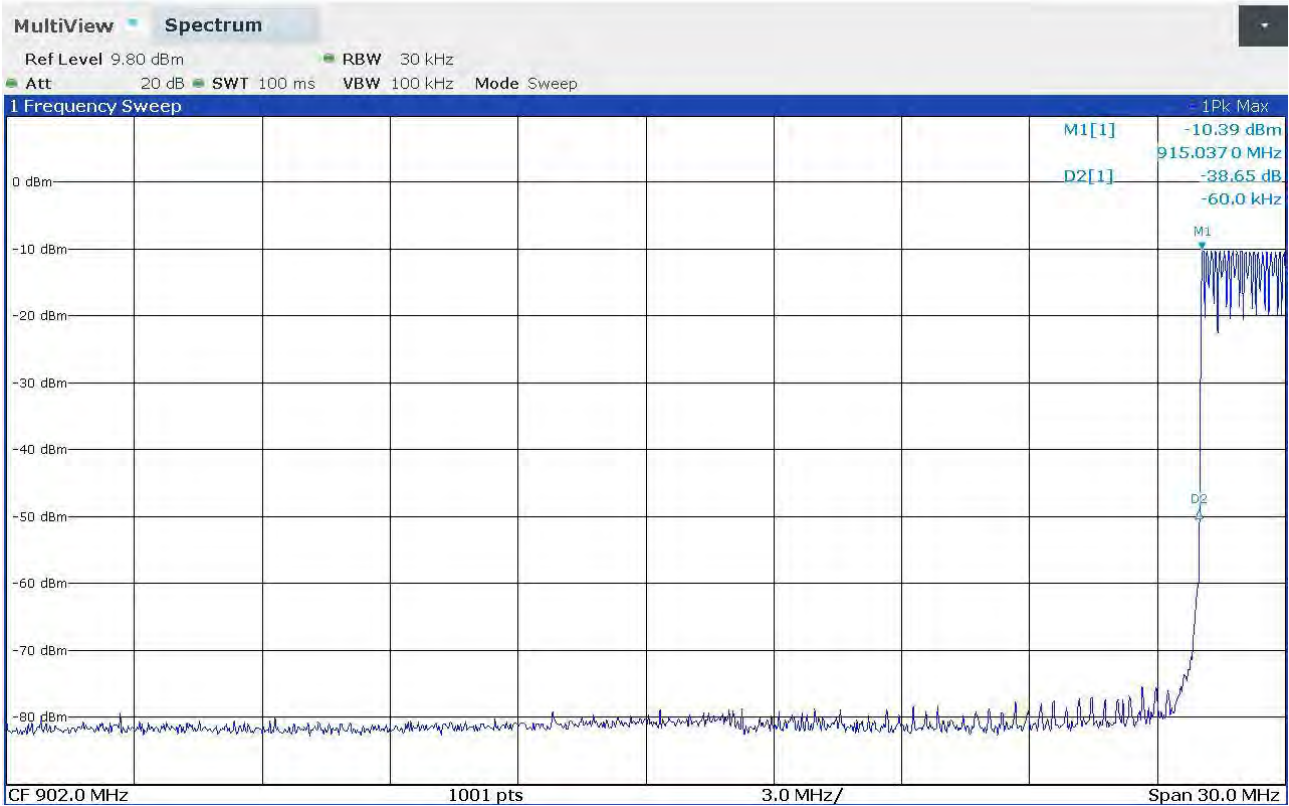

Segalla 23069034

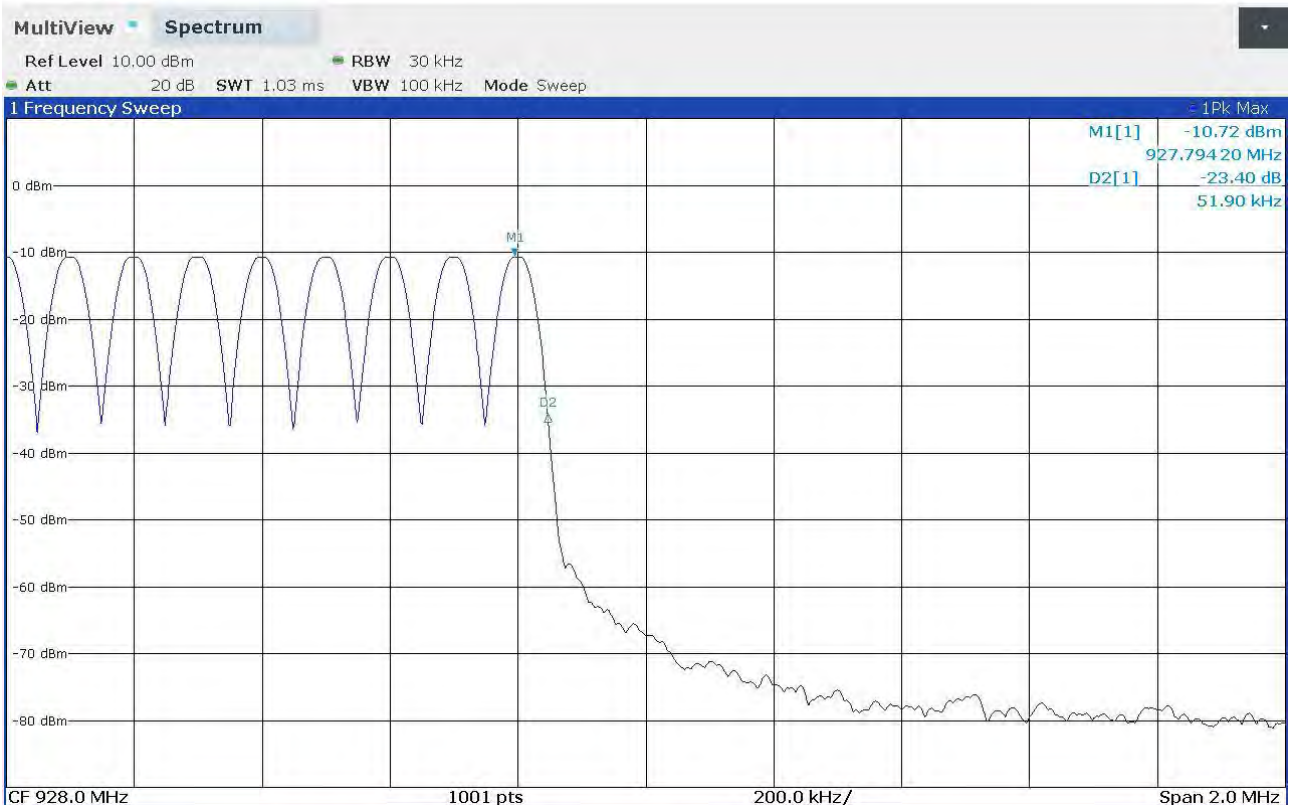

9.9 Peak Output Power

Tested by	M. Segalla
Test date	13.06.2023
Test location (stand)	Laboratory
Reference standards.....	FCC Rules and Regulation; Titles 47 Part. 15.247 KDB 558074 D01 15.247 Meas Guidance v05r02 cl. 2.2 ANSI C63.10 cl. 7.8.5
Supplementary test set-up description.....	--
Supplementary information	--

Acceptance limits

For frequency hopping systems operating in the 2400–2483,5 MHz band employing at least 75 non-overlapping hopping channels, and all frequency hopping systems in the 5725–5850 MHz band: 1 watt. For all other frequency hopping systems in the 2400–2483,5 MHz band: 0,125 watts.

For frequency hopping systems operating in the 902–928 MHz band: 1 watt for systems employing at least 50 hopping channels; and, 0,25 watts for systems employing less than 50 hopping channels, but at least 25 hopping channels.

Test setup

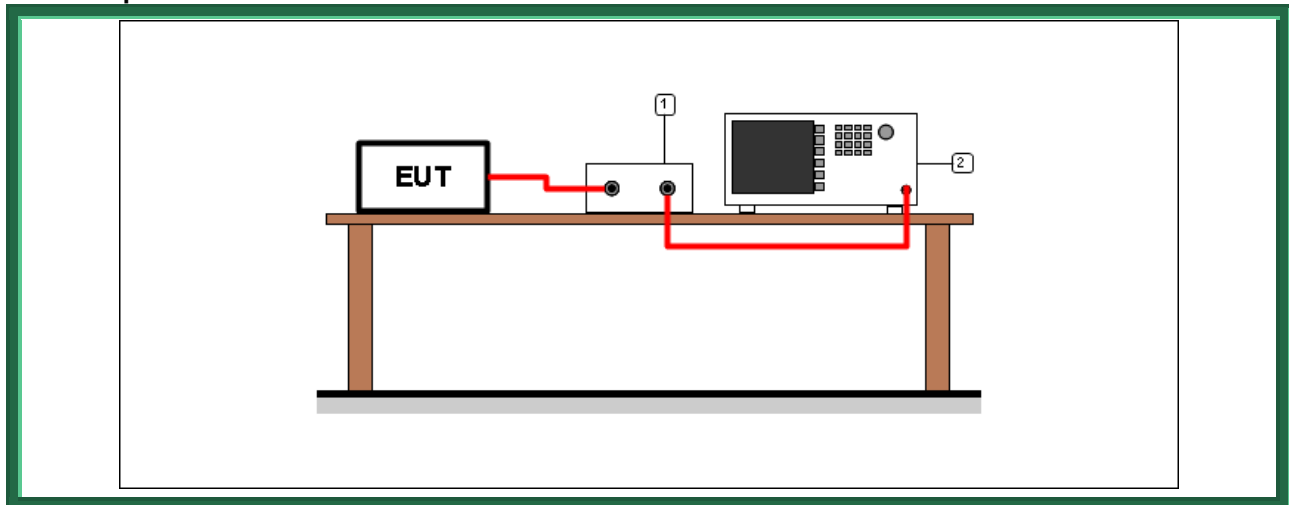

Test setup PR002_01

Nr.	Id. Number	Manufacturer	Model	Description
2	CMC S295	Rohde & Schwarz	FSW43	Spectrum Analyzer 43GHz
1	--	--	--	Cable + attenuator (calibrated before the test)

Result

Transmission channel (MHz)	Graphs	Peak Output Power (dBm)	Peak Output Power (mW)	Limit (mW)
915,05	G23069018	15,95	39,36	1000
921,40	G23069022	15,58	36,14	1000
927,80	G23069025	15,38	34,51	1000

Graphs

Segalla 23069018

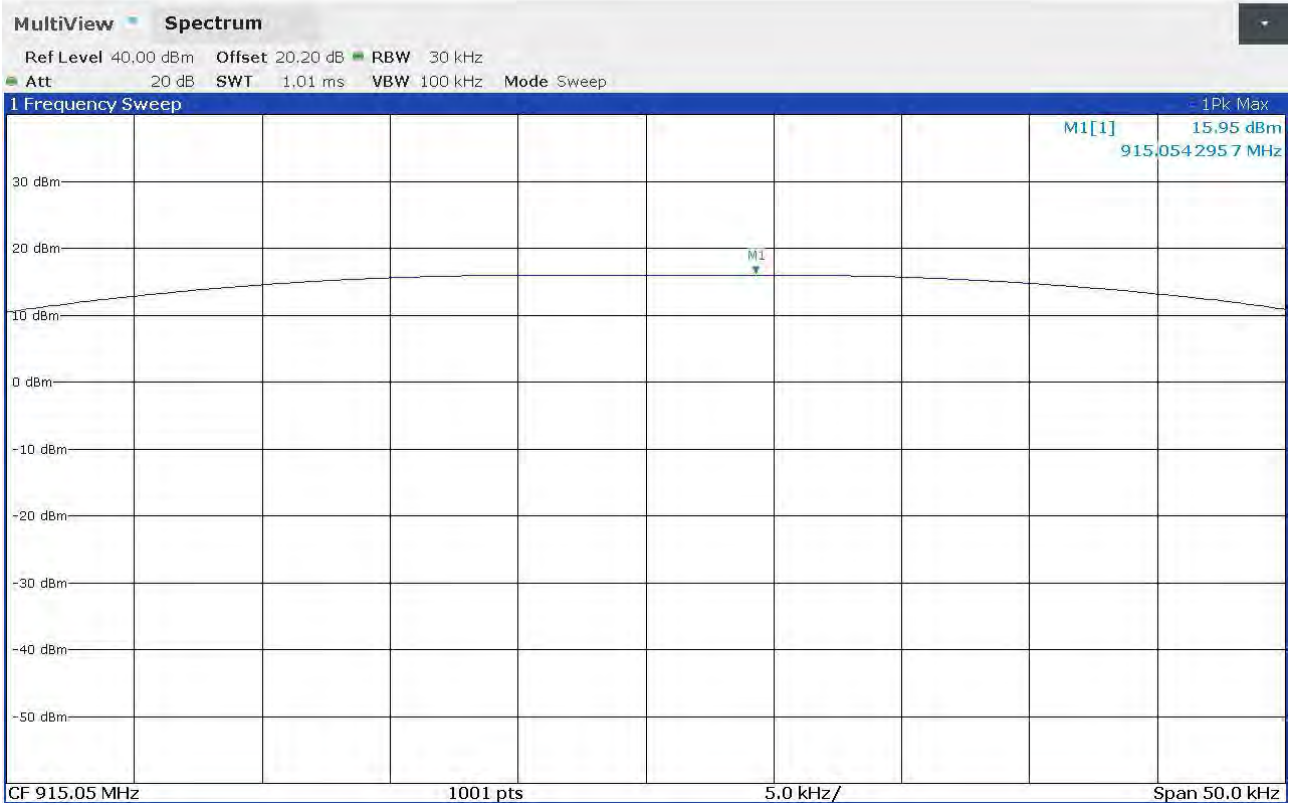

Segalla 23069022

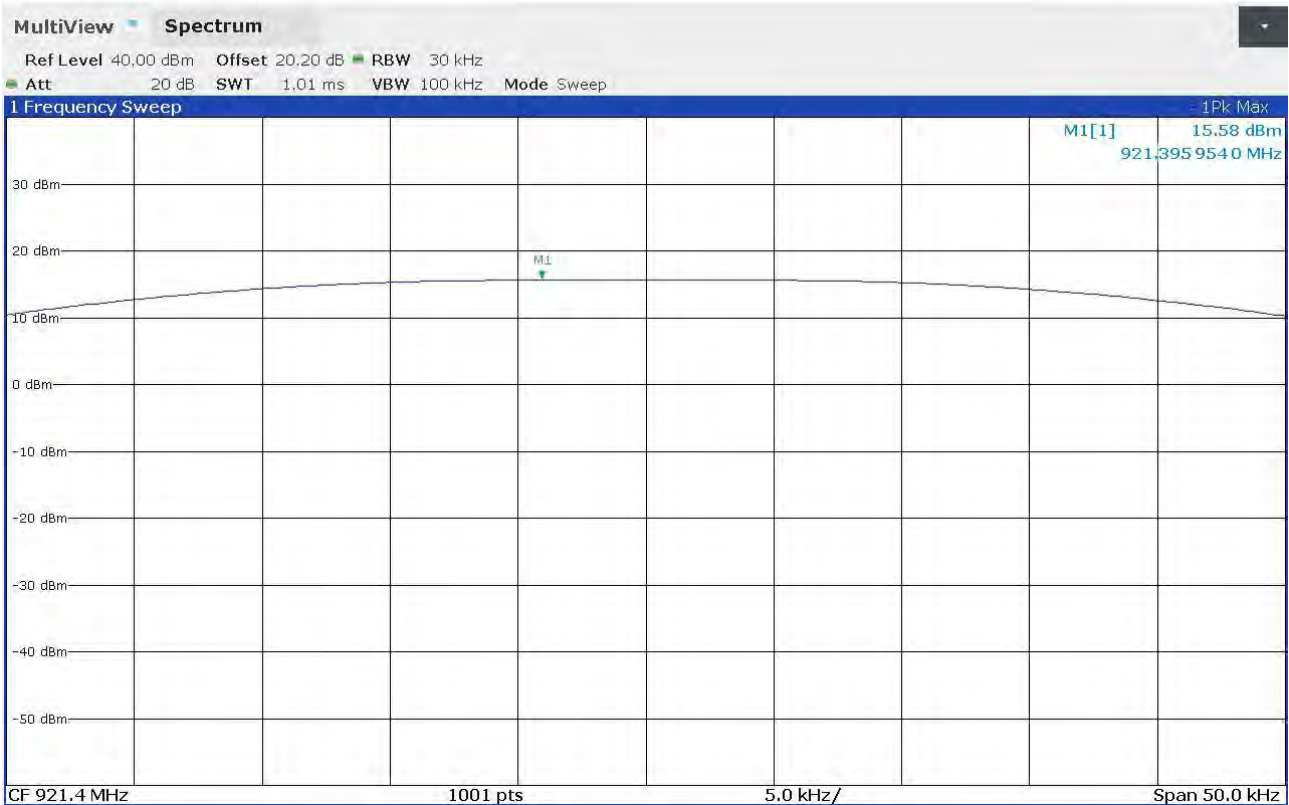

Segalla 23069025

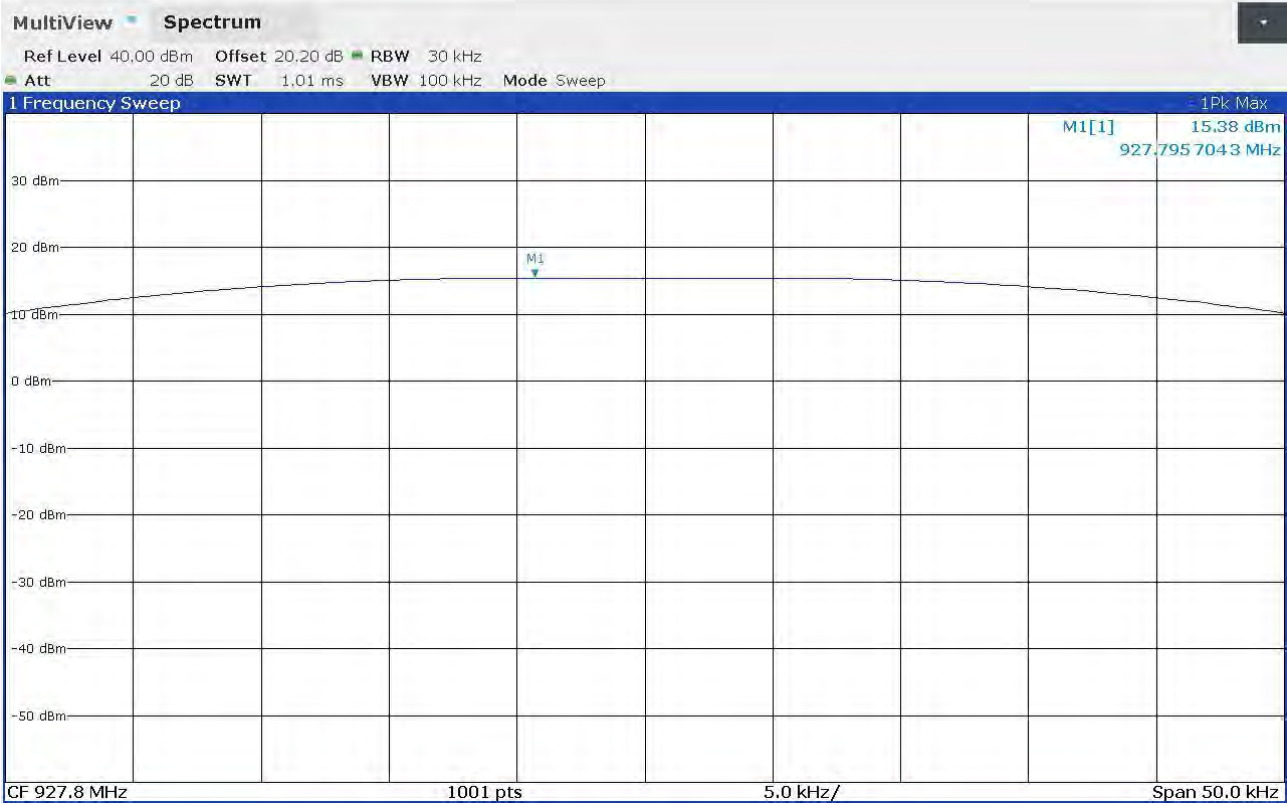

Attachment 1
Measurement uncertainty

<i>Test</i>	<i>Test Setup</i>	<i>Expanded uncertainty</i>		<i>Note</i>
Conducted emission CISPR 16 LISN 50uH 0,009-0,0150 MHz	PE001_01	3,4 dB		1
Conducted emission CISPR 16 LISN 50uH 0,150-30,0 MHz	PE001_01	2,9 dB		1
Conducted emission CISPR 16 Voltage Probe 0,15-30 MHz	PE001_02	2,1 dB		1
Conducted emission CISPR 16 Current Probe 0,15-30 MHz	PE001_03	2,5 dB		1
Conducted emission CISPR 16 ISN 0,15-30 MHz	PE001_04	4,7 dB		1
Clic CISPR 16 LISN 50uH 0,150-30,0 MHz	PE001_05	2,9 dB		1
Radiated Emission CDNE 30-300 MHz	PE001_06	3,3 dB		1
Disturbance Power 30-300 MHz	PE002_01	3,7 dB		1
Radiated Emission LAS 0,15-30 MHz	PE003_01	1,9 dB		1
Radiated Emission CISPR 16 Loop Ant. 0,15-30 MHz	PE004_01	4,1 dB		1
Radiated Emission CISPR 16 Bicon. Ant. 30-300 MHz	PE004_02	4,6 dB		1
Radiated Emission CISPR 16 LogP. Ant. 300-1000 MHz	PE004_03	4,5 dB		1
Radiated Emission CISPR 16 Horn Ant. 1-18 GHz	PE004_04	4,7 dB		1
Human Exposure to electromagnetic fields	PE005_01	14,2 %		1
Harmonics	PE006_01	10 mA +	2,9 %	1
Flicker	PE007_01	4,20 %		1
Radiated Immunity 80 MHz - 6 GHz	PE102_XX	2,25 dB	0,89 V/m a 3V/m	1
Conducted Immunity 0,15 - 230 MHz	PE105_XX	1,19 dB	0,44 V a 3V	1
AC Magnetic field	PE106_01	1,55 %	0,15 A/m a 10A/m	1
Pulse Magnetic field	PE107_01	6,25 %	18,8 A/m a 300A/m	1
Dumped Magnetic field	PE108_01	6,25 %	1,88 A/m a 30A/m	1
Common mode conducted immunity	PE112_01	2,22 %	0,22 V a 10V	1

Attachment 1

Test	Test Setup	Expanded uncertainty	Note
Power/Spurious 9kHz-30MHz	PR001_01	4,1 dB	1
Power/Spurious ERP 30-1000MHz d=10m	PR001_02+03	4,7 dB	1
Misura della potenza EIRP 1-18GHz d=3m	PR001_04+05	4,7 dB	1
Misura della potenza EIRP 18-40GHz d=3m	PR001_06	5,1 dB	1
Frequency error	PR002_01+02	$< 1 \times 10^{-7}$	1
Timing zero span (1001pts.)	PR002_01+02	0,2 % SWT	1
Modulation bandwidth	PR002_01+02	$< 1 \times 10^{-7}$	1
Conducted RF power and spurious emission	PR002_01+02	1,1 dB	1
Adjacent channel power	PR002_01+02	1,1 dB	1
Blocking	PR002_01+02	1,1 dB	1

Test	Test Setup	Expanded uncertainty	Note
Electrostatic discharge immunity test	PE101_0X		2
Electrical fast transients / burst immunity test	PE103_0X		2
Surge immunity test	PE104_0X		2
Short interruption immunity test	PE109_01		2
Ring Wave immunity test	PE110_01		2
Low frequency immunity test	PE111_01		2
Dumped Oscillatory immunity test	PE113_01		2
Rev_23_01 date 20/03/2023			

Note 1:



The expanded uncertainty reported according to the document EA-4-02 is based on a standard uncertainty multiplied by a coverage factor of $k=2$, providing a level of confidence of $p = 95\%$

Note 2:

It has been demonstrated that the used test equipment meets the specified requirements in the standard with at least a 95% confidence, covering factor $k=2$

Attachment 1

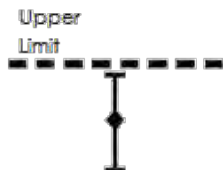
Judgement of compliance

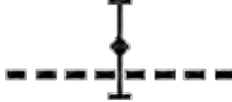
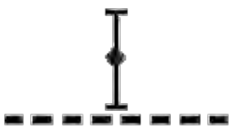
Case 1	Case 2	Case 3	Case 4
 <p>The sample complies with the requirements.</p> <p>The measurement results is within the specification limit when the measurement uncertainty is taken into account.</p>	 <p>The sample complies with the requirements.</p> <p>It is not possible to state compliance using a 95% coverage probability for the expanded uncertainty although the measurement result is below the limit.</p>	 <p>The sample does not comply with the requirements.</p> <p>It is not possible to state compliance using a 95% coverage probability for the expanded uncertainty also the measurement result is upper the limit.</p>	 <p>The sample does not comply with the requirements.</p> <p>The measurement results is outside the specification limit when the measurement uncertainty is taken into account.</p>

In agreement with ILAC-G8:09/2019 cl.4.2.1 Guidelines on Decision Rules and Statements of Conformity

Quality manual references – Internal procedure

Internal Procedure PM001 rev. 4.0 (Quality Manual)	Measure procedure
Internal Procedure INC_M rev. 10.0 (Quality Manual)	Measurement uncertainty calculation