

Instruction Manual for the use and the maintenance of the Radio Remote Control

Original instructions

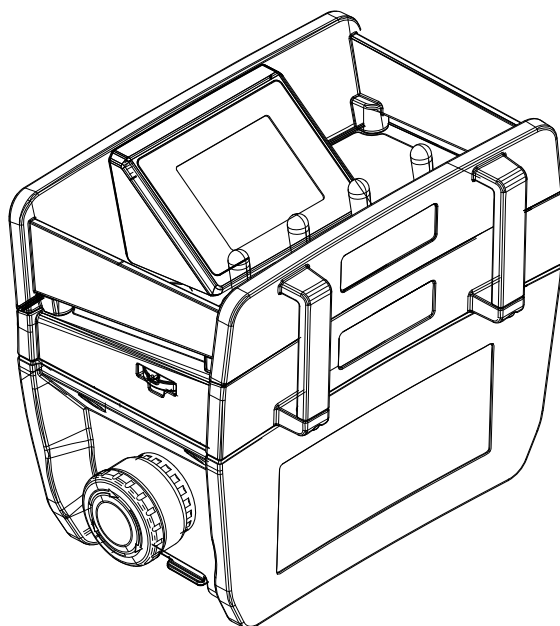

Part C: SIDEKICK SK8B Transmitting Unit

AIR SERIES



WARNING

THIS PART OF THE MANUAL CONSISTS OF: Part C - Information, instructions and warnings for the SIDEKICK SK8B Transmitting Unit. The Manual consists of Part A – General, Part B – Conformity and Frequencies, Part C – Transmitting Unit, Part D – Receiving Unit, Part E – Battery and Battery Charger, plus the Technical Data Sheet.

THIS MANUAL, INCLUDING ALL PARTS THEREOF, AND ALL INSTRUCTIONS CONTAINED HEREIN, MUST BE READ CAREFULLY AND UNDERSTOOD BEFORE INSTALLING, USING, MAINTAINING OR REPAIRING THE AUTEK RADIO REMOTE CONTROL.

FAILURE TO READ AND COMPLY WITH ALL APPLICABLE WARNINGS AND INSTRUCTIONS OR ANY ONE OF THE LIMITATIONS NOTED IN THIS MANUAL CAN RESULT IN SERIOUS BODILY INJURY OR DEATH, AND/OR PROPERTY DAMAGE.

THE AUTEK RADIO REMOTE CONTROL IS NOT A STANDALONE PRODUCT AND IS INTENDED ONLY AS A COMPONENT ON A MACHINE:

- ON WHICH AND WHERE THE USE OF A RADIO REMOTE CONTROL IS APPROPRIATE,
- THAT CAN BE OPERATED SAFELY AND IN ACCORDANCE WITH ALL APPLICABLE LAWS, REGULATIONS AND STANDARDS BY SUCH REMOTE CONTROL.

ACCORDINGLY, IT IS THE RESPONSIBILITY OF THE MACHINE MANUFACTURER ON WHICH THE AUTEK RADIO REMOTE CONTROL IS INTENDED TO BE INSTALLED, to perform an in-depth and accurate risk assessment to determine if the Autec Radio Remote Control is suitable for operating a Machine in conditions of safety and operational effectiveness, taking into account the conditions of use, the intended uses and the reasonably foreseeable incorrect ones, so that the installation, maintenance and use of the Autec Radio Remote Control, and all its components, are performed only and entirely in compliance with this Manual and in accordance with all local regulations, safety standards and regulations (referred to herein as "Laws, Regulations and Standards").

With reference to the USA market the Laws, Regulations and Standards include all safety rules and regulations of the Occupational Safety & Health Administration (OSHA) (<http://www.osha.gov>), all federal, state and local laws, regulations and building and electrical codes, and all applicable standards, including but not limited to ANSI Standards.

It is also the responsibility of the Manufacturer and of the design professionals of the Machine on which the Autec Radio Remote Control is to be installed and used to be certain that the structure, condition, organization and markings of the Machine as installed at the facility is appropriate for and will allow for the safe and reliable use and control of the Machine through the Autec Radio Remote Control interface.

IT IS THE RESPONSIBILITY OF THE OWNER AND FACILITY OPERATOR, AND THEIR DESIGN PROFESSIONALS, that the installation, maintenance and operation of the Autec Radio Remote Control and all of its components are done solely and completely in accordance with this Manual, and with all applicable Laws, Regulations and Standards, even local. It is also the responsibility of the Manufacturer of the Machine on which the Autec Radio Remote Control is to be installed and used, and their design professionals, to be certain that the structure, condition, organization and markings of the Machine as installed at the facility is appropriate for and will allow for the safe and reliable use and control of the Machine through the Autec Radio Remote Control interface.

ONLY QUALIFIED AND PROPERLY TRAINED PERSONNEL SHOULD BE PERMITTED TO OPERATE OR USE THE AUTEC RADIO REMOTE CONTROL AND THE MACHINE OPERATED BY OR THROUGH THE AUTEC RADIO REMOTE CONTROL. ONLY QUALIFIED AND PROPERLY TRAINED PERSONNEL SHOULD BE PERMITTED TO BE IN THE VICINITY OF MACHINE OPERATED BY OR THROUGH THE AUTEC RADIO REMOTE CONTROL.

FAILURE TO PROPERLY INSTALL, OPERATE, MAINTAIN AND SERVICE THE AUTEC RADIO REMOTE CONTROL CAN RESULT IN SERIOUS BODILY INJURY OR DEATH AND/OR PROPERTY DAMAGE. Refer to this Manual and each of its Parts for further assistance or contact Autec. Autec is not responsible for and shall not be held liable for any installation of the Autec Radio Remote Control not performed by Autec or for any use of the Autec Radio Remote Control not in complete compliance with, and/or not maintained in complete compliance with, all Autec instructions and warnings and all applicable Laws, Regulations and Standards, even local.

Autec is not responsible for and shall not be held liable for any alteration or modification of the Autec Radio Remote Control, or the use of non-Autec components or products used with or incorporated into the Autec Radio Remote Control.

IT IS THE RESPONSIBILITY OF THE OWNER AND FACILITY OPERATOR, AND THEIR DESIGN PROFESSIONALS, to be certain that the Autec Radio Remote Control is properly maintained and serviced at all times in compliance with all Autec instructions and warnings, and with all applicable Laws, Regulations and Standards, even local.

IT IS THE RESPONSIBILITY OF THE OWNER AND FACILITY OPERATOR, AND THEIR OFFICERS, MANAGERS AND SUPERVISORS, to be certain that all Users of the Autec Radio Remote Control and that all Persons who are or will be working with or near the Machine operated by or through the Autec Radio Remote Control are fully and properly educated and trained by qualified Personnel in the proper and safe use of the Autec Radio Remote Control and of the Machine, including without limitation complete familiarity with and understanding of Autec warnings and instructions, and all applicable Laws, Regulations and Standards, even local, and that such Users and other Persons do in fact at all times operate or work with the Autec Radio Remote Control safely and ONLY in compliance with Autec instructions and warnings and with all applicable Laws, Regulations and Standards, even local. FAILURE TO DO SO CAN RESULT IN SERIOUS BODILY INJURY OR DEATH AND/OR PROPERTY DAMAGE.

IT IS THE RESPONSIBILITY OF THE OWNER AND FACILITY OPERATOR, AND THEIR OFFICERS, MANAGERS AND SUPERVISORS, to be certain that the areas in which the Machine operated by or through the Autec Radio Remote Control is located and operates are clearly delineated and marked in accordance with all Autec warnings and instructions, and all applicable Laws, Regulations and Standards, even local, and otherwise sufficient to alert and warn ALL PERSONS that the Machine is operated by or through a Radio Remote Control, and prohibiting any unauthorized access thereto. FAILURE TO DO SO CAN RESULT IN SERIOUS BODILY INJURY OR DEATH AND/OR PROPERTY DAMAGE.

FAILURE TO OPERATE THE AUTEC RADIO REMOTE CONTROL SAFELY AND IN COMPLIANCE WITH AUTEC INSTRUCTIONS AND WARNINGS AND WITH APPLICABLE LAWS, REGULATIONS AND STANDARDS, EVEN LOCAL, AND/OR PERMITTING USERS OR OTHER PERSONS NOT PROPERLY TRAINED IN THE SAFE AND PROPER USE OF THE SYSTEM, OR THE MACHINE ON WHICH IT IS INSTALLED, CAN RESULT IN SERIOUS BODILY INJURY OR DEATH AND/OR PROPERTY DAMAGE.

INDEX

1	Information on the use of instructions	8
1.1	Structure of the Instruction Manual	8
1.2	Caption and terminology	10
1.3	Symbols	10
1.4	To whom the instructions are addressed	11
1.5	Instruction storage	11
1.6	Intellectual property	11
2	Brief product presentation	12
2.1	Series, Radio Remote Control and Unit	12
2.2	Conformity with standards	12
2.3	Contacts and useful addresses	12
2.4	Warranty	12
2.5	Technical assistance and spare parts	12
3	Description of the Transmitting Unit	13
3.1	Description of the SK8B Transmitting Unit	13
4	Technical data	15
5	Technical Data Sheet	15
6	Plates	16
7	Light and acoustic warning signals	17
7.1	Light signals	17
7.2	Acoustic signals	20
8	General operating instructions	21
8.1	Power keyswitch	21
8.2	START pushbutton	21
8.3	GSS pushbutton	22
8.4	EMS pushbutton	22
8.5	DISPLAY pushbutton (if the Transmitting Unit has a display)	23
8.6	Battery	23
8.7	ID internal tx memory	25
8.8	Zero-G sensor	25
8.9	Starting up the Radio Remote Control	26
8.10	Command activation	28
8.11	Interruption of the radio link	28
8.12	Transmitting Unit automatic switch off	28
8.13	Switching off the Transmitting Unit	29
8.14	Data Feedback Function	30
8.15	Cable control	31
8.16	BACK-UP UNIT	33
9	Instructions for the User	34
9.1	Usage restrictions	34
9.2	User behaviour	34
9.3	Belt or harness	36
10	Maintenance	38
11	Malfunction signalled by the Transmitting Unit	39
12	Decommissioning and disposal	41

1 Information on the use of instructions



Before reading this part of the Manual, you must read and understand the general part (Part A) of the Manual provided with the Radio Remote Control.

1.1 Structure of the Instruction Manual

The Manual for the use and maintenance of Autec Radio Remote Controls consists of different parts, that altogether form the Manual; the Manual must be read carefully, understood and applied by the Radio Remote Control's Owner, User and by all those Persons that, for any reasons, may operate with the Radio Remote Control or with the Machine where it is installed. The following table describes the structure of the Instruction Manual for the use and the maintenance of the Radio Remote Control.

Part	Title	Contents
A	General part	<ul style="list-style-type: none"> - General information regarding the series, - directions for risk assessment of the "Machine+Radio Remote Control" system, - warnings for installation of the Radio Remote Control, - warnings for use and maintenance of the Radio Remote Control, - instructions for correct transportation and storage of Radio Remote Control.
B	Conformity and frequencies	<ul style="list-style-type: none"> - Operating frequency bands of the Radio Remote Control, - conformity and law references of the Radio Remote Control.
C	Transmitting Unit	Description and instructions concerning the Transmitting Unit, including: <ul style="list-style-type: none"> - description of operation, - commands, - light signals, - malfunctions, - additional instructions to the general part.
D	Receiving Unit	Description and instructions concerning the Receiving Unit, including: <ul style="list-style-type: none"> - description of operation, - light signals, - malfunctions, - additional instructions to the general part.
E	Battery and battery charger	Description, warnings and instructions concerning batteries and battery chargers, including: <ul style="list-style-type: none"> - description of operation, - light signals, - malfunctions, - instructions for the User.

Usage and maintenance instructions are supplemented by the Radio Remote Control's Technical Data Sheet, that:

- Describes the Transmitting Unit's configuration
- Indicates the relation between commands sent by the Transmitting Unit and those available on the Receiving Unit.

Usage and maintenance instruction as a whole are to be considered as an integral part both of the Autec Radio Remote Control and of the Machine, system, device or Machinery system where the Radio Remote Control is installed.

The Manufacturer of the Machine on which the Autec Radio Remote Control is installed, and the Owner and User of the Machine, must make sure that the Instruction Manual and all of its parts are included in the Instruction Manual of the Machine.

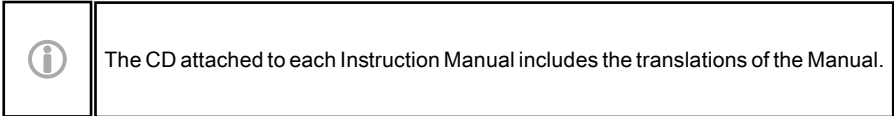

Act as follows to identify the single Manual parts in the relevant language in the CD:

- Identify the correct section depending on the Radio Remote Control serial number
- Choose the desired language
- Select the single parts of the Manual: refer to the code name provided on the cover of each part.

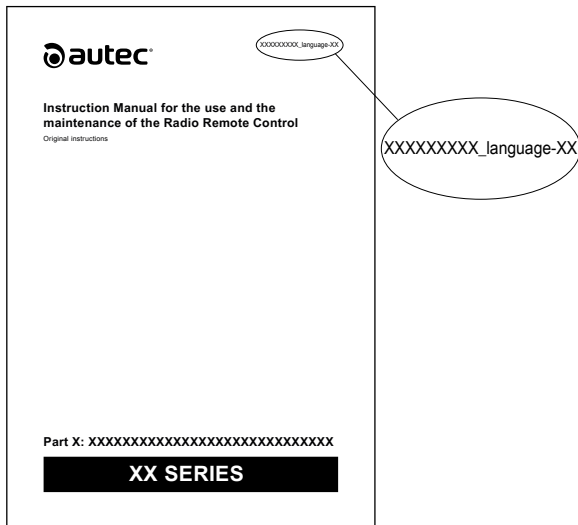

1.2 Caption and terminology



Contact Autec if any of the instructions, symbols, warnings or images are not clear and understandable.

In this part of the Manual, the terms listed below have the same meaning explained in the corresponding paragraph of the general part (Part A):

- **Unit**
- **Radio Remote Control**
- **Transmitting Unit**
- **Receiving Unit**
- **Radio link**
- **Active stop**
- **Automatic stop**
- **Manual stop**
- **Passive stop**
- **Machine**
- **Manufacturer**
- **Installer**
- **User**
- **Maintenance Technician**
- **Manual or Instruction Manual**
- **Installation manual**
- **Person**
- **Owner**

Functions indicated for the Manufacturer, the Installer, the User and the Maintenance Technician may be performed by a single Person, if he/she has the needed competence and undertakes the resulting responsibilities. Each Person must be aware of the instructions contained in the Manual, depending on the activity they carry out.

For example, if a Manufacturer is also the Installer, and/or Maintenance Technician, he/she must also know and follow the instructions specifically addressed to those Persons. The same applies, for example, if a User is also the Manufacturer and/or the Installer.

1.3 Symbols



This symbol identifies the parts of text in the Manual that must be read with special attention.



This symbol identifies the parts of text in the Manual containing warnings, information and/or instructions that are particularly relevant with regards to safety; failure in understanding them or in complying with them may cause hazards for People and/or property.

1.4 To whom the instructions are addressed

Addressees of instructions are listed in the paragraph with the same title in the general part: please refer to that part.

1.5 Instruction storage

Regulation for the storage of instructions are described in the paragraph with the same title in the general part: please refer to that part.

1.6 Intellectual property

Restrictions connected to intellectual property are described in the paragraph with the same title in the general part: please refer to that part.

2 Brief product presentation

2.1 Series, Radio Remote Control and Unit

The object of this part of the Manual is the SIDEKICK SK8B Transmitting Unit of an Autec Air series' Radio Remote Control.

Autec Air series' Radio Remote Controls are designed to be used on Machines and provide a command interface to their command and control system, to be used from an appropriate distance and position.

2.2 Conformity with standards

The conformity of Radio Remote Controls with standards and with working requirements and conditions in the single Countries is provided in the related specific part "Conformity and frequencies" (Part B) of the Manual.

2.3 Contacts and useful addresses

The Radio Remote Controls are produced by Autec Srl – Via Pomaroli, 65 - 36030 Caldogno (VI) - Italy.

You can find contacts for Autec, its distributors, dealers and authorized service centres on the website www.autecsafety.com.

2.4 Warranty

General warranty conditions are indicated both in the relevant sheet provided together with this documentation, and in the specific page on the website www.autecsafety.com.

2.5 Technical assistance and spare parts

If you need technical services and/or spare parts, please refer to contacts provided in the website www.autecsafety.com.

When applying for technical service to Autec, its distributors, dealers and authorized service centres, the Radio Remote Control's serial number is required; you can find it on the identification plate on the Transmitting Unit and/or on the Receiving Unit.

3 Description of the Transmitting Unit

3.1 Description of the SK8B Transmitting Unit

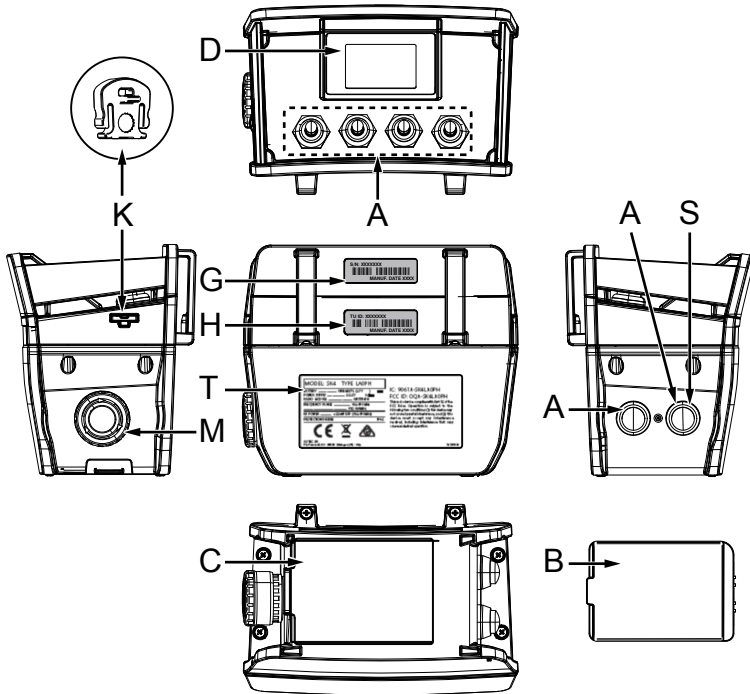

A	Actuators (selectors, pushbuttons)	H	Transmitting Unit identification plate
B	Battery	K	Power keyswitch
C	Battery housing	M	GSS or EMS pushbutton
D	Display	S	START pushbutton
G	Radio Remote Control identification plate	T	Technical data plate

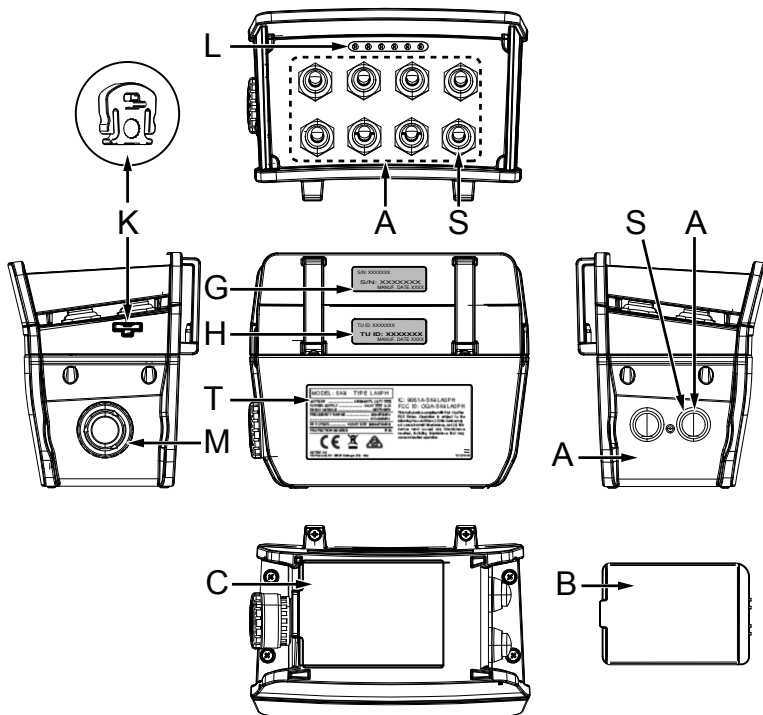

A	Actuators (selectors, pushbuttons)
B	Battery
C	Battery housing
G	Radio Remote Control identification plate
H	Transmitting Unit identification plate

K	Power keyswitch
L	LEDs
M	GSS or EMS pushbutton
S	START pushbutton
T	Technical data plate

4 Technical data

Power supply	battery LPM02
	battery MBM06MH
Antenna	integrated
Housing material	PA 6 (20%fg)
Protection degree	IP65 (NEMA 4)
Dimensions	144x100x121mm (5.67x3.94x4.76in)
Weight	0.75kg (1.65lb)
Run time at 20°C (68°F) with LPM02 battery	24h
Run time at 20°C (68°F) with LPM02 battery and 1.8" colour display	10h
Run time at 20°C (68°F) with MBM06MH battery	12h
Power frequency magnetic field immunity according to CEI EN 61000-4-8	up to 300A/m

5 Technical Data Sheet

The Radio Remote Control 's Technical Data Sheet:

- Describes the Transmitting Unit's configuration
- Indicates the relation between commands sent by the Transmitting Unit and those available on the Receiving Unit.

The Technical Data Sheet must be filled in, checked and signed by the Installer, who is responsible for correct wiring.

A Technical Data Sheet must always be kept together with this Manual: if you need to use the Technical Data Sheet for administrative purposes (tests, check, etc.), make a copy of it.

 WARNING	<p>The wiring of the Receiving Unit's outputs must always reflect the wiring indicated in the Technical Data Sheet.</p>
---	--

6 Plates

Plate	Position	Content
Radio Remote Control identification plate	Behind the belt on the back side of the Transmitting Unit	Radio Remote Control serial number (S/N)
Transmitting Unit identification plate	Behind the belt on the back side of the Transmitting Unit	Manufacturing year, a QR code and the Transmitting Unit identification number (TU ID)
Technical data plate	Back side of the Transmitting Unit	MODEL, TYPE and main Transmitting Unit technical data, marking and possible Radio Remote Control marks

7 Light and acoustic warning signals

7.1 Light signals

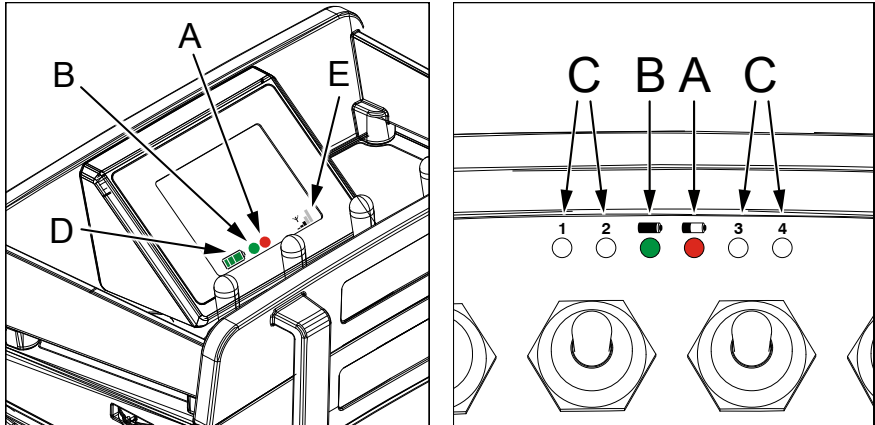

A	Red LED
B	Green LED
C	LEDs for "Data Feedback" function
D	Battery icon
E	Radio link icon

The Transmitting Unit always has a green LED [B] and a red LED [A] that provide information regarding the Radio Remote Control.

Symbol	Meaning
	This symbol identifies the red LED [A]
	This symbol identifies the green LED [B]

	<p>The meaning of signals provided by the LEDs identified with "C" are explained in the Data Feedback function part (see paragraph 8.14). The meaning of LEDs related to the Data Feedback function are decided and established by the Machine Manufacturer depending on the Machine's functions for which he wants to receive information.</p>
--	---

7.1.1 Red LED [A] and green LED [B]

The meaning of red LED [A] and green LED [B] signals is described in the following tables; possible actions to perform are given in chapter 11

	The meaning of the red and green LED signals cannot be modified.
---	--





Signals	Meaning
The green LED is off.	The Transmitting Unit is off.
The green LED is steady on.	The Transmitting and Receiving Unit do not communicate.
The green LED repeats the sequence: two blinks and a pause.	The working range of the remote control has been exceeded for more than 20 seconds.
The green LED repeats the sequence: three blinks and a pause.	The Transmitting Unit does not receive feedback data from the Receiving Unit (see paragraph 8.14).
The green LED blinks fast.	The Transmitting and Receiving Unit communicate. The Radio Remote Control is not started.
The green LED blinks slowly (one blink per second).	The Radio Remote Control is started.
The red LED is off.	The Transmitting Unit works correctly.
The red LED blinks twice per second at Radio Remote Control's start up.	At least one of the commands that were checked at start-up is enabled (see Technical Data Sheet).
The red LED blinks three times per second at Radio Remote Control's start up.	The battery is flat.
The red LED is steady on for two seconds at Radio Remote Control's start up.	The Transmitting Unit does not work correctly.
The red LED blinks slowly (one blink per second).	The Transmitting Unit has about 1-hour run time after the onset of signal.
The red LED blinks quickly.	The Transmitting Unit has a 10-minute run time after the onset of signal.

Signals	Meaning
The green LED and the red LED are steady on at Radio Remote Control's start up and an acoustic signal sounds.	Wrong Key ID 0-1 or ID internal tx memory has been inserted in the Transmitting Unit.
	You're using a BACK-UP UNIT with the Key ID 0-1 or ID internal tx memory of the Transmitting Unit that has been replaced.
The green LED and the red LED blink three times per second at Radio Remote Control's start up.	The Key ID 0-1 or ID internal tx memory is damaged.
The green LED is steady on and the red LED blinks twice per second at Radio Remote Control's start up.	START is active.
The green LED] and the red LED blink alternating.	30s left before the Transmitting Unit automatically switches off.
The green LED repeats the sequence three blinks and a pause, and the red LED is steady at Radio Remote Control's start up.	The UNPAIR procedure has been carried out.
The green LED and the red LED are off at Radio Remote Control's start up	The GSS or the EMS pushbutton is pressed.
	The power keyswitch is not inserted.
	The battery is completely discharged or not inserted.

7.1.2 Battery icon

The display on the SK8B Transmitting Units has a Battery icon [D] that provides indications related to the battery charge level.



The Battery icon [D] shows a bar whose length and colour indicate the battery power level.

Symbol	Meaning
	High power level (green bar).
	Medium power level (green bar).
	Low power level (green bar): the battery has less than 1h run time from the beginning of this signal.
	Very low power level (red bar): the battery has 10min run time from the beginning of this signal.
	The Unit is about to switch off (blinking red bar): the battery has 2min run time from the beginning of this signal.

7.1.3 Radio link icon

The display on the SK8B Transmitting Units has a Radio Link icon [D] that provides indications on the quality of the radio link.

The Radio link icon [E] consists of five vertical bars. The amount of dark bars is proportional to the quality of the radio link.

Symbol	Meaning
	Strong radio link signal.
	Medium radio link signal.
	No radio link.

7.2 Acoustic signals

The Transmitting Unit has an acoustic signal device that activates when:

- The Transmitting Unit has a 10-minute run time.
- During start up, the Radio Remote Control detects that a wrong Key ID 0-1 or ID internal tx memory has been inserted in the Transmitting Unit, or this is a BACK-UP UNIT.

	The meaning of the acoustic signals cannot be modified.
---	---

8 General operating instructions

8.1 Power keyswitch

The Transmitting Unit always has a power keyswitch called T-key that allows to power the Unit. The Radio Remote Control cannot work if the power keyswitch is not inserted in the Transmitting Unit.

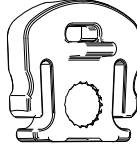

8.1.1 Inserting the power keyswitch

insert the power keyswitch into its receptacle.

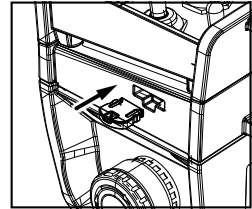

8.1.2 Removing the power keyswitch

Pull the power keyswitch to remove it from its receptacle.

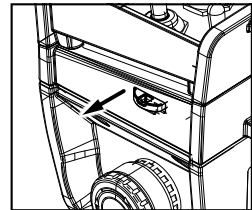

8.2 START pushbutton

The START pushbutton is used to:

- start the Radio Remote Control (see paragraph 8.9)
- activate the horn when the Radio Remote Control is started.

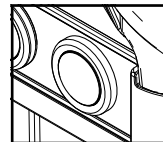

8.3 GSS pushbutton

When the GSS pushbutton (if any) is activated, the Transmitting Unit switches off and the Machine stops. To start the Radio Remote Control again and enable it to control the Machine after the GSS pushbutton has been pressed, you need to:

- Make sure that the working and usage conditions are safe.
- Pull or turn the GSS pushbutton in the arrow direction (shown on the button) to unlock it.
- Start the Radio Remote Control following the procedure described in paragraph 8.9).

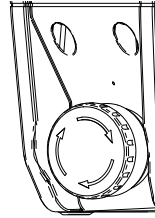

The GSS pushbutton should be pressed when it is necessary to stop the Machine immediately whenever a dangerous condition occurs.

The Machine Manufacturer and/or the Installer must provide the User with the instructions and warnings concerning possible risks that may originate from the Machine stop (by way of example: movement inertia, swinging load...).

8.4 EMS pushbutton

When the EMS pushbutton (if any) is activated, the Transmitting Unit switches off and the Machine stops. To start the Radio Remote Control again and enable it to control the Machine after the EMS pushbutton has been pressed, you need to:

- Make sure that the working and usage conditions are safe.
- Pull or turn the EMS pushbutton in the arrow direction (shown on the button) to unlock it.
- Start the Radio Remote Control following the procedure described in paragraph 8.9).

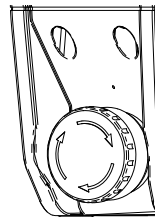

The EMS pushbutton should be pressed when it is necessary to stop the Machine immediately whenever a dangerous condition occurs.

The Machine Manufacturer and/or the Installer must provide the User with the instructions and warnings concerning possible risks that may originate from the Machine stop (by way of example: movement inertia, swinging load...).

8.5 DISPLAY pushbutton (if the Transmitting Unit has a display)

The functions of this pushbutton are:

- Activates the display lighting.
- It cyclically scrolls the information on the display in two different modes:
 - Manual: the lines scroll up each time the pushbutton is pressed.
 - Automatic: when the DISPLAY pushbutton is pressed for 3 seconds, the lines scroll automatically. If the DISPLAY pushbutton is pressed again, it switches back to Manual mode.

It is not possible to scroll the lines if icons only are displayed.

The display lighting stays on for a time set by the Machine Manufacturer.

8.6 Battery

 WARNING	<p>The Air series' Transmitting Units can only be powered by Autec rechargeable batteries.</p> <p>For any warnings and instructions regarding the battery, see "Part E" in the Instruction Manual.</p>
--	--

8.6.1 Battery insertion

To insert the battery, proceed as follows:

1. Push the battery towards the contacts of the Transmitting Unit.
2. Insert the battery in its housing.

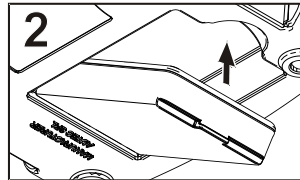
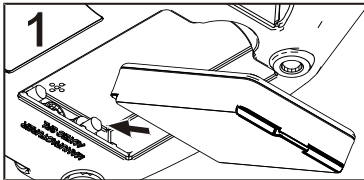

	<p>The battery slides easily into place and ensures that the positive (+) and negative (-) poles are correctly connected only if it is inserted with the plate facing its housing, so that the battery's contacts match the Transmitting Unit's contacts.</p>
---	---

8.6.2 Battery removal

To remove the battery, proceed as follows:

1. Push the battery towards the contacts of the Transmitting Unit.
2. Remove the battery from its housing.

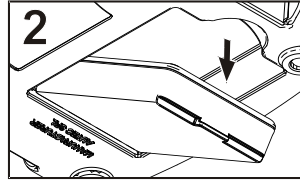
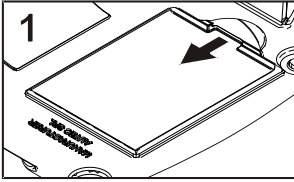

When the Transmitting Unit is not in use, remove the battery if possible.

8.6.3 Indication of the battery charge level

Perform the following actions to check the Transmitting Unit's battery charge level:

1. Switch off the Transmitting Unit and make sure that the GSS or EMS pushbutton is unlocked.
2. First activate S1 (check in the Technical Data Sheet which actuator corresponds to it) and then START and hold them active until the LEDs indicating the battery level illuminate. The charge level indication disappears after some seconds.
 - One LED on: low level.
 - Two LEDs on: medium level.
 - Three LEDs on: maximum level.



Commands associated to the actuators that are activated during the procedure to check the battery charge level are not sent to the Machine.

If the Transmitting Unit has a display, the battery charge level is shown by the corresponding icon on the display.

8.7 ID internal tx memory

The ID internal tx memory is a key containing the address that is used to code messages exchanged between the Transmitting Unit and the Receiving Unit. This key is inside the Transmitting Unit.

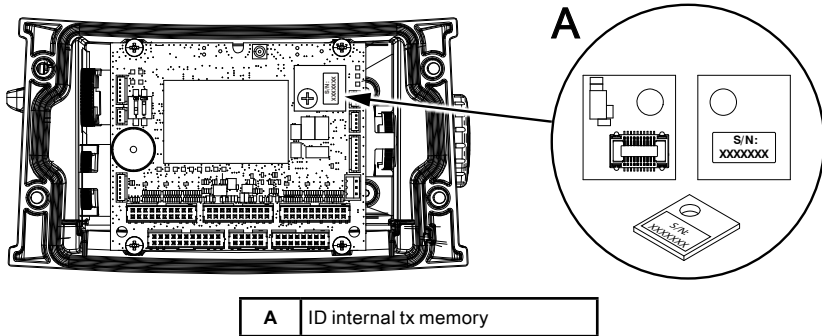

A ID internal tx memory

8.8 Zero-G sensor



The Transmitting Unit is equipped with a Zero-G only upon request of the Machine Manufacturer and/or of the Installer, who are responsible for the decision on the conditions for activation of the Zero-G sensor. The Radio Remote Control User must be properly trained about this.

The Zero-G sensor can activate due to one or more of the following causes:

- **Impact:** The Zero-G sensor activates when the Transmitting Unit has an impact with at least a 30-centimetre movement and with an acceleration higher than 2g.
- **Fall:** the Zero-G sensor activates when the Transmitting Unit falls from higher than 1 metre.
- **Tilt:** the Zero-G sensor activates when the Transmitting Unit is tilted for more than one second by a defined dangle with respect to the ground. The value of the tilting angle is set by Autec, but it is decided by the Machine Manufacturer and/or by the installer (possible options: 45°/60°/90°).

The Zero-G sensor also activates when the Transmitting Unit is thrown, or rolls, as soon as the sensor detects one of the above-mentioned causes (impact, fall, tilt).

Autec sets the system so that when the Zero-G sensor activates, one of the following behaviour occurs:

- Transmitting Unit is switched off.
- A command is sent to the Receiving Unit.

8.9 Starting up the Radio Remote Control

Starting up the Radio Remote Control means enabling it to send commands and operate the Machine.

 WARNING	<p>The Radio Remote Control start up is protected by a power keyswitch to prevent unauthorised use of the Machine. If the risk assessment requires further protection of the Radio Remote Control from unauthorized use, the Machine Manufacturer and/or the Installer of the Radio Remote Control can also enable a PIN code.</p> <p>Autec will enable the PIN code for the Radio Remote Control start up only upon request by the Machine Manufacturer and/or the Radio Remote Control Installer.</p> <p>To activate the Radio Remote Control you need to insert the power keyswitch and enter the PIN code (if applicable) following the procedure indicated in paragraph 8.9.1 or 8.9.2.</p>
--	---

The PIN code is not a sequence of numbers, but it consists in the sequential activation of a series of commands.

	<p>Commands activated while entering the PIN code are not sent to the Machine, therefore they do not activate the corresponding Machine's movements and/or functions.</p>
---	---

8.9.1 Power keyswitch start up (no PIN code)

When the Receiving Unit is powered on correctly, perform the following procedure:

1. Insert a fully charged battery in the Transmitting Unit (see paragraph 8.6.1).
2. Insert the power keyswitch in the Transmitting Unit.
3. Make sure that the GSS or EMS pushbutton is not pressed.
4. Activate START and hold it active until the green LED blinks fast.
5. Release START.

When the green LED blinks slowly, the Radio Remote Control is started.

8.9.2 Power keyswitch + PIN code start up

	<p>WARNING: Make sure that a PIN code for start up is enabled in the Transmitting Unit. In fact, if a PIN code is not enabled for start up in the Transmitting Unit, the following procedure may start the Machine at first activation of the START.</p>
---	---

When the Receiving Unit is correctly powered on, perform the following procedure; activate each command within 3 seconds after releasing the previous one:

1. Insert a fully charged battery in the Transmitting Unit (see paragraph 8.6.1).
2. Insert the power keyswitch in the Transmitting Unit (see paragraph 8.1).
3. Make sure that the GSS or EMS pushbutton is not pressed.
4. Activate START and hold it active until the green LED illuminates.
5. Activate the commands corresponding to PIN code in the correct sequence (PIN 1, PIN 2 and PIN 3 given in the Technical Data Sheet).
 - a. PIN 1 shall not be included in the start up procedure if it corresponds to START.
 - b. PIN 3 shall not be included in the start up procedure if it corresponds to START.
6. Activate START and hold it active until the green LED blinks fast.
7. Release START.

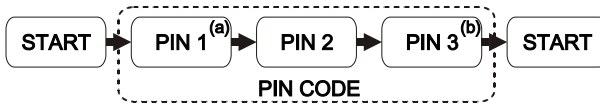

When the green LED blinks slowly, the Radio Remote Control is started.

Note: the default PIN code set by Autec is the following:

- PIN 1 = START
- PIN 2 = FUNCTION
- PIN 3 = START

	<p>Autec will set a customized PIN code only upon request by the Machine Manufacturer or the Installer.</p>
---	---

8.9.3 Procedure to modify the PIN code

If a PIN code is needed for the Transmitting Unit, it can be modified to limit the use of the Radio Remote Control.

To modify the PIN code, perform the following procedure with the Transmitting Unit switched off and the GSS or EMS pushbutton released.

1. Enable command S0 and START and keep them enabled until the green LED blinks (1 blink per second).
2. Activate the commands of the PIN code sequence provided in the Technical Data Sheet.
3. Activate command S1 (see Technical Data Sheet) repeatedly until LED 2 illuminates.

4. Activate command S2 (see Technical Data Sheet) to confirm your selection (green LED blinks twice per second). You can choose the 3 commands you want to set as PIN code amongst all the commands on the Unit.
 - If you want to start the Radio Remote Control with a single-command PIN code, enable START as PIN 1 and PIN 3.
 - If you want to start the Radio Remote Control with a two-command PIN code, enable START as PIN 1 or PIN 3.
5. Activate the command you want to allocate as PIN 1 (LED 1 and green LED are steady on).
6. Activate the command you want to allocate as PIN 2 (LED 2 and green LED are steady on).
7. Activate the command you want to allocate as PIN 3 (LED 3 and green LED are steady on). PIN code is saved automatically.

8.10 Command activation

When the Radio Remote Control is started, it is possible to activate movements, functions and commands on the Machine by acting on the related pushbuttons or switches, whose functions and symbols are decided by the Manufacturer and/or the Installer.

To identify the relation between the actuators and the corresponding Machine movements, the Machine Manufacturer and/or the Installer shall provide relevant instructions and the User shall be properly trained.

8.11 Interruption of the radio link

When the radio link is incorrect or interrupted, the automatic stop function activates (see paragraph "Control devices" in the Instruction Manual's general part).

The green LED of the Transmitting Unit signals this interruption by switching from slow blinking to one of the following statuses (see chapter 11):

- fast blink;
- on with steady light;
- two blinks and a pause;
- three blinks and a pause.

8.12 Transmitting Unit automatic switch off

Automatic switch off of the Transmitting Unit occurs in the following cases:

- When the battery is flat (see paragraph 8.12.1).
- When the Radio Remote Control is not used for a certain time (see paragraph 8.12.2).

To start the Radio Remote Control, see paragraph 8.9).

8.12.1 Low battery

The Transmitting Unit indicates if the battery is not sufficiently charged.

- The red LED blinks slowly (one blink per second): the Transmitting Unit has about 1-hour run time after the onset of signal.
- The red LED blinks fast: the Transmitting Unit has a 10-minute run time from the onset of signal, after which the Transmitting Unit will automatically switch off.

It is necessary to bring the Machine to a safe state and replace the battery with a charged one (see paragraph 8.6).

	<p>The battery run time signalled by the Transmitting Unit is reduced by the following factors:</p> <ul style="list-style-type: none"> - Battery ageing - Increasing number of battery charge-discharge cycles - Battery usage outside the range provided in paragraph "Operational usage" in "Part A" of the Manual. - Battery storage in disregard of the indications given in paragraph "Storage" in the instruction manual for the use and maintenance of the battery and battery charger.
---	--

8.12.2 When the Transmitting Unit is not used

If the Transmitting Unit remains started with no enabled commands, it will automatically switch off after a predetermined time frame. This time frame is specified in the Technical Data Sheet (SWITCH-OFF).

Before the Transmitting Unit switches off automatically, the green and red LEDs blink alternating for 30 seconds.

Activating any actuator corresponding to a movement command reduces the predetermined automatic switch-off time (SWITCH-OFF) to zero.

	<p>Setting or removal of the automatic switch off time (SWITCH-OFF) is done by Autec and decided by the Machine Manufacturer or by the Installer, depending on the operation and functions they need on the Machine.</p>
---	--

8.13 Switching off the Transmitting Unit

 WARNING	<p>Switch off the Transmitting Unit when not actively using the Radio Remote Control to operate the Machine, or when work is otherwise interrupted, even for short periods. Do not leave the load hanging or the Machine in dangerous conditions (even when charging the Unit or changing the battery).</p> <p>FAILURE TO DO SO CAN RESULT IN SERIOUS BODILY INJURY OR DEATH AND/OR PROPERTY DAMAGE.</p>
--	--

Voluntary switch off of the Transmitting Unit occurs in the following cases.

- When the battery is removed (see paragraph 8.6.2).
- When the power keyswitch is removed (see paragraph 8.1).

8.14 Data Feedback Function

The User receives information and/or signals concerning some specific situations and the movements of the controlled Machine by means of the Data Feedback function.

The Data Feedback function acts through the LED array and/or the display.

	<p>Any information shown and signalled on the display and/or through the LEDs for Data Feedback function can never be considered or used as a safety signal or for legal metrology.</p> <p>When operating the Machine, remember that the Radio Remote Control does not cut in autonomously when potential hazardous situations are shown and signalled.</p> <p>If the green LED repeats the sequence "three blinks and a pause", no information and/or signals related to the Data Feedback function is shown via the LEDs and/or display. The Transmitting Unit may however be able to send commands (if activated) to the Receiving Unit and activate movements on the Machine. In this case, bring the Transmitting Unit closer to the Receiving Unit until the green LED blinks slowly.</p>
---	--

During normal Radio Remote Control operation, pay particular attention to the indications displayed and signalled by the display and/or through the LEDs: they can be helpful to evaluate the Machine working status.

Operation with display

If the Transmitting Unit has a display, it is possible to show warning icons, the measurements collected from the Machine and their description.

The Machine Manufacturer chooses which information are displayed and the way they are displayed (icons and/or measurements and/or descriptions).

In addition, the battery level and the quality of the radio link are always indicated.

Operation with LED

If the Transmitting Unit has an LED array for the Data Feedback function, specific Machine conditions are signalled if they are illuminated (by way of example: load limits, limit switch).

The signalled conditions depend on the settings chosen by the Machine Manufacturer.

8.15 Cable control

The cable control is used:

- in particular working conditions, established by the Machine Manufacturer
- when it is not possible to establish a radio link between the Radio Remote Control Units,
- when working in environments where it is not allowed to work via radio frequency,
- when a fully charged battery is not available.



ATTENTION: The use of the cable control entails risk of electric shock when working near overhead or underground power line's cables.

8.15.1 Description

The cable control connects the Transmitting Unit to the Receiving Unit through a cable that replaces the radio link. The cable shall be plugged in the suitable connectors, one on the Transmitting Unit and the other on the Receiving Unit (or placed where established by the Machine Manufacturer).

When using the cable control, the working features (e.g. the meaning of actuators and the Data Feedback function) do not change.

8.15.2 Operation

 WARNING	<p>Before starting to work, make sure that the cable and the corresponding connectors are intact.</p> <p>Work organisation, Machines' position, passages, etc. shall be planned so as to avoid that the cable control 's cable may be damaged by moving trolleys or by the ongoing operations.</p> <p>Do not use the cable control's cable to lift the Transmitting Unit.</p> <p>Lay the cable control's cable in such a way as to avoid that it is squashed or strained by People or objects. Avoid contact with sharp or cutting objects that can cut the cable's protective sheath.</p> <p>Using the cable control at the same time as the waist belt or the shoulder harness means that there is a physical connection between the User and the Machine: therefore, the User must constantly check that the Machine's movements, especially in case of loss of control (by way of example: risk of overturning, of cable dragging by other Machinery), do not cause hazards. In such situations, the User must pull out the belt or open it by unfastening its buckle(s).</p>
--	--

	<p>The cable control must only be connected and disconnected when the Transmitting Unit is off.</p> <p>When you finish working with the cable control, disconnect the cable from the Transmitting Unit and from the Machine, and protect the connectors with their caps.</p>
---	--

To control the Machine after the cable control has been connected or disconnected, start the Radio Remote Control (see paragraph 8.9).

When working with the cable control:

- Radio link is cut off.
- Leave the battery inside the Transmitting Unit, even though the power supply comes from the Receiving Unit. The battery is not, in any case, recharged through the cable control: it can only be recharged through its appropriate battery charger provided together with the system.

8.16 BACK-UP UNIT

If the Transmitting Unit cannot be used, it can be replaced with a Transmitting Unit called BACK-UP UNIT; you need to ask for it from Autec.

It is identical to the Unit that cannot be used any more; the only difference is the presence of the plate "BACK-UP UNIT" on the battery housing.

	<p>Insert in the BACK-UP UNIT the ID internal tx memory of the Transmitting Unit that cannot be used any longer and perform the address storage procedure described below.</p> <p>As required by standard IEC 60204-32, each Radio Remote Control is uniquely identified through a serial number (S/N). Therefore, upon replacement of the Unit, the serial number of the Transmitting Unit to be replaced must be written on the BACK-UP UNIT, so that all the Units belonging to the Radio Remote Control show the same serial number.</p> <p>Autec cannot be held responsible if the serial number of the Transmitting Unit to be replaced has not been marked on BACK-UP UNIT.</p>
---	---

8.16.1 Address storage

Perform the following procedure with fully charged battery and power keyswitch inserted in the BACK-UP UNIT:

1. Activate START and hold it active until the green and red LEDs illuminate and an acoustic signal sounds.
2. Wait until the green LED blinks slowly.
3. within 3 seconds, activate in sequence the pushbuttons related to PIN 1, PIN 2 and PIN 3 that compose the PIN code provided in the Technical Data Sheet.

If the PIN code is incorrect, the red LED illuminates and the Transmitting Unit switches off. In this case, the storage procedure shall be repeated.

If the PIN code is correct, the green LED turns steady on and the Transmitting Unit switches off: this indicates that the address has been stored in the BACK-UP UNIT. It is now possible to start the Radio Remote Control and control the Machine with the BACK-UP UNIT Transmitting Unit.

9 Instructions for the User

The chapter "Instructions for the User" in "Part A" of the Instruction Manual contains the warnings for the use that add to those provided in this chapter. Therefore, please refer to that part of the Manual.

The following instructions are general, they refer to general usage situations for the Transmitting Unit, and indicate how people should or should not behave when using the unit: these do not cover any possible risk situation and/or drawback that may depend on specific applications of Autec Radio Remote Controls.

However, instructions given in the following paragraphs do not replace nor complete the instructions that must be provided to the User by the Manufacturer of the Machine where an Autec Radio Remote Control (to which the SIDEKICK SK8B Transmitting Unit belongs) is installed.

9.1 Usage restrictions

 WARNING	<p>If the Radio Remote Control User wears electronic devices (by way of example: pacemaker, implantable cardiac defibrillator, hearing aids), the Transmitting Unit must be kept at least 15 cm away from those devices when in use.</p> <p>Do not expose the Transmitting Unit to strong magnetic fields, as they may affect the correct operation of the Unit (its immunity level is provided in chapter 4).</p>
--	--

9.2 User behaviour

Besides the instructions contained in the General Part (Part A) of the Instruction Manual, when using the Transmitting Unit, the User must:

- Observe and comply with all instructions and warnings provided by the Machine Manufacturer.
- Observe and comply with all instructions and warnings provided by the Installer.
- Observe and comply with all instructions and warnings provided by the Person responsible for the Machine commissioning or making the Machine available for work.
- Observe and comply with all instructions and warnings provided in the Radio Remote Control Manual.
- Observe and comply with all applicable Laws, Regulations and Standards, even local.
- Follow and put into practice the working instructions he/she received, and/or those he/she must be aware of because of his/her work and his/her tasks.
- Avoid using the Radio Remote Control if he has not been properly trained and prepared, and if he has not been qualified for its use by the Person responsible for the work.
- Make sure that the Transmitting Unit and the Receiving Unit are whole and work perfectly.
- Make sure that the Machine reacts correctly to the commands activated by the Autec Radio Remote Control.

- Not perform any operation if the tests mentioned in the previous two points did not give positive results.
- Make sure that the Radio Remote Control operation and the consequent Machine movement occur in safety conditions, to prevent hazards to people and/or property.
- Adopt the necessary caution to avoid that the Machine operation causes dangerous situations of any type; to this end, the User's physical and health status shall be taken into account too.
- Avoid leaving the Transmitting Unit unattended or in such a condition that it may be damaged, tampered with, operated by people who are not qualified or by the movement of people and/or objects (by way of example due to: fall, movement, contact).
- Operate the Transmitting Unit by holding it correctly in his hands, so that he can activate the Machine movements correctly and in safe conditions and monitor its light signals.
- Keep at a safe distance from any risk situations originating from the use of the Machine where the Autec Radio Remote Control is installed.
- Avoid doing anything else while using the Radio Remote Control, such as, by way of example, operate other Machines and/or other devices, eat and/or drink, use communication devices (phone, radio phone, etc.), keyboards, computers, IT devices or AV equipment, or carry out any other action that may pose the User in the situation not to be able to correctly control the Transmitting Unit and/or the Machine.
- Activate immediately the stop devices available on the Transmitting Unit and/or on the Machine, in case dangerous situations occur, even if they do not depend on the use of the Machine.
- Use the Transmitting Unit in such a way as to avoid contact with objects and/or People, fall and loss of control.
- Use the transmitting unit with supports such as belts and the like, which are provided with the Radio Remote Control.
- Not modify or tamper with the Transmitting Unit, its components and/or its commands; not modify the indications and/or meaning and/or abbreviations and/or symbols and/or original stickers on the Transmitting Unit's panel.

9.3 Belt or harness

The Transmitting Unit always comes with a waist belt: the User must mount the belt on the Transmitting Unit and use it as explained in paragraph 9.3.1.



Replace the belt or harness if it is damaged or worn.

9.3.1 Waist belt

Assembly

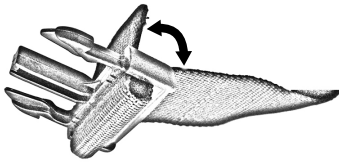

1

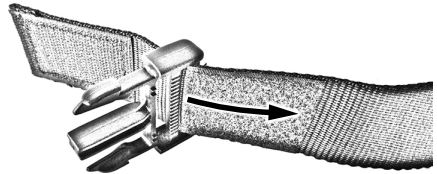

2

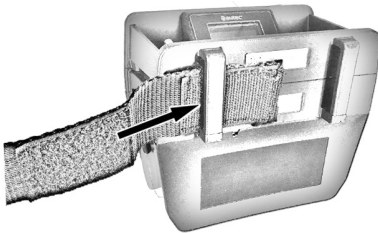

3

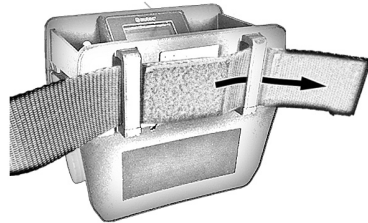

4

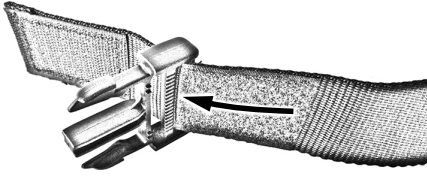

5

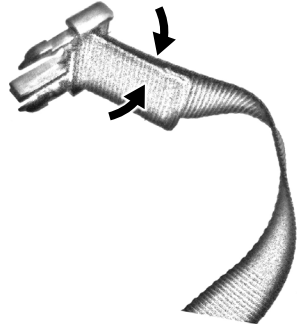

6

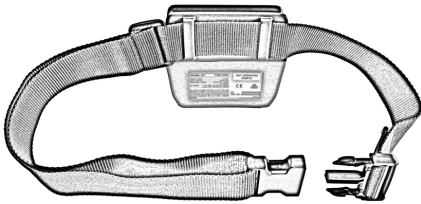

7

Use

The User must wear the Radio Remote Control with the belt as shown in the photo below, to avoid its fall, loss, loss of control, accidental contact and improper use.

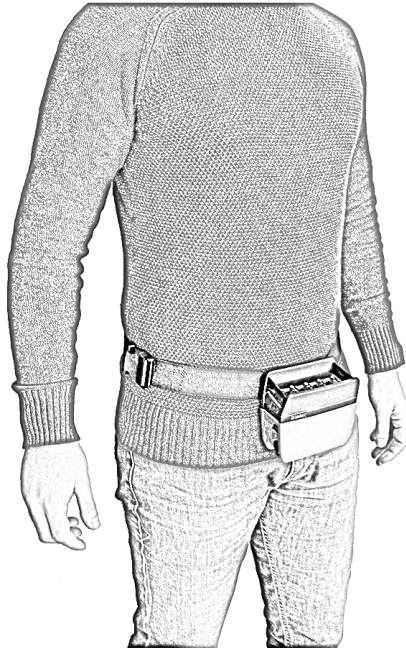

If the Transmitting Unit and the belt are used in a different way from the one described in the above mentioned figure, this constitutes improper use and may lead to damage to the Transmitting Unit, to the User, to people and/or property.

10 Maintenance

Instructions for correct Radio Remote Control maintenance are described in the chapter "Maintenance" included in "Part A" of the Instruction Manual. Therefore, please refer to that part of the Manual.

11 Malfunction signalled by the Transmitting Unit

The table below lists malfunctions that are signalled by LEDs on the Transmitting Unit and the solution to those malfunctions.

If the problem persists after attempting the suggested solution, contact the support service of the Machine Manufacturer.

Signals	Possible reasons	Solutions
The green LED is steady on.	The Transmitting and Receiving Unit do not communicate.	Bring the Transmitting Unit close to the Receiving Unit until the green LED blinks quickly (if the signal doesn't change, check that the Receiving Unit is powered), then activate and release START. When START is released, the green LED starts blinking slowly.
The green LED repeats the sequence: two blinks and a pause.	The working range of the remote control has been exceeded for more than 20 seconds.	Bring the Transmitting Unit close to the Receiving Unit, then activate and release START. When START is released, the green LED starts blinking slowly.
The green LED repeats the sequence: three blinks and a pause.	The Transmitting and Receiving Unit do not communicate.	Bring the Transmitting Unit close to the Receiving Unit until the green LED blinks quickly (if the signal doesn't change, check that the Receiving Unit is powered), then activate and release START. When START is released, the green LED starts blinking slowly.
The green LED blinks fast.	Temporary loss of radio link.	Bring the actuators related to movement commands to the rest position, then activate and release START. When START is released, the green LED starts blinking slowly.

Signals	Possible reasons	Solutions
The green LED blinks slowly (one blink per second).	The Receiving Unit may not work correctly.	See "Malfunctions signalled by the Receiving Unit " in Part D of the Manual.
The red LED blinks twice per second at Radio Remote Control's start up.	At least one of the commands that were checked at start-up is enabled (see Technical Data Sheet).	Move the actuators related to the commands monitored during the start up to the rest position.
The red LED blinks three times per second at Radio Remote Control's start up.	The battery is flat.	Replace the battery with a charged one.
The red LED is steady on for two seconds at Radio Remote Control's start up.	The Transmitting Unit does not work correctly.	Contact the support service of the Machine Manufacturer.
The green LED and the red LED are steady on at Radio Remote Control's start up.	Wrong Key ID 0-1 or ID internal tx memory has been inserted in the Transmitting Unit.	Use the correct Key ID 0-1 or ID internal tx memory.
	You're using a BACK-UP UNIT with the Key ID 0-1 or ID internal tx memory of the Transmitting Unit that has been replaced.	Store the address in the BACK-UP UNIT (see paragraph 8.16).
The green LED and the red LED blink three times per second at Radio Remote Control's start up.	The Key ID 0-1 or ID internal tx memory is damaged.	Contact the support service of the Machine Manufacturer.
The green LED is steady on and the red LED blinks twice per second at Radio Remote Control's start up.	START is active.	Release START.
The green LED repeats the sequence three blinks and a pause, and the red LED is steady at Radio Remote Control's start up.	The UNPAIR procedure provided in the document "Menu of Transmitting Unit (MTU)" has been carried out.	Perform the ALIGNMENT procedure.
The green LED and the red LED are off at Radio Remote Control's start up	The GSS or the EMS pushbutton is pressed.	Unlock the GSS or the EMS pushbutton.
	The power keyswitch is not inserted.	Insert the power keyswitch.
	The battery is completely discharged or not inserted.	Insert a charged battery.

12 Decommissioning and disposal

Instructions for correct decommissioning and disposal of Radio Remote Controls are described in chapter "Decommissioning and disposal" in "Part A" of the Instruction Manual. Therefore, please refer to that part of the Manual.



Via Pomaroli, 65 - 36030 Caldogno (VI) - Italy
Tel. +39 0444 901000 - Fax +39 0444 901011
info@autecsafety.com - www.autecsafety.com

MADE IN ITALY