

Instruction Manual for the use and the maintenance of the Radio Remote Control

Original instructions

**Part A: Information, instructions and general
warnings**

DYNAMIC+P SERIES



WARNING

THIS PART OF THE MANUAL CONSISTS OF Part A - Information, instructions and general warnings for the Autec Dynamic+P Series Radio Remote Control. The Manual consists of Part A – General, Part B – Conformity and Frequencies, Part C – Transmitting Unit, Part D – Receiving Unit and Part E – Battery and Battery Charger, plus the Technical Data Sheet.

THIS MANUAL, INCLUDING ALL PARTS THEREOF, AND ALL INSTRUCTIONS CONTAINED HEREIN, MUST BE READ CAREFULLY AND UNDERSTOOD BEFORE INSTALLING, USING, MAINTAINING OR REPAIRING THE AUTEK RADIO REMOTE CONTROL.

FAILURE TO READ AND COMPLY WITH ALL APPLICABLE WARNINGS AND INSTRUCTIONS OR ANY ONE OF THE LIMITATIONS NOTED IN THIS MANUAL CAN RESULT IN SERIOUS BODILY INJURY OR DEATH, AND/OR PROPERTY DAMAGE.

THE AUTEK RADIO REMOTE CONTROL IS NOT A STANDALONE PRODUCT AND IS INTENDED ONLY AS A COMPONENT ON A MACHINE:

- **ON WHICH AND WHERE THE USE OF A RADIO REMOTE CONTROL IS APPROPRIATE,**
- **THAT CAN BE OPERATED SAFELY AND IN ACCORDANCE WITH ALL APPLICABLE LAWS, REGULATIONS AND STANDARDS BY SUCH REMOTE CONTROL.**

ACCORDINGLY, IT IS THE RESPONSIBILITY OF THE MACHINE MANUFACTURER ON WHICH THE AUTEK RADIO REMOTE CONTROL IS INTENDED TO BE INSTALLED, to perform an in-depth and accurate risk assessment to determine if the Autec Radio Remote Control is suitable for operating a Machine in conditions of safety and operational effectiveness, taking into account the conditions of use, the intended uses and the reasonably foreseeable incorrect ones, so that the installation, maintenance and use of the Autec Radio Remote Control, and all its components, are performed only and entirely in compliance with this Manual and in accordance with all local regulations, safety standards and regulations (referred to herein as "Laws, Regulations and Standards").

With reference to the USA market the Laws, Regulations and Standards include all safety rules and regulations of the Occupational Safety & Health Administration (OSHA) (<http://www.osha.gov>), all federal, state and local laws, regulations and building and electrical codes, and all applicable standards, including but not limited to ANSI Standards.

It is also the responsibility of the Manufacturer and of the design professionals of the Machine on which the Autec Radio Remote Control is to be installed and used to be certain that the structure, condition, organization and markings of the Machine as installed at the facility is appropriate for and will allow for the safe and reliable use and control of the Machine through the Autec Radio Remote Control interface.

IT IS THE RESPONSIBILITY OF THE OWNER AND FACILITY OPERATOR, AND THEIR DESIGN PROFESSIONALS, that the installation, maintenance and operation of the Autec Radio Remote Control and all of its components are done solely and completely in accordance with this Manual, and with all applicable Laws, Regulations and Standards, even local. It is also the responsibility of the Manufacturer of the Machine on which the Autec Radio Remote Control is to be installed and used, and their design professionals, to be certain that the structure, condition, organization and markings of the Machine as installed at the facility is appropriate for and will allow for the safe and reliable use and control of the Machine through the Autec Radio Remote Control interface.

ONLY QUALIFIED AND PROPERLY TRAINED PERSONNEL SHOULD BE PERMITTED TO OPERATE OR USE THE AUTEC RADIO REMOTE CONTROL AND THE MACHINE OPERATED BY OR THROUGH THE AUTEC RADIO REMOTE CONTROL. ONLY QUALIFIED AND PROPERLY TRAINED PERSONNEL SHOULD BE PERMITTED TO BE IN THE VICINITY OF MACHINE OPERATED BY OR THROUGH THE AUTEC RADIO REMOTE CONTROL.

FAILURE TO PROPERLY INSTALL, OPERATE, MAINTAIN AND SERVICE THE AUTEC RADIO REMOTE CONTROL CAN RESULT IN SERIOUS BODILY INJURY OR DEATH AND/OR PROPERTY DAMAGE. Refer to this Manual and each of its Parts for further assistance or contact Autec. Autec is not responsible for and shall not be held liable for any installation of the Autec Radio Remote Control not performed by Autec or for any use of the Autec Radio Remote Control not in complete compliance with, and/or not maintained in complete compliance with, all Autec instructions and warnings and all applicable Laws, Regulations and Standards, even local.

Autec is not responsible for and shall not be held liable for any alteration or modification of the Autec Radio Remote Control, or the use of non-Autec components or products used with or incorporated into the Autec Radio Remote Control.

IT IS THE RESPONSIBILITY OF THE OWNER AND FACILITY OPERATOR, AND THEIR DESIGN PROFESSIONALS, to be certain that the Autec Radio Remote Control is properly maintained and serviced at all times in compliance with all Autec instructions and warnings, and with all applicable Laws, Regulations and Standards, even local.

IT IS THE RESPONSIBILITY OF THE OWNER AND FACILITY OPERATOR, AND THEIR OFFICERS, MANAGERS AND SUPERVISORS, to be certain that all Users of the Autec Radio Remote Control and that all Persons who are or will be working with or near the Machine operated by or through the Autec Radio Remote Control are fully and properly educated and trained by qualified Personnel in the proper and safe use of the Autec Radio Remote Control and of the Machine, including without limitation complete familiarity with and understanding of Autec warnings and instructions, and all applicable Laws, Regulations and Standards, even local, and that such Users and other Persons do in fact at all times operate or work with the Autec Radio Remote Control safely and ONLY in compliance with Autec instructions and warnings and with all applicable Laws, Regulations and Standards, even local. FAILURE TO DO SO CAN RESULT IN SERIOUS BODILY INJURY OR DEATH AND/OR PROPERTY DAMAGE.

IT IS THE RESPONSIBILITY OF THE OWNER AND FACILITY OPERATOR, AND THEIR OFFICERS, MANAGERS AND SUPERVISORS, to be certain that the areas in which the Machine operated by or through the Autec Radio Remote Control is located and operates are clearly delineated and marked in accordance with all Autec warnings and instructions, and all applicable Laws, Regulations and Standards, even local, and otherwise sufficient to alert and warn ALL PERSONS that the Machine is operated by or through a Radio Remote Control, and prohibiting any unauthorized access thereto. FAILURE TO DO SO CAN RESULT IN SERIOUS BODILY INJURY OR DEATH AND/OR PROPERTY DAMAGE.

FAILURE TO OPERATE THE AUTEC RADIO REMOTE CONTROL SAFELY AND IN COMPLIANCE WITH AUTEC INSTRUCTIONS AND WARNINGS AND WITH APPLICABLE LAWS, REGULATIONS AND STANDARDS, EVEN LOCAL, AND/OR PERMITTING USERS OR OTHER PERSONS NOT PROPERLY TRAINED IN THE SAFE AND PROPER USE OF THE SYSTEM, OR THE MACHINE ON WHICH IT IS INSTALLED, CAN RESULT IN SERIOUS BODILY INJURY OR DEATH AND/OR PROPERTY DAMAGE.

INDEX

| | | |
|----------|---|-----------|
| 1 | Information on the use of instructions | 9 |
| 1.1 | Structure of the Instruction Manual | 9 |
| 1.2 | Caption and terminology | 11 |
| 1.3 | Symbols | 12 |
| 1.4 | To whom the instructions are addressed | 12 |
| 1.5 | Instruction storage | 13 |
| 1.6 | Intellectual property | 13 |
| 2 | Brief product presentation | 14 |
| 2.1 | Series, Radio Remote Control and Unit | 14 |
| 2.2 | Conformity with standards | 15 |
| 2.3 | Contacts and useful addresses | 15 |
| 2.4 | Warranty | 15 |
| 2.5 | Technical assistance and spare parts | 15 |
| 3 | General safety warnings | 16 |
| 4 | Radio Remote Control features | 20 |
| 4.1 | Description of radio link | 20 |
| 4.2 | Control devices | 22 |
| 4.3 | Radio Remote Control stop functions | 22 |
| 4.4 | Protection against unintended movements from the standstill position UMFS | 29 |
| 4.5 | Technical data | 31 |
| 4.6 | Identifying the Radio Remote Control | 31 |
| 4.7 | Additional features of the "Take & Release" Radio Remote Control | 32 |
| 5 | Radio Remote Control storage before installation or after removal | 33 |
| 6 | Installation | 33 |
| 6.1 | Applications | 33 |
| 6.2 | Staff training: installation and maintenance | 36 |
| 6.3 | Classification of commands | 36 |
| 6.4 | Warnings for installation | 37 |
| 7 | Safety | 45 |
| 7.1 | Risk assessment for radio remote controlled Machines | 45 |
| 7.2 | Delay in command response time | 46 |
| 7.3 | Inadvertent activation of commands | 46 |
| 7.4 | Activation and/or deactivation of commands due to failure | 47 |
| 7.5 | Latching functions | 47 |
| 8 | Instructions for the User | 48 |
| 8.1 | Staff training: use and working conditions | 48 |
| 8.2 | Warnings for the User | 49 |
| 8.3 | Operational use | 53 |
| 9 | Maintenance | 54 |
| 9.1 | Radio Remote Control maintenance - general directions | 54 |
| 9.2 | Routine maintenance | 55 |
| 9.3 | Special maintenance | 57 |
| 9.4 | Additional maintenance operations in environments with corrosive agents | 58 |
| 9.5 | Preventive replacement of the Radio Remote Control's electromechanical components | 59 |

| | |
|--|-----------|
| 10 Troubleshooting | 61 |
| 10.1 Radio Remote Controls with "Data Feedback" function | 61 |
| 10.2 Radio Remote Controls with cable control | 61 |
| 10.3 Solutions in case of malfunction | 61 |
| 11 Decommissioning and disposal | 62 |
| 11.1 Decommissioning | 62 |
| 11.2 Disposal | 62 |

1 Information on the use of instructions

1.1 Structure of the Instruction Manual

The Manual for the use and maintenance of Autec Radio Remote Controls consists of different parts, that altogether form the Manual; the Manual must be read carefully, understood and applied by the Radio Remote Control's Owner, User and by all those Persons that, for any reasons, may operate with the Radio Remote Control or with the Machine where it is installed. The following table describes the structure of the Instruction Manual for the use and the maintenance of the Radio Remote Control.

| Part | Title | Contents |
|------|-----------------------------|--|
| A | General part | <ul style="list-style-type: none"> - General information regarding the series, - directions for risk assessment of the "Machine+Radio Remote Control" system, - warnings for installation of the Radio Remote Control, - warnings for use and maintenance of the Radio Remote Control, - instructions for correct transportation and storage of Radio Remote Control. |
| B | Conformity and frequencies | <ul style="list-style-type: none"> - Operating frequency bands of the Radio Remote Control, - conformity and law references of the Radio Remote Control. |
| C | Transmitting Unit | Description and instructions concerning the Transmitting Unit, including: <ul style="list-style-type: none"> - description of operation, - commands, - light signals, - malfunctions, - additional instructions to the general part. |
| D | Receiving Unit | Description and instructions concerning the Receiving Unit, including: <ul style="list-style-type: none"> - description of operation, - light signals, - malfunctions, - additional instructions to the general part. |
| E | Battery and battery charger | Description, warnings and instructions concerning batteries and battery chargers, including: <ul style="list-style-type: none"> - description of operation, - light signals, - malfunctions, - instructions for the User. |

Usage and maintenance instructions are supplemented by the Radio Remote Control's Technical Data Sheet, that:

- Describes the Transmitting Unit's configuration
- Indicates the relation between commands sent by the Transmitting Unit and those available on the Receiving Unit.

INSTRUCTIONS FOR THE GENERAL PART: The instructions contained in this general part of the Instruction Manual refer to all Autec Dynamic+P series' Radio remote controls and to their single components and Units, and must be read and understood by their addressees before reading the instructions contained in the manuals of the single Units.

Usage and maintenance instruction as a whole are to be considered as an integral part both of the Autec Radio Remote Control and of the Machine, system, device or Machinery system where the Radio Remote Control is installed.

The Manufacturer of the Machine on which the Autec Radio Remote Control is installed, and the Owner and User of the Machine, must make sure that the Instruction Manual and all of its parts are included in the Instruction Manual of the Machine.

| | |
|---|--|
|  | <p>The CD attached to each Instruction Manual includes the translations of the Manual.</p> |
|---|--|

Act as follows to identify the single Manual parts in the relevant language in the CD:

- Choose the desired language
- Select the single parts of the Manual: refer to the code name provided on the cover of each part.

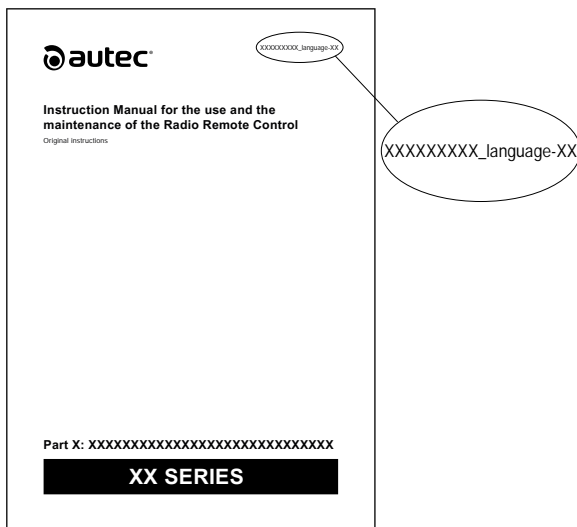

1.2 Caption and terminology



Contact Autec if any of the instructions, symbols, warnings or images are not clear and understandable, or if you have doubts or questions.



The terms listed here below have the stated meaning throughout the entire Manual, including all of its parts:

- **Unit:** the single (Transmitting or Receiving) Units that comprise the Autec Radio Remote Control.
- **Radio Remote Control:** Cableless Control System (CCS) made up of one or two Transmitting Units and one Receiving Unit that communicate with each other through a radio link.
- **Transmitting Unit:** portable component (remote station) through which the User interfaces with the Radio Remote Control.
- **Receiving Unit:** component fixed permanently on the Machine (base station); it constitutes an interface between the Radio Remote Control and the other Machine's parts.
- **Radio link:** (cableless control) uninterrupted communication between a Transmitting Unit and a Receiving Unit without physical connection.
- **Active stop:** stop generated by the transmission of a command from the Transmitting Unit to the Receiving Unit.
- **Automatic stop:** safety stop initiated without manual activation of a device by a User.
- **Manual stop:** stop initiated with the manual activation of a device by a User.
- **Passive stop:** safety stop originated by the absence of radio link between the Transmitting Unit and the Receiving Unit.
- **Machine:** the Machine, as defined in the Directive 2006/42/EC and in any other local regulations, and any other device, Machinery, equipment, Machinery system, application etc., where the Autec Radio Remote Control is installed, or that is controlled by it.
- **Manufacturer:** the Person who plans and/or manufactures a Machine, an appliance, a device or a Machinery system and decides to install a Radio Remote Control on it to control the Machine.
- **Installer:** the Person, qualified technician, who plans and/or performs the installation of an Autec Radio Remote Control on a Machine to act on its commands.
- **User:** the Person who actually uses an Autec Radio Remote Control to act on the commands of a Machine.
- **Maintenance Technician:** the Person, qualified technician, who carries out routine or special maintenance on an Autec Radio Remote Control, to keep it whole and effective.
- **Manual or Instruction Manual:** document consisting of: Part A – General, Part B – Conformity and Frequencies, Part C – Transmitting Unit, Part D – Receiving Unit and Part E – Battery and Battery Charger, plus the Technical Data Sheet.
- **Installation Manual:** the specific manual containing specific instructions for the installation of the Radio Remote Control on the Machine: the Installation Manual is specifically addressed to the Installer.
- **Person:** individual, natural or legal person and/or any entity, however it is considered
- **Owner:** the owner of the Radio Remote Control.

Functions indicated for the Manufacturer, the Installer, the User and the Maintenance Technician may be performed by a single Person, if he/she has the needed competence and undertakes the resulting responsibilities. Each Person must be aware of the instructions contained in the Manual, depending on the activity they carry out.

For example, if a Manufacturer is also the Installer, and/or Maintenance Technician, he must also know and follow the instructions specifically addressed to those Persons. The same applies, for example, if a User is also the Manufacturer and/or the Installer.

1.3 Symbols

| | |
|---|--|
|  | <p>This symbol identifies the parts of text in the Manual that must be read with special attention.</p> |
|  | <p>This symbol identifies the parts of text in the Manual containing warnings, information and/or instructions that are particularly relevant with regards to safety; failure in understanding them may cause hazards for People and/or property.</p> |

1.4 To whom the instructions are addressed

The Instruction Manual for the use and the maintenance of the Radio Remote Control is addressed to Manufacturers, design engineers, Installers, assemblers, mechanics, electricians, Users, operators, drivers, workers, people responsible for productive activities, Maintenance Technicians and to all the people who, in any capacity and for any reason, work with an Autec Radio Remote Control or with the Machine where it is installed.

The Manual must be read carefully, understood and applied in all its parts by:

- The Owner and/or Person responsible for the Machine and/or for the Autec Radio Remote Control and/or for their operation
- The Machine Manufacturer, who decides to equip it with a Radio Remote Control
- The Radio Remote Control Installer or the Person who assembles it on a Machine, device, Machinery system, etc., and/or who has the responsibility for that operation
- The Person responsible for safety in the workplace where the Radio Remote Control is used
- Users, that is to say, those who actually, and in any capacity, are qualified/authorised/appointed for the use of a Radio Remote Control, or who work with it
- Maintenance Technicians
- Those who, in any capacity, work with the Radio Remote Control and/or with the Machine, system, device and/or Machinery system where an Autec Radio Remote Control is installed, or that are controlled by an Autec Radio Remote Control.

| | |
|---|--|
|  | <p>The instructions concerning the installation and maintenance of the Radio Remote Control are addressed to qualified Personnel; their implementation requires qualified professional expertise: none of the operation for which qualified Personnel is required can be carried out by Persons or companies that do not have the required specific professional expertise.</p> |
|---|--|

1.5 Instruction storage

The Instruction Manual must be stored and made available to all its addressees, Users and technicians, for the whole life time of the Radio Remote Control, in any moment it may need to be consulted.

No part of the Manual shall be altered, modified or damaged.

If the Manual is damaged, a written request of replacement shall be sent to Autec; replacement is at the applicant's expense.

When applying for it, the Radio Remote Control's serial number is required.

1.6 Intellectual property

The Manual, its structure and contents, the images and photos, the drawings, the instructions and all intellectual property rights included in the Manual are and remain exclusive property of Autec Srl.

They cannot be reproduced and/or disseminated in any form or by any means (including the internet and photocopying) without authorisation and written consent by Autec.

2 Brief product presentation

2.1 Series, Radio Remote Control and Unit

The object of this part of the Manual is the Autec Dynamic+P series Radio Remote Control (see chapter 4).

Autec Dynamic+P series' Radio Remote Controls are designed to be used on Machines and provide a command interface to their command and control system, to be used from an appropriate distance and position.

Dynamic+P series' Radio Remote Controls may be made of one or two Transmitting Units and one Receiving Unit: the single Units, their commands and their features are illustrated in the specific parts in the Manual and in the Technical Data Sheet.

A Radio Remote Control is usually made of one Transmitting Unit and one Receiving Unit.

A "Take & Release" Radio Remote Control is made of two Transmitting Units and one Receiving Unit.

The Dynamic+P series consists of six Transmitting Units (PJB, PJC, PJM, PJN, PJQ and PJR) and one CRP Receiving Unit.

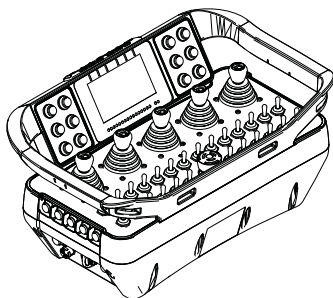

PJB

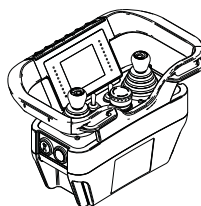

PJC

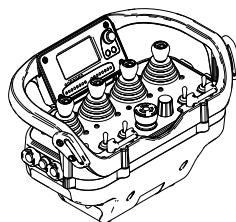

PJM

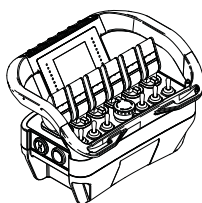

PJN

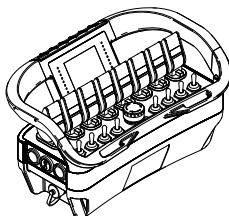

PJQ

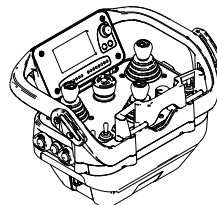

PJR

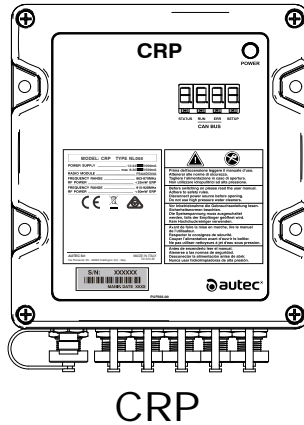

2.2 Conformity with standards

The conformity of Radio Remote Controls with standards and with working requirements and conditions in the single Countries is provided in the related specific part "Conformity and frequencies" (Part B) of the Manual.

2.3 Contacts and useful addresses

The Radio Remote Controls are produced by Autec Srl – Via Pomaroli, 65 - 36030 Caldogno (VI) - Italy.

You can find contacts for Autec, its distributors, dealers and authorized service centres on the website www.autecsafety.com.

2.4 Warranty

General warranty conditions are indicated both in the relevant sheet provided together with this documentation, and in the specific page on the website www.autecsafety.com.

2.5 Technical assistance and spare parts

If you need technical services and/or spare parts, please refer to contacts provided in the website www.autecsafety.com.

When applying for technical service to Autec, its distributors, dealers and authorized service centres, the Radio Remote Control's serial number is required; you can find it on the identification plate on the Transmitting Unit and/or on the Receiving Unit.

3 General safety warnings

| | |
|--|--|
|  WARNING | <p>All the warnings and instructions provided in this chapter are safety-relevant.</p> <p>Failure to follow the instructions contained in the Manual provided by Autec, as well as all applicable safety-related legislations, even local ones, regulations and standards may generate serious damage to people and property.</p> <p>The Machine Manufacturer and/or designer, the Installer, the Maintenance Technician and the people responsible for the use of the Machine and for the working place are responsible to ensure that the installation, maintenance and use of the Autec Radio Remote Control and all its components are carried out in complete accordance with the instructions provided by Autec and in compliance with all the applicable safety-related standards and regulations in force in the countries where the Machine and the Radio Remote Control are used.</p> <p>The Machine Manufacturer takes on the responsibility for the installation and use of the Radio Remote Control on any application.</p> |
|--|--|

The Manufacturer or those who want to use or install an Autec Radio Remote Control on a Machine must first:

- Assess whether the Machine where they want to install the Radio Remote Control can be used with a Radio Remote Control safely and effectively.
- Carry out an in-depth, accurate risk assessment, taking into account the Machine's manufacturing, functional and/or performance features and characteristics, purpose of the Machine, the location and environment in which the Machine is to be used, the facility in which the Machine is to be or is installed, the interaction between the Machine and other equipment and Personnel, the safety conditions during operation of the Machine, the actual and potential different usage conditions, the conditions that may arise following the installation and use of a Radio Remote Control, and the features and limitations of the Autec Radio Remote Control.

For this purpose, by way of example and by no way of limitation, refer to standards ISO 12100 and ISO 14121, that prescribe the conditions for a correct risk assessment, which includes risk analysis and the adoption of the necessary protection and safeguarding actions.

Without limitation on the Laws, Regulations and Standards it is forbidden to use an Autec Radio Remote Control if the Manufacturer or those who want to install it on the Machine are not able to or do not:

- Carry out an appropriate and comprehensive risk assessment in relation to the safety of the Machine, concerning the Radio Remote Control adoption and installation.
- Ensure the required professional experience and/or technical competence to carry out the risk assessment correctly.
- Ensure the correct installation of the Radio Remote Control in accordance with this Manual and all applicable Laws, Regulations and Standards, even local.
- Implement all safety conditions, so that the radio remote controlled Machine can be used without creating dangerous situations.
- Adopt the appropriate technical solutions and informative actions to create the conditions for the User and the Maintenance Technician to safely operate the radio remote controlled Machine.
- Implement all necessary and appropriate action and procedures to remove or reduce risks that may originate from the use of the radio remote controlled Machine.

ONLY IF THE COMPREHENSIVE RISK ASSESSMENT SUPPORTS THE INSTALLATION OF THE AUTEC RADIO REMOTE CONTROL AS APPROPRIATE, EFFECTIVE AND SAFE FOR THE OPERATION OF THE MACHINE AND THE USE OF THE RADIO REMOTE CONTROL ON THE MACHINE IS PERMITTED BY AND IS IN COMPLIANCE WITH APPLICABLE LAWS, REGULATIONS AND STANDARDS, EVEN LOCAL, AND THIS MANUAL, MAY THE AUTEC RADIO REMOTE CONTROL SYSTEM BE INSTALLED AND USED ON SUCH MACHINE.

THE MACHINE MANUFACTURER OR ALL THOSE WHO DECIDE TO INSTALL THE AUTEC RADIO REMOTE CONTROL ON A MACHINE IS HELD COMPLETELY RESPONSIBLE FOR:

- **THE RISK ASSESSMENT**
- **THE DETERMINATION TO USE THE AUTEC RADIO REMOTE CONTROL ON THE MACHINE**
- **TAKING ALL ACTIONS NECESSARY OR ADVISABLE TO REDUCE OR REMOVE RISKS OCCASIONED BY THE MACHINE AND, WITHOUT LIMITATION, THE USE OF A RADIO REMOTE CONTROL TO OPERATE THE MACHINE**
- **THE OBSERVANCE OF STANDARDS AND REGULATIONS AIMING AT PRESERVING SAFETY.**



THE AUTEC RADIO REMOTE CONTROL IS NOT A STANDALONE PRODUCT AND IS INTENDED ONLY AS A COMPONENT ON A MACHINE:

- **ON WHICH AND WHERE THE USE OF A RADIO REMOTE CONTROL IS APPROPRIATE**
- **THAT CAN BE OPERATED SAFELY AND IN ACCORDANCE WITH ALL APPLICABLE LAWS, REGULATIONS AND STANDARDS BY SUCH REMOTE CONTROL.**

AUTEC IS NOT RESPONSIBLE FOR AND SHALL NOT BE HELD LIABLE FOR THE COMPATIBILITY OF THE RADIO REMOTE CONTROL WITH THE MACHINE OR DESIRED APPLICATION, EVEN IF IT IS AMONG THE PERMITTED APPLICATIONS, OR FOR ANY ISSUE RELATING TO THE SUITABILITY OF THE MACHINE AND ITS CONTROL SYSTEM TO BE RADIO REMOTE CONTROLLED.

SIMILARLY, AUTEC IS NOT RESPONSIBLE FOR AND SHALL NOT BE HELD LIABLE FOR THE RISK ASSESSMENT THAT MUST BE CARRIED OUT WHEN CONSIDERING A RADIO REMOTE CONTROL GENERALLY OR THIS AUTEC RADIO REMOTE CONTROL SPECIFICALLY, OR THE SUITABILITY OF OPERATING A MACHINE BY A RADIO REMOTE CONTROL GENERALLY OR THIS AUTEC RADIO REMOTE CONTROL SPECIFICALLY, WHETHER WITH REGARD TO THE MACHINE, THE FACILITY IN WHICH THE MACHINE IS TO BE USED OR IS USED, OR THE ENVIRONMENTAL AND/OR WORKING CONDITIONS IN WHICH THE MACHINE WILL BE OR IS USED.



Without limitation on the foregoing, Autec is not responsible for and shall not be held liable for:

- Installation that is faulty or in any way not in conformity with this Manual and any other instructions provided by Autec, and with all applicable Laws, Regulations and Standards, even local
- Installation on Machines, appliances, devices, equipment and/or Machinery systems on which the use of a Radio Remote Control is not allowed by its Manufacturer or under applicable Laws, Regulations and Standards, even local, or on which the installation and/or the use of a Radio Remote Control may generate safety issues or other risk situations that cannot be adequately removed and/or reduced, in conformity with applicable Laws, Regulations and Standards, even local
- Use of the Autec Radio Remote Control system that is in any way not in conformity with this Manual and any other instructions provided by Autec, and with all applicable Laws, Regulations and Standards, even local

- Use of the Radio Remote Control in facilities or environments, or in weather and/or climate conditions, in which the use of the Radio Remote Control is not permitted or advisable under applicable Laws, Regulations and Standards, even local, not permitted according to the instructions contained in this Manual, or that may pose the risk of damage and/or incorrect operation of the Radio Remote Control (by way of example: temperature exceeding the limits indicated in paragraph 8.3, situations where the risk of explosion exists, risk of contact with liquids or fluids);
- Use of the Radio Remote Control in working conditions that do not allow the User to maintain full and continuous observation of the movements of the Machine and, if applicable, of the load
- Use of the Radio Remote Control in a different way or for different purposes from the permitted ones, and/or use not in complete compliance with the instructions for use and the maintenance contained in this Manual
- Inadequate or missing maintenance of the Radio Remote Control, referring to both routine and special maintenance, or failure to repair any damage to, wearing out or malfunction of the Autec Radio Remote Control
- Damage to and/or deterioration of any component or feature of the Autec Radio Remote Control
- Failure to take the Autec Radio Remote Control out of service if there is any damage to or malfunction of the Radio Remote Control or any component thereof
- Use of parts or components in the Autec Radio Remote Control that are not manufactured or supplied by Autec
- Service of the Autec Radio Remote Control system by anyone other than Autec or an Autec authorized service provider.

4 Radio Remote Control features

Dynamic+P series' Radio Remote Controls are used to control Machines from a distance, without physical connection (by way of example: wires or connecting cables) between the Transmitting Unit handled by the User and the Receiving Unit installed on the Machine, hence between the User and the Machine.

They usually consist of a portable Transmitting Unit, from which the User can remotely control a Machine, and a Receiving Unit installed on board the Machine itself.

Images of the single Units belonging to the Radio Remote Control can be found in the specific manual that refers to each Unit.



The relation between the commands sent by the Transmitting Unit and those available in the Receiving Unit is decided by the Installer of the Radio Remote Control on the Machine.

4.1 Description of radio link

The Transmitting Unit communicates with the Receiving Unit through a radio link. Such link must be continuous to promote safety in the use of the Machine. Every time this link is incorrect or interrupted, the Receiving Unit stops the commands and orders the Machine to stop.



The Machine stops only if the wiring between the Receiving Unit and the Machine itself is correct.

The Units in a Radio Remote Control code their messages through an address that is unique (produced by Autec only once and non repeatable for other Radio Remote Controls) and univocal (specific for each Radio Remote Control and associated to it).

Each Unit can only decode messages coming from the Unit with the same address.

This prevents messages from other radio equipment from activating any "Machine+Radio Remote Control" system function.

The radio link is interrupted in the following cases:

- Stop (see paragraph 4.3)
- Low battery
- Automatic switch off
- No power supply in the Receiving Unit
- Working range exceeded (see paragraph 4.5)
- Presence of metal obstructions.

| | |
|---|--|
|  | <p>WARNING: The operating working range may be significantly and unpredictably reduced compared to the value indicated in the technical data (see paragraph 4.5) when special conditions occur in the working environment (by way of example: temporary presence of electromagnetic interference and/or metal obstructions).</p> <p>WARNING: The operating working range may be extended up to ten times compared to the value indicated in the technical data (see paragraph 4.5) when there are no interference elements in the working environment (by way of example: no electromagnetic interference and/or metal obstacles).</p> |
|---|--|

When a radio link is interrupted:

- All outputs of the Receiving Unit are disabled
- It is not possible to enable or disable the Machine commands through the Transmitting Unit until the Radio Remote Control is started up again.

| | |
|---|---|
|  | <p>When the START pushbutton is pressed to re-start the Radio Remote Control, the commands that are not monitored during start up (see Technical Data Sheet), if active, immediately activate the Machine functions that are associated with them.</p> <p>The Machine's Manufacturer or those who integrate the Radio Remote Control in the Machine must take this Radio Remote Control behaviour into account when carrying out the risk assessment. The Machine Manufacturer or those who integrate the Radio Remote Control on the Machine must inform the User if they believe that the reactivation of such Machine functions may entail hazardous situations that cannot be reduced by reasonable technical measures implemented on the Machine itself.</p> |
|---|---|

4.2 Control devices

4.2.1 Start up and switch off

Start up and switch off functions are described in chapter "General instructions for operation" included in "Part C" of the Instruction Manual. Therefore, please refer to that part of the Manual.

4.3 Radio Remote Control stop functions

The Radio Remote Control has two stop functions that bring the Machine to a safe state every time it is necessary to stop it due to a potentially hazardous situation:

- Automatic stop function (ATS): this function is activated automatically (see chapter 4.3.3).
- Manual stop function: this stop function may be a General Safe Stop (GSS, see paragraph 4.3.1) or an EMergency Stop (EMS, see paragraph 4.3.2).



The automatic stop function (ATS) and the manual stop function are both safety functions (see paragraph 4.5).



The GSS function and the EMS function are never present simultaneously in a Radio Remote Control. The Machine Manufacturer and/or the Installer have the responsibility to decide which one is the correct/suitable one for the radio remote controlled Machine in accordance with the requirements for such function.

THE USER MUST AT ALL TIMES PAY FULL ATTENTION TO THE SAFE AND PROPER OPERATION OF THE MACHINE IN ACCORDANCE WITH THE INSTRUCTIONS AND WARNINGS PROVIDED IN THIS MANUAL AND WITH THE MANUAL, INSTRUCTIONS AND WARNINGS FOR THE MACHINE AND WITH ALL APPLICABLE LAWS, REGULATIONS AND STANDARDS, EVEN LOCAL.

ACTIVATING THE PUSHBUTTON RELATED TO THE STOP FUNCTION (GSS or EMS) MAY NOT RESULT IN AN IMMEDIATE STOP OF THE MACHINE.

| | |
|--|--|
|  WARNING | <p>THE ACTIVATION OF THE PUSHBUTTON RELATED TO THE STOP FUNCTION (GSS OR EMS) CONTROLS THE MACHINE'S STOP FUNCTION, BUT THE TIME AND DISTANCE WITHIN WHICH THE LATTER WILL BE BROUGHT TO A SAFE STATE MAY VARY FROM MACHINE TO MACHINE, FOR EXAMPLE DUE TO THE PRESENCE OR ABSENCE OF A BRAKE. THE USER MUST BE FULLY AWARE OF THE MACHINE'S MOVEMENTS AND OPERATING ZONES AND MUST ALLOW FOR SUFFICIENT SAFE FUNCTIONING OF THE MACHINE, INCLUDING SUCH RESPONSE TIMES AND STOPPING DISTANCES.</p> <p>FAILURE TO DO SO CONTINUOUSLY AND CORRECTLY MAY RESULT IN SEVERE INJURY OR DEATH, OR PROPERTY DAMAGE.</p> |
|  | <p>Depending on the Machine's risk assessment, it may be necessary to arrange, on the Machine or nearby, an additional restore device to be used after the GSS or the EMS function has been activated by the Transmitting Unit. This device must be placed in a fixed position in such a way as to enable the User to perfectly see the whole Machine's working area.</p> |

4.3.1 General Safe Stop function (GSS)

The User activates the GSS function by using the pushbutton identified with GSS or General Safe Stop in the Transmitting Unit.

This manual stop first generates an active stop and then it switches off the Transmitting Unit. This working logic implicates that the Receiving Unit brings the Machine to a safe state when it receives the command generated by the active stop. If this does not happen due to interference causing incorrect or broken radio link, the passive stop will activate the automatic stop function in the Receiving Unit.

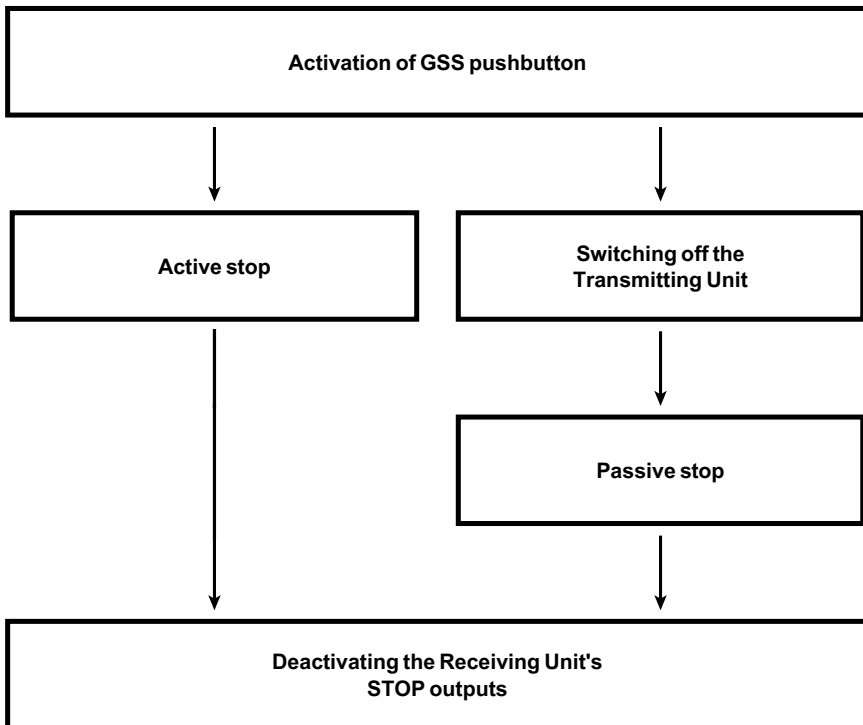

| | |
|---|--|
|  | <p>The GSS function is available if and only if the Radio Remote Control is started (see paragraph "Radio Remote Control start up" in "Part C" of the Manual).</p> <p>In "Take & Release" Radio Remote Controls, the GSS function is available only on the Transmitting Unit that controls the machine when the Radio Remote Control is started (see "Radio Remote Control start up" in "Part C" of the Manual).</p> |
|---|--|

| | |
|--|---|
|  WARNING | <p>Never leave the Transmitting Unit unguarded to avoid uncertainty about the availability or unavailability of the GSS function.</p> <p>The “mission time” of the GSS function, as defined in international standards and requirements, is 20 years. In any case, the Radio Remote Control must be replaced within this period. The “mission time” must not be considered as a warranty period.</p> <p>After the activation of the GSS or General Safe Stop pushbutton on the Transmitting Unit, the Machine is not controlled by the Radio Remote Control any more. Any possible risks that may arise from the activation of the stop function must be taken into account by the Installer of the Radio Remote Control, and by the Manufacturer and the Owner of the Machine where the Radio Remote Control is installed. The Radio Remote Control User must be properly trained about this.</p> |
|--|---|

4.3.2 EMergency Stop (EMS) function

| | |
|---|---|
|  | The EMS function is never available in "Take&Release" Radio Remote Controls. |
|---|---|

The User activates EMS function by using the red pushbutton on a yellow background identified with EMS in the Transmitting Unit.

This manual stop first generates an active stop and then it switches off the Transmitting Unit. This working logic implicates that the Receiving Unit brings the Machine to a safe state when it receives the command generated by the active stop. If this does not happen due to interference causing incorrect or broken radio link, the passive stop will activate the automatic stop function in the Receiving Unit.

The red pushbutton in use complies with the IEC 60204-1 and with the IEC 60947-5-5.

The EMS function complies with the ISO 13850.

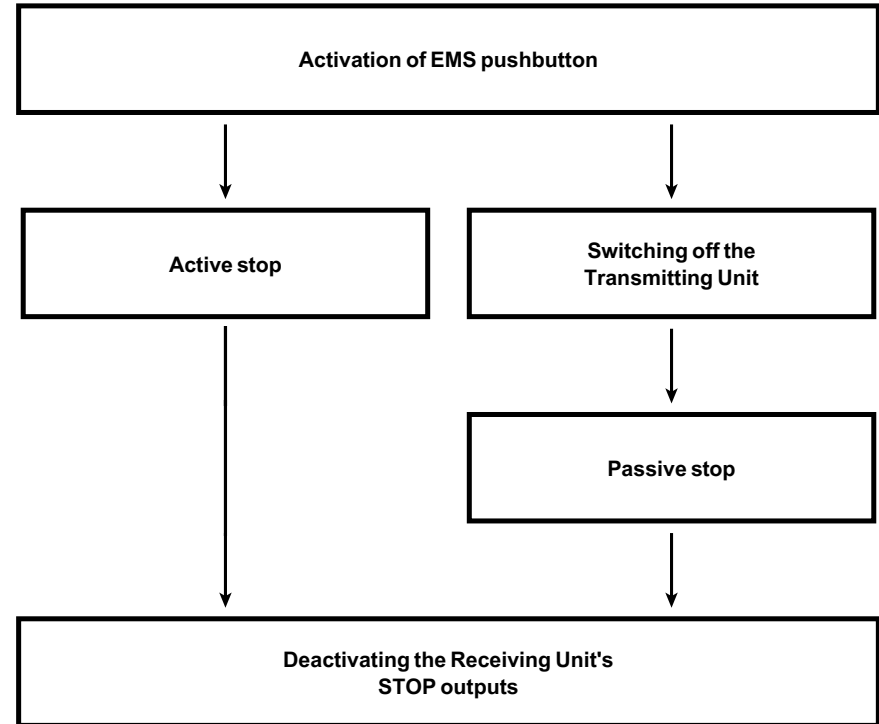

| | |
|---|---|
|  | The EMS function is available if and only if the Radio Remote Control is started (see paragraph "Radio Remote Control start up" in "Part C" of the Manual). |
|---|---|

The Radio Remote Control's stop function can be considered EMS only if:

- It belongs to a Machine's emergency stop function compliant with the requirements of the Machinery Directive 2006/42/EC and of the ISO 13850 standard
- It belongs to a Machine's emergency stop function that is always available and operational, independently from the Machine's working mode
- The Transmitting Unit is the only control station of the Machine. If, on the other hand, there is another non-remote control station, the EMS function present in the Radio Remote Control must always be made available and operational.

The red pushbutton on the Transmitting Unit must not be the only means to initiate the emergency stop function in the radio remote controlled Machine.



Never leave the Transmitting Unit unguarded to avoid uncertainty about the availability or unavailability of the EMS function.

The "mission time" of the EMS function, as defined in international standards and requirements, is 20 years. In any case, the Radio Remote Control must be replaced within this period. The "mission time" must not be considered as a warranty period.

After the activation of the red pushbutton on the Transmitting Unit, the Machine is not controlled by the Radio Remote Control any more. Any possible risks that may arise from the activation of the stop function must be taken into account by the Installer of the Radio Remote Control, and by the Manufacturer and the Owner of the Machine where the Radio Remote Control is installed. The Radio Remote Control User must be properly trained about this.

4.3.3 Automatic stop function (ATS)

The automatic stop function (ATS) prevents hazardous operation of the radio remote controlled Machine and brings it to a safe state. This function is activated automatically:

- By the Receiving Unit due to passive stop, when the Receiving Unit does not receive correct messages in a given time span (see paragraph 4.1).
- When a Radio Remote Control malfunction is detected.

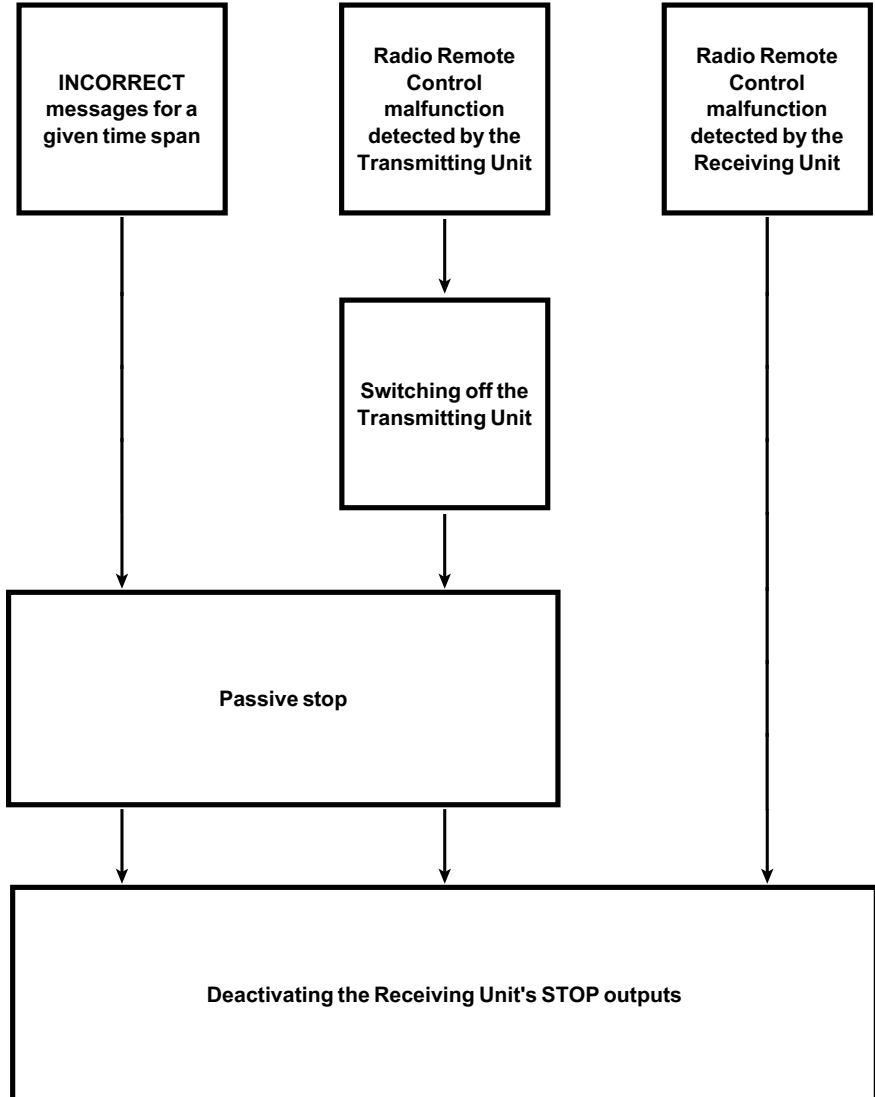



4.4 Protection against unintended movements from the standstill position UMFS

| | |
|---|---|
|  | <p>Unintended movements of the Machine, that is Machine movements that are not activated by movements of the actuators, may occur due to electrical or mechanical failure or malfunction that may affect the Radio Remote Control.</p> |
|---|---|

The rest position of the actuators on the Transmitting Unit is the neutral position. When all the actuators related to commands protected by the UMFS function (such commands are indicated in the Technical Data Sheet as COMMAND+SAFETY) are in the neutral position, the Radio Remote Control keeps the Receiving Unit's SAFETY outputs deactivate, regardless of the status of all the outputs related to the commands.

When all the actuators of commands protected by the UMFS function are in their neutral position, the UMFS function reduces the risk of accidentally activating Machine's movements in case of electrical failure in the Radio Remote Control.

| | |
|---|---|
|  | <p>During the Radio Remote Control start up, if all actuators related to commands protected by the UMFS function are in their neutral position, possible movement commands due to electrical failure do not activate the SAFETY outputs.</p> <p>If all actuators related to the commands protected by UMFS function are released, SAFETY outputs are deactivated after about 1 second (for the ADD Receiving Unit only, such delay cannot occur: see "SAFETY delay time" in the Installation Manual).</p> <p>The UMFS function prevents the Radio Remote Control from starting if an electrical failure of movement commands is detected.</p> |
|---|---|

| | |
|---|--|
|  | <p>THE UMFS FUNCTION WORKS CORRECTLY IF AND ONLY IF "SAFETY" OUTPUTS ARE CONNECTED CORRECTLY (SEE INSTALLATION MANUAL).</p> |
|---|--|



MOVEMENT OF THE MACHINE MAY OCCUR WHENEVER AN ACTUATOR RELATED TO MOVEMENT COMMANDS IN THE TRANSMITTING UNIT IS MOVED FROM ITS NEUTRAL POSITION. EVEN INADVERTENT ACTIVATION OF COMMANDS MAY CAUSE MACHINE MOVEMENTS (SEE PARAGRAPH 7.3). EVEN THOUGH THIS RADIO REMOTE CONTROL IS EQUIPPED WITH ALL THE REASONABLE MEASURES TO PREVENT ACCIDENTAL ACTIVATION, IT CANNOT DETECT IF THE ACTUATOR HAS BEEN MOVED INTENTIONALLY OR ACCIDENTALLY.

THE UMFS FUNCTION MUST NOT BE INTENDED AS A PROTECTION AGAINST ACCIDENTAL ACTIVATION OF ACTUATORS, BUT IT HAS BEEN DESIGNED TO PREVENT UNINTENDED ACTIVATION OF MOVEMENTS IN CASE OF ELECTRICAL FAILURE OF COMMANDS PROTECTED BY THE UMFS FUNCTION.

THE UMFS FUNCTION IS NOT A SUBSTITUTE WHATSOEVER FOR THE PROPER USE AND PROTECTION OF THE TRANSMITTING UNIT IN ACCORDANCE WITH THE INSTRUCTIONS CONTAINED IN THIS MANUAL (INCLUDING ALL OF ITS PARTS); THE USER MUST AT ALL TIMES PAY FULL ATTENTION TO THE SAFE AND PROPER OPERATION OF THE MACHINE IN ACCORDANCE WITH THE INSTRUCTIONS AND WARNINGS PROVIDED IN THIS MANUAL AND IN THE MANUAL FOR THE MACHINE AND WITH ALL APPLICABLE LAWS AND STANDARDS, EVEN LOCAL.

4.5 Technical data

| | |
|--|--------------------------------------|
| Performance of the automatic stop function (ATS) | SIL 3 / PL e ; cat.4 (4-wire wiring) |
| | SIL 2 / PL d ; cat.3 (2-wire wiring) |
| Performance of the General Safe Stop (GSS) function | SIL 3 / PL e ; cat.4 (4-wire wiring) |
| | SIL 2 / PL d ; cat.3 (2-wire wiring) |
| Performance of the Emergency Stop (EMS) function | SIL 3 / PL e ; cat.4 (4-wire wiring) |
| | SIL 2 / PL d ; cat.3 (2-wire wiring) |
| Performance of the UMFS function | SIL 2 / PL d ; cat.3 |
| Cut in time of the automatic stop function (ATS) | 0.5s |
| Cut in time of the manual active stop function (GSS or EMS) | <160ms |
| Cut in time of the manual passive stop function (GSS or EMS) | 0.5s |
| Hamming distance | ≥15 |
| Probability of undetected error | <10 ⁻¹⁵ |
| (Typical) working range | 100m (330ft) |
| Command response time | 80-130ms |

The technical data related to the single Units belonging to the Dynamic+P series are provided in the specific parts of the Manual and in their Technical Data Sheets.

4.6 Identifying the Radio Remote Control

A serial number (S/N) univocally identifies each Radio Remote Control.

The serial number is provided in the identification plate on each Radio Remote Control Unit. This is the only reference to be used for maintenance operations and for any other situation when you need to precisely identify the Radio Remote Control.

The serial number must be mentioned in any communication with Autec, its dealers, Installers, Maintenance Technicians of the Radio Remote Control and with the people who, in any capacity, need information, spare parts or technical data concerning the Radio Remote Control.

| | |
|---|---|
|  | <p>Plates must not be removed from their position: removal immediately voids the warranty.</p> <p>Plates must not be altered or damaged, contact Autec for replacement.</p> |
|---|---|

| | |
|---|--|
|  WARNING | <p>The Machine Manufacturer, the Installer, the Maintenance Technician and the People in charge for the usage of the Machine and of the working place are responsible for making sure that the Radio Remote Control's identification plate is a sufficient means to explain the correspondence between the Transmitting Unit and the Receiving Unit. If that were the case, it is necessary to provide additional, more visible identification.</p> |
|---|--|

4.7 Additional features of the "Take & Release" Radio Remote Control

It consists of two Transmitting Units, from which two Users can remotely control a single Machine, and of a Receiving Unit installed on board the Machine itself. The Receiving Unit can be controlled by a single Transmitting Unit independently (of other Transmitting Unit) and exclusively (the Receiving Unit cannot be controlled by both Transmitting Units at the same time), so as to avoid command overlap.

The Transmitting Units belonging to a "Take & Release" Radio Remote Control are named "TU No.1" and "TU No.2".

The names of the Transmitting Units belonging to the "Take & Release" Radio Remote Control are provided in the Technical Data Sheet and on the panel of each Transmitting Unit.

4.7.1 Description of radio link

The Receiving Unit can decode only the messages coming from the Transmitting Units of the "Take & Release" Radio Remote Control to which it belongs.

Each Transmitting Unit can decode only the messages coming from the Receiving Unit of the "Take & Release" Radio Remote Control to which it belongs.

4.7.2 Receiving Unit statuses

The Receiving Unit of a "Take & Release" Radio Remote Control can have two different statuses:

- Free: the Receiving Unit is not controlled by any Transmitting Unit.
- Engaged: the Receiving Unit is controlled by one of the Transmitting Units and cannot be controlled by the other Unit until it is released.

The Receiving Unit switches from the engaged to the free status in the following cases:

- if it is disconnected from its power source for at least one second,
- if it is released by the Transmitting Unit that was controlling it.

Only when the Receiving Unit is free, it can be engaged by the first Transmitting Unit that performs such operation by acting on the TAKE command, or by performing the start up procedure (see "Part C" in the Instruction Manual).

| | |
|---|---|
|  | <p>When a Transmitting Unit is switched off without releasing the Receiving Unit beforehand (see "Part C" in the Instruction Manual), the latter remains in "engaged" status.</p> |
|---|---|

5 Radio Remote Control storage before installation or after removal

Radio Remote Controls must always be transported and stored inside their packing until they are installed on the Machine.

The Radio Remote Control system and all components are to be shipped and maintained according to the following environmental parameters and conditions:

| | Temperature | Relative Humidity | Air pressure |
|----------------|---|--------------------------|---------------------|
| Transportation | from -40 to +70°C (from -40 to +158°F) | 95% | from 70 to 106kPa |
| Storage | from -40 to +85°C (from -40 to +185°F) | from 5 to 95% | from 70 to 106kPa |

In the previous table:

- Temperature, relative humidity and air pressure during transportation refer to Class 2K4 of standard EN 50178.
- Temperature and air pressure during storage refer to Class 1K5 of standard EN 50178.
- Relative humidity during storage refers to Class 1K3 of standard EN 50178.

6 Installation

The chapter "Installing the Receiving Unit" in "Part D" of the Instruction Manual contains the warnings for the installation that add to those provided in this chapter. Therefore, please refer to that part of the Manual.

6.1 Applications

An Autec Dynamic+P series Radio Remote Control can be used for several applications: the Manufacturer must establish if the Radio Remote Control is suitable for each different application, especially with regards to safety. The Dynamic+P series is used most frequently for the following types of Machines:

- Machines for lifting and moving materials, objects, general loads (by way of example: hydraulic cranes, concrete pumps)
- Machines for raising and moving people (by way of example: elevated work platforms, telehandlers)
- Drilling Machines.



Make sure that the application's requirements are compatible with the value "(Typical) Working range" (see paragraph 4.5).

Be aware that such value may vary (see paragraph 4.1).

| | |
|--|--|
|  WARNING | <p>The Autec Radio Remote Control may not be installed on Machines where it is used for applications or functions not permitted under this Manual and applicable Laws, Regulations and Standards, even local. INSTALLATION OF AN AUTEK RADIO REMOTE CONTROL ON OTHER MACHINE OR FOR OTHER FUNCTIONS MAY CAUSE SERIOUS INJURY OR DEATH OR PROPERTY DAMAGE.</p> <p>Autec is not and cannot be held responsible if the Radio Remote Control is used in unsafe or poor safety conditions. Assessment shall be made by the Machine Manufacturer to establish possible additional protection measures for the actuators (by way of example: commands requiring two-hand operation, “dead-man” function) if particular environments, equipment and working modes could cause accidental bumps to the actuators.</p> <p>“Take & Release” Radio Remote Controls are not suitable to be used in Machines requiring simultaneous consent from different Transmitting Units to start the Machine itself or to perform operations.</p> |
|--|--|



In addition to the above, Dynamic+P series' Radio Remote Controls cannot be installed:

- On Machines that are intended for the use in environments requiring explosion-proof features or in any Radio Remote Control usage situation that may pose the risk of explosion
- On machines where the receiving unit power supply does not come from a battery or from a power supply unit with safety isolating transformer
- On Machines that control loads that are not isolated from alternating current (AC) power supply (if applicable)
- On Machines that create or can create dangerous situations if they stop due to the loss of radio link
- On Machines that do not allow a risk-free installation of a Radio Remote Control, due to their functions or features and/or to the risks related to their use
- On any kind of lifting accessory (by way of example: magnets, grippers, suction cups) whenever the loss of radio link or the deactivation of commands may cause the release of the load, resulting in the risk of damage to People and/or property. The Machine Manufacturer may allow the installation and use of the Radio Remote Control for such applications under their own responsibility
- If the applicable safety-related laws in the country where the Machine is used, regulations and standards (even local ones), even concerning safety in the workplace, do not allow the use of Radio Remote Controls to control the Machines.

INSTALLATION OF AN AUTEC RADIO REMOTE CONTROL ON MACHINES AND IN THE ABOVE-MENTIONED SITUATIONS MAY CAUSE SERIOUS INJURY OR DEATH OR PROPERTY DAMAGE.

6.2 Staff training: installation and maintenance

All installation and maintenance operations relating to the Autec Radio Remote Control system must be carried out ONLY by qualified technicians. Without limitation on the foregoing, such technicians must be trained and qualified with respect to:

- The activity to perform
- Warnings resulting from the risk assessment, concerning the Radio Remote Control installation and/or maintenance
- All applicable Laws, Regulations and Standards, even local, including also safety rules
- Operations and requirements of the Machine on which the Radio Remote Control is to be installed
- Instructions and warnings provided in the Manual and any other documents related to the Radio Remote Control and to the radio remote controlled Machine
- Directions by the Machine Manufacturer and by the Person in charge for safety in the workplace where the system "Machine + Radio Remote Control" is used.

General instructions for installation and maintenance are provided in chapter 6 and in chapter 9 respectively.

Instructions for the different Units are described in the specific Manual's parts related to the Units.

Therefore, please refer to that parts of the Instruction Manual.

6.3 Classification of commands

This paragraph describes the classification of commands in the Radio Remote Control: such information is useful during installation and maintenance.

6.3.1 Command type: analogue, digital or direction command

Commands sent by the Transmitting Unit can either be analogue, digital or direction commands. Analogue commands generate proportional outputs as a function of the position of the corresponding actuator.

Digital commands switch the status of their corresponding output, according to the position of the related actuator. This status can either be on or off.

Direction commands are digital commands paired with analogue commands, and are used to enable the movement in a specific direction.

6.3.2 Name of commands

All commands activated by the Transmitting Unit are identified with abbreviations such D1, D2, H1, L1, etc.

Those abbreviations are provided in the Technical Data Sheet that must be used when installing the system, and in particular:

- In the drawing of the Transmitting Unit, where commands and their layout are indicated
- In the wiring diagram of the Receiving Unit.

This is helpful to highlight the relation between the commands sent by the Transmitting Unit and those available on the Receiving Unit.

6.4 Warnings for installation

The Installer of the Radio Remote Control must always read, understand and follow all the instructions and warnings contained in this Manual. These instructions and warnings are not exhaustive. In addition, for a correct installation, the Installer must abide and comply with all Laws, Regulations and Standards, even local, including all the technical specifications and standards applicable to the Autec Radio Remote Control to which this Manual applies (by way of example: IEC 60204-1, IEC 60204-32). The Installer of the Radio Remote Control must also observe all the instructions, provisions and technical directions provided by the Machine Manufacturer.



Instructions and warnings provided in this chapter 6 are general. Specific instructions for the installation of the Radio Remote Control are provided in the Installation Manual: please refer to it for this information. The Installer must use and comply with that Installation Manual to complete the tasks for which he is appointed.

6.4.1 General warnings for installation



Always follow the instructions provided in the Technical Data Sheet and respect values given in the technical data to carry out correct installation.

The electrical connection of the Receiving Unit must meet the requirements set by clause 9.1 of standard IEC 60204-1 and/or standard IEC 60204-32.

ONLY QUALIFIED PERSONNEL MAY INSTALL THE RADIO REMOTE CONTROL. SUCH PERSONNEL MUST HAVE MASTERED THE TECHNICAL KNOWLEDGE REQUIRED TO CARRY OUT THESE PROCEDURES CORRECTLY AND SAFELY AND BE QUALIFIED ACCORDING TO THE APPLICABLE LAWS AND REGULATIONS AND HAVE ALL NECESSARY CERTIFICATIONS.

FAILURE TO INSTALL THE AUTEK RADIO REMOTE CONTROL CORRECTLY MAY RESULT IN PERSONAL INJURY OR DEATH, OR PROPERTY DAMAGE.

6.4.2 Mounting and fastening the Receiving Unit in the best position

Place the Receiving Unit so as to avoid damage due to incidental contact.

Place the Receiving Unit so that it can be easily reached in case of need.

Place the Receiving Unit so that it can be easily reached, and far from heat sources (e.g. exhaust pipes, heat exchangers, radiators).

Place the Receiving Unit vertically, with the cable gland or the plug facing down.

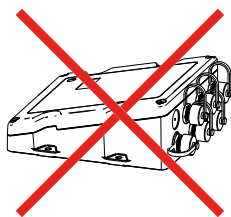

NO

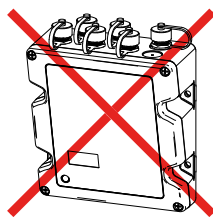

NO

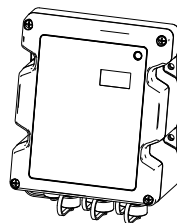

YES



WARNING

Fix the Receiving Unit in four points, using the specific holes in the housing.

Do not perforate the Receiving Unit in any case.

When installing on Machines that are subject to intense mechanical stress (by way of example: vibrations, rough paths, sudden movements), it is recommended to fix the Receiving Unit to the Machine with the appropriate vibration dampers.

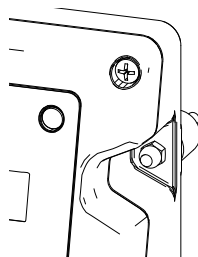
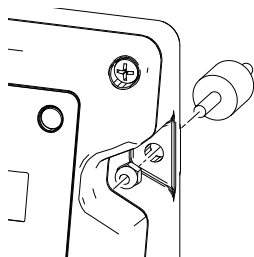

6.4.3 Positioning the antenna

The Receiving Unit may be configured with internal antenna or external antenna (see Technical Data Sheet). If the antenna is external, it cannot be mounted directly on the Receiving Unit's casing, but it must be installed with the antenna cable-extension kit.

If the antenna is inside the Receiving Unit, install the Receiving Unit in a free and easily accessible area of the Machine: protections, panels, parts, surfaces or anything else should not be present, so that shields, structures or materials do not obstruct the radio link. In particular, the Receiving Unit must be placed at least 50 cm far from metal objects in its surroundings and must never be placed inside closed metal containers.

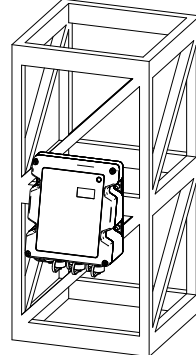
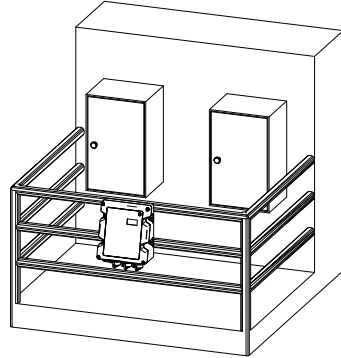
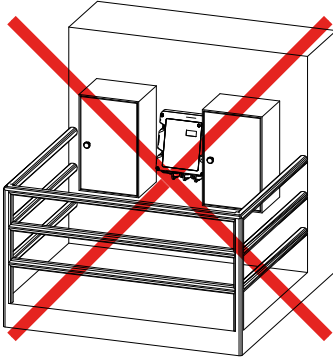

NO

YES

If the antenna is external to the Receiving Unit, install the antenna vertically as far as possible from the Receiving Unit and from other electrical and electronic devices. The antenna must not be placed inside closed metal containers. Install the antenna at least 50 cm far from metal objects in the surroundings, in a free area of the Machine; protections, panels, parts, surfaces or anything else should not be present, so that shields, structures or materials do not obstruct the radio link.

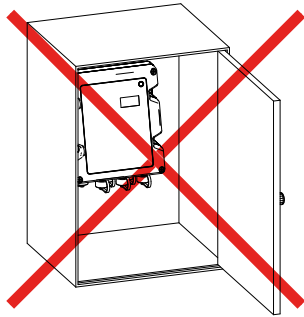

NO

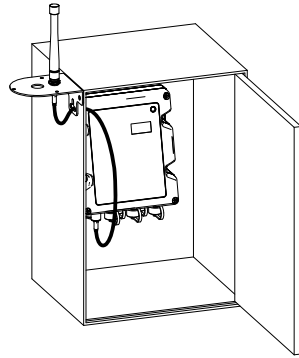

YES

6.4.4 Wiring

Wiring is understood as the electrical cable connections that can be found:

- Inside the Receiving Unit
- Between the Receiving Unit and the Machine.

ALL ELECTRICAL CONNECTIONS MUST BE PERFORMED AND MADE IN COMPLIANCE WITH THE NATIONAL ELECTRIC CODE AND ALL APPLICABLE LAWS, REGULATIONS AND STANDARDS, EVEN LOCAL. IF INSTRUCTIONS PROVIDED BY AUTEC ARE INCONSISTENT WITH SUCH APPLICABLE LAWS, REGULATIONS OR STANDARDS, DO NOT INSTALL THE AUTEC RADIO REMOTE CONTROL WITHOUT CONSULTATION WITH AUTEC. AUTEC IS NOT RESPONSIBLE FOR AND SHALL NOT BE HELD LIABLE FOR ANY MALFUNCTIONS OR ACCIDENTS THAT MAY OCCUR DUE TO ANY IMPROPER INSTALLATION OR INCONSISTENCY BETWEEN ITS INSTRUCTIONS AND SUCH LAWS, REGULATIONS OR STANDARDS.

FAILURE TO INSTALL THE AUTEC RADIO REMOTE CONTROL CORRECTLY MAY RESULT IN PERSONAL INJURY OR DEATH, OR PROPERTY DAMAGE.

The power supply of the Receiving Unit must have a switch that allows power supply disconnection during installation, wiring and/or maintenance operations. Connect the Receiving Unit immediately downstream of the Machine main switch or of the electrical panel main switch (see the Installation Manual).

Make sure that the Receiving Unit's power supply:

- Complies with technical data (see chapter "Technical Data" in "Part D" in the Instruction Manual)
- Is protected against short circuit (see paragraph "Wiring" in "Part D" in the Instruction Manual)
- Is provided by a battery or by a class 1 (ES1) electrical energy source, according to standard EN 62368-1.

Never connect power supply positive or negative pole to the outputs. Such connections damage the outputs and make ineffective the UMFS and STOP safety functions. In this case the Machine may be in a dangerous condition, out of the User's control.



The Installer must avoid that a power supply positive or negative pole is connected to the outputs.

If a Receiving Unit's output is connected to a direct current inductive load (by way of example: solenoid valves, relays), it is advisable to connect a freewheeling diode in anti-parallel with the driven load, to reduce the effects of demagnetizing currents.

A 12 or 24 V $\overline{\text{DC}}$ voltage must always be applied to the power supply input of solid state outputs.

Common wire related to diodes of solid state outputs must be connected with the common of all the Machine's freewheeling diodes. If that is not possible, connect it to the Receiving Unit's power supply negative.

Pay special attention to the currents flowing in the STOP and SAFETY outputs: they shall not exceed the maximum permitted values (see rated current of STOP and SAFETY outputs in chapter "Technical Data" in "Part D" of the Instruction Manual) .



Wiring of STOP outputs is crucial to define the safety level for the STOP function (see the Installation Manual).

Wiring of SAFETY outputs is crucial to define the safety level for the UMFS protection function (see the Installation Manual).

Single-insulation wiring cables shall be placed inside the Receiving Unit, in such a way that they do not jeopardize the insulation amongst the circuits.

The Installer is in any case responsible for carrying out wiring in such a way as to ensure the safety level required according to the risk analysis; in particular, the connection of power supply's positive or negative pole to the STOP outputs must be avoided.

In compliance with article 9.2.7.4 of IEC Standard 60204-1 and of article 9.2.7.5 of IEC 60204-32, as far as "Take & Release" Radio Remote Controls are concerned, one or more signals (lamps or horns) must be installed; dedicated outputs on the Receiving Unit must be used for that purpose. Such signalling devices indicate which Transmitting Unit is controlling the Receiving Unit.

| | |
|---|---|
|  | <p>Since the "Take & Release" Radio Remote Control consists of two Transmitting Units and one Receiving Unit, the Installer must carefully assess the risks generated by the presence of multiple Units, and adopt the necessary risk reduction measures.</p> |
|---|---|

6.4.5 At the end of installation

| | |
|---|---|
|  | <p>Make sure that during installation the protection measures on the Radio Remote Control and/or in the Machine have not been made ineffective by improper installation works.</p> <p>Look up in the Technical Data Sheet and check that the frequency band set in the Radio Remote Control is permitted in the country of use.</p> <p>Correctly close the Receiving Unit in order to maintain the protection from dust, contaminants and water:</p> <ul style="list-style-type: none">- Make sure that the gasket is intact and correctly seated.- Check that the housing parts correctly fit so that they overlap.- Tighten the screws. |
|---|---|

6.4.6 Testing



The Installer must check and fill in the Technical Data Sheet in all its parts, adding the date in which the radio remote controlled Machine has been put into service, their stamp and signature.



After installing and wiring the Receiving Unit, test the Machine controlled by the Radio Remote Control and verify that the operations carried out correspond exactly to the commands sent, including in particular but not limited to the functionality of the STOP command.

Make sure that the SAFETY outputs (of UMFS function) only activate after the Radio Remote Control has started, and when at least one movement command is sent to the Machine. Also make sure that the SAFETY outputs disable when all the movement commands are released.

In case of malfunction, disable the system “Machine+Radio Remote Control” until the problem has been completely solved and the installation and functionality is confirmed to be correct..

7 Safety

7.1 Risk assessment for radio remote controlled Machines

The Manufacturer of the Machine on which the Radio Remote Control is to be installed shall make a full and proper risk assessment to determine whether the use and installation of the Autec Radio Remote Control is appropriate for the safe and effective operation of the Machine by a Radio Remote Control in the facility and for the purposes intended, also taking into account the reasonably foreseeable misuse, so that the installation, maintenance and operation of the Autec Radio Remote Control and all of its components are done solely and completely in accordance with this Manual, and with all local applicable laws, safety rules and standards (all of the foregoing referred to herein as "Laws, Regulations and Standards").

When carrying out the risk assessment to determine whether the Radio Remote Control may be installed on a Machine, the Manufacturer and/or Installer of the Radio Remote Control must comply with all Laws, Regulations and Standards, even local, regarding safety of the Machine and/or the installation, as well as the following warnings:

- Some Machines cannot be operated with a Radio Remote Control, such as set forth in paragraph 6.1).
- The radio link between the Units might be interrupted (see paragraph 4.1).
- All warnings regarding the installation, use and maintenance provided by Autec (see chapters 6, 8 and 9) must be considered.
- The "Take & Release" Radio Remote Control consists of two Transmitting Units.
- There is a delay between the release of a command in the Transmitting Unit and the deactivation of the corresponding output in the Receiving Unit (see paragraph 7.2).
- There is a delay between the activation of a command in the Transmitting Unit and the activation of the corresponding output in the Receiving Unit (see paragraph 7.2).
- Additional protection measures for the actuators may be necessary (see paragraph 7.3).
- It is possible that a command be enabled or disabled due to electrical and/or mechanical failure (see paragraph 7.4).
- The Machine may be subject to stresses that might generate dangerous situations (by way of example: inertia, swinging load...) if, when a movement is performed, a joystick is released very fast, or the stop function is enabled.

7.2 Delay in command response time



Under normal conditions, the delay between the activation/deactivation of a command in the Transmitting Unit and the activation/deactivation of the corresponding output in the Receiving Unit requires the "Command response time" indicated in the Technical Data (see paragraph 4.5). With poor radio link (by way of example: EM interference, exceeded working range) this delay may protract up to the "Cut in time of the automatic stop function (ATS)" indicated in the Technical Data (see paragraph 4.5). As for the SAFETY outputs only, the "UMFS cut-in time" (see technical data in "Part D" of the Instruction Manual) adds up to this time.

The Manufacturer, the Installer, the Owner, the User and/or the Maintenance Technician, must make sure that these delays never lead to a dangerous situation in the specific uses.

7.3 Inadvertent activation of commands

The User shall operate with the Transmitting Unit in a correct manner, in accordance with the instructions for use and maintenance.



If the Unit is used correctly, accidental contact with the User's body parts or with external bodies does not cause inadvertent activation of the actuators.

Any action carried out on the Transmitting Unit, or on part of it, aiming at activating the actuators in a different way from the one indicated in the instructions for use constitutes an improper use of the Radio Remote Control.

The User must use the Radio Remote Control in conformity with the instruction for use and maintenance and with all the Laws, the Regulations and the Standards, even local, in force in the country where the Radio Remote Control and the Machine are used; moreover, the User must always have the control of the Radio Remote Control and remain in the usage position, as described in the relevant specific part concerning the Transmitting Unit.

| | |
|---|---|
|  | <p>The Machine Manufacturer and/or the Installer must assess and adopt possible additional protection measures for the actuators (by way of example: commands requiring two-hand operation, “dead-man” function) if particular environments, equipment and working modes could generate risk situations, and if Laws, Regulations and Standards in force in the country where the Radio Remote Control and the Machine are used should require it.</p> |
|---|---|

7.4 Activation and/or deactivation of commands due to failure

| | |
|---|--|
|  | <p>It is possible that a command be activated or deactivated due to electrical and/or mechanical failure, that may affect the Radio Remote Control and/or the Machine.</p> <p>The Machine Manufacturer and/or the Installer of the Radio Remote Control must carefully evaluate the possible consequences of such malfunction. If required by the risk assessment, implement protection measures to prevent, reduce and report potential hazardous situations.</p> |
|---|--|

| | |
|---|---|
|  | <p>For further information see paragraph 4.4.</p> |
|---|---|

If a command is activated and/or deactivated due to failure, carry out the following procedure:

1. Press the GSS or EMS pushbutton to bring the Machine to a safe state.
2. Disable the Radio Remote Control and stop using the system "Machine+Radio Remote Control" until the problem has been solved by implementing the necessary technical operations.

7.5 Latching functions

| | |
|---|--|
|  | <p>Latching functions possibly available on the Radio Remote Control cannot be used for Machine's hazardous functions because they are never safety functions.</p> <p>These latching functions are available on the Radio Remote Control only upon request by the Machine Manufacturer and/or Installer, who has/have the responsibility to check if they are appropriate for a safe use of the Machine.</p> |
|---|--|

8 Instructions for the User

The chapter "Instructions for the User" in "Parts C" of the Instruction Manual contains the warnings and instructions for the use that add to those provided in this chapter. Therefore, please refer to that part of the Manual.

FAILURE TO READ, UNDERSTAND AND FOLLOW ALL INSTRUCTIONS AND WARNINGS CONTAINED IN ALL PARTS OF THIS MANUAL FOR THE AUTEC RADIO REMOTE CONTROL MAY RESULT IN PERSONAL INJURY OR DEATH, OR PROPERTY DAMAGE.

8.1 Staff training: use and working conditions

To ensure the correct use of a Radio Remote Control, the following must always be observed:

- Instructions and warnings provided in the Manual and any other documents related to the Radio Remote Control and to the radio remote controlled Machine
- All current provisions on safety at work and on work accident prevention
- All applicable Laws, Regulations and Standards, even local.

| | |
|---|--|
|  | <p>When the Radio Remote Control is installed on Machines on board vehicles, switch off the Receiving Unit while the vehicle is travelling.</p> |
|---|--|

Some drawings illustrating an incorrect use of a Radio Remote Control are provided here, by way of example and by no way of limitation. Those images do not cover all possible dangerous situations or incorrect use of a Radio Remote Control that must be considered and avoided by the Machine Manufacturer and the User.

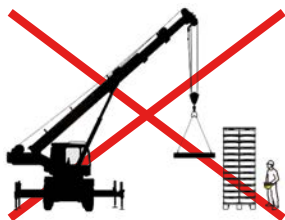

NO



NO

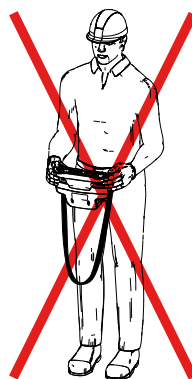

NO

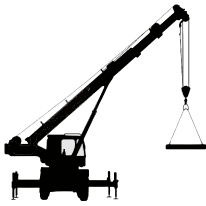

YES



YES



YES

8.2 Warnings for the User

The User must:

- Observe and comply with all instructions and warnings provided by the Machine Manufacturer.
- Observe and comply with all instructions and warnings provided by the Installer.
- Observe and comply with all instructions and warnings provided by the Person responsible for the Machine commissioning or making the Machine available for work.
- Observe and comply with all instructions and warnings provided in the Radio Remote Control Manual.
- Observe and comply with all applicable Laws, Regulations and Standards, even local.
- Operate the Autec Radio Remote Control only in accordance with this Manual and all of its Parts, and with all Autec warnings and instructions, and with applicable Laws, Regulations and Standards, even local.
- Operate the Machine operated by or through the Autec Radio Remote Control only in accordance with the Machine Manufacturer's instructions and warnings, and with applicable Laws, Regulations and Standards, even local.
- Operate the Machine operated by or through the Autec Radio Remote Control only when he is in a safe condition and can perfectly see the whole Machine's working area.
- Immediately inform his supervisors and/or the people in charge for the working place and/or for the Machine about any possible failure, damage, loosening, anomalous wear, detachment and/or any other anomaly that may cause malfunction to the Radio Remote Control and/or to the Machine, or that may cause damage to people and/or property.
- Keep the Transmitting Unit secure and out of reach of unauthorized and unqualified Personnel.

The User must not:

- Use the radio remote control without receiving prior complete training by qualified personnel, and if he does not completely master the instructions and warnings regarding the radio remote control usage
- Use the Radio Remote Control if he suspects malfunction on the Radio Remote Control, the Machine, or one of their components
- Use the Radio Remote Control if the warnings and labels on the Machine or the symbols on the Radio Remote Control cannot be read, are worn or dirty
- Allow the use of the Radio Remote Control to unauthorised and/or untrained Personnel.



ADDITIONAL WARNINGS AND INSTRUCTIONS THAT ARE CONTAINED IN THE OTHER PARTS OF THIS MANUAL MUST BE FOLLOWED.



If the Radio Remote Control User wears electronic devices (by way of example: pacemaker, implantable cardiac defibrillator, hearing aids), the Transmitting Unit must be kept at least 15 cm away from those devices when in use.

8.2.1 Before starting to work



Before starting the Radio Remote Control to work, the User must be positioned in a place that allows him:

- **The direct control of the radio remote controlled Machine and of the load movements, and, at the same time**
- **A safe position with regard to the operation of the radio remote controlled Machine and/or the load movement, and with regard to other operations and/or activities and/or processes taking place in the working place.**

In addition to the above, when the cable control is used, the User must position themselves in a place that prevents them from stumbling on the cable control's cable and from being trapped/blocked by it.

Always check that the mechanical operation of the GSS or EMS pushbutton is correct. If it is impossible or difficult to press this pushbutton, do not use the Radio Remote Control.

Never start up or use the Transmitting Unit if the working conditions pose the risk of losing balance or of tripping.

| | |
|---|--|
|  | <p>Start up the Transmitting Unit only to use it according to its intended use or for operational needs (by way of example: maintenance, checks): improper use may cause dangerous situations.</p> <p>Never start up or use the Transmitting Unit in closed spaces, with no or poor visibility, or outside the Radio Remote Control working range: in such cases it is still possible to establish a radio link between the Transmitting Unit and the Receiving Unit, thus causing the risk that unwanted commands be carried out by the radio remote controlled Machine.</p> <p>Get familiar with the relation between the actuators and the Machine's movements (this is indicated in the attached Technical Data Sheet) and learn symbols on the Transmitting Unit's panel (the used symbols are defined by the Machine Manufacturer and/or by the Installer depending on the effectiveness and the functions the Machine requires).</p> |
|---|--|

8.2.2 During normal operation

| | |
|---|---|
|  | <p>Pay attention to the entire work area. Immediately press the GSS or EMS pushbutton when a hazardous situation occurs.</p> <p>Visually and directly follow all movements of the Machine and its load and remain inside the Radio Remote Control working range.</p> <p>Pay particular attention to warnings and visual and acoustic signals, and take all measurements and steps to avoid that movements of the remote controlled Machine may lead to hazardous situations for people and/or property.</p> <p>In case of malfunction, switch off the Transmitting Unit and disconnect power supply from the Receiving Unit: this way, the system "Machine+Radio Remote Control" is disabled; it must not be used until the problem has been solved by implementing the necessary technical operations.</p> |
|---|---|

| | |
|--|--|
|  WARNING | <p>Pay attention to low battery signals: all dangerous operations (by way of example: hanging load) must be concluded before the battery is completely flat.</p> <p>Use the Transmitting Unit with the complements provided with the Radio Remote Control (by way of example: pouch, waist belt, shoulder harness) to avoid that it accidentally falls, or that actuators come into contact with external bodies, or that the Unit is used improperly.</p> <p>When "Take & Release" Radio Remote Controls are used, by releasing a Machine the User gives an explicit consent to the other Users, thus enabling them to take control of the Machine itself. Therefore, when a User releases a Machine or part of it, they must pay highest attention to possible Machine's movements, as it is no more under their control.</p> |
|--|--|

8.2.3 After using the Radio Remote Control

| | |
|--|---|
|  WARNING | <p>Switch off the Transmitting Unit when not using the remote control to control the Machine, or when work is otherwise interrupted, even for short periods. Do not leave a load hanging or the Machine in dangerous conditions (even when charging the Unit or changing the battery).</p> <p>Never leave the Transmitting Unit unguarded in order to prevent unauthorised or non supervised use.</p> <p>FAILURE TO DO SO CAN RESULT IN SERIOUS BODILY INJURY OR DEATH AND/OR PROPERTY DAMAGE.</p> |
|--|---|

8.3 Operational use

The use of Radio Remote Controls is strictly limited to properly trained Personnel. All instructions for correct use are given in "Part C" of the Manual (related to the Transmitting Unit).

| | |
|---|--|
|  | <p>When the Radio Remote Control is installed on Machines on board vehicles, switch off the Receiving Unit while the vehicle is travelling.</p> |
|---|--|

Environmental working conditions are given in the following table.

| | Temperature | Relative Humidity | Air pressure |
|-------------------------|---|--------------------------|---------------------|
| Transmitting Unit usage | from -25 to +55°C (from -13 to +130°F) | from 5 to 95% | from 70 to 106kPa |
| Receiving Unit usage | from -25 to +70°C (from -13 to +158°F) | from 5 to 95% | from 70 to 106kPa |

In the previous table:

- Temperature of the Transmitting Unit refers to Class 5K4H of the standard EN 50178.
- Temperature, relative humidity and air pressure during of the Receiving Unit refer to Class 5K2 of standard EN 50178.
- The Receiving Unit can work at 70°C (185°F) only if the sum of currents corresponding to the loads simultaneously activated by digital and analogue outputs does not exceed 10A.

9 Maintenance

9.1 Radio Remote Control maintenance - general directions

The Maintenance Technician must:

- Observe and comply with all instructions and warnings provided by the Machine Manufacturer.
- Observe and comply with all instructions and warnings provided by the Installer.
- Observe and comply with all instructions and warnings provided by the Person responsible for the Machine commissioning or making the Machine available for work.
- Observe and comply with all instructions and warnings provided in the Radio Remote Control Manual.
- Observe and comply with all applicable Laws, Regulations and Standards, even local.
- Operate the Autec Radio Remote Control only in accordance with this Manual and all of its Parts, and with all Autec warnings and instructions, and with applicable Laws, Regulations and Standards, even local.
- Operate the Machine operated by or through the Autec Radio Remote Control only in accordance with the Machine Manufacturer's instructions and warnings, and with applicable Laws, Regulations and Standards, even local.
- Operate the Machine operated by or through the Autec Radio Remote Control only when he is in a safe condition and can perfectly see the whole Machine's working area.
- Immediately inform his supervisors and/or the people in charge for the working place and/or for the Machine about any possible failure, damage, loosening, anomalous wear, detachment and/or any other anomaly that may cause malfunction to the Radio Remote Control and/or to the Machine, or that may cause damage to people and/or property.
- Keep the Transmitting Unit secure and out of reach of unauthorized and unqualified Personnel.



ADDITIONAL WARNINGS AND INSTRUCTIONS THAT ARE CONTAINED IN THE OTHER PARTS OF THIS MANUAL MUST BE FOLLOWED.

All fine-tuning, checking and maintenance actions carried out on the Radio Remote Control shall be verified and recorded by the Person in charge of carrying out maintenance on the Machine.

| | |
|--|--|
|  WARNING | <p>Before any maintenance operation, disconnect the Receiving Unit from the power supply, using the devices and instructions provided by the Machine Manufacturer and by the Installer.</p> <p>After each maintenance operation, always make sure that all commands sent by the Transmitting Unit activate only the corresponding expected operations.</p> <p>In case of malfunction, switch off the Transmitting Unit and disconnect power supply from the Receiving Unit: this way, the system "Machine+Radio Remote Control" is disabled; it must not be used until the problem has been solved by implementing the necessary technical operations.</p> <p>After each maintenance operation, if a Unit has been opened, close it correctly, in order to maintain the protection degree from dust, contaminants and water:</p> <ul style="list-style-type: none"> - Make sure that the gasket is intact and correctly seated. - Check that the housing parts correctly fit so that they overlap. - Tighten the screws. |
|--|--|

9.2 Routine maintenance

Routine maintenance consists of operations needed to preserve the Radio Remote Control normal usage conditions, thus implementing fine-tuning, checks, planned replacement actions that necessarily arise from the normal use of the product.

All given instructions must be followed correctly at each commissioning, that is:

- Whenever the Radio Remote Control and/or the Machine is installed or assembled
- Whenever the Machine location/position changes
- After special maintenance.

Routine maintenance carried out as described in this Manual is fundamental for using the Radio Remote Control safely.

Special applications may require more specific routine maintenance actions to be carried out at different periods (by way of example: if the working environment is particularly dirty, or temperature is very high or very low (see limits provided in paragraph 8.3), or in case of heavy application, or if it is used very frequently, some maintenance actions may be required more frequently depending on the instructions provided by the Machine Manufacturer and/or by the Installer).

| | |
|---|---|
|  | <p>When carrying out maintenance on the Machine, always disconnect power supply from the Receiving Unit. In the event of necessary maintenance on the Machine (by way of example: welding), disconnect all the electrical connections of the Receiving Unit.</p> |
|---|---|

9.2.1 Daily routine maintenance

Before starting to work:

- Make sure that the symbols on panel on the Transmitting Unit and on the Receiving Unit are clearly visible and replace the panel if necessary.
- Make sure that the plates on the Transmitting Unit and on the Receiving Unit are readable and intact (refer to the specific part in the Manual concerning the Transmitting Unit and the Receiving Unit).
- Make sure that the mechanical operation of the GSS or EMS pushbutton is correct.
- Make sure that the Transmitting Unit and the Receiving Unit are undamaged in all their parts.
- Check the Receiving Unit status and remove any material from it (dust, remnants, object, etc.): never use solvents or flammable/corrosive materials for cleaning, and do not use high-pressure water cleaners or steam cleaners.
- Check that the wiring of the Receiving Unit is intact and connected.

During normal operation:

- Do not damage the Transmitting Unit (avoid falls, bumps, contact with water, fluids or liquids, etc.).
- Pay attention not to let materials (by way of example: concrete, sand, grease, dirt, lime, dust, etc.) deposit on the Transmitting Unit because they can compromise its use and safety.

After using the Radio Remote Control:

- Clean the Transmitting Unit: never use solvents or flammable/corrosive materials and do not use water jet cleaners, or air pressure or steam pressure cleaners.
- Store the Transmitting Unit in clean and dry places.

9.2.2 Three-month routine maintenance

At least every three months:

- Check the correct correspondence between the commands that are sent and the manoeuvres that are carried out by the Machine.
- Make sure that the SAFETY outputs (of UMFS function) only activate after the Radio Remote Control has started, and when at least one movement command is sent to the Machine. Also make sure that the SAFETY outputs disable when all the movement commands are released. This is safety critical maintenance: it is necessary to keep a record (date, signature, comments) showing that this check has been regularly carried out. Keep the record together with other installation documents.
- Make sure that all the outputs in the Receiving Unit operate correctly, and check that each output activates when the corresponding operation is enabled and deactivates when the operation is disabled.

- Start up the Radio Remote Control and check in the Receiving Unit that the STOP outputs activate. Then press the GSS or the EMS pushbutton and check in the Receiving Unit that the STOP outputs deactivate.

| | |
|---|--|
|  | <p>Before testing the STOP outputs, make sure that no dangerous situations may arise due to the activation of the STOP outputs in the Receiving Unit.</p> |
|---|--|

9.3 Special maintenance

Special maintenance consists of repairs needed due to Radio Remote Control failure, damage or malfunction, and their aim is to restore the original usage and working conditions.

| | |
|---|--|
|  | <p>Special maintenance may be performed only by qualified Maintenance Technicians, that is to say, by skilled technical Personnel with specific competence and knowledge of Autec Radio Remote Control, belonging to the Autec's service network, or explicitly authorised by Autec.</p> <p>When performing special maintenance operations, the Instruction Manual for the use and maintenance of the Autec Radio Remote Control must be available and undamaged in all its parts.</p> <p>Only original Autec spare parts and materials provided by Autec shall be used for the replacement of parts and/or for special maintenance operations.</p> |
|---|--|

When seeking assistance or replacement parts from Autec or its authorized distributors or service centres, the following must be provided:

- Radio Remote Control serial number
- Purchase date
- Description of the problem found
- Address and telephone number of the place where the Radio Remote Control is being used (with the name of the Person to contact)
- Local Radio Remote Control supplier.

9.4 Additional maintenance operations in environments with corrosive agents

If the Radio Remote Control is used in environments where corrosive agents are present (by way of example: sea water, salt fog, salt...), apply grease to the electrical connections to protect them.

| | |
|---|---|
|  | <p>Only use electrically non-conductive, polyalphaolefin and silicate-based grease for electrical contacts.</p> <p>Do not use polyether-, polyolester- and polyphenyl ether-based grease.</p> |
|---|---|

One possible grease to be used is Electric Grease CN 4070 (Macon Research).
Check and replace grease as frequently as shown in the following table:

| Type of connection | Grease check frequency | Re-greasing frequency |
|---|------------------------|--|
| Connector for external antenna | every 4-6 months | If dirt and impurities are found |
| Receiving Unit's plug | every 4-6 months | If dirt and impurities are found |
| Connectors for cable control of Transmitting Unit and of Receiving Unit | 1 month | If dirt and impurities are found, and once a year anyway |
| Contacts of Transmitting Unit, battery charger and battery | weekly | If dirt and impurities are found, and once every three months anyway |

| | |
|---|--|
|  | <p>It is recommended to disconnect the cable control cable and to store it in a protected place when it is not in use.</p> |
|---|--|

When carrying out this kind of maintenance operations, follow these recommendations:







- Make sure that the surface of electrical connections is covered with a layer of grease and add it if necessary.
- Contact the support service of the Machine Manufacturer if evident oxidation is detected.

9.5 Preventive replacement of the Radio Remote Control's electromechanical components

9.5.1 Actuators (joysticks, pushbuttons and switches)

As provided by the Manufacturer of each actuator in the corresponding technical specification, each actuator of the Transmitting Unit can be used for a defined "maximum number of operations", as shown in the table below. The "maximum number of operations" must not be considered as a warranty period.

| | |
|---|---|
|  | <p>The Maintenance Technician must replace joysticks, pushbuttons and selectors on the Transmitting Unit before they reach the maximum number of operations, even though they are still working.</p> <p>This replacement prevents possible failure and dangerous situations (by way of example: inadvertent activation and/or deactivation of the command activated by the actuator).</p> |
|---|---|

| Actuator | Max. operations | Actuator | Max. operations |
|---|-----------------|---|-----------------|
|  | 5×10^6 |  | 5×10^6 |
|  | 5×10^6 |  | 10^6 |
|  | 3×10^6 |  | 6×10^6 |

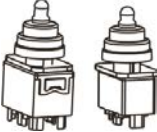
| Actuator | Max. operations |
|---|-----------------|
|  | 5×10^4 |
|  | 10^5 |

| Actuator | Max. operations |
|---|-----------------|
|  | 10^6 |

10 Troubleshooting

If the Radio Remote Control does not work correctly, carry out the following preliminary checks:

1. Move all other Transmitting Units in the working area away from the Autec Transmitting Unit in use to avoid possible radio interference.
2. Bring the Autec Transmitting Unit closer to the matching Autec Receiving Unit to avoid possible radio interference, always positioning yourself in a safe place and with full view of the Machine, its operational area and the load, if any. In a "Take & Release" Radio Remote Control, if you cannot take control of the Receiving Unit, even from a short distance, make sure that it is not already controlled by the other Transmitting Unit.
3. Determine if the problem lies with the Radio Remote Control or with the Machine: to that purpose, you need to try to control the Machine with another control station (if any), different from the Radio Remote Control. If the problem persists after this attempt, you need to fix the Machine: follow the instructions provided by the Machine Manufacturer. Otherwise, the problem lies with the Autec Radio Remote Control, so you need to carry out further checks (see paragraph 10.3).

10.1 Radio Remote Controls with "Data Feedback" function

It is still possible that the Transmitting Unit sends commands to control the Machine even if the Data Feedback function does not work properly (refer to "Data Feedback function" in "Part C" of the Manual), or if there is no information and/or signals coming from it.



When the display or the LED array does not work, please contact the support service of the Machine Manufacturer, even if none of the problems indicated in paragraph 10.3 has been detected.

10.2 Radio Remote Controls with cable control

Possibly use the wire control to check if radio interference occurs.

On the contrary, if you want to check that the wire control works properly:

1. Connect the cable to the Transmitting Unit and to the Receiving Unit.
2. Check that the movement carried out by the Machine correspond to the commands sent by the Transmitting Unit.

10.3 Solutions in case of malfunction

Look up in "Part C" and/or in "Part D" of the Manual to identify the Radio Remote Control malfunction signalled by light signals on the Units.

If the problem persists after attempting the suggested solution, contact the support service of the Machine Manufacturer.

11 Decommissioning and disposal

11.1 Decommissioning

If you want to remove the Receiving Unit from the Machine:

- Make sure that the Receiving Unit and the Machine are not powered.
- Remove all electrical connections between the Receiving Unit and the Machine.

If the Radio Remote Control needs to be stored after it has been decommissioned, follow the directions provided in chapter 5.

If the Radio Remote Control needs to be dismantled after it has been decommissioned, follow the directions provided in paragraph 11.2.

11.2 Disposal

When disposing of a Radio Remote Control, its components must be managed as separate waste. When disposing of a Radio Remote Control, please comply with the provisions and/or the regulations in force in the country where it is used.

11.2.1 Waste disposal in the European Union: Directive 2012/19/EU

In the European Union, all electrical and electronic equipment (EEE) such as radio remote controls must be correctly managed to reduce their environmental impact and protect human health. Therefore, different collection and recycling systems are set out for such equipment.

The symbol consisting of a crossed-out wheeled bin indicates that such EEE must be disposed of in conformity with Directive 2012/19/EU.

The symbol with a crossed-out bin provided on the radio remote control indicates that this product must be separately collected from other waste at the end of its life cycle. Separate collection of end-of-life radio remote controls is set up and managed by the manufacturer.



Users who want to dispose of radio remote controls need to contact their manufacturer to receive directions about the separate collection system chosen for end-of-life products.

As an alternative, it is possible to bring any equipment with no dimension more than 25 cm to retail shops with sales areas relating to EEE of at least 400 m², free of charge and with no obligation to buy any new equivalent equipment.

Proper separate collection of end-of-life Radio remote controls and their subsequent recycling, treatment and environmentally sound disposal contributes to preventing possible negative impacts on the environment and on human health, and fosters the reuse and/or recycling of materials radio remote controls are made of.



Via Pomaroli, 65 - 36030 Caldogno (VI) - Italy
Tel. +39 0444 901000 - Fax +39 0444 901011
info@autecsafety.com - www.autecsafety.com

MADE IN ITALY