

Instruction Manual for the use and the maintenance of the Radio Remote Control

Original instructions

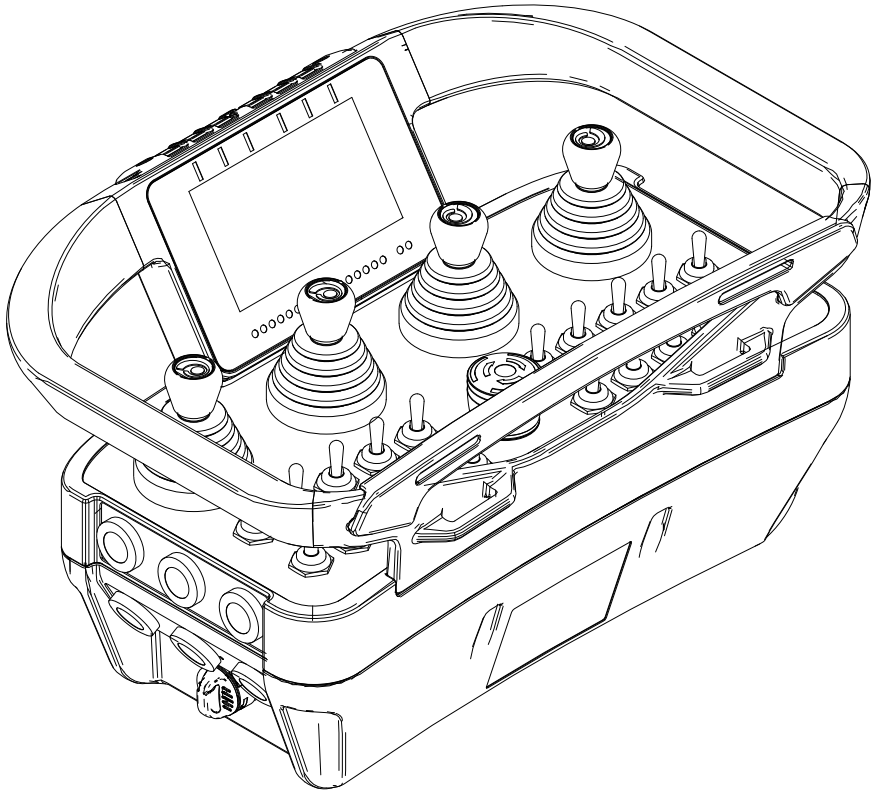

Part C: PJE Transmitting Unit

DYNAMIC+P SERIES



WARNING

THIS PART OF THE MANUAL CONSISTS OF: Part C - Information, instructions and warnings for the PJE (Model J8P) Transmitting Unit. The Manual consists of Part A – General, Part B – Conformity and Frequencies, Part C – Transmitting Unit, Part D – Receiving Unit, Part E – Battery and Battery Charger, plus the Technical Data Sheet.

THIS MANUAL, INCLUDING ALL PARTS THEREOF, AND ALL INSTRUCTIONS CONTAINED HEREIN, MUST BE READ CAREFULLY AND UNDERSTOOD BEFORE INSTALLING, USING, MAINTAINING OR REPAIRING THE AUTC RADIO REMOTE CONTROL.

FAILURE TO READ AND COMPLY WITH ALL APPLICABLE WARNINGS AND INSTRUCTIONS OR ANY ONE OF THE LIMITATIONS NOTED IN THIS MANUAL CAN RESULT IN SERIOUS BODILY INJURY OR DEATH, AND/OR PROPERTY DAMAGE.

THE AUTC RADIO REMOTE CONTROL IS NOT A STANDALONE PRODUCT AND IS INTENDED ONLY AS A COMPONENT ON A MACHINE:

- **ON WHICH AND WHERE THE USE OF A RADIO REMOTE CONTROL IS APPROPRIATE,**
- **THAT CAN BE OPERATED SAFELY AND IN ACCORDANCE WITH ALL APPLICABLE LAWS, REGULATIONS AND STANDARDS BY SUCH REMOTE CONTROL.**

ACCORDINGLY, IT IS THE RESPONSIBILITY OF THE MACHINE MANUFACTURER ON WHICH THE AUTC RADIO REMOTE CONTROL IS INTENDED TO BE INSTALLED, to perform an in-depth and accurate risk assessment to determine if the Autec Radio Remote Control is suitable for operating a Machine in conditions of safety and operational effectiveness, taking into account the conditions of use, the intended uses and the reasonably foreseeable incorrect ones, so that the installation, maintenance and use of the Autec Radio Remote Control, and all its components, are performed only and entirely in compliance with this Manual and in accordance with all local regulations, safety standards and regulations (referred to herein as "Laws, Regulations and Standards").

With reference to the USA market the Laws, Regulations and Standards include all safety rules and regulations of the Occupational Safety & Health Administration (OSHA) (<http://www.osha.gov>), all federal, state and local laws, regulations and building and electrical codes, and all applicable standards, including but not limited to ANSI Standards.

It is also the responsibility of the Manufacturer and of the design professionals of the Machine on which the Autec Radio Remote Control is to be installed and used to be certain that the structure, condition, organization and markings of the Machine as installed at the facility is appropriate for and will allow for the safe and reliable use and control of the Machine through the Autec Radio Remote Control interface.

IT IS THE RESPONSIBILITY OF THE OWNER AND FACILITY OPERATOR, AND THEIR DESIGN PROFESSIONALS, that the installation, maintenance and operation of the Autec Radio Remote Control and all of its components are done solely and completely in accordance with this Manual, and with all applicable Laws, Regulations and Standards, even local. It is also the responsibility of the Manufacturer of the Machine on which the Autec Radio Remote Control is to be installed and used, and their design professionals, to be certain that the structure, condition, organization and markings of the Machine as installed at the facility is appropriate for and will allow for the safe and reliable use and control of the Machine through the Autec Radio Remote Control interface.

ONLY QUALIFIED AND PROPERLY TRAINED PERSONNEL SHOULD BE PERMITTED TO OPERATE OR USE THE AUTEC RADIO REMOTE CONTROL AND THE MACHINE OPERATED BY OR THROUGH THE AUTEC RADIO REMOTE CONTROL. ONLY QUALIFIED AND PROPERLY TRAINED PERSONNEL SHOULD BE PERMITTED TO BE IN THE VICINITY OF MACHINE OPERATED BY OR THROUGH THE AUTEC RADIO REMOTE CONTROL.

FAILURE TO PROPERLY INSTALL, OPERATE, MAINTAIN AND SERVICE THE AUTEC RADIO REMOTE CONTROL CAN RESULT IN SERIOUS BODILY INJURY OR DEATH AND/OR PROPERTY DAMAGE. Refer to this Manual and each of its Parts for further assistance or contact Autec. Autec is not responsible for and shall not be held liable for any installation of the Autec Radio Remote Control not performed by Autec or for any use of the Autec Radio Remote Control not in complete compliance with, and/or not maintained in complete compliance with, all Autec instructions and warnings and all applicable Laws, Regulations and Standards, even local.

Autec is not responsible for and shall not be held liable for any alteration or modification of the Autec Radio Remote Control, or the use of non-Autec components or products used with or incorporated into the Autec Radio Remote Control.

IT IS THE RESPONSIBILITY OF THE OWNER AND FACILITY OPERATOR, AND THEIR DESIGN PROFESSIONALS, to be certain that the Autec Radio Remote Control is properly maintained and serviced at all times in compliance with all Autec instructions and warnings, and with all applicable Laws, Regulations and Standards, even local.

IT IS THE RESPONSIBILITY OF THE OWNER AND FACILITY OPERATOR, AND THEIR OFFICERS, MANAGERS AND SUPERVISORS, to be certain that all Users of the Autec Radio Remote Control and that all Persons who are or will be working with or near the Machine operated by or through the Autec Radio Remote Control are fully and properly educated and trained by qualified Personnel in the proper and safe use of the Autec Radio Remote Control and of the Machine, including without limitation complete familiarity with and understanding of Autec warnings and instructions, and all applicable Laws, Regulations and Standards, even local, and that such Users and other Persons do in fact at all times operate or work with the Autec Radio Remote Control safely and ONLY in compliance with Autec instructions and warnings and with all applicable Laws, Regulations and Standards, even local. FAILURE TO DO SO CAN RESULT IN SERIOUS BODILY INJURY OR DEATH AND/OR PROPERTY DAMAGE.

IT IS THE RESPONSIBILITY OF THE OWNER AND FACILITY OPERATOR, AND THEIR OFFICERS, MANAGERS AND SUPERVISORS, to be certain that the areas in which the Machine operated by or through the Autec Radio Remote Control is located and operates are clearly delineated and marked in accordance with all Autec warnings and instructions, and all applicable Laws, Regulations and Standards, even local, and otherwise sufficient to alert and warn ALL PERSONS that the Machine is operated by or through a Radio Remote Control, and prohibiting any unauthorized access thereto. FAILURE TO DO SO CAN RESULT IN SERIOUS BODILY INJURY OR DEATH AND/OR PROPERTY DAMAGE.

FAILURE TO OPERATE THE AUTEC RADIO REMOTE CONTROL SAFELY AND IN COMPLIANCE WITH AUTEC INSTRUCTIONS AND WARNINGS AND WITH APPLICABLE LAWS, REGULATIONS AND STANDARDS, EVEN LOCAL, AND/OR PERMITTING USERS OR OTHER PERSONS NOT PROPERLY TRAINED IN THE SAFE AND PROPER USE OF THE SYSTEM, OR THE MACHINE ON WHICH IT IS INSTALLED, CAN RESULT IN SERIOUS BODILY INJURY OR DEATH AND/OR PROPERTY DAMAGE.

INDEX

1	Information on the use of instructions	8
1.1	Structure of the Instruction Manual	8
1.2	Caption and terminology	10
1.3	Symbols	10
1.4	To whom the instructions are addressed	11
1.5	Instruction storage	11
1.6	Intellectual property	11
2	Brief product presentation	12
2.1	Series, Radio Remote Control and Unit	12
2.2	Conformity with standards	12
2.3	Contacts and useful addresses	12
2.4	Warranty	12
2.5	Technical assistance and spare parts	12
3	Description of the Transmitting Unit	13
4	Technical data	14
5	Technical Data Sheet	14
6	Plates	15
7	Light and acoustic warning signals	15
7.1	Light signals	15
7.2	Acoustic signals	17
8	General operating instructions	17
8.1	Power keyswitch	17
8.2	START pushbutton	18
8.3	GSS pushbutton	18
8.4	EMS pushbutton	19
8.5	Pushbuttons for display/LED	19
8.6	Command meaning	20
8.7	Battery	22
8.8	Starting up the Radio Remote Control	23
8.9	How to take control of the Receiving Unit in a Take & Release Radio Remote Control	24
8.10	How to release the Receiving Unit in a Take & Release Radio Remote Control	25
8.11	Command activation	25
8.12	Interruption of the radio link	25
8.13	Transmitting Unit automatic switch off	26
8.14	Switching off the Transmitting Unit	27
8.15	Data Feedback Function	27
8.16	Cable control	28
8.17	BACK-UP UNIT	30
9	Instructions for the User	30
9.1	Usage restrictions	31
9.2	User behaviour	31
9.3	Belt or harness	33
10	Maintenance	37
11	Malfunction signalled by the Transmitting Unit	38
11.1	Red LED and green LED	38
11.2	Identifying the activated command	39
12	Decommissioning and disposal	40

1 Information on the use of instructions

	Before reading this part of the Manual, you must read and understand the general part (Part A) of the Manual provided with the Radio Remote Control.
---	--

1.1 Structure of the Instruction Manual

The Manual for the use and maintenance of Autec Radio Remote Controls consists of different parts, that altogether form the Manual; the Manual must be read carefully, understood and applied by the Radio Remote Control's Owner, User and by all those Persons that, for any reasons, may operate with the Radio Remote Control or with the Machine where it is installed. The following table describes the structure of the Instruction Manual for the use and the maintenance of the Radio Remote Control.

Part	Title	Contents
A	General part	<ul style="list-style-type: none"> - General information regarding the series, - directions for risk assessment of the "Machine+Radio Remote Control" system, - warnings for installation of the Radio Remote Control, - warnings for use and maintenance of the Radio Remote Control, - instructions for correct transportation and storage of Radio Remote Control.
B	Conformity and frequencies	<ul style="list-style-type: none"> - Operating frequency bands of the Radio Remote Control, - conformity and law references of the Radio Remote Control.
C	Transmitting Unit	Description and instructions concerning the Transmitting Unit, including: <ul style="list-style-type: none"> - description of operation, - commands, - light signals, - malfunctions, - additional instructions to the general part.
D	Receiving Unit	Description and instructions concerning the Receiving Unit, including: <ul style="list-style-type: none"> - description of operation, - light signals, - malfunctions, - additional instructions to the general part.
E	Battery and battery charger	Description, warnings and instructions concerning batteries and battery chargers, including: <ul style="list-style-type: none"> - description of operation, - light signals, - malfunctions, - instructions for the User.

Usage and maintenance instructions are supplemented by the Radio Remote Control's Technical Data Sheet, that:

- Describes the Transmitting Unit's configuration
- Indicates the relation between commands sent by the Transmitting Unit and those available on the Receiving Unit.

Usage and maintenance instruction as a whole are to be considered as an integral part both of the Autec Radio Remote Control and of the Machine, system, device or Machinery system where the Radio Remote Control is installed.

The Manufacturer of the Machine on which the Autec Radio Remote Control is installed, and the Owner and User of the Machine, must make sure that the Instruction Manual and all of its parts are included in the Instruction Manual of the Machine.

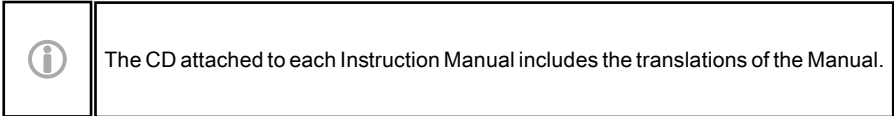

Act as follows to identify the single Manual parts in the relevant language in the CD:

- Choose the desired language
- Select the single parts of the Manual: refer to the code name provided on the cover of each part.

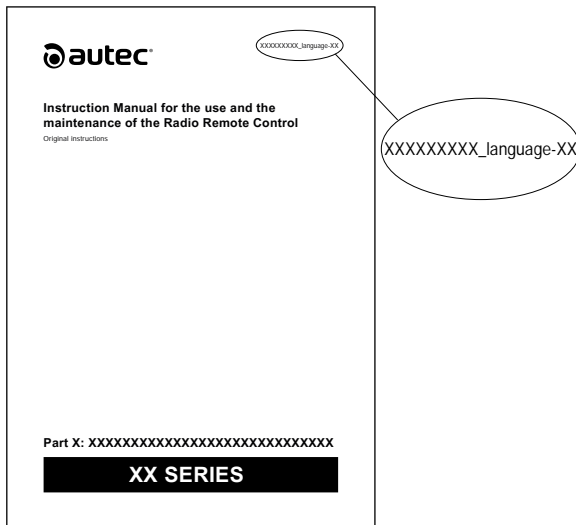

1.2 Caption and terminology



Contact Autec if any of the instructions, symbols, warnings or images are not clear and understandable.

In this part of the Manual, the terms listed below have the same meaning explained in the corresponding paragraph of the general part (Part A):

- **Unit**
- **Radio Remote Control**
- **Transmitting Unit**
- **Receiving Unit**
- **Radio link**
- **Active stop**
- **Automatic stop**
- **Manual stop**
- **Passive stop**
- **Machine**
- **Manufacturer**
- **Installer**
- **User**
- **Maintenance Technician**
- **Manual or Instruction Manual**
- **Installation manual**
- **Person**
- **Owner**

Functions indicated for the Manufacturer, the Installer, the User and the Maintenance Technician may be performed by a single Person, if he/she has the needed competence and undertakes the resulting responsibilities. Each Person must be aware of the instructions contained in the Manual, depending on the activity they carry out.

For example, if a Manufacturer is also the Installer, and/or Maintenance Technician, he/she must also know and follow the instructions specifically addressed to those Persons. The same applies, for example, if a User is also the Manufacturer and/or the Installer.

1.3 Symbols



This symbol identifies the parts of text in the Manual that must be read with special attention.



This symbol identifies the parts of text in the Manual containing warnings, information and/or instructions that are particularly relevant with regards to safety; failure in understanding them or in complying with them may cause hazards for People and/or property.

1.4 To whom the instructions are addressed

Addressees of instructions are listed in the paragraph with the same title in the general part: please refer to that part.

1.5 Instruction storage

Regulation for the storage of instructions are described in the paragraph with the same title in the general part: please refer to that part.

1.6 Intellectual property

Restrictions connected to intellectual property are described in the paragraph with the same title in the general part: please refer to that part.

2 Brief product presentation

2.1 Series, Radio Remote Control and Unit

The object of this part of the Manual is the PJE (Model J8P) Transmitting Unit of an Autec Dynamic+P series' Radio Remote Control.

Autec Dynamic+P series' Radio Remote Controls are designed to be used on Machines and provide a command interface to their command and control system, to be used from an appropriate distance and position.

2.2 Conformity with standards

The conformity of Radio Remote Controls with standards and with working requirements and conditions in the single Countries is provided in the related specific part "Conformity and frequencies" (Part B) of the Manual.

2.3 Contacts and useful addresses

The Radio Remote Controls are produced by Autec Srl – Via Pomaroli, 65 - 36030 Caldogno (VI) - Italy.

You can find contacts for Autec, its distributors, dealers and authorized service centres on the website www.autecsafety.com.

2.4 Warranty

General warranty conditions are indicated both in the relevant sheet provided together with this documentation, and in the specific page on the website www.autecsafety.com.

2.5 Technical assistance and spare parts

If you need technical services and/or spare parts, please refer to contacts provided in the website www.autecsafety.com.

When applying for technical service to Autec, its distributors, dealers and authorized service centres, the Radio Remote Control's serial number is required; you can find it on the identification plate on the Transmitting Unit and/or on the Receiving Unit.

3 Description of the Transmitting Unit

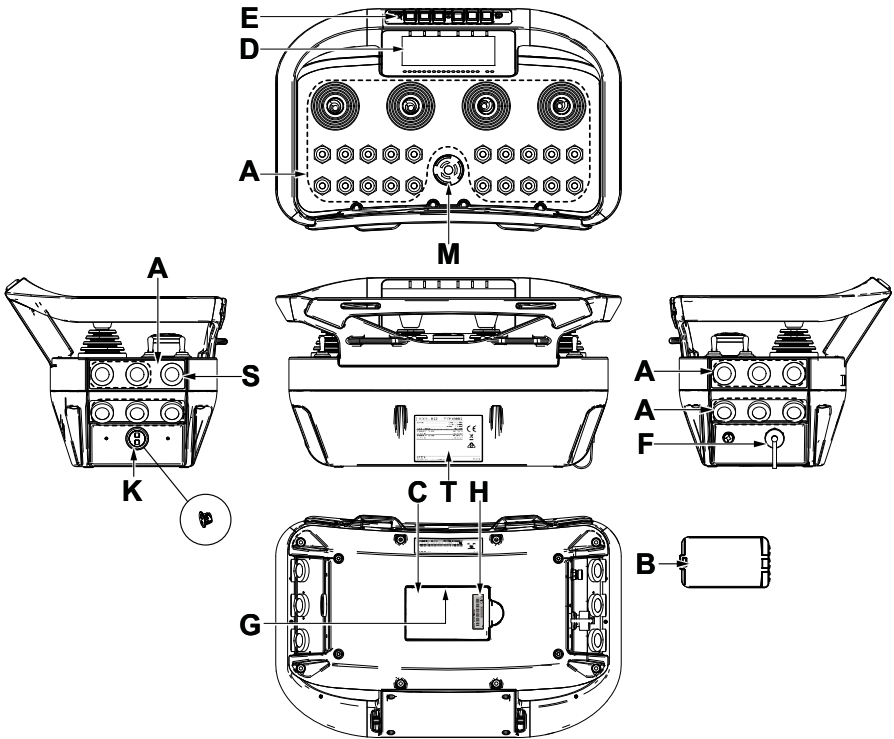

A	Actuators (joysticks, selectors, pushbuttons)
B	Battery
C	Battery housing
D	Display and/or LED (if any)
E	Pushbuttons for display/LEDs (if any)
F	Connector for cable control (if present)
G	Radio Remote Control identification plate

H	Transmitting Unit identification plate
K	Power keyswitch
M	GSS or EMS pushbutton
S	START pushbutton
T	Technical data plate

4 Technical data

Power supply	batteryLPM04
	batteryLPM02
Antenna	integrated
Housing material	PA 6 (20%fg)
Protection degree	IP65 (NEMA 4)
Dimensions	363x233x198mm (14.3x9.2x7.8in)
Weight	6.3kg (13.9lb)
Run time at 20°C (68°F) with LPM02 battery	18,5h
Run time at 20°C (68°F) with LPM02 battery and 4.1" display	15h
Run time at 20°C (68°F) with LPM04 battery	35h
Run time at 20°C (68°F) with LPM04 battery and 4.3" display	8h
Run time at 20°C (68°F) with LPM04 battery and 4.1" display	28h
Power frequency magnetic field immunity according to CEI EN 61000-4-8	up to 300A/m

5 Technical Data Sheet

The Radio Remote Control 's Technical Data Sheet:

- Describes the Transmitting Unit's configuration
- Indicates the relation between commands sent by the Transmitting Unit and those available on the Receiving Unit.

The Technical Data Sheet must be filled in, checked and signed by the Installer, who is responsible for correct wiring.

A Technical Data Sheet must always be kept together with this Manual: if you need to use the Technical Data Sheet for administrative purposes (tests, check, etc.), make a copy of it.

	<p>The wiring of the Receiving Unit's outputs must always reflect the wiring indicated in the Technical Data Sheet.</p>
---	--

6 Plates

Plate	Position	Content
Radio Remote Control identification plate	Battery housing	Radio Remote Control serial number (S/N), QR code and manufacturing year.
Transmitting Unit identification plate	Battery housing	Manufacturing year, a QR code and the Transmitting Unit identification number (TU ID)
Technical data plate	Battery housing	Model, Type and main Transmitting Unit technical data, marking and possible Radio Remote Control marks

7 Light and acoustic warning signals

7.1 Light signals

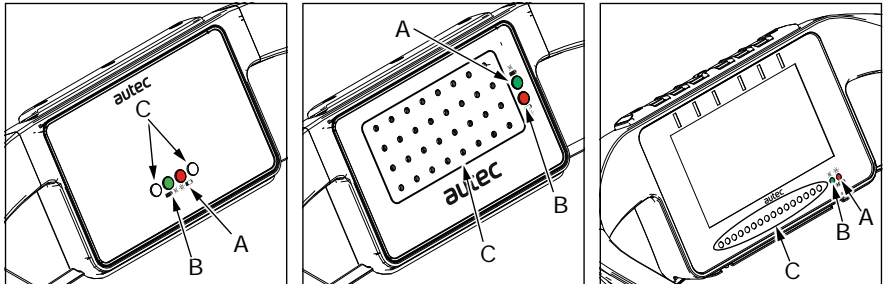

A	Red LED
B	Green LED
C	LEDs for Data Feedback function

The Transmitting Unit always has a green LED [B] and a red LED [A] that provide information regarding the Radio Remote Control.

Symbol	Meaning
	This symbol identifies the red LED [A]
	This symbol identifies the green LED [B]



The meaning of signals provided by the LEDs identified with “C” are explained in the Data Feedback function part (see paragraph 8.15). The meaning of LEDs related to the Data Feedback function are decided and established by the Machine Manufacturer depending on the Machine’s functions for which he wants to receive information.

Signals provided by the red LED [A] indicate a Radio Remote Control malfunction. The meaning of such signals and possible actions to perform are described in chapter 11.

The meaning of signals provided by the green LED [B], when the red LED [A] is off, are described in the following table.

Signals	Meaning
The green LED is off. The red LED is off.	The Transmitting Unit is off.
The green LED blinks fast. The red LED is off.	The Transmitting and Receiving Unit do not communicate.
The green LED repeats the sequence: a blink and a pause. The red LED is off.	The Radio Remote Control is started and the Units communicate via radio link in the 863-870MHz or 2400-2483.5MHz frequency band.
The green LED repeats the sequence: two blinks and a pause. The red LED is off.	The Radio Remote Control is started and the Units communicate via radio link in the 915-928MHz frequency band.
The green LED repeats the sequence: three blinks and a pause. The red LED is off.	The Radio Remote Control is started and the Units communicate via cable control.



The meaning of the green [B] and red [A] LED signals cannot be modified.

7.2 Acoustic signals

The Transmitting Unit has an acoustic signal device that activates when:

- The battery is nearly flat.
- The Transmitting Unit has been on for twenty-four hours.
- The Transmitting Unit does not work correctly.
- During the Radio Remote Control start up, the GSS or the EMS pushbutton is pressed or damaged.
- At least one of the actuators corresponding to the monitored commands is active at Radio Remote Control start up (see paragraph 8.8.1).
- During the Radio Remote Control start-up, the battery is flat.

The acoustic signal device activates whenever the red LED [A] illuminates. The meaning of the red LED [A] lighting up and of the activation of the acoustic signal and possible actions to perform are described in chapter 11.

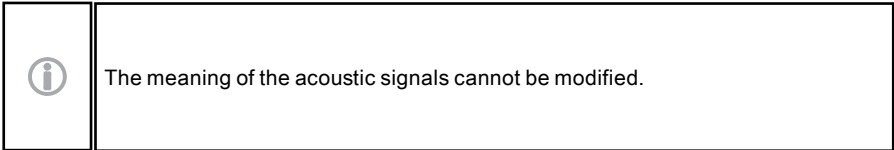

8 General operating instructions

8.1 Power keyswitch

The Transmitting Unit have a power keyswitch. It can either one of the following:

- Mechanical key (see paragraph 8.1.1).
- M-Key (see paragraph 8.1.2).

The Radio Remote Control cannot work if the power keyswitch is not inserted in the Transmitting Unit.

8.1.1 Mechanical key

The mechanical key makes it possible to power the Transmitting Unit.

Inserting the mechanical key

Do the following to insert the mechanical key:

1. Insert the mechanical key into its receptacle.
2. Turn the mechanical key clockwise.

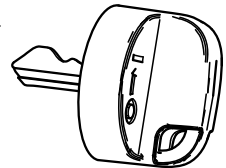

Removing the mechanical key

Do the following to remove the mechanical key:

1. Turn the mechanical key anticlockwise.
2. Pull the mechanical key to remove it from its receptacle.

8.1.2 M-Key

The M-Key makes it possible power the Transmitting Unit.

Inserting the M-Key

Push the M-Key to the bottom of its housing.

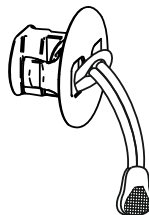

Removing the M-Key

Remove the M-Key from its housing by pulling the lanyard.

8.2 START pushbutton

The START pushbutton is used to:

- start the Radio Remote Control (see paragraph 8.8)
- activate the horn when the Radio Remote Control is started.

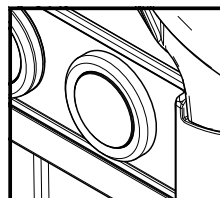

8.3 GSS pushbutton

When the GSS pushbutton (if any) is activated, the Transmitting Unit switches off and the Machine stops. To start the Radio Remote Control again and enable it to control the Machine after the GSS pushbutton has been pressed, you need to:

- Make sure that the working and usage conditions are safe.
- Turn the GSS pushbutton in the direction show by the arrow (see button) to unlock it.
- Start the Radio Remote Control following the procedure described in paragraph 8.8).

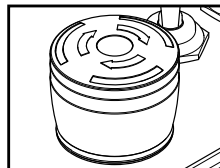

The GSS pushbutton should be pressed when it is necessary to stop the Machine immediately whenever a dangerous condition occurs.

The Machine Manufacturer and/or the Installer must provide the User with the instructions and warnings concerning possible risks that may originate from the Machine stop (by way of example: movement inertia, swinging load...).

8.4 EMS pushbutton

When the EMS pushbutton (if any) is activated, the Transmitting Unit switches off and the Machine stops. To start the Radio Remote Control again and enable it to control the Machine after the EMS pushbutton has been pressed, you need to:

- Make sure that the working and usage conditions are safe.
- Turn the EMS pushbutton in the direction show by the arrow (see button) to unlock it.
- Start the Radio Remote Control following the procedure described in paragraph 8.8).

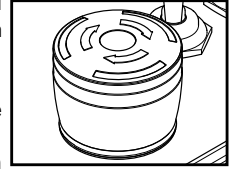

 WARNING	<p>The EMS pushbutton should be pressed when it is necessary to stop the Machine immediately whenever a dangerous condition occurs.</p> <p>The Machine Manufacturer and/or the Installer must provide the User with the instructions and warnings concerning possible risks that may originate from the Machine stop (by way of example: movement inertia, swinging load...).</p>
--------------------	---

8.5 Pushbuttons for display/LED

4.1"/4.3" display

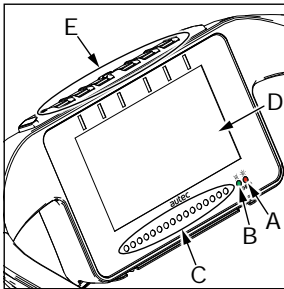

A	Red LED
B	Green LED
C	LEDs for Data Feedback function
D	Display
E	Keys

The pushbuttons [E] on the Transmitting Unit are used to interact with the display [D] and the LEDs for Data Feedback function [C].

	<p>Functions performed by the pushbuttons [E] are configurable and are decided by the Machine Manufacturer: the User must be properly trained in this respect.</p> <p>No operation or movement of the Machine shall be connected to the use of the pushbuttons [E].</p>
--	---

8.6 Command meaning

Commands on the Unit are specified according to the Machine's operations and functions. Their presence and functions are decided and defined by the Machine Manufacturer, who chooses the symbol conventions too.

The control devices described below, when present, perform the following functions (usually the symbol conventions are as in the images).

8.6.1 RPM+/- switch (during normal operation)

This switch increases (rpm +) or decreases (rpm -) the number of revolutions of a Machine's engine.

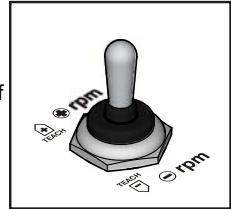

Symbol	Meaning
	This symbol identifies the command that increases the number of revolutions of a Machine's engine.
	This symbol identifies the command that decreases the number of revolutions of a Machine's engine.

8.6.2 TEACH switch (during REMOTE SETUP)

This switch is used to:

- Set maximum and minimum values of proportional outputs (see "Part D" in the Instruction Manual).
- Set values related to the rest position of proportional outputs (offset) (see "Part D" in the Instruction Manual).
- Invert the movement direction of the joystick's axis (see the Installation Manual).

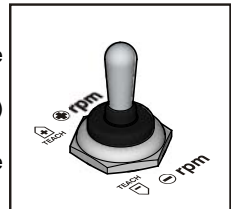

Symbol	Meaning
	This symbol identifies the TEACH+ command.
	This symbol identifies the TEACH- command.

8.6.3 MOVEMENT SPEED SELECTOR



This switch is used to modify the speed of the Machine movements.

Depending on the configuration:

- It sets two or three speed levels.
- It increases or decreases speed.

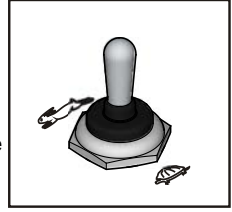
The levels and the speed increase and decrease are chosen by the Machine Manufacturer.





Symbol	Meaning
	Depending on the configuration, this symbol indicates: - the normal speed of the Machine movements or - the increase of speed of the Machine movements.
	Depending on the configuration, this symbol indicates: - the reduced speed of the Machine movements or - the decrease of speed of the Machine movements.
	If this symbol is present, it indicates that the speed of the Machine movements is further reduced.

8.6.4 Engine on/off switch

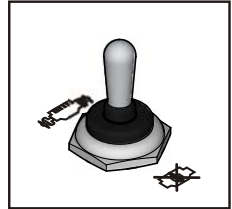
This switch is used to switch on and off a Machine's engine.



Symbol	Meaning
	This symbol indicates the power on command of a Machine's engine.
	This symbol indicates the switch off command of a Machine's engine.

8.6.5 Command TAKE

The TAKE command may be present in the Transmitting Units of a Take & Release Radio Remote Control. The TAKE command enables to take control of the Receiving Unit, if it is free.

8.6.6 Command RELEASE

The RELEASE command is present in all the Transmitting Units of a Take & Release Radio Remote Control. The RELEASE command enables to release the Receiving Unit, if it is engaged.



By releasing the Receiving Unit of a Take & Release Radio Remote Control, the User gives an explicit consent to the other User, thus enabling him/her to take control of the Receiving Unit that has just been released.

8.7 Battery



The Dynamic+P series' Transmitting Units can only be powered by Autec rechargeable batteries.

For any warnings and instructions regarding the battery, see "Part E" in the Instruction Manual.

8.7.1 Battery insertion

To insert the battery, proceed as follows:

1. Push the battery towards the contacts of the Transmitting Unit.
2. Insert the battery in its housing.

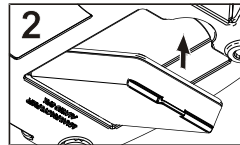
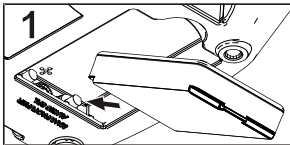

The battery slides easily into place and ensures that the positive (+) and negative (-) poles are correctly connected only if it is inserted with the plate facing its housing, so that the battery's contacts match the Transmitting Unit's contacts.

8.7.2 Battery removal

To remove the battery, proceed as follows:

1. Push the battery towards the contacts of the Transmitting Unit.
2. Remove the battery from its housing.

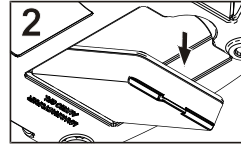
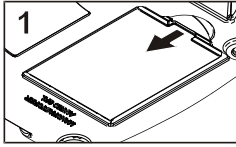

When the Transmitting Unit is not in use, remove the battery if possible.

8.8 Starting up the Radio Remote Control

Starting up the Radio Remote Control means enabling it to send commands and operate the Machine.

 WARNING	<p>The Radio Remote Control start up is protected by a power keyswitch to prevent unauthorised use of the Machine.</p> <p>To activate the Radio Remote Control it is necessary to insert the power keyswitch as described in the following procedure.</p>
-------------	---

Perform the following procedure to start the Radio Remote Control:

1. Power on the Receiving Unit respecting the voltage limits provided in the technical data (see "Part D" of the Manual). The POWER LED illuminates.
2. Insert a fully charged battery in the Transmitting Unit (see paragraph 8.7.1).
3. Insert the power keyswitch in the Transmitting Unit (see paragraph 8.1).
4. In a Take & Release Radio Remote Control, activate the TAKE command and hold it active until the Receiving Unit's seven-segment displays show the following signal: "---1" or "---2".
5. Press the START pushbutton and hold it down until the green LED repeats one of the following sequences: one or two blinks and a pause. If the red LED illuminates, refer to chapter 11.

When the green LED repeats one or two blinks and a pause, the Radio Remote Control is started.

8.8.1 Monitored commands

When the START pushbutton is pressed during the Radio Remote Control start up, the Transmitting Unit checks the status of the commands listed below (see technical data plate according to the radio module in the Transmitting Unit).

Radio module	Monitored commands (factory setting)
FSAACI03A	SAFETY, D2-D20, A1-A8, H1-H8 and L1-L8
FSAACI04A	SAFETY, D2-D20, A1-A8, H1-H8 and L1-L8
FSAACI05A	SAFETY, D2-D32, A1-A16, H1-H16 and L1-L16

If any command is active:

- By pressing the START pushbutton, the Transmitting Unit shows through the LEDs and the display which command is enabled.
- By releasing the START pushbutton before the signal ends, the signal is interrupted.

Both the above mentioned situations end with the automatic switch-off of the Transmitting Unit.

If none of the monitored commands is active, the Radio Remote Control starts.

The commands below (see technical data plate according to the radio module in the Transmitting Unit) are never monitored during start up.

Radio module	Non-monitored commands
FSAACI03A	D21-D48, A9-A12
FSAACI04A	D21-D48, A9-A12
FSAACI05A	D33-D96, A17-A26

If the Machine Manufacturer, based on the risk assessment, considers it necessary to monitor the position of an actuator corresponding to a non-monitored command during start up, contact Autec to verify if this is feasible.

 WARNING	<p>Commands monitored by the Transmitting Unit during start up are chosen by the Machine Manufacturer according to the risk assessment. Based on such assessment, the Manufacturer may ask Autec to modify the factory-set monitored commands, thus making them non-monitored (except the SAFETY command). Look up for monitored and non-monitored commands in the Technical Data Sheet.</p> <p>When the START pushbutton is pressed to start the Radio Remote Control, the commands that are not monitored during start up, if active, immediately activate the Machine functions that are associated with them.</p>
--	---

8.9 How to take control of the Receiving Unit in a Take & Release Radio Remote Control

To take control of the Receiving Unit, activate the TAKE command and hold it active until in the Receiving Unit's seven-segment display appears "---1" or "---2".

8.10 How to release the Receiving Unit in a Take & Release Radio Remote Control

To release the Receiving Unit, activate the RELEASE command. Depending on the Transmitting Unit's configuration, this command may be associated with one or two actuators.

If the RELEASE command is associated to one actuator, to release the Receiving Unit you need to activate the actuator and hold it active until in the Receiving Unit's seven-segment display appears "---F".

If the RELEASE command is associated to two actuators, to release the Receiving Unit you need to activate the two actuators simultaneously and hold them active until in the Receiving Unit's seven-segment display appears "---F".

 WARNING	<p>Autec can set the RELEASE command to be activated in a different way than the above mentioned ones, only upon request by either the Machine Manufacturer or the Installer: the User must be properly trained in the matter.</p> <p>By releasing the Receiving Unit of a Take & Release Radio Remote Control, the User gives an explicit consent to the other Users, thus enabling them to take control of the Receiving Unit just released.</p>
--	--

8.11 Command activation

When the Radio Remote Control is started, it is possible to activate movements, functions and commands on the Machine by acting on the related joysticks, switches or pushbuttons, whose functions and symbols are decided by the Manufacturer and/or the Installer.

To identify the relation between the actuators and the corresponding Machine movements, the Machine Manufacturer and/or the Installer shall provide relevant instructions and the User shall be properly trained.

8.12 Interruption of the radio link

When the radio link is incorrect or interrupted for a certain period of time ("Passive Stop" indicated in the Technical Data Sheet), the automatic stop function activates (see paragraph "Control devices" in "Part A" of the Manual).

The green LED on the Transmitting Unit blinks fast.

The POWER LED on the Receiving Unit illuminates steadily.

To start the Radio Remote Control, press the START pushbutton and hold it down until the green LED repeats one or two blinks and a pause. If the red LED illuminates, refer to chapter 11.

When the green LED repeats one of the following sequences: one or two blinks and a pause, the Radio Remote Control is active and it can send commands and activate the Machine.

8.13 Transmitting Unit automatic switch off

Automatic switch off of the Transmitting Unit occurs in the following cases:

- When the battery is flat (see paragraph 8.13.1).
- When the Radio Remote Control is not used for a certain time (see paragraph 8.13.2).
- When the transmitting unit is powered and never switched off for twenty-four hours non-stop (see paragraph 8.13.3).

The green LED on the Transmitting Unit switches off.

The POWER LED on the Receiving Unit illuminates steadily.

To start the Radio Remote Control, press the START pushbutton and hold it down until the green LED repeats one or two blinks and a pause. If the red LED illuminates, refer to chapter 11.

When the green LED repeats one of the following sequences: one or two blinks and a pause, the Radio Remote Control is active and it can send commands and activate the Machine.

8.13.1 Low battery

The Transmitting Unit indicates if the battery is not sufficiently charged (the red LED blinks and an acoustic signal sounds).

The Transmitting Unit automatically switches off after 3.5 minutes after the onset of the signal. It is necessary to bring the Machine to a safe state and replace the battery with a charged one (see paragraph 8.7).



The battery run time signalled by the Transmitting Unit is reduced by the following factors:

- Battery ageing
- Increasing number of battery charge-discharge cycles
- Battery usage outside the range provided in paragraph "Operational usage" in "Part A" of the Manual.
- Battery storage in disregard of the indications given in paragraph "Storage" in the instruction manual for the use and maintenance of the battery and battery charger.

8.13.2 When the Transmitting Unit is not used

If the Transmitting Unit remains started for a certain time frame while none of the commands listed below are active (see technical data plate according to the radio module in the Transmitting Unit), then it automatically switches off. This time frame is specified in the Technical Data Sheet (Automatic Switch Off).

Radio module	Monitored commands (factory setting)
FSAACI03A	SAFETY, D2-D10, H1-H8 or L1-L8
FSAACI04A	SAFETY, D2-D10, H1-H8 or L1-L8
FSAACI05A	SAFETY, D2-D32, H1-H16 and L1-L16



Setting or removal of the automatic switch off time (Automatic Switch Off) is done by Autec and decided by the Machine Manufacturer, according to his risk assessment and to the operation and functions he needs on the Machine.

8.13.3 Non-stop use

The Transmitting Unit indicates if it has been on for twenty-four hours non-stop (the red LED blinks and an acoustic signal sounds).

The Transmitting Unit automatically switches off after 3.5 minutes after the onset of the signal. Bring the Machine to a safe state before the Transmitting Unit automatically switches off.

8.14 Switching off the Transmitting Unit



Switch off the Transmitting Unit when not actively using the Radio Remote Control to operate the Machine, or when work is otherwise interrupted, even for short periods. Do not leave the load hanging or the Machine in dangerous conditions (even when charging the Unit or changing the battery).

FAILURE TO DO SO CAN RESULT IN SERIOUS BODILY INJURY OR DEATH AND/OR PROPERTY DAMAGE.

Voluntary switch off of the Transmitting Unit occurs in the following cases.

- when the power keyswitch is turned anti-clockwise or removed.
- When the battery is removed (see paragraph 8.7.2).

8.15 Data Feedback Function

The User receives information and/or signals concerning some specific situations and the movements of the controlled Machine by means of the Data Feedback function.

The Data Feedback function acts through the LED array and/or the display.



Any information shown and signalled on the display and/or through the LEDs for Data Feedback function can never be considered or used as a safety signal or for legal metrology.

When operating the Machine, remember that the Radio Remote Control does not cut in autonomously when potential hazardous situations are shown and signalled.

During normal Radio Remote Control operation, pay particular attention to the indications displayed and signalled by the display and/or through the LEDs: they can be helpful to evaluate the Machine working status.

8.15.1 Operation with display

If the Transmitting Unit has a display, it is possible to show warning icons, the measurements collected from the Machine and their description.

The Machine Manufacturer chooses which information are displayed and the way they are displayed (icons and/or measurements and/or descriptions).

In addition, the battery level and the quality of the radio link are always indicated.

8.15.2 Operation with LED

If the Transmitting Unit has an LED array for the Data Feedback function, specific Machine conditions are signalled if they are illuminated (by way of example: load limits, limit switch).

The signalled conditions depend on the settings chosen by the Machine Manufacturer.

8.16 Cable control

The cable control is used:

- in particular working conditions, established by the Machine Manufacturer
- when it is not possible to establish a radio link between the Radio Remote Control Units,
- when working in environments where it is not allowed to work via radio frequency,
- when a fully charged battery is not available.

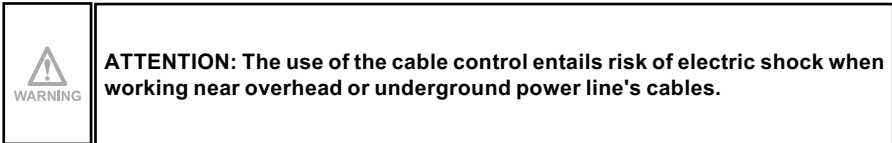



8.16.1 Description

The cable control connects the Transmitting Unit to the Receiving Unit through a cable that replaces the radio link. The cable shall be plugged in the suitable connectors, one on the Transmitting Unit and the other on the Receiving Unit (or placed where established by the Machine Manufacturer).

When using the cable control, the working features of the Radio Remote Control and of the Take & Release Radio Remote Control (e.g. the meaning of actuators and the Data Feedback function) do not change.

8.16.2 Operation

 WARNING	<p>Before starting to work, make sure that the cable and the corresponding connectors are intact.</p> <p>Work organisation, Machines' position, passages, etc. shall be planned so as to avoid that the cable control 's cable may be damaged by moving trolleys or by the ongoing operations.</p> <p>Do not use the cable control's cable to lift the Transmitting Unit.</p> <p>Lay the cable control's cable in such a way as to avoid that it is squashed or strained by People or objects. Avoid contact with sharp or cutting objects that can cut the cable's protective sheath.</p> <p>The cable control cannot be used if the Radio Remote Control is installed on a Machine that controls loads that are not isolated from an AC power supply or from a DC power supply higher than 30V$\overline{---$.</p> <p>Using the cable control at the same time as the waist belt or the shoulder harness means that there is a physical connection between the User and the Machine: therefore, the User must constantly check that the Machine's movements, especially in case of loss of control (by way of example: risk of overturning, of cable dragging by other Machinery), do not cause hazards. In such situations, the User must pull out the belt or open it by unfastening its buckle(s).</p>
--	--

	<p>The cable control must only be connected and disconnected when the Transmitting Unit is off.</p> <p>When you finish working with the cable control, disconnect the cable from the Transmitting Unit and from the Machine, and protect the connectors with their caps.</p>
---	--

Follow this procedure to control the Machine with the cable control:

1. Power on the Receiving Unit respecting the voltage limits provided in the technical data (see "Part D" of the Manual). The POWER LED illuminates.
2. Make sure that the battery is inside the Transmitting Unit and leave it there even though the power supply comes from the Receiving Unit via the cable control. The battery is not, in any case, recharged through the cable control: it can only be recharged through its appropriate battery charger provided together with the system.
3. Connect the cable control to its connector in the Receiving Unit (or where arranged by the Machine Manufacturer).
4. Connect the cable control to its connector on the Transmitting Unit.

5. Insert the power keyswitch in the Transmitting Unit (see paragraph 8.1).
6. In a Take & Release Radio Remote Control, activate the TAKE command and hold it active until the Receiving Unit's seven-segment displays show the following signal: "---1" or "---2".
7. Press the START pushbutton and hold it down until the green LED repeats the sequence: three blinks and a pause. If the red LED illuminates, refer to chapter 11.

When the green LED repeats the sequence: three blinks and a pause, the Radio Remote Control is active and it can send commands and activate the Machine.

When working with the cable control, the radio link is cut off:

8.17 BACK-UP UNIT

If the Transmitting Unit cannot be used, it can be replaced with a Transmitting Unit called BACK-UP UNIT; you need to ask for it from Autec.

It is identical to the Unit that cannot be used any more; the only difference is the presence of the plate "BACK-UP UNIT" on the battery housing.

	<p>As required by standard IEC 60204-32, each Radio Remote Control is uniquely identified through a serial number (S/N). Therefore, upon replacement of the Unit, the serial number of the Transmitting Unit to be replaced must be written on the BACK-UP UNIT, so that all the Units belonging to the Radio Remote Control show the same serial number.</p> <p>Autec cannot be held responsible if the serial number of the Transmitting Unit to be replaced has not been marked on BACK-UP UNIT.</p>
---	---

9 Instructions for the User

The chapter "Instructions for the User" in "Part A" of the Instruction Manual contains the warnings for the use that add to those provided in this chapter. Therefore, please refer to that part of the Manual.

The following instructions are general, they refer to general usage situations for the Transmitting Unit, and indicate how people should or should not behave when using the unit: these do not cover any possible risk situation and/or drawback that may depend on specific applications of Autec Radio Remote Controls.

However, instructions given in the following paragraphs do not replace nor complete the instructions that must be provided to the User by the Manufacturer of the Machine where an Autec Radio Remote Control (to which the PJE Transmitting Unit belongs) is installed.

9.1 Usage restrictions

 WARNING	<p>If the Radio Remote Control User wears electronic devices (by way of example: pacemaker, implantable cardiac defibrillator, hearing aids), the Transmitting Unit must be kept at least 15 cm away from those devices when in use.</p> <p>Do not expose the Transmitting Unit to strong magnetic fields, as they may affect the correct operation of the Unit (its immunity level is provided in chapter 4).</p>
--	--

9.2 User behaviour

Besides the instructions contained in the General Part (Part A) of the Instruction Manual, when using the Transmitting Unit, the User must:

- Observe and comply with all instructions and warnings provided by the Machine Manufacturer.
- Observe and comply with all instructions and warnings provided by the Installer.
- Observe and comply with all instructions and warnings provided by the Person responsible for the Machine commissioning or making the Machine available for work.
- Observe and comply with all instructions and warnings provided in the Radio Remote Control Manual.
- Observe and comply with all applicable Laws, Regulations and Standards, even local.
- Follow and put into practice the working instructions he/she received, and/or those he/she must be aware of because of his/her work and his/her tasks.
- Avoid using the Radio Remote Control if he has not been properly trained and prepared, and if he has not been qualified for its use by the Person responsible for the work.
- Make sure that the Transmitting Unit and the Receiving Unit are whole and work perfectly.
- Make sure that the Machine reacts correctly to the commands activated by the Autec Radio Remote Control.
- Not perform any operation if the tests mentioned in the previous two points did not give positive results.
- Make sure that the Radio Remote Control operation and the consequent Machine movement occur in safety conditions, to prevent hazards to people and/or property.
- Adopt the necessary caution to avoid that the Machine operation causes dangerous situations of any type; to this end, the User's physical and health status shall be taken into account too.
- Avoid leaving the Transmitting Unit unattended or in such a condition that it may be damaged, tampered with, operated by people who are not qualified or by the movement of people and/or objects (by way of example due to: fall, movement, contact).

- Operate the Transmitting Unit by holding it correctly in his hands, so that he can activate the Machine movements correctly and in safe conditions and monitor its light signals.
- Keep at a safe distance from any risk situations originating from the use of the Machine where the Autec Radio Remote Control is installed.
- Avoid doing anything else while using the Radio Remote Control, such as, by way of example, operate other Machines and/or other devices, eat and/or drink, use communication devices (phone, radio phone, etc.), keyboards, computers, IT devices or AV equipment, or carry out any other action that may pose the User in the situation not to be able to correctly control the Transmitting Unit and/or the Machine.
- Activate immediately the stop devices available on the Transmitting Unit and/or on the Machine, in case dangerous situations occur, even if they do not depend on the use of the Machine.
- Use the Transmitting Unit in such a way as to avoid contact with objects and/or People, fall and loss of control.
- Use the transmitting unit with supports such as belts and the like, which are provided with the Radio Remote Control.
- Not modify or tamper with the Transmitting Unit, its components and/or its commands; not modify the indications and/or meaning and/or abbreviations and/or symbols and/or original stickers on the Transmitting Unit's panel.

9.3 Belt or harness

The Unit always comes with a waist belt or a shoulder harness: the User must mount the belt or the harness on the Transmitting Unit and use it as described in paragraph 9.3.1 or 9.3.2.



Replace the belt or harness if it is damaged or worn.

9.3.1 Waist belt

Assembly

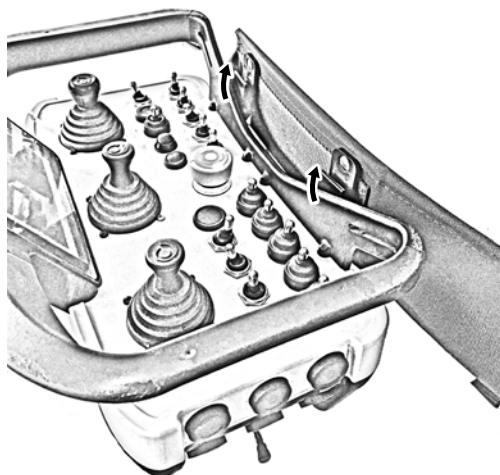

Use

The User must wear the Radio Remote Control with the belt as shown in the photo below, to avoid its fall, loss, loss of control, accidental contact and improper use.



If the Transmitting Unit and the belt are used in a different way from the one described in the above mentioned figure, this constitutes improper use and may lead to damage to the Transmitting Unit, to the User, to people and/or property.

9.3.2 Shoulder harness

Assembly

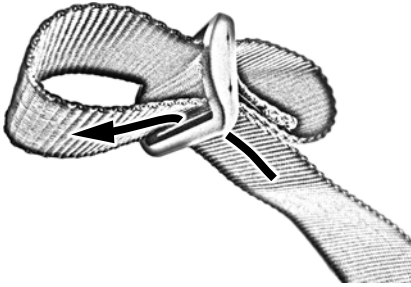
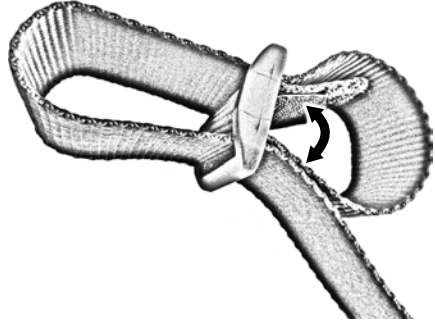
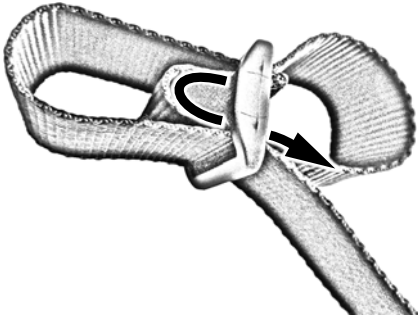
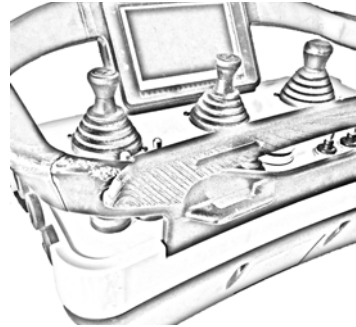
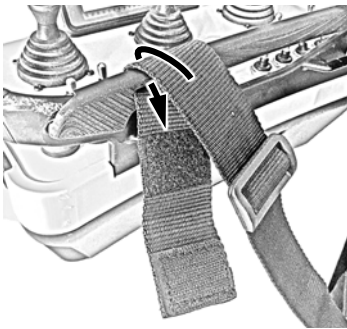
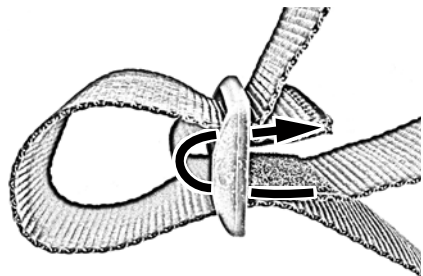
**1****2****3****4****5****6**

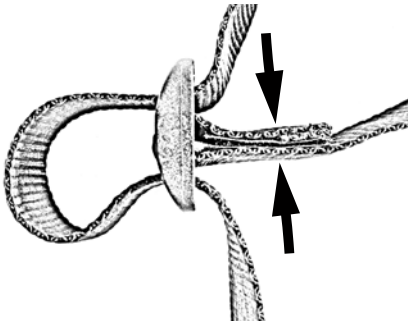

7

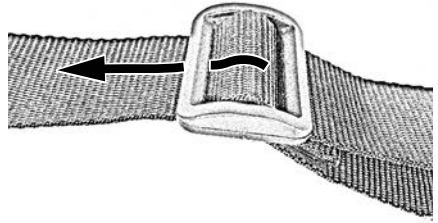

8

Use

	<p>The User must wear the Radio Remote Control with the belt as shown in the photo below, to avoid its fall, loss, loss of control, accidental contact and improper use.</p>
---	--



	<p>If the Transmitting Unit and the belt are used in a different way from the one described in the above mentioned figure, this constitutes improper use and may lead to damage to the Transmitting Unit, to the User, to people and/or property.</p>
---	---

10 Maintenance

Instructions for correct Radio Remote Control maintenance are described in the chapter "Maintenance" included in "Part A" of the Instruction Manual. Therefore, please refer to that part of the Manual.

11 Malfunction signalled by the Transmitting Unit

11.1 Red LED and green LED

The table below lists malfunctions that are signalled by LEDs on the Transmitting Unit and the solution to those malfunctions.

If the problem persists after attempting the suggested solution, contact the support service of the Machine Manufacturer.

Signals	Possible reasons	Solutions
The green LED blinks fast. The red LED blinks for 3.5 minutes.	The battery is not charged enough or the Transmitting Unit has been on for twenty-four hours.	It is necessary to replace the battery with a charged one (see paragraph 8.7) or it is necessary to switch off the Transmitting Unit and to re-start the Radio Remote Control.
The green LED repeats one of the following sequences: one or two blinks and a pause The red LED blinks for 3.5 minutes.		
The green LED repeats the sequence: three blinks and a pause. The red LED blinks for 3.5 minutes.	The Transmitting Unit has been on for twenty-four hours.	It is necessary to switch off the Transmitting Unit and start the Radio Remote Control again.
The green LED is off. The red LED emits one very long blink.	The Transmitting Unit does not work correctly.	Contact the support service of the Machine Manufacturer.
At Radio Remote Control start up, the green LED is off and the red LED emits one long blink.	The GSS or the EMS pushbutton is pressed.	Unlock the GSS or the EMS pushbutton.
At Radio Remote Control start up, the green LED is off and the red LED emits two long blinks.	The Transmitting Unit does not work correctly.	Contact the support service of the Machine Manufacturer.
At Radio Remote Control start up, the green LED is off and the red LED emits three long blinks.	The battery is very low.	It is necessary to replace the battery with a charged one (see paragraph 8.7).
At Radio Remote Control start up, the green LED is off and the red LED emits four long blinks.	The SAFETY command is activated (see Technical Data Sheet).	Bring the actuators to the rest position.

Signals	Possible reasons	Solutions
The green LED is on and the red LED blinks at Radio Remote Control start up	At least one of the actuators corresponding to the monitored commands is active (see paragraph 8.8.1).	Bring the actuators to the rest position. If necessary, it is possible to identify the activated command looking up the table in paragraph 11.2.

	<p>Whenever the red LED illuminates, the acoustic signal device activates.</p> <p>At the end of each signal, the Transmitting Unit switches off.</p> <p>To correctly view signals displayed at the Radio Remote Control start up, press the START pushbutton and hold it pressed until the Transmitting Unit switches off.</p>
---	--

11.2 Identifying the activated command

The turned on green LED indicates that at least one of the monitored commands (see paragraph 8.8.1) is active at Radio Remote Control start up.

You can identify an active command by observing the red LED long blinks followed by short blinks:

- The number of long blinks indicates the type of active command, as described in the following table.

Red LED long blinks	Type of active command
1	Digital command "D"
2	Analogue command "A"
3	Direction command "H"
4	Direction command "L"

- The number of short blinks identifies the specific active command.

The following table provides some examples of identification of active commands.

Green LED	Red LED		Activated command
	Number of long blinks	Number of short blinks	
On	1	16	D16
On	2	4	A4
On	3	3	H3
On	4	6	L6

	<p>Whenever the red LED illuminates, the acoustic signal device activates.</p> <p>The active command can even be identified through the 4.3" display (if any) if this feature has been arranged by the Machine Manufacturer and/or by the Installer.</p>
---	--

12 Decommissioning and disposal

Instructions for correct decommissioning and disposal of Radio Remote Controls are described in chapter "Decommissioning and disposal" in "Part A" of the Instruction Manual. Therefore, please refer to that part of the Manual.



Via Pomaroli, 65 - 36030 Caldogno (VI) - Italy
Tel. +39 0444 901000 - Fax +39 0444 901011
info@autecsafety.com - www.autecsafety.com

MADE IN ITALY