

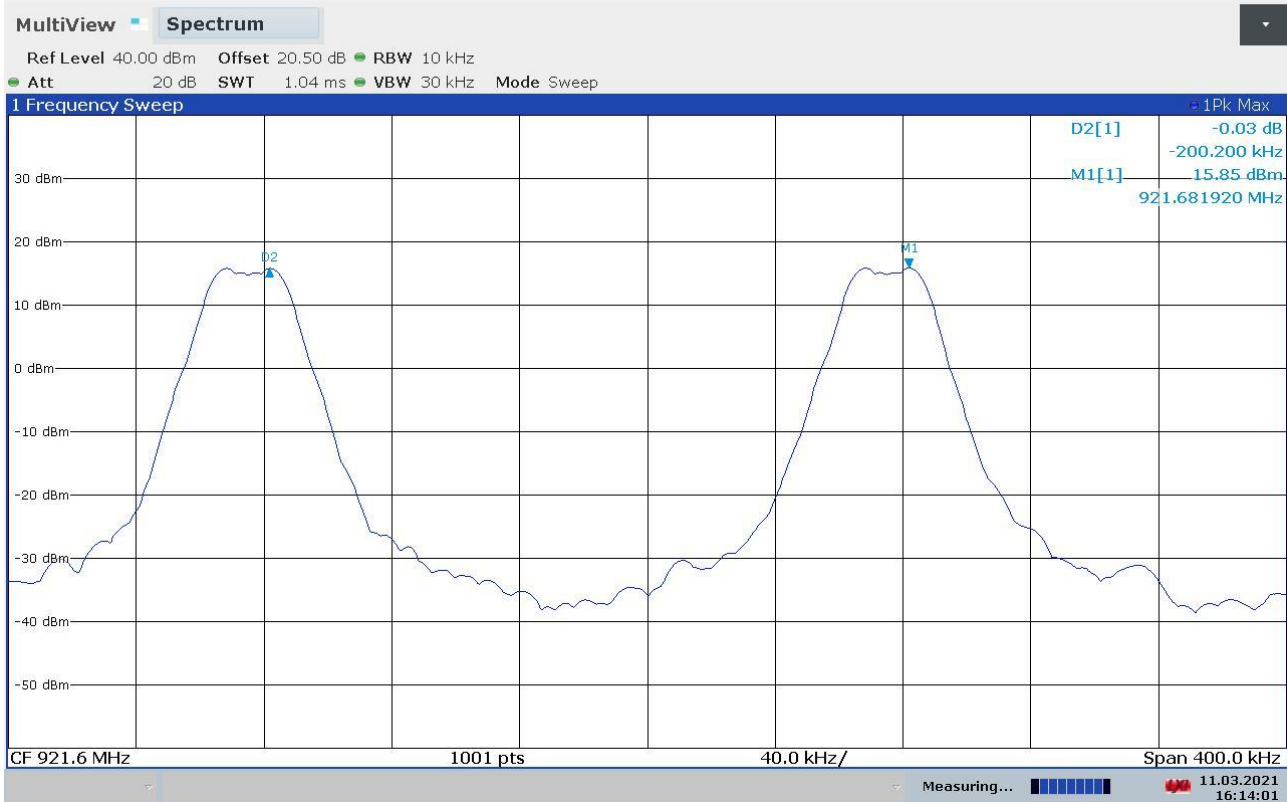

Graphs

Segalla 21057215



9.5 Number of hopping channels

Tested by	M. Segalla
Test date	11.03.2021
Test location (stand)	Laboratory
Reference standards	FCC Rules and Regulation; Titles 47 Part. 15.247 KDB 558074 D01 15.247 Meas Guidance v05r02 cl. 9 b) ANSI C63.10 cl. 7.8.3
Supplementary test set-up description	--
Supplementary information.....	--

Acceptance limits

For frequency hopping systems operating in the 902 – 928 MHz band: if the 20 dB bandwidth of the hopping channel is less than 250 kHz, the system shall use at least 50 hopping frequencies and the average time of occupancy on any frequency shall not be greater than 0,4 seconds within a 20 second period; if the 20 dB bandwidth of the hopping channel is 250 kHz or greater, the system shall use at least 25 hopping frequencies and the average time of occupancy on any frequency shall not be greater than 0,4 seconds within a 10 second period. The maximum allowed 20 dB bandwidth of the hopping channel is 500 kHz.

Test setup

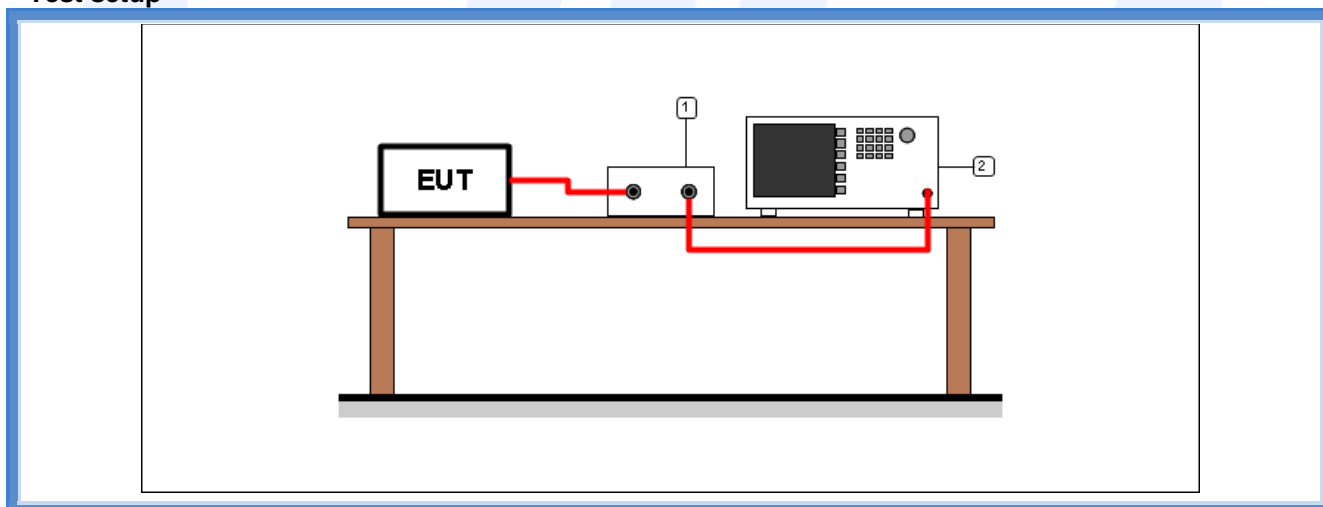

Test setup PR002_01

Nr.	Id. Number	Manufacturer	Model	Description
2	CMC S295	Rohde & Schwarz	FSW43	Spectrum Analyzer 43GHz
1	--	--	--	Cable + attenuator (calibrated before the test)



Result

<i>Frequency band (MHz)</i>	<i>Graphs</i>	<i>Number of hopping channels</i>	<i>Minimum number of hopping channels required</i>	<i>Results</i>
902 – 928	G21057212 G21057213 G21057214	64	50	Complies





Graphs

Segalla 21057212

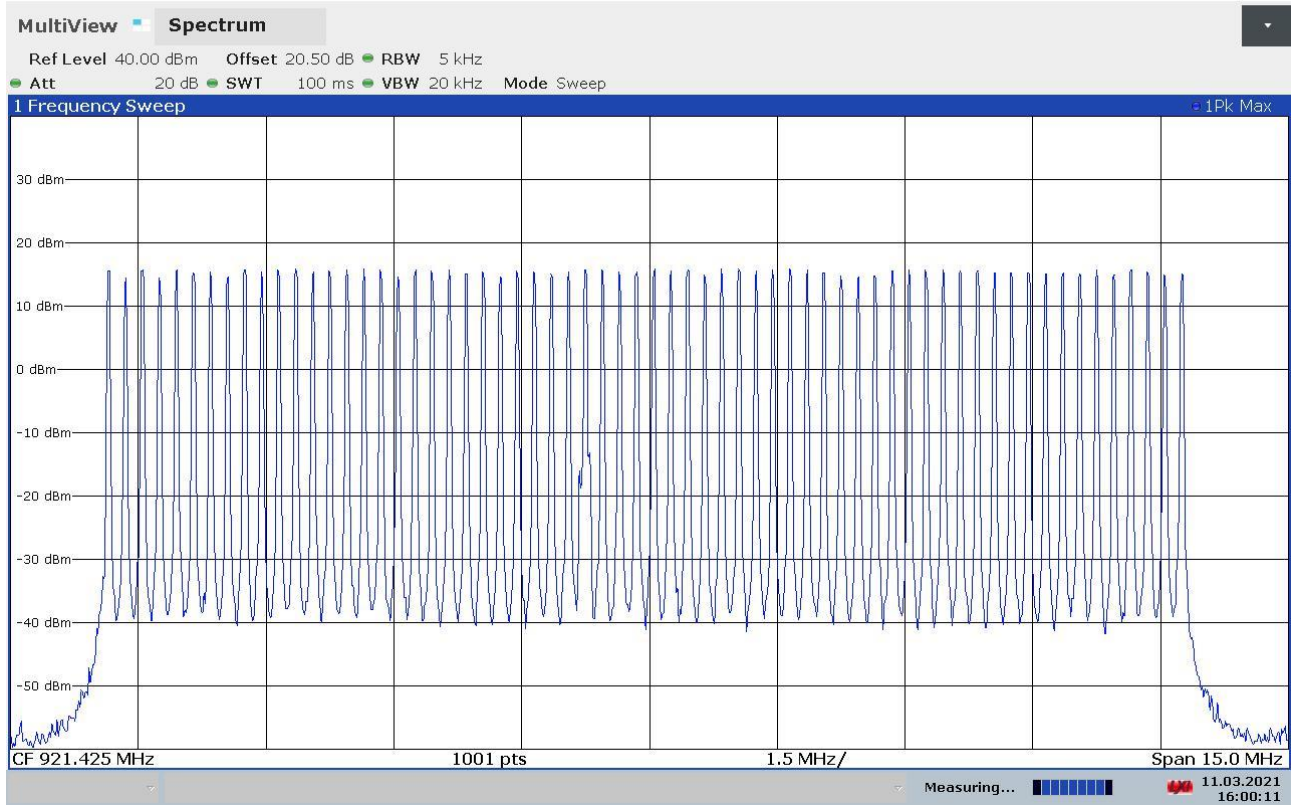

Segalla 21057213

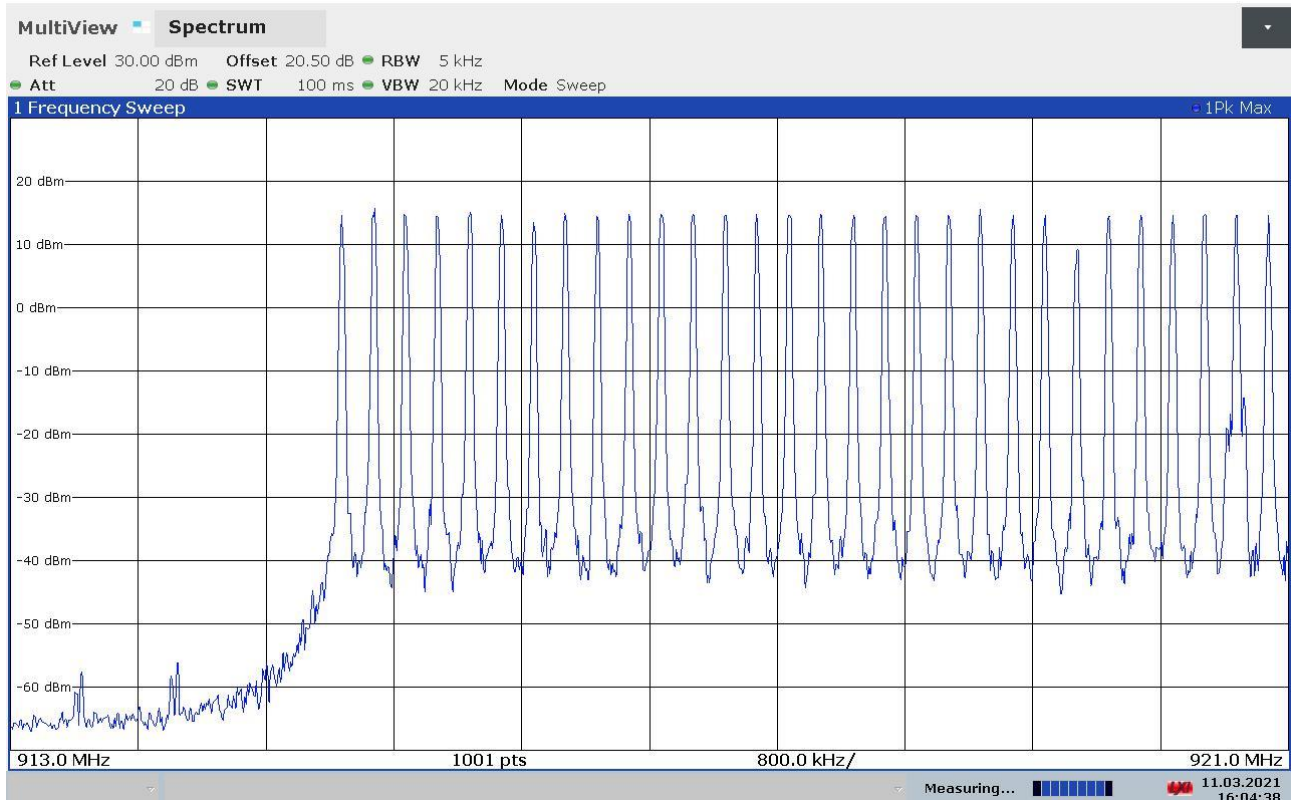



Segalla 21057214

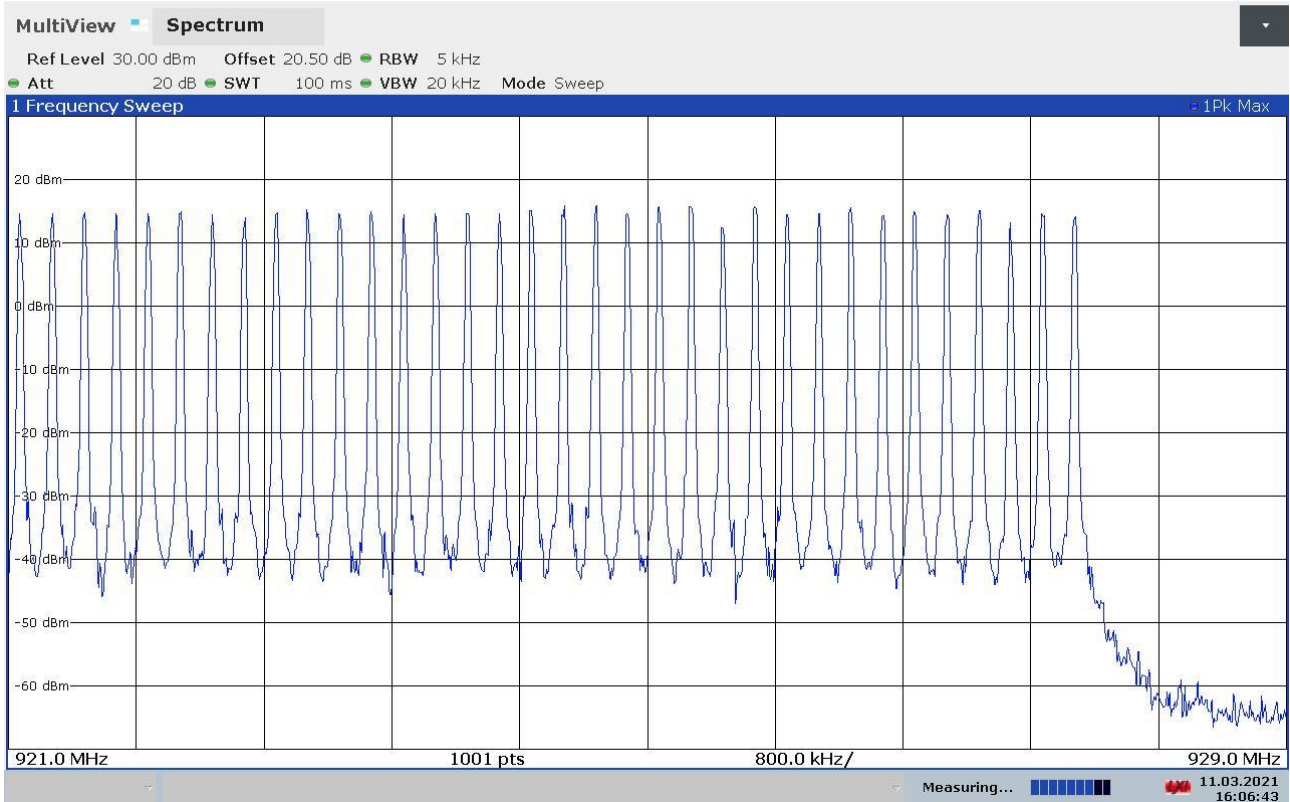

CMC Centro Misure Compatibilità S.r.l.

9.6 Time of occupancy

Tested by	M. Segalla
Test date	11.03.2021
Test location (stand)	Laboratory
Reference standards	FCC Rules and Regulation; Titles 47 Part. 15.247 KDB 558074 D01 15.247 Meas Guidance v05r02 cl. 9 b) ANSI C63.10 cl. 7.8.4
Supplementary test set-up description	--
Supplementary information.....	--

Acceptance limits

For frequency hopping systems operating in the 902 – 928 MHz band: if the 20 dB bandwidth of the hopping channel is less than 250 kHz, the system shall use at least 50 hopping frequencies and the average time of occupancy on any frequency shall not be greater than 0,4 seconds within a 20 second period; if the 20 dB bandwidth of the hopping channel is 250 kHz or greater, the system shall use at least 25 hopping frequencies and the average time of occupancy on any frequency shall not be greater than 0,4 seconds within a 10 second period. The maximum allowed 20 dB bandwidth of the hopping channel is 500 kHz.

Test setup

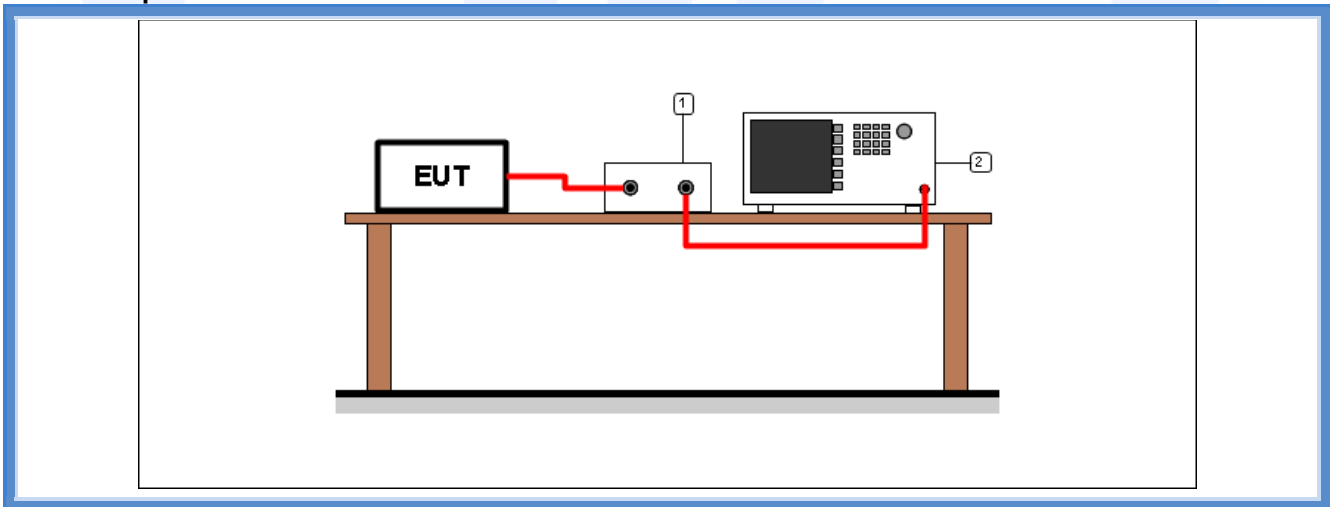

Test setup PR002_01

Nr.	Id. Number	Manufacturer	Model	Description
2	CMC S295	Rohde & Schwarz	FSW43	Spectrum Analyzer 43GHz
1	--	--	--	Cable + attenuator (calibrated before the test)



Result

<i>Frequency (MHz)</i>	<i>Graphs</i>	<i>Dwell time (ms)</i>
921,075	G21057416	20,76

<i>Frequency (MHz)</i>	<i>Graphs</i>	<i>Number of transmissions</i>	<i>Period</i>
921,075	G21057417	8	20 s

Remarks: only the highest peaks have been considered. The lowest peaks are due to the auxiliary receiver unit

<i>Time of occupancy (Dwell time x Nr. transmissions)</i>	<i>Maximum allowed time of occupancy</i>	<i>Results</i>
166,08 ms	400 ms	Complies



Graphs

Segalla 21057216

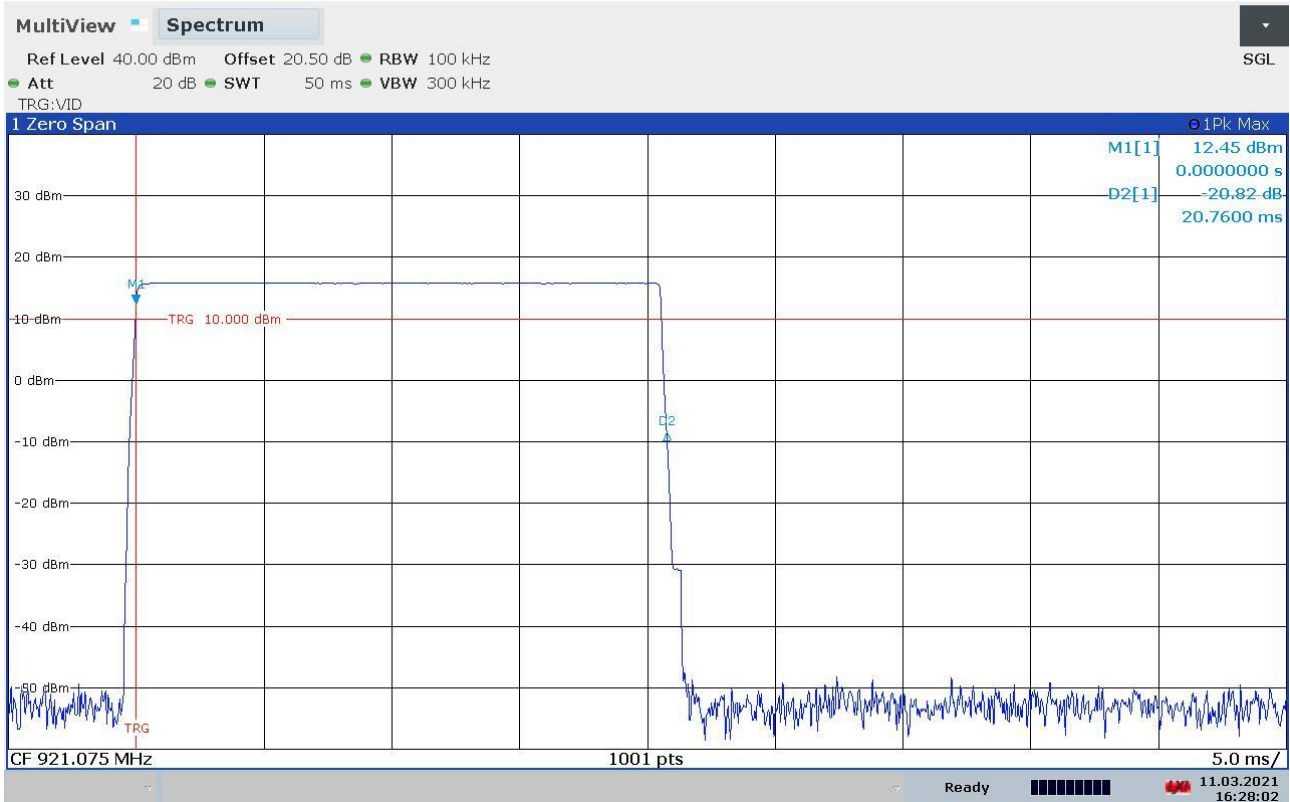

Segalla 21057217

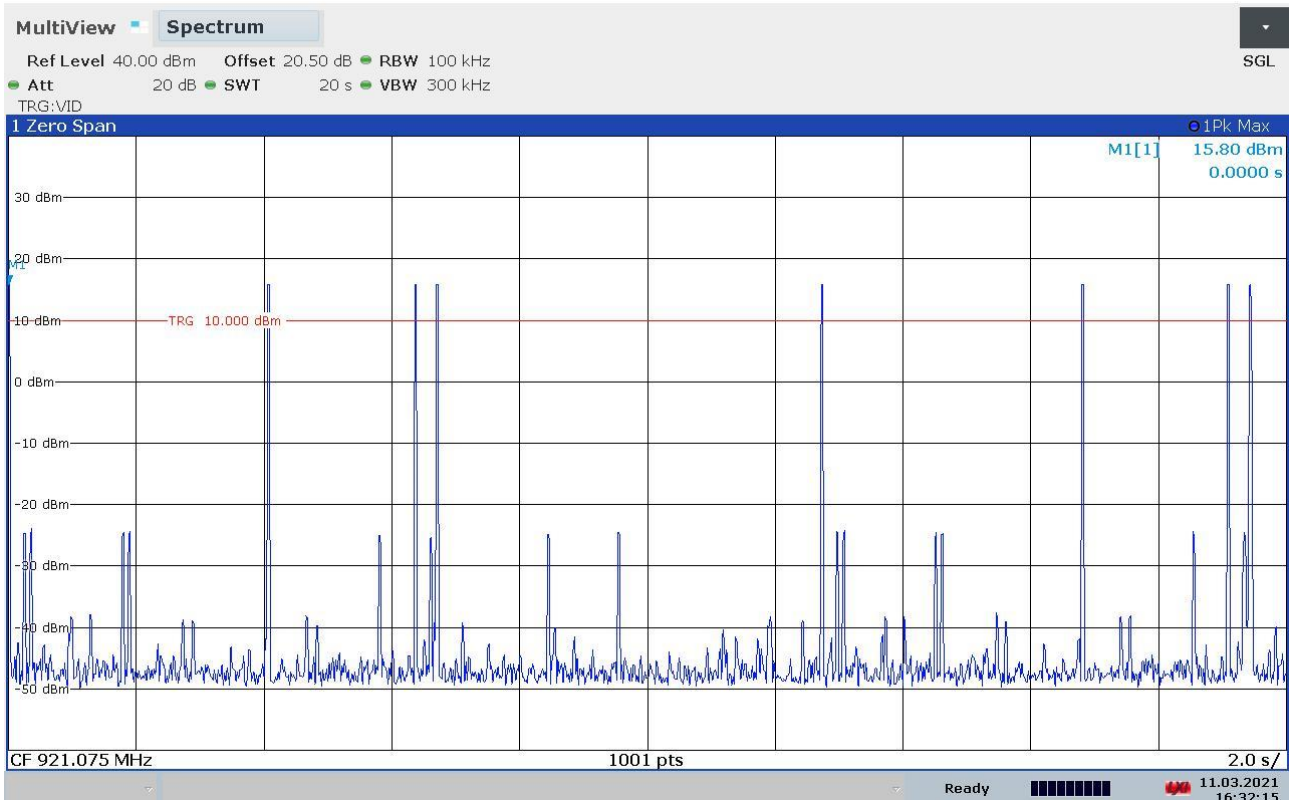

9.7 Band edge

Tested by	M. Segalla
Test date	11.03.2021
Test location (stand)	Laboratory
Reference standards	FCC Rules and Regulation; Titles 47 Part. 15.247 ANSI C63.10 cl. 7.8.6
Supplementary test set-up description	--
Supplementary information.....	--

Acceptance limits

In any 100 kHz bandwidth outside the frequency band in which the spread spectrum or digitally modulated intentional radiator is operating, the radio frequency power that is produced by the intentional radiator shall be at least 20 dB below that in the 100 kHz bandwidth within the band that contains the highest level of the desired power, based on either an RF conducted or a radiated measurement, provided the transmitter demonstrates compliance with the peak conducted power limits. If the transmitter complies with the conducted power limits based on the use of RMS averaging over a time interval, as permitted under paragraph (b)(3) of this section, the attenuation required under this paragraph shall be 30 dB instead of 20 dB. Attenuation below the general limits specified in § 15.209(a) is not required. In addition, radiated emissions which fall in the restricted bands, as defined in §15.205(a), must also comply with the radiated emission limits specified in § 15.209(a) (see § 15.205(c)).

Operation within the band 902 – 928 MHz

Test setup

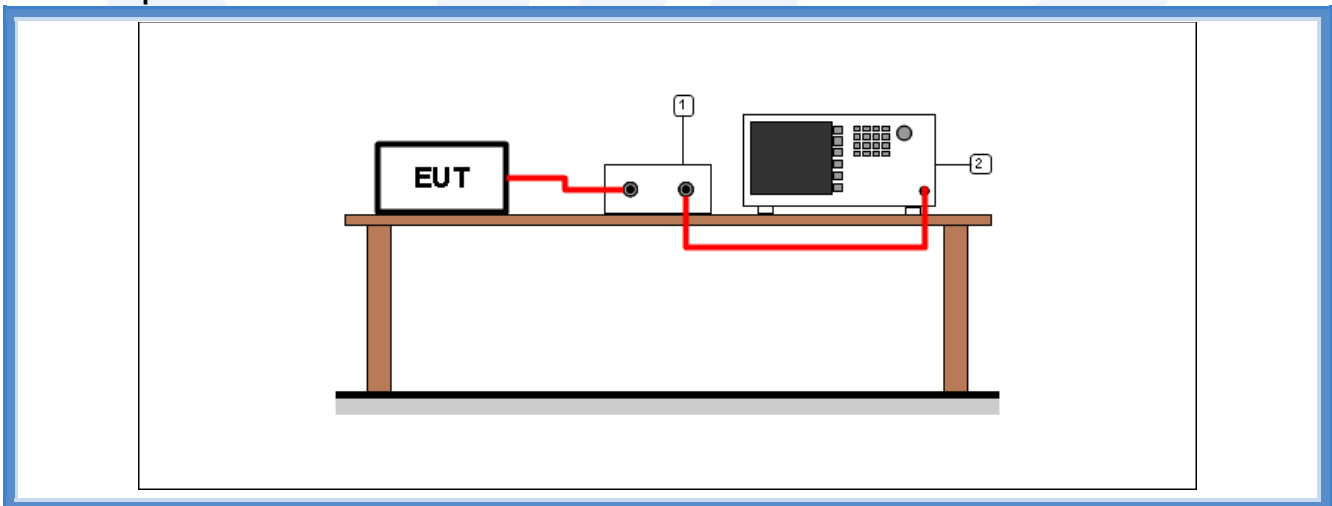

Test setup PR002_01

Nr.	Id. Number	Manufacturer	Model	Description
2	CMC S295	Rohde & Schwarz	FSW43	Spectrum Analyzer 43GHz
1	--	--	--	Cable + attenuator (calibrated before the test)



Result

Frequency (MHz)	Bandwidth	Graph(s) – Hopping	Results	
915,075	100 kHz	G21057218	FL: 914,9360 MHz	Complies
927,825	100 kHz	G21057219	FH: 927,9661 MHz	Complies

Frequency (MHz)	Bandwidth	Graph(s) – No hopping	Results	
915,075	100 kHz	G21057204	FL: 914,9350 MHz	Complies
927,825	100 kHz	G21057211	FH: 927,9467 MHz	Complies



CMC Centro Misure Compatibilità S.r.l.



Graphs

Segalla 21057204

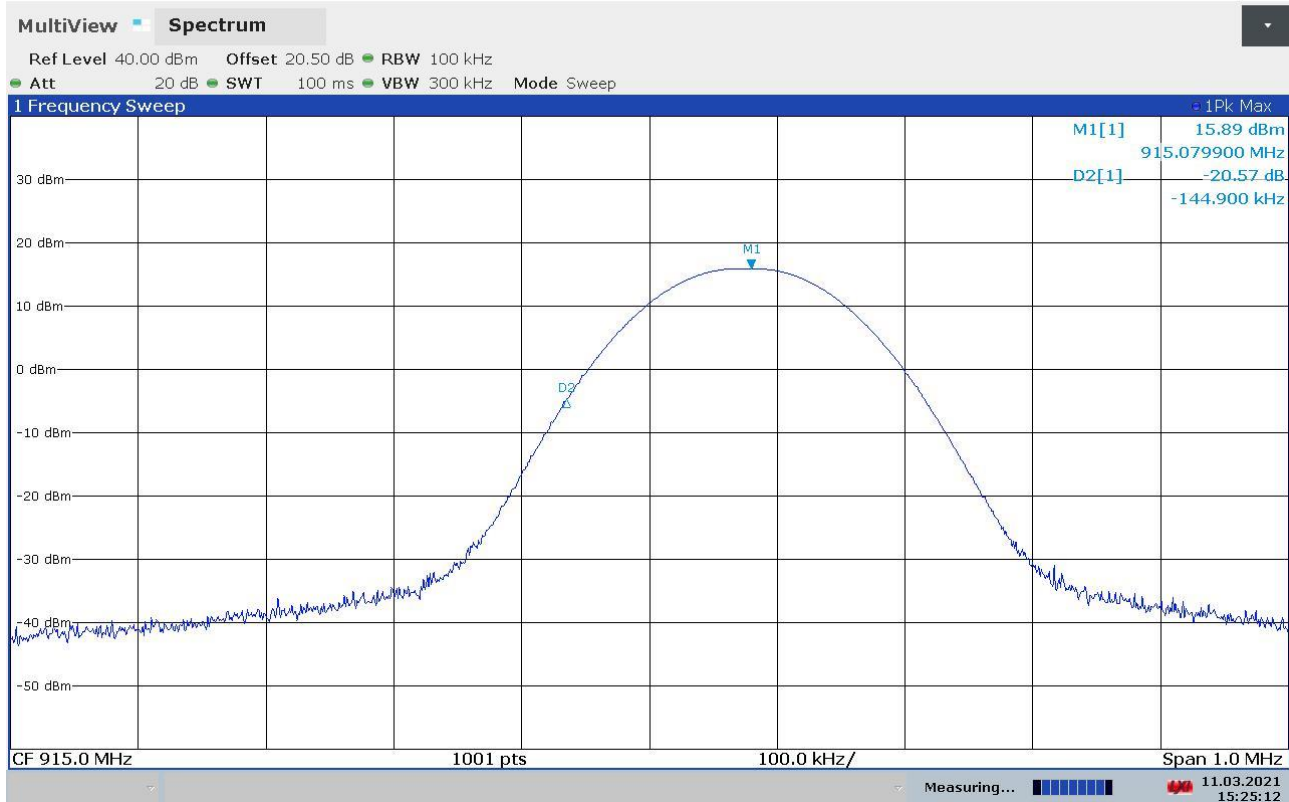

Segalla 21057211

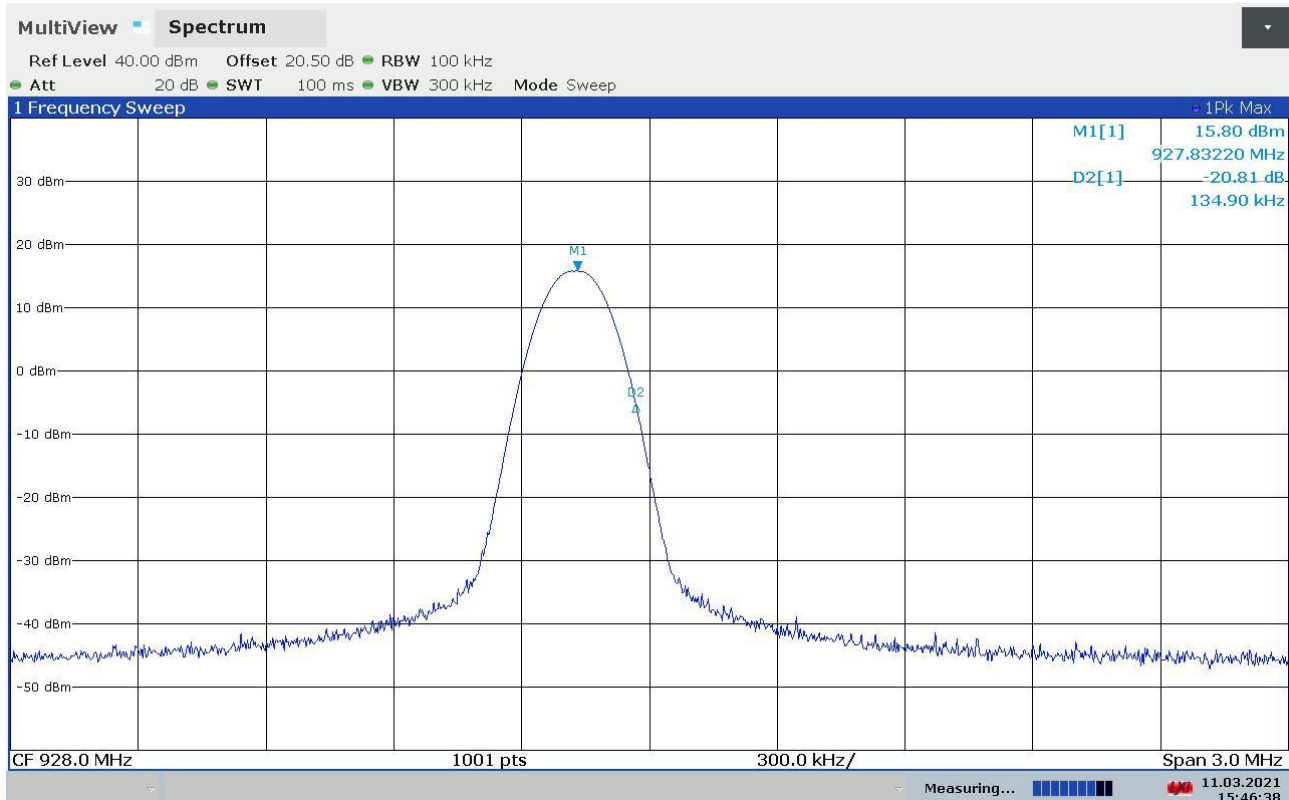



Segalla 21057218

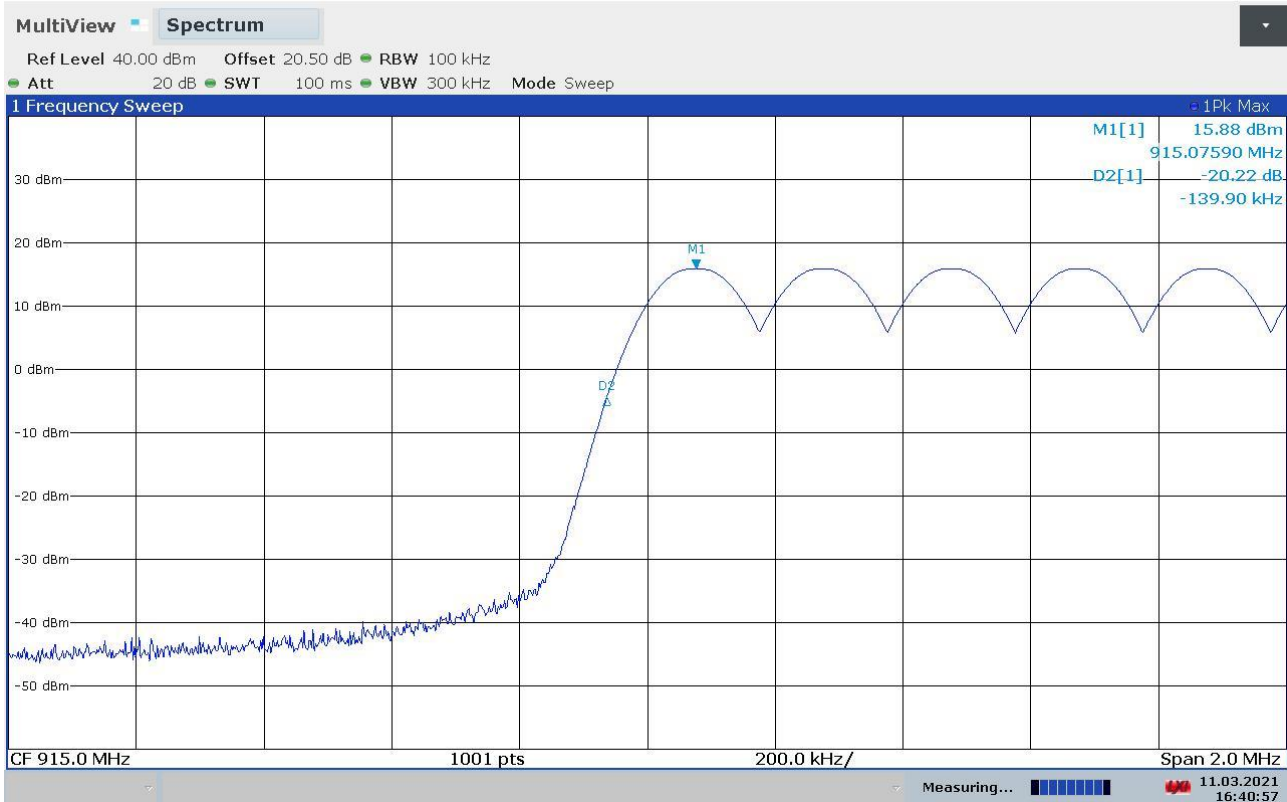

Segalla 21057219

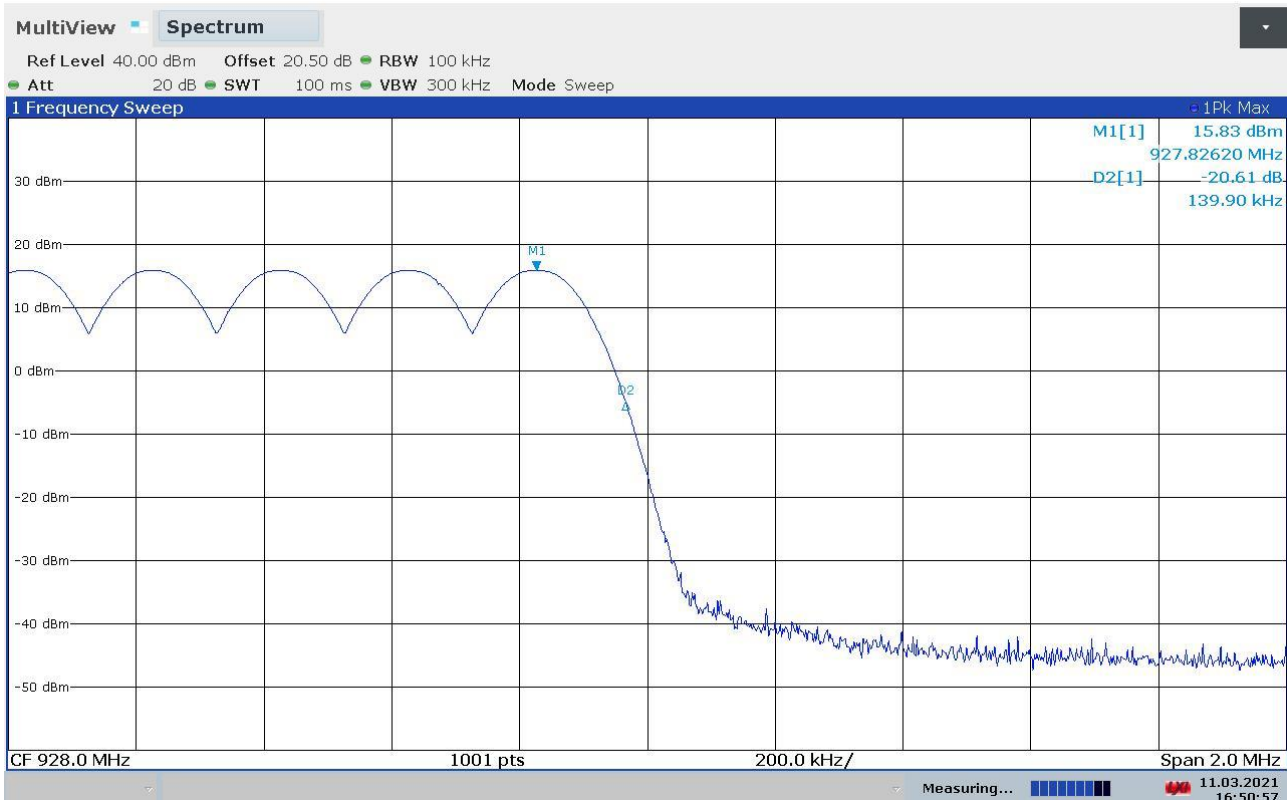

CMC Centro Misure Compatibilità S.r.l.



9.8 Peak Output Power

Tested by	M. Segalla
Test date	11.03.2021
Test location (stand)	Laboratory
Reference standards	FCC Rules and Regulation; Titles 47 Part. 15.247 KDB 558074 D01 15.247 Meas Guidance v05r02 cl. 2.2 ANSI C63.10 cl. 7.8.5
Supplementary information.....	--

Acceptance limits

For frequency hopping systems operating in the 902–928 MHz band: 1 watt for systems employing at least 50 hopping channels; and, 0,25 watts for systems employing less than 50 hopping channels, but at least 25 hopping channels

Test setup

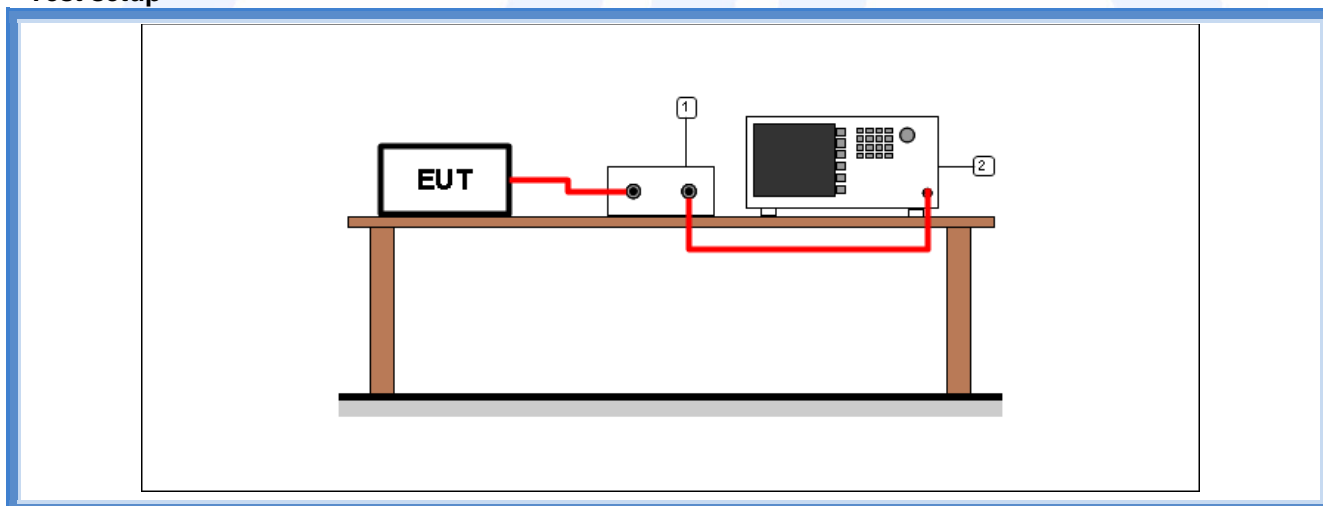

Test setup PR002_01

Nr.	Id. Number	Manufacturer	Model	Description
2	CMC S295	Rohde & Schwarz	FSW43	Spectrum Analyzer 43GHz
1	--	--	--	Cable + attenuator (calibrated before the test)



Result

<i>Frequency (MHz)</i>	<i>Graphs</i>	<i>Peak Output Power (dBm)</i>	<i>Peak Output Power (mW)</i>	<i>Limit (mW)</i>
915,075	G21057403	15,92	39,08	1000
921,425	G21057407	15,85	38,46	1000
927,825	G21057410	15,80	38,02	1000





Graphs

Segalla 21057203

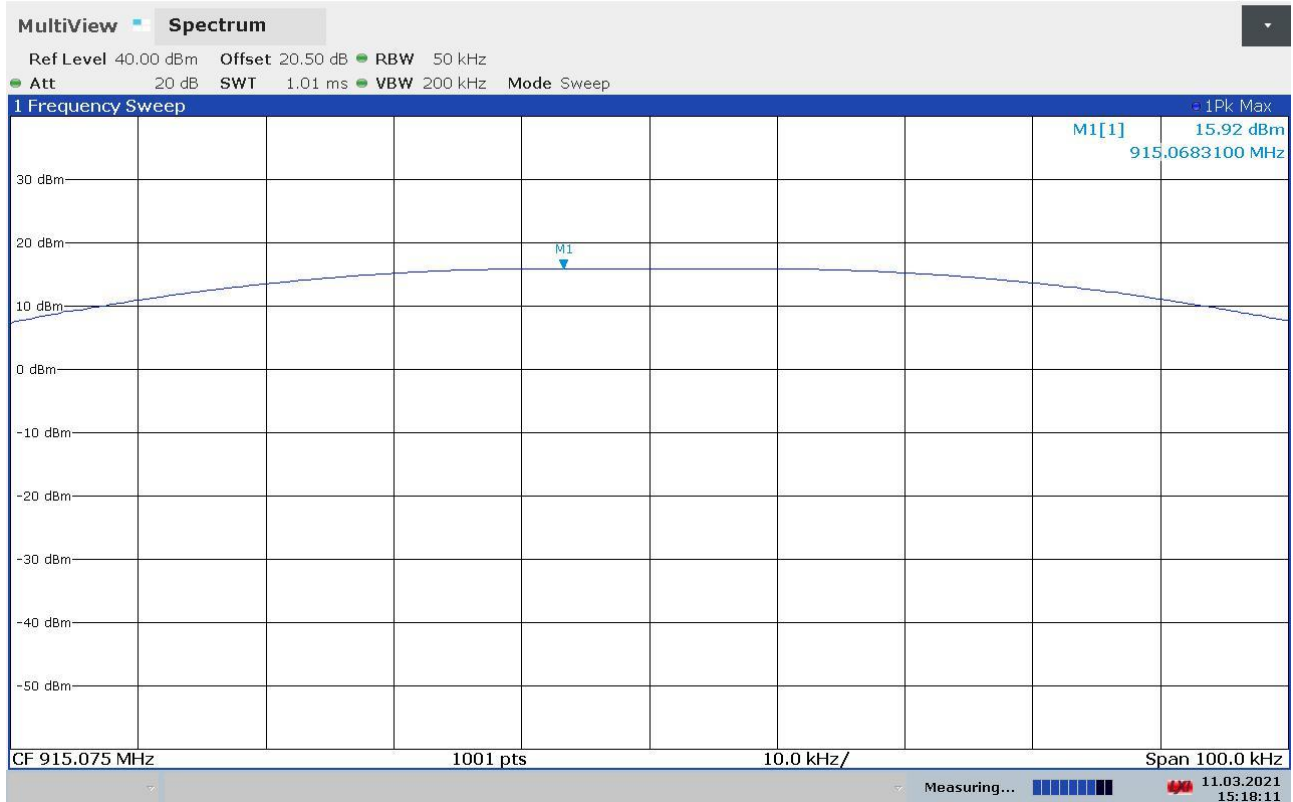

Segalla 21057207

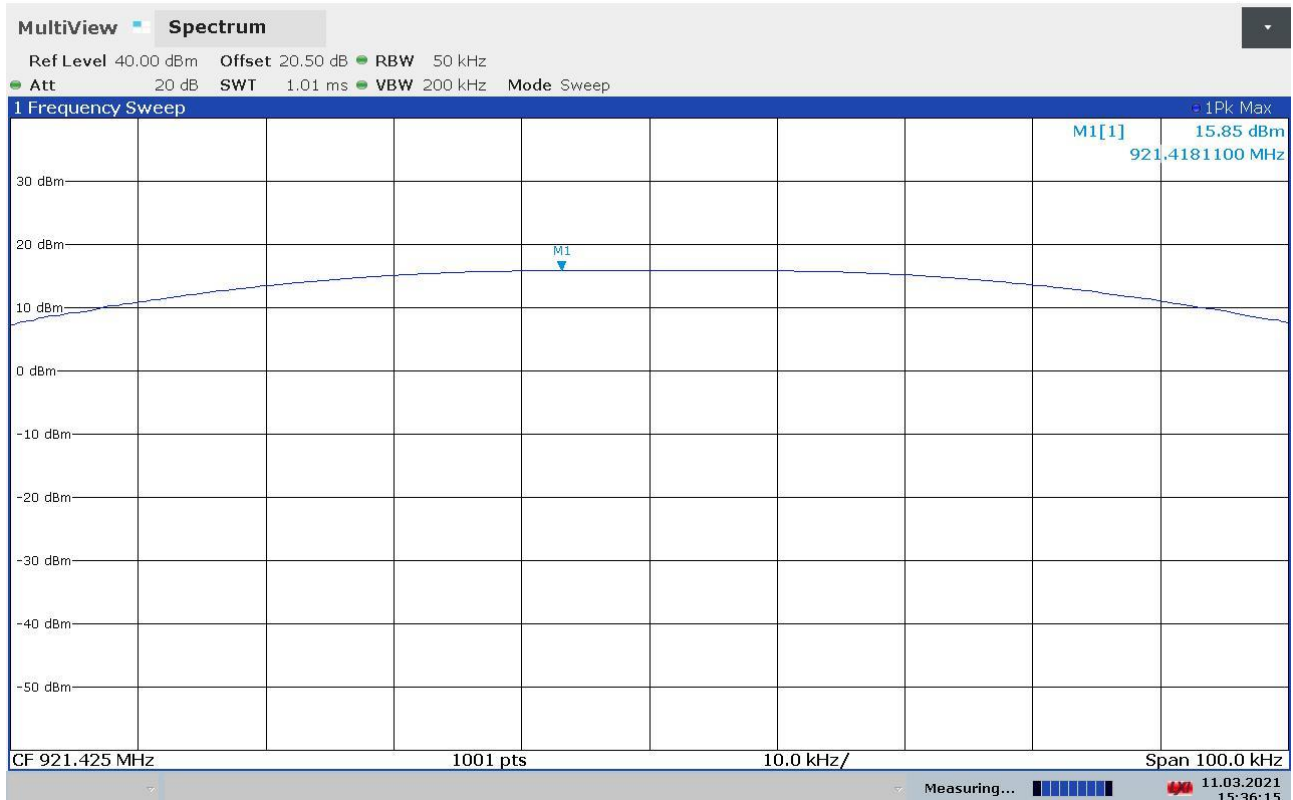



Segalla 21057210

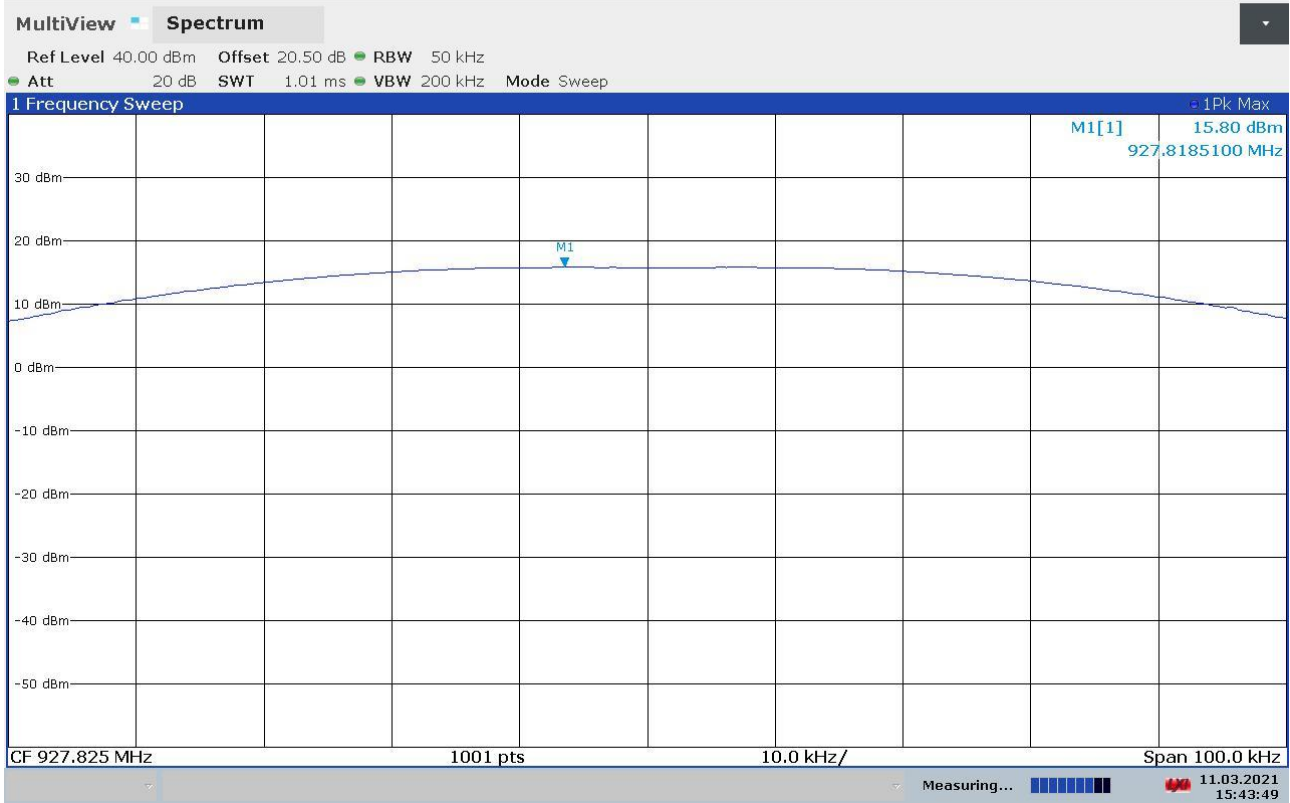

CMC Centro Misure Compatibilità S.r.l.



Attachment 1

Instruments list

<i>Id. number</i>	<i>Manufacturer</i>	<i>Model</i>	<i>Description</i>	<i>Serial number</i>	<i>Last calibration</i>	<i>Due date calibration</i>
CMC S010	Rohde & Schwarz	ESH3-Z2	Impulses Limiting Device	- - -	January '21	January '22
CMC S108	EMCO	3115	Horn Antenna	9811-5622	June '19	June '22
CMC S127	Schaffner	HLA6120	Loop Antenna	1191	November '18	November '23
CMC S200	Schwarzbeck	NSLK 8128	V-LISN	8128-273	January '21	January '22
CMC S206	Rohde & Schwarz	ESCI 7	EMC Receiver 9KHz-7GHz	100781	January '21	January '22
CMC S260	CMC	Wfr_N	Shielded Cable	Wfr_ant10-1	November '20	November '21
CMC S261	CMC	Wfr_N	Shielded Cable	Wfr_ant20-1	November '20	November '21
CMC S262	CMC	Wfr_N_fix	Shielded Cable	Wfr_fix32-1	November '20	November '21
CMC S263	CMC	Wfr_N_fix	Shielded Cable	Wfr_fix31-1	November '20	November '21
CMC S264	CMC	Wfr_N	Shielded Cable	Wfr_ext03-1	November '20	November '21
CMC S271	Schwarzbeck	BBA 9106 + VHBB 9124	Biconical Antenna (30-300MHz)	831	June '19	June '22
CMC S287	Schwarzbeck	VUSLP 9111B	Log-periodic Antenna (200 MHz-3Ghz)	9111B-203	June '19	June '22
CMC S288	CMC	W_sma_white	Joint Shielded Cable	W_001	November '20	November '21
CMC S295	Rohde & Schwarz	FSW43	Spectrum Analyzer 43GHz	104059	November '19	November '22
CMC S353	Rohde & Schwarz	ESW26	Emi Test Receiver 1 Hz - 26.5 GHz	101492	September '20	September '22



Attachment 1

Measurement uncertainty

Test	Test Setup	Expanded uncertainty	Note
Conducted emission CISPR 16 LISN 50uH 0,009-0,0150 MHz	PE001_01	3,4 dB	1
Conducted emission CISPR 16 LISN 50uH 0,150-30,0 MHz	PE001_01	3,0 dB	1
Conducted emission CISPR 16 Voltage Probe 0,15-30 MHz	PE001_02	2,3 dB	1
Conducted emission CISPR 16 Current Probe 0,15-30 MHz	PE001_03	2,6 dB	1
Conducted emission CISPR 16 ISN 0,15-30 MHz	PE001_04	4,7 dB	1
Clic CISPR 16 LISN 50uH 0,150-30,0 MHz	PE001_05	2,9 dB	1
Radiated Emission CDNE 30-300 MHz	PE001_06	3,3 dB	1
Disturbance Power 30-300 MHz	PE002_01	3,8 dB	1
Radiated Emission LAS 0,15-30 MHz	PE003_01	2,0 dB	1
Radiated Emission CISPR 16 Loop Ant. 0,15-30 MHz	PE004_01	4,2 dB	1
Radiated Emission CISPR 16 Bicon. Ant. 30-300 MHz	PE004_02	4,1 dB	1
Radiated Emission CISPR 16 LogP. Ant. 300-1000 MHz	PE004_03	3,9 dB	1
Radiated Emission CISPR 16 Horn Ant. 1-18 GHz	PE004_04	4,1 dB	1
Human Exposure to electromagnetic fields	PE005_01	16,7 %	1
Harmonics	PE006_01	10 mA + 2,9 %	1
Flicker	PE007_01	4,36 %	1
Radiated Immunity 80 MHz - 6 GHz	PE102_XX	2,20 dB 0,87 V/m a 3V/m	1
Conducted Immunity 0,15 - 230 MHz	PE105_XX	1,20 dB 0,44 V a 3V	1
AC Magnetic field	PE106_01	1,55 % 0,15 A/m a 10A/m	1
Pulse Magnetic field	PE107_01	6,23 % 18,7 A/m a 300A/m	1
Dumped Magnetic field	PE108_01	6,23 % 1,87 A/m a 30A/m	1
Common mode conducted immunity	PE112_01	2,16 % 0,22 V a 10V	1



Attachment 1

Test	Test Setup	Expanded uncertainty	Note
Power/Spurious 9kHz-30MHz	PR001_01	4,2 dB	1
Power/Spurious ERP 30-1000MHz d=10m	PR001_02+03	4,7 dB	1
Misura della potenza EIRP 1-18GHz d=3m	PR001_04+05	4,7 dB	1
Misura della potenza EIRP 18-40GHz d=3m	PR001_06	5,4 dB	1
Frequency error	PR002_01+02	< 1x10 ⁻⁷	1
Timing zero span (1001pts.)	PR002_01+02	0,2 % SWT	1
Modulation bandwidth	PR002_01+02	< 1x10 ⁻⁷	1
Conducted RF power and spurious emission	PR002_01+02	1,1 dB	1
Adjacent channel power	PR002_01+02	1,1 dB	1
Blocking	PR002_01+02	1,1 dB	1

Test	Test Setup	Expanded uncertainty	Note
Electrostatic discharge immunity test	PE101_0X		2
Electrical fast transients / burst immunity test	PE103_0X		2
Surge immunity test	PE104_0X		2
Short interruption immunity test	PE109_01		2
Ring Wave immunity test	PE110_01		2
Low frequency immunity test	PE111_01		2
Dumped Oscillatory immunity test	PE113_01		2
Rev_21_01 date 23/02/2021			

Note 1:

The expanded uncertainty reported according to the document EA-4-02 is based on a standard uncertainty multiplied by a coverage factor of k=2, providing a level of confidence of p = 95%



Note 2:

It has been demonstrated that the used test equipment meets the specified requirements in the standard with at least a 95% confidence, covering factor k=2

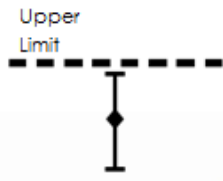

Attachment 1

Judgement of compliance

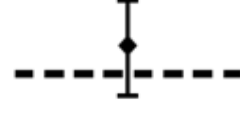
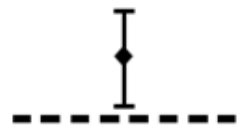
Case 1	Case 2	Case 3	Case 4
 <p>The sample complies with the requirements.</p> <p>The measurement results is within the specification limit when the measurement uncertainty is taken into account.</p>	 <p>The sample complies with the requirements.</p> <p>It is not possible to state compliance using a 95% coverage probability for the expanded uncertainty although the measurement result is below the limit.</p>	 <p>The sample does not comply with the requirements.</p> <p>It is not possible to state compliance using a 95% coverage probability for the expanded uncertainty also the measurement result is upper the limit.</p>	 <p>The sample does not comply with the requirements.</p> <p>The measurement results is outside the specification limit when the measurement uncertainty is taken into account.</p>

In agreement with ILAC-G8:09/2019 cl.4.2.1 Guidelines on Decision Rules and Statements of Conformity

Quality manual references – Internal procedure

Internal Procedure PM001 rev. 3.1 (Quality Manual)	Measure procedure
Internal Procedure INC_M rev. 9.5 (Quality Manual)	Measurement uncertainty calculation

CMC Centro Misure Compatibilità S.r.l.