



FCC Test Report

Report No: FCS202209166W02

Issued for

Applicant:	CAD Audio, LLC
Address:	6573 Cochran Rd., Bldg I, Solon Ohio 44139 USA
Product Name:	UHF Wireless Microphone
Brand Name:	N/A
Model Name:	WX200
Series Model:	N/A
FCC ID:	OQ5-WX200
Issued By: Flux Compliance Service Laboratory Add: Room 105 Floor Bao hao Technology Building 1 NO.15 Gong ye West Road Hi-Tech Industrial, Song shan lake Dongguan Tel: 769-27280901 Fax:769-27280901 http://www.fcs-lab.com	

TEST RESULT CERTIFICATION

Applicant's Name.....: CAD Audio, LLC
Address.....: 6573 Cocharn Rd., Bldg I, Solon Ohio 44139 USA
Manufacture's Name.....: CAD Audio, LLC
Address.....: 6573 Cocharn Rd., Bldg I, Solon Ohio 44139 USA

Product Description

Product Name.....: UHF Wireless Microphone
Brand Name: N/A
Model Name.....: WX200
Series Model.....: N/A
Test Standards.....: FCC Rules and Regulations Part 15 Subpart C section 15.236
Test Procedure.....: ANSI C63.10:2013

This device described above has been tested FCS, the test results show that the equipment under test (EUT) is in compliance with the FCC requirements. And it is applicable only to the tested sample identified in the report.

This report shall not be reproduced except in full, without the written approval of FCS, this document may be altered or revised by FCS, personal only, and shall be noted in the revision of the document..

Date of Test.....:

Date (s) of performance of tests.: 26 Sep, 2022 ~ 10 Oct, 2022

Date of Issue.....: 10 Oct, 2022

Test Result.....: Pass

Tested by : Scott Shen
(Scott Shen)

Reviewed by : Duke Qian
(Duke Qian)

Approved by : Jack Wang
(Jack Wang)

Table of Contents

	Page
1. SUMMARY OF TEST RESULTS	5
1.1 TEST FACTORY	6
1.2 MEASUREMENT UNCERTAINTY	6
2. GENERAL INFORMATION	7
2.1 GENERAL DESCRIPTION OF THE EUT	7
2.2 DESCRIPTION OF THE TEST MODES	8
2.3 DESCRIPTION OF NECESSARY ACCESSORIES AND SUPPORT UNITS	9
2.4 EQUIPMENTS LIST	10
3 MAXIMUM RADIATED POWER	11
3.1 LIMIT	11
3.2 TEST PROCEDURE	11
3.3 TEST SETUP	11
4. OCCUPIED BANDWIDTH	12
4.1 LIMIT	12
4.2 TEST PROCEDURE	12
4.3 TEST SETUP	12
4.4 TEST RESULTS	12
5. NECESSARY BANDWITH	15
5.1 LIMIT	15
5.2 TEST PROCEDURE	15
5.3 TEST SETUP	15
6. TRANSMITTER UNWANTED EMISSIONS	18
6.1 LIMIT	18
5.2 TEST PROCEDURE	18
5.3 TEST SETUP	18
6.4 TEST RESULTS	19
7. FREQUENCY STABILITY	26
7.1 LIMIT	26
7.2 TEST PROCEDURE	26
7.3 TEST SETUP	26
7.4 TEST RESULTS	27

Revision History

Rev.	Issue Date	Effect Page	Contents
00	10 Oct, 2022	All	Initial Issue

1. SUMMARY OF TEST RESULTS

FCC Part 15 Subpart C section 15.236			
Standard Section	Test Item	Judgment	Remark
FCC Part 15.236(d)	Maximum Radiated Power	PASS	--
FCC Part 15.236(f)(2)	Occupied Bandwidth	PASS	--
FCC Part 15.236(g)	Necessary bandwidth	PASS	--
FCC Part 15.236(f)(3)	Frequency stability	PASS	--
FCC Part 15.236(g)	Emission within the band and outside this band	PASS	--
FCC Part 207(a)	Conducted Emission	NA	--

NOTE:

- (1) "N/A" denotes test is not applicable in this Test Report
- (2) All tests are according to ANSI C63.10:2013

1.1 TEST FACTORY

Company Name:	Flux Compliance Service Laboratory
Address:	Room 105 Floor Bao hao Technology Building 1 NO.15 Gong ye West Road Hi-Tech Industrial, Song shan lake Dongguan
Telephone:	+86-769-27280901
Fax:	+86-769-27280901
FCC Test Firm Registration Number: 514908 Designation number: CN0127 A2LA accreditation number: 5545.01	

1.2 MEASUREMENT UNCERTAINTY

The reported uncertainty of measurement $y \pm U$, where expanded uncertainty U is based on a standard uncertainty multiplied by a coverage factor of $k=2$, providing a level of confidence of approximately **95 %**.

No.	Item	Uncertainty
1	RF output power, conducted	± 0.71 dB
2	Unwanted Emissions, conducted	± 2.98 dB
3	Occupied bandwidth	4(%)
4	Conducted Emission (9KHz-150KHz)	± 4.13 dB
5	Conducted Emission (150KHz-30MHz)	± 4.74 dB
6	All emissions,radiated(<1G) 9KHz-30MHz	± 3.1 dB
7	All emissions,radiated(<1G) 30MHz-1000MHz	± 3.2 dB
8	All emissions,radiated (1GHz -18GHz)	± 3.66 dB
9	All emissions,radiated (18GHz -40GHz)	± 4.31 dB

2. GENERAL INFORMATION

2.1 GENERAL DESCRIPTION OF THE EUT

Product Name	UHF Wireless Microphone
Brand Name	N/A
Model Name	WX200
Series Model	N/A
Model Difference	N/A
Channel List	Please refer to the Note 2.
Operation frequency	563.1- 565.2 MHz
Modulation Type	FM
Antenna Type	Spring antenna
Antenna Gain (dBi)	-2.71
Power Supply	DC 3V
Battery	DC 1.5V×2
Hardware version number	V1.0
Software version number	V1.0
Connecting I/O Port(s)	Please refer to the User's Manual

Note:

1. For a more detailed features description, please refer to the manufacturer's specifications or the User's Manual.

2. Channel List

Channel					
Channel	Frequency (MHz)	Channel	Frequency (MHz)	Channel	Frequency (MHz)
01	563.1	09	563.9	17	564.7
02	563.2	10	564.0	18	564.8
03	563.3	11	564.1	19	564.9
04	563.4	12	564.2	20	565.0
05	563.5	13	564.3	21	565.1
06	563.6	14	564.4	22	565.2
07	563.7	15	564.5		
08	563.8	16	564.6		

Ant.	Atnenna Brand	Antenna Model Name	Antenna Type	Connector	Gain (dBi)	EIRP(dBm)	NOTE
1	N/A	N/A	Spring antenna	N/A	-2.71	7.83	Antenna

2.2 DESCRIPTION OF THE TEST MODES

To investigate the maximum EMI emission characteristics generates from EUT, the test system was pre-scanning tested base on the consideration of following EUT operation mode or test configuration mode which possible have effect on EMI emission level. Each of these EUT operation mode(s) or test configuration mode(s) mentioned above was evaluated respectively.

Test software:FCC tools

The test software was used to control EUT work in continuous TX mode, and select test channel, Wireless mode as below table, the following operating modes were applied for the related test items. All test modes were tested, only the result of the worst case was recorded in the report.

Tested mode, channel , information		
Mode	Channel	Frequency (MHz)
Channel A	CH 01	563.1
	CH 11	564.1
	CH 22	565.2

Note: that use new battery during the test

2.3 DESCRIPTION OF NECESSARY ACCESSORIES AND SUPPORT UNITS

The EUT has been tested as an independent unit together with other necessary accessories or support units. The following support units or accessories were used to form a representative test configuration during the tests.

Necessary accessories

Item	Equipment	Mfr/Brand	Model/Type No.	Serial No.	Note

Support units

Item	Equipment	Mfr/Brand	Model/Type No.	Serial No.	Note

Note:

- (1) The support equipment was authorized by Declaration of Confirmation.
- (2) For detachable type I/O cable should be specified the length in cm in 『Length』 column.
- (3) “YES” is means “shielded” “with core”; “NO” is means “unshielded” “without core”.

2.4 EQUIPMENTS LIST

Radiation Test equipment

Kind of Equipment	Manufacturer	Type No.	Company No.	Last calibration	Calibrated until
EMI Test Receiver	R&S	ESRP 3	FCS-E001	2022.01.27	2023.01.26
Signal Analyzer	R&S	FSV40-N	FCS-E012	2022.01.27	2023.01.26
Active loop Antenna	ZHINAN	ZN30900C	FCS-E013	2022.01.27	2023.01.26
Bilog Antenna	SCHWARZBECK	VULB 9168	FCS-E002	2022.01.27	2023.01.26
Horn Antenna	SCHWARZBECK	BBHA 9120D	FCS-E003	2022.01.27	2023.01.26
SHF-EHF Horn Antenna (18G-40GHz)	A-INFO	LB-180400-KF	FCS-E018	2022.01.27	2023.01.26
Pre-Amplifier(0.1M-3G Hz)	EMCI	EM330N	FCS-E004	2022.01.27	2023.01.26
Pre-Amplifier (1G-18GHz)	N/A	TSAMP-0518SE	FCS-E014	2022.01.27	2023.01.26
Pre-Amplifier (18G-40GHz)	TERA-MW	TRLA-0400	FCS-E019	2022.01.27	2023.01.26
Temperature & Humidity	HTC-1	victor	FCS-E005	2022.01.27	2023.01.26
Signal generator	Agilent	E4421B	FCS-E025	2022.01.27	2023.01.26

Conduction Test equipment

Kind of Equipment	Manufacturer	Type No.	Company No.	Last calibration	Calibrated until
EMI Test Receiver	R&S	ESPI	FCS-E020	2022.01.27	2023.01.26
LISN	R&S	ENV216	FCS-E007	2022.01.27	2023.01.26
LISN	ETS	3810/2NM	FCS-E009	2022.01.27	2023.01.26
Temperature & Humidity	HTC-1	victor	FCS-E008	2022.01.27	2023.01.26

RF Connected Test

Kind of Equipment	Manufacturer	Type No.	Company No.	Last calibration	Calibrated until
Spectrum Analyzer	Keysight	N9020A	FCS-E015	2022.01.27	2023.01.26
Spectrum Analyzer	Agilent	E4447A	MY50180039	2022.01.27	2023.01.26
Spectrum Analyzer	R&S	FSV-40	101499	2022.01.27	2023.01.26
Audio Analyzer	R&S	UPL	FCS-E39	2022.01.27	2023.01.26

3 MAXIMUM RADIATED POWER

3.1 LIMIT

Refer to FCC 15.236(d)

In the bands allocated and assigned for broadcast television and in the 600 MHz service band: 50 mW EIRP

3.2 TEST PROCEDURE

A · Connect each EUT's antenna output to power sensor by RF cable and attenuator

3.3 TEST SETUP



3.4 TEST RESULTS

Test mode	Channel	Frequency (MHz)	Peak Output Power (dBm)	Antenna Gain (dBi)	EIRP(dBm)	Limit(dBm)	Verdict
Channel	01	563.1	10.12	-2.71	7.41	16.99	PASS
	11	564.1	10.26	-2.71	7.55		
	22	565.2	10.54	-2.71	7.83		

note: Cable Loss has been included in peak output power

4. OCCUPIED BANDWIDTH

4.1 LIMIT

One or more adjacent 25KHz segments within the assignable frequencies may be combined to form a channel whose maximum bandwidth shall not exceed 200 kHz. The operating bandwidth shall not exceed 200 kHz

4.2 TEST PROCEDURE

Parameter	Setting
Detector	Peak/AV
Sweep time	Auto
Resolution bandwidth	1 % to 5 % of the occupied bandwidth
Video bandwidth:	3 x resolution bandwidth
Span:	2 x emission bandwidth
Trace mode:	Max. hold
Analyzer function:	99% power occupied bandwidth function
EUT:	Modulated signal with max(FM,2.5kHz tone). frequency deviation

4.3 TEST SETUP

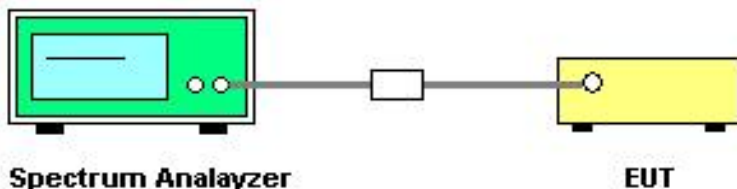

4.4 TEST RESULTS

Test mode	Channel	Frequency (MHz)	20dB Bandwidth (KHz)	Limt(KHz)	Verdict
Channel	01	563.1	101.1KHz	200KHz	PASS
	11	564.1	100.4KHz		
	22	565.2	100.8KHz		

Low



Middle



High



5. NECESSARY BANDWIDTH

5.1 LIMIT

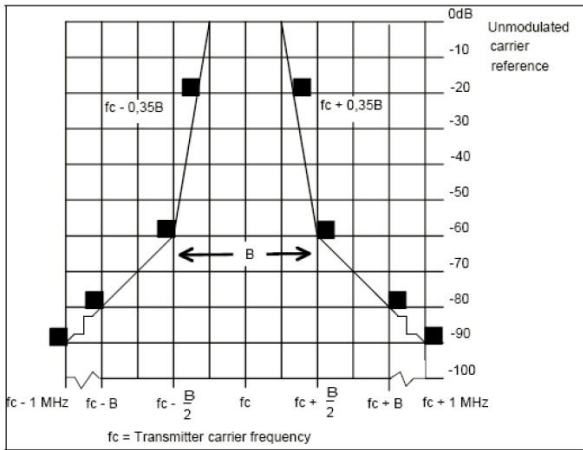
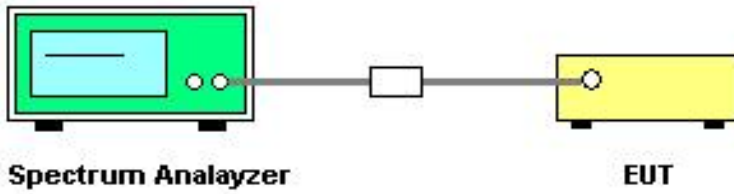

Figure 1: Spectrum mask for analogue systems in all bands

5.2 TEST PROCEDURE

EN300422-1 V1.4.2 Clause 8.3.

5.3 TEST SETUP



5.4 TEST RESULT

Low

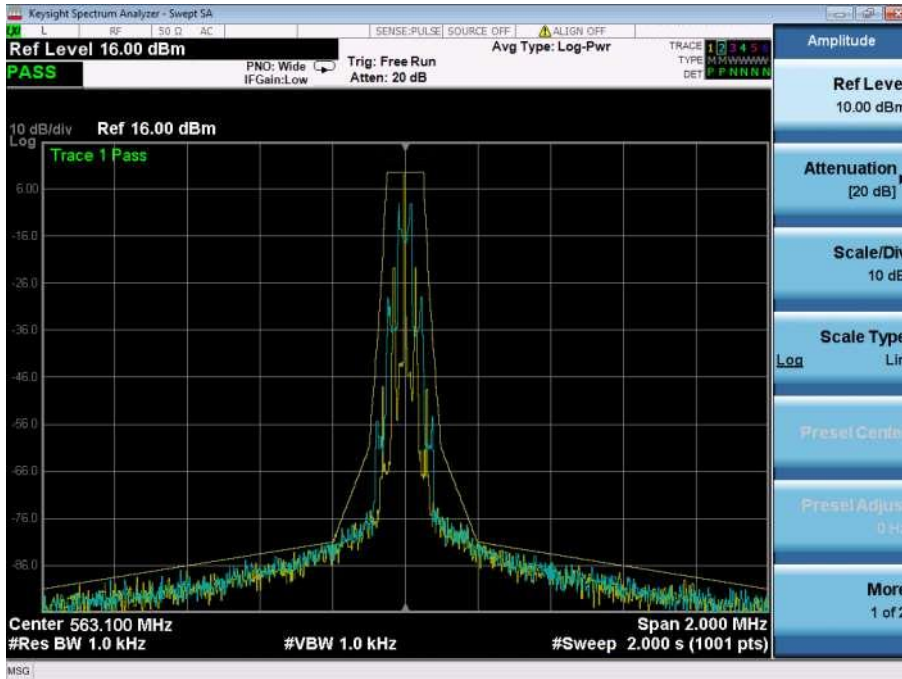

Middle

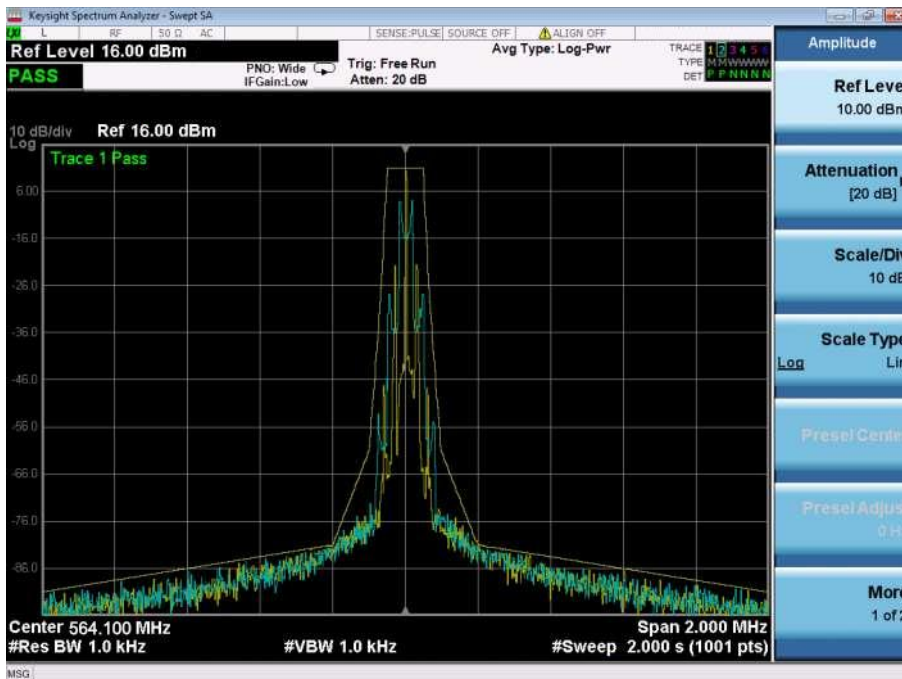

High

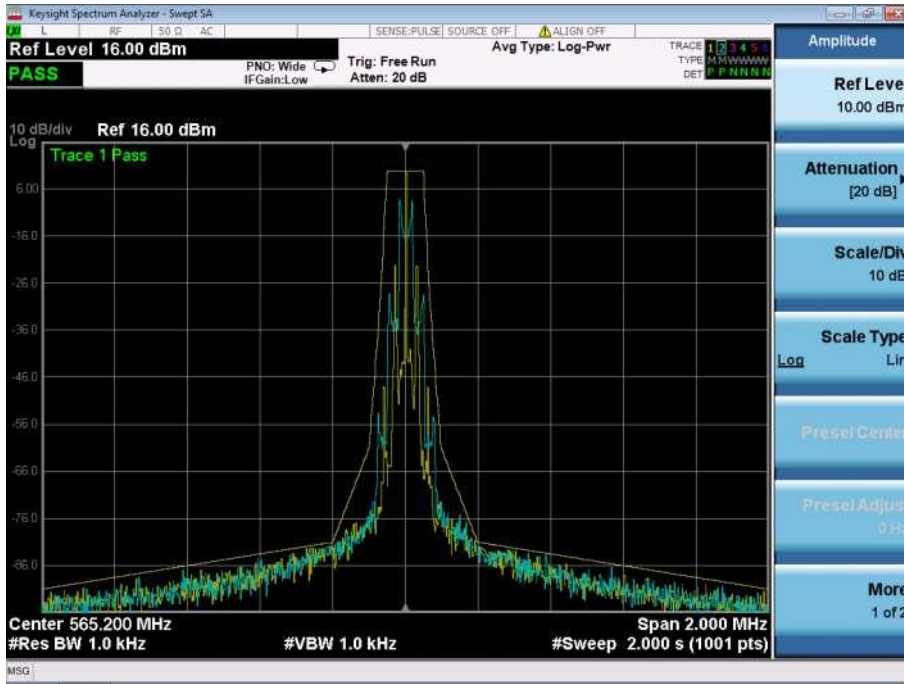

6. TRANSMITTER UNWANTED EMISSIONS

6.1 LIMIT

Spurious emissions are emissions outside the frequency range(s) of the equipment. The power of the spurious emissions shall not exceed the limits of table as below:

State	Frequency		
	47MHz to 74MHz, 87.5MHz to 137MHz 174MHz to 230MHz, 470MHz to 862MHz	Other Frequencies below 1000MHz	Frequencies above 1000MHz
Operation	4nW	250nW	1uW
Standby	2nW	2nW	20nW

5.2 TEST PROCEDURE

1. The transmitter output was connected to the spectrum analyzer through an attenuator. Set spectrum analyzer start 30MHz to 6000MHz with 100 KHz RBW and 300 KHz VBW
2. Please refer to ETSI EN 300 422-1 V1.4.2 (2011-08) clause 6.1 for the test conditions.
3. Please refer to ETSI EN 300 422-1 V1.4.2 (2011-08) clause 8.4.2 for the measurement method.

5.3 TEST SETUP

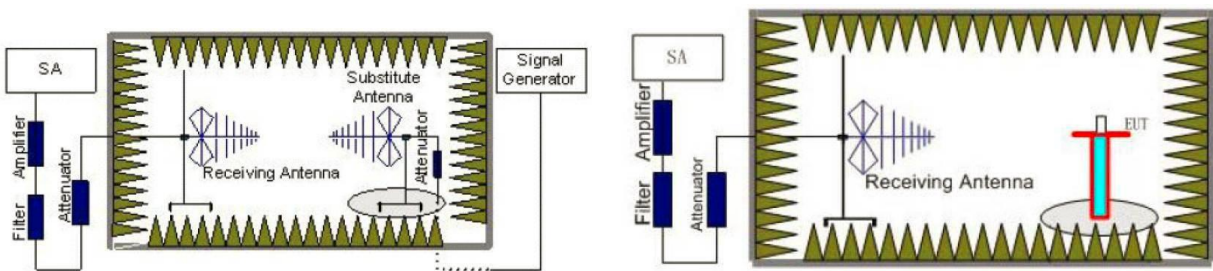

6.4 TEST RESULTS

LOW CH-30MHZ-1000MHZ

Vertical

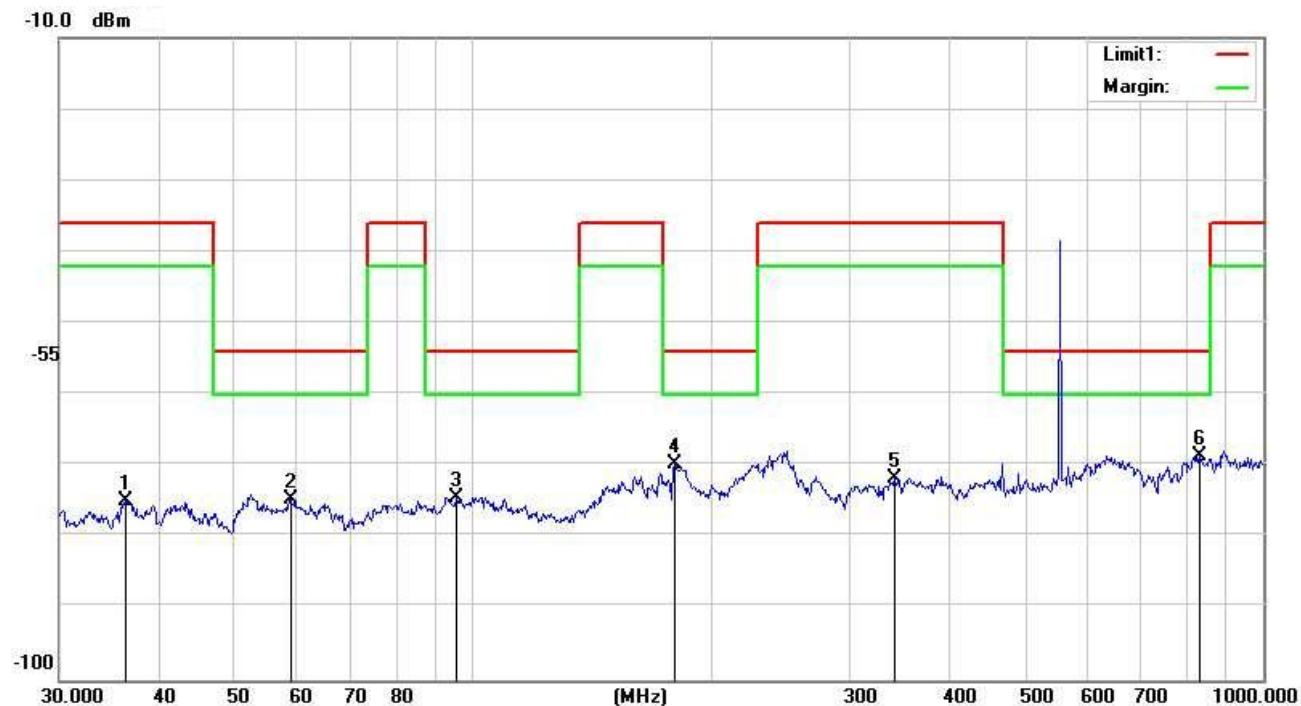

No.	Frequency (MHz)	Reading (dBm)	Correction (dB)	Result (dBm)	Limit (dBm)	Margin (dB)	Remark
1	36.3813	-58.51	-16.50	-75.01	-36.00	-39.01	peak
2	58.8185	-57.68	-16.91	-74.59	-54.00	-20.59	peak
3	95.4270	-55.32	-19.09	-74.41	-54.00	-20.41	peak
4	180.0165	-50.26	-19.44	-69.70	-54.00	-15.70	peak
5	341.9786	-58.92	-12.78	-71.70	-36.00	-35.70	peak
6	830.4002	-64.38	-4.26	-68.64	-54.00	-14.64	peak

Horizontal

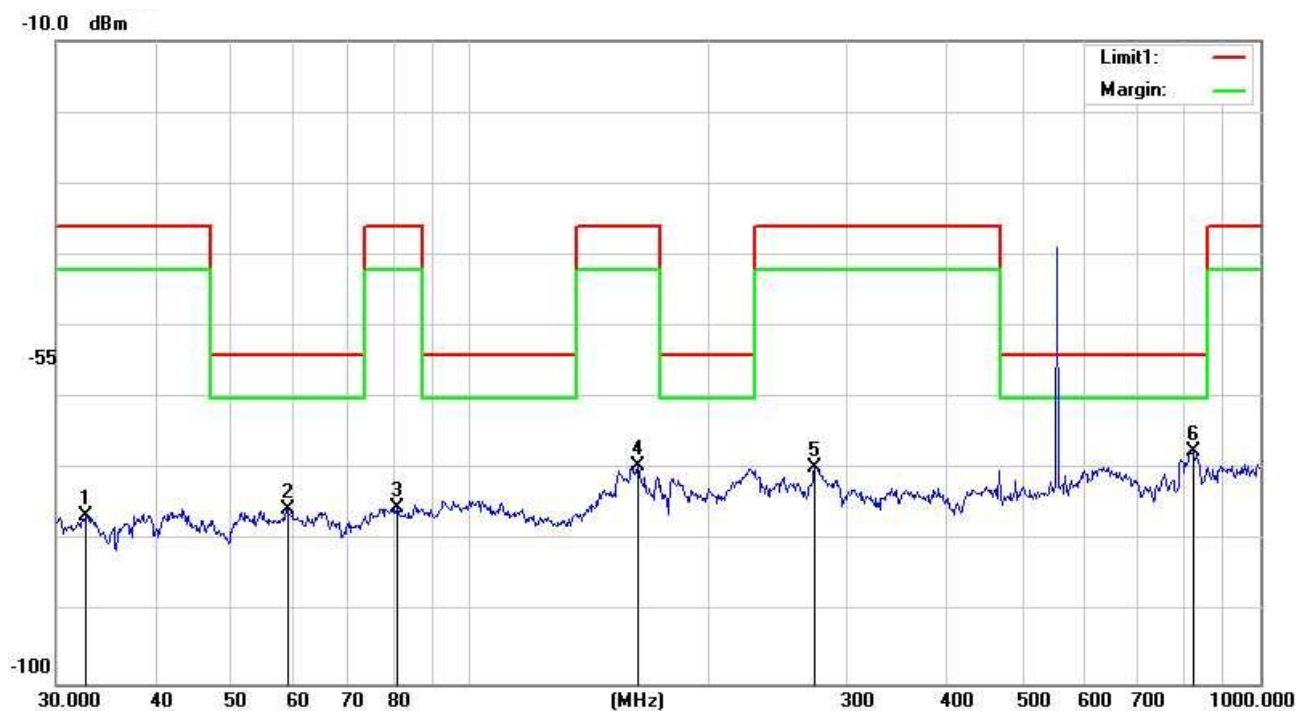

No.	Frequency (MHz)	Reading (dBm)	Correction (dB)	Result (dBm)	Limit (dBm)	Margin (dB)	Remark
1	32.6340	-61.77	-14.74	-76.51	-36.00	-40.51	peak
2	58.8185	-58.68	-16.91	-75.59	-54.00	-21.59	peak
3	80.9274	-53.68	-21.76	-75.44	-36.00	-39.44	peak
4	163.1818	-50.77	-18.68	-69.45	-36.00	-33.45	peak
5	273.2341	-55.11	-14.55	-69.66	-36.00	-33.66	peak
6	821.7104	-62.95	-4.46	-67.41	-54.00	-13.41	peak

Note :

1. Result = Reading + Corrected Factor Note :

MIDDLE CH-30MHZ-1000MHZ

Vertical

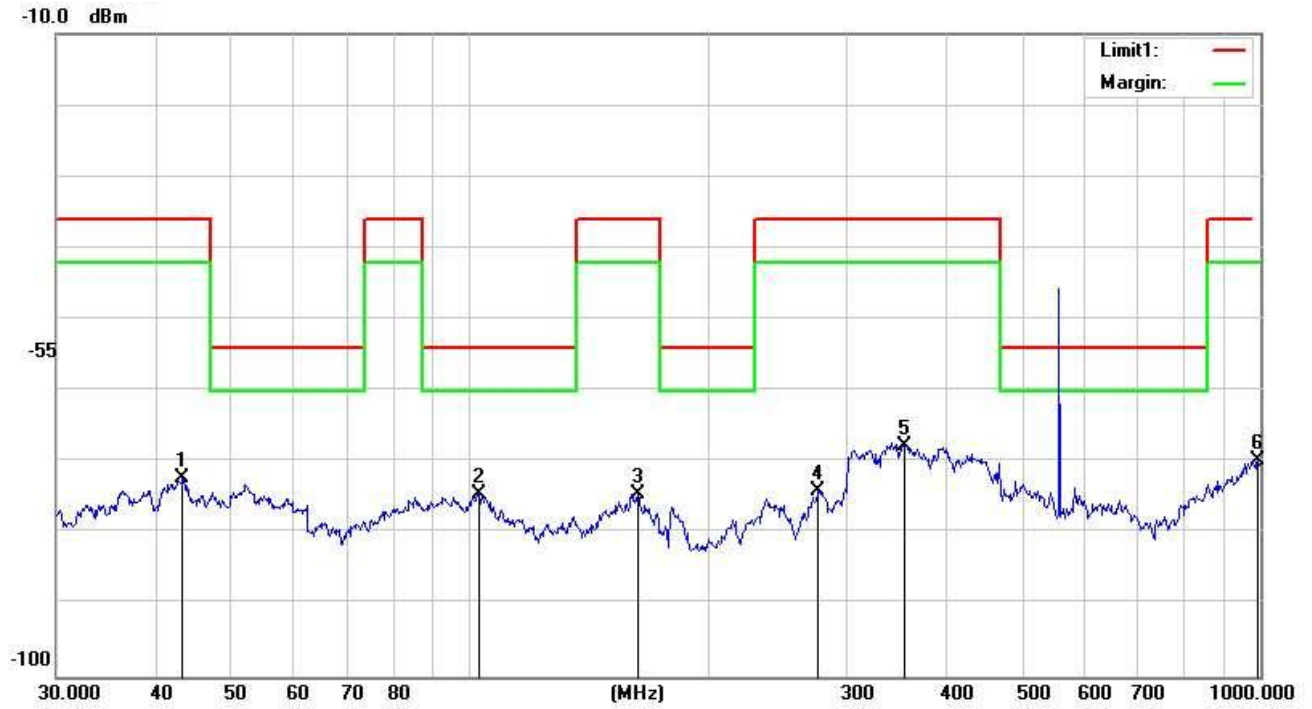

No.	Frequency (MHz)	Reading (dBm)	Correction (dB)	Result (dBm)	Limit (dBm)	Margin (dB)	Remark
1	43.3534	-55.20	-16.92	-72.12	-36.00	-36.12	peak
2	102.7192	-56.84	-17.58	-74.42	-54.00	-20.42	peak
3	163.1818	-55.77	-18.68	-74.45	-36.00	-38.45	peak
4	276.1235	-59.64	-14.47	-74.11	-36.00	-38.11	peak
5	355.4273	-55.02	-12.64	-67.66	-36.00	-31.66	peak
6	993.0113	-67.95	-1.87	-69.82	-36.00	-33.82	peak

Horizontal

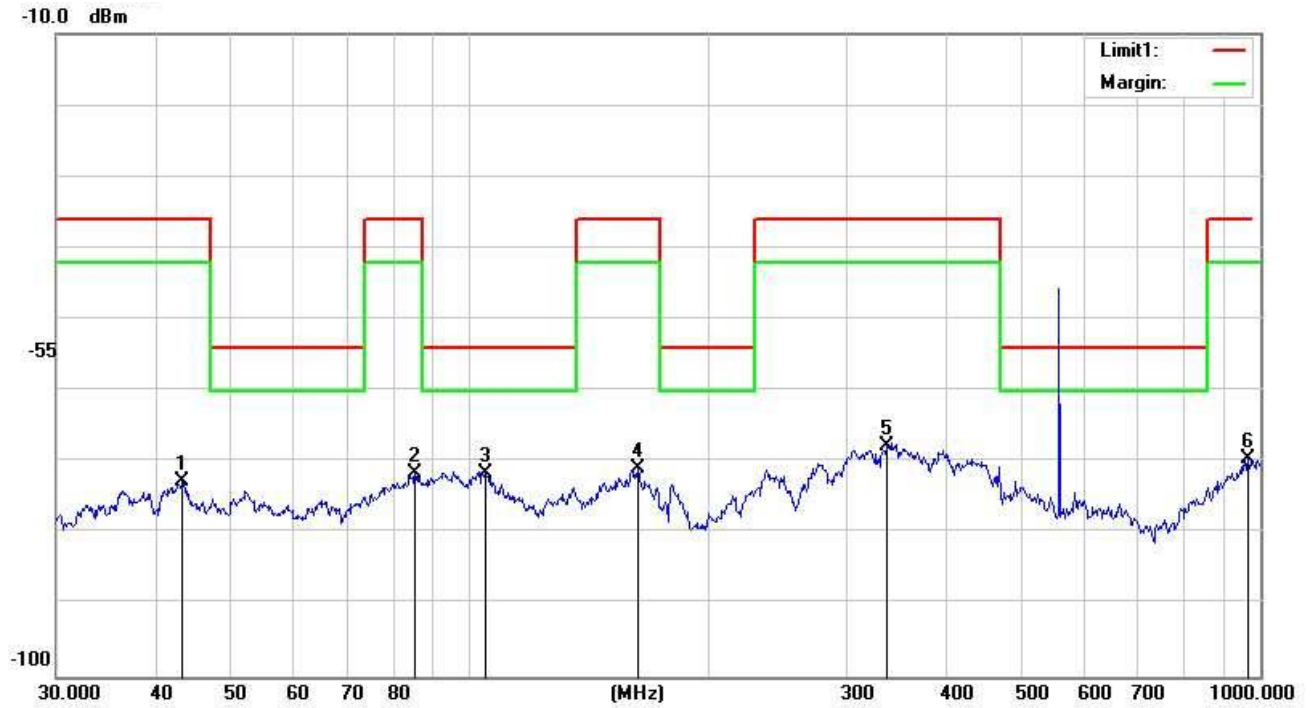

No.	Frequency (MHz)	Reading (dBm)	Correction (dB)	Result (dBm)	Limit (dBm)	Margin (dB)	Remark
1	43.3534	-55.70	-16.92	-72.62	-36.00	-36.62	peak
2	85.2980	-50.53	-20.98	-71.51	-36.00	-35.51	peak
3	104.9033	-54.10	-17.34	-71.44	-54.00	-17.44	peak
4	163.1818	-52.27	-18.68	-70.95	-36.00	-34.95	peak
5	337.2155	-54.91	-12.88	-67.79	-36.00	-31.79	peak
6	965.5421	-67.29	-2.32	-69.61	-36.00	-33.61	peak

Note :

1. Result = Reading + Corrected Factor Note :

HIGH CH-30MHZ-1000MHZ

Vertical

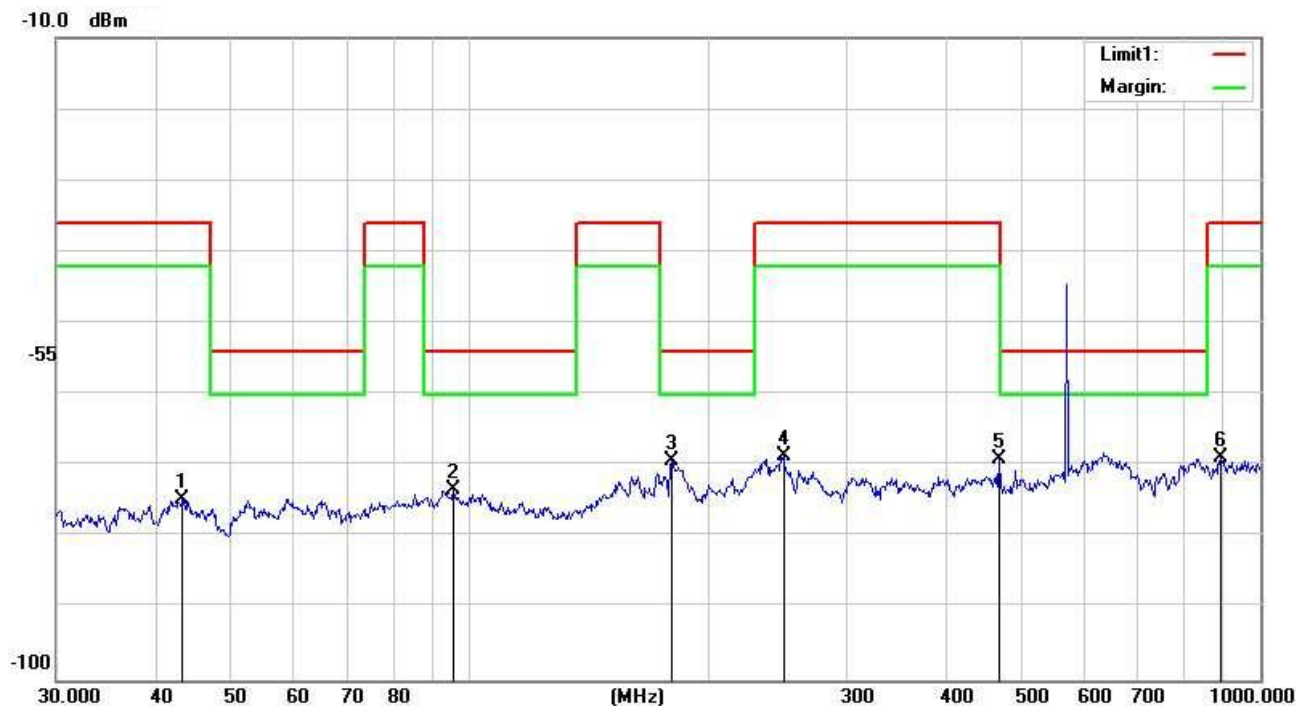

No.	Frequency (MHz)	Reading (dBm)	Correction (dB)	Result (dBm)	Limit (dBm)	Margin (dB)	Remark
1	43.3534	-54.20	-16.92	-71.12	-36.00	-35.12	peak
2	65.1145	-56.58	-19.38	-75.96	-54.00	-21.96	peak
3	172.5988	-52.94	-19.12	-72.06	-36.00	-36.06	peak
4	251.1802	-58.55	-15.24	-73.79	-36.00	-37.79	peak
5	346.8091	-61.30	-12.67	-73.97	-36.00	-37.97	peak
6	919.2866	-67.41	-3.05	-70.46	-36.00	-34.46	peak

Horizontal

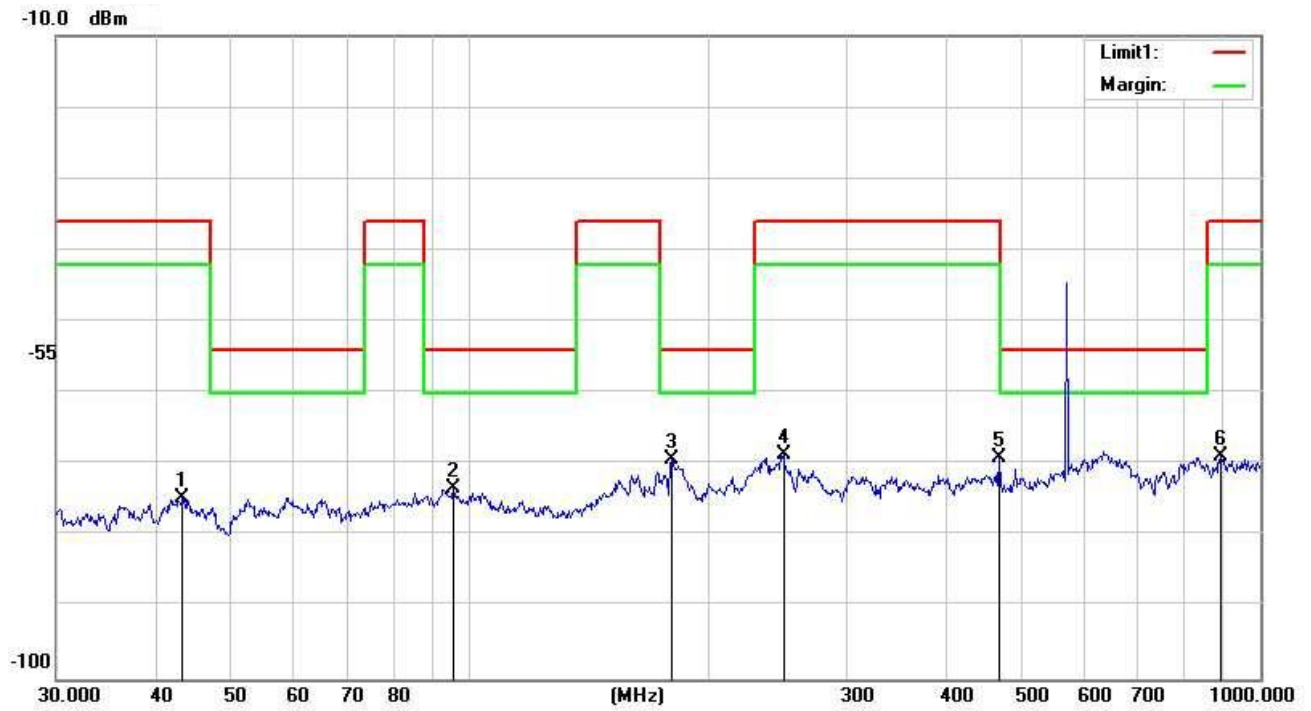

No.	Frequency (MHz)	Reading (dBm)	Correction (dB)	Result (dBm)	Limit (dBm)	Margin (dB)	Remark
1	43.3211	-57.70	-16.92	-74.62	-36.00	-38.62	peak
2	95.4270	-54.32	-19.09	-73.41	-54.00	-19.41	peak
3	180.0165	-49.76	-19.44	-69.20	-54.00	-15.20	peak
4	249.4250	-53.22	-15.28	-68.50	-36.00	-32.50	peak
5	467.2348	-58.53	-10.60	-69.13	-36.00	-33.13	peak
6	890.7278	-65.47	-3.43	-68.90	-36.00	-32.90	peak

Note :

1. Result = Reading + Corrected Factor Note :

CHANNEL 1GHZ-6GHZ

Frequency (MHz)	Reading (dBm)	Correct dB	Result (dBm)	Limit (dBm)	Margin (dB)	Polar H/V
Channel Low -563.1MHz						
1126.20	-49.65	7.92	-41.73	-30	-11.73	H
1689.30	-52.36	13.97	-38.39	-30	-8.39	H
5631.00	-58.25	14.21	-44.04	-30	-14.04	H
1126.20	-48.27	7.92	-40.35	-30	-10.35	V
1689.30	-47.69	13.64	-34.05	-30	-4.05	V
5631.00	-56.35	14.23	-42.12	-30	-12.12	V
Channel Middle -564.1MHz						
1128.20	-53.68	8.27	-45.41	-30	-15.41	H
1692.30	-52.11	13.73	-38.38	-30	-8.38	H
5641.00	-56.65	14.15	-42.50	-30	-12.50	H
1128.20	-50.36	8.27	-42.09	-30	-12.09	V
1692.30	-49.25	13.73	-35.52	-30	-5.52	V
5641.00	-53.38	14.18	-39.20	-30	-9.20	V
Channel High -565.2MHz						
1130.40	-54.78	8.19	-46.59	-30	-16.59	H
1695.60	-54.02	13.52	-40.05	-30	-10.05	H
5652.00	-55.68	14.16	-41.52	-30	-11.52	H
1130.40	-52.34	8.19	-44.15	-30	-14.15	V
1695.60	-50.11	13.52	-36.59	-30	-6.59	V
5652.00	-56.25	14.14	-42.11	-30	-12.11	V

7. FREQUENCY STABILITY

7.1 LIMIT

The frequency tolerance of the carrier signal shall be maintained within $\pm 0.005\%$ of the operating frequency over a temperature variation of -20 degrees to $+50$ degrees C at normal supply voltage, and for a variation in the primary supply voltage from 85% to 115% of the rated supply voltage at a temperature of 20 degrees C

7.2 TEST PROCEDURE

a. The EUT was connected to an external DC power supply and the RF output was connected to a frequency counter via feed through attenuators. The EUT was placed inside the temperature chamber. The DC leads and the RF output cable, exited the chamber through an opening made for that purpose.

After the temperature stabilized the frequency output was recorded from the counter. An external variable DC power supply was connected to the battery terminals of the equipment under test.

b. For hand carried, battery powered equipment primary supply voltage was reduced to the battery operating end point as specified by the manufacturer. The output frequency was recorded for each battery voltage.

7.3 TEST SETUP

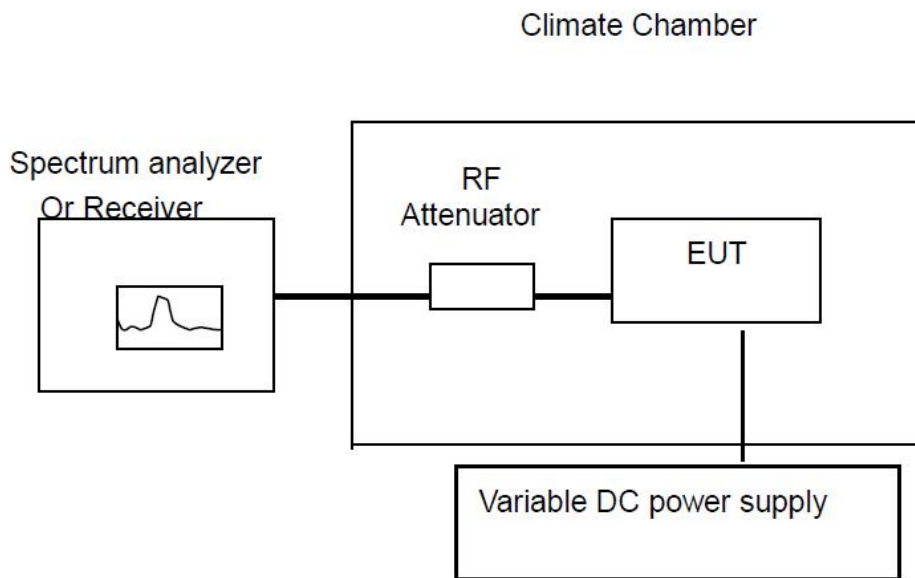

7.4 TEST RESULTS

- (1) Frequency stability versus input voltage (Supply Nominal voltage is DC 3V)
- (2) Frequency stability versus input voltage (Supply battery operating end point which shall be specified by the manufacturer DC 2.55V)

Refernce Frequency: 563.1MHz			
Power supply	Environment Temperature(°C)	Frequency Error (Hz)	Frequency Error (ppm)
DC 2.55V	20	3349	5.95
DC 3V	20	3334	5.92
DC 3.45V	20	3350	5.95

Refernce Frequency: 563.1MHz				
Frequency Deviation measured with time Elapse(30 minutes)				
Environment Temperature(°C)	Frequency Error (Hz)	Frequency Error (ppm)	Limit (ppm)	Results
50	3354	5.96	50	Pass
40	3354	5.96		
30	3347	5.94		
20	3344	5.94		
10	3344	5.94		
0	3332	5.92		
-10	3321	5.90		
-20	3322	5.90		

Reference Frequency: 564.1MHz			
Power supply	Environment Temperature(°C)	Frequency Error (Hz)	Frequency Error (ppm)
DC 2.55V	20	3283	5.82
DC 3V	20	3296	5.84
DC 3.45V	20	3285	5.82

Reference Frequency: 564.1MHz				
Frequency Deviation measured with time Elapse(30 minutes)				
Environment Temperature(°C)	Frequency Error (Hz)	Frequency Error (ppm)	Limit (ppm)	Results
50	3284	5.82	50	Pass
40	3283	5.82		
30	3291	5.83		
20	3291	5.83		
10	3291	5.83		
0	3281	5.82		
-10	3286	5.83		
-20	3282	5.82		

Reference Frequency: 565.2MHz			
Power supply	Environment Temperature(°C)	Frequency Error (Hz)	Frequency Error (ppm)
DC 2.55V	20	3120	5.52
DC 3V	20	3137	5.55
DC 3.45V	20	3129	5.54

Reference Frequency: 565.2MHz				
Frequency Deviation measured with time Elapse(30 minutes)				
Environment Temperature(°C)	Frequency Error (Hz)	Frequency Error (ppm)	Limit (ppm)	Results
50	3129	5.54	50	Pass
40	3125	5.53		
30	3123	5.53		
20	3127	5.53		
10	3127	5.53		
0	3120	5.52		
-10	3122	5.52		
-20	3123	5.53		

*****END OF THE REPORT*****