



# Operation Instruction Manual

## VRCP-65



# Content

1. Appearance -----	3
2. Wiring Connection -----	4
3. Front panel description -----	5
4. Main Menu -----	6
5. Settings -----	7
6. Apple CarPlay -----	13
7. Radio -----	14
8. SiriusXM <sup>®</sup> Operation -----	15
9. DISC -----	21
10. USB -----	24
11. BT Audio -----	26
12. BT Phone -----	28
13. Aux IN -----	31
14. Rear Camera -----	32
15. E-Link -----	33
16. Remote Control -----	34
17. Specification -----	36

Sirius, XM and all marks and logos are trademarks of Sirius XM Radio Inc. All rights reserved.

# 1. Appearance

## Main Menu



## CarPlay Menu

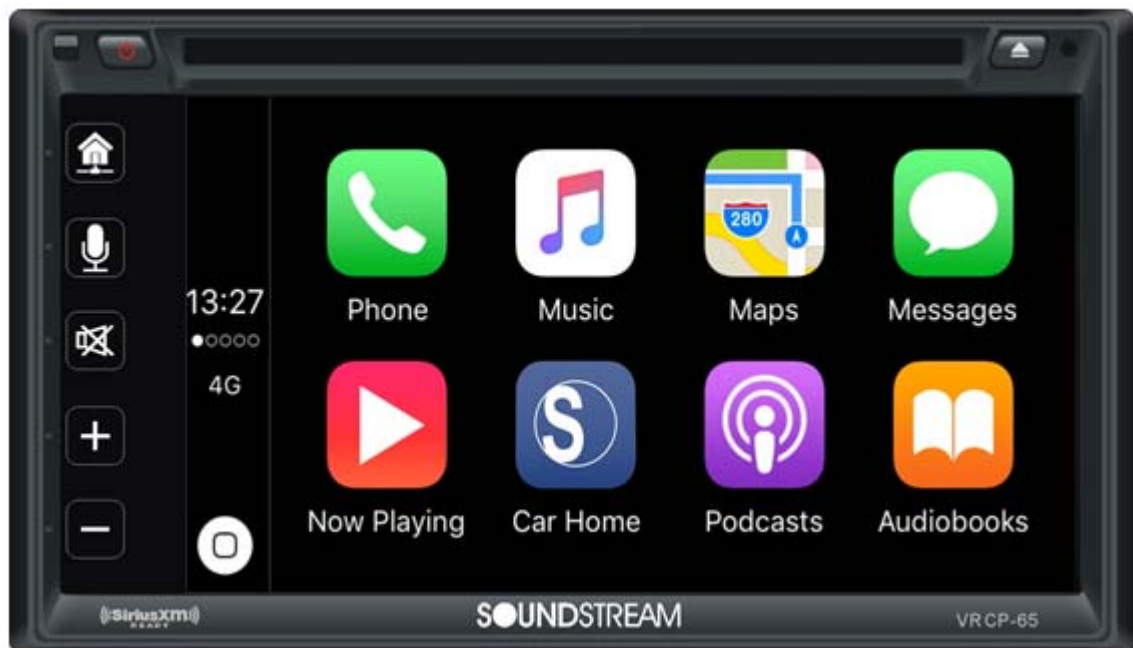

## 2. WIRING CONNECTION

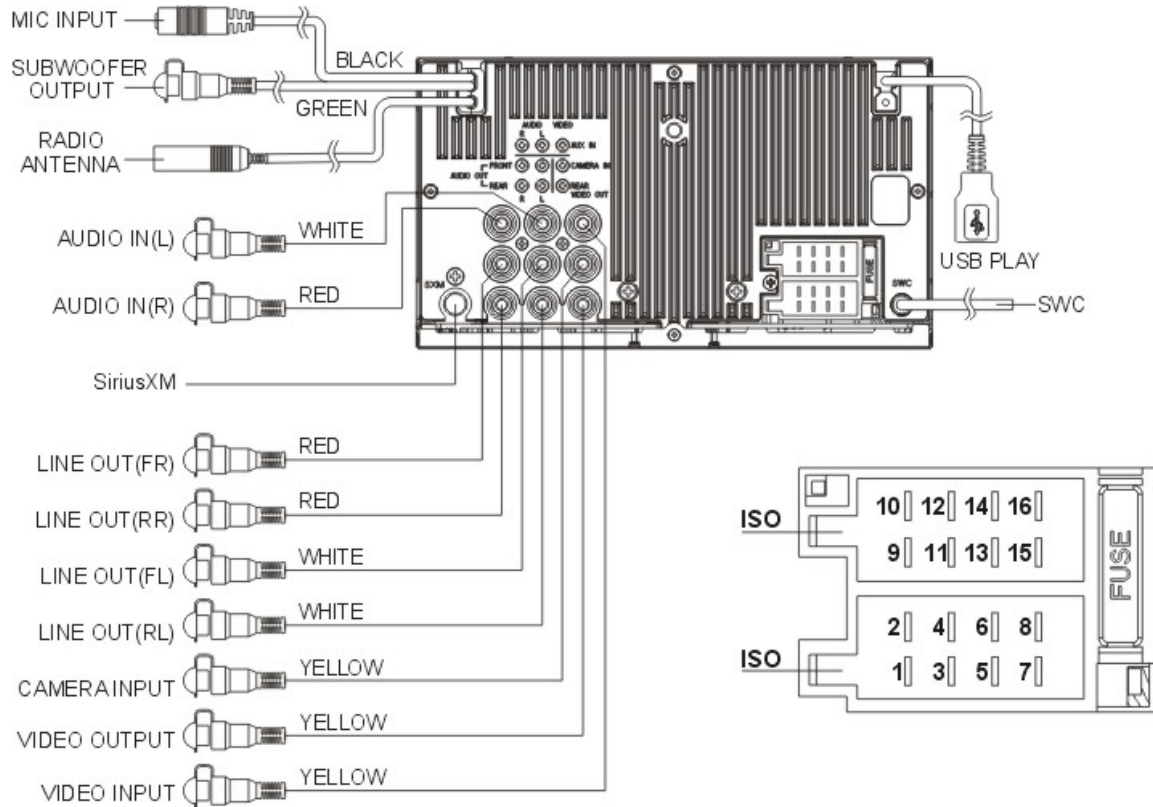

PIN NO.	WIRE COLOR	DESCRIPTION
1	PINK	REVERSE
2	NO CONNECTION	NO CONNECTION
3	YELLOW	+12V BATT
4	BROWN	PARKING
5	ORANGE	DIMMER
6	BLUE	POWER ANTENNA
7	BLACK	GROUND
8	RED	+12V IGNITION
9	VIOLET/BLACK	REAR-R SPEAKER(-)
10	VIOLET	REAR-R SPEAKER(+)
11	GREY/BLACK	FRONT-R SPEAKER(-)
12	GREY	FRONT-R SPEAKER(+)
13	WHITE/BLACK	FRONT-L SPEAKER(-)
14	WHITE	FRONT-L SPEAKER(+)
15	GREEN/BLACK	REAR-L SPEAKER(-)
16	GREEN	REAR-L SPEAKER(+)

### 3. FRONT PANEL Description



**① IR SENSOR**

IR Remote control signal receiving windows. Max distance is 6-8 meters, in 45 degree.

**② POWER**

Turn Power on or off. During power OFF, press Power button to turn ON the Head unit.  
During the unit is ON, long press power button to turn OFF the Head unit

**③ Home**

In any mode, touch the Home button to enter to the Main Menu.

**④ SIRI**

In CarPlay mode, touch the SIRI button to start the Apple SIRI function.

**⑤ MUTE**

To toggle Mute and unmute

**⑥ VOL+**

Increment the Volume level (0~50).

**⑦ VOL-**

Decrement the Volume level (50~0).

**⑧ EJECT**

Insert or eject the disc.

**⑨ RESET**

To reset the Head unit for any reason, use a ball pen or pin to press the RESET button.  
After reset the head unit, the head unit will be restart, all parameter and setting will be kept as pervious status

## 4. MAIN MENU

VRCP-65 is a Two Din Car Audio with the following functions:



Apple CarPlay, Radio, SiriusXM®, Bluetooth Audio, Disc (DVD), USB, E-link (Android 5.0 or above smartphone) and Phone









The MODE icon in grey mean the corresponding function is not ready or proper device have not been connected.

Touch the corresponding MODE icon to enter playing mode.



### Hidden soft button bar

A hidden pop up soft button bar is located at the bottom. Touch the  icon to shown the soft button bar. Touch the  to hidden.

-  Pop up the soft button bar
-  Hidden the pop up soft button bar
-  Setup, to enter the Settings Menu
-  AUX IN, to enter the AUX and A/V IN interface
-  Dimming, to change Daylight or Night (If lighting detect is OFF in Display Setting)
-  Rear Camera, to enter the camera setting mode
-  EQ Setting, to enter the Audio EQ setting menu
-  Bluetooth pairing

## 5. Settings

Touch the  icon to enter the Setup menu.

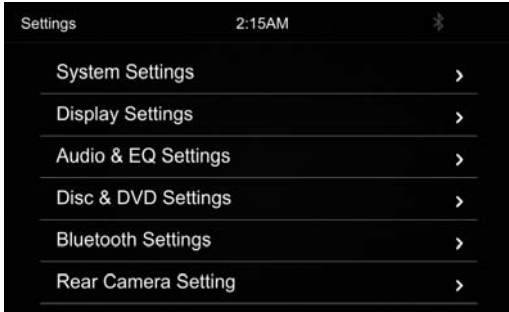

The Setup menu is included System Settings, Display Settings, Audio & EQ Settings, Disc & DVD Settings, Bluetooth Settings and Rear Camera Settings

### System Settings

The System Settings allow the user to set up the Language, Display Time, Date & Time, Beep Tone, Factory Reset and About



### Language



### Display Time: ON/ OFF

- To select display full format date time

### Date & Time:

- To setting Time display format (12H or 24H), setting the date and time



### Beep Tone: On/Off

- To set the touch button beep tune On or Off

### Factory Reset

- To reset the default factory setting.



### About

- To display the Unit Hardware and Firmware version





## Display Settings

Below is the Display setting menu, user can select Lighting Detect, Daylight Dimming Level, Night Dimming Level, Illumination and Wallpaper.

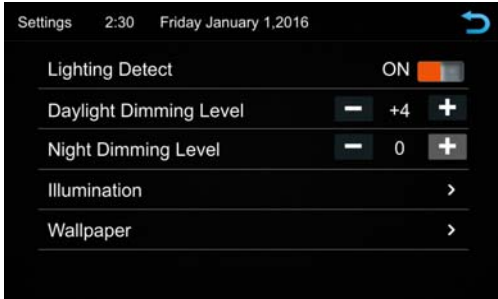

Lighting Detect: On/Off  
 Daylight Dimming Level: 0 – 8  
 Night Dimming Level: -8 – 0  
 Illumination: Red/Yellow/Blue/Green/White



## Wallpaper

User can select the preset wallpaper or select the picture in USB driver as the wallpaper.

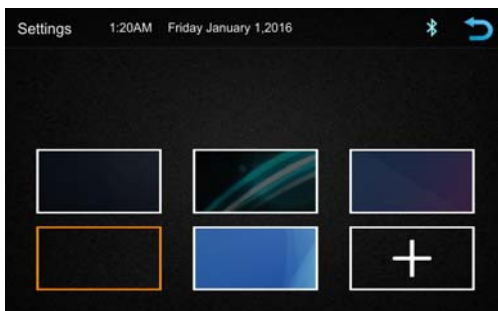

Touch the corresponding picture to select the prefer background.  
 Touch “ + ”, the head unit will search the USB photo file for wallpaper.  
 Select a picture and touch OK to add the wallpaper

### Audio & EQ Settings

Below shown is the Audio Setting Menu

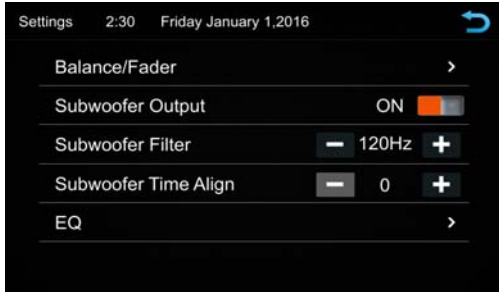

Balance/Fader:

Touch the + or – of Balance/Fade to tune for the driver and passenger preference. The value of Balance (Left 15 – Right 15) and Fade (Front 15 – Rear 15) Touch Reset to set both Balance and Fade to zero

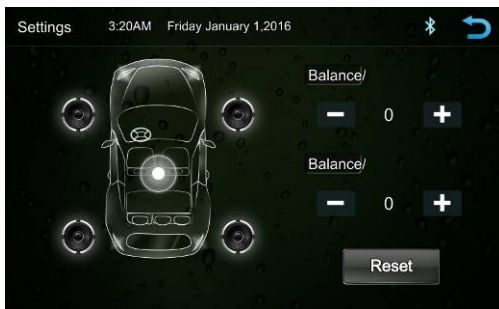

Subwoofer Output On/Off

Subwoofer Filter OFF/ 50Hz/ 80Hz/ 120Hz/ 160Hz

Subwoofer Time Align 0 – 18ms

10-Band Equalizer 10 band of EQ tuning, slide the EQ bar to tune each band frequency level according to user preference. Touch Reset to set all Band to 0.



Or user can touch < or > at the bottom to select the following preset EQ:  
 OFF/Custom/ Jazz/ Hip-Hop /Pop/Rock/R&B

## Disc & DVD Settings

Touch the Disc/DVD Settings from the menu to enter the Disc/DVD setting interface.

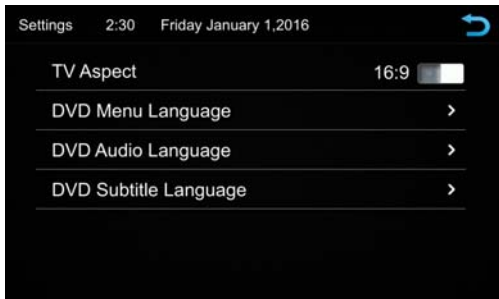

- TV Aspect      Select between 16:9 and 4:3 aspect ratio
- DVD Menu Language:
- DVD Audio Language:
- DVD Subtitle Language:

## Bluetooth Settings

Touch the Bluetooth Settings from the setting menu will be shown below

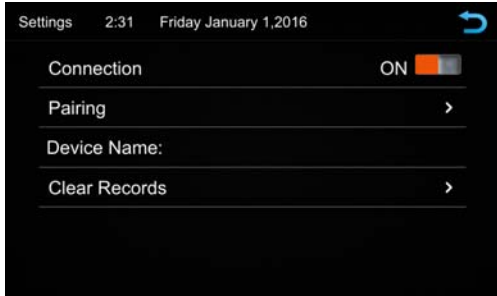

- Connection: On/Off (Select Bluetooth connection on or off)
- Pairing > (To start the pairing)



- Device Name: shown the connected phone or device
- Clear Records (To clear the device list records)

## Rear Camera Setting

Touch Rear View Camera in the Setting Menu to enter rear camera setting interface as follow:

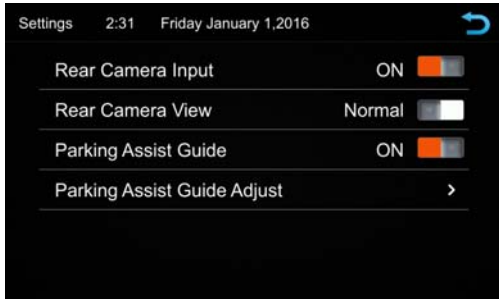

Rear Camera Input: On/Off

Rear Camera View: Normal/Reverse

Parking Assist Guide: On/Off

Parking Assist Guide Adjustment

Touch > to enter Parking Assist Guide Adjustment interface to show the below screen



Select the adjust position and Touch </>/^/∨ to adjust.



Touch Reset to resume the default Parking Assist Line

## 6. Apple CarPlay

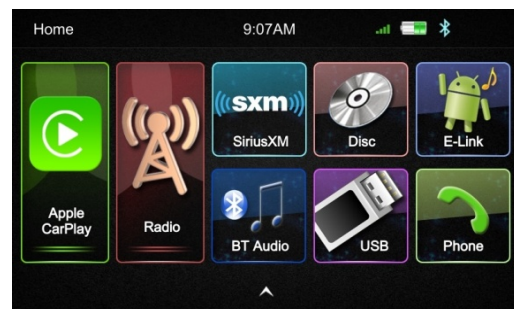
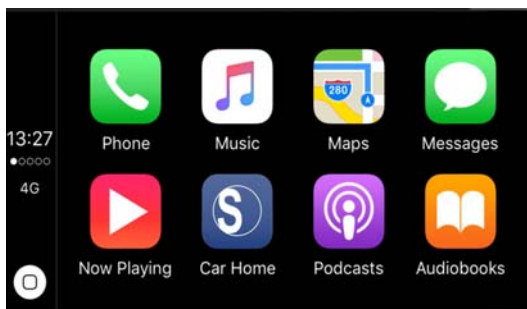
Plug the iPhone (iPhone 5 or latter models, and iOS 7.1 or above) through the lightning cable to the USB port of the Head unit. The iPhone will be shown the “CarPlay”. The Head unit will enter the CarPlay interface, the APP that support the CarPlay feature will be displayed on the Head Unit as shown below. Touch the corresponding APP can operation the operation, touch the  button to go back to the CarPlay interface.



### SIRI

In CarPlay mode, user can talk to SIRI to control the CarPlay function. Press  button to start the SIRI function, or touch the  button for 2 second or the HOME button of iPhone in the CarPlay Home screen to talk to SIRI for playing music, GPS .....

Notice: For the SIRI function in the Head unit, the Microphone has to been connected.

In CarPlay model, touch  button or Main menu icon to enter the Head unit main menu

## 7. Radio Mode

Touch the Radio mode icon to enter Radio mode



**FM1** Touch FM can change between FM1=>FM2=>FM3

**AM1** Touch AM can change between AM1=>AM2

**SXM1** Touch SiriusXM to enter SiriusXM Mode, if a SiriusXM tuner is connected with the unit.

\*Note - A SiriusXM Connect Vehicle Tuner and Subscription are required and sold separately.

**PS** Touch for Prescan search, each scanned station will be play for 3 sec, touch again to stop.

**Q** Touch it for the Auto Scan searching.

**EQ** Touch it to enter EQ setting

**◀** Short touch for Tune-, long touch for Seek-.

**▶** Short touch for Tune+, long touch for Seek+.

Preset channel, Six preset buttons store and recall stations for each band. Touch and slide the preset channel can switch to next band FM1 / FM2 / FM3 or AM1 / AM2

Slide the frequency to Seek +/- to next station

### Store a Station

1. Tune radio to desired station.
2. Touch and hold the one of the preset channel button for more than 3 seconds, then the preset buttons will be highlighted on the screen, and the preset station will be store.

## 8. SiriusXM Operation

VRCP-65 is SiriusXM Satellite Radio Ready, to operation this function, connect an optional SiriusXM Connect Vehicle Tuner.

To enter SiriusXM Mode, touch the SXM icon on the Main Menu.



If the screen is shown “Check Tuner” as below, check the SiriusXM tuner connection.



### Signal Strength

The Top Left corner of the screen is showing the Signal Strength of the SiriusXM satellite



SiriusXM Signal is Excellent



SiriusXM Signal is Good



SiriusXM Signal is Weak





No SiriusXM Signal

In SiriusXM mode, SiriusXM icon is highlighted.

Touch FM1 to go to FM radio

Touch AM1 to go to AM radio



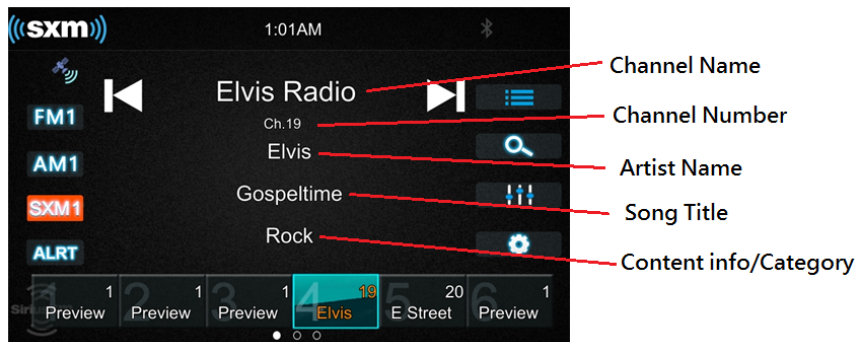

Press  to go to the next channel

Press  to go to the pervious channel

Preset Stations is shown at the bottom, six preset buttons store and recall stations for each band.



The following functions are also supported

-  Browse function
-  Favorite Alerts, Touch to list the favorite channel to direct select the channel
-  Direct Tune function
-  EQ Setting function
-  SiriusXM Setting Menu

### Artist and Song Alert

While listening to SiriusXM Satellite Radio, user can mark Artists and/or Songs for which you wish to be alerted. The radio will display an Alert message when a matching artist or song is found on another channel. Then user can choose if you want to tune to that favorite or user can ignore the alert and stay on your current channel.

To store an artist or song title, touch on the "artist" or "Song" metadata on the display. User will then be prompted to set the alert for the Artist or the Song Title.

User will be alerted when one of your stored artists or songs is playing on another channel. If multile alerts happen at the same time, or the alert gets dismissed, user can touch the ALRT button to list the channels that are currently playing your artist or song.

### Browser Function

Touch  to browse the channel. User can browse by select the Channel List and Category List.

### Channel List

Touch "Channel" button at Left side to show the channel listing





Slide the bar at right to browse the channel

Touch "Channel" button at top right corner to change the display different Metadata as Channel Name, Song Title, Artist/Category Name, Content Info and Category Name

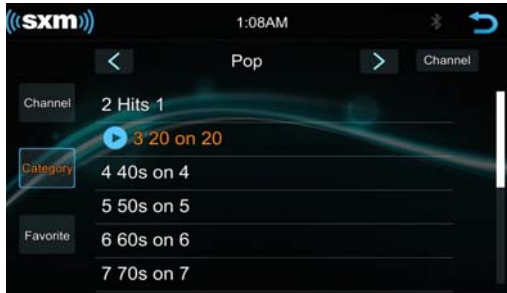

### Category List

Touch the "Category" for the Category list



The channel will be shown according to different Category. Touch < or > to select different Category. Touch "Channel" button at top right corner to change the display different Metadata as Channel Name, Song Title, Artist/Category Name and Content Info.

### Direct Tune

Press  to shown the direct tune interface, user can direct enter the channel number and  touch to go to the desire channel. Press  backspace to clear the pervious digit





### SiriusXM Setting Menu

Touch  to enter the SiriusXM setting menu. It allows user to Change Passcode, Lock Channel and check the Version.



### Change Passcode

Touch > of the Change Passcode to show the below screen. Input the passcode by using the keypad. Press  to clear the pervious digit if input wrong. Touch  to confirm input.





If the passcode is correct, the below screen will be shown to allow user to Enter NEW Passcode.

Input a new 4 digits passcode and select  to confirm the new passcode

Input the passcode again and press  to confirm, then the passcode can be successfully changed.

### Lock Channel

Press > of the Lock Channel in SiriusXM setting menu to enter the Lock channel interface as below.

Input the passcode and touch  to confirm, press  to backspace to remove the pervious digit if input wrongly

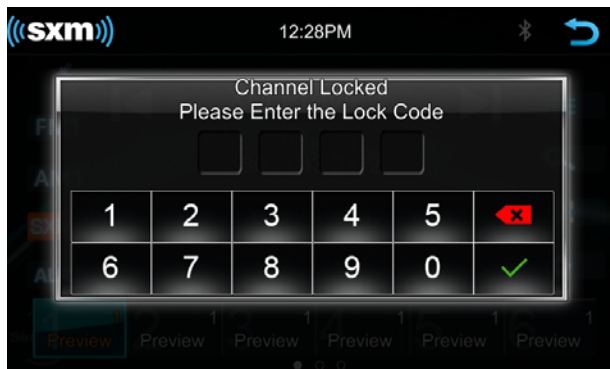

If the passcode is correct, the unit will enter the lock channel list, select the channel for any channel that has been locked. Tap the locked channel again to remove from the locked channel list. The lock icon  will be shown that that you would like to lock.



**Version**

Press Version in the menu, the below screen will be shown the VRCP-65 Software version information



**Reset SiriusXM passcode**

The default SiriusXM passcode is 0000, If you forget the passcode, follow the steps below to restore the unit to the default.

1. Enter Settings ;
2. Set the time format is 24H and the date/time to 2001-1-1 01 : 01 ;
3. Enter SiriusXM mode and select direct tune;
4. Input the channel number 9992 ( the display only can show 999 ) ;
5. Press confirm to reset the SiriusXM passcode to default

**Radio ID**

Tune to channel 0 to display the Radio ID. you can use channel up/down or direct tune.



**Advisory Message**

On-Screen Display	Advisory Message	Cause	Explanation/Solution
Check Antenna	Check Antenna	The radio has detected a fault with the SiriusXM antenna. The antenna cable may be either disconnected or damaged.	<ul style="list-style-type: none"> <li>• Verify that the antenna cable is connected to the SiriusXM Connect Vehicle Tuner.</li> <li>• Inspect the antenna cable for damage and kinks. Replace the antenna if the cable is damaged.</li> </ul>
Check Tuner	Check Tuner	<ul style="list-style-type: none"> <li>• The radio has difficulty communicating with the SiriusXM Connect Vehicle Tuner.</li> <li>• The tuner may be disconnected or damaged</li> </ul>	<ul style="list-style-type: none"> <li>• Verify that the SiriusXM Connect Vehicle Tuner cable is securely connected to the radio SiriusXM connector/ cable.</li> <li>• If the problem persists, disconnect and reconnect the tuner and then contact your dealer.</li> </ul>

No Signal	No Signal	The SiriusXM Connect Vehicle Tuner has difficulty receiving the SiriusXM satellite signal.	<ul style="list-style-type: none"> <li>• Verify that your vehicle is outdoors with a clear view of the southern sky.</li> <li>• Verify that the SiriusXM magnetic mount antenna is mounted on a metal surface on the outside the vehicle.</li> <li>• Move the SiriusXM antenna away from any obstructions.</li> <li>• Inspect the antenna cable for damage and kinks. Replace the antenna if the cable is damaged.</li> <li>• If the problem persists, disconnect and reconnect the tuner and then contact your dealer.</li> </ul>
Channel Not Available	Channel Not Available	The channel that you have requested is not a valid SiriusXM channel or the channel that you were listening to is no longer available. You may also see this message briefly when first connecting a new SiriusXM Connect Vehicle tuner. Visit <a href="http://www.siriusxm.com">www.siriusxm.com</a> for more information about the SiriusXM channel lineup.	Visit <a href="http://www.siriusxm.com/channellineup">www.siriusxm.com/channellineup</a> for more information about the SiriusXM channel lineup.
Channel Not Subscribed	Channel Not Subscribed	The channel that you have requested is not included in your SiriusXM subscription package or the channel that you were listening to is no longer included in your SiriusXM subscription package	<ul style="list-style-type: none"> <li>• Questions about your subscription in the United States please visit <a href="http://www.siriusxm.com/activatenow">http://www.siriusxm.com/activatenow</a> or call SiriusXM Listener Care at 1-866-635-2349.</li> <li>• Questions about your subscription in Canada please visit <a href="http://www.siriusxm.ca/help/activation-help/">http://www.siriusxm.ca/help/activation-help/</a> or call XM Listener Care at 1-877-438-9677</li> </ul>
Channel Locked	Channel Locked	The channel that you have requested is Locked by the radio	See the section on Lock Channel, page 18 for more information on the Lock Channel feature and how to access locked channels
Please Enter the Lock Code	Please Enter the Lock Code	User prompted to enter the lock/unlock code.	Enter the four digit code to unlock the channel
Incorrect Passcode Entered	Incorrect Passcode Entered	The unlock code entered by the user is incorrect	<ul style="list-style-type: none"> <li>• Input the correct four digit code to unlock the channel.</li> <li>• Reset lock code to default following instructions on page 19</li> </ul>

## 9. Disc

### Inserting a Disc

Insert a Disc to the slot of the head unit, pull the disc or press the Eject button to make the disc into the deck. Touch the Disc to perform Disc playing function.



### Ejecting a Disc

During disc playing or inside the deck, press the Eject button to stop playing the disc and eject the disc. After the disc is ejected and press the Eject button, the disc will go inside to the unit.

### Playing CD/MP3 Disc

If playing the CD/MP3 Disc, the following will be shown.

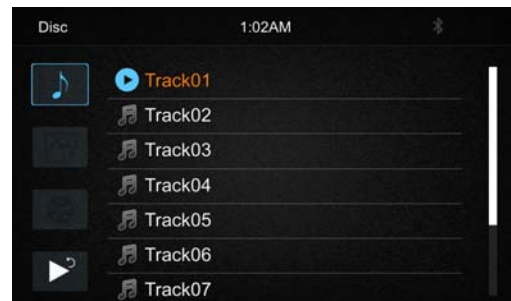

- Press it to skip to the next folder (for MP3)
- Press it to search song files or folder list.
- Press it to skip to the previous folder (for MP3).
- Short press it to skip to the previous track, long press it to fast reverse.
- Pause/Play button.
- Short press it to skip to the next track, long press it to fast forward.
- Repeat: For CD: Press for switch between Repeat All and Repeat One  
For MP3: Press for select Repeat All, Repeat One or Repeat Directory
- Press it to turn on/off random play.
- Press it to turn on/off the Audio Settings menu to adjust the EQ.
- Press it to select songs.
- Return button.

### DVD/VCD Playback

The Video display can be watched only during the Car is Parked

Parking wiring: High level (+12v or NC) is driving; low level (ground) is parking

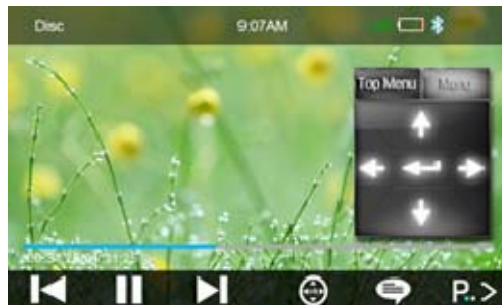

- Short press it to skip to the previous track, long press it to fast reverse.
- / Pause/Play button.
- Short press it to skip to the next track, long press it to fast forward.
- Touch it to select subtitle language
- Touch to open/close the navigation button
- Touch it to show the tools bar
- Touch it to select Chapter
- Touch it to select Title
- Press it to select repeat All, Repeat One and Repeat Off
- Touch it to select subtitle language or sub off.
- Touch it to change the viewing angle.
- Touch it to adjust the Brightness/Contract/Color
- Touch it to hidden the tools bar

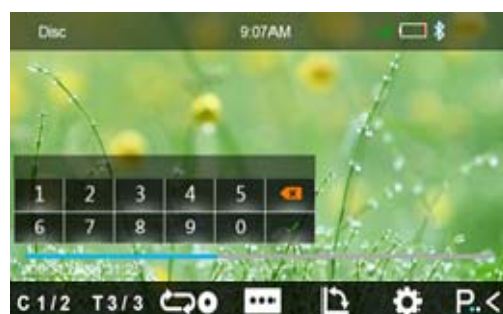
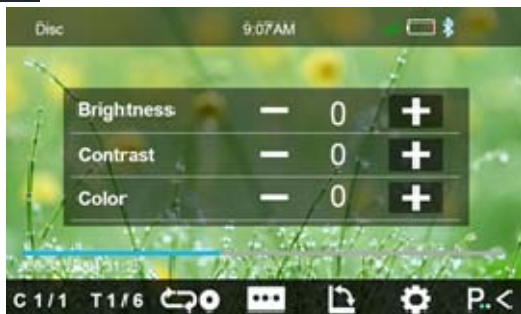

### Direct search





1. Touch the button
2. Touch the button or to select a chapter or title directly using the on-screen display direct entry menu display. Enter the Direct Search menu,
3. Enter the chapter or Title Digital, touch that starts the function.

### Playing Multimedia Files in Disc

VRCP-65 is supporting the below disc types and Multimedia file format.

1. Supported DISC Format: CD-DA /CD-TEXT/Video CD/DVD/Multi session
2. Supported Audio Format: PCM(.wav ), MP3, WMA, Flac, Dolby Digital, DTS,
3. Supported Picture Format: JPEG, BMP, PNG.
  - Max file size is 10Mbytes or Max. Resolution 1200×1200.
4. Supported Video Format: MPEG1/MPEG2/MPEG4 Simple Profile (.mp4 (MPEG-4 Simple Profile + AAC), JPEG, DVD-Video, DVD-VR

When the disc is included different type of Multimedia, Touch  to shown the list.

-  Select Audio or Music files
-  Select Movie or Video files.
-  Select Picture files
-  Return to playing pervious file

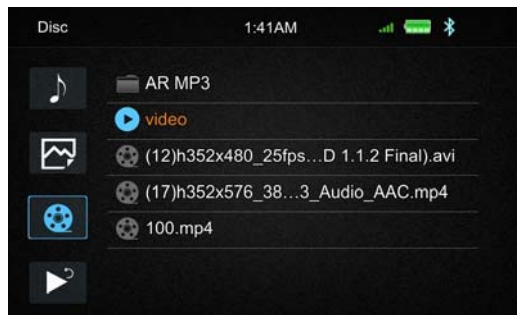



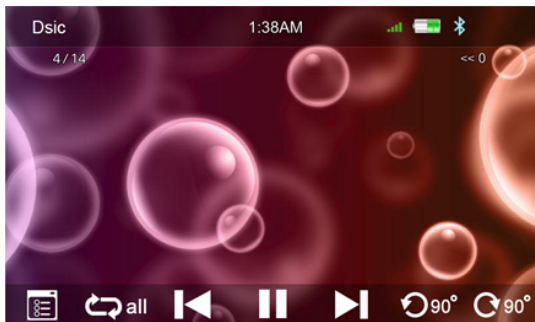

Touch the corresponding icon to list the files, touch the filename to playback the file.

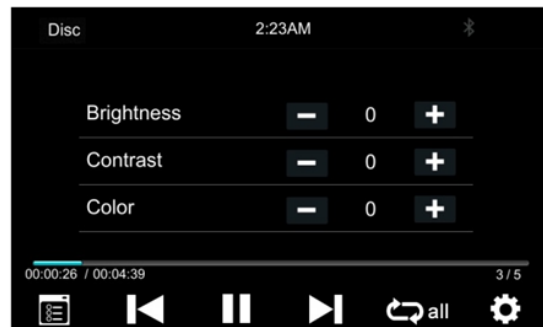

picture playback











video playback

-  Touch it to return to the file list
-  Repeat Play, touch to select repeat play once, directory or all
-  Touch to rotate the picture anti-clockwise for 90 degree (for picture playback)
-  Touch to rotate the picture clockwise for 90 degree (for picture playback)
-  Touch to set the video Brightness, Contrast and Color (for video playback)

## 10. USB





Plug the USB to the connector, the USB icon will have color. Touch the USB icon to enter the USB playback mode. The Head unit default to play the Audio in the USB driver.



-  Press to go to the next folder.
-  Press to search Audio, Video or Picture files.
-  Press to go to the previous folder.
-  Short press it to skip to the previous track, long press it to fast reverse.
-  Pause/Play button.
-  Short press it to skip to the next track, long press it to fast forward.
-  Repeat Play Press it to select Repeat All, Repeat One or Repeat Directory.
-  Press it to turn on/off random play.
-  Press it to select the Audio setting or set the prefer EQ of each band in Custom mode

### Audio, Video, Picture play back

VRCP-65 is default audio play back, it also support to play picture and video. If there is other multimedia files in the USB, touch  to browse the folder and file list of the USB driver. Select the multimedia type

-  Select Audio or Music files
-  Select Movie or Video files.
-  Select Picture files
-  Return to playing pervious file



Touch the corresponding icon to select different type of multimedia file list will be shown. Select the file to play.





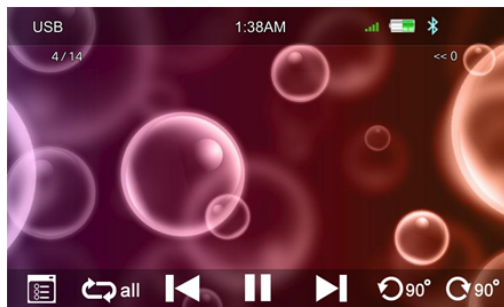

Picture and Video Playback

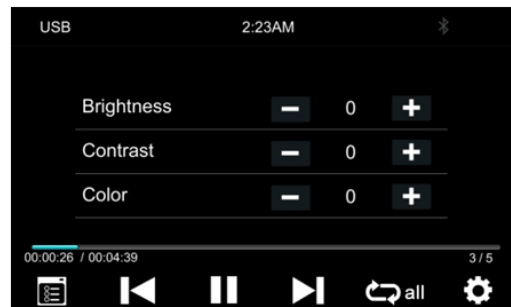

picture playback



video playback

-  Touch it to return to the file list
-  Repeat Play, touch to select repeat play once, directory or all
-  Touch to rotate the picture anti-clockwise for 90 degree (for picture playback)
-  Touch to rotate the picture clockwise for 90 degree (for picture playback)
-  Touch to set the video Brightness, Contrast and Color (for video playback)

### 11. Bluetooth Audio

Touch the BT Audio icon to enter Bluetooth Audio playing mode. If the Bluetooth is connected, the music will be playing as following shown.

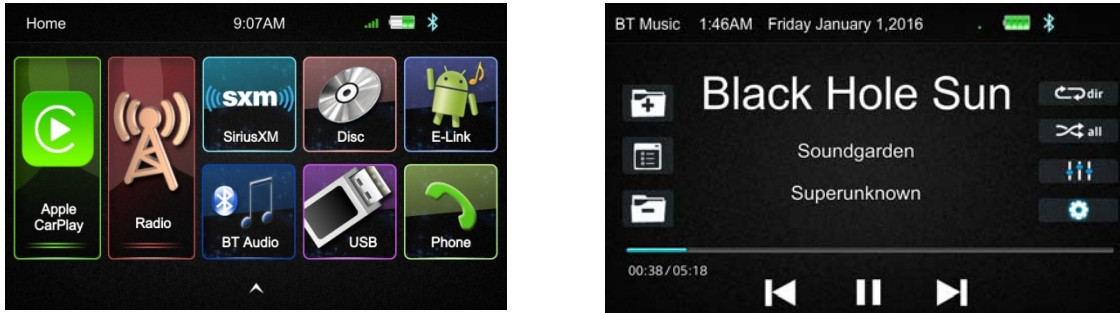

If the Bluetooth is not connected, press Reconnect to connect the paired phone or Pairing to pair the new device.



### Bluetooth Pairing













Press Pairing the Pairing Mode screen will be shown as below



Turn On the Bluetooth of the Mobile phone/Bluetooth device, you can see the VRCP-65. Select the VRCP-65 for pairing and connection

**Bluetooth Audio Playback**



-  Press it to skip to the next folder.
-  Press it to open the music file list or folder (support iPhone).
-  Press it to skip to the previous folder.
-  Short press it to skip to the previous track.
-  Pause/Play button.
-  Short press it to skip to the next track.
-  Repeat, press for select between Repeat All, Repeat One or Repeat Directory
-  Press it to turn on/off random play.
-  Press it to turn on/off the Audio Settings menu to adjust the EQ.
-  Press it to select songs.
-  Return button.
-  Setting the Bluetooth output level



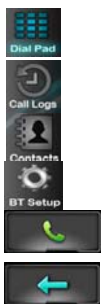

## 12. Phone

Touch the Phone icon in main menu to go to Phone mode. After the phone connected with the Head Unit via Bluetooth (HFP), user can through the Head unit to make a phone call. Please note it needs to connect the microphone for phone call.



- Dial Pad, tap Dial pad button to enter call mode
- Call logs, to show the call record, missed, received and dialed calls
- Contact, to show the phonebook connected phone
- BT Setup, to set auto answer and microphone gain
- Make a Call or Accept the Incoming Call
- Backspace, to clear the pervious dial digit

### Dial a Call

1. Touch the  icon to the above screen will appear.
2. Using the keypad, touch 0-9,\*, #, to enter the phone number you wish to dial. If you enter an incorrect number, touch the  icon on the keypad to delete the incorrect number.
3. Once the correct number appears on the screen, touch the  icon. To go back dialing interface, touch the return icon at the upper right corner of the screen.
4. To end the call, touch the  on the screen





### Receive an incoming Call

If the Phone is connect with the unit via Bluetooth, when an incoming call, the below screen will be shown



Press  to receive the Call or  to hang the call

-  Interchange between phone and head unit
-  ON/OFF the Microphone function
-  Display the Dial Pad



### Call Logs

Touch the  icon to display the Call Combined list.

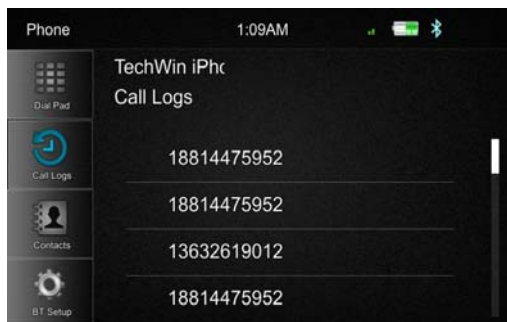

Slide the bar at right side up and down to display a Call logs up to 20 records.

### Contacts

Touch the  icon to access the phone book of the connected phone.  
To make a call from the phone book, simply touch the contact name.



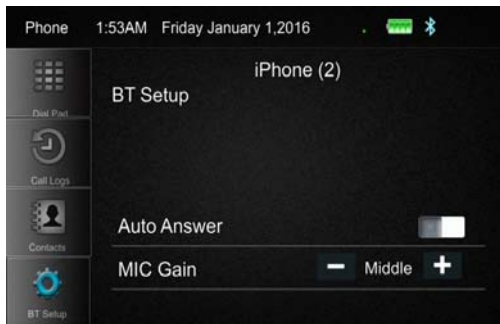

### BT Setup



Auto Answer      On/Off  
Mic Gain          Low/ Middle/High

### 13. AUX IN

The Audio/Video source with RCA cable can through the Head unit to play the Audio/Video. Plug the RCA to the corresponding A/V socket.

Touch the  to pop up the function bars and touch  to view the playing Audio/Video.



The Audio and Video will via the RCA cable to the Head unit



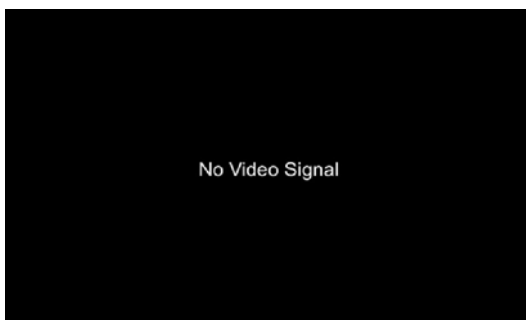

If there is no Video signal the below screen will be shown



### 14. Rear Camera

There is a RCA socket for the Rear camera video signal to display on the Head unit.

The Reverse wire in High level (+12V) is reverse; low level (ground or NC) is normal

User also can touch the  to pop up the function bars and touch  to view the Rear camera.



### Rear Camera Settings menu

Rear Camera Input: On/Off

Rear Camera view: Normal/ Reverse

Parking Assist Guide: On/Off



### Parking Assist Guide Adjust

Touch the </>/^/∨ buton to adjust the assist line to guide the car position

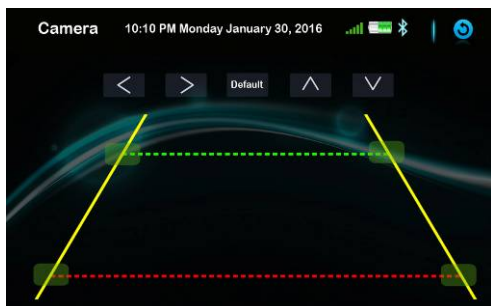



## 15. E-Link

The VRCP-65 have the E-Link function to allow the Android 5.0 or above smartphone display on the Head unit screen.

### Install Auto Link

User need to install the Autolink App to the Android phone. When the Android phone first time connected to the VRCP-65 via USB, the phone will show a website link to download the Autolink application pack. Download and install the apk file on the Android phone. After installed the Autolink App, the Android phone can use the E-Link function.

### Connection

Connect the Android phone and head unit via USB cable, the Android phone display will be shown on the Head unit screen. User also allows using the touch panel of the head unit to control the Android phone.

## 16. Remote Control

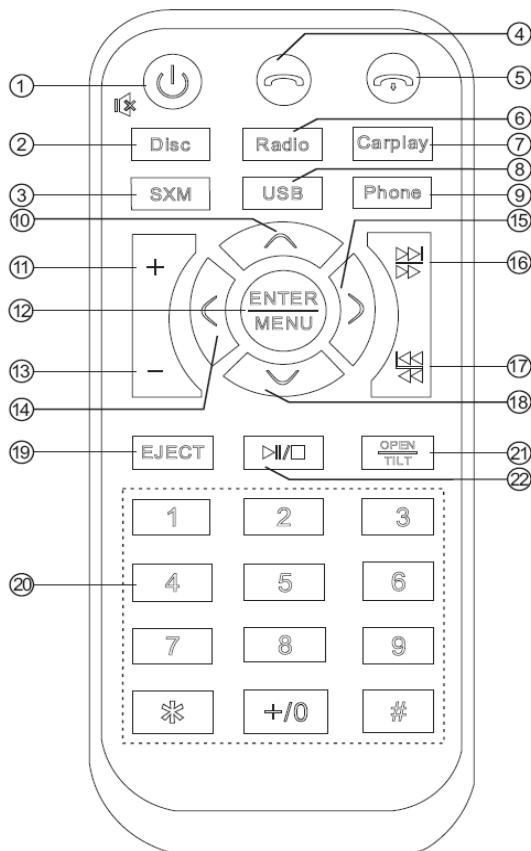

- |              |               |
|--------------|---------------|
| ① Power      | ④ Answer      |
| ② Disc       | ⑤ Hang up     |
| ③ SiriusXM   | ⑥ Radio       |
| ⑩ Up         | ⑦ Carplay     |
| ⑪ VOL+       | ⑧ USB         |
| ⑫ ENTER/MENU | ⑨ Phone       |
| ⑬ VOL-       | ⑮ Right       |
| ⑭ Left       | ⑯ SEEK+ / >>> |
| ⑰ EJECT      | ⑰ SEEK- / <<< |
| ⑱ Number Key | ⑱ Down        |
|              | ⑲ OPEN/TILT   |
|              | ⑲ Play/Pause  |

### 1. Power

Long press it to power off

### 2. Disc

Press it to select the disc play mode if there is a disc in the unit.

### 3. SiriusXM

Press it to select the SiriusXM mode if the unit is connected with a SiriusXM tuner.

### 4. Answer

BT phone is connected, press it to accept call.

### 5. Hang up

BT phone is connected, press it to end call.

### 6. Radio

Press it to select the Radio mode.

### 7. Carplay

Press it to select the CarPlay mode if the unit is connected with iPhone.

### 8. USB

Press it to select the USB mode if there is a USB device in the unit.

### 9. Phone

Press it to select the BT Phone mode.

### 10. UP

In the radio mode, press it to select a preset station up.

In the USB mode, press it to select a folder up.

In the disc mode, press it to select the DVD menu item up.

**11. VOL+**

Press it to increment volume step, long press to volume rapid up.

**12. ENTER/MENU**

In disc mode, press it to confirm selection or enter setting for DVD menu.

**13. VOL-**

Press for decrement the volume step, long press for volume rapid down.

**14. LEFT**

In the radio mode, short press for seek-, long press for tune-.

In the disc mode, press to select the DVD menu item left.

**15. RIGHT**

In the radio mode, short press for seek+, long press for tune+.

In the disc mode, press it to select the DVD menu item right.

**16. SEEK+/▶▶**

In Radio mode, short press for next preset channel, long press for SEEK+

In SiriusXM mode, short press for next preset channel, long press to browse the channel up.

In USB/BT/Disc mode, short press for next track, long press for fast forward

**17. SEEK-/◀◀**

In Radio mode, short press for pervious preset channel, long press for SEEK-

In SiriusXM mode, short press for pervious preset channel, long press to browse the channel down

In USB/BT/Disc mode, short press for previous track, long press for fast reverse

**18. DOWN**

In the radio mode, press it to select a preset station down.

In the USB mode, press it to select a folder down.

In the disc mode, press it to select the DVD menu item down.

**19. EJECT**

Press it to eject the disc, Press it to again to insert the disc.

**20. Numeric Key**

In Radio and SiriusXM mode, 1 to 6 can use to select the preset channel.

In BT Phone mode, the numeric key can act for number dialing

**21. OPEN/TILT**

No function for VRCP-65

**22. PLAY/PAUSE**

Play/Pause button

## 17. Specification

### General

Power Supply .....	DC10~16Volts
Grounding System .....	Negative Ground
Current Drain .....	15A(Max.)
Power Output .....	4×40W/channel(Max.)
Speaker Impedance .....	4~8ohms per channel
Frequency Response.....	20Hz~20KHz
Operating Temperature .....	-20~+60°C

### TFT Display

TFT Screen size.....	6.2inch
Resolution.....	800×480 pixels

### FM Radio

Frequency Range (USA) .....	87.5~107.9MHz
Frequency Range (Europe) .....	87.5~108MHz
Usable Sensitivity (S/N=30dB).....	≤ 15dB
S/N Ratio.....	≥ 55dB
Stereo Separation.....	≥ 30dB

### AM/MW

Frequency Range (USA) .....	530~1710KHz
Frequency Range (Europe) .....	522~1620KHz
Usable Sensitivity(S/N=20dB).....	≤ 40dB
S/N Ratio.....	≥ 45dB

### DVD/CD

S/N Ratio.....	≥ 60dB
Channel Separation .....	>50dB

### Line-Out/Subwoofer Output

Maximum Output Level (10K ohms load).....	≥ 4Vrms
Subwoofer Time Align.....	0~18ms

**FCC Warning**

Any Changes or modifications not expressly approved by the party responsible for compliance could void the user's authority to operate the equipment.

This device complies with part 15 of the FCC Rules. Operation is subject to the following two conditions: (1) This device may not cause harmful interference, and (2) this device must accept any interference received, including interference that may cause undesired operation.

**FCC Radiation Exposure Statement:**

This equipment complies with FCC radiation exposure limits set forth for an uncontrolled environment. This equipment should be installed and operated with minimum distance 20cm between the radiator& your body.

This transmitter must not be co-located or operating in conjunction with any other antenna or transmitter.

Note: This equipment has been tested and found to comply with the limits for a Class B digital device, pursuant to part 15 of the FCC Rules. These limits are designed to provide reasonable protection against harmful interference in a residential installation. This equipment generates uses and can radiate radio frequency energy and, if not installed and used in accordance with the instructions, may cause harmful interference to radio communications. However, there is no guarantee that interference will not occur in a particular installation. If this equipment does cause harmful interference to radio or television reception, which can be determined by turning the equipment off and on, the user is encouraged to try to correct the interference by one or more of the following measures:

- Reorient or relocate the receiving antenna.
- Increase the separation between the equipment and receiver.
- Connect the equipment into an outlet on a circuit different from that to which the receiver is connected.
- Consult the dealer or an experienced radio/TV technician for help.