



FCC PART 15C TEST REPORT FOR CERTIFICATION  
On Behalf of

Sounding Audio Industrial Ltd.

Mobile audio wall mount unit

JWM9A

FCC ID: OPDJWM9ABK

Prepared for : Sounding Audio Industrial Ltd.  
Unit N, 7/F, Stage 2. Wah Fung Industrial Centre 33-39 Kw  
Chung Road Kwai Chung, Hong Kong

Prepared By : Audix Technology (Shenzhen) Co., Ltd.  
No. 6, Kefeng Road, Science & Technology Park, Nanshan  
District , Shenzhen, Guangdong, China

Tel: (0755) 26639496

Report Number : ACS-F16184  
Date of Test : Aug.16~20, 2016  
Date of Report : Sep.26, 2016

**TABLE OF CONTENTS**

Description	Page
<b>1. SUMMARY OF STANDARDS AND RESULTS .....</b>	<b>1-1</b>
1.1. Description of Standards and Results.....	1-1
<b>2. GENERAL INFORMATION .....</b>	<b>2-1</b>
2.1. Description of Device (EUT) .....	2-1
2.2. Test information .....	2-2
2.3. Tested Supporting System Details .....	2-2
2.4. Block Diagram of Test Setup .....	2-2
2.5. Test Facility.....	2-3
2.6. Measurement Uncertainty (95% confidence levels, k=2) .....	2-3
<b>3. POWER LINE CONDUCTED EMISSION TEST.....</b>	<b>3-1</b>
<b>4. RADIATED EMISSION MEASUREMENT .....</b>	<b>4-1</b>
4.1. Test Equipments.....	4-1
4.2. Block Diagram of Test Setup .....	4-2
4.3. Radiated Emission Limit Standard: FCC 15.209 .....	4-3
4.4. EUT Configuration on Test.....	4-3
4.5. Operating Condition of EUT.....	4-3
4.6. Test Procedure.....	4-3
4.7. Radiated Emission Test Results .....	4-4
<b>5. CONDUCTED SPURIOUS EMISSIONS .....</b>	<b>5-1</b>
5.1. Test Equipments.....	5-1
5.2. Limit.....	5-1
5.3. Test Procedure.....	5-1
5.4. Test result .....	5-1
<b>6. CARRIER FREQUENCY SEPARATION TEST .....</b>	<b>6-1</b>
6.1. Test Equipments.....	6-1
6.2. Limit.....	6-1
6.3. Test Procedure.....	6-1
6.4. Test Results .....	6-2
<b>7. 20 DB BANDWIDTH TEST .....</b>	<b>7-1</b>
7.1. Test Equipments.....	7-1
7.2. Limit.....	7-1
7.3. Test Procedure.....	7-1
7.4. Test Results .....	7-1
<b>8. NUMBER OF HOPPING FREQUENCY TEST .....</b>	<b>8-1</b>
8.1. Test Equipments.....	8-1
8.2. Limit.....	8-1
8.3. Test Procedure.....	8-1
8.4. Test Results .....	8-1
<b>9. DWELL TIME .....</b>	<b>9-1</b>
9.1. Test Equipment .....	9-1
9.2. Limit.....	9-1
9.3. Test Procedures .....	9-1
9.4. Test Results .....	9-1
<b>10. MAXIMUM PEAK OUTPUT POWER TEST.....</b>	<b>10-1</b>
10.1. Test Equipments.....	10-1

10.2. Limit.....	10-1
10.3. Test Procedure.....	10-1
10.4. Test Results .....	10-1
<b>11. BAND EDGE COMPLIANCE TEST .....</b>	<b>11-1</b>
11.1. Test Equipments.....	11-1
11.2. Limit.....	11-1
11.3. Test Produce.....	11-1
11.4. Test Results .....	11-1
<b>12. DEVIATION TO TEST SPECIFICATIONS .....</b>	<b>12-1</b>
<b>13. PHOTOGRAPH OF TEST.....</b>	<b>13-1</b>
13.1. Photos of Radiated Emission Test.....	13-1
<b>14. PHOTOS OF THE EUT .....</b>	<b>14-1</b>

### TEST REPORT CERTIFICATION

Applicant : Sounding Audio Industrial Ltd.  
 Manufacturer : AR Electronics Co., Ltd.  
 Product : Mobile audio wall mount unit  
 FCC ID : OPDJWM9ABK  
 (A) Model No. : JWM9A  
 (B) Serial No. : N/A  
 (C) Power Supply : DC 12V  
 (D) Test Voltage : DC 12V

Tested for comply with:  
 FCC Rules and Regulations Part 15 Subpart C: 2014  
 Test procedure used:  
 ANSI C63.10: 2013

The device described above is tested by AUDIX TECHNOLOGY (SHENZHEN) CO., LTD. to confirm comply with all the FCC Part 15 Subpart C requirements. The test results are contained in this test report and AUDIX TECHNOLOGY (SHENZHEN) CO., LTD. is assumed full responsibility for the accuracy and completeness of these tests. Also, this report shows that the Equipment Under Test (EUT) is to be technically compliant with the FCC and IC requirements. This report contains data that are not covered by the NVLAP accreditation.

This Report is made under FCC Part 2.1075. No modifications were required during testing to bring this product into compliance.

This report applies to above tested sample only. This report shall not be reproduced in part without written approval of AUDIX TECHNOLOGY (SHENZHEN) CO., LTD.

The report must not be used by the client to claim product certification, approval, or endorsement by NVLAP, NIST, or any agency of the federal government.

Date of Test : Aug.16~20, 2016 Report of date: Sep.26, 2016

Prepared by : Monica Liu / Assistant Reviewed by : Sunny Lu / Deputy Manager



Approved & Authorized Signer : David Jin / Manager

## 1. SUMMARY OF STANDARDS AND RESULTS

### 1.1. Description of Standards and Results

The EUT has been tested according to the applicable standards as referenced below.

EMISSION		
Description of Test Item	Standard	Results
Power Line Conducted Emission Test	FCC Part 15: 15.207 ANSI C63.10 : 2013	N/A
Radiated Emission Test	FCC Part 15: 15.209 FCC Part 15: 15.247(d) ANSI C63.10 : 2013	PASS
Conducted Spurious Emissions	FCC Part 15: 15.247(a)(1) ANSI C63.10 : 2013	PASS
Carrier Frequency Separation Test	FCC Part 15: 15.247(a)(1) ANSI C63.10 : 2013	PASS
20dB Bandwidth Test	FCC Part 15: 15.215 ANSI C63.10 : 2013	PASS
Number Of Hopping Frequency Test	FCC Part 15: 15.247(a)(1)(iii) ANSI C63.10 : 2013	PASS
Dwell Time Test	FCC Part 15: 15.247(a)(1)(iii) ANSI C63.10 : 2013	PASS
Maximum Peak Output Power Test	FCC Part 15: 15.247(b)(1)\ ANSI C63.10 : 2013	PASS
Band Edge Compliance Test	FCC Part 15: 15.247(d) ANSI C63.10 : 2013	PASS

## 2. GENERAL INFORMATION

### 2.1. Description of Device (EUT)

Product	: Mobile audio wall mount unit
Model No.	: JWM9A
FCC ID	: OPDJWM9ABK
Radio	: Bluetooth V2.1 + EDR
Operation frequency	: 2402-2480MHz
Channel Number	: 79 channels
Modulation Technology	: GFSK, $\pi/4$ DQPSK, 8-DPSK
Antenna Type	: Embedded with designed PCB antenna, 0dBi PK Gain
Applicant	: Sounding Audio Industrial Ltd. Unit N, 7/F, Stage 2. Wah Fung Industrial Centre 33-39 Kw Chung Road Kwai Chung, Hong Kong
Manufacturer	: AR Electronics Co., Ltd. Sima District, Changping, Dongguan, Guangdong.
Date of Test	: Aug.16~20, 2016
Date of Receipt	: Aug.14, 2016
Sample Type	: Prototype production

### 2.2. Test information

A special test software was used to control EUT work in Continuous TX mode, and select test channel.

Tested mode, channel, and data rate information			
Mode	data rate (Mbps)	Channel	Frequency (MHz)
Tx Mode GFSK modulation	1	Low :CH 0	2402
	1	Middle: CH39	2441
	1	High: CH78	2480
Tx Mode 8-DPSK modulation	3	Low :CH 0	2402
	3	Middle: CH39	2441
	3	High: CH78	2480

Note:  $\pi/4$ DQPSK modulation is same type modulation with 8-DPSK, and according exploratory test, 8-DPSK will have worse emissions, so the final test were only performed with GFSK and 8-DPSK modulation.

### 2.3. Tested Supporting System Details

No.	Description	ACS No.	Manufacturer	Model	Serial Number
1	Speaker #1	N/A	SAMSUNG	PS-E460D	N/A
		Cable: Shielded, Undetachable, 0.9m			
2	Speaker #2	N/A	SONY	SS-CEX100	N/A
		Cable: Shielded, Undetachable, 0.9m			
3	MP4 Play	N/A	SONY	NWZ-E360	N/A

### 2.4. Block Diagram of Test Setup

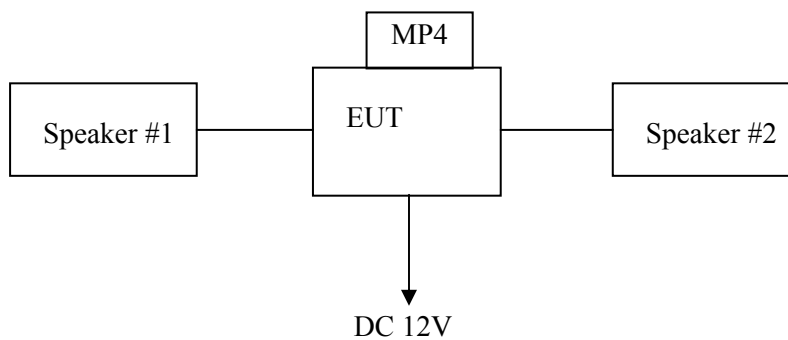

(EUT: Mobile audio wall mount unit)

**2.5. Test Facility**

Site Description

Name of Firm : Audix Technology (Shenzhen) Co., Ltd.  
 No. 6, Kefeng Road, Science & Technology Park, Nanshan District , Shenzhen, Guangdong, China

3m Anechoic Chamber : Certificated by FCC, USA  
 Registration Number: 90454  
 Valid Date: Jul.12, 2017

3m & 10m Anechoic Chamber : Certificated by FCC, USA  
 Registration Number: 794232  
 Valid Date: Jul.12, 2017

EMC Lab. : Certificated by Industry Canada  
 Registration Number: IC 5183A-1  
 Valid Date: May.14, 2017

: Certificated by DAkkS, Germany  
 Registration No: D-PL-12151-01-00  
 Valid Date: Dec.15, 2016

: Accredited by NVLAP, USA  
 NVLAP Code: 200372-0  
 Valid Date: Mar.31, 2017

**2.6. Measurement Uncertainty (95% confidence levels, k=2)**

Test Item	Uncertainty
Uncertainty for Radiation Emission test in 3m chamber	2.8dB(30~200MHz, Polarization: H)
	2.8dB(30~200MHz, Polarization: V)
	2.8dB(200M~1GHz, Polarization: H)
	2.8dB(200M~1GHz, Polarization: V)
Uncertainty for Radiation Emission test in 3m chamber (1GHz-18GHz)	5.8dB (1~6GHz, Distance: 3m)
	5.8dB (6~18GHz, Distance: 3m)
Uncertainty for Radiated Spurious Emission test in RF chamber	3.6dB
Uncertainty for Conduction Spurious emission test	2.0dB
Uncertainty for Output power test	0.8dB
Uncertainty for Bandwidth test	83kHz
Uncertainty for DC power test	0.1%
Uncertainty for test site temperature and humidity	0.6°C
	3%



### **3. POWER LINE CONDUCTED EMISSION TEST**

According to Paragraph (c) of FCC Part 15 section 15.207, Tests to demonstrate compliance with the conducted limits are not required for devices which only employ battery power for operation and which do not operate from the AC power lines or contain provisions for operation while connected to the AC power lines.

## 4. RADIATED EMISSION MEASUREMENT

### 4.1. Test Equipments

#### 4.1.1. Frequency range: 30~1000MHz (In 3m Anechoic Chamber)

Item	Equipment	Manufacturer	Model No.	Serial No.	Last Cal.	Cal. Interval
1.	3#Chamber	AUDIX	N/A	N/A	Mar.28,16	1 Year
2.	EMI Spectrum	Agilent	E4407B	MY41440292	Apr.24,16	1 Year
3.	Test Receiver	Rohde & Schwarz	ESVS10	834468/011	Apr.24,16	1 Year
4.	Amplifier	HP	8447D	2648A04738	Apr.24,16	1 Year
5.	Tri-log-Broadband Antenna	SCHWARZBECK	VULB 9168	9168-710	Jul.20,16	1 Year
6.	RF Cable	MIYAZAKI	CFD400-N W(3.5M)	No.3	Apr.24,16	1 Year
7.	RF Cable	MIYAZAKI	CFD400-L W(22M)	No.7	Apr.24,16	1 Year
8.	Coaxial Switch	Anritsu	MP59B	6201397222	Apr.23,16	1 Year
9.	Test Software	AUDIX	e3	6.2009-5-21a(n)	N/A	N/A

Note: N/A means Not applicable.

#### 4.1.2. For frequency range 1GHz~25GHz (In 3m Anechoic Chamber)

Item	Equipment	Manufacturer	Model No.	Serial No.	Last Cal.	Cal. Interval
1.	Spectrum Analyzer	Agilent	E4446A	US44300459	Apr.24,16	1 Year
2.	Horn Antenna	ETS	3115	9510-4877	Oct.15,15	1 Year
3.	Amplifier	Agilent	8449B	3008A02495	Apr.24,16	1 Year
4.	RF Cable	Hubersuhner	SUCOFLEX104	274094/4	Apr.24,16	1 Year
5.	Horn Antenna	ETS	3116	00060089	Oct.15,15	1 Year
6.	Test Software	AUDIX	e3	6.2009-5-21a(n)	N/A	N/A

Note: N/A means Not applicable.

### 4.2. Block Diagram of Test Setup

For frequency range 30MHz-1000MHz

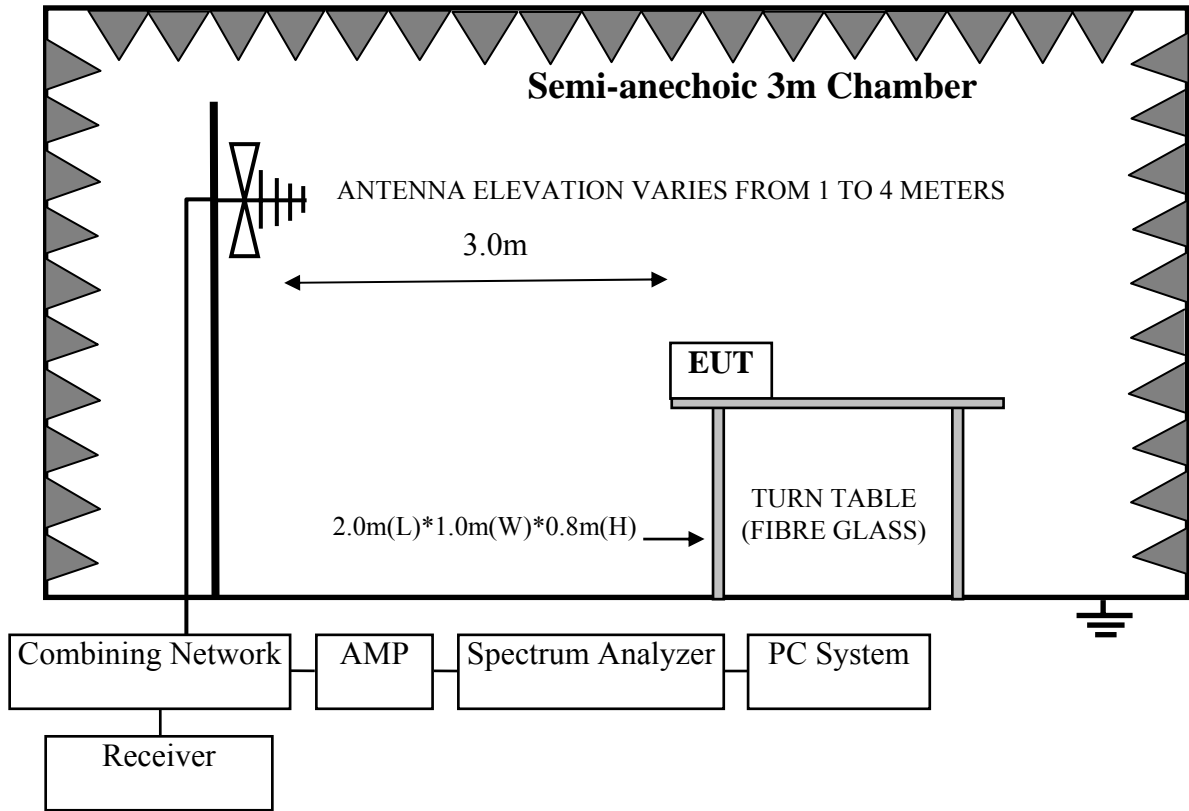

For frequency range 1GHz-25GHz

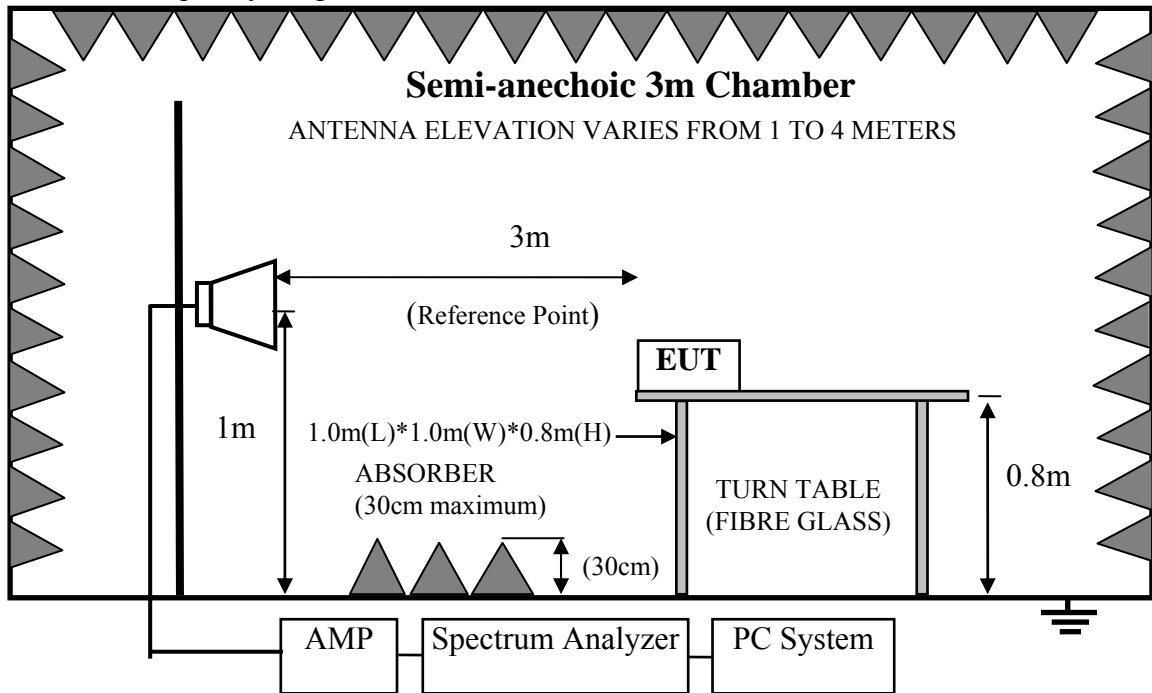

4.3. Radiated Emission Limit Standard: FCC 15.209

FREQUENCY MHz	DISTANCE Meters	FIELD STRENGTHS LIMIT	
		μV/m	dB(μV)/m
30 ~ 88	3	100	40.0
88 ~ 216	3	150	43.5
216 ~ 960	3	200	46.0
960 ~ 1000	3	500	54.0
Above 1000MHz	3	74.0 dB(μV)/m (Peak) 54.0 dB(μV)/m (Average)	

Remark : (1) Emission level  $dB\mu V = 20 \log$  Emission level  $\mu V/m$

- (2) The smaller limit shall apply at the cross point between two frequency bands.
- (3) Distance is the distance in meters between the measuring instrument, antenna and the closest point of any part of the device or system.
- (4) The emission limits shown in the above table are based on measurements employing a CISPR quasi-peak detector except for the frequency bands 9-90 kHz, 110-490 kHz and above 1000MHz. Radiated emission limits in these three bands are based on measurements employing an average detector.

4.4. EUT Configuration on Test

The following equipment are installed on Power Line Conducted Emission Test to meet the commission requirement and operating regulations in a manner which tends to maximize its emission characteristics in a normal application.

4.4.1. Mobile audio wall mount unit (EUT)

Model Number: JWM9A

Serial Number: N/A

4.4.2. Support Equipment: As Tested Supporting System Details, in Section 2.2.

4.5. Operating Condition of EUT

4.5.1. Setup the EUT and simulator as shown as Section 4.2.

4.5.2. Turn on the power of all equipments.

4.5.3. Let EUT work in Tx mode.

4.6. Test Procedure

EUT and its simulators are placed on a turn table, which is 0.8 meter high above ground for frequency 30MHz~1000MHz, 1.5 meter high above ground for frequency above 1GHz and put the absorbing with 2.4m(L)\*2.4m(W)\*0.3m(H) on the ground . The turn table can rotate 360 degrees to determine the position of the maximum emission level. Power on the EUT and let it working in test mode, then test it.EUT is set 3 meters away from the receiving antenna, which is mounted on a antenna tower. The antenna can be moved up and down between 1 meter and 4 meters to find out the maximum emission level. Broadband antenna (calibrated bilog antenna) is used as receiving antenna for frequency 30MHz~1000MHz, and the Horn antenna is used as receiving antenna for frequency above 1GHz. Both horizontal and vertical polarization of the antenna is set on Test. In order to find the maximum emission levels, all of the interface cables must be manipulated according to ANSI C63.10-2013 on radiated emission Test.

This test was performed with EUT in X, Y, Z position, and the worse case was found when EUT in X position as the test photo indicated.

The bandwidth of the EMI test receiver (R&S ESVS10) is set at 120kHz for frequency range from 30MHz to 1000 MHz.

The bandwidth of the Spectrum's RBW is set at 1MHz and VBW is set at 3MHz for peak emissions measurement above 1GHz

This device is pulse Modulated, a duty cycle factor was used to calculated average level based measured peak level.

The frequency range from 30MHz to 10th harmonic (25GHz) are checked. and no any emissions were found from 18GHz to 25 GHz, So the radiated emissions from 18GHz to 25GHz were not record.

4.7. Radiated Emission Test Results  
**PASS.**

All the emissions from 30MHz to 25GHz were comply with the 15.209 Limit.

Note: The duty cycle factor for calculate average level is -30.722dB, and average limit is 20dB below peak limit, so if peak measured level comply with average limit, the average level was deemed to comply with average limit.

$$\text{Duty cycle factor} = 20\log(\text{Dwell time}/100\text{ms}) = -30.722\text{dB}$$

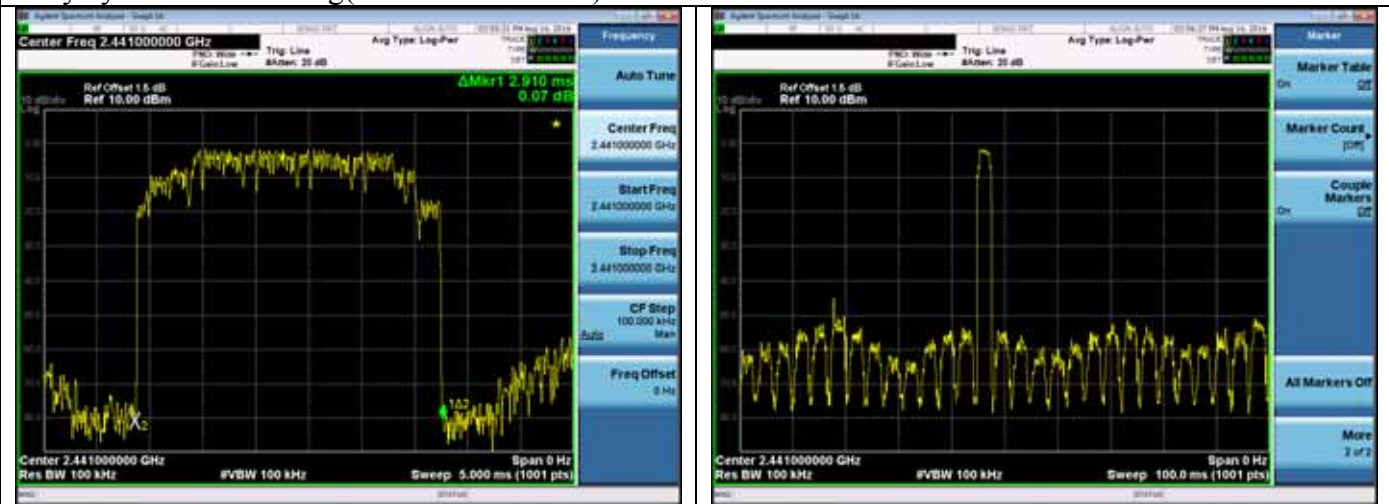



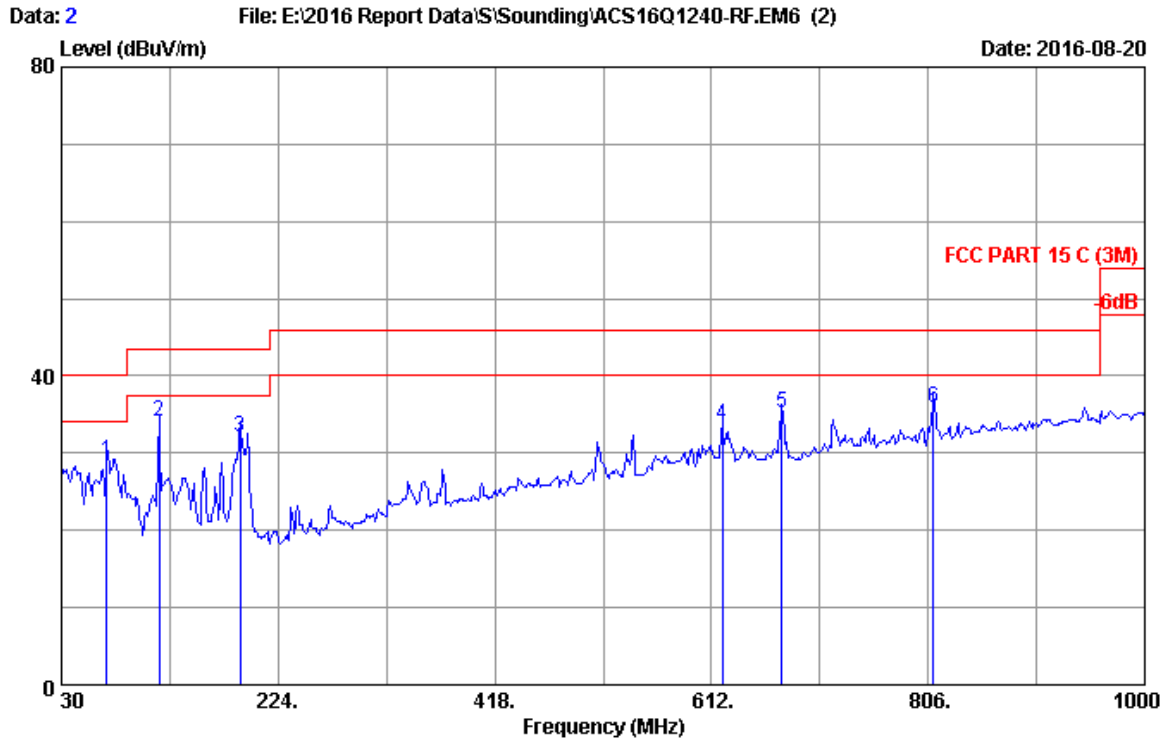

Site no. : 3m Chamber Data no. : 2  
 Dis. / Ant. : 3m 2016 9168 710 Ant. pol. : VERTICAL  
 Limit : FCC PART 15 C (3M)  
 Env. / Ins. : 23.8.0\*C/46% Engineer : Donjon  
 EUT : Mobile audio wall mount unit  
 Power rating : DC 12V  
 Test Mode : Tx Mode  
 M/N : JWM9A

No.	Freq. (MHz)	Ant. Factor (dB/m)	Cable Loss (dB)	Reading (dBuV)	Emission Level (dBuV/m)	Limits (dBuV/m)	Margin (dB)	Remark
1	70.740	17.61	0.96	10.49	29.06	40.00	10.94	QP
2	117.300	17.19	1.19	15.69	34.07	43.50	9.43	QP
3	190.050	17.19	1.51	13.46	32.16	43.50	11.34	QP
4	621.700	26.23	3.30	4.10	33.63	46.00	12.37	QP
5	675.050	26.68	3.53	5.11	35.32	46.00	10.68	QP
6	810.850	28.40	4.19	3.27	35.86	46.00	10.14	QP

Remarks: 1. Emission Level= Antenna Factor + Cable Loss + Reading.  
 2. The emission levels that are 20dB below the official limit are not reported.

### Frequency: 1GHz~18GHz

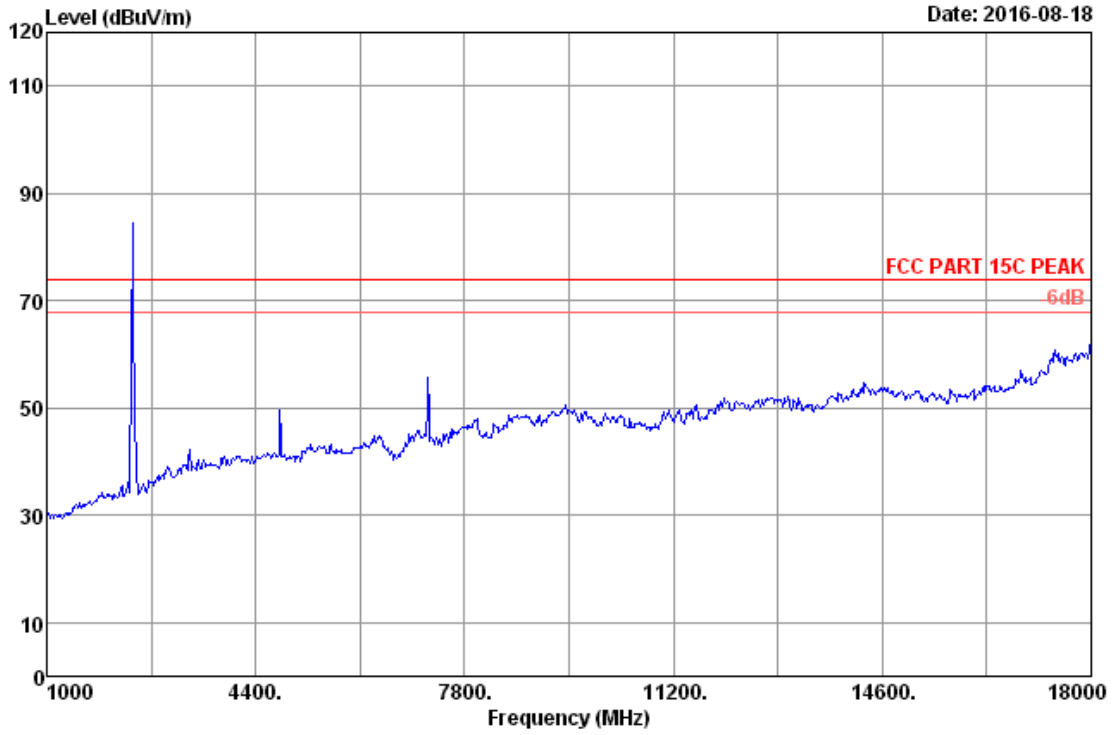

Site no.	: RF Chamber	Data no.	: 1
Dis. / Ant.	: 3m 2015 3115-4877	Ant. pol.	: HORIZONTAL
Limit	: FCC PART 15C PEAK	Pre	: 101.2kPa
Env. / Ins.	: 22.6°C/51.2%	Engineer	: Donjon_Huang
EUT	: Mobile audio wall mount unit		
Power rating	: DC 12V		
Test Mode	: GFSK 2402MHz Tx Mode		
M/N	: JWM9A		



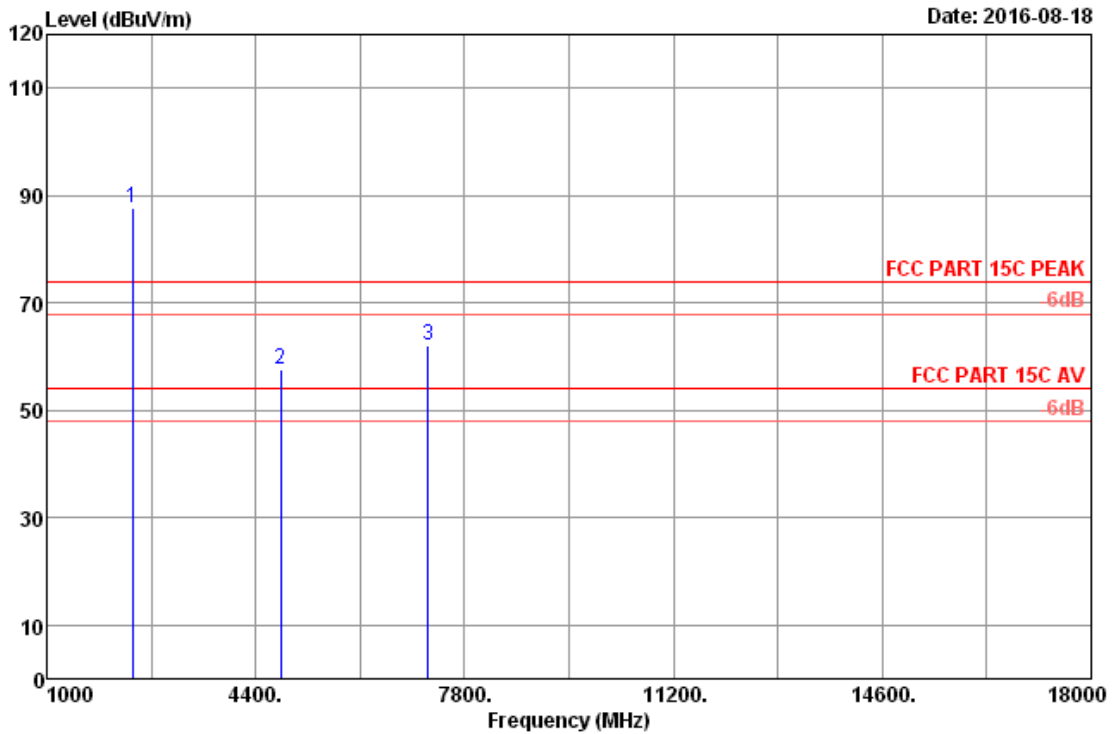

Site no. : RF Chamber Data no. : 2  
 Dis. / Ant. : 3m 2015 3115-4877 Ant. pol. : HORIZONTAL  
 Limit : FCC PART 15C PEAK Pre : 101.2kPa  
 Env. / Ins. : 22.6\*C/51.2% Engineer : Donjon\_Huang  
 EUT : Mobile audio wall mount unit  
 Power rating : DC 12V  
 Test Mode : GFSK 2402MHz Tx Mode  
 M/N : JWM9A

No.	Freq. (MHz)	Ant. Factor (dB/m)	Cable Loss (dB)	Reading (dBuV)	AMP factor (dB)	Emission Level (dBuV/m)	Limits (dBuV/m)	Margin (dB)	Remark
1	2402.00	28.28	8.34	87.55	36.39	87.78	74.00	-13.78	Peak
2	4804.00	33.11	11.75	48.35	35.67	57.54	74.00	16.46	Peak
3	7206.00	35.99	12.44	49.22	35.55	62.10	74.00	11.90	Peak

Remarks: 1. Emission Level= Antenna Factor + Cable Loss + Reading - Amp Factor  
 2. The emission levels that are 20dB below the official limit are not reported.

Frequency (MHz)	Original AV level (dBuV/m)	Duty cycle factor (dB)	Final AV level (dBuV/m)	Limit (dBuV/m)	Conclusion
4804.00	57.54	-30.722	26.818	54	Pass
7206.00	62.10	-30.722	31.378	54	Pass

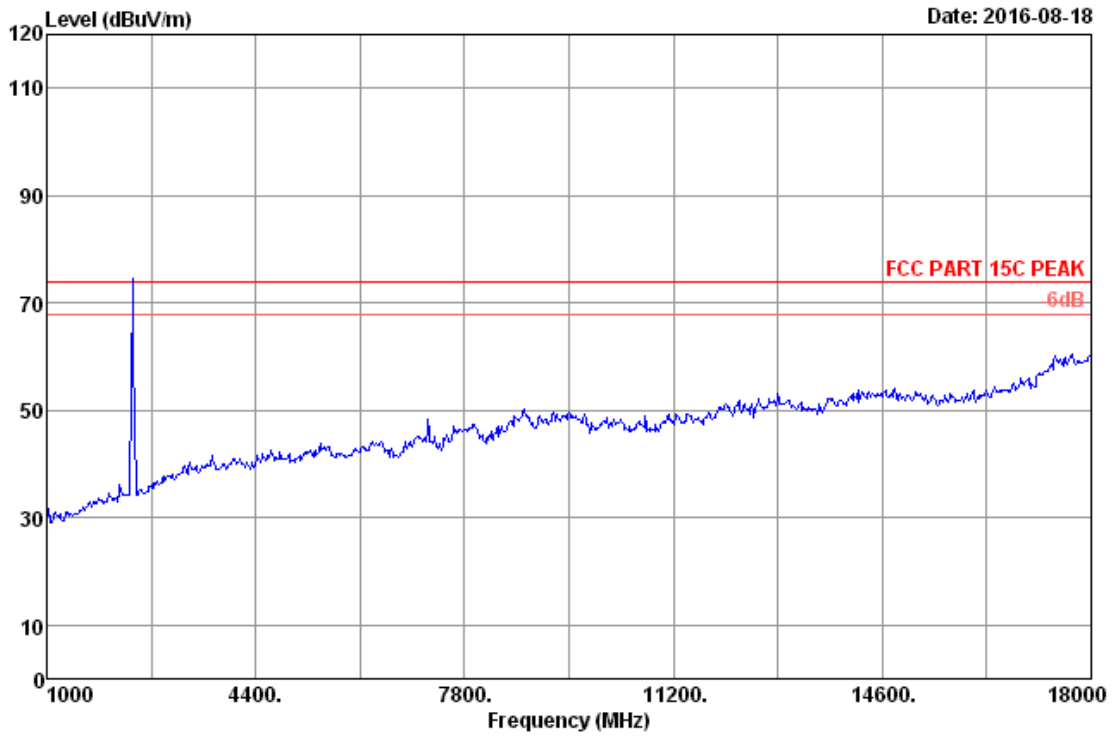

Site no.	: RF Chamber	Data no.	: 3
Dis. / Ant.	: 3m 2015 3115-4877	Ant. pol.	: VERTICAL
Limit	: FCC PART 15C PEAK	Pre	: 101.2kPa
Env. / Ins.	: 22.6*C/51.2%	Engineer	: Donjon_Huang
EUT	: Mobile audio wall mount unit		
Power rating	: DC 12V		
Test Mode	: GFSK 2402MHz Tx Mode		
M/N	: JWM9A		

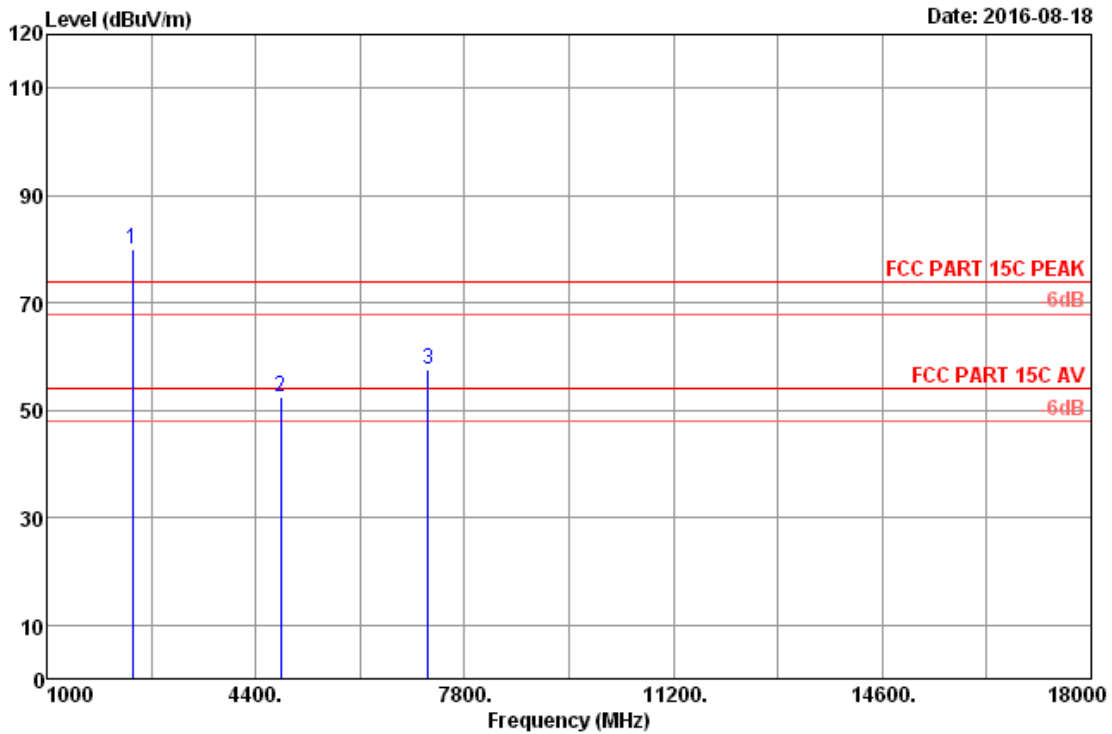

Site no. : RF Chamber Data no. : 4  
 Dis. / Ant. : 3m 2015 3115-4877 Ant. pol. : VERTICAL  
 Limit : FCC PART 15C PEAK Pre : 101.2kPa  
 Env. / Ins. : 22.6°C/51.2% Engineer : Donjon\_Huang  
 EUT : Mobile audio wall mount unit  
 Power rating : DC 12V  
 Test Mode : GFSK 2402MHz Tx Mode  
 M/N : JWM9A

No.	Freq. (MHz)	Ant. Factor (dB/m)	Cable Loss (dB)	Reading (dBuV)	AMP factor (dB)	Emission Level (dBuV/m)	Limits (dBuV/m)	Margin (dB)	Remark
1	2402.00	28.28	8.34	79.81	36.39	80.04	74.00	-6.04	Peak
2	4804.00	33.11	11.75	43.15	35.67	52.34	74.00	21.66	Peak
3	7206.00	35.99	12.44	44.74	35.55	57.62	74.00	16.38	Peak

Remarks: 1. Emission Level= Antenna Factor + Cable Loss + Reading - Amp Factor  
 2. The emission levels that are 20dB below the official limit are not reported.

Frequency (MHz)	Original AV level (dBuV/m)	Duty cycle factor (dB)	Final AV level (dBuV/m)	Limit(dBuv/m)	Conclusion
7206.00	57.62	-30.722	26.898	54	Pass

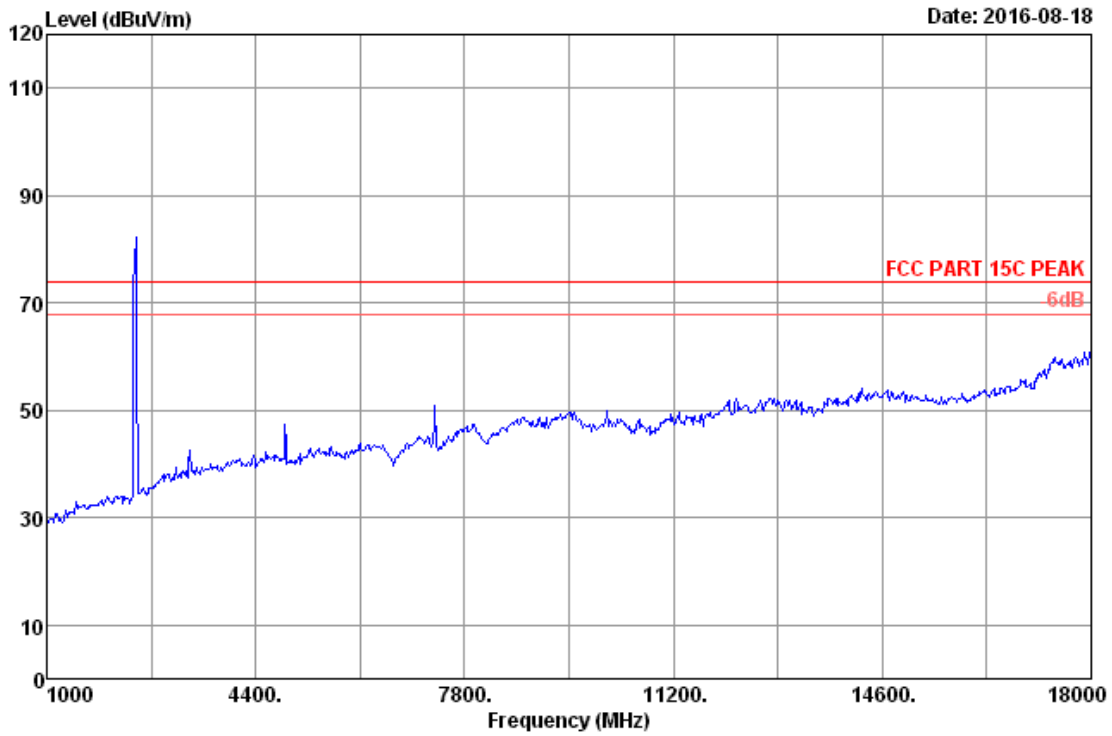

Site no. : RF Chamber  
Dis. / Ant. : 3m 2015 3115-4877  
Limit : FCC PART 15C PEAK  
Env. / Ins. : 22.6°C/51.2%  
EUT : Mobile audio wall mount unit  
Power rating : DC 12V  
Test Mode : GFSK 2441MHz Tx Mode  
M/N : JWM9A  
Data no. : 7  
Ant. pol. : HORIZONTAL  
Pre : 101.2kPa  
Engineer : Donjon\_Huang

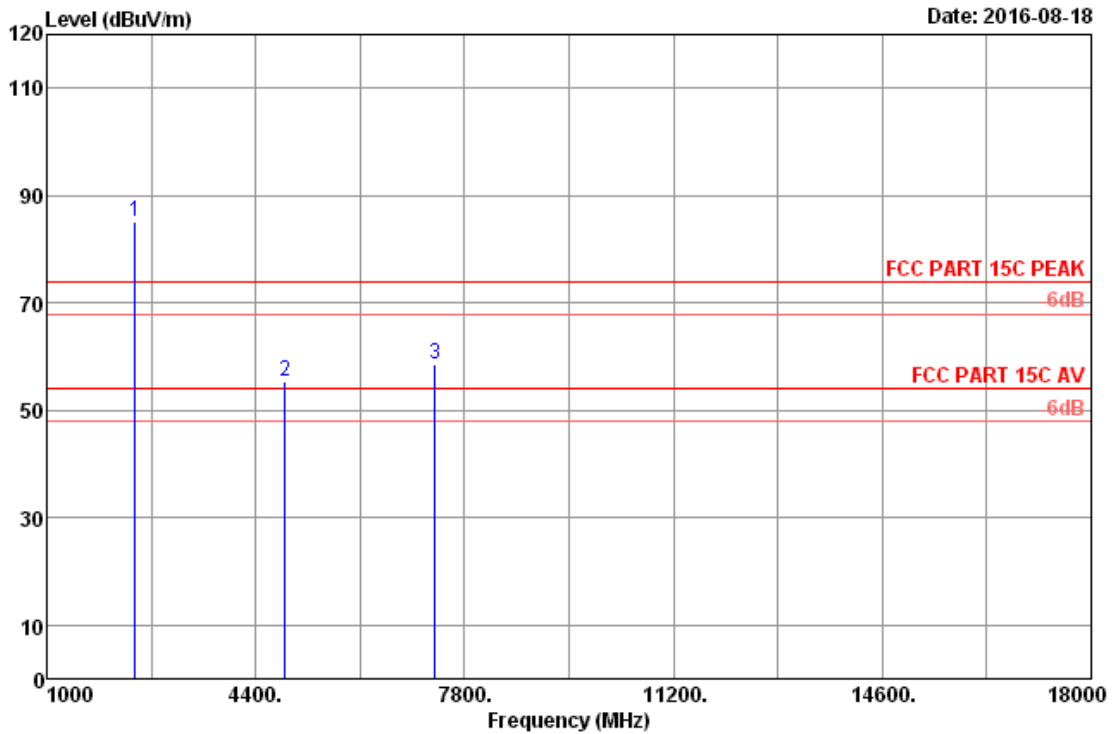

Site no. : RF Chamber Data no. : 8  
 Dis. / Ant. : 3m 2015 3115-4877 Ant. pol. : HORIZONTAL  
 Limit : FCC PART 15C PEAK Pre : 101.2kPa  
 Env. / Ins. : 22.6\*C/51.2% Engineer : Donjon\_Huang  
 EUT : Mobile audio wall mount unit  
 Power rating : DC 12V  
 Test Mode : GFSK 2441MHz Tx Mode  
 M/N : JWM9A

No.	Freq. (MHz)	Ant. Factor (dB/m)	Cable Loss (dB)	Reading (dBuV)	AMP factor (dB)	Emission Level (dBuV/m)	Limits (dBuV/m)	Margin (dB)	Remark
1	2441.00	28.33	8.38	84.74	36.38	85.07	74.00	-11.07	Peak
2	4882.00	33.26	11.80	46.14	35.69	55.51	74.00	18.49	Peak
3	7323.00	36.28	12.54	45.20	35.57	58.45	74.00	15.55	Peak

Remarks: 1. Emission Level= Antenna Factor + Cable Loss + Reading - Amp Factor  
 2. The emission levels that are 20dB below the official limit are not reported.

Frequency (MHz)	Original AV level (dBuV/m)	Duty cycle factor (dB)	Final AV level (dBuV/m)	Limit(dBuv/m)	Conclusion
4882.00	55.51	-30.722	24.788	54	Pass
7323.00	58.45	-30.722	27.728	54	Pass

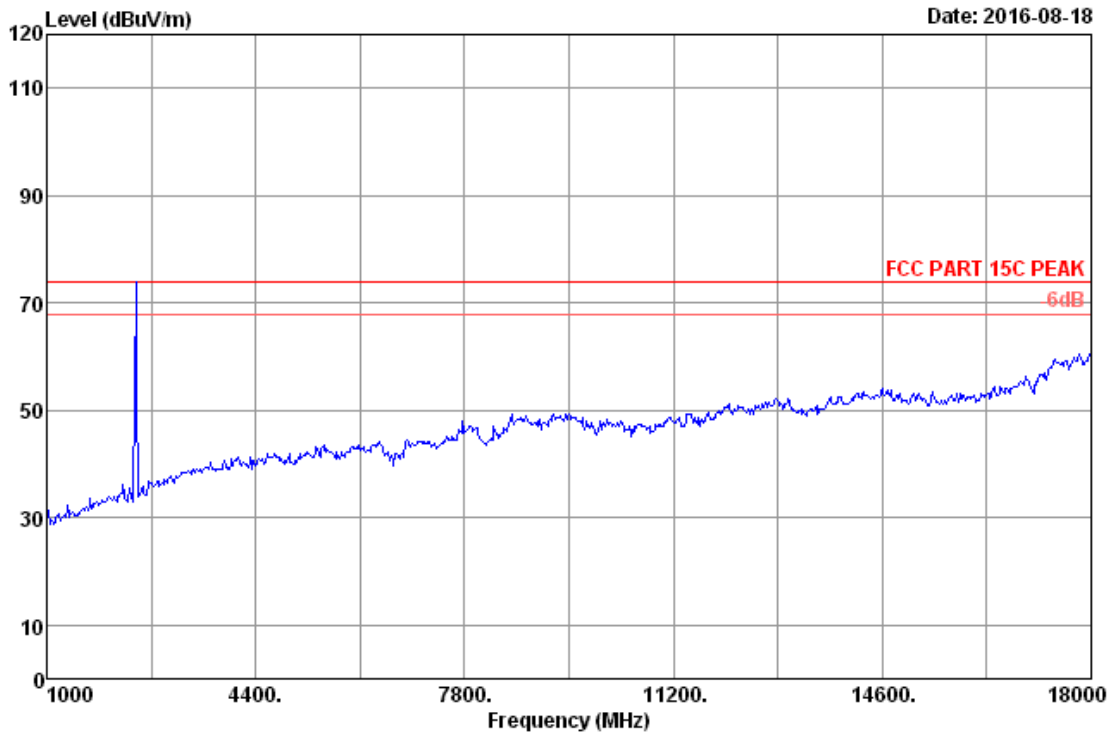

Site no.	: RF Chamber	Data no.	: 9
Dis. / Ant.	: 3m 2015 3115-4877	Ant. pol.	: VERTICAL
Limit	: FCC PART 15C PEAK	Pre	: 101.2kPa
Env. / Ins.	: 22.6*C/51.2%	Engineer	: Donjon_Huang
EUT	: Mobile audio wall mount unit		
Power rating	: DC 12V		
Test Mode	: GFSK 2441MHz Tx Mode		
M/N	: JWM9A		

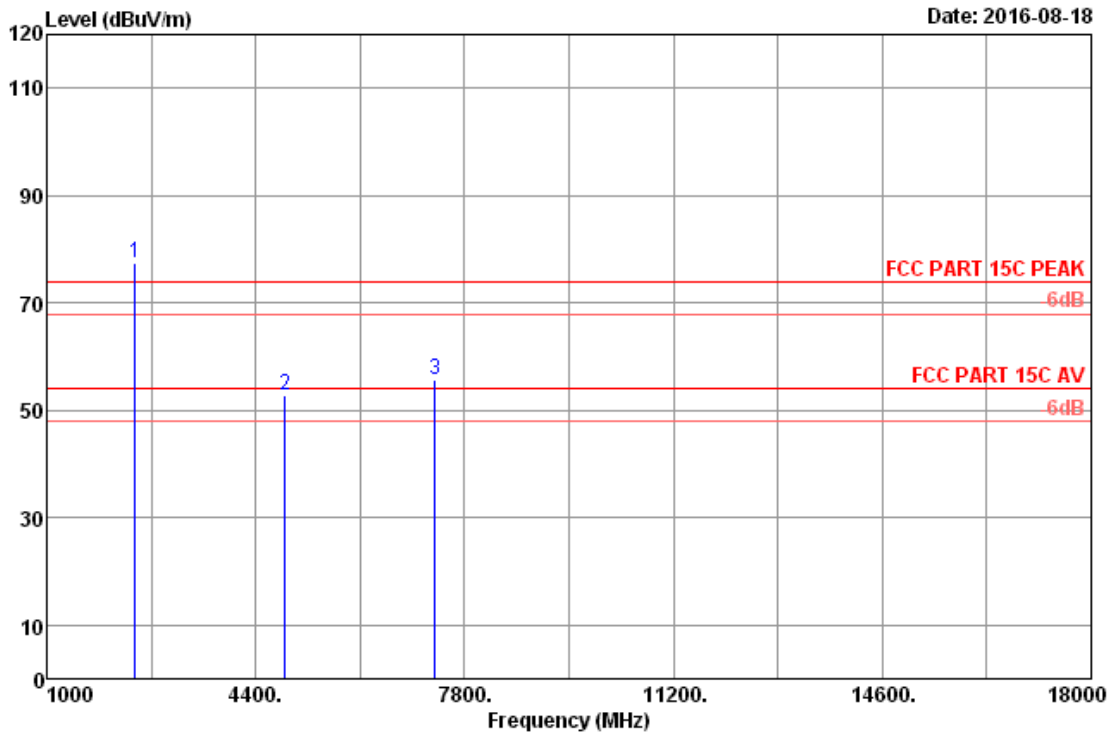

Site no. : RF Chamber  
 Dis. / Ant. : 3m 2015 3115-4877  
 Limit : FCC PART 15C PEAK  
 Env. / Ins. : 22.6°C/51.2%  
 EUT : Mobile audio wall mount unit  
 Power rating : DC 12V  
 Test Mode : GFSK 2441MHz Tx Mode  
 M/N : JWM9A

Data no. : 10  
 Ant. pol. : VERTICAL  
 Pre : 101.2kPa  
 Engineer : Donjon\_Huang

No.	Freq. (MHz)	Ant. Factor (dB/m)	Cable Loss (dB)	Reading (dBuV)	AMP factor (dB)	Emission Level (dBuV/m)	Limits (dBuV/m)	Margin (dB)	Remark
1	2441.00	28.33	8.38	76.99	36.38	77.32	74.00	-3.32	Peak
2	4882.00	33.26	11.80	43.51	35.69	52.88	74.00	21.12	Peak
3	7323.00	36.28	12.54	42.50	35.57	55.75	74.00	18.25	Peak

Remarks: 1. Emission Level= Antenna Factor + Cable Loss + Reading - Amp Factor  
 2. The emission levels that are 20dB below the official limit are not reported.

Frequency (MHz)	Original AV level (dBuV/m)	Duty cycle factor (dB)	Final AV level (dBuV/m)	Limit(dBuv/m)	Conclusion
7323.00	55.75	-30.722	25.028	54	Pass

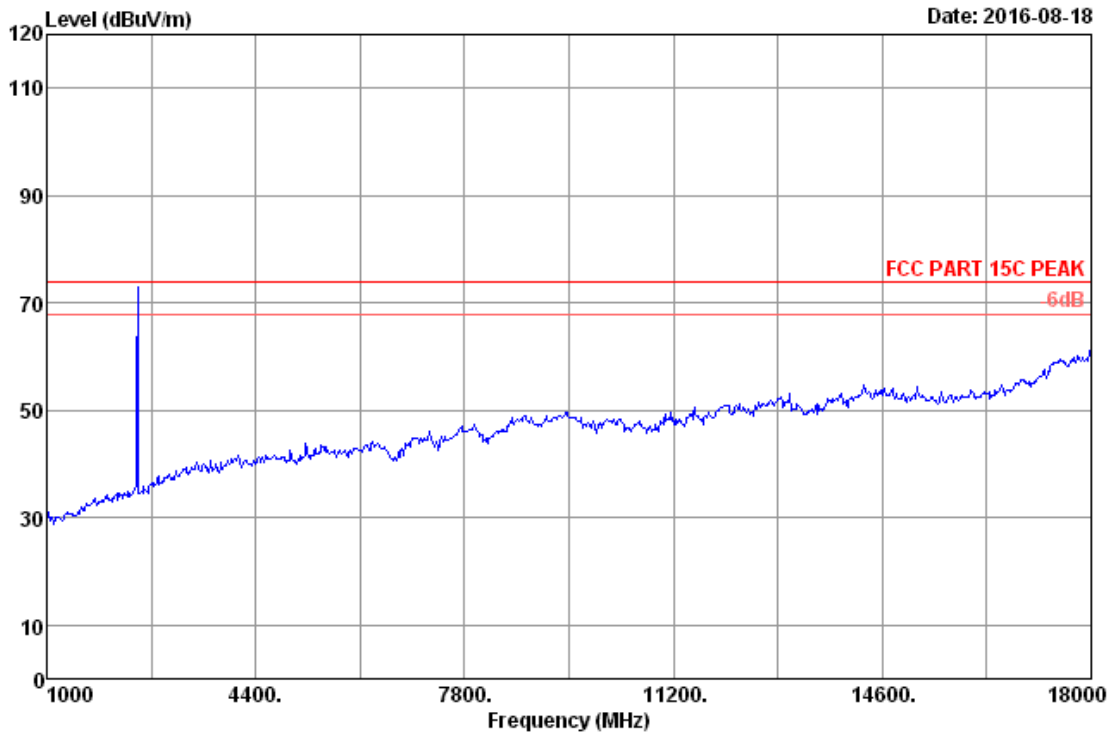

Site no.	: RF Chamber	Data no.	: 11
Dis. / Ant.	: 3m 2015 3115-4877	Ant. pol.	: VERTICAL
Limit	: FCC PART 15C PEAK	Pre	: 101.2kPa
Env. / Ins.	: 22.6°C/51.2%	Engineer	: Donjon_Huang
EUT	: Mobile audio wall mount unit		
Power rating	: DC 12V		
Test Mode	: GFSK 2480MHz Tx Mode		
M/N	: JWM9A		



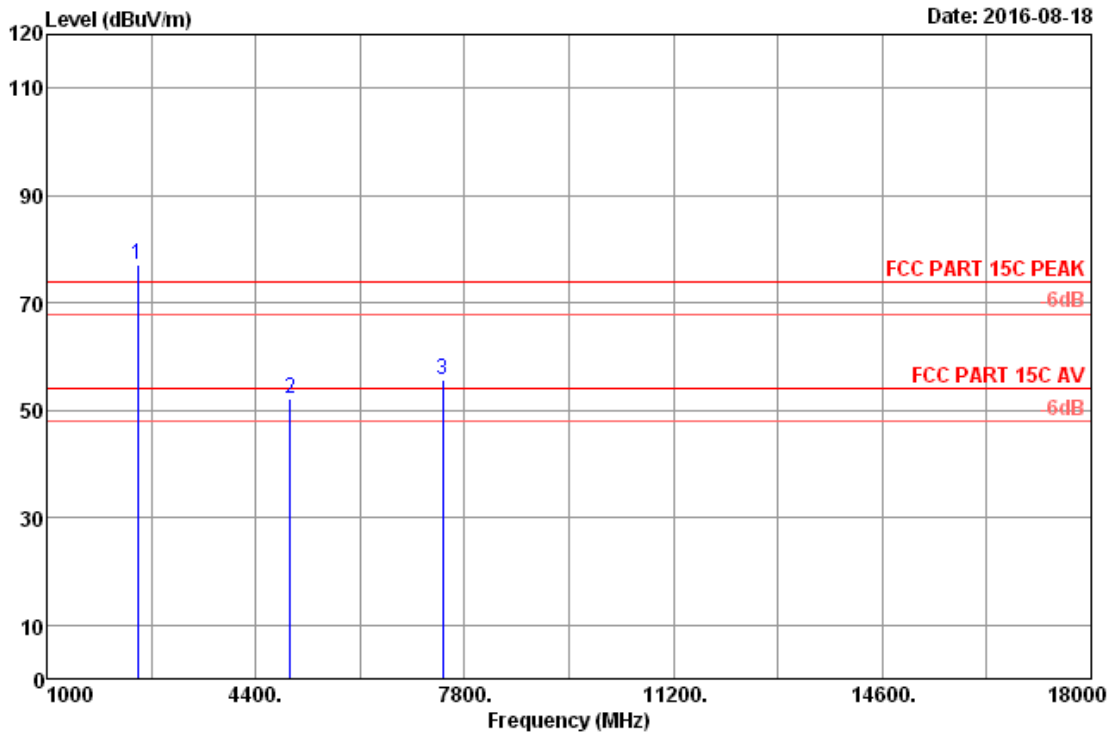

Site no. : RF Chamber  
 Dis. / Ant. : 3m 2015 3115-4877  
 Limit : FCC PART 15C PEAK  
 Env. / Ins. : 22.6°C/51.2%  
 EUT : Mobile audio wall mount unit  
 Power rating : DC 12V  
 Test Mode : GFSK 2480MHz Tx Mode  
 M/N : JWM9A

Data no. : 12  
 Ant. pol. : VERTICAL  
 Pre : 101.2kPa  
 Engineer : Donjon\_Huang

No.	Freq. (MHz)	Ant. Factor (dB/m)	Cable Loss (dB)	Reading (dBuV)	AMP factor (dB)	Emission Level (dBuV/m)	Limits (dBuV/m)	Margin (dB)	Remark
1	2480.00	28.38	8.42	76.74	36.38	77.16	74.00	-3.16	Peak
2	4960.00	33.42	11.85	42.52	35.71	52.08	74.00	21.92	Peak
3	7440.00	36.56	12.64	41.93	35.59	55.54	74.00	18.46	Peak

Remarks: 1. Emission Level= Antenna Factor + Cable Loss + Reading - Amp Factor  
 2. The emission levels that are 20dB below the official limit are not reported.

Frequency (MHz)	Original AV level (dBuV/m)	Duty cycle factor (dB)	Final AV level (dBuV/m)	Limit(dBuv/m)	Conclusion
7440.00	55.54	-30.722	24.818	54	Pass

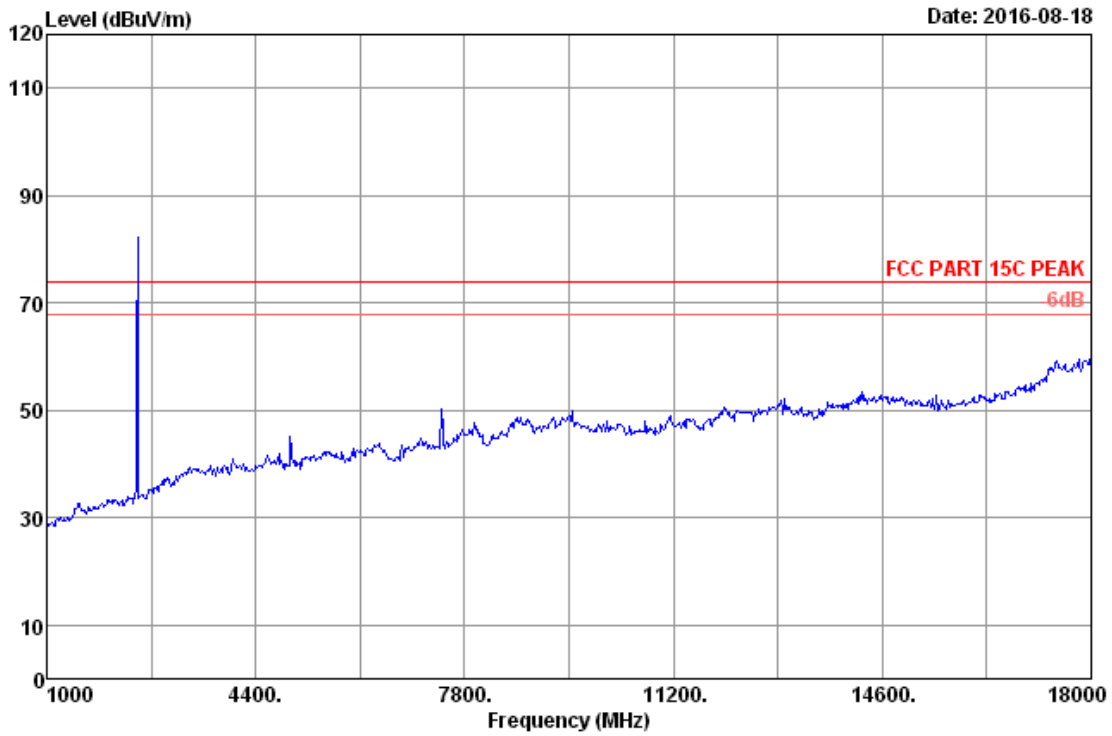

Site no.	: RF Chamber	Data no.	: 13
Dis. / Ant.	: 3m 2015 3115-4877	Ant. pol.	: HORIZONTAL
Limit	: FCC PART 15C PEAK	Pre	: 101.2kPa
Env. / Ins.	: 22.6°C/51.2%	Engineer	: Donjon_Huang
EUT	: Mobile audio wall mount unit		
Power rating	: DC 12V		
Test Mode	: GFSK 2480MHz Tx Mode		
M/N	: JWM9A		

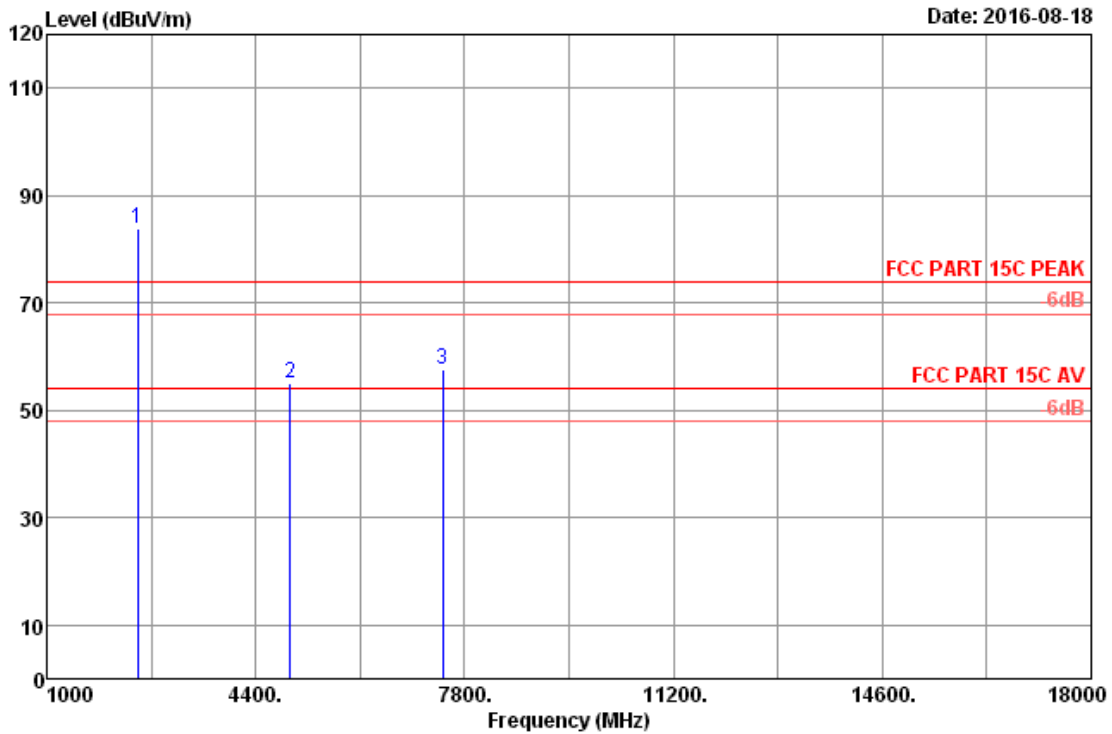

Site no. : RF Chamber  
 Dis. / Ant. : 3m 2015 3115-4877  
 Limit : FCC PART 15C PEAK  
 Env. / Ins. : 22.6°C/51.2%  
 EUT : Mobile audio wall mount unit  
 Power rating : DC 12V  
 Test Mode : GFSK 2480MHz Tx Mode  
 M/N : JWM9A

Data no. : 14  
 Ant. pol. : HORIZONTAL  
 Pre : 101.2kPa  
 Engineer : Donjon\_Huang

No.	Freq. (MHz)	Ant. Factor (dB/m)	Cable Loss (dB)	Reading (dBuV)	AMP factor (dB)	Emission Level (dBuV/m)	Limits (dBuV/m)	Margin (dB)	Remark
1	2480.00	28.38	8.42	83.52	36.38	83.94	74.00	-9.94	Peak
2	4960.00	33.42	11.85	45.48	35.71	55.04	74.00	18.96	Peak
3	7440.00	36.56	12.64	44.14	35.59	57.75	74.00	16.25	Peak

Remarks: 1. Emission Level= Antenna Factor + Cable Loss + Reading - Amp Factor  
 2. The emission levels that are 20dB below the official limit are not reported.

Frequency (MHz)	Original AV level (dBuV/m)	Duty cycle factor (dB)	Final AV level (dBuV/m)	Limit(dBuv/m)	Conclusion
4960.00	55.04	-30.722	24.318	54	Pass
7440.00	57.75	-30.722	27.028	54	Pass

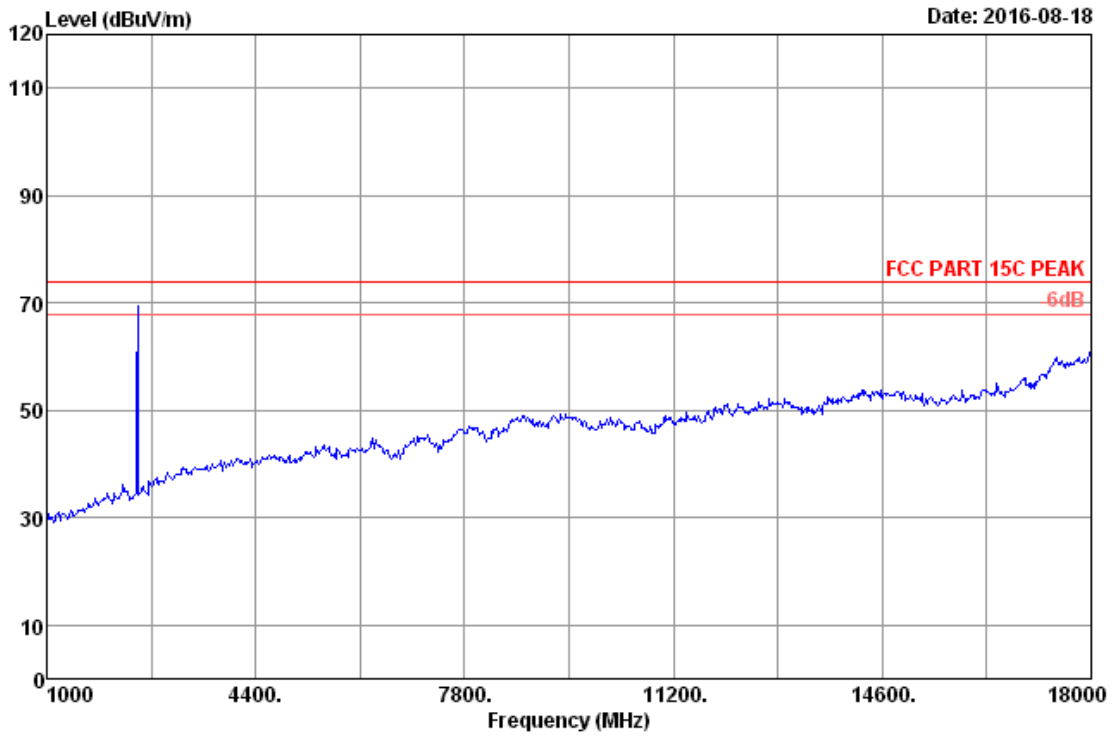

Site no.	: RF Chamber	Data no.	: 19
Dis. / Ant.	: 3m 2015 3115-4877	Ant. pol.	: VERTICAL
Limit	: FCC PART 15C PEAK	Pre	: 101.2kPa
Env. / Ins.	: 22.6*C/51.2%	Engineer	: Donjon_Huang
EUT	: Mobile audio wall mount unit		
Power rating	: DC 12V		
Test Mode	: 8-DPSK 2480MHz Tx Mode		
M/N	: JWM9A		

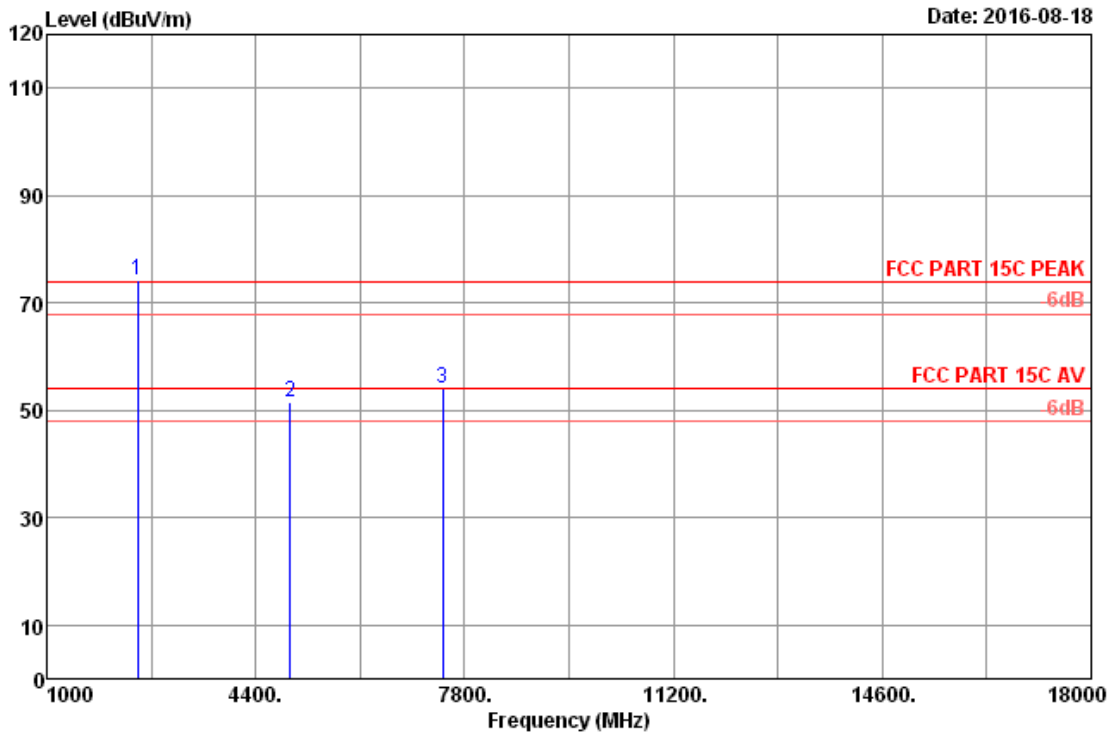

Site no. : RF Chamber Data no. : 20  
 Dis. / Ant. : 3m 2015 3115-4877 Ant. pol. : VERTICAL  
 Limit : FCC PART 15C PEAK Pre : 101.2kPa  
 Env. / Ins. : 22.6°C/51.2% Engineer : Donjon\_Huang  
 EUT : Mobile audio wall mount unit  
 Power rating : DC 12V  
 Test Mode : 8-DPSK 2480MHz Tx Mode  
 M/N : JWM9A

No.	Freq. (MHz)	Ant. Factor (dB/m)	Cable Loss (dB)	Reading (dBuV)	AMP factor (dB)	Emission Level (dBuV/m)	Limits (dBuV/m)	Margin (dB)	Remark
1	2480.00	28.38	8.42	73.73	36.38	74.15	74.00	-0.15	Peak
2	4960.00	33.42	11.85	41.86	35.71	51.42	74.00	22.58	Peak
3	7440.00	36.56	12.64	40.35	35.59	53.96	74.00	20.04	Peak

Remarks: 1. Emission Level= Antenna Factor + Cable Loss + Reading - Amp Factor  
 2. The emission levels that are 20dB below the official limit are not reported.



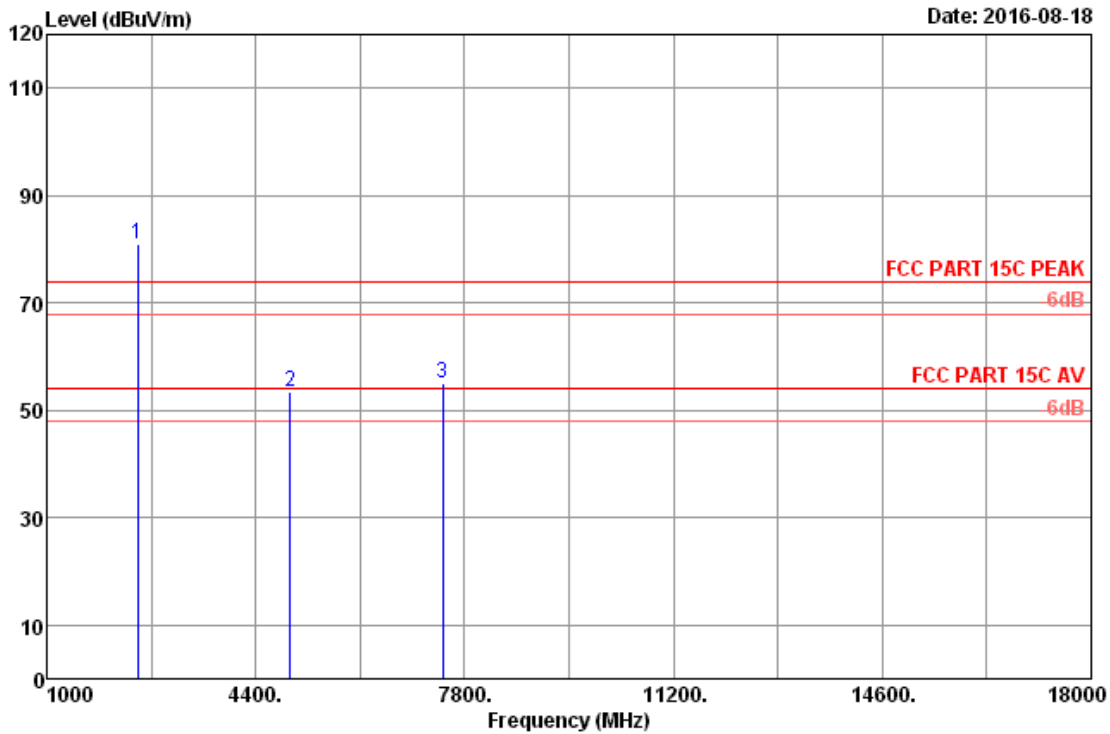

Site no. : RF Chamber Data no. : 22  
 Dis. / Ant. : 3m 2015 3115-4877 Ant. pol. : HORIZONTAL  
 Limit : FCC PART 15C PEAK Pre : 101.2kPa  
 Env. / Ins. : 22.6\*C/51.2% Engineer : Donjon\_Huang  
 EUT : Mobile audio wall mount unit  
 Power rating : DC 12V  
 Test Mode : 8-DPSK 2480MHz Tx Mode  
 M/N : JWM9A

No.	Freq. (MHz)	Ant. Factor (dB/m)	Cable Loss (dB)	Reading (dBuV)	AMP factor (dB)	Emission Level (dBuV/m)	Limits (dBuV/m)	Margin (dB)	Remark
1	2480.00	28.38	8.42	80.42	36.38	80.84	74.00	-6.84	Peak
2	4960.00	33.42	11.85	43.88	35.71	53.44	74.00	20.56	Peak
3	7440.00	36.56	12.64	41.50	35.59	55.11	74.00	18.89	Peak

Remarks: 1. Emission Level= Antenna Factor + Cable Loss + Reading - Amp Factor  
 2. The emission levels that are 20dB below the official limit are not reported.

Frequency (MHz)	Original AV level (dBuV/m)	Duty cycle factor (dB)	Final AV level (dBuV/m)	Limit(dBuv/m)	Conclusion
7440.00	55.11	-30.722	24.388	54	Pass

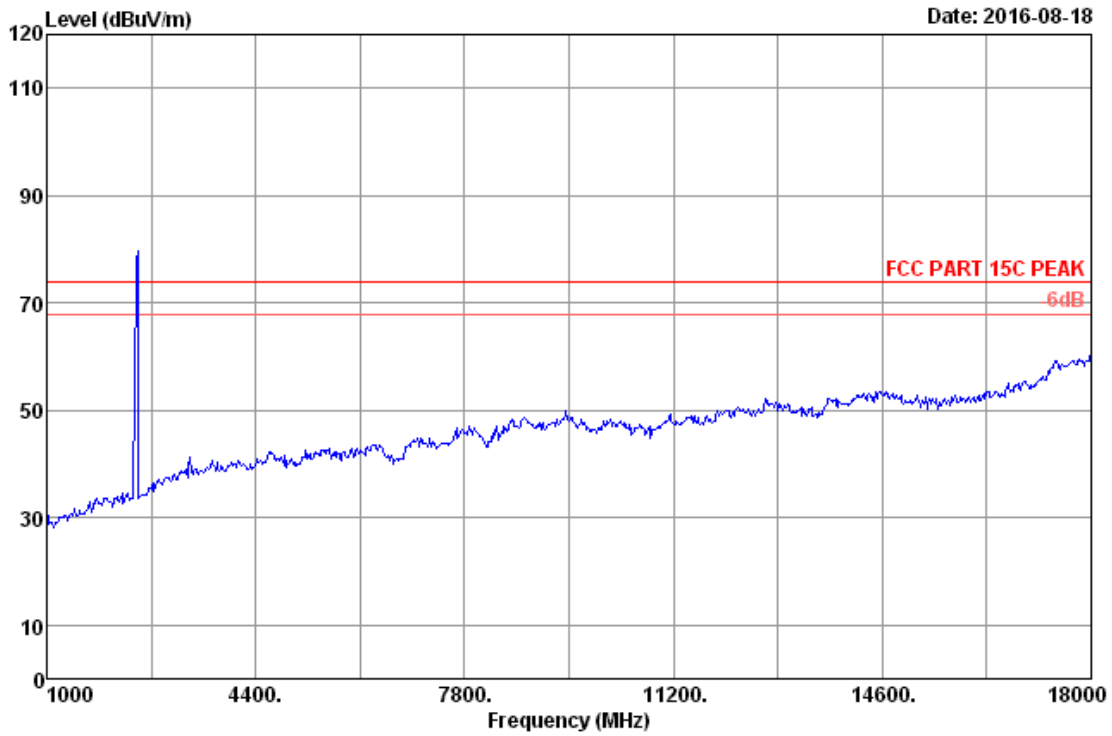

Site no.	: RF Chamber	Data no.	: 23
Dis. / Ant.	: 3m 2015 3115-4877	Ant. pol.	: HORIZONTAL
Limit	: FCC PART 15C PEAK	Pre	: 101.2kPa
Env. / Ins.	: 22.6*C/51.2%	Engineer	: Donjon_Huang
EUT	: Mobile audio wall mount unit		
Power rating	: DC 12V		
Test Mode	: 8-DPSK 2441MHz Tx Mode		
M/N	: JWM9A		



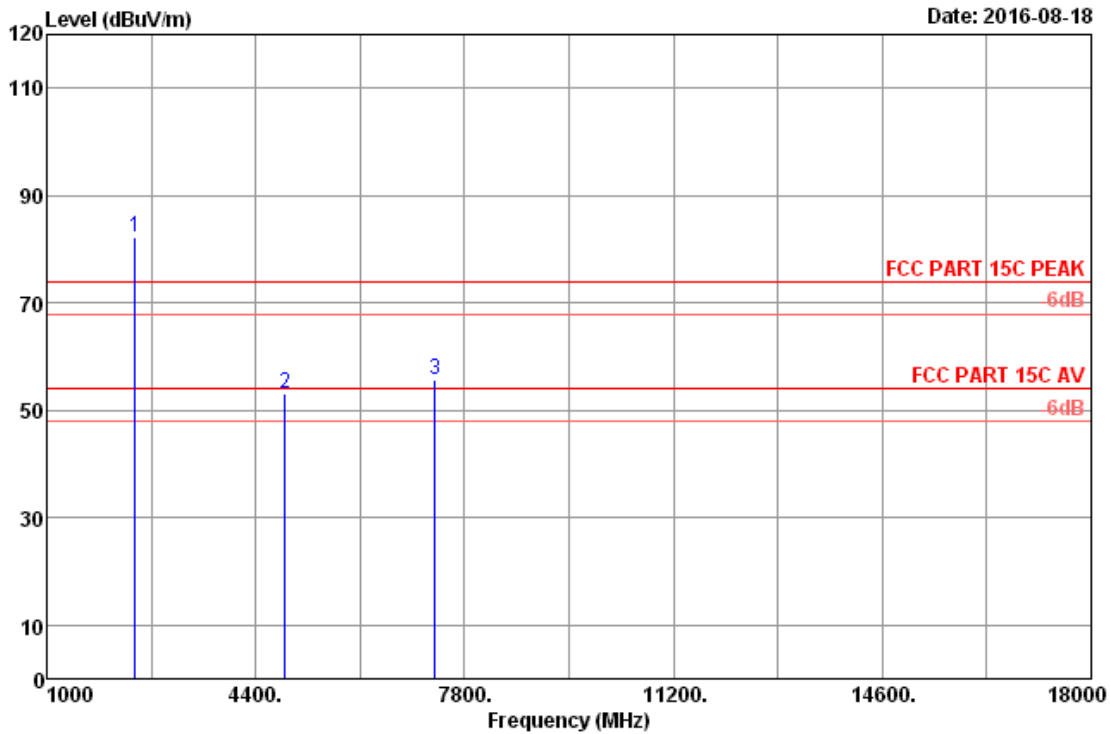

Site no. : RF Chamber Data no. : 24  
 Dis. / Ant. : 3m 2015 3115-4877 Ant. pol. : HORIZONTAL  
 Limit : FCC PART 15C PEAK Pre : 101.2kPa  
 Env. / Ins. : 22.6\*C/51.2% Engineer : Donjon\_Huang  
 EUT : Mobile audio wall mount unit  
 Power rating : DC 12V  
 Test Mode : 8-DPSK 2441MHz Tx Mode  
 M/N : JWM9A

No.	Freq. (MHz)	Ant. Factor (dB/m)	Cable Loss (dB)	Reading (dBuV)	AMP factor (dB)	Emission Level (dBuV/m)	Limits (dBuV/m)	Margin (dB)	Remark
1	2441.00	28.33	8.38	81.93	36.38	82.26	74.00	-8.26	Peak
2	4882.00	33.26	11.80	43.64	35.69	53.01	74.00	20.99	Peak
3	7323.00	36.28	12.54	42.38	35.57	55.63	74.00	18.37	Peak

Remarks: 1. Emission Level= Antenna Factor + Cable Loss + Reading - Amp Factor  
 2. The emission levels that are 20dB below the official limit are not reported.

Frequency (MHz)	Original AV level (dBuV/m)	Duty cycle factor (dB)	Final AV level (dBuV/m)	Limit(dBuv/m)	Conclusion
7323.00	55.63	-30.722	24.908	54	Pass

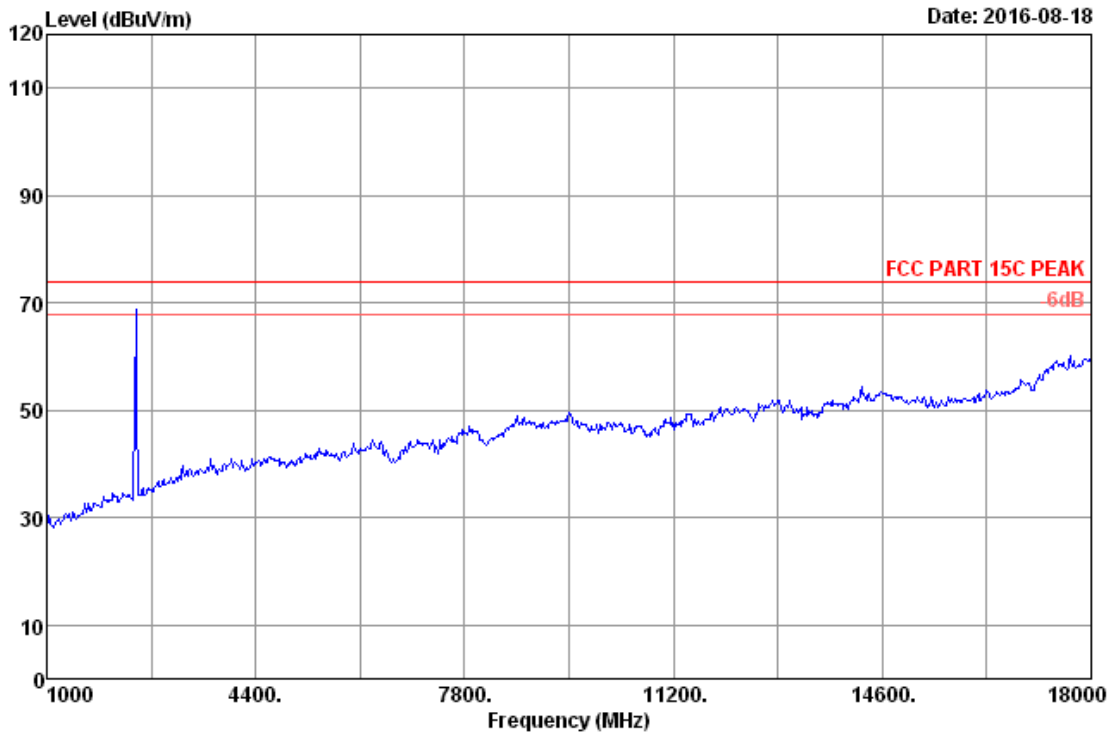

Site no.	: RF Chamber	Data no.	: 25
Dis. / Ant.	: 3m 2015 3115-4877	Ant. pol.	: VERTICAL
Limit	: FCC PART 15C PEAK	Pre	: 101.2kPa
Env. / Ins.	: 22.6*C/51.2%	Engineer	: Donjon_Huang
EUT	: Mobile audio wall mount unit		
Power rating	: DC 12V		
Test Mode	: 8-DPSK 2441MHz Tx Mode		
M/N	: JWM9A		

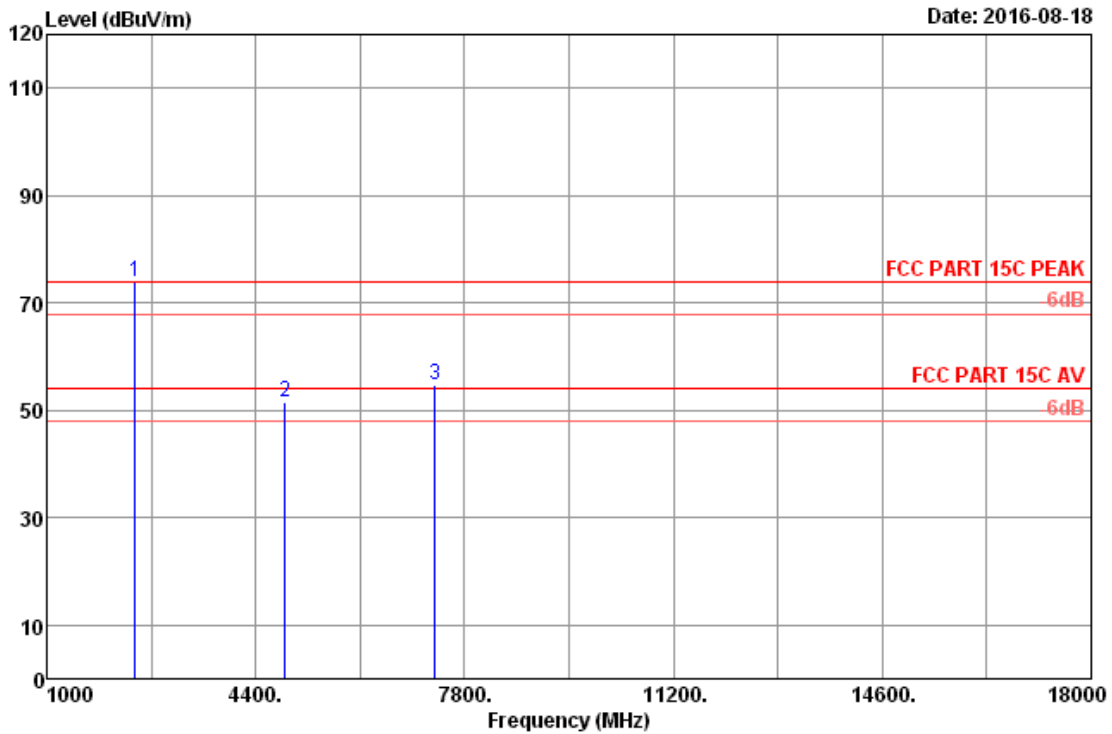

Site no. : RF Chamber Data no. : 26  
 Dis. / Ant. : 3m 2015 3115-4877 Ant. pol. : VERTICAL  
 Limit : FCC PART 15C PEAK Pre : 101.2kPa  
 Env. / Ins. : 22.6°C/51.2% Engineer : Donjon\_Huang  
 EUT : Mobile audio wall mount unit  
 Power rating : DC 12V  
 Test Mode : 8-DPSK 2441MHz Tx Mode  
 M/N : JWM9A

No.	Freq. (MHz)	Ant. Factor (dB/m)	Cable Loss (dB)	Reading (dBuV)	AMP factor (dB)	Emission Level (dBuV/m)	Limits (dBuV/m)	Margin (dB)	Remark
1	2441.00	28.33	8.38	73.62	36.38	73.95	74.00	0.05	Peak
2	4882.00	33.26	11.80	42.09	35.69	51.46	74.00	22.54	Peak
3	7323.00	36.28	12.54	41.41	35.57	54.66	74.00	19.34	Peak

Remarks: 1. Emission Level= Antenna Factor + Cable Loss + Reading - Amp Factor  
 2. The emission levels that are 20dB below the official limit are not reported.

Frequency (MHz)	Original AV level (dBuV/m)	Duty cycle factor (dB)	Final AV level (dBuV/m)	Limit(dBuv/m)	Conclusion
7323.00	54.66	-30.722	23.938	54	Pass

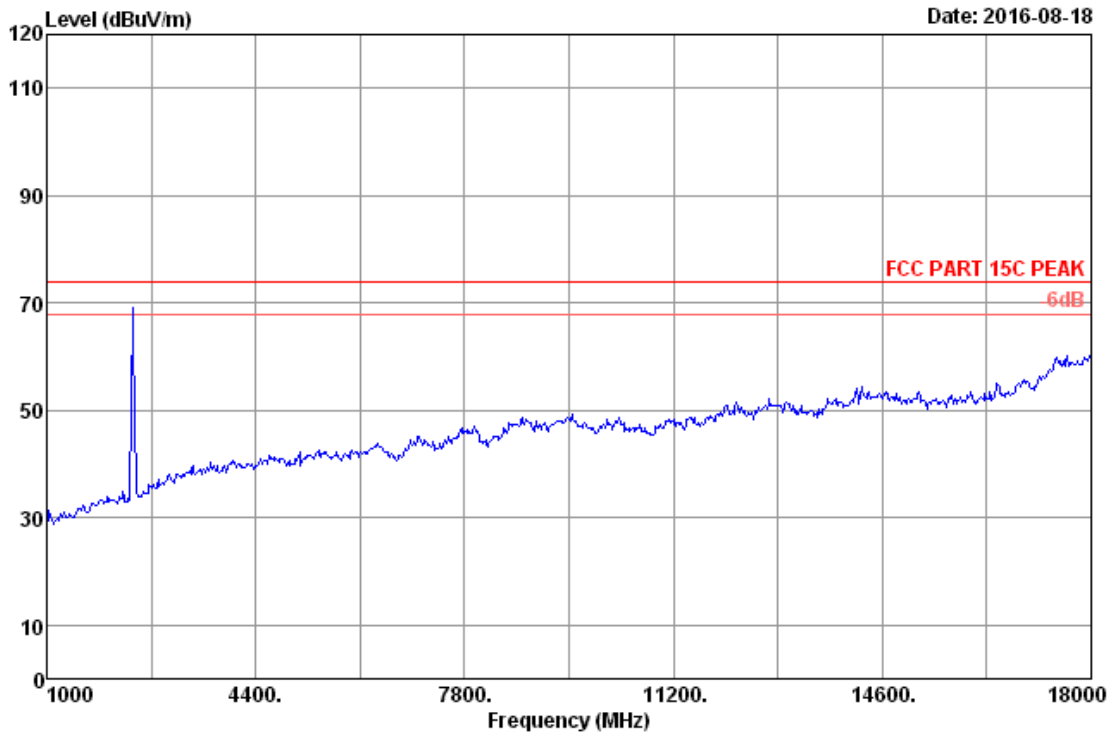

Site no.	: RF Chamber	Data no.	: 27
Dis. / Ant.	: 3m 2015 3115-4877	Ant. pol.	: VERTICAL
Limit	: FCC PART 15C PEAK	Pre	: 101.2kPa
Env. / Ins.	: 22.6°C/51.2%	Engineer	: Donjon_Huang
EUT	: Mobile audio wall mount unit		
Power rating	: DC 12V		
Test Mode	: 8-DPSK 2402MHz Tx Mode		
M/N	: JWM9A		

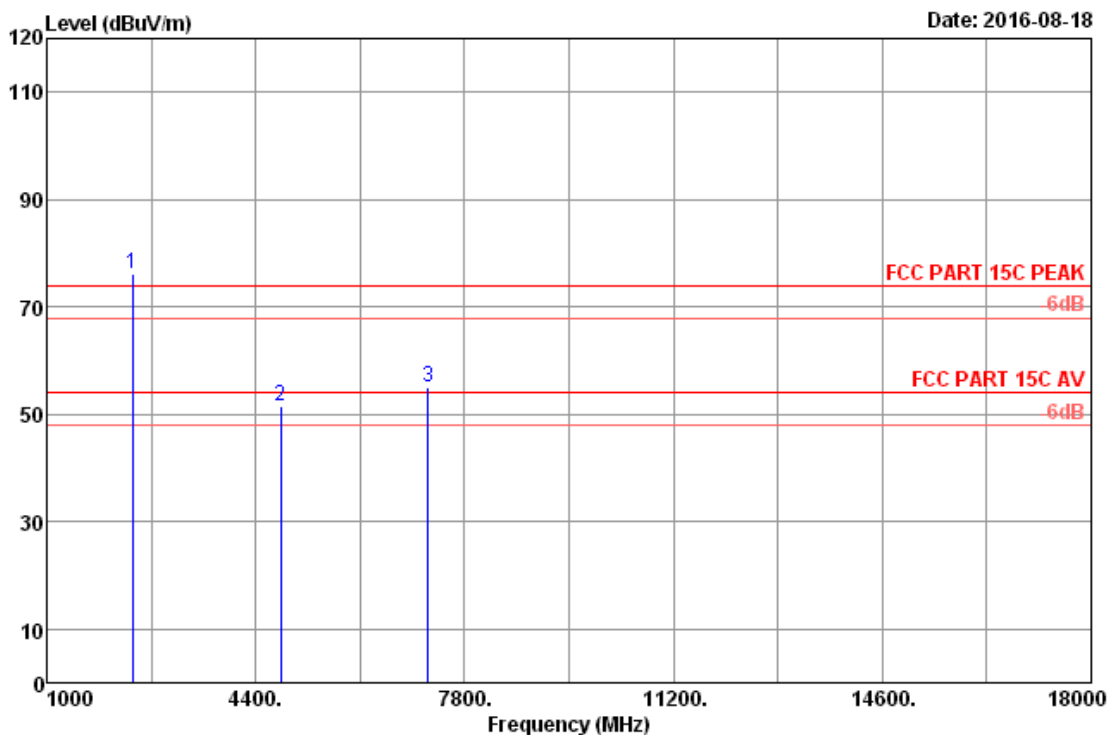

Site no. : RF Chamber Data no. : 28  
 Dis. / Ant. : 3m 2015 3115-4877 Ant. pol. : VERTICAL  
 Limit : FCC PART 15C PEAK Pre : 101.2kPa  
 Env. / Ins. : 22.6°C/51.2% Engineer : Donjon\_Huang  
 EUT : Mobile audio wall mount unit  
 Power rating : DC 12V  
 Test Mode : 8-DPSK 2402MHz Tx Mode  
 M/N : JWM9A

No.	Freq. (MHz)	Ant. Factor (dB/m)	Cable Loss (dB)	Reading (dBuV)	AMP factor (dB)	Emission Level (dBuV/m)	Limits (dBuV/m)	Margin (dB)	Remark
1	2402.00	28.28	8.34	75.99	36.39	76.22	74.00	-2.22	Peak
2	4804.00	33.11	11.75	42.23	35.67	51.42	74.00	22.58	Peak
3	7206.00	35.99	12.44	42.08	35.55	54.96	74.00	19.04	Peak

Remarks: 1. Emission Level= Antenna Factor + Cable Loss + Reading - Amp Factor  
 2. The emission levels that are 20dB below the official limit are not reported.

Frequency (MHz)	Original AV level (dBuV/m)	Duty cycle factor (dB)	Final AV level (dBuV/m)	Limit(dBuv/m)	Conclusion
7206.00	54.96	-30.722	24.238	54	Pass

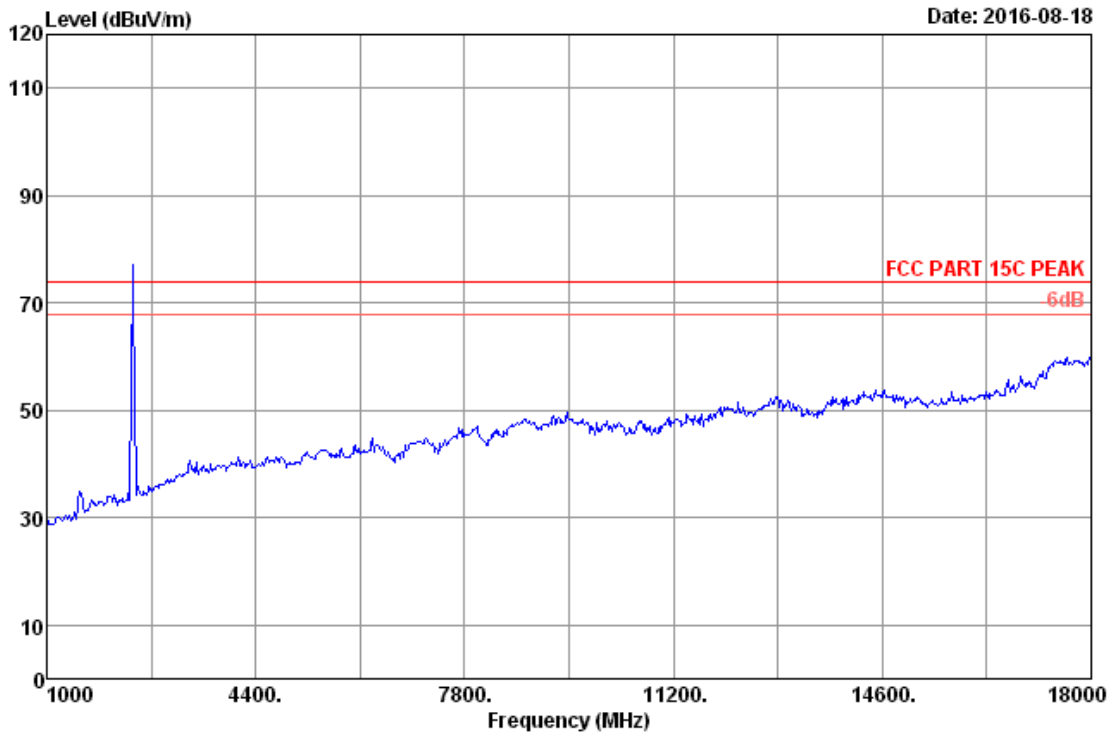

Site no.	: RF Chamber	Data no.	: 29
Dis. / Ant.	: 3m 2015 3115-4877	Ant. pol.	: HORIZONTAL
Limit	: FCC PART 15C PEAK	Pre	: 101.2kPa
Env. / Ins.	: 22.6*C/51.2%	Engineer	: Donjon_Huang
EUT	: Mobile audio wall mount unit		
Power rating	: DC 12V		
Test Mode	: 8-DPSK 2402MHz Tx Mode		
M/N	: JWM9A		

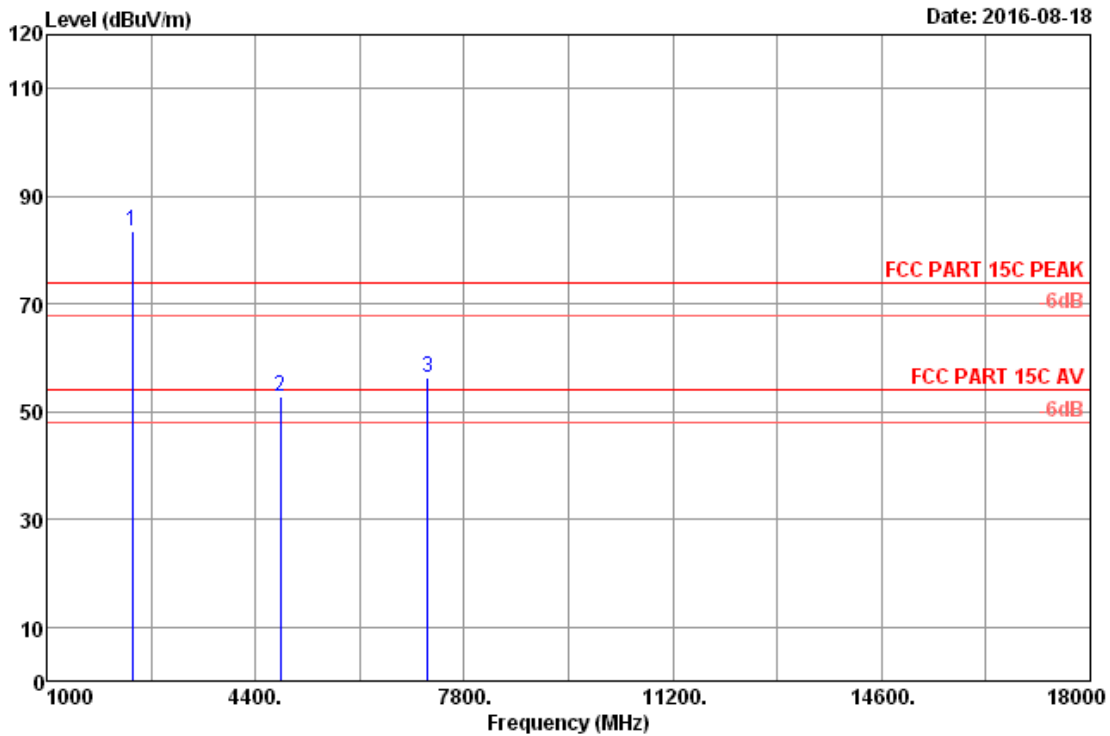

Site no. : RF Chamber  
 Dis. / Ant. : 3m 2015 3115-4877  
 Limit : FCC PART 15C PEAK  
 Env. / Ins. : 22.6°C/51.2%  
 EUT : Mobile audio wall mount unit  
 Power rating : DC 12V  
 Test Mode : 8-DPSK 2402MHz Tx Mode  
 M/N : JWM9A  
 Data no. : 30  
 Ant. pol. : HORIZONTAL  
 Pre : 101.2kPa  
 Engineer : Donjon\_Huang

No.	Freq. (MHz)	Ant. Factor (dB/m)	Cable Loss (dB)	Reading (dBuV)	AMP factor (dB)	Emission Level (dBuV/m)	Limits (dBuV/m)	Margin (dB)	Remark
1	2402.00	28.28	8.34	83.30	36.39	83.53	74.00	-9.53	Peak
2	4804.00	33.11	11.75	43.47	35.67	52.66	74.00	21.34	Peak
3	7206.00	35.99	12.44	43.44	35.55	56.32	74.00	17.68	Peak

Remarks: 1. Emission Level= Antenna Factor + Cable Loss + Reading - Amp Factor  
 2. The emission levels that are 20dB below the official limit are not reported.

Frequency (MHz)	Original AV level (dBuV/m)	Duty cycle factor (dB)	Final AV level (dBuV/m)	Limit(dBuv/m)	Conclusion
7206.00	56.32	-30.722	25.598	54	Pass

## 5. CONDUCTED SPURIOUS EMISSIONS

### 5.1. Test Equipments

Item	Equipment	Manufacturer	Model No.	Serial No.	Last Cal.	Cal. Interval
1.	Spectrum	Agilent	N9030A	MY51380221	Oct.17,15	1 Year
2.	Attenuator (20dB)	Agilent	8491B	MY39262165	Apr.23,16	1 Year
3.	RF Cable	Marvelous Microwave Inc	SFL402105FLEX	NO.1	Oct.17,15	1 Year

### 5.2. Limit

In any 100kHz bandwidth outside the frequency bands in which the spread spectrum intentional radiator is operating, the radio frequency power that is produced by the intentional radiator shall be at least 20dB below that in the 100kHz bandwidth within the band that contains the highest level of the desired power.

### 5.3. Test Procedure

The transmitter output was connected to a spectrum analyzer, the resolution bandwidth is set to 100 kHz, the video bandwidth is set to 300 kHz and measure all the emissions detected.

### 5.4. Test result

**PASS** (The testing data was attached in the next pages.)



**Hopping Off  
GFSK  
2402MHz**

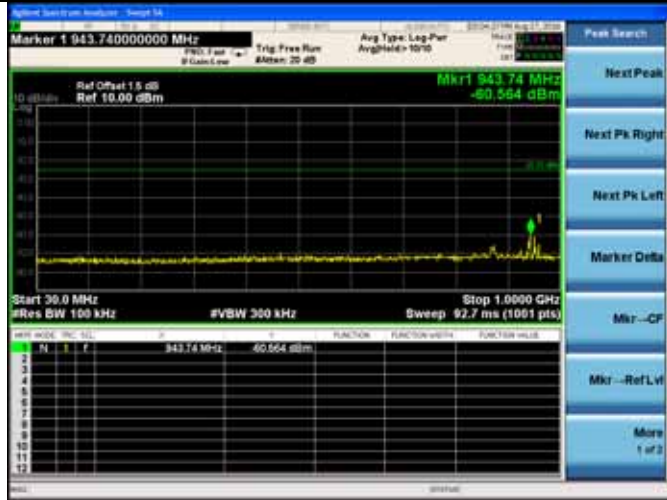

**2441MHz**

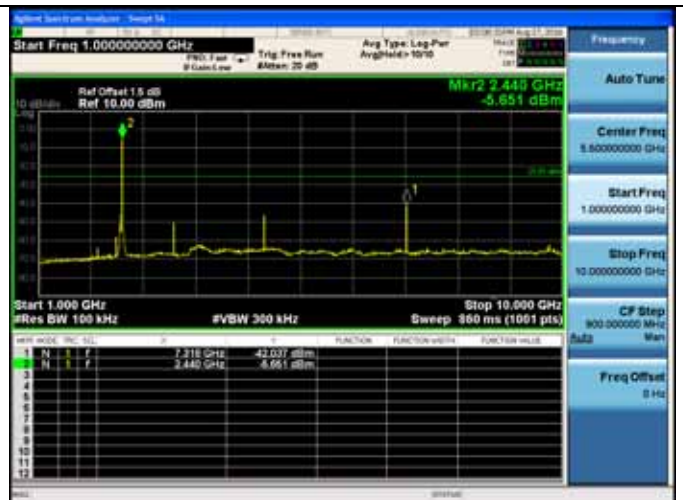
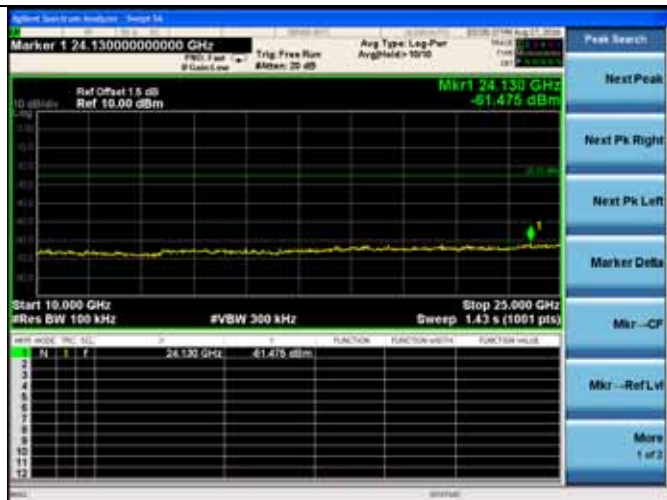
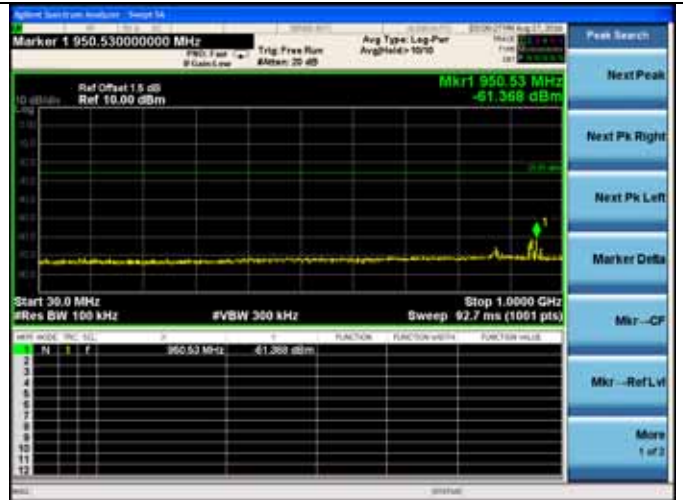
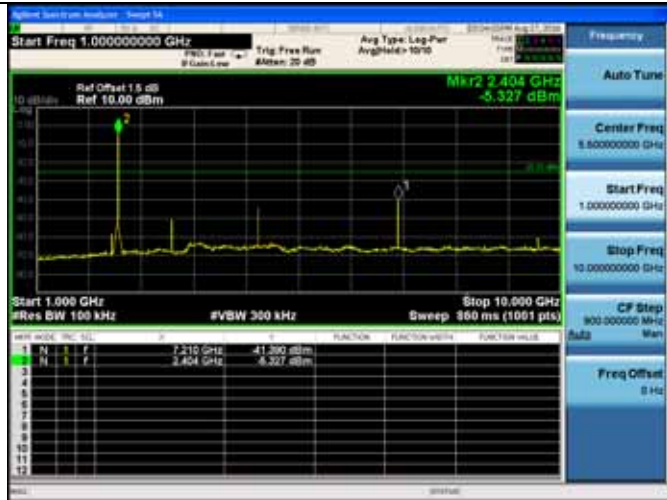

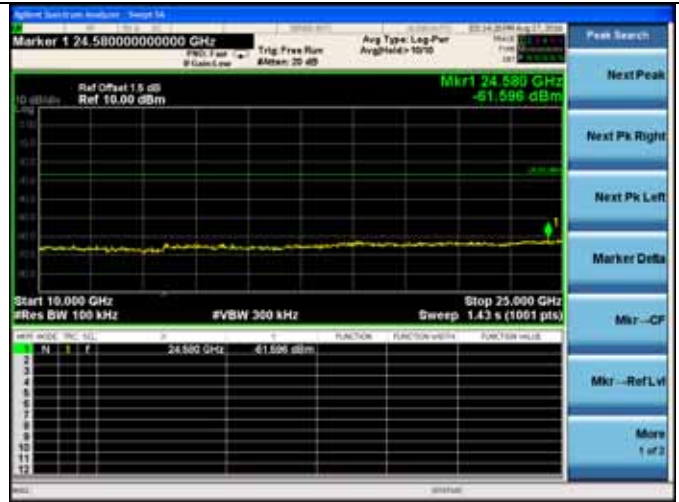
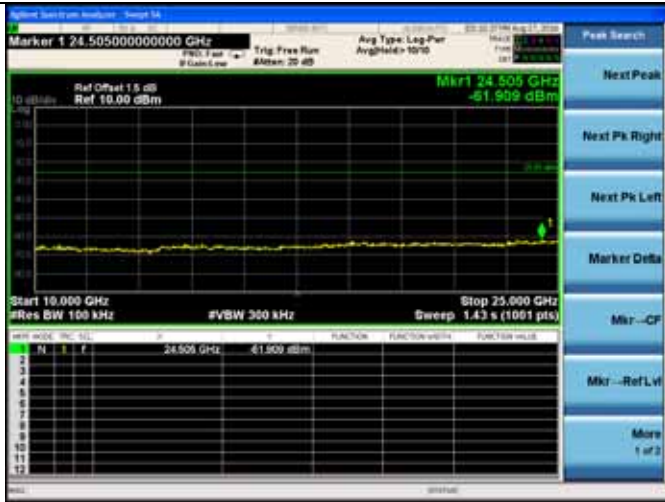

2480MHz

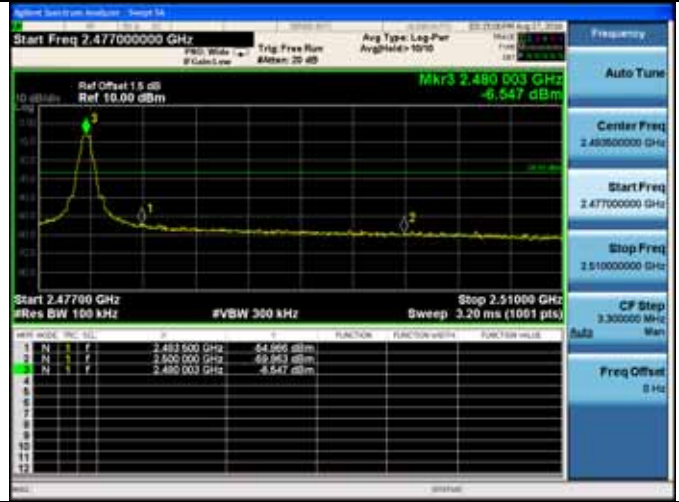
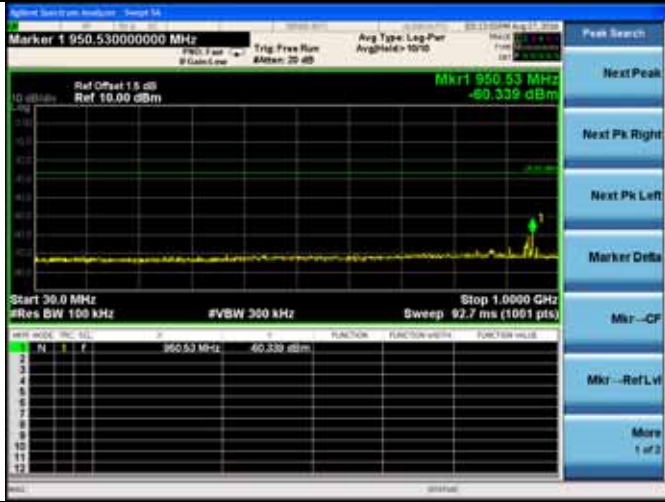

8-DPSK  
2402MHz

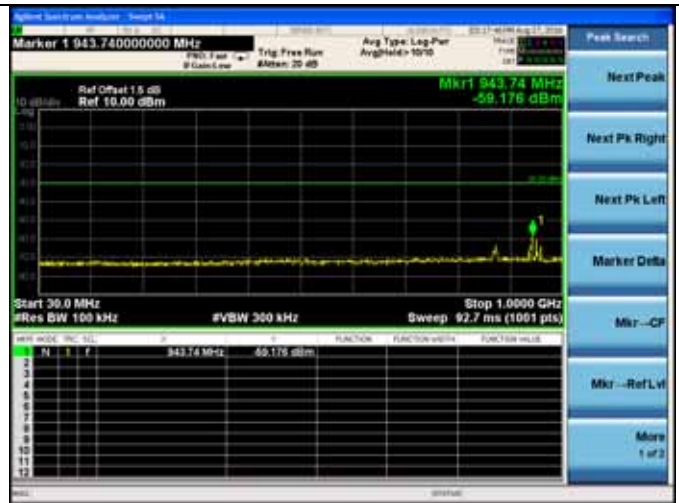
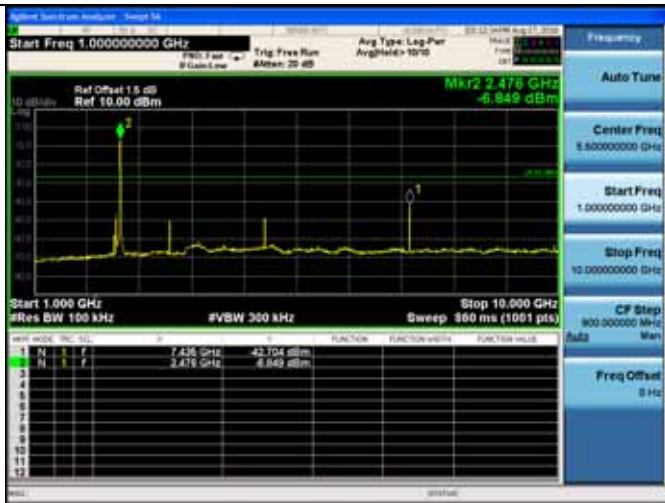

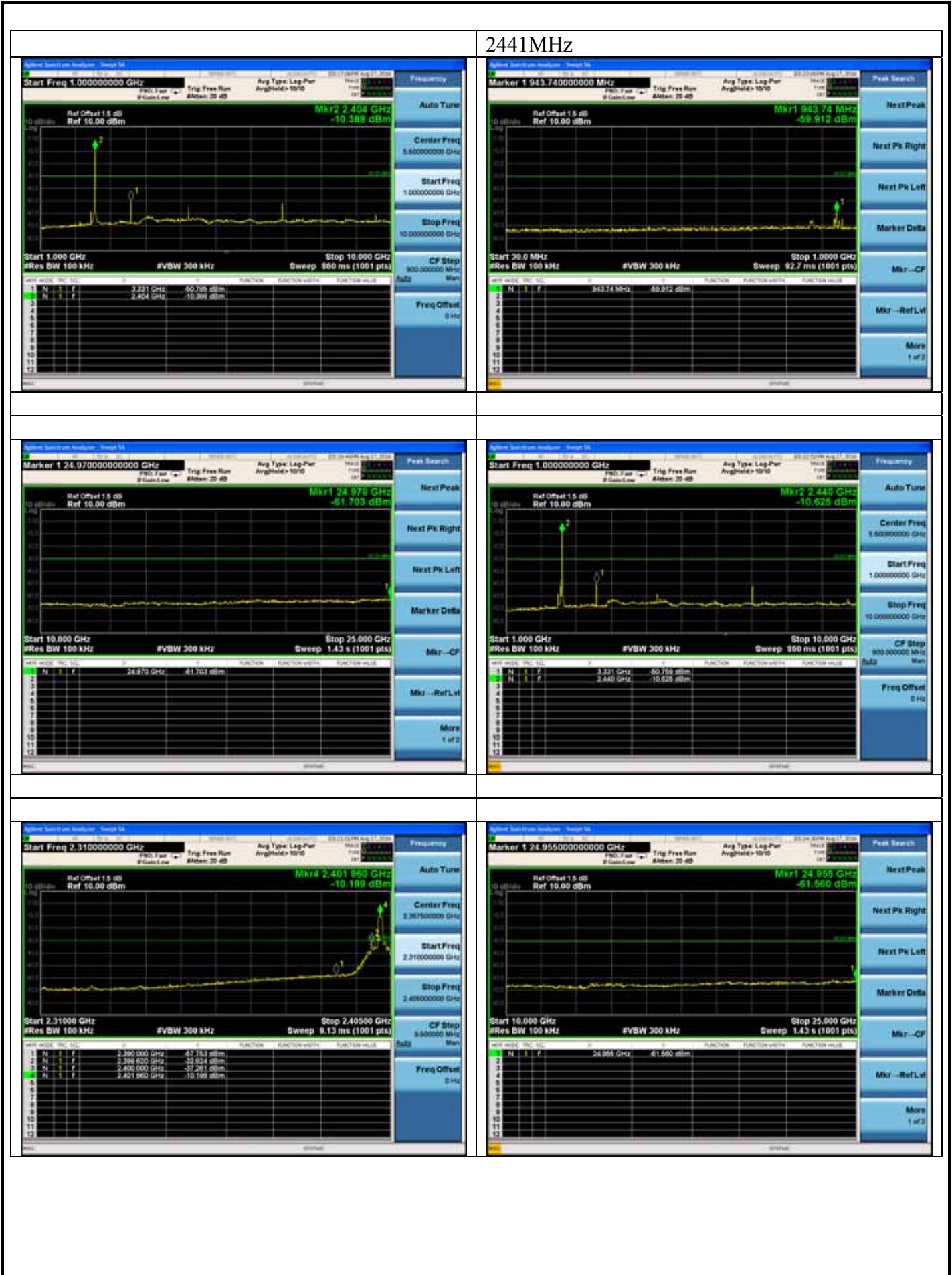

2480MHz

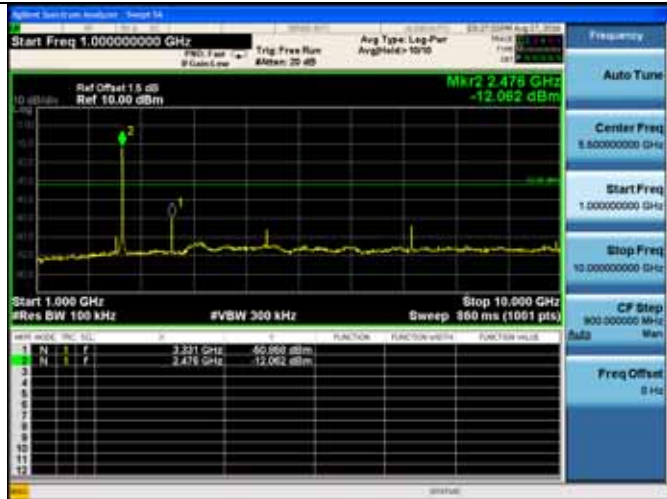
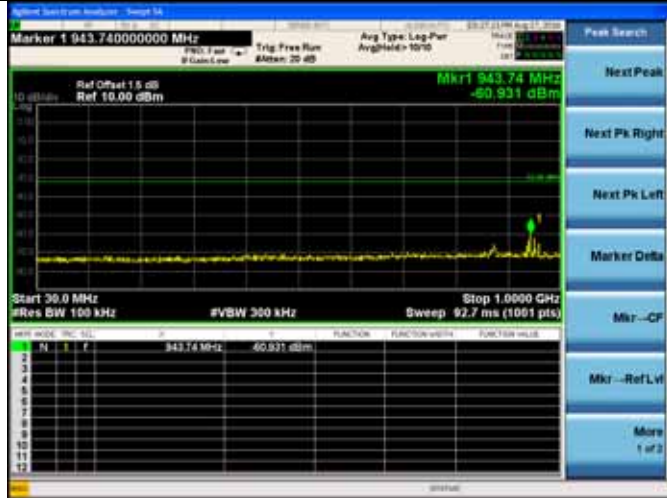

**Hopping On  
GFSK**

**8-DPSK**

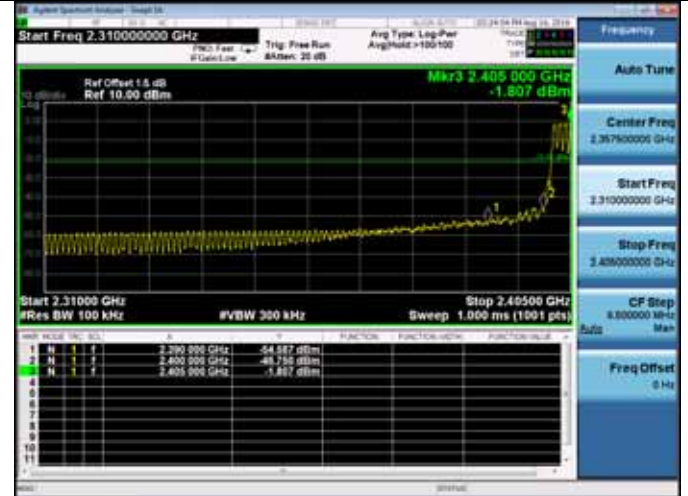
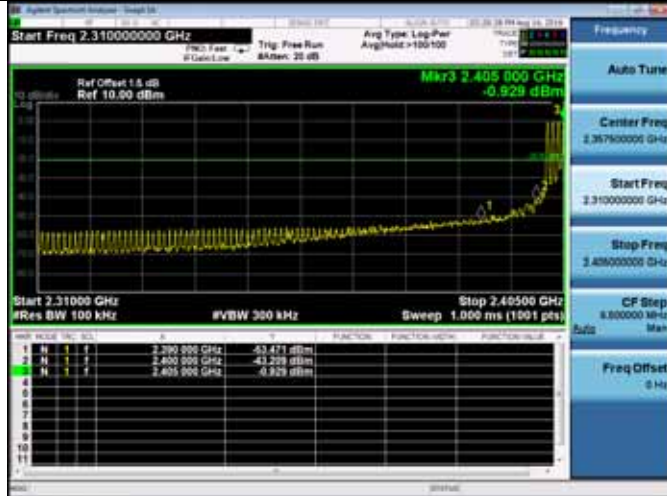

## 6. CARRIER FREQUENCY SEPARATION TEST

### 6.1. Test Equipments

Item	Equipment	Manufacturer	Model No.	Serial No.	Last Cal.	Cal. Interval
1	Spectrum Analyzer	Agilent	N9030A	MY51380221	Oct.18,15	1 Year
2.	RF Cable	Marvelous Microwave Inc	SFL402105FLEX	NO.1	Oct.17,15	1 Year

### 6.2. Limit

Frequency hopping systems shall have hopping channel carrier frequency separated by a minimum of 25kHz or the 20dB bandwidth of the hopping channel, whichever is greater. Alternatively, frequency hopping systems operating in the 2400-2483.5MHz band may have hopping channel carrier frequencies that are separated by 25kHz or two-thirds of the 20 dB bandwidth of the hopping channel, whichever is greater, provided the systems operate with an output power no greater than 125mW.

### 6.3. Test Procedure

1. Connect the antenna port of the EUT to the Spectrum analyzer.
2. Let the EUT transmit at Low/ Mid/ High channel.
3. Setting of SA is following as: RBW: 100kHz / VBW: 300kHz.Span:5MHz
4. Use the mark Delta function of the SA measure out the channel separation

6.4. Test Results.

EUT: Mobile audio wall mount unit		
M/N: JWM9A		
Test date: 2016-08-16	Pressure: 101.4±1.0 kpa	Humidity: 51.5±3.0%
Tested by: Donjon_Huang	Test site: RF Site	Temperature: 22.3±0.6°C

Test Mode	Channel separation	Conclusion
8-DPSK	1.0MHz	PASS
GFSK	1.0MHz	PASS

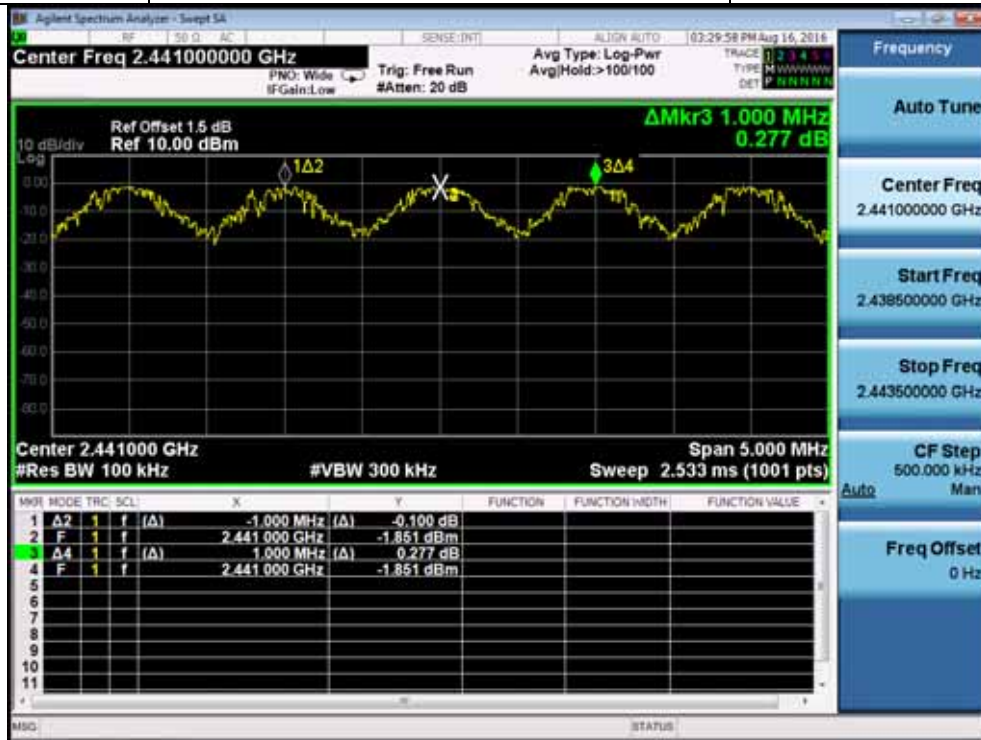

## 7. 20 DB BANDWIDTH TEST

### 7.1. Test Equipments

Item	Equipment	Manufacturer	Model No.	Serial No.	Last Cal.	Cal. Interval
1.	Spectrum	Agilent	N9030A	MY51380221	Oct.18,15	1Year
2.	Attenuator (20dB)	Agilent	8491B	MY39262165	Apr.23,16	1 Year
3.	RF Cable	Marvelous Microwave Inc	SFL402105FLEX	NO.1	Oct.17.15	1 Year

### 7.2. Limit

Intentional radiators operating under the alternative provisions to the general emission limits, as contained in §§ 15.217 through 15.257 and in Subpart E of this part, must be designed to ensure that the 20 dB bandwidth of the emission, or whatever bandwidth may otherwise be specified in the specific rule section under which the equipment operates, is contained within the frequency band designated in the rule section under which the equipment is operated.

### 7.3. Test Procedure

1. Connect the antenna port of the EUT to the spectrum analyzer.
2. Let the EUT transmit at Low/ Mid/ High channel with test software.
3. Setting of SA is following as: RBW: 30kHz / VBW: 100kHz  
Sweep Mode: Continuous sweep  
Detect mode: Positive peak  
Trace mode: Max hold.
4. Use the occupied bandwidth function of the SA measure the 20dB bandwidth directly.

### 7.4. Test Results

EUT: Mobile audio wall mount unit		
M/N: JWM9A		
Test date: 2016-08-19	Pressure: 101.5±1.0 kpa	Humidity: 52.4±3.0%
Tested by: Donjon_Huang	Test site: RF Site	Temperature: 25.1±0.6°C

Test Mode	Frequency (MHz)	-20dB Bandwidth (KHz)	Limit (KHz)
GFSK	2402	1104	N/A
	2441	1101	N/A
	2480	1106	N/A
8-DPSK	2402	1372	N/A
	2441	1375	N/A
	2480	2038	N/A

Conclusion : PASS



**GFSK**

Test Frequency: 2402MHz



**8-DPSK**

Test Frequency: 2402MHz

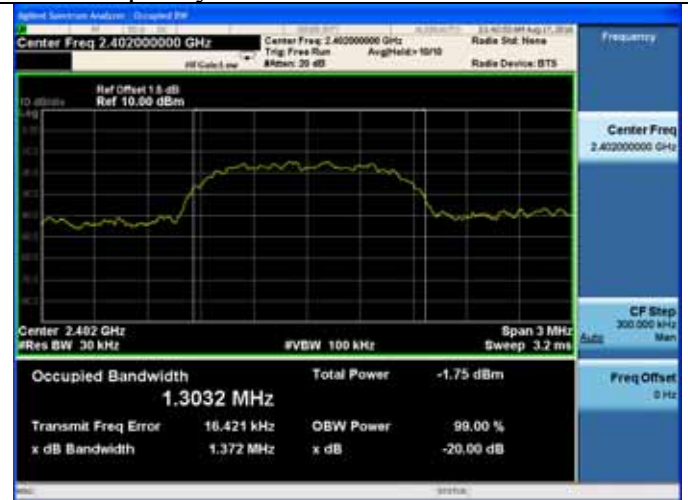

Test Frequency: 2441MHz



Test Frequency: 2441MHz



Test Frequency: 2480MHz



Test Frequency: 2480MHz



## 8. NUMBER OF HOPPING FREQUENCY TEST

### 8.1. Test Equipments

Item	Equipment	Manufacturer	Model No.	Serial No.	Last Cal.	Cal. Interval
1	Spectrum Analyzer	Agilent	N9030A	MY53311015	Oct.18,15	1Year
2.	RF Cable	Marvelous Microwave Inc	SFL402105FLEX	NO.1	Oct.17,15	1 Year

### 8.2. Limit

Frequency hopping systems in the 2400-2483.5 MHz band shall use at least 15 channels

### 8.3. Test Procedure

1. Connect the antenna of the EUT to Spectrum analyzer and let the EUT working at hopping mode.
2. Setting of SA is following as: RBW: 100kHz / VBW: 300kHz ,  
 Start frequency: 2390MHz  
 Stop frequency: 2483.5MHz  
 And waiting for the hopping trace until stability, count out the number of the hopping

### 8.4. Test Results

EUT: Mobile audio wall mount unit		
M/N: JWM9A		
Test date: 2016-08-16	Pressure: 101.4±1.0 kpa	Humidity: 51.5±3.0%
Tested by: Donjon_Huang	Test site: RF Site	Temperature: 22.3±0.6°C

Test Mode	Number of channel	Limit	Conclusion
8-DPSK	79	≥15	PASS
GFSK	79	≥15	PASS

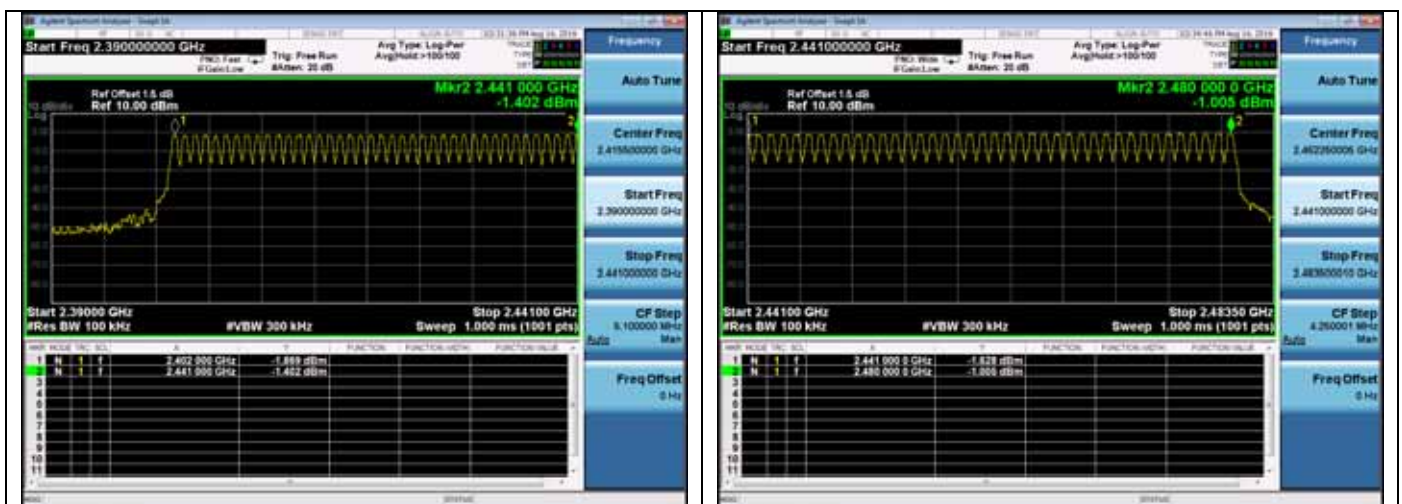

## 9. DWELL TIME

### 9.1. Test Equipment

Item	Equipment	Manufacturer	Model No.	Serial No.	Last Cal.	Cal. Interval
1	Spectrum Analyzer	Agilent	N9030A	MY51380221	Oct.18,15	1Year
2.	RF Cable	Marvelous Microwave Inc	SFL402105FLEX	NO.1	Oct.17,15	1 Year

### 9.2. Limit

The average time of occupancy on any channel shall not be greater than 0.4 seconds within a period of 0.4 seconds multiplied by the number of hopping channels employed.

### 9.3. Test Procedures

1. Connect the antenna of the EUT to Spectrum analyzer and let the EUT working at hopping mode.
2. Setting of SA is following as:  
 RBW: 100kHz / VBW: 100kHz  
 Sweep Mode: Single  
 Detect mode: Positive peak  
 Trace mode: Auto  
 Span: 0Hz  
 Sweep time: 5s and big enough to measure one hopping signal
3. Use below formula calculate the Dwell time  

$$\text{Dwell time} = \text{Hopping number per second} * 0.4 * \text{channel number} * \text{Pulse bandwidth per hopping}$$

### 9.4. Test Results

EUT: Mobile audio wall mount unit		
M/N: JWM9A		
Test date: 2016-08-16	Pressure: 101.4±1.0 kpa	Humidity: 51.5±3.0%
Tested by: Donjon_Huang	Test site: RF Site	Temperature: 22.3±0.6°C

Mode		dwell time	Limit	Conclusion
GFSK	DH1	48 hops/5s*0.4*79channels* 0.468 ms =141.972ms	≅ 400ms	PASS
	DH3	27 hops/5s*0.4*79channels* 1.773 ms =302.545ms	≅ 400ms	PASS
	DH5	18 hops/5s*0.4*79channels* 2.900 ms =329.904ms	≅ 400ms	PASS
8-DPSK	3-DH1	48 hops/5s*0.4*79channels* 0.428 ms =129.838ms	≅ 400ms	PASS
	3-DH3	27 hops/5s*0.4*79channels* 1.818 ms =310.224ms	≅ 400ms	PASS
	3-DH5	18 hops/5s*0.4*79channels* 2.890 ms =328.766ms	≅ 400ms	PASS

Note: All the lower levels were signal from receiver's, and should not considered in here.

**GFSK**  
DH 1

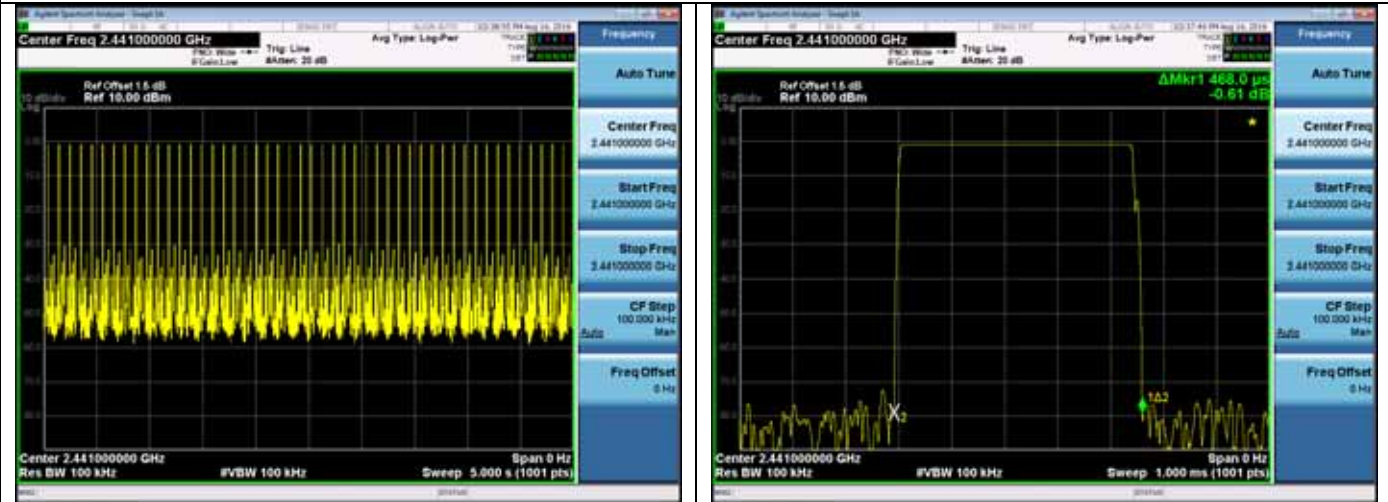

**DH 3**

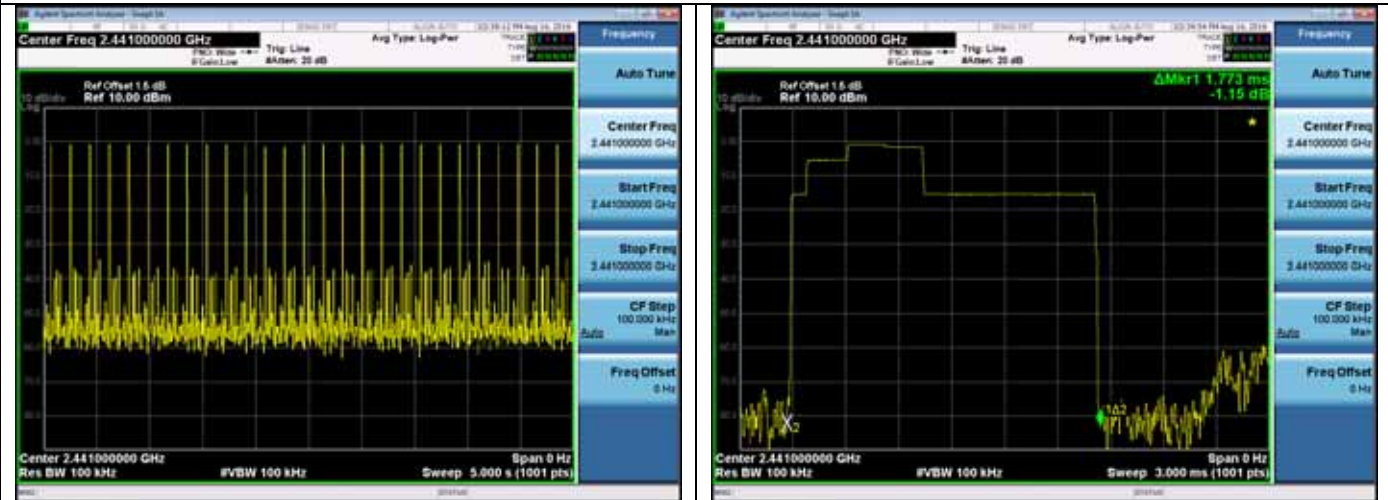

**DH 5**

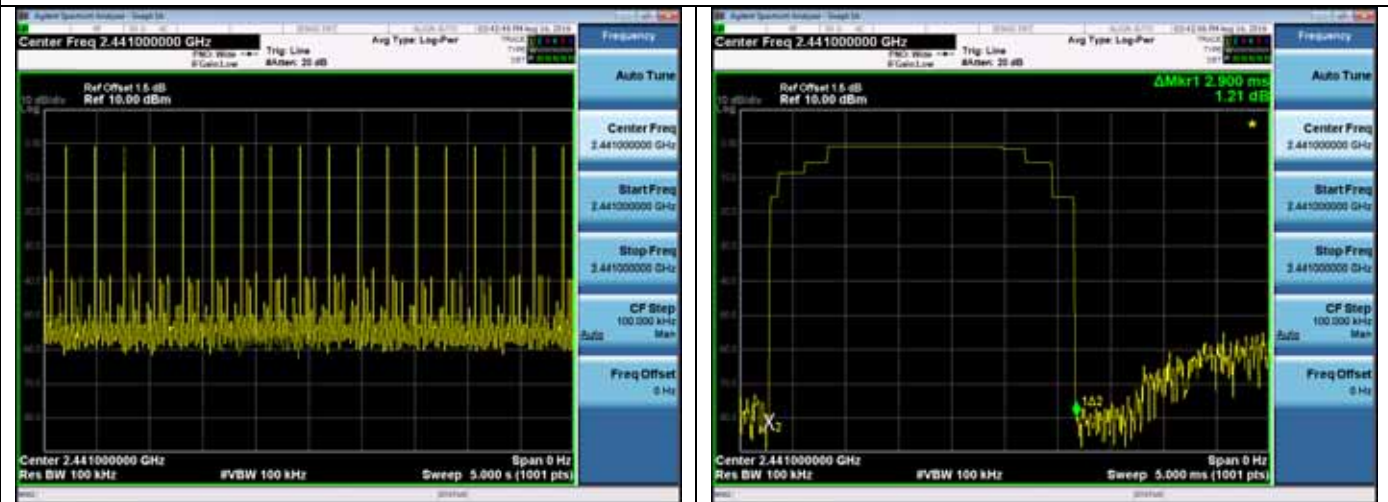

**8-DPSK**  
**3-DH 1**

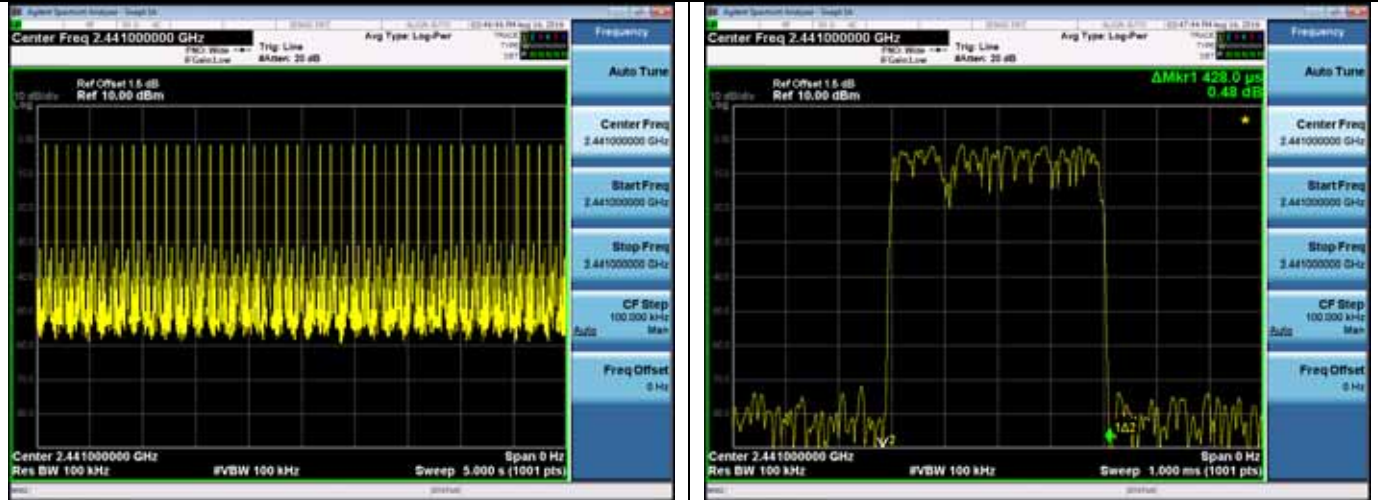

**3-DH 3**

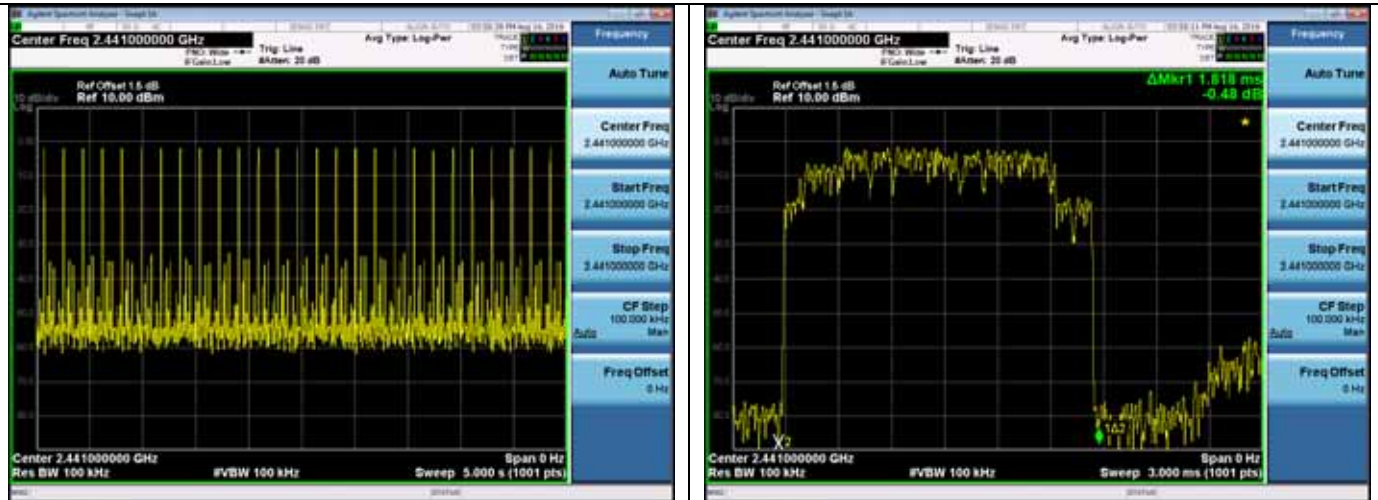

**3-DH 5**

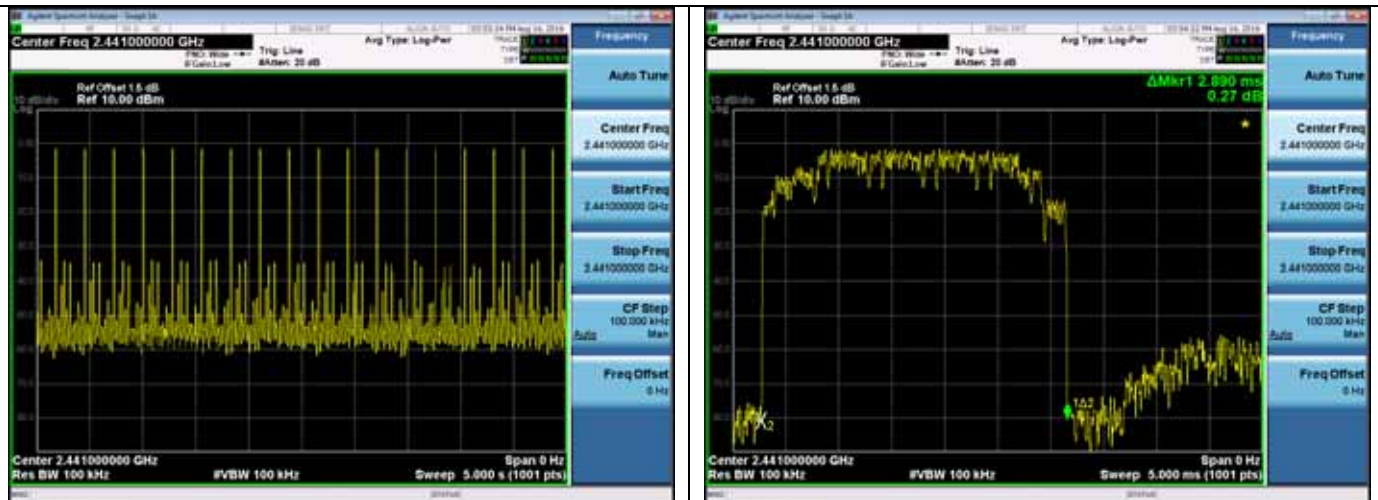

## 10. MAXIMUM PEAK OUTPUT POWER TEST

### 10.1. Test Equipments

Item	Equipment	Manufacturer	Model No.	Serial No.	Last Cal.	Cal. Interval
1.	Spectrum	Agilent	E4446A	US44300459	Apr.24,16	1 Year
2.	Spectrum	Agilent	N9030A	MY51380221	Oct.18,15	1 Year
3.	Power meter	Anritsu	ML2487A	6K00002472	Apr.23,16	1 Year
4.	Power sensor	Anritsu	MA2491A	0033005	Apr.23,16	1 Year
5.	Attenuator (20dB)	Agilent	8491B	MY39262165	Apr.23,16	1 Year
6.	RF Cable	Marvelous Microwave Inc	SFL402105FLEX	NO.1	Oct.17,15	1 Year

### 10.2. Limit

For frequency hopping systems operating in the 2400-2483.5MHz band employing at least 75 non-overlapping hopping channels, and all frequency hopping systems in the 5725-5850 MHz band: 1 watt. For all other frequency hopping systems in the 2400-2483.5 MHz band: 0.125 watts.

### 10.3. Test Procedure

The power meter was used to measure for 2400-2483.5MHz band that is the peak output power directly.

### 10.4. Test Results

EUT: Mobile audio wall mount unit			
M/N: JWM9A			
Test date: 2016-08-19		Pressure: 101.5±1.0 kpa	Humidity: 52.3±1.0%
Tested by: Donjon_Huang		Test site: RF site	Temperature:25.3±1.0 °C
Test Mode	CH (MHz)	Peak output Power (dBm)	Limit (dBm)
GFSK	2402	-4.696	30
	2441	-5.232	30
	2480	-6.318	30
8-DPSK	2402	-5.968	30
	2441	-6.358	30
	2480	-7.427	30
Conclusion: PASS			

## 11. BAND EDGE COMPLIANCE TEST

### 11.1. Test Equipments

Item	Equipment	Manufacturer	Model No.	Serial No.	Last Cal.	Cal. Interval
1.	Amp	HP	8449B	3008A02495	Apr.24,16	1 Year
2.	Horn Antenna	ETS	3115	9510-4877	Oct.15,15	1 Year
3.	HF Cable	Hubersuhner	Sucoflex104	274094/4	Apr.24,16	1 Year

### 11.2. Limit

All the lower and upper band-edges emissions appearing within 2310MHz to 2390MHz and 2483.5MHz to 2500MHz restricted frequency bands shall not exceed the limits shown in 15.209, all the other emissions outside operation frequency band 2400MHz to 2483.5MHz shall be at least 20dB below the fundamental emissions, or comply with 15.209 limits.

### 11.3. Test Produce

For upper band emissions that are up to two bandwidths(2MHz) away (2483.5MHz to 2485.5MHz) from the band-edge use below produce:

1. Choose a spectrum analyzer span that encompasses both the peak of the fundamental emission and the band-edge emission under investigation. Set the analyzer RBW to 100KHz and with a video bandwidth 300KHz. Record the peak levels of the fundamental emission and the relevant band-edge emission, Observe the stored trace and measure the amplitude delta between the peak of the fundamental and the peak of the band-edge emission. This is not a field strength measurement, it is only a relative measurement to determine the amount by which the emission drops at the band edge relative to the highest fundamental emission level.
2. Subtract the delta measured in step (1) from the maximum field strengths measured in clause 4 .The resultant field strengths are then used to determine band-edge compliance as required by Section 15.205

For emissions above two bandwidths away from the band-edge use below produce:

1. The EUT is placed on a turntable, which is 0.8m above the ground plane and worked at highest radiated power.
2. The turntable was rotated for 360 degrees to determine the position of maximum emission level.
3. EUT is set 3m away from the receiving antenna, which is varied from 1m to 4m to find out the highest emission.
4. Set the spectrum analyzer in the following setting in order to capture the lower and upperband-edges of the emission:
  - (a) PEAK: RBW=1MHz ;VBW=3MHz, PK detector, Sweep=AUTO
  - (b) This is pulse Modulation device a duty cycle factor was used to calculate average level based measured peak level.

### 11.4. Test Results

Pass (The testing data was attached in the next pages.)

Note: If the PK measured levels comply with average limit, then the average level were deemed to comply with average limit.

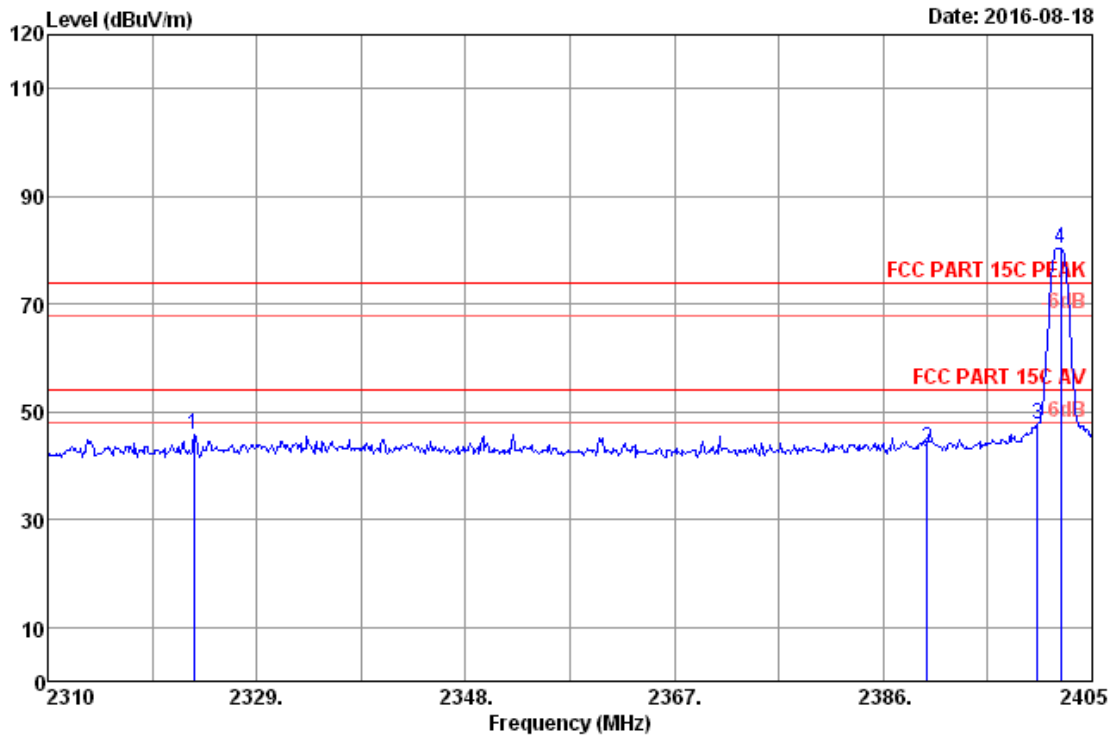

Site no. : RF Chamber Data no. : 5  
 Dis. / Ant. : 3m 2015 3115-4877 Ant. pol. : VERTICAL  
 Limit : FCC PART 15C PEAK Pre : 101.2kPa  
 Env. / Ins. : 22.6°C/51.2% Engineer : Donjon\_Huang  
 EUT : Mobile audio wall mount unit  
 Power rating : DC 12V  
 Test Mode : GFSK 2402MHz Tx Mode  
 M/N : JWM9A

No.	Freq. (MHz)	Ant. Factor (dB/m)	Cable Loss (dB)	Reading (dBuV)	AMP factor (dB)	Emission Level (dBuV/m)	Limits (dBuV/m)	Margin (dB)	Remark
1	2323.30	28.19	8.26	45.79	36.39	45.85	74.00	28.15	Peak
2	2390.00	28.27	8.33	43.07	36.39	43.28	74.00	30.72	Peak
3	2400.00	28.28	8.34	47.32	36.39	47.55	74.00	26.45	Peak
4	2402.15	28.28	8.34	80.07	36.39	80.30	74.00	-6.30	Peak

Remarks: 1. Emission Level= Antenna Factor + Cable Loss + Reading - Amp Factor  
 2. The emission levels that are 20dB below the official limit are not reported.



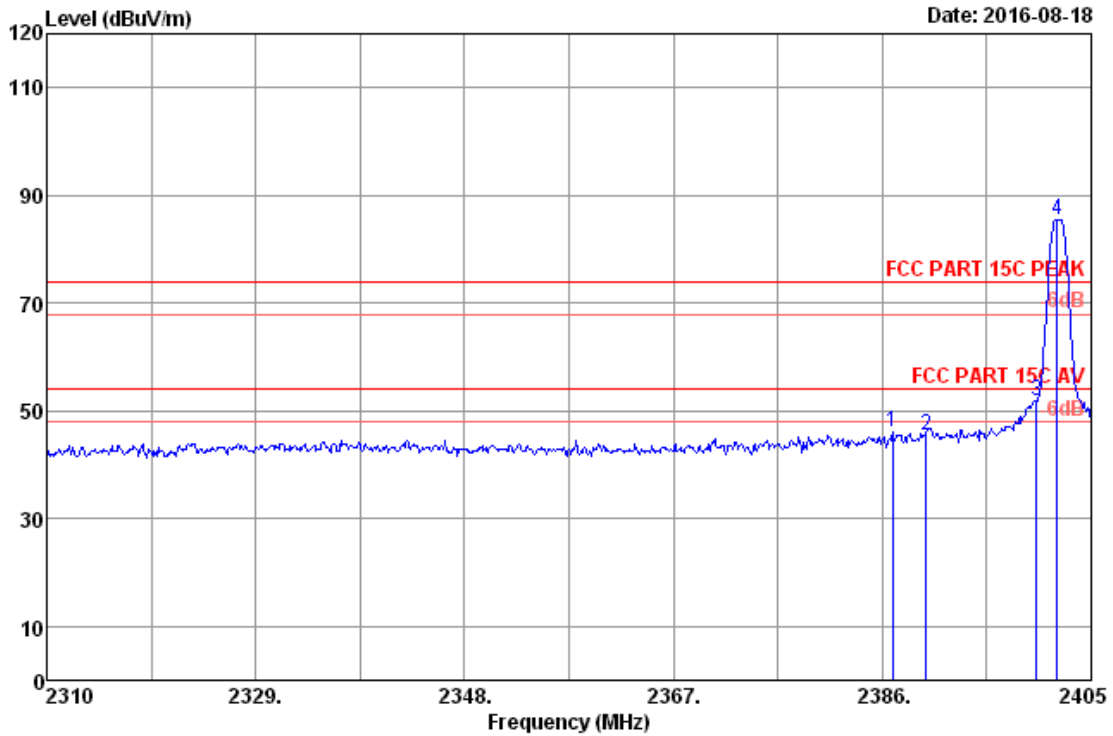

Site no. : RF Chamber  
 Dis. / Ant. : 3m 2015 3115-4877  
 Limit : FCC PART 15C PEAK  
 Env. / Ins. : 22.6°C/51.2%  
 EUT : Mobile audio wall mount unit  
 Power rating : DC 12V  
 Test Mode : GFSK 2402MHz Tx Mode  
 M/N : JWM9A  
 Data no. : 6  
 Ant. pol. : HORIZONTAL  
 Pre : 101.2kPa  
 Engineer : Donjon\_Huang

No.	Freq. (MHz)	Ant. Factor (dB/m)	Cable Loss (dB)	Reading (dBuV)	AMP factor (dB)	Emission Level (dBuV/m)	Limits (dBuV/m)	Margin (dB)	Remark
1	2386.95	28.26	8.32	45.84	36.39	46.03	74.00	27.97	Peak
2	2390.00	28.27	8.33	45.16	36.39	45.37	74.00	28.63	Peak
3	2400.00	28.28	8.34	51.73	36.39	51.96	74.00	22.04	Peak
4	2401.87	28.28	8.34	85.25	36.39	85.48	74.00	-11.48	Peak

Remarks: 1. Emission Level= Antenna Factor + Cable Loss + Reading - Amp Factor  
 2. The emission levels that are 20dB below the official limit are not reported.

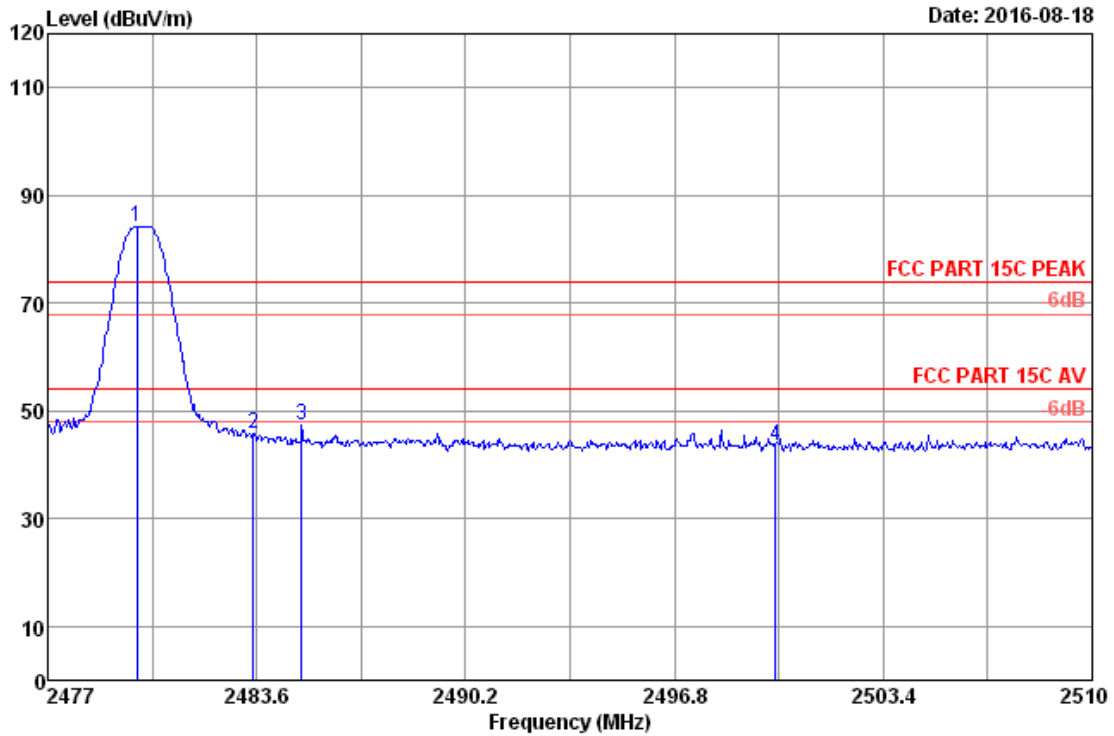

Site no. : RF Chamber Data no. : 15  
 Dis. / Ant. : 3m 2015 3115-4877 Ant. pol. : HORIZONTAL  
 Limit : FCC PART 15C PEAK Pre : 101.2kPa  
 Env. / Ins. : 22.6\*C/51.2% Engineer : Donjon\_Huang  
 EUT : Mobile audio wall mount unit  
 Power rating : DC 12V  
 Test Mode : GFSK 2480MHz Tx Mode  
 M/N : JWM9A

No.	Freq. (MHz)	Ant. Factor (dB/m)	Cable Loss (dB)	Reading (dBuV)	AMP factor (dB)	Emission Level (dBuV/m)	Limits (dBuV/m)	Margin (dB)	Remark
1	2479.81	28.38	8.42	83.87	36.38	84.29	74.00	-10.29	Peak
2	2483.50	28.38	8.42	45.19	36.38	45.61	74.00	28.39	Peak
3	2485.02	28.38	8.42	46.79	36.38	47.21	74.00	26.79	Peak
4	2500.00	28.40	8.44	42.99	36.38	43.45	74.00	30.55	Peak

Remarks: 1. Emission Level= Antenna Factor + Cable Loss + Reading - Amp Factor  
 2. The emission levels that are 20dB below the official limit are not reported.

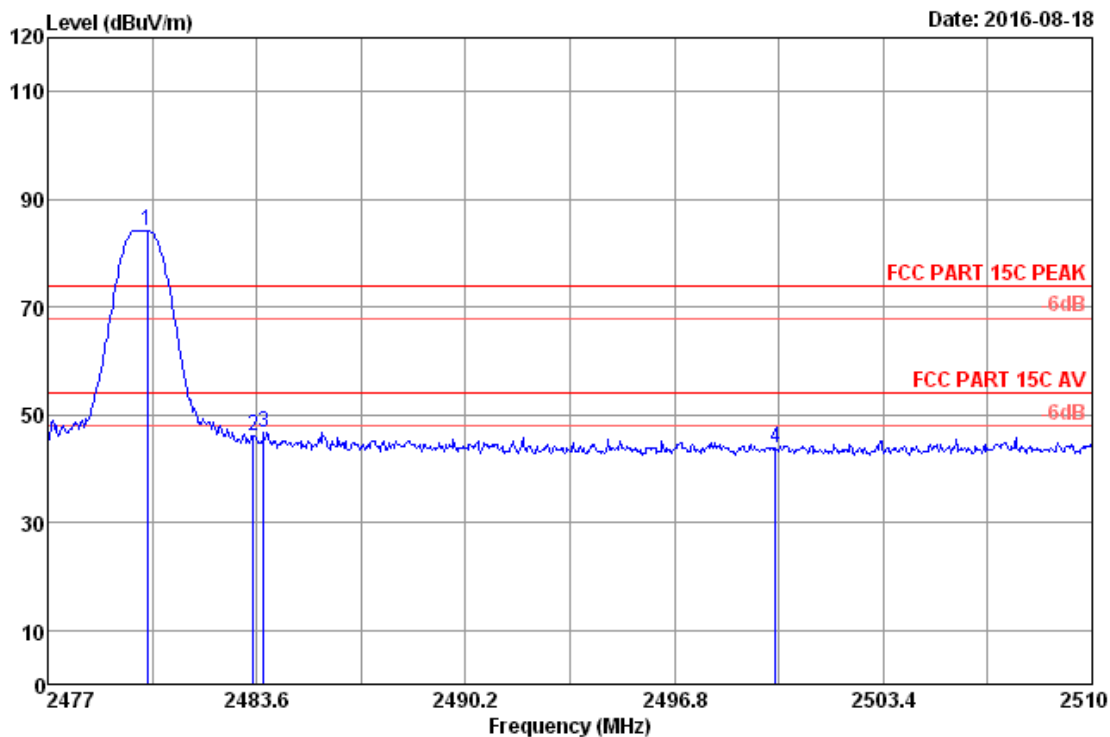

Site no. : RF Chamber  
 Dis. / Ant. : 3m 2015 3115-4877  
 Limit : FCC PART 15C PEAK  
 Env. / Ins. : 22.6°C/51.2%  
 EUT : Mobile audio wall mount unit  
 Power rating : DC 12V  
 Test Mode : GFSK 2480MHz Tx Mode  
 M/N : JWM9A

Data no. : 16  
 Ant. pol. : HORIZONTAL  
 Pre : 101.2kPa  
 Engineer : Donjon\_Huang

No.	Freq. (MHz)	Ant. Factor (dB/m)	Cable Loss (dB)	Reading (dBUV)	AMP factor (dB)	Emission Level (dBUV/m)	Limits (dBUV/m)	Margin (dB)	Remark
1	2480.14	28.38	8.42	83.88	36.38	84.30	74.00	-10.30	Peak
2	2483.50	28.38	8.42	45.74	36.38	46.16	74.00	27.84	Peak
3	2483.83	28.38	8.42	46.27	36.38	46.69	74.00	27.31	Peak
4	2500.00	28.40	8.44	43.24	36.38	43.70	74.00	30.30	Peak

Remarks: 1. Emission Level= Antenna Factor + Cable Loss + Reading - Amp Factor  
 2. The emission levels that are 20dB below the official limit are not reported.

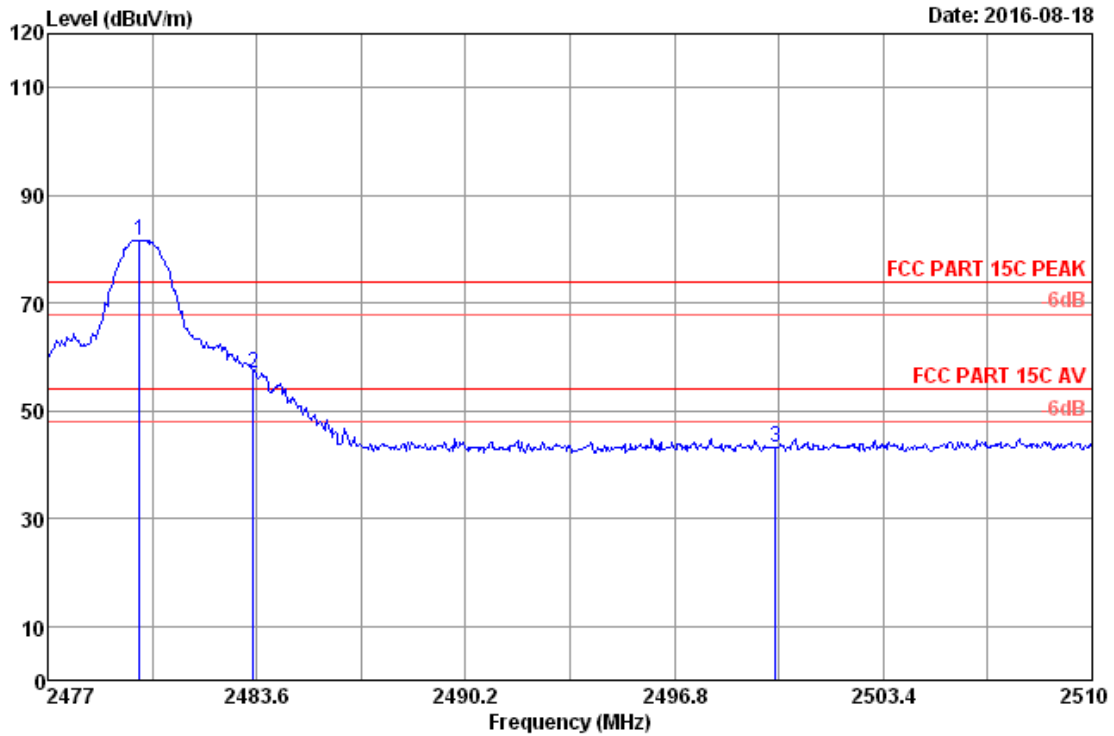

Site no. : RF Chamber Data no. : 17  
 Dis. / Ant. : 3m 2015 3115-4877 Ant. pol. : HORIZONTAL  
 Limit : FCC PART 15C PEAK Pre : 101.2kPa  
 Env. / Ins. : 22.6°C/51.2% Engineer : Donjon\_Huang  
 EUT : Mobile audio wall mount unit  
 Power rating : DC 12V  
 Test Mode : 8-DPSK 2480MHz Tx Mode  
 M/N : JWM9A

No.	Freq. (MHz)	Ant. Factor (dB/m)	Cable Loss (dB)	Reading (dBuV)	AMP factor (dB)	Emission Level (dBuV/m)	Limits (dBuV/m)	Margin (dB)	Remark
1	2479.90	28.38	8.42	81.29	36.38	81.71	74.00	-7.71	Peak
2	2483.50	28.38	8.42	56.69	36.38	57.11	74.00	16.89	Peak
3	2500.00	28.40	8.44	42.79	36.38	43.25	74.00	30.75	Peak

Remarks: 1. Emission Level= Antenna Factor + Cable Loss + Reading - Amp Factor  
 2. The emission levels that are 20dB below the official limit are not reported.

Frequency (MHz)	Original AV level (dBuV/m)	Duty cycle factor (dB)	Final AV level (dBuV/m)	Limit(dBuv/m)	Conclusion
2483.50	57.11	-30.722	26.388	54	Pass

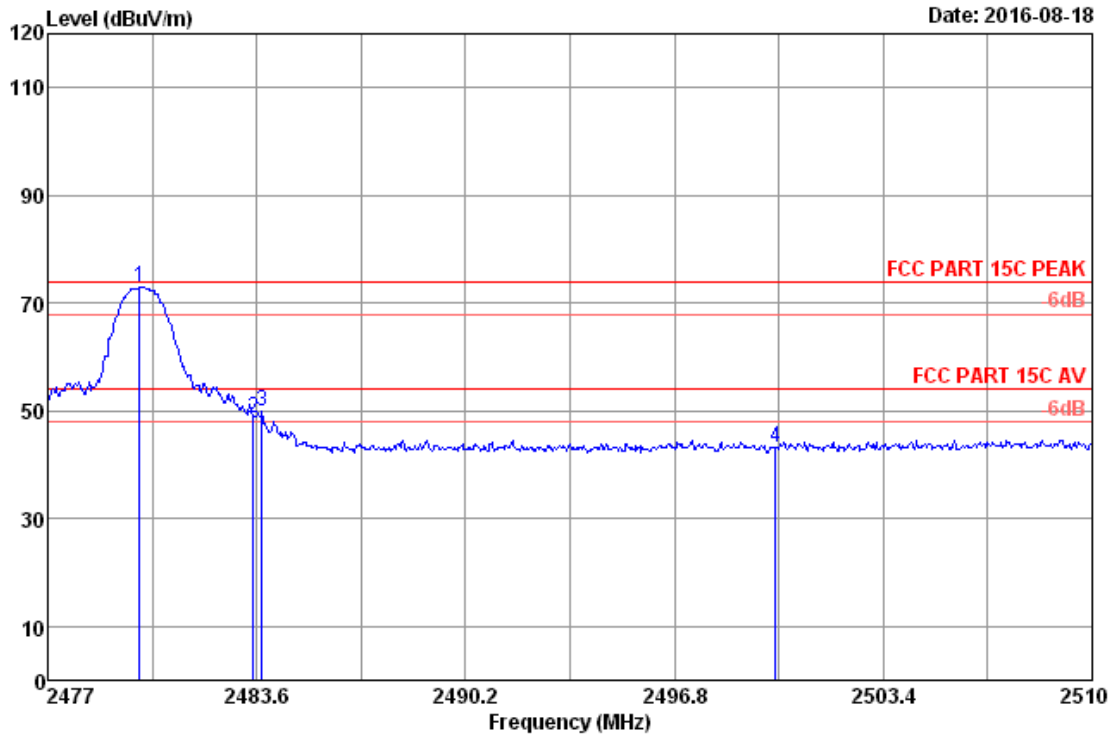

Site no. : RF Chamber  
 Dis. / Ant. : 3m 2015 3115-4877  
 Limit : FCC PART 15C PEAK  
 Env. / Ins. : 22.6°C/51.2%  
 EUT : Mobile audio wall mount unit  
 Power rating : DC 12V  
 Test Mode : 8-DPSK 2480MHz Tx Mode  
 M/N : JWM9A  
 Data no. : 18  
 Ant. pol. : VERTICAL  
 Pre : 101.2kPa  
 Engineer : Donjon\_Huang

No.	Freq. (MHz)	Ant. Factor (dB/m)	Cable Loss (dB)	Reading (dBUV)	AMP factor (dB)	Emission Level (dBUV/m)	Limits (dBUV/m)	Margin (dB)	Remark
1	2479.90	28.38	8.42	72.54	36.38	72.96	74.00	1.04	Peak
2	2483.50	28.38	8.42	48.28	36.38	48.70	74.00	25.30	Peak
3	2483.77	28.38	8.42	49.56	36.38	49.98	74.00	24.02	Peak
4	2500.00	28.40	8.44	42.64	36.38	43.10	74.00	30.90	Peak

Remarks: 1. Emission Level= Antenna Factor + Cable Loss + Reading - Amp Factor  
 2. The emission levels that are 20dB below the official limit are not reported.

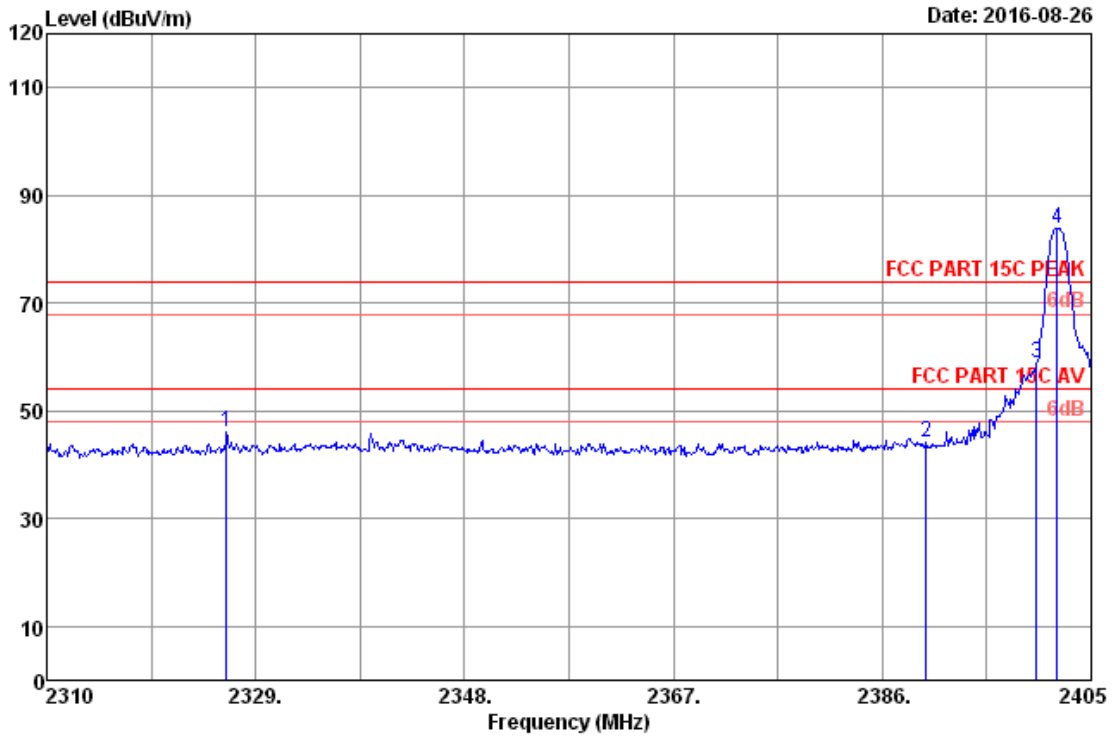

Site no. : RF Chamber Data no. : 31  
 Dis. / Ant. : 3m 2015 3115-4877 Ant. pol. : HORIZONTAL  
 Limit : FCC PART 15C PEAK Pre : 101.2kPa  
 Env. / Ins. : 22.6°C/51.2% Engineer : Donjon\_Huang  
 EUT : Mobile audio wall mount unit  
 Power rating : DC 12V  
 Test Mode : 8-DPSK 2402MHz Tx Mode  
 M/N : JWM9A

No.	Freq. (MHz)	Ant. Factor (dB/m)	Cable Loss (dB)	Reading (dBuV)	AMP factor (dB)	Emission Level (dBuV/m)	Limits (dBuV/m)	Margin (dB)	Remark
1	2326.34	28.19	8.26	45.90	36.39	45.96	74.00	28.04	Peak
2	2390.00	28.27	8.33	43.92	36.39	44.13	74.00	29.87	Peak
3	2400.00	28.28	8.34	58.72	36.39	58.95	74.00	15.05	Peak
4	2401.87	28.28	8.34	83.66	36.39	83.89	74.00	-9.89	Peak

Remarks: 1. Emission Level= Antenna Factor + Cable Loss + Reading - Amp Factor  
 2. The emission levels that are 20dB below the official limit are not reported.

Frequency (MHz)	Original AV level (dBuV/m)	Duty cycle factor (dB)	Final AV level (dBuV/m)	Limit(dBuv/m)	Conclusion
2400.00	58.95	-30.722	28.228	54	Pass

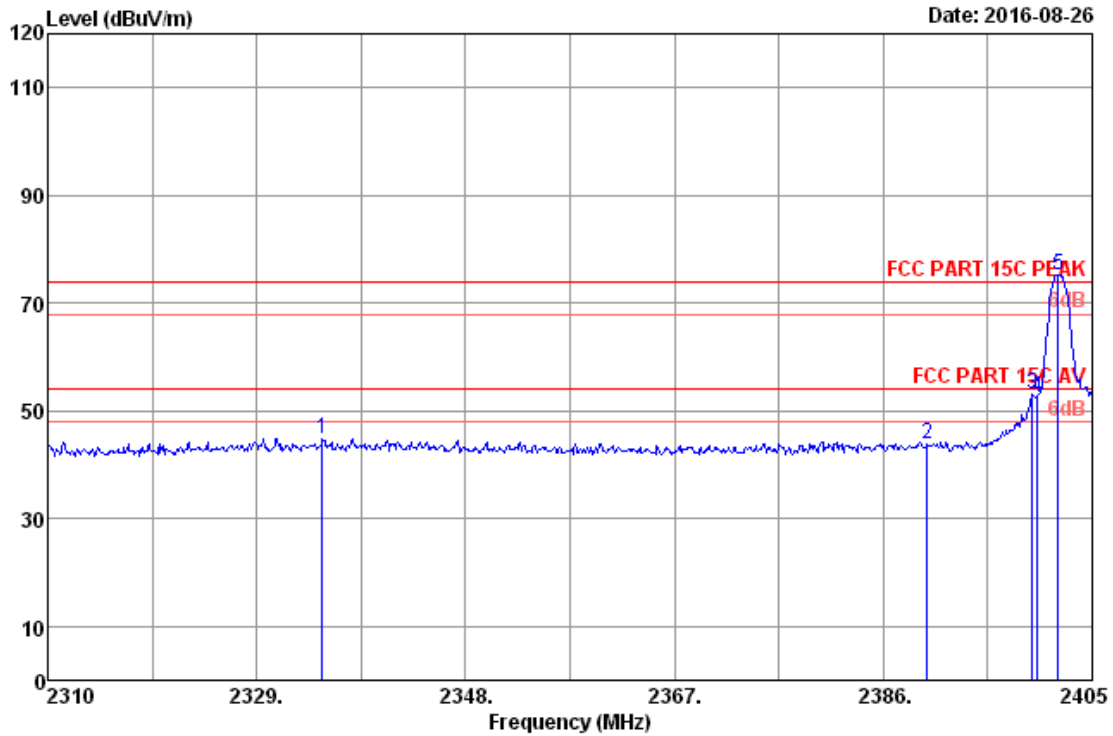

Site no. : RF Chamber Data no. : 32  
 Dis. / Ant. : 3m 2015 3115-4877 Ant. pol. : VERTICAL  
 Limit : FCC PART 15C PEAK Pre : 101.2kPa  
 Env. / Ins. : 22.6°C/51.2% Engineer : Donjon\_Huang  
 EUT : Mobile audio wall mount unit  
 Power rating : DC 12V  
 Test Mode : 8-DPSK 2402MHz Tx Mode  
 M/N : JWM9A

No.	Freq. (MHz)	Ant. Factor (dB/m)	Cable Loss (dB)	Reading (dBuV)	AMP factor (dB)	Emission Level (dBuV/m)	Limits (dBuV/m)	Margin (dB)	Remark
1	2334.99	28.20	8.27	44.82	36.39	44.90	74.00	29.10	Peak
2	2390.00	28.27	8.33	43.77	36.39	43.98	74.00	30.02	Peak
3	2399.59	28.28	8.34	52.97	36.39	53.20	74.00	20.80	Peak
4	2400.00	28.28	8.34	52.19	36.39	52.42	74.00	21.58	Peak
5	2401.87	28.28	8.34	75.02	36.39	75.25	74.00	-1.25	Peak

Remarks: 1. Emission Level= Antenna Factor + Cable Loss + Reading - Amp Factor  
 2. The emission levels that are 20dB below the official limit are not reported.

## 12. DEVIATION TO TEST SPECIFICATIONS

[NONE]