

Photo No. 3

Unit disassembled

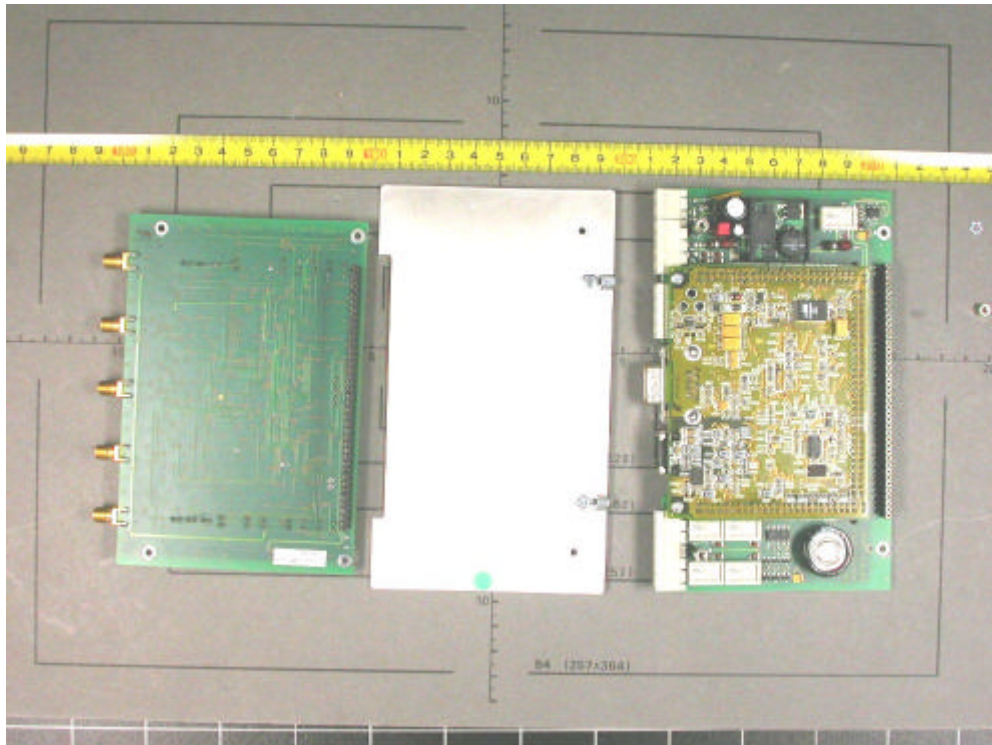
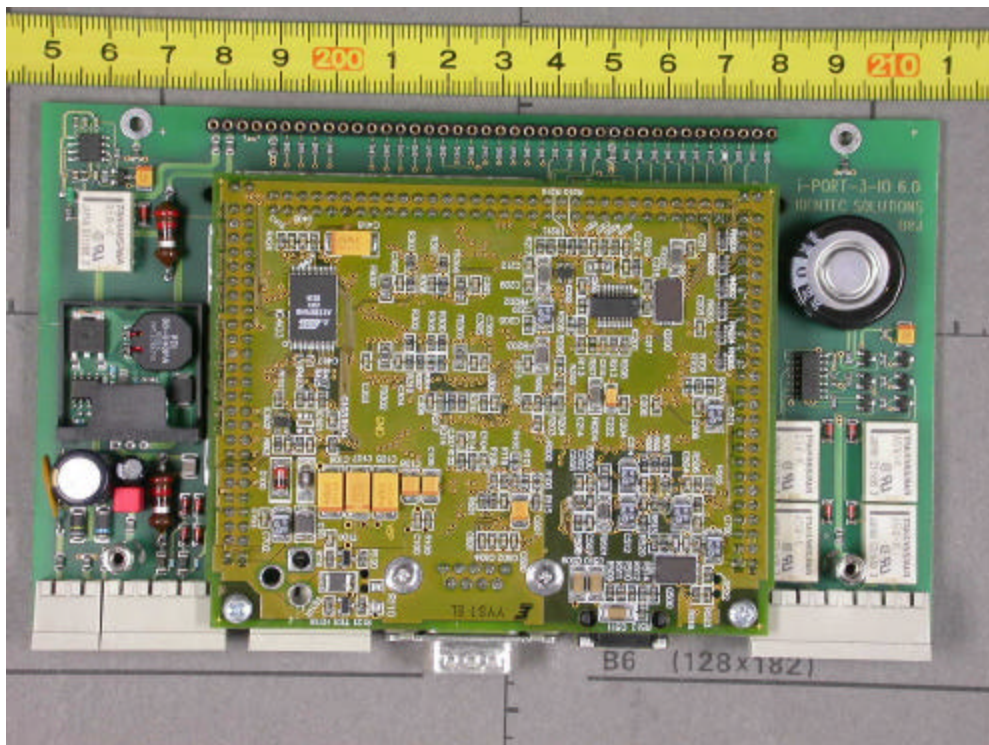
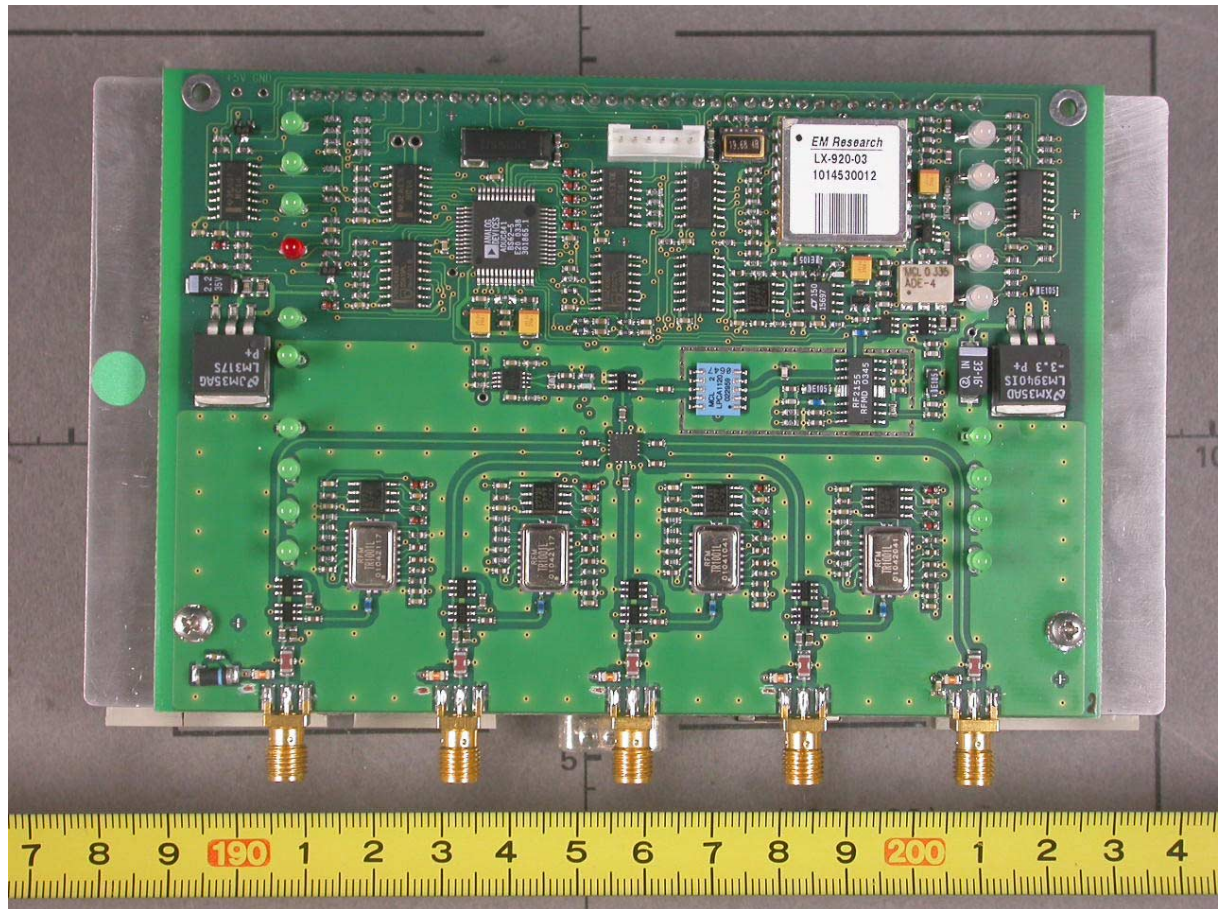

Photo No. 6

Top view - printed board (Host section)





FCC ID 004-IPORT3-NAE

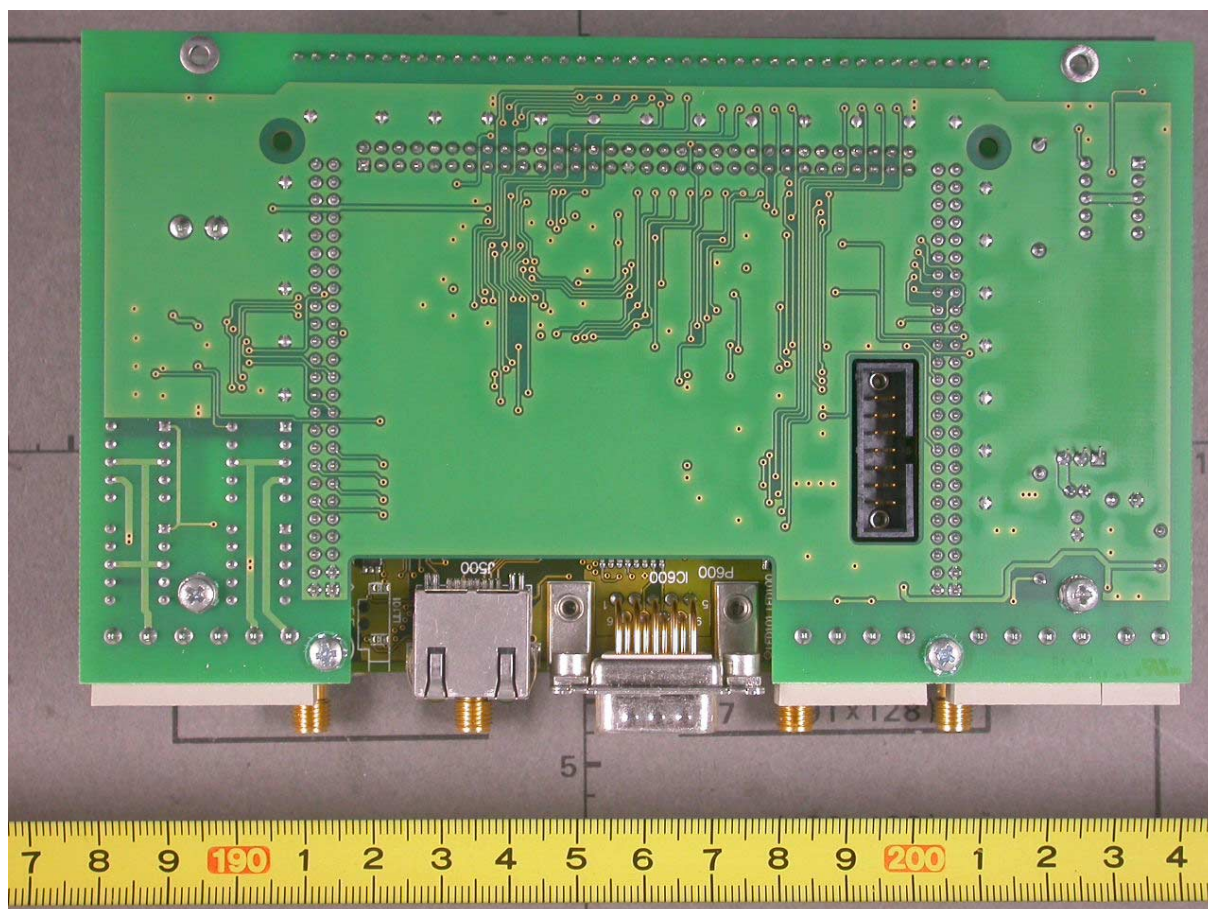

FCC ID 004-IPORT3-NAE

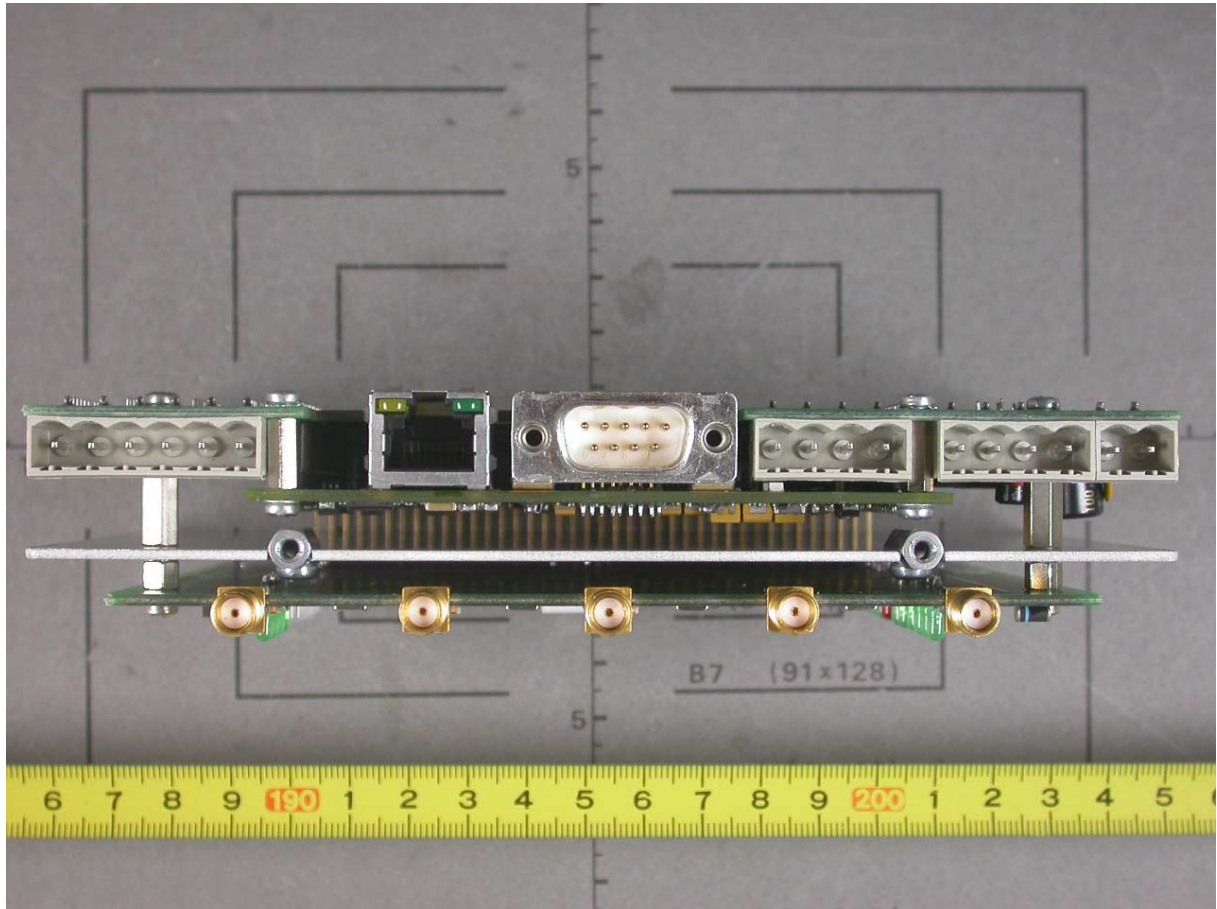

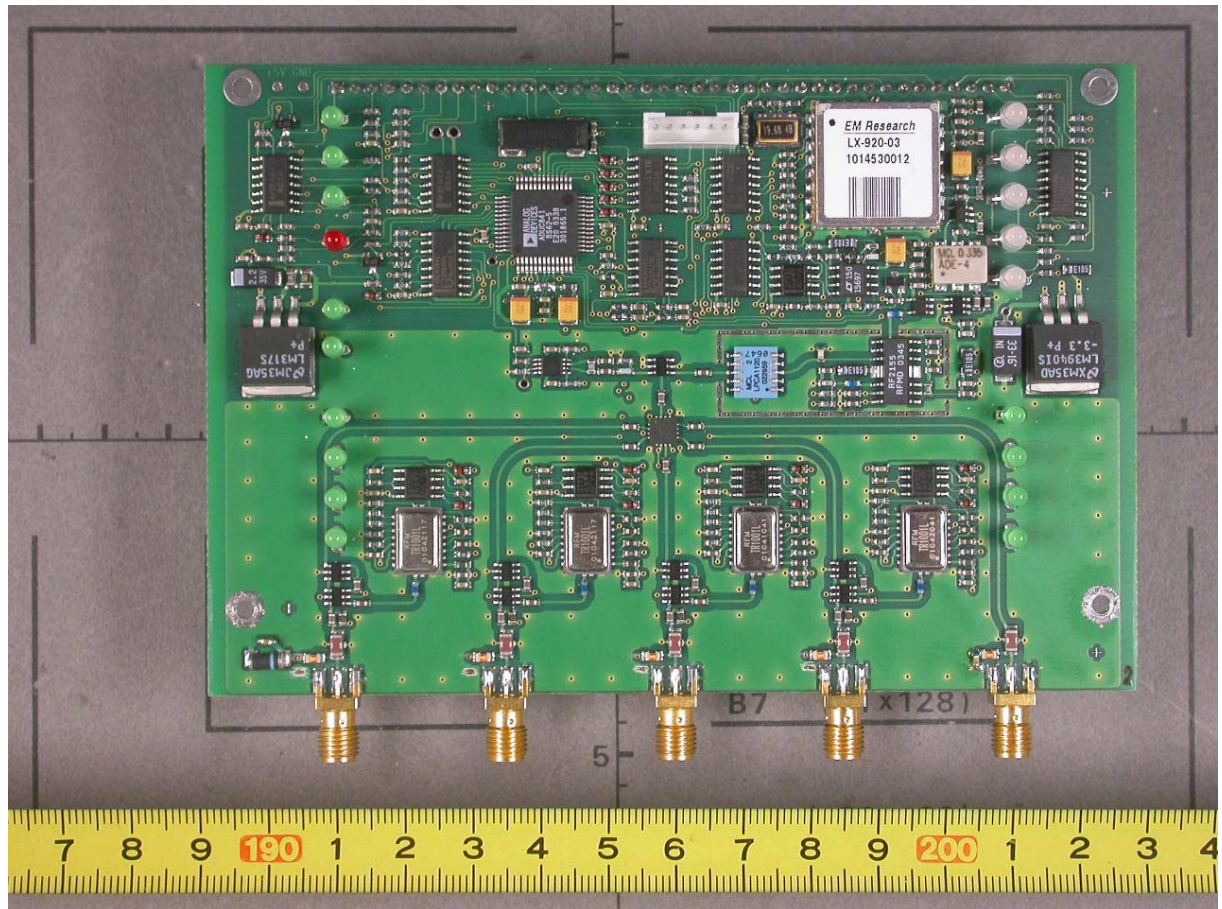

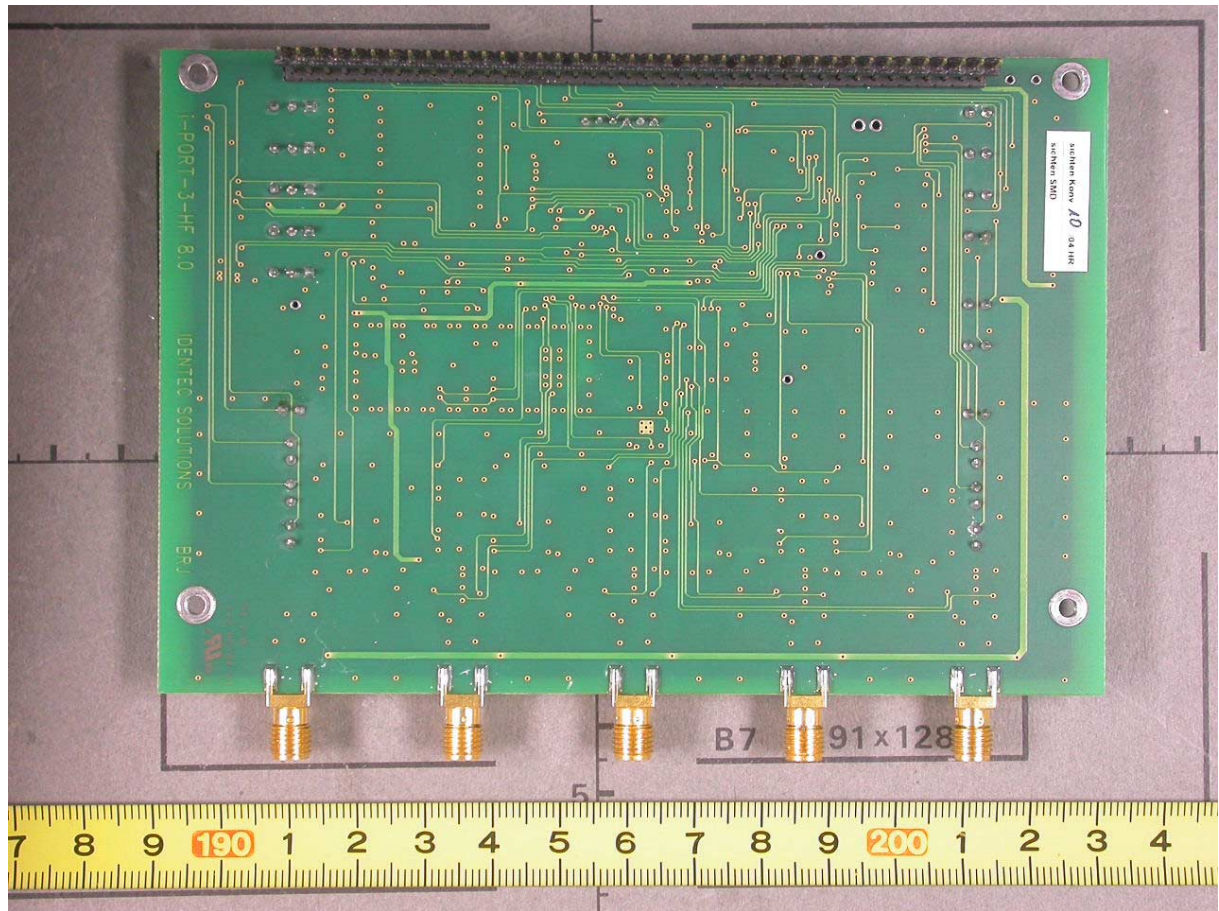

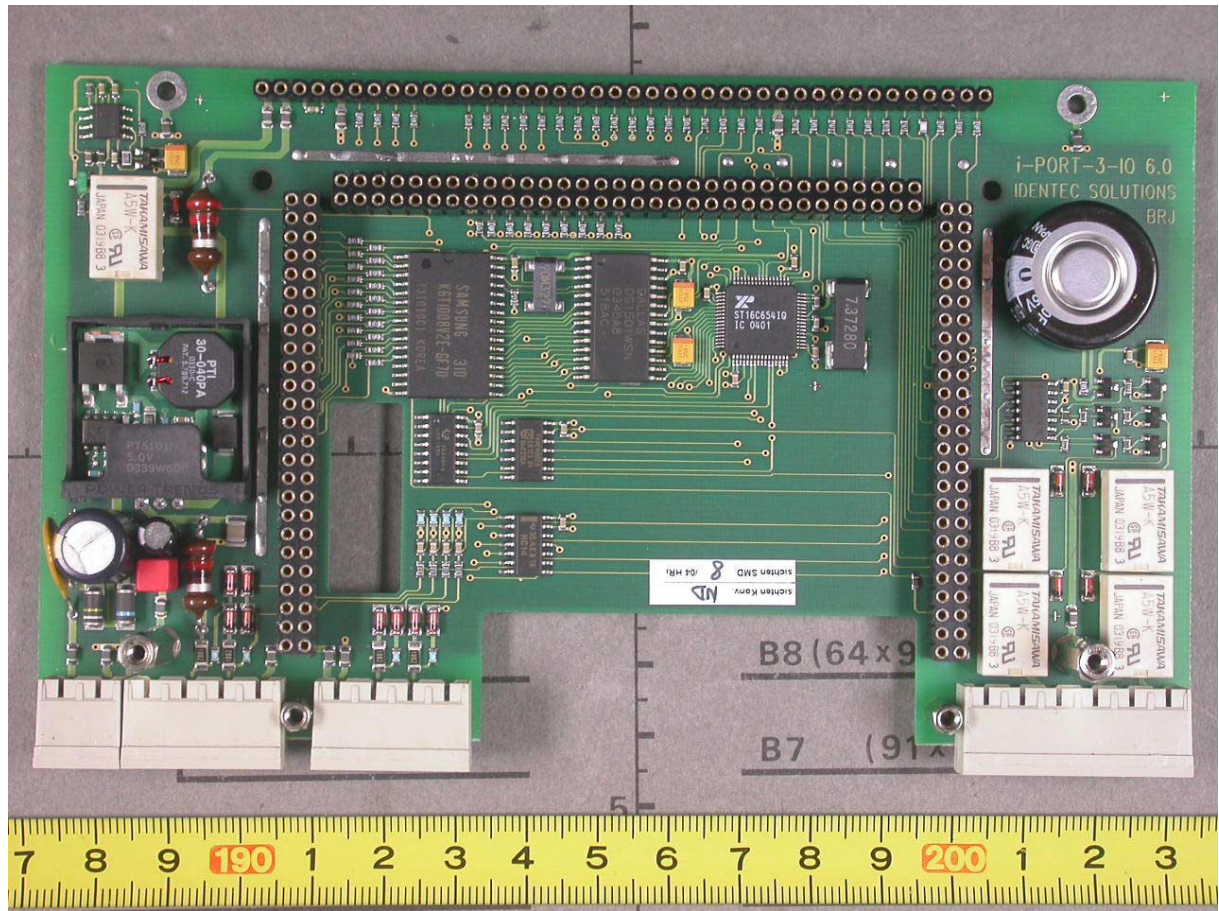

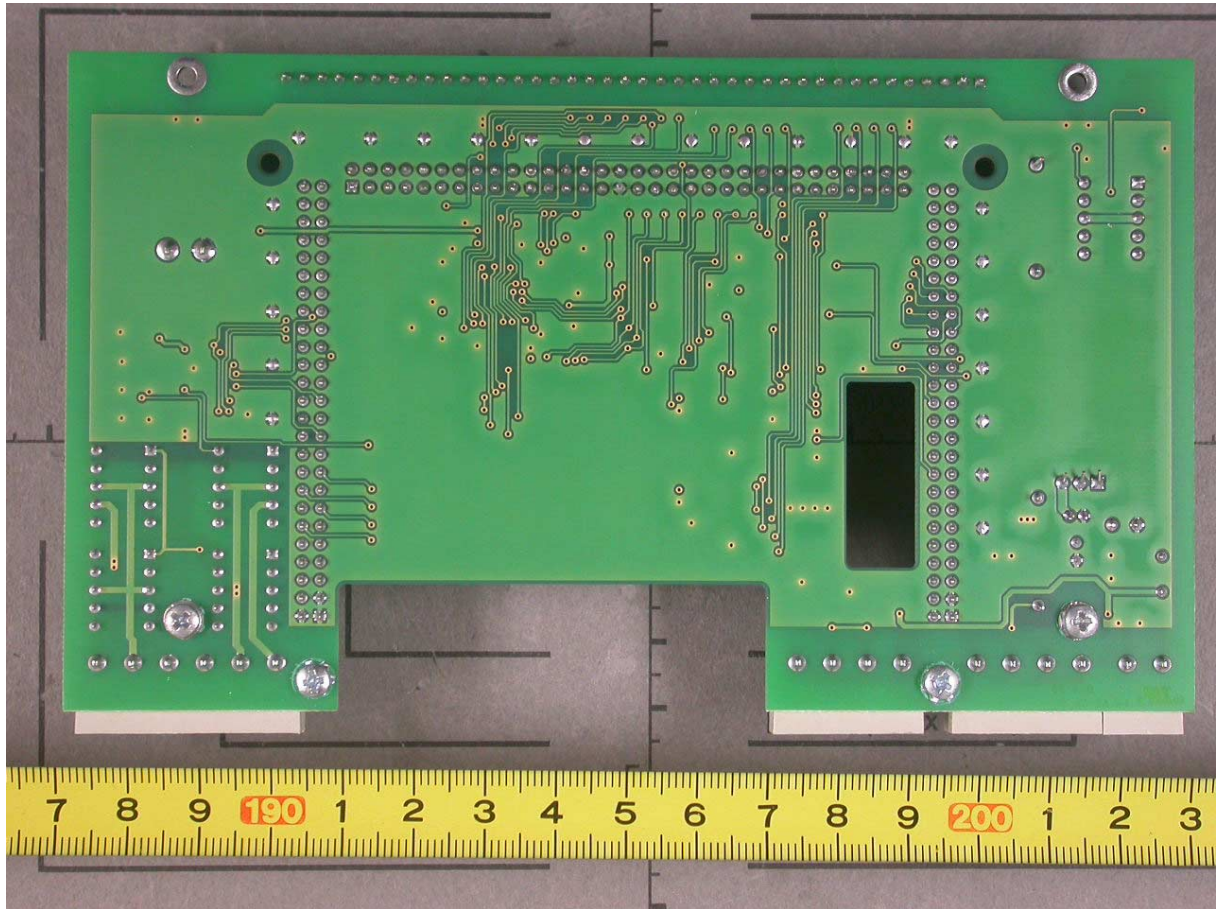

FCC ID 004-IPORT3-NAE

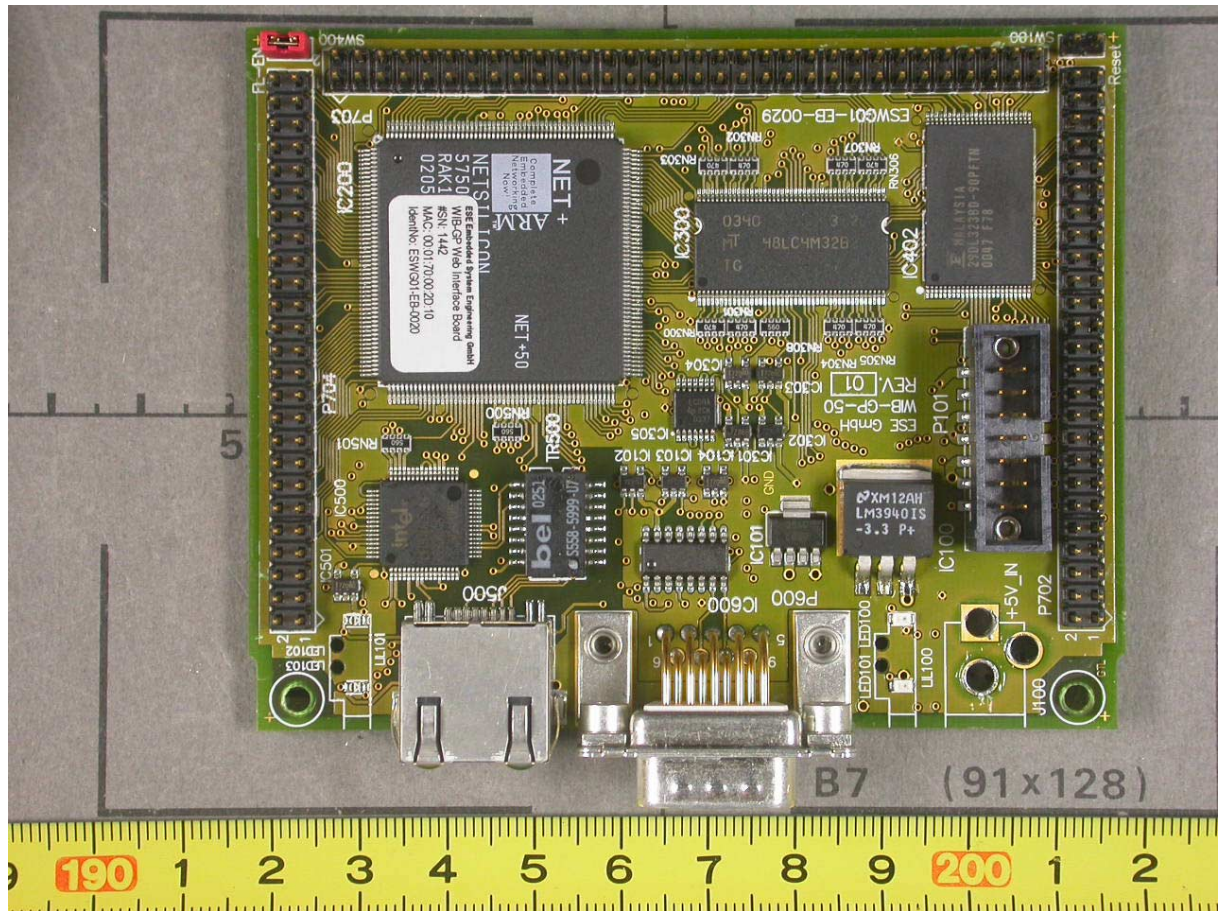

FCC ID 004-IPORT3-NAE

