

TEST REPORT

FCC RULES Part 90, Part2

FCC ID : ONKAQ-10

| | |
|-----------------|--|
| Report File No. | : <u>STROR-04-022</u> |
| Date of Issue | : <u>Dec 20, 2004</u> |
| Kind of Product | : <u>FM Handheld Transceiver</u> |
| Model Name | : <u>AQ-10</u> |
| Manufacturer | : <u>AIRTECH Information & Communication Co., Ltd.</u> |
| Serial No. | : <u>-</u> |
| Test Result | : <u>Complied</u> |

The results shown in this report refer only to the sample(s) tested unless otherwise stated. This test report cannot be reproduced, except in full, without prior written permission of company.

SGS Testing Korea Co., Ltd.

18-34, Sanbon-dong, Gunpo-si, Gyeonggi-do, Korea, 435-041

Tel. +82 31 428 5700 / Fax. +82 31 427 2371

<http://www.sgstesting.co.kr>

VERIFICATION OF COMPLIANCE

Applicant : AIRTECH Information & Communication Co., Ltd.
Kind of Product : FM Handheld Transceiver
Brand Name : -
Model Name : AQ-10
Model Difference : -
Report File No. : STROR-04-022
Date of test : Dec 6, 2004 ~ Dec 20, 2004
Receiver EUT : -

| APPLICABLE STANDARDS | |
|--------------------------|-------------|
| STANDARD | TEST RESULT |
| FCC RULES Part 90, Part2 | Complied |

The above equipment was tested by SGS Testing Korea Co., Ltd. for compliance with the requirements set forth in the FCC RULES PARTS Part90, Part2. The results of testing in this report apply to the product system that was tested only. Other similar equipment will not necessarily produce the same results due to production tolerance and measurement uncertainties.

Tested By:



Date

Dec 20, 2004

Feel Jeong

Approved By

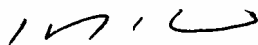

Date

Dec 20, 2004

James Kwon

INDEX

| <u>CONTENTS</u> | <u>Page</u> |
|--|-------------|
| 1. General Description of EUT ----- | <u>4</u> |
| 2. General Information of EUT ----- | <u>4</u> |
| 3. Test Procedure ----- | <u>5</u> |
| Test Results | |
| 4. Output Power Conducted----- | <u>10</u> |
| 5. Radiated Spurious Emissions----- | <u>11</u> |
| 6. Conducted Spurious Emissions----- | <u>23</u> |
| 7. Audio Frequency Response----- | <u>36</u> |
| 8. Audio Low Pass Filter Frequency Response----- | <u>37</u> |
| 9. Modulation Limited----- | <u>38</u> |
| 10. Occupied Bandwidth----- | <u>40</u> |
| 11. Frequency Stability----- | <u>42</u> |
| 12. Transient Frequency Behaviours of the Transmitter----- | <u>43</u> |
| 13. Attachment A – Photos of the Test Setup ----- | <u>50</u> |
| 14. Attachment B – Photos of the EUT----- | <u>51</u> |

1. General Description of EUT

AQ-10 has a general features in range of 136.000-174.000MHz. AQ-10 has a general features shown as below

- 1-1. Compact design & size (125(W)*55(H)*40(D),350.7g with high capable battery)
- 1-2. Heavy duty durable construction
- 1-3. 128 channels
- 1-4. 38 CTCSS/83 CDCSS/ 83 INVERR CDCSS
- 1-5. PC Programmable, transferable by cloning
- 1-6. Timer-out timer(TOT)
- 1-7. Busy Lockout(BCLO)
- 1-8. Battery saving mode
- 1-9. Low battery alert
- 1-10. DTMF ANI
- 1-11. Transmit output power High/Low DC 7.5V Ni-MH battery

2. General Information of EUT

Transceiver

| | |
|------------------------|------------------------|
| Power Supply | DC 7.5V |
| Operating Frequency | 136.000MHz -174.000MHz |
| Transmit Power | 2W(low)/5W(high) |
| Modulation of Channels | FM |
| Channel spacing | 12.5kHz and 25kHz |
| Emission | 8K5F3E/ 16K0F3E |
| Communication method | Simplex |
| Number of Channels | 128channels |
| Antenna Type | External |

3. Test Procedure

The test procedure are performed following the test stands ANSI/EIA-603, if applicable.

3.1 Output Power Conducted FCC 2.1046(a), FCC 90.205

The conducted RF output power is the available power at the output terminals of the transmitter when the output terminals are corrected to the standard transmitter load.

The test sample is feeding a 50 ohm coaxial attenuator which is connected to a spectrum analyzer.

The power output at the transmitter antenna port is determined by adding the value of the attenuator to the spectrum analyzer reading.

The test are performed at the frequencies(low, middle, high channels of the EUT operating band) and full rated power levels of the transmitter.



3.2 Radiated Spurious Emissions FCC 2.1053, FCC 90.210

Radiated spurious emissions are emissions from the EUT when transmitting in non-radiating load on frequencies outside the operating band.

ERP measurement of spurious emission the general substitution method as described at 2.4.2.

In order to suppress inter-modulation products in the spectrum analyzer a notch filter is used, if applicable.



3.3 Conducted Spurious Emissions FCC 2.1051

Conducted spurious emissions are emissions at the antenna terminal on frequencies outside the operating band. The test is performed according the principle below using a computer controlled test set-up.

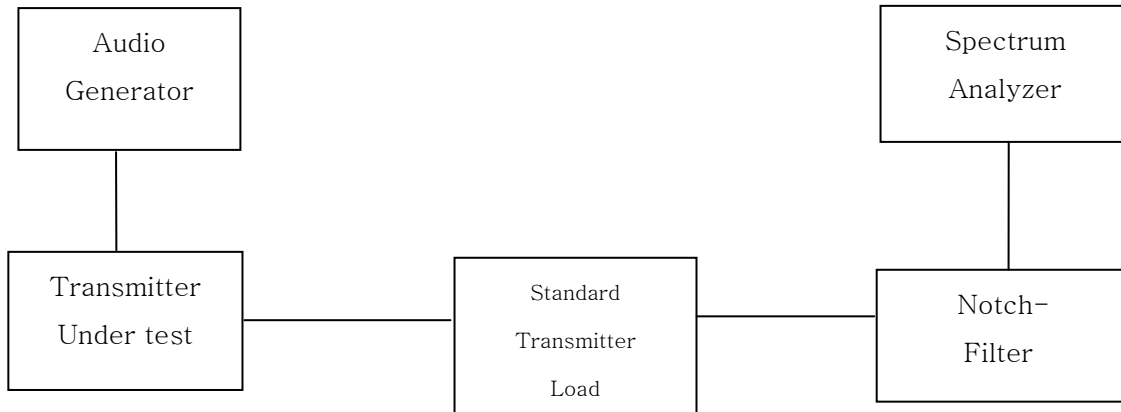

The transmitter is modulated with 2500Hz sine wave at an input level 16dB greater than that necessary to produce 50% of rated system deviation.

3.4 Audio Frequency Response FCC 2.1047(a)

The audio frequency response is the degree of closeness to which the frequency deviation of the transmitter follows a prescribed characteristic.

The frequency response of the audio modulation part is adjusted to get 20% of the rated system deviation.

The deviations obtained over the frequency range from 100Hz to 5000Hz are recorded and compared with the reference deviation as follows:

$$\text{Audio Frequency Response} = 20 \log \left[\frac{\text{DEV}_{\text{Freq}}}{\text{DEV}_{\text{ref}}} \right]$$

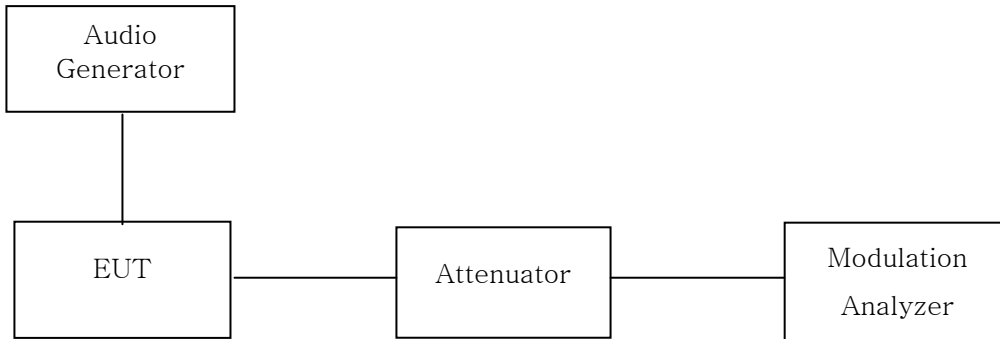

3.5 Audio Low Pass Filter Frequency Response FCC 2.1047(a), FCC 90.242(b)(8)

The audio low pass filter response is the frequency response of the post limits low pass filter circuit above 3000Hz.

It is measured from 1kHz(reference point) to 50kHz with test set-up below.

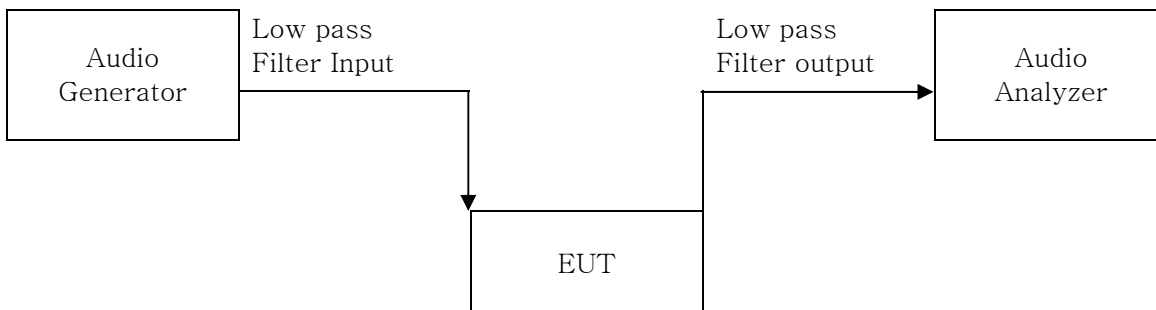

3.6 Modulation Limiting FCC 2.1047(b),22.915(b),90.210

Modulation limiting is the transmitter circuit's ability to limit the transmitter from producing deviations in excess of rated system deviation.

The modulation response is measured at certain modulation frequencies, related to 1000Hz reference signal. The basic setting is 60% of full rated deviation which will be increased the audio generator level from -20dB to 20dB in nine steps.

Tests are performed for positive and negative modulation.

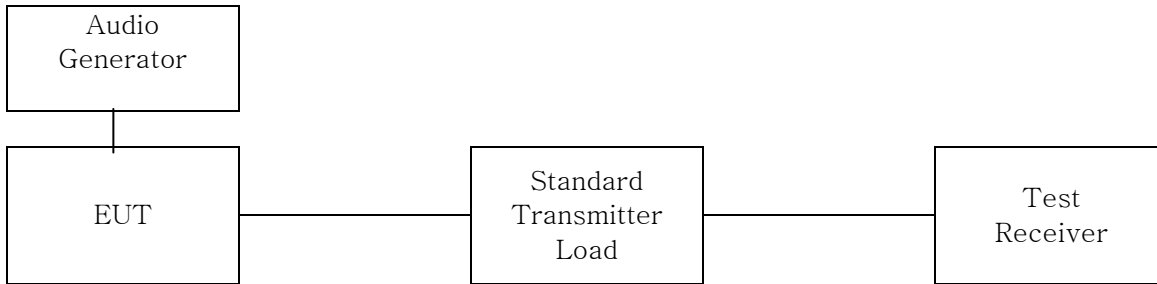

3.7 Occupied Bandwidth FCC 2.1049,90.210

The occupied bandwidth, that is the frequency bandwidth such that, below its lower and above its upper frequency limits, the mean powers radiated are each equal to 0,5 percent of the total mean power radiated by a given emission.

The transmitter is modulated by a 2500Hz tone at an input level 16dB greater than that necessary to produce 50 percent modulation.

The input level shall be established at the frequency of maximum response of the audio modulating circuit.

Different emission masks are required.

Emission Mask B for transmitters that are equipped with an audio low pass filter.

Emission Mask D for transmitters designed to operate with a 12.5 kHz bandwidth.

3.8 Frequency stability FCC 2.1055,FCC 90.213

The carrier frequency is the stability of the transmitter to maintain an assigned carrier frequency.

The frequency stability is measured with variation of ambient temperature from -30°C to +50°C.

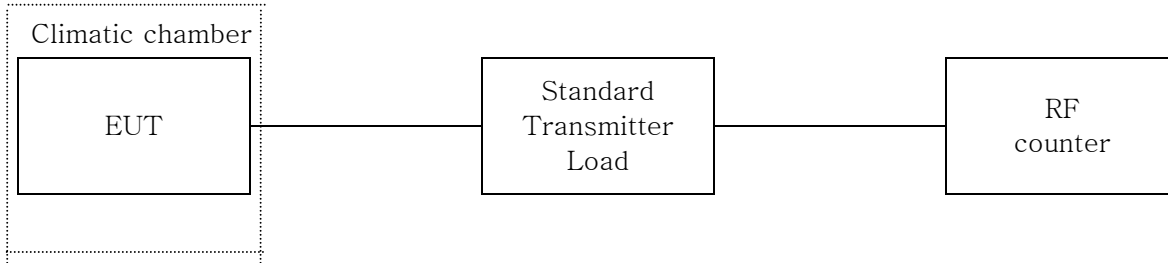

3.9 Transient frequency behavior FCC 90.214

Transient frequency behavior is a measure of the difference, as a function in time, of the actual transmitter frequency to the assigned transmitter frequency behavior for a 30dB step during the switch on and switch off time.



4. Output Power Conducted FCC 2.1046(a), FCC90.205

| Power Level [W] | Frequency [MHz] | Channel Spacing [kHz] | RF Output Power [W] | Nominal DC Voltage [V] |
|-----------------|-----------------|-----------------------|---------------------|------------------------|
| 2 | 136.000 | 25 | 2.20 | 7.5 |
| | 155.000 | 25 | 1.80 | 7.5 |
| | 174.000 | 25 | 1.63 | 7.5 |
| 5 | 136.000 | 25 | 3.33 | 7.5 |
| | 155.000 | 25 | 4.11 | 7.5 |
| | 174.000 | 25 | 3.98 | 7.5 |

Test Equipment Used

| EQUIPMENT | MANUFACTURER | MODEL | CAL DUE. |
|-------------------|--------------|--------|-----------|
| Spectrum Analyzer | H/P | 8565E | Dec. 2005 |
| Signal Generator | Agilent | E4438C | May. 2005 |
| Power Meter | Agilent | E4416A | May. 2005 |
| Power Sensor | Agilent | E9327A | May. 2005 |
| DC Power Supply | Agilent | 6674A | May. 2005 |

5. Radiated Spurious Emissions FCC 2.1053(a), FCC90.210

TX FREQ=136.000MHz

Low Power Setting

Channel Spacing 12.5kHz

| Frequency [MHz] | Polarization | Max. Power Value [dBm] | Specification Limit [dBm] | Margin [dB] |
|-----------------|--------------|------------------------|---------------------------|-------------|
| 272.000 | H | <-30 | -20 | >10 |
| 408.000 | H | <-30 | -20 | >10 |
| 544.000 | V | <-30 | -20 | >10 |
| 680.000 | V | <-30 | -20 | >10 |
| 816.000 | H | <-30 | -20 | >10 |
| 952.000 | V | <-30 | -20 | >10 |
| 1088.000 | V | <-30 | -20 | >10 |
| 1224.000 | V | <-30 | -20 | >10 |
| 1360.000 | V | <-30 | -20 | >10 |

Test Equipment Used

| EQUIPMENT | MANUFACTURER | MODEL | CAL DUE. |
|-------------------|------------------|-----------|-----------|
| Spectrum analyzer | H/P | 8593E | Aug. 2005 |
| Signal Generator | Agilent | 8648D | May. 2005 |
| Dipole Antenna | Schwarzbeck Mess | UHAP | May. 2005 |
| Dipole Antenna | Schwarzbeck Mess | UHAP | May. 2005 |
| Dummy Load | BIRD | 8404 | Dec. 2005 |
| Horn Antenna | Schwarzbeck | BBHA9120A | Jul. 2006 |
| Horn Antenna | Schwarzbeck | BBHA9120A | Jul. 2006 |
| Biconical Antenna | Schwarzbeck | VHA9103 | Jan. 2005 |
| Biconical Antenna | EMCO | 3104C | Feb. 2005 |
| Log-periodic | S/B | UHALP9107 | Jan. 2005 |
| Anechoic Chamber | Seo Young EMC | - | - |

TX FREQUE = 136.000 MHz

High Power Setting

Channel Spacing 12.5kHz

| Frequency [MHz] | Polarization | Max. Power Value [dBm] | Specification Limit [dBm] | Margin [dB] |
|-----------------|--------------|------------------------|---------------------------|-------------|
| 272.000 | V | <-30 | -20 | >10 |
| 408.000 | V | <-30 | -20 | >10 |
| 544.000 | V | <-30 | -20 | >10 |
| 680.000 | V | <-30 | -20 | >10 |
| 816.000 | V | <-30 | -20 | >10 |
| 952.000 | V | <-30 | -20 | >10 |
| 1088.000 | V | <-30 | -20 | >10 |
| 1224.000 | V | <-30 | -20 | >10 |
| 1360.000 | V | <-30 | -20 | >10 |

Test Equipment Used

| EQUIPMENT | MANUFACTURER | MODEL | CAL DUE. |
|-------------------|------------------|-----------|-----------|
| Spectrum analyzer | H/P | 8593E | Aug. 2005 |
| Signal Generator | Agilent | 8648D | May. 2005 |
| Dipole Antenna | Schwarzbeck Mess | UHAP | May. 2005 |
| Dipole Antenna | Schwarzbeck Mess | UHAP | May. 2005 |
| Dummy Load | BIRD | 8404 | Dec. 2005 |
| Horn Antenna | Schwarzbeck | BBHA9120A | Jul. 2006 |
| Horn Antenna | Schwarzbeck | BBHA9120A | Jul. 2006 |
| Biconical Antenna | Schwarzbeck | VHA9103 | Jan. 2005 |
| Biconical Antenna | EMCO | 3104C | Feb. 2005 |
| Log-periodic | S/B | UHALP9107 | Jan. 2005 |
| Anechoic Chamber | Seo Young EMC | - | - |

TX FREQUE =136.000 MHz

Low Power Setting

Channel Spacing 25kHz

| Frequency [MHz] | Polarization | Max. Power Value [dBm] | Specification Limit [dBm] | Margin [dB] |
|-----------------|--------------|------------------------|---------------------------|-------------|
| 272.000 | V | <-30 | -13 | >17 |
| 408.000 | V | <-30 | -13 | >17 |
| 544.000 | V | <-30 | -13 | >17 |
| 680.000 | V | <-30 | -13 | >17 |
| 816.000 | V | <-30 | -13 | >17 |
| 952.000 | V | <-30 | -13 | >17 |
| 1088.000 | V | <-30 | -13 | >17 |
| 1224.000 | V | <-30 | -13 | >17 |
| 1360.000 | V | <-30 | -13 | >17 |

Test Equipment Used

| EQUIPMENT | MANUFACTURER | MODEL | CAL DUE. |
|-------------------|------------------|-----------|-----------|
| Spectrum analyzer | H/P | 8593E | Aug. 2005 |
| Signal Generator | Agilent | 8648D | May. 2005 |
| Dipole Antenna | Schwarzbeck Mess | UHAP | May. 2005 |
| Dipole Antenna | Schwarzbeck Mess | UHAP | May. 2005 |
| Dummy Load | BIRD | 8404 | Dec. 2005 |
| Horn Antenna | Schwarzbeck | BBHA9120A | Jul. 2006 |
| Horn Antenna | Schwarzbeck | BBHA9120A | Jul. 2006 |
| Biconical Antenna | Schwarzbeck | VHA9103 | Jan. 2005 |
| Biconical Antenna | EMCO | 3104C | Feb. 2005 |
| Log-periodic | S/B | UHALP9107 | Jan. 2005 |
| Anechoic Chamber | Seo Young EMC | - | - |

TX FREQUE =136.000 MHz

High Power Setting

Channel Spacing 25kHz

| Frequency [MHz] | Polarization | Max. Power Value [dBm] | Specification Limit [dBm] | Margin [dB] |
|-----------------|--------------|------------------------|---------------------------|-------------|
| 272.000 | V | <-30 | -13 | >17 |
| 408.000 | V | <-30 | -13 | >17 |
| 544.000 | V | <-30 | -13 | >17 |
| 680.000 | V | <-30 | -13 | >17 |
| 816.000 | V | <-30 | -13 | >17 |
| 952.000 | V | <-30 | -13 | >17 |
| 1088.000 | V | <-30 | -13 | >17 |
| 1224.000 | V | <-30 | -13 | >17 |
| 1360.000 | V | <-30 | -13 | >17 |

Test Equipment Used

| EQUIPMENT | MANUFACTURER | MODEL | CAL DUE. |
|-------------------|------------------|-----------|-----------|
| Spectrum analyzer | H/P | 8593E | Aug. 2005 |
| Signal Generator | Agilent | 8648D | May. 2005 |
| Dipole Antenna | Schwarzbeck Mess | UHAP | May. 2005 |
| Dipole Antenna | Schwarzbeck Mess | UHAP | May. 2005 |
| Dummy Load | BIRD | 8404 | Dec. 2005 |
| Horn Antenna | Schwarzbeck | BBHA9120A | Jul. 2006 |
| Horn Antenna | Schwarzbeck | BBHA9120A | Jul. 2006 |
| Biconical Antenna | Schwarzbeck | VHA9103 | Jan. 2005 |
| Biconical Antenna | EMCO | 3104C | Feb. 2005 |
| Log-periodic | S/B | UHALP9107 | Jan. 2005 |
| Anechoic Chamber | Seo Young EMC | - | - |

TX FREQUE = 155.000MHz

Low Power Setting

Channel Spacing 12.5kHz

| Frequency [MHz] | Polarization | Max. Power Value [dBm] | Specification Limit [dBm] | Margin [dB] |
|-----------------|--------------|------------------------|---------------------------|-------------|
| 310.000 | V | <-30 | -20 | >10 |
| 465.000 | V | <-30 | -20 | >10 |
| 620.000 | V | <-30 | -20 | >10 |
| 775.000 | V | <-30 | -20 | >10 |
| 930.000 | V | <-30 | -20 | >10 |
| 1085.000 | V | <-30 | -20 | >10 |
| 1240.000 | V | <-30 | -20 | >10 |
| 1395.000 | V | <-30 | -20 | >10 |
| 1550.000 | V | <-30 | -20 | >10 |

Test Equipment Used

| EQUIPMENT | MANUFACTURER | MODEL | CAL DUE. |
|-------------------|------------------|-----------|-----------|
| Spectrum analyzer | H/P | 8593E | Aug. 2005 |
| Signal Generator | Agilent | 8648D | May. 2005 |
| Dipole Antenna | Schwarzbeck Mess | UHAP | May. 2005 |
| Dipole Antenna | Schwarzbeck Mess | UHAP | May. 2005 |
| Dummy Load | BIRD | 8404 | Dec. 2005 |
| Horn Antenna | Schwarzbeck | BBHA9120A | Jul. 2006 |
| Horn Antenna | Schwarzbeck | BBHA9120A | Jul. 2006 |
| Biconical Antenna | Schwarzbeck | VHA9103 | Jan. 2005 |
| Biconical Antenna | EMCO | 3104C | Feb. 2005 |
| Log-periodic | S/B | UHALP9107 | Jan. 2005 |
| Anechoic Chamber | Seo Young EMC | - | - |

TX FREQUE = 155.000MHz

High Power Setting

Channel Spacing 12.5kHz

| Frequency [MHz] | Polarization | Max. Power Value [dBm] | Specification Limit [dBm] | Margin [dB] |
|-----------------|--------------|------------------------|---------------------------|-------------|
| 310.000 | V | <-30 | -20 | >10 |
| 465.000 | V | <-30 | -20 | >10 |
| 620.000 | V | <-30 | -20 | >10 |
| 775.000 | V | <-30 | -20 | >10 |
| 930.000 | V | <-30 | -20 | >10 |
| 1085.000 | V | <-30 | -20 | >10 |
| 1240.000 | V | <-30 | -20 | >10 |
| 1395.000 | V | <-30 | -20 | >10 |
| 1550.000 | V | <-30 | -20 | >10 |

Test Equipment Used

| EQUIPMENT | MANUFACTURER | MODEL | CAL DUE. |
|-------------------|------------------|-----------|-----------|
| Spectrum analyzer | H/P | 8593E | Aug. 2005 |
| Signal Generator | Agilent | 8648D | May. 2005 |
| Dipole Antenna | Schwarzbeck Mess | UHAP | May. 2005 |
| Dipole Antenna | Schwarzbeck Mess | UHAP | May. 2005 |
| Dummy Load | BIRD | 8404 | Dec. 2005 |
| Horn Antenna | Schwarzbeck | BBHA9120A | Jul. 2006 |
| Horn Antenna | Schwarzbeck | BBHA9120A | Jul. 2006 |
| Biconical Antenna | Schwarzbeck | VHA9103 | Jan. 2005 |
| Biconical Antenna | EMCO | 3104C | Feb. 2005 |
| Log-periodic | S/B | UHALP9107 | Jan. 2005 |
| Anechoic Chamber | Seo Young EMC | - | - |

TX FREQUE = 155.000MHz

Low Power Setting

Channel Spacing 25kHz

| Frequency [MHz] | Polarization | Max. Power Value [dBm] | Specification Limit [dBm] | Margin [dB] |
|-----------------|--------------|------------------------|---------------------------|-------------|
| 310.000 | V | <-30 | -13 | >17 |
| 465.000 | V | <-30 | -13 | >17 |
| 620.000 | V | <-30 | -13 | >17 |
| 775.000 | V | <-30 | -13 | >17 |
| 930.000 | V | <-30 | -13 | >17 |
| 1085.000 | V | <-30 | -13 | >17 |
| 1240.000 | V | <-30 | -13 | >17 |
| 1395.000 | V | <-30 | -13 | >17 |
| 1550.000 | V | <-30 | -13 | >17 |

Test Equipment Used

| EQUIPMENT | MANUFACTURER | MODEL | CAL DUE. |
|-------------------|------------------|-----------|-----------|
| Spectrum analyzer | H/P | 8593E | Aug. 2005 |
| Signal Generator | Agilent | 8648D | May. 2005 |
| Dipole Antenna | Schwarzbeck Mess | UHAP | May. 2005 |
| Dipole Antenna | Schwarzbeck Mess | UHAP | May. 2005 |
| Dummy Load | BIRD | 8404 | Dec. 2005 |
| Horn Antenna | Schwarzbeck | BBHA9120A | Jul. 2006 |
| Horn Antenna | Schwarzbeck | BBHA9120A | Jul. 2006 |
| Biconical Antenna | Schwarzbeck | VHA9103 | Jan. 2005 |
| Biconical Antenna | EMCO | 3104C | Feb. 2005 |
| Log-periodic | S/B | UHALP9107 | Jan. 2005 |
| Anechoic Chamber | Seo Young EMC | - | - |

TX FREQUE = 155.000MHz

High Power Setting

Channel Spacing 25kHz

| Frequency [MHz] | Polarization | Max. Power Value [dBm] | Specification Limit [dBm] | Margin [dB] |
|-----------------|--------------|------------------------|---------------------------|-------------|
| 310.000 | V | <-30 | -13 | >17 |
| 465.000 | V | <-30 | -13 | >17 |
| 620.000 | V | <-30 | -13 | >17 |
| 775.000 | V | <-30 | -13 | >17 |
| 930.000 | V | <-30 | -13 | >17 |
| 1085.000 | V | <-30 | -13 | >17 |
| 1240.000 | V | <-30 | -13 | >17 |
| 1395.000 | V | <-30 | -13 | >17 |
| 1550.000 | V | <-30 | -13 | >17 |

Test Equipment Used

| EQUIPMENT | MANUFACTURER | MODEL | CAL DUE. |
|-------------------|------------------|-----------|-----------|
| Spectrum analyzer | H/P | 8593E | Aug. 2005 |
| Signal Generator | Agilent | 8648D | May. 2005 |
| Dipole Antenna | Schwarzbeck Mess | UHAP | May. 2005 |
| Dipole Antenna | Schwarzbeck Mess | UHAP | May. 2005 |
| Dummy Load | BIRD | 8404 | Dec. 2005 |
| Horn Antenna | Schwarzbeck | BBHA9120A | Jul. 2006 |
| Horn Antenna | Schwarzbeck | BBHA9120A | Jul. 2006 |
| Biconical Antenna | Schwarzbeck | VHA9103 | Jan. 2005 |
| Biconical Antenna | EMCO | 3104C | Feb. 2005 |
| Log-periodic | S/B | UHALP9107 | Jan. 2005 |
| Anechoic Chamber | Seo Young EMC | - | - |

TX FREQUE = 174.000 MHz

Low Power Setting

Channel Spacing 12.5kHz

| Frequency [MHz] | Polarization | Max. Power Value [dBm] | Specification Limit [dBm] | Margin [dB] |
|-----------------|--------------|------------------------|---------------------------|-------------|
| 348.000 | V | -27 | -20 | 7 |
| 522.000 | V | <-30 | -20 | >10 |
| 696.000 | V | <-30 | -20 | >10 |
| 870.000 | V | <-30 | -20 | >10 |
| 1044.000 | V | <-30 | -20 | >10 |
| 1218.000 | V | <-30 | -20 | >10 |
| 1392.000 | V | <-30 | -20 | >10 |
| 1566.000 | V | <-30 | -20 | >10 |
| 1740.000 | V | <-30 | -20 | >10 |

Test Equipment Used

| EQUIPMENT | MANUFACTURER | MODEL | CAL DUE. |
|-------------------|------------------|-----------|-----------|
| Spectrum analyzer | H/P | 8593E | Aug. 2005 |
| Signal Generator | Agilent | 8648D | May. 2005 |
| Dipole Antenna | Schwarzbeck Mess | UHAP | May. 2005 |
| Dipole Antenna | Schwarzbeck Mess | UHAP | May. 2005 |
| Dummy Load | BIRD | 8404 | Dec. 2005 |
| Horn Antenna | Schwarzbeck | BBHA9120A | Jul. 2006 |
| Horn Antenna | Schwarzbeck | BBHA9120A | Jul. 2006 |
| Biconical Antenna | Schwarzbeck | VHA9103 | Jan. 2005 |
| Biconical Antenna | EMCO | 3104C | Feb. 2005 |
| Log-periodic | S/B | UHALP9107 | Jan. 2005 |
| Anechoic Chamber | Seo Young EMC | - | - |

TX FREQUE = 174.000 MHz

High Power Setting

Channel Spacing 12.5kHz

| Frequency [MHz] | Polarization | Max. Power Value [dBm] | Specification Limit [dBm] | Margin [dB] |
|-----------------|--------------|------------------------|---------------------------|-------------|
| 348.000 | V | -26 | -20 | 6 |
| 522.000 | V | <-30 | -20 | >10 |
| 696.000 | V | <-30 | -20 | >10 |
| 870.000 | V | <-30 | -20 | >10 |
| 1044.000 | V | <-30 | -20 | >10 |
| 1218.000 | V | <-30 | -20 | >10 |
| 1392.000 | V | <-30 | -20 | >10 |
| 1566.000 | V | <-30 | -20 | >10 |
| 1740.000 | V | <-30 | -20 | >10 |

Test Equipment Used

| EQUIPMENT | MANUFACTURER | MODEL | CAL DUE. |
|-------------------|------------------|-----------|-----------|
| Spectrum analyzer | H/P | 8593E | Aug. 2005 |
| Signal Generator | Agilent | 8648D | May. 2005 |
| Dipole Antenna | Schwarzbeck Mess | UHAP | May. 2005 |
| Dipole Antenna | Schwarzbeck Mess | UHAP | May. 2005 |
| Dummy Load | BIRD | 8404 | Dec. 2005 |
| Horn Antenna | Schwarzbeck | BBHA9120A | Jul. 2006 |
| Horn Antenna | Schwarzbeck | BBHA9120A | Jul. 2006 |
| Biconical Antenna | Schwarzbeck | VHA9103 | Jan. 2005 |
| Biconical Antenna | EMCO | 3104C | Feb. 2005 |
| Log-periodic | S/B | UHALP9107 | Jan. 2005 |
| Anechoic Chamber | Seo Young EMC | - | - |

TX FREQUE = 174.000 MHz

Low Power Setting

Channel Spacing 25kHz

| Frequency [MHz] | Polarization | Max. Power Value [dBm] | Specification Limit [dBm] | Margin [dB] |
|-----------------|--------------|------------------------|---------------------------|-------------|
| 348.000 | V | -26 | -13 | 13 |
| 522.000 | V | <-30 | -13 | >17 |
| 696.000 | V | <-30 | -13 | >17 |
| 870.000 | V | <-30 | -13 | >17 |
| 1044.000 | V | <-30 | -13 | >17 |
| 1218.000 | V | <-30 | -13 | >17 |
| 1392.000 | V | <-30 | -13 | >17 |
| 1566.000 | V | <-30 | -13 | >17 |
| 1740.000 | V | <-30 | -13 | >17 |

Test Equipment Used

| EQUIPMENT | MANUFACTURER | MODEL | CAL DUE. |
|-------------------|------------------|-----------|-----------|
| Spectrum analyzer | H/P | 8593E | Aug. 2005 |
| Signal Generator | Agilent | 8648D | May. 2005 |
| Dipole Antenna | Schwarzbeck Mess | UHAP | May. 2005 |
| Dipole Antenna | Schwarzbeck Mess | UHAP | May. 2005 |
| Dummy Load | BIRD | 8404 | Dec. 2005 |
| Horn Antenna | Schwarzbeck | BBHA9120A | Jul. 2006 |
| Horn Antenna | Schwarzbeck | BBHA9120A | Jul. 2006 |
| Biconical Antenna | Schwarzbeck | VHA9103 | Jan. 2005 |
| Biconical Antenna | EMCO | 3104C | Feb. 2005 |
| Log-periodic | S/B | UHALP9107 | Jan. 2005 |
| Anechoic Chamber | Seo Young EMC | - | - |

TX FREQUE = 174.000 MHz

High Power Setting

Channel Spacing 25kHz

| Frequency [MHz] | Polarization | Max. Power Value [dBm] | Specification Limit [dBm] | Margin [dB] |
|-----------------|--------------|------------------------|---------------------------|-------------|
| 348.000 | V | -25 | -13 | 12 |
| 522.000 | V | <-30 | -13 | >17 |
| 696.000 | V | <-30 | -13 | >17 |
| 870.000 | V | <-30 | -13 | >17 |
| 1044.000 | V | <-30 | -13 | >17 |
| 1218.000 | V | <-30 | -13 | >17 |
| 1392.000 | V | <-30 | -13 | >17 |
| 1566.000 | V | <-30 | -13 | >17 |
| 1740.000 | V | <-30 | -13 | >17 |

Test Equipment Used

| EQUIPMENT | MANUFACTURER | MODEL | CAL DUE. |
|-------------------|------------------|-----------|-----------|
| Spectrum analyzer | H/P | 8593E | Aug. 2005 |
| Signal Generator | Agilent | 8648D | May. 2005 |
| Dipole Antenna | Schwarzbeck Mess | UHAP | May. 2005 |
| Dipole Antenna | Schwarzbeck Mess | UHAP | May. 2005 |
| Dummy Load | BIRD | 8404 | Dec. 2005 |
| Horn Antenna | Schwarzbeck | BBHA9120A | Jul. 2006 |
| Horn Antenna | Schwarzbeck | BBHA9120A | Jul. 2006 |
| Biconical Antenna | Schwarzbeck | VHA9103 | Jan. 2005 |
| Biconical Antenna | EMCO | 3104C | Feb. 2005 |
| Log-periodic | S/B | UHALP9107 | Jan. 2005 |
| Anechoic Chamber | Seo Young EMC | - | - |

TX FREQE =136.000 MHz

Low Power Setting

Channel Spacing 25kHz

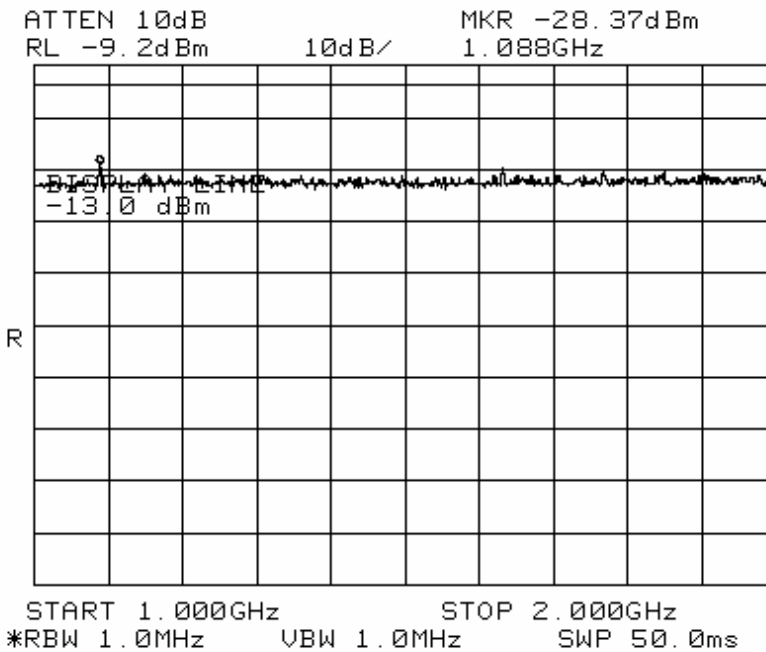
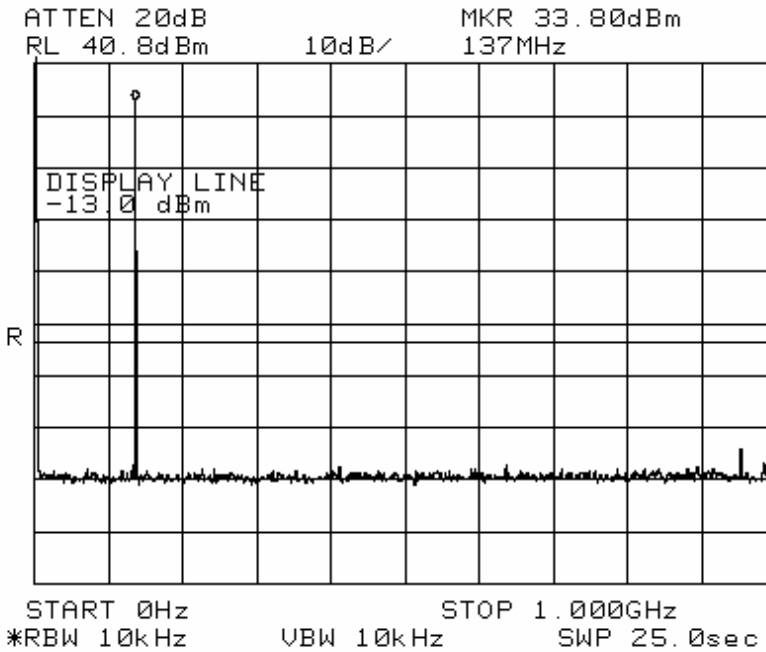

TX FREQE= 136.000MHz

High Power Setting

Channel Spacing 25kHz

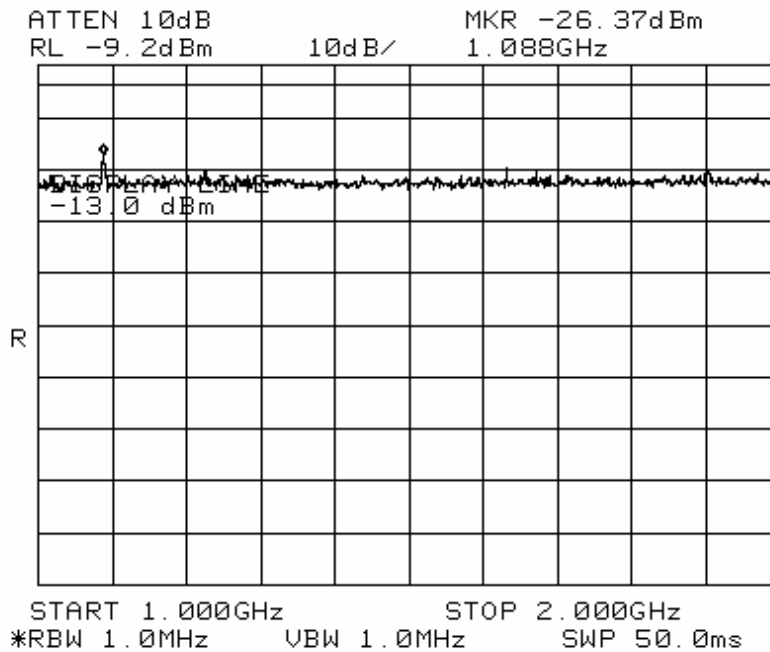
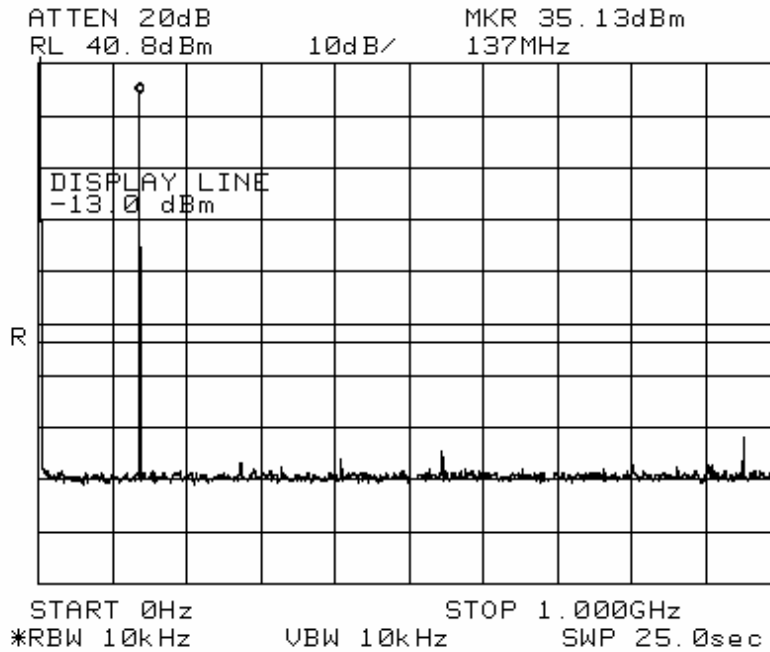

TX FREQE = 155.000 MHz

High Power Setting

Channel Spacing 25kHz

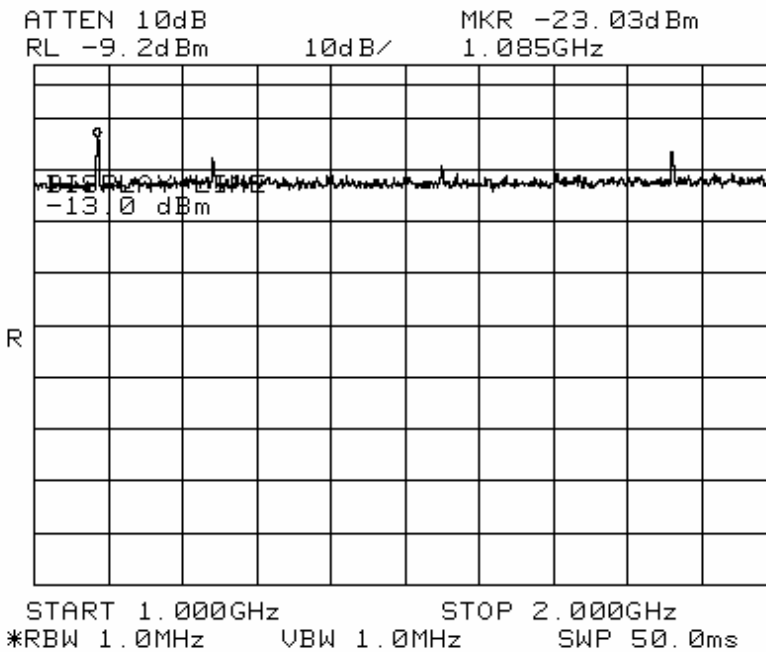
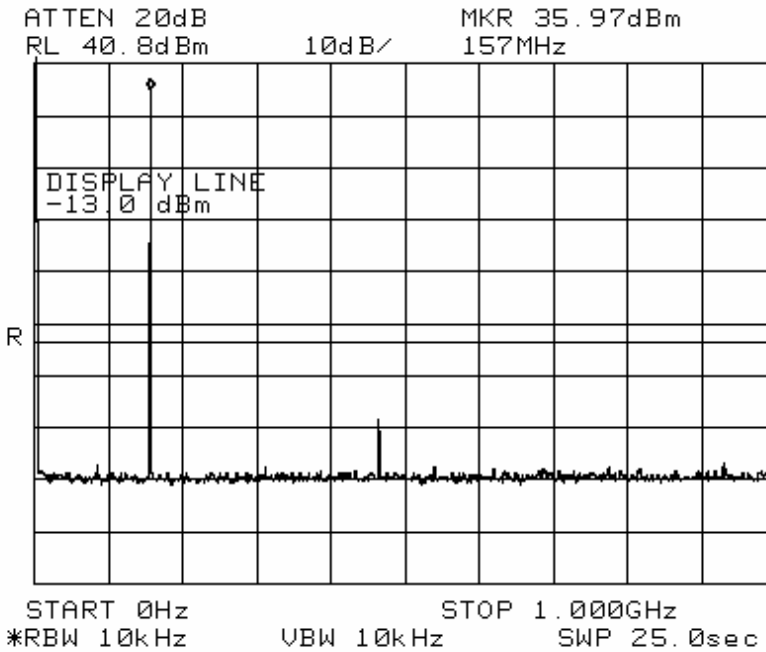

TX FREQE = 174.000 MHz

Low Power Setting

Channel Spacing 12.5kHz

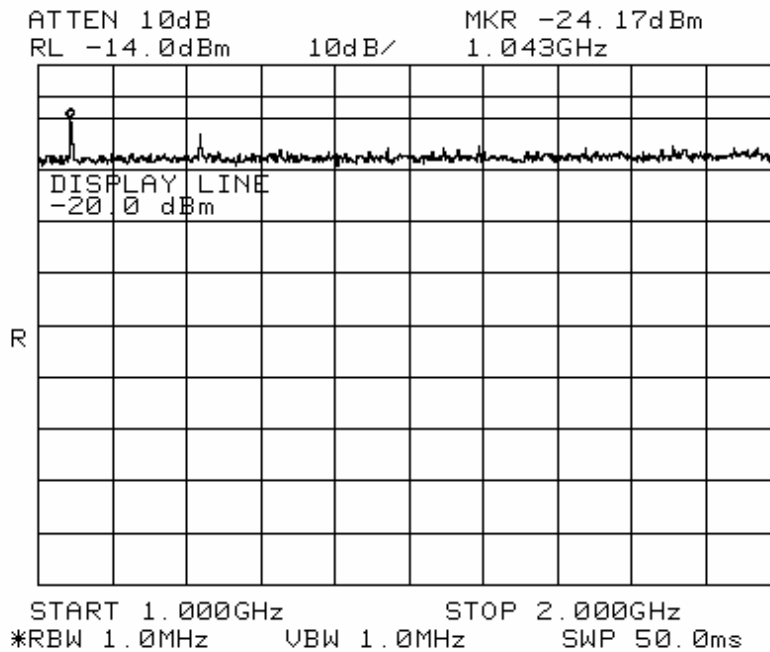
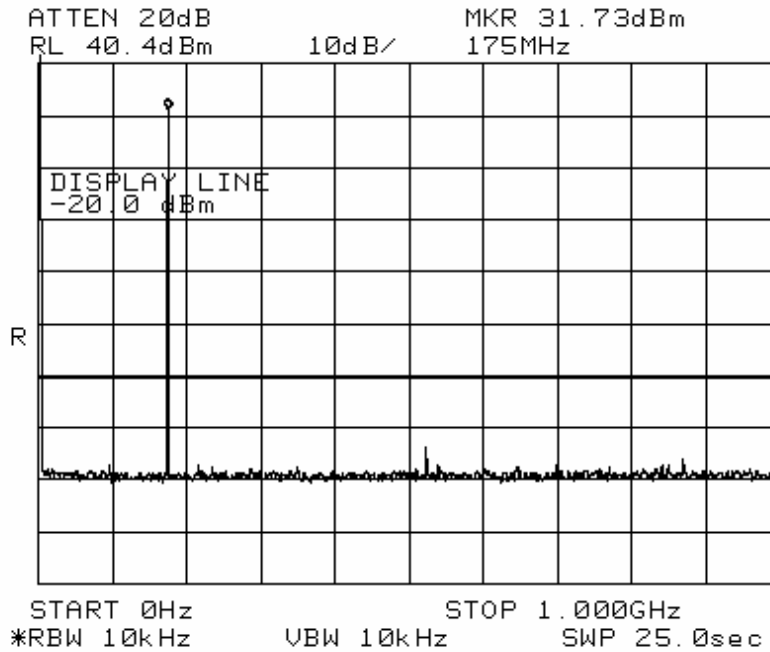

TX FREQE = 174.000 MHz

Low Power Setting

Channel Spacing 25kHz

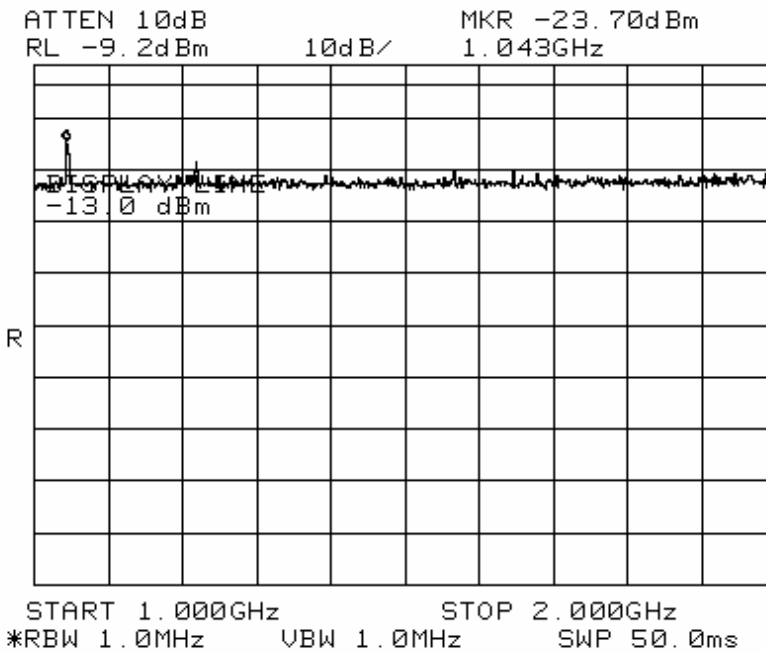
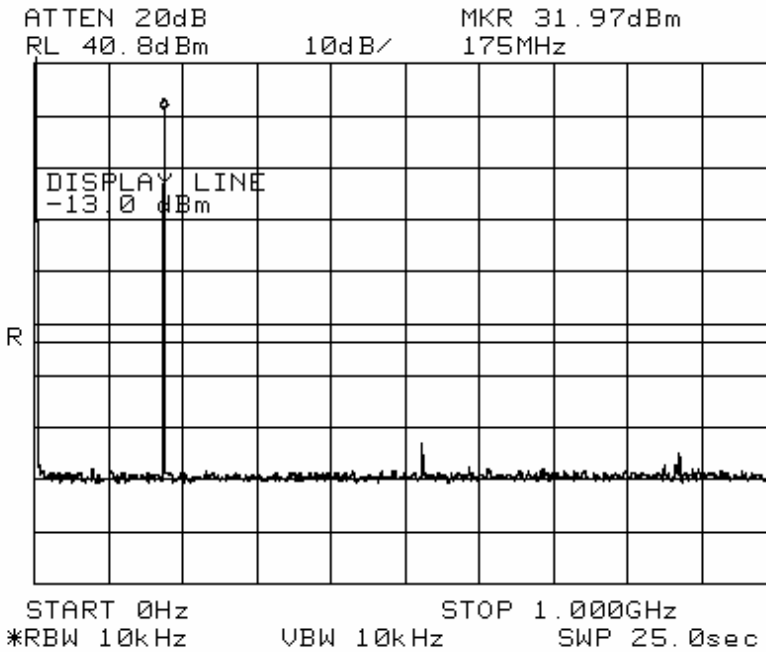

TX FREQE = 174.000 MHz

High Power Setting

Channel Spacing 25kHz

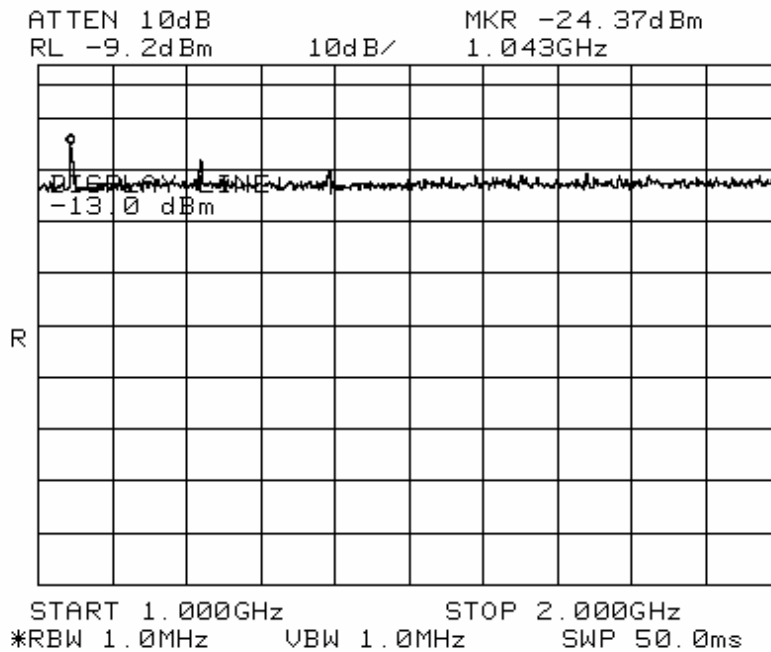
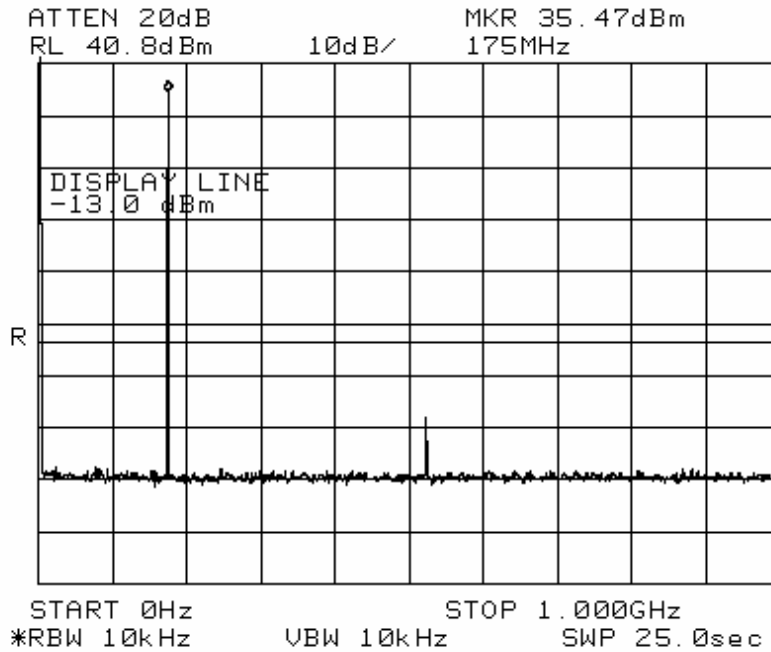

Test Equipment Used

| EQUIPMENT | MANUFACTURER | MODEL | CAL DUE. |
|---------------------|--------------|--------|-----------|
| Spectrum Analyzer | H/P | 8565E | Dec. 2005 |
| Modulation Analyzer | H/P | 8901B | Dec. 2005 |
| Function Generator | Agilent | 33220A | May. 2005 |
| DC Power Supply | Agilent | 6674A | May. 2005 |

7.Audio Frequency Response FCC 2.1.047(a)

Operating Frequency : 155.000MHz

Channel : Middle

Nominal DC Voltage: 7.5Vdc

| Audio frequency [Hz] | Channel spacing 12.5kHz | | Channel spacing 25kHz | |
|----------------------|--------------------------|--------------------------|--------------------------|--------------------------|
| | Measured Deviation [kHz] | Calculated Response [dB] | Measured Deviation [kHz] | Calculated Response [dB] |
| 100 | 0.054 | -19.34 | 0.085 | -21.39 |
| 200 | 0.060 | -18.43 | 0.127 | -17.90 |
| 300 | 0.121 | -12.34 | 0.227 | -12.85 |
| 400 | 0.196 | -8.15 | 0.320 | -9.87 |
| 500 | 0.246 | -6.18 | 0.433 | -7.24 |
| 600 | 0.299 | -4.48 | 0.551 | -5.15 |
| 700 | 0.345 | -3.24 | 0.670 | -3.45 |
| 800 | 0.398 | -2.00 | 0.782 | -2.11 |
| 900 | 0.451 | -0.91 | 0.904 | -0.85 |
| 1000 | 0.501 | 0 | 0.997 | 0 |
| 2000 | 0.839 | 4.48 | 1.620 | 4.22 |
| 2500 | 0.881 | 4.90 | 1.652 | 4.39 |
| 3000 | 0.963 | 5.68 | 1.816 | 5.21 |
| 4000 | 0.196 | -8.42 | 0.345 | -9.22 |
| 5000 | 0.082 | -15.72 | 0.139 | -17.11 |

Test Equipment Used

| EQUIPMENT | MANUFACTURER | MODEL | CAL DUE. |
|---------------------|--------------|--------|-----------|
| Spectrum Analyzer | H/P | 8565E | Dec. 2005 |
| Modulation Analyzer | H/P | 8901B | Dec. 2005 |
| Function Generator | Agilent | 33220A | May. 2005 |
| DC Power Supply | Agilent | 6674A | May. 2005 |

8.Audio Low Pass Filter Frequency Response FCC 2.1047(a), FCC 90.210

Operating Frequency : 155.000 MHz

Channel : Middle

Nominal DC Voltage: 7.5 Vdc

| Audio frequency [kHz] | Channel spacing 12.5kHz | Channel spacing 25kHz |
|-----------------------|-------------------------|-----------------------|
| | Response [dB] | Response [dB] |
| 1 | 0 | 0 |
| 2 | -1.85 | -0.79 |
| 3 | -5.42 | -2.73 |
| 4 | -17.30 | -14.62 |
| 5 | -28.05 | -25.92 |
| 6 | -33.75 | -33.91 |
| 7 | -39.11 | -38.11 |
| 8 | -45.21 | -39.41 |
| 9 | -50.20 | -45.11 |
| 10 | -54.21 | -47.31 |
| 20 | <-60 | -49.00 |
| 30 | <-60 | <-60 |
| 50 | <-60 | <-60 |

Test Equipment Used

| EQUIPMENT | MANUFACTURER | MODEL | CAL DUE. |
|---------------------|--------------|--------|-----------|
| Spectrum Analyzer | H/P | 8565E | Dec. 2005 |
| Modulation Analyzer | H/P | 8901B | Dec. 2005 |
| Audio Analyzer | H/P | 8903B | Dec. 2005 |
| Spectrum Analyzer | Agilent | E4440A | May. 2005 |
| Function Generator | Agilent | 33220A | May. 2005 |
| DC Power Supply | Agilent | 6674A | May. 2005 |

9.Modulation Limiting FCC 2.1047(b), FCC 22.915(b), FCC 90.242(b)(8)

Operating Frequency : 155.000 MHz

Channel : Middle

Nominal DC Voltage: 7.5Vdc

12.5kHz channel spacing

| Audio input level Relative [dB] | Positive peak deviation [kHz] | | | Negative peak deviation [kHz] | | |
|------------------------------------|----------------------------------|--------|--------|----------------------------------|--------|--------|
| | 300Hz | 1000Hz | 3000Hz | 300Hz | 1000Hz | 3000Hz |
| -20 | 0.091 | 0.207 | 0.247 | 0.094 | 0.208 | 0.288 |
| -15 | 0.122 | 0.311 | 0.406 | 0.110 | 0.317 | 0.469 |
| -10 | 0.156 | 0.518 | 0.656 | 0.132 | 0.519 | 0.770 |
| -5 | 0.191 | 0.860 | 0.996 | 0.186 | 0.871 | 1.060 |
| 0 | 0.309 | 1.499 | 1.020 | 0.281 | 1.504 | 1.077 |
| 5 | 0.493 | 1.716 | 1.023 | 0.460 | 1.910 | 1.089 |
| 10 | 0.889 | 1.733 | 1.023 | 0.823 | 1.882 | 1.091 |
| 15 | 1.330 | 1.725 | 1.028 | 1.487 | 1.887 | 1.095 |
| 20 | 1.833 | 1.731 | 1.023 | 2.227 | 1.891 | 1.090 |

25kHz channel spacing

| Audio input level Relative [dB] | Positive peak deviation [kHz] | | | Negative peak deviation [kHz] | | |
|------------------------------------|----------------------------------|--------|--------|----------------------------------|--------|--------|
| | 300Hz | 1000Hz | 3000Hz | 300Hz | 1000Hz | 3000Hz |
| -20 | 0.102 | 0.340 | 0.537 | 0.108 | 0.344 | 0.581 |
| -15 | 0.131 | 0.556 | 0.875 | 0.138 | 0.558 | 0.986 |
| -10 | 0.189 | 0.953 | 1.510 | 0.181 | 0.941 | 1.702 |
| -5 | 0.287 | 1.697 | 2.160 | 0.276 | 1.610 | 2.266 |
| 0 | 0.491 | 3.003 | 2.201 | 0.491 | 2.991 | 2.278 |
| 5 | 0.829 | 3.796 | 2.201 | 0.846 | 4.251 | 2.290 |
| 10 | 1.445 | 3.842 | 2.223 | 1.429 | 4.290 | 2.301 |
| 15 | 2.536 | 3.851 | 2.218 | 2.546 | 4.330 | 2.307 |
| 20 | 4.010 | 3.833 | 2.215 | 4.690 | 4.330 | 2.301 |

Limits:

| Channel spacing [kHz] | Rated frequency deviation [kHz] |
|-----------------------|---------------------------------|
| 12,5 | 2,5 |
| 25 | 5 |

Test Equipment Used

| EQUIPMENT | MANUFACTURER | MODEL | CAL DUE. |
|---------------------|--------------|--------|-----------|
| Spectrum Analyzer | H/P | 8565E | Dec. 2005 |
| Modulation Analyzer | H/P | 8901B | Dec. 2005 |
| Function Generator | Agilent | 33220A | May. 2005 |
| DC Power Supply | Agilent | 6674A | May. 2005 |

10.Occupied Bandwidth FCC 2.1049, FCC 90.210

High power mode

| Frequency Channel | Occupied Bandwidth Mask D Channel spacing 12.5kHz | Occupied Bandwidth Mask B Channel spacing 25kHz |
|-------------------|--|--|
| Middle | Pass | Pass |

Operating Frequency : 155.000 MHz

Channel : Middle

Nominal DC Voltage: 7.5Vdc

MAX POWER SETTING

MASK B

CHANNEL SPACING = 25kHz

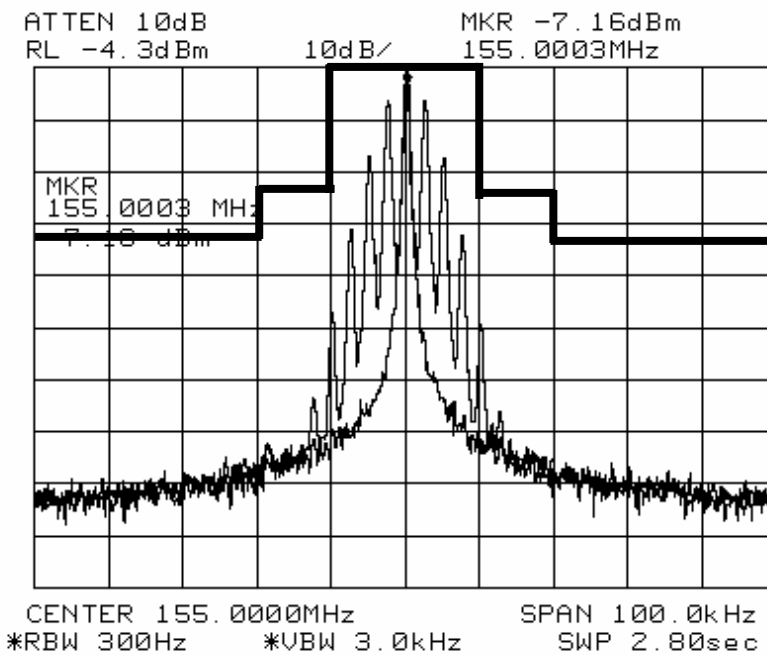

Limits: Are determined by used emission mask.

Operating Frequency : 155.000 MHz

Channel : Middle

Nominal DC Voltage: 7.5Vdc

MAX POWER SETTING

MASK D

CHANNEL SPACING = 12.5kHz

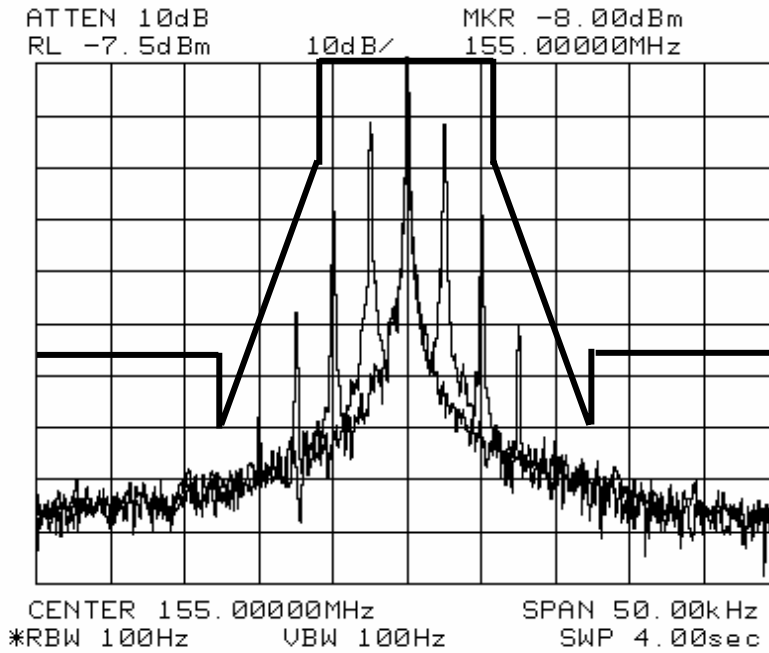

Limits: Are determined by used emission mask.

Test Equipment Used

| EQUIPMENT | MANUFACTURER | MODEL | CAL DUE. |
|---------------------|--------------|--------|-----------|
| Spectrum Analyzer | H/P | 8565E | Dec. 2005 |
| Modulation Analyzer | H/P | 8901B | Dec. 2005 |
| Function Generator | Agilent | 33220A | May. 2005 |
| DC Power Supply | Agilent | 6674A | May. 2005 |

11. Frequency Stability FCC 90.213, FCC2.1055, FCC 22.915(b)

| Voltage [%] | Voltage [V] | Temperature [deg C] | Measured Frequency [MHz] | Frequency Error [ppm] |
|-------------|-------------|---------------------|--------------------------|-----------------------|
| 100% | 7.5V | -30 | 155.000078 | 0.50 |
| 100% | 7.5V | -20 | 155.000070 | 0.45 |
| 100% | 7.5V | -10 | 155.000062 | 0.40 |
| 100% | 7.5V | 0 | 155.000078 | 0.50 |
| 100% | 7.5V | + 10 | 155.000075 | 0.48 |
| 100% | 7.5V | + 20 | 155.000073 | 0.47 |
| 100% | 7.5V | + 30 | 155.000043 | 0.28 |
| 100% | 7.5V | + 40 | 155.000011 | 0.07 |
| 100% | 7.5V | + 50 | 155.000007 | 0.05 |
| 100% | 7.5V | + 60 | 154.999921 | -0.51 |
| 85% | 6.38V | + 20 | 155.000076 | 0.49 |
| 115% | 8.63V | + 20 | 155.000072 | 0.46 |

Limits:

| Channel spacing [kHz] | Frequency error [ppm] |
|-----------------------|-----------------------|
| 12.5 | 2.5 |
| 25 | 5 |

Test Equipment Used

| EQUIPMENT | MANUFACTURER | MODEL | CAL DUE. |
|---------------------|-------------------|-----------|-----------|
| Spectrum Analyzer | H/P | 8565E | Dec. 2005 |
| Frequency Counter | Anritsu | MF2414B | Dec 2005 |
| Temperature Chamber | Han-Gil Technique | HGTP-4050 | Nov. 2005 |
| DC Power Supply | Agilent | 6674A | May. 2005 |

12. Transient Frequency Behaviour of the Transmitter FCC 90.214

Limits:

| Time intervals ^{1,2} | Maximum Frequency Difference ³ | All equipment | |
|--|---|----------------|----------------|
| | | 150 to 174 MHz | 421 to 512 MHz |
| Transient Frequency Behaviour for Equipment Designed to Operate on 25kHz Channel | | | |
| t ₁ ⁴ ----- | ±25.0kHz | 5.0 ms | 10.0 ms |
| t ₂ ----- - | ±12.5kHz | 20.0 ms | 25.0 ms |
| t ₃ ⁴ ----- | ±25.0kHz | 5.0 ms | 10.0 ms |
| Transient Frequency Behaviour for Equipment Designed to Operate on 12,5kHz Channel | | | |
| t ₁ ⁴ ----- | ±12.5kHz | 5.0 ms | 10.0 ms |
| t ₂ ----- | ±6.25kHz | 20.0 ms | 25.0 ms |
| t ₃ ⁴ ----- | ±12.5kHz | 5.0 ms | 10.0 ms |
| Transient Frequency Behaviour for Equipment Designed to Operate on 6.25kHz Channel | | | |
| t ₁ ⁴ ----- | ±6.25kHz | 5.0 ms | 10.0 ms |
| t ₂ ----- | ±3.125kHz | 20.0 ms | 25.0 ms |
| t ₃ ⁴ ----- | ±6.25kHz | 5.0 ms | 10.0 ms |

¹ t_{on} is the instant when a 1kHz test signal is completely suppressed, including any capture time due to phasing.

t₁ is the time period immediately following t_{on}.

t₂ is the time period immediately following t₁.

t₃ is the time period from the instant when the transmitter is turned off until t_{off}.

t_{off} is the instant when the 1kHz test signal starts to rise.

² During the time from the end of t₂ to the beginning of t₃, the frequency difference must not exceed the limits specified in §90.213.

³ Difference between the actual transmitter frequency and the assigned transmitter frequency .

⁴ If the transmitter carrier output power rating is 6watts or less, the frequency difference during this time may exceed the maximum frequency difference for this period.

Plot

Ch 1 Narrow

Switching from OFF to ON (t_1 & t_2)

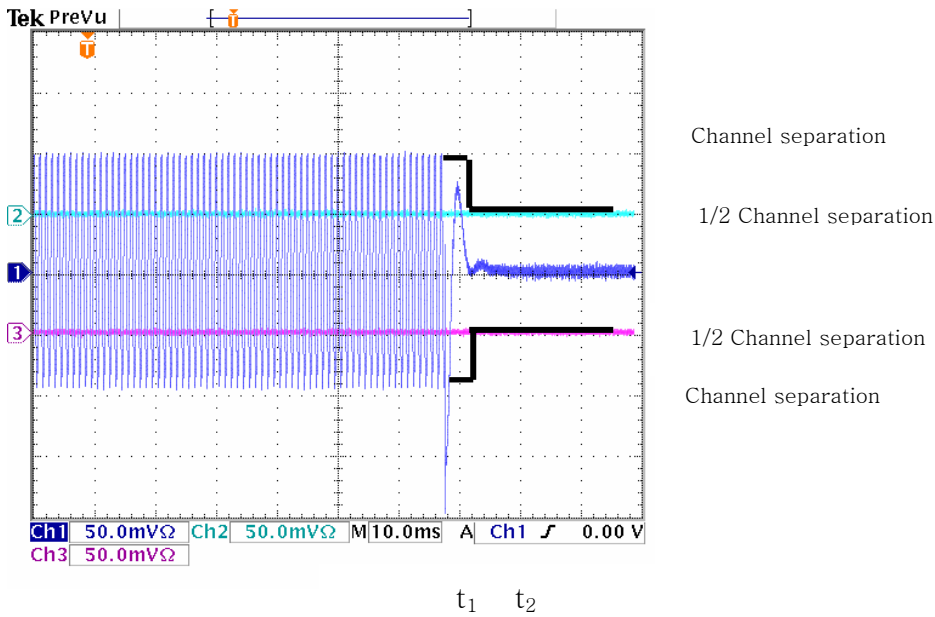

Switching from ON to OFF (t_3)

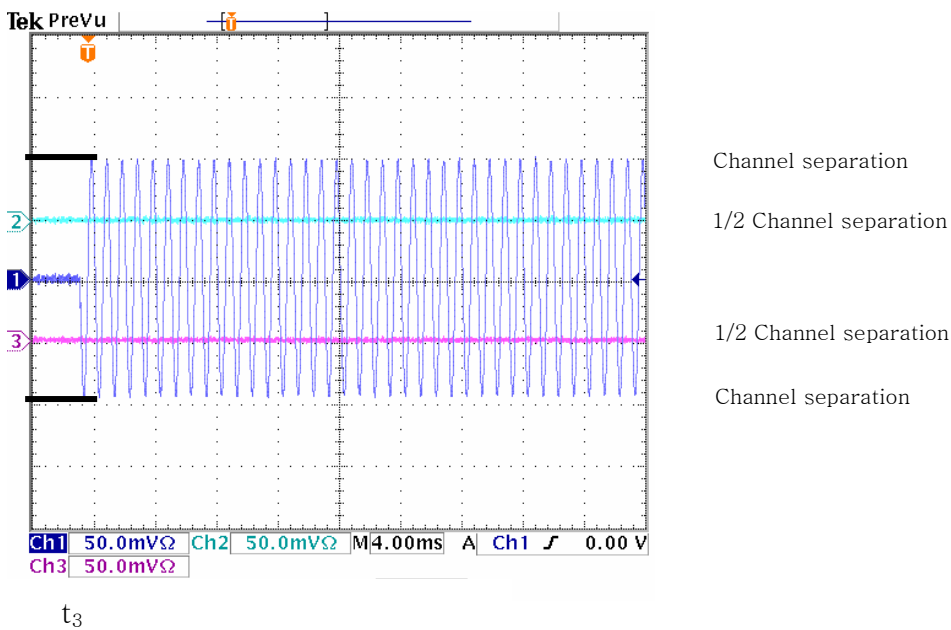

Ch 3 Narrow

Switching from OFF to ON (t_1 & t_2)

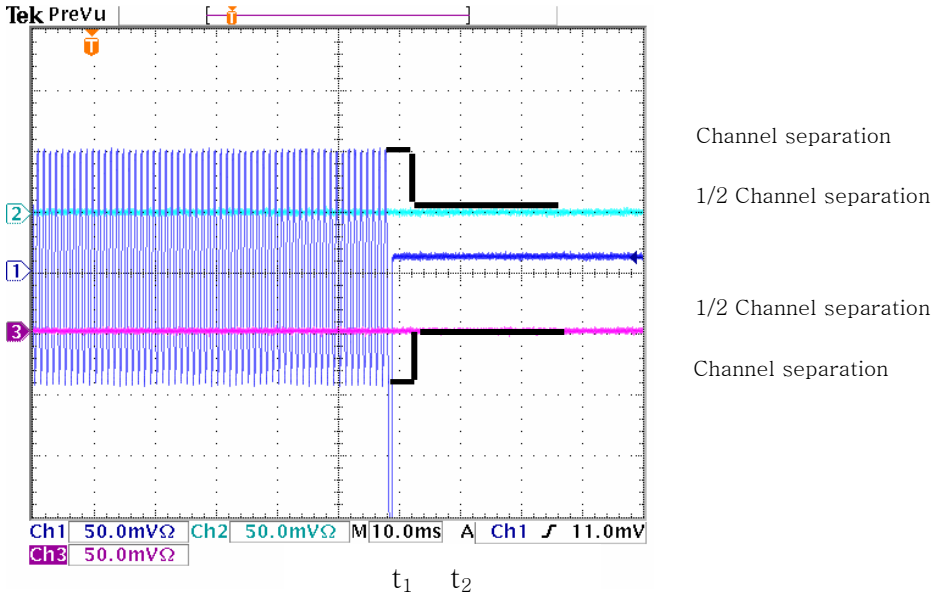

Switching from ON to OFF (t_3)

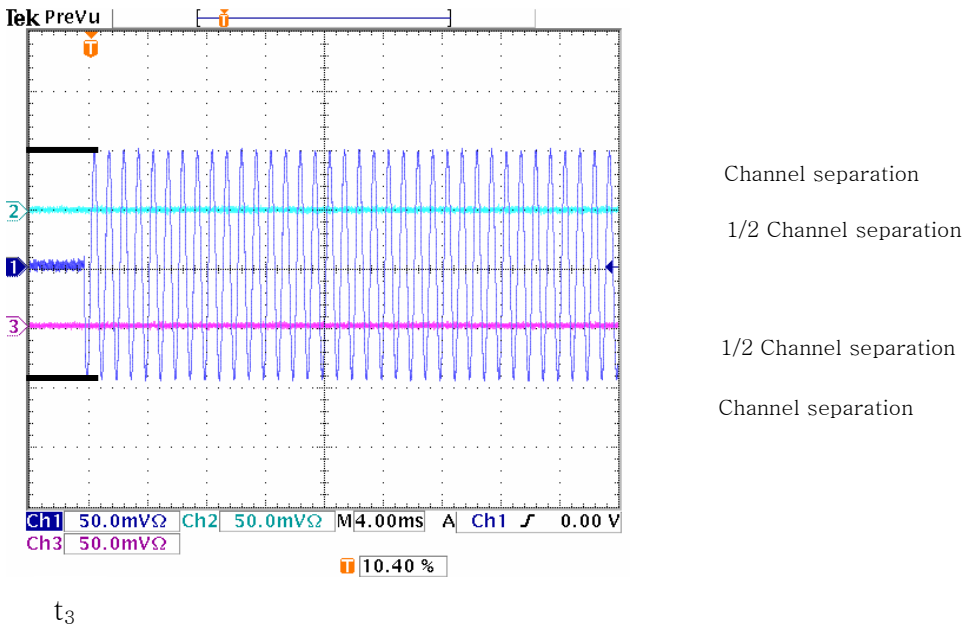

Test Equipment Used

| EQUIPMENT | MANUFACTURER | MODEL | CAL DUE. |
|-------------------------------|--------------|----------|-----------|
| Signal Generator | Agilent | E4438C | May. 2005 |
| Modulation Analyzer | H/P | 8901B | Dec. 2005 |
| DC Power Supply | Agilent | 6674A | May. 2005 |
| Digital Phosphor Oscilloscope | Tektronix | TDS3054B | May. 2005 |

Plot

Ch 1 Wide

Switching from OFF to ON (t_1 & t_2)

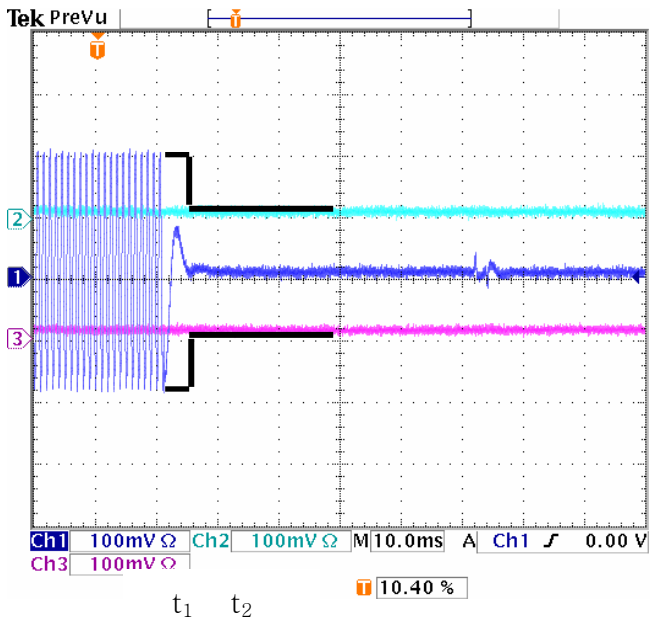

Channel separation

1/2 Channel separation

1/2 Channel separation

Channel separation

Switching from ON to OFF (t_3)

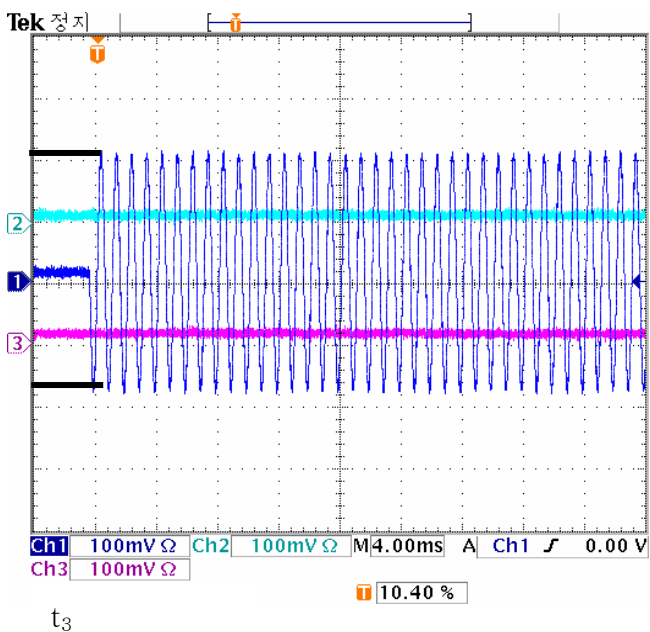

Channel separation

1/2 Channel separation

1/2 Channel separation

Channel separation

Ch 3 Wide

Switching from OFF to ON (t_1 & t_2)

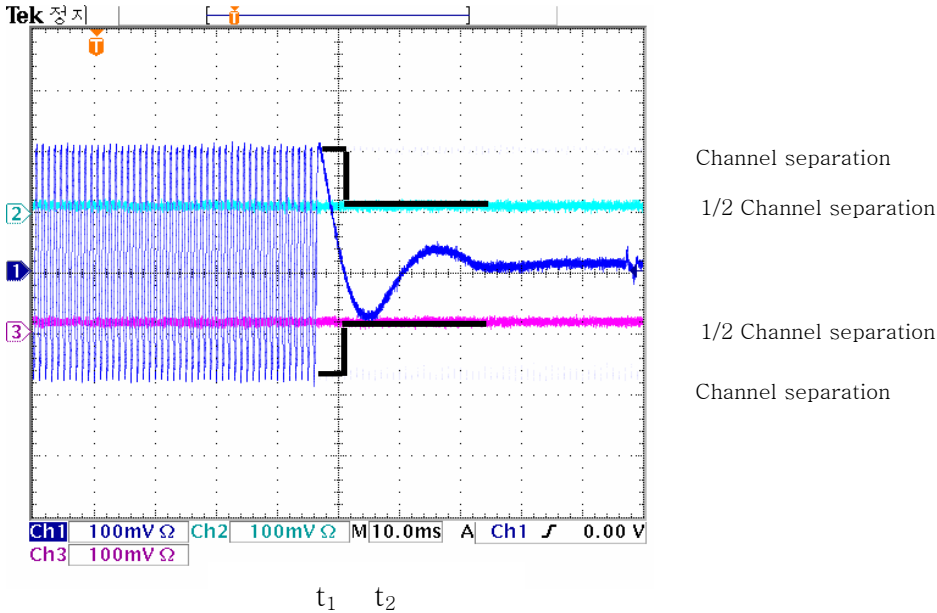

Switching from ON to OFF (t_3)

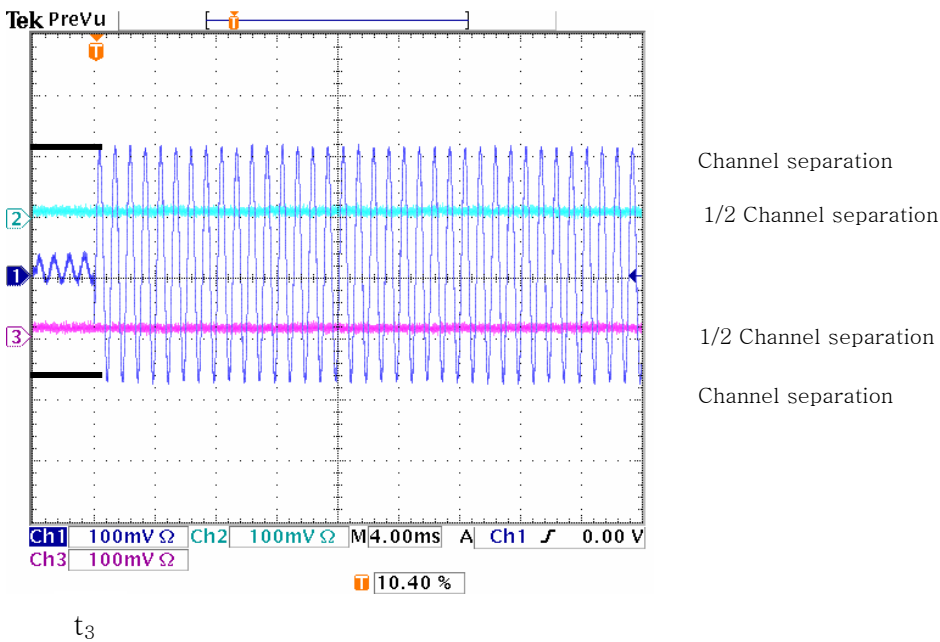

Test Equipment Used

| EQUIPMENT | MANUFACTURER | MODEL | CAL DUE. |
|-------------------------------|--------------|----------|-----------|
| Signal Generator | Agilent | E4438C | May. 2005 |
| Modulation Analyzer | H/P | 8901B | Dec. 2005 |
| DC Power Supply | Agilent | 6674A | May. 2005 |
| Digital Phosphor Oscilloscope | Tektronix | TDS3054B | May. 2005 |

13. Attachment A – Photos of the test setup