

SGS TESTING KOREA

TEST – REPORT

SAR Compliance Test Report

Test report no.:
STROS-04-008

SAR

SGS TESTING KOREA Co., Ltd.

18-34, Sanbon-dong, Gunpo-si, Gyeonggi-do, Korea, 435-041

PHONE +82 31 428 5700

FAX +82 31 427 2371

TABLE OF CONTENTS

1	<u>General information</u>
1.1	<u>Notes</u>
1.2	<u>Testing laboratory</u>
1.3	<u>Details of approval holder</u>
1.4	<u>Manufacturer</u>
1.5	<u>Test item</u>
1.6	<u>Test results</u>
1.7	<u>Test standards</u>
2	<u>Technical test</u>
2.1	<u>Summary of test results</u>
2.2	<u>Test environment</u>
2.3	<u>Test equipment utilized</u>
2.4	<u>Definitions</u>
2.5	<u>Measurement system description</u>
2.6	<u>Test system specification</u>
2.7	<u>Measurement procedure</u>
2.8	<u>Reference positions for handheld radio transmitters</u>
2.9	<u>Measurement uncertainty</u>
3	<u>Tissue and system verification</u>
3.1	<u>Tissue verification</u>
3.2	<u>System verification</u>
4	<u>Test Results</u>
5	<u>References</u>
6	<u>Appendix</u>

1 General Information**1.1 Notes**

The purpose of conformity testing is to increase the probability of adherence to the essential requirements or conformity specifications, as appropriate.

The complexity of the technical specifications, however, means that full and thorough testing is impractical for both technical and economic reasons.

Furthermore, there is no guarantee that a test sample which has passed all the relevant tests conforms to a specification. The existence of the tests nevertheless provides the confidence that the test sample possesses the qualities as maintained and that its performance generally conforms to representative cases of communications equipment.

The test results of this test report relate exclusively to the item tested as specified in 1.5.

The test report may only be reproduced or published in full.

Reproduction or publication of extracts from the report requires the prior written approval of the SGS Testing Korea.

I attest to the accuracy of data. All measurements reported herein were performed by me or were made under my supervision and are correct to the best of my knowledge and belief. I assume full responsibility for the completeness of these measurements and vouch for the qualification of all persons taking them.

Tester:

December 21, 2004

Elvin Lee



Date

Name

Signature

Technical responsibility for area of testing:

December 22, 2004

James Kwon

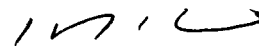

Date

Name

Signature

SGS Testing Korea Co., Ltd.

18 - 34, Sanbon - dong, Gunpo - si, Gyeonggi - do, Korea, 435 - 041

Tel. +82 31 428 5700 / Fax. +82 31 427 2371

<http://www.sgstesting.co.kr>

1.2 Location of Testing laboratory

SGS Testing Korea Co., Ltd.
18-34, Sanbon-dong, Gunpo-si, Gyeonggi-do
Korea
Telephone : +82 31 428 5700
Fax : +82 31 427 2371

1.3 Details of approval holder

Name **AIRTECH Information & Communication Co., Ltd.**
Address **9L 33B 613-9 Namchon-dong, Namdong-gu,
Incheon City, Korea**
Country **Korea**
Telephone **82-32-815-1119 (406)**
Fax **82-32-815-1778**
Contact **JaeWon Lee**
E-Mail leejw@airtech21.com

1.4 Manufacturer: (if applicable)

Name :
Street :
Town :
Country :

1.5 Test item

FCC ID : ONKAQ-10
Description of test item : FM Handheld Transceiver
Type identification : AQ-10
Serial number : without; Identical prototype
Device category : PCF (Licensed Portable Transmitter Held To Face)

Technical data

Tx Frequency range : 136 – 174 MHz
Rx Frequency range : 136 – 174 MHz
Max. Conducted RF output power : 5.0 W
Power supply : 7.5 V DC rechargeable battery
Antenna Tx : External
Antenna Rx : External
Antenna type : Helical Antenna
Additional information : Tx and Rx. antenna are the same.

1.6 Test Results

Max. SAR Measurement : **1.82 W/kg** (averaged over 1 gram)

This EUT has been shown to be capable of compliance for localized specific absorption rate (SAR) for uncontrolled environment/general population exposure limits specified in ANSI/IEEE Std. C95.1-1992 and had been tested in accordance with the measurement procedures specified in FCC/OET Bulletin 65 Supplement C (2001) and IEEE Std. 1528-200X(Draft 6.5, January 2002).

1.7 Test standards

Standards : - IEEE Std. 1528-200X (Draft 6.5, January 2002)
FCC Rule Part(s) : - FCC OET Bulletin 65, Supplement C, Edition 01-01

2 Technical test

2.1 Summary of test results

Classification

Uncontrolled environment/general population	
Controlled exposure/occupational environment	X

Applicable Configuration

Handset (Head)	
Handset (Held to face)	X
Handset (Body)	
Headset (Head)	
Body Worn Equipment	X

EUT complies with the RF radiation exposure limits of the FCC as shown by the SAR measurement results. These measurements are taken to simulate the RF effects exposure under worst-case conditions. The EUT complies with the requirements in respect to all parameters subject to the test. The test results and statements relate only to the item(s) tested.

Please note that the absorption and distribution of electromagnetic energy in the body are very complex phenomena that depend on the mass, shape, and size of the body, the orientation of the body with respect to the field vectors, and the electrical properties of both the body and the environment. Other variables that may play a substantial role in possible biological effects are those that characterize the environment (e.g. ambient temperature, air velocity, relative humidity, and body insulation) and those that characterize the individual (e.g. age, gender, activity level, debilitation, or disease). Because innumerable factors may interact to determine the specific biological outcome of an exposure to electromagnetic fields, any protection guide shall consider maximal amplification of biological effects as a result of field-body interaction, environmental conditions, and physiological variables. [1]

2.2 Test environment

Room temperature	: 22.2–22.6°C
Liquid temperature	: 21.8-22.1°C
Relative humidity content	: 58%
Details of power supply	: 7.5 V DC

2.3 Test equipment utilized

Type / Model	Calib. Date	S/N
Staubli Robot / RX90BL	N/A	F03/5W05A1/A/01
Staubli Robot Controller / RX90B L	N/A	F03/5W05A1/C/01
Staubli Manual Control Operator	N/A	D22134006 1
PC / IBM NetVista 2.66	N/A	99LA523
OS / Windows 2000	N/A	-
SPEAG DAE / DAE3	April 2004	567
SPEAG E-Field Probe / ET3DV6	April 2004	1782
SPEAG Dummy Probe	N/A	-
SPEAG SAM Phantom	N/A	TP-1300, TP-1299
SPEAG Flat Phantom	N/A	1003, 1005
SPEAG Validation Dipole D450V2	July 2003	1015
SPEAG Validation Dipole D835V2	June 2003	490
SPEAG Validation Dipole D900V2	June 2003	188
SPEAG Validation Dipole D1800V2	June 2003	2d074
SPEAG Validation Dipole D1900V2	June 2003	5d033
SPEAG Validation Dipole D2450V2	July 2003	734
Dipole Antenna/ VHAP/UHAP	May 2004	958
Mounting Device	N/A	-

2.4 Definitions

2.4.1 SAR

The specific absorption rate (SAR) is defined as the time derivative of the incremental energy (dW) absorbed by (dissipated in) an incremental mass (dm) contained in a volume element (dV) of a given density (ρ), expressed in watts per kilogram (W/kg)

$$SAR = \frac{d}{dt} \left(\frac{dW}{dm} \right) = \frac{d}{dt} \left(\frac{dW}{\rho_i dV} \right) = \frac{\sigma}{\rho} |E_t|^2$$

where:
$$\frac{dW}{dt} = \int_v E \cdot J dV = \int_v \sigma E^2 dV$$

2.4.2 Uncontrolled Exposure

The general population/uncontrolled exposure limits are applicable to situations in which the general public may be exposed or in which persons who are exposed as a consequence of their employment may not be made fully aware of the potential for exposure or cannot exercise control over their exposure. Members of the general public would come under this category when exposure is not employment-related; for example, in the case of a wireless transmitter that exposes persons in its vicinity. Warning labels placed on low-power consumer devices such as cellular telephones are not considered sufficient to allow the device to be considered under the occupational/controlled category, and the general population/uncontrolled exposure limits apply to these devices. [2]

2.4.3 Controlled Exposure

In general, occupational/controlled exposure limits are applicable to situations in which persons are exposed as a consequence of their employment, who have been made fully aware of the potential for exposure and can exercise control over their exposure. This exposure category is also applicable when the exposure is of a transient nature due to incidental passage through a location where the exposure levels may be higher than the general population/uncontrolled limits, but the exposed person is fully aware of the potential for exposure and can exercise control over his or her exposure by leaving the area or by some other appropriate means. Awareness of the potential for RF exposure in a workplace or similar environment can be provided through specific training as part of a RF safety program. If appropriate, warning signs and labels can also be used to establish such awareness by providing prominent information on the risk of potential exposure and instructions on the risk of potential exposure and instructions on methods to minimize such exposure risks. [2]

Push-to-talk applications (PTT) operating in front of a person's face and certain body worn configurations as occupational/controlled exposure. The consideration of a 50% duty factor for PTT simplex radio-caring typical voice traffic is possible.

2.5 Measurement System Description

2.5.1 System Setup

Measurements are performed using the DASY4 automated dosimetric assessment system (figure 1) made by Schmid & Partner Engineering AG (SPEAG) in Zurich, Switzerland.

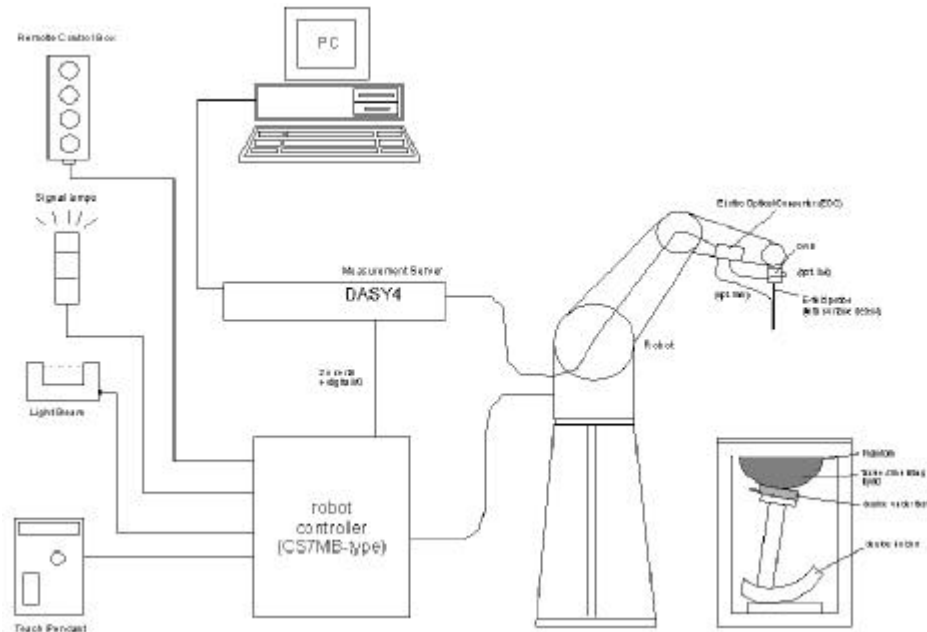

Figure1

The DASY4 system for performing compliance tests consists of the following items:

- A standard high precision 6-axis robot (Stäubli RX family) with controller, teach pendant and software. An arm extension for accommodating the data acquisition electronics (DAE).
- A dosimetric probe, i.e., an isotropic E-field probe optimized and calibrated for usage in tissue simulating liquid. The probe is equipped with an optical surface detector system.
- A data acquisition electronics (DAE) which performs the signal amplification, signal multiplexing, AD-conversion, offset measurements, mechanical surface detection, collision detection, etc. The unit is battery powered with standard or rechargeable batteries. The signal is optically transmitted to the EOC.
- An unit to operate the optical surface detector which is connected to the EOC.
- The Electro-optical converter (EOC) performs the conversion from the optical into a digital electric signal of the DAE. The EOC is connected to the measurement server.
- The functions of the measurement server is to perform the time critical task such as signal filtering, surveillance of the robot operation, fast movement interrupts.
- A probe alignment unit which improves the (absolute) accuracy of the probe positioning.
- A computer operating Windows 2000 or Windows NT.
- DASY4 software.
- Remote control with teach pendant and additional circuitry for robot safety such as warning lamps, etc.
- The SAM twin phantom enabling testing left-hand and right-hand usage.
- The device holder for handheld mobile phones.
- Tissue simulating liquid mixed according to the given recipes (see Application Notes).
- System validation dipoles allowing to validate the proper functioning of the system.

2.5.2 Phantom Description



(figure 2.1)

The SAM twin phantom V4.0 (figure 2.1) is a fiberglass shell phantom with 2 mm shell thickness.

It has three measurement areas:

- Left hand
- Right hand
- Flat phantom

The phantoms are integrated in a wooden table.

The bottom plate of the table contains three pair of bolts for locking the device holder. The device holder positions are adjusted to the standard measurement positions in the three sections. Only one device holder is necessary if two phantoms are used(e.g., for different liquids).

A cover is provided to tap the phantom during off-periods to prevent water evaporation and changes in the liquid parameters. Free space scans of devices on the cover are possible.

On the phantoms top, three reference markers are provided to identify the phantom positions with respect to the robot.



(figure 2.2)

The FLATPHANTOM V4 (figure 2.2) is a phantom for dosimetric evaluations of body mounted usage and system performance check for the frequency up to 3 GHz.

2.5.3 Tissue Simulating Liquids

The parameters of the tissue simulating liquid strongly influence the SAR. The parameters for the different frequencies are defined in the corresponding compliance standards (e.g., EN 50361, IEEE P1528-200X).

Tissue dielectric properties

Frequency (MHz)	Head		Body	
	Relative Dielectric Constant (ϵ_r)	Conductivity (S/m)	Relative Dielectric Constant (ϵ_r)	Conductivity (S/m)
150	52.3	0.76	61.9	0.80
300	45.3	0.87	58.2	0.92
450	43.5	0.87	56.7	0.94
835	41.5	0.90	55.2	0.97
900	41.5	0.97	55.0	1.05
1450	40.5	1.20	54.0	1.30
1800	40.0	1.40	53.3	1.52
1900	40.0	1.40	53.3	1.52
2000	40.0	1.40	53.3	1.52
2450	39.2	1.80	52.7	1.95
3000	38.5	2.40	52.0	2.73

2.5.4 Device Holder

The DASY device holder (figure 3.1) is designed to cope with different positions given in the standard. It has two scales for the device rotation (with respect to the body axis) and the device inclination (with respect to the line between the ear openings). The rotation center for both scales is the ear opening. Thus the device needs no repositioning when changing the angles.



Figure 3.1

The DASY device holder has been made out of low-loss POM material having the following dielectric parameters: relative permittivity $\epsilon_r = 3$ and loss tangent $\tan \delta = 0.02$. The amount of dielectric material has been reduced in the closest vicinity of the device, since measurements have suggested that the influence of the clamp on the results could thus be lowered.

2.5.5 Probes

The SAR measurements were conducted with the dosimetric probe ET3DV6 (figure 4), designed in the classical triangular configuration and optimized for dosimetric evaluation. [3] The probe is constructed using the thick film technique; with printed resistive lines on ceramic substrates. The probe is equipped with an optical multifiber line ending at the front of the probe tip. It is connected to the EOC box on the robot arm and provides an automatic detection of the phantom surface. Half of the fibers are connected to a pulsed infrared transmitter, the other half to a synchronized receiver. As the probe approaches the surface, the reflection from the surface produces a coupling from the transmitting to the receiving fibers. This reflection increases first during the approach, reaches maximum and then decreases. If the probe is flatly touching the surface, the coupling is zero. The distance of the coupling maximum to the surface is independent of the surface reflectivity and largely independent of the surface to probe angle. The DASY4 software reads the reflection during a software approach and looks for the maximum using a 2nd order fitting. The approach is stopped at reaching the maximum.



Figure 4

Probe Specifications

Calibration:	In air from 10 MHz to 2.5 GHz In brain and muscle simulating tissue at Frequencies of 150 MHz, 300 MHz, 450 MHz, 835 MHz, 900 MHz, 1800 MHz, 1900 MHz and 2450 MHz Calibration certificates please find attached.
Frequency:	10 MHz to > 3 GHz; Linearity: ± 0.2 dB (30 MHz to 3 GHz)
Directivity:	± 0.2 dB in HSL (rotation around probe axis) ± 0.4 dB in HSL (rotation normal probe axis)
Dynamic Range:	5 μ W/g to > 100 mW/g;
Linearity:	± 0.2 dB
Dimensions:	Overall length: 330m Tip length: 16mm Body diameter: 12mm Tip diameter: 6.8mm
Application:	Distance from probe tip to dipole centers: 2.7 mm General dosimetry up to 3 GHz Compliance tests of mobile phones Fast automatic scanning in arbitrary phantoms

2.6 Test System Specification

Positioner

Robot: Stäubli Animation Corp. Robot Model: RX90B L
Repeatability: 0.02 mm
No. of axis: 6

Data Acquisition Electronic(DAE) System

Cell Controller

Processor: Pentium IV
Clock Speed: 2.0 GHz
Operating System: Windows 2000
Data Card: DASY4 PC-Board
Data Converter
Features: Signal Amplifier, multiplexer, A/D converter, & control logic
Software: DASY4 software
Connecting Lines: Optical downlink for data and status info.
Optical uplink for commands and clock

PC Interface Card

Function: 24 bit (64 MHz) DSP for real time processing
Link to DAE3
16 bit A/D converter for surface detection system
serial link to robot
direct emergency stop output for robot

E-Field Probes

Model: ET3DV6 / SN1782
Construction: Triangular core fiber optic detection system
Frequency: 10 MHz to 6 GHz
Linearity: ± 0.2 dB (30 MHz to 3 GHz)

Phantom

Phantom: SAM Twin Phantom(V4.0)
Shell Material: Fiberglass
Thickness: 2.0 \pm 0.2 mm

Phantom

Phantom: Flat Phantom (V4.4)
Shell Material: Fiberglass
Thickness: 6 mm \pm 0.2 mm

2.7 Measurement Procedure

The evaluation was performed using the following procedure:

1. The SAR measurement was taken at a selected spatial reference point to monitor power variations during testing. This fixed location point was measured and used as a reference value.
2. The SAR distribution at the exposed side of the head was measured at a distance of 3.9mm from the inner surface of the shell. The area covered the entire dimension of the head and the horizontal grid spacing was 10mm x 10mm.
3. Based on the area scan data, the area of the maximum absorption was determined by spline interpolation. Around this point, a volume of 30mm x 30mm x 30mm (fine resolution volume scan, zoom scan) was assessed by measuring 5 x 5 x 5 points. On this basis of this data set, the spatial peak SAR value was evaluated with the following procedure:
 - a. The data at the surface was extrapolated, since the center of the dipoles is 2.7mm away from the tip of the probe and the distance between the surface and the lowest measuring point is 1.2mm. The extrapolation was based on a least square algorithm [4]. A polynomial of the fourth order was calculated through the points in z-axes. This polynomial was then used to evaluate the points between the surface and the probe tip.
 - b. The maximum interpolated value was searched with a straight-forward algorithm. Around this maximum the SAR values averaged over the spatial volumes (1g or 10g) were computed using the 3D-Spline interpolation algorithm. The 3D-spline is composed of three one-dimensional splines with the "Not a knot" condition (in x, y, and z directions) [4] [5]. The volume was integrated with the trapezoidal algorithm. One thousand points (10 x 10 x 10) were interpolated to calculate the average.
 - c. All neighboring volumes were evaluated until no neighboring volume with a higher average value was found.
4. The SAR reference value, at the same location as procedure #1, was remeasured. If the value changed by more than 5%, the evaluation is repeated.

2.8 Reference Positions for Handheld Radio Transmitters

In general handheld radio transmitters like PMR/SMR devices are used in held to face position or with a speaker/microphone combination as body-worn configuration.

1.8.1 Held to face position

For held to face position the flat section of a SAM Phantom or a flat phantom is used.

The center of the radiating structure is to set on the middle position of the flat phantom. The distance between sample and flat phantom is 2.5 cm, similar to the real using.

For the measurement head tissue simulating liquid is used.

1.8.2 Belt Clip/Holster Configuration

Test configurations for body-worn operated EUTs are carried out while the belt-clip and/or holster is attached to the EUT and placed against a flat phantom in a regular configuration. An EUT with a headset output is tested with a headset connected to the device.

Body dielectric parameters are used.

There are two categories for accessories for body-worn operation configurations:

1. accessories not containing metallic components
2. accessories containing metallic components.

When the EUT is equipped with accessories not containing metallic components the tests are done with the accessory that dictates the closest spacing to the body. For accessories containing metallic parts a test with each one is implemented. If the multiple accessories share an identical metallic component (e.g. the same metallic belt-clip used with different holsters with no other metallic components) only the accessory that has the closest spacing to the body is tested.

In case that a EUT authorized to be body-worn is not supplied or has no options to be operated with any accessories, a test configuration where a separation distance between the back of the device and the flat phantom is used. All test position spacings are documented.

Transmitters operating in front of a person's face (e.g. push-to-talk configurations) are tested for SAR compliance with the front of the device positioned to face the flat platform. SAR Compliance tests for shoulder, waist or chest-worn transmitters are carried out with the accessories including headsets and microphones attached to the device and placed against a flat phantom in a regular configuration.

The SAR measurements are performed to investigate the worst-case positioning. This is documented and used to perform Body SAR testing. [2]. Body tissue simulating liquid is used.

1.9 Measurement uncertainty

The uncertainty budget has been determined for the DASY4 system performance check according to IEEE Str. 1528-200X, (draft), April 2002.

Items	Factors of Uncertainty x_i	Type A/ Type B	Probability Distribution	Standard Uncertainty $u(x_i)$	Coverage Factor(k)
1	Probe calibration	A	normal	4.8%	2
2	Axial isotropy	B	rectangualr	1.9%	2
3	Hemispherical isotropy	B	rectangualr	3.9%	2
4	Boundary effects	B	rectangualr	0.6%	2
5	Linearity	B	rectangualr	2.7%	2
6	System Detection limits	B	rectangualr	0.6%	2
7	Readout Electronics	A	normal	1.0%	2
8	Response time	B	rectangualr	0.5%	2
9	Integration time	B	rectangualr	1.5%	2
10	RF Ambient Conditions	B	rectangualr	1.7%	2
11	Mech. Constrains of robot	B	rectangualr	0.2%	2
12	Probe positioning	B	rectangualr	1.7%	2
13	Extrap. and integration	B	rectangualr	0.6%	2
14	Device positioning	A	normal	2.9%	2
15	Device holder uncertainty	A	normal	3.6%	2
16	Power drift	B	rectangualr	2.9%	2
17	Phantom uncertainty	B	rectangualr	2.3%	2
18	Liquid conductivity(target)	B	rectangualr	1.8%	2
19	Liquid conductivity(meas.)	A	normal	3.2%	2
20	Liquid permittivity(target)	B	rectangualr	1.7%	2
21	Liquid permittivity(meas.)	A	normal	3.0%	2
Combined Standard Uncertainty $u_c(Y)$: 11.0%					
Expanded Uncertainty(95% confidence interval) $U_{exp}=kx u_c(y)$: 22.0%					

3. Tissue and System Verification

3.1 Tissue Verification

Dielectric parameters of the simulating liquids were verified using a Dielectric Probe Kit Agilent 85070D.

Room Temperature: 22.2 - 22.6 °C

	Measured Tissue Parameters	
	300 MHz Head	
	Target	Measured
Date		December 20, 2004
Liquid Temperature: °C		21.8
Dielectric Constant:	45.3	45.49
Conductivity:	0.87	0.878

	Measured Tissue Parameters	
	150 MHz Head	
	Target	Measured
Date		December 20, 2004
Liquid Temperature: °C		21.8
Dielectric Constant:	52.3	52.30
Conductivity:	0.76	0.753

Room Temperature: 21.8 - 22.2 °C

	Measured Tissue Parameters	
	150 MHz Muscle	
	Target	Measured
Date		December 21, 2004
Liquid Temperature: °C		21.9
Dielectric Constant:	61.9	62.21
Conductivity:	0.80	0.803

3.2 System Verification

Prior to the assessment, the system was verified by using a 300 MHz validation dipole. Power level of 250mW was supplied to the dipole antenna placed under the flat section of SAM Phantom.

The system was verified to a tolerance of $\pm 10\%$

Liquid Temperature: 21.8-22.1 °C

Room Temperature: 22.2-22.6 °C

Liquid Depth: 15 cm

System Dipole Validation Target & Measurement					
Date	System Validation Kit:	Liquid	Targeted SAR 1g(mW/g)	Measured SAR 1g(mW/g)	Deviation (%)
DEC 20, 2004	UHAP-10dB	300 MHz Head	3,044	2.768	-7.8

Comment: Please find attached the measurement plots.

4. Test Results

Procedures Used To Establish Test Signal

The EUT was placed into simulated call mode (e.g. AMPS, Cellular CDMA & PCS CDMA modes) using manufacturers test codes. Such test signals offer a consistent means for testing SAR and are recommended for evaluating SAR [2]. The actual transmission is activated through a base station simulator or similar when test modes are not available or inappropriate for testing the EUT.

The EUT is rechargeable battery operated. The battery used for the SAR measurements was completely charged. The device was tested at full power verified by implementing conducted output power measurements. For confirming of the output power it was tested before and after each SAR measurement. The test was repeated if a conducted power deviation of more than 5% occurred.

Mixture Type: 150 MHz Head

Date: December 20, 2004

Liquid Temperature: 21.8-22.1 °C

Room Temperature: 22.2 – 22.6 °C

Frequency			Power Drift dBm	Antenna Pos.	Phantom Section	Test Position -25 mm	SAR (W/kg) 1g	
MHz	Channel	Modulation					Measured SAR values	
							100% Duty Cycle	50% Duty Cycle
136.000	Low	CW	-0.1	Fixed	Flat	Front	0.705	0.353
155.000	Middle	CW	0.1	Fixed	Flat	Front	0.845	0.423
174.000	High	CW	-0.05	Fixed	Flat	Front	0.634	0.317

1. The SAR values found were below the maximum limit of 8.0 w/kg (controlled exposure):
2. The highest face-held SAR value found was 0,423 W/kg (50% duty cycle)
3. The EUT was tested for face-held SAR with a 2.5 cm separation distance between the front of the EUT and the outer surface of the planar phantom.

Mixture Type: 150 MHz Muscle

Date: December 21, 2004

Liquid Temperature: 21.8-22.1 °C

Room Temperature: 22.2 – 22.6 °C

Frequency			Power Drift dBm	Antenna Pos.	Phantom Section	Test Position -10 mm	SAR (W/kg) 1g	
MHz	Channel	Modulation					Measured SAR values	
							100% Duty Cycle	50% Duty Cycle
136.000	Low	CW	-0.03	Fixed	Flat	Battery Side	3.640	1.820
155.000	Middle	CW	0.2	Fixed	Flat	Battery Side	2.470	1.235
174.000	High	CW	-0.04	Fixed	Flat	Battery Side	2.550	1.275

1. The SAR values found were below the maximum limit of 8.0 w/kg (controlled exposure):
2. The highest body-worn SAR value found was 1.820 W/kg (50% duty cycle)
3. The EUT was tested for body-worn SAR with the attached belt-clip providing a 1.0 cm separation distance between the front of the EUT and the outer surface of the planar phantom.

Limits:

Exposure Limits	SAR (W/kg)	
	Uncontrolled Exposure/General Population Environment	Controlled Exposure/Occupational Environment
Spatial Average SAR (averaged over the whole body)	0.08	0.40
Spatial Peak SAR (averaged over any 1g of tissue)	1.60	8.00
Spatial Peak SAR (Hands, Feet, Ankles, Wrist) (averaged over any 10g of tissue)	4.00	20.00

Notes:

1. Test data represent the worst case SAR value and test procedure used are according to OET Bulletin 65, Supplement C (01-01).
2. All Modes of operation were investigated.

5. References

- [1] ANSI/IEEE C95.3 – 1991, IEEE Recommended Practice for the Measurement of Potentially Hazardous Electromagnetic fields, 300 KHz to 100 GHz, New York: IEEE, Aug. 1992.
- [2] Federal Communications Commission, OET Bulletin 65 (Edition 97-01), Supplement C (Edition 01-01), Evaluating Compliance with FCC Guidelines for Human Exposure to Radio frequency Electromagnetic Fields, July 2001.
- [3] T. Schmid, O. Egger, N. Kuster, Automated E-field scanning system for dosimetric assessments, IEEE Transaction on Microwave Theory and Techniques, vol. 44, Jan. 1996, pp. 105-113.
- [4] W. Gander, Computer mathematics, Birkhaeuser, Basel, 1992.
- [5] W.H. Press, S.A Teukolsky, W.T. Vetterling, and B.P. Flannery, Numerical Recipes in C, The Art of Scientific Computing, Second edition, Cambridge University Press, 1992.
- [6] IEEE Standards Coordinating Committee 34 – IEEE Std. 1528-200X (Draft 6.1 – January 2002), Draft Recommended Practice for Determining the Peak Spatial-Average Absorption Rate (SAR in the Human Body Due to Wireless Communications Devices: Experimental Techniques).
- [7] DASY4 Dosimetric Assessment System Manual; Draft; September 6, 2002; Schmid & Partner Engineering AG.

6. Appendix

- | | | | |
|----|------------|-------------------------|------------------------------|
| 1. | Appendix A | Calibration Certificate | - PROBE
- DAE
- DIPOLE |
| 2. | Appendix B | Measurement Plots | |
| 3. | Appendix C | Photographs | |

APPENDIX A

Client **SGS KES (Dymstec)**

CALIBRATION CERTIFICATE

Object(s) **ET3DV6 - SN:1782**
 Calibration procedure(s) **QA CAL-01.v2
 Calibration procedure for dosimetric E-field probes**
 Calibration date: **April 28, 2004**
 Condition of the calibrated item **In Tolerance (according to the specific calibration document)**

This calibration certificate documents the traceability to national standards, which realize the physical units of measurements (SI).
 The measurements and the uncertainties with confidence probability are given on the following pages and are part of the certificate.

All calibrations have been conducted in the closed laboratory facility: environment temperature 22 +/- 2 degrees Celsius and humidity < 75%.

Calibration Equipment used (M&TE critical for calibration)

Model Type	ID #	Cal Date (Calibrated by, Certificate No.)	Scheduled Calibration
Power meter EPM E442	GB37480704	6-Nov-03 (METAS, No. 252-0254)	Nov-04
Power sensor HP B481A	US37292783	6-Nov-03 (METAS, No. 252-0254)	Nov-04
Fluke Process Calibrator Type 702	SN: 6295803	8-Sep-03 (Sintrel SCS No. E-030020)	Sep-04
Power sensor HP B481A	MY41092180	18-Sep-02 (SPEAG, in house check Oct-03)	In house check: Oct 05
RF generator HP 8684C	US3642U01700	4-Aug-99 (SPEAG, in house check Aug-02)	In house check: Aug-05
Network Analyzer HP 8753E	US37390585	18-Oct-01 (SPEAG, in house check Oct-03)	In house check: Oct 05

	Name	Function	Signature
Calibrated by:	Nico Vetterli	Technician	
Approved by:	Katja Pokovic	Laboratory Director	

Date issued: April 28, 2004

This calibration certificate is issued as an intermediate solution until the accreditation process (based on ISO/IEC 17025 International Standard) for
 Calibration Laboratory of Schmid & Partner Engineering AG is completed.

Probe ET3DV6

SN:1782

Manufactured:	April 15, 2003
Last calibrated:	July 28, 2003
Recalibrated:	April 28, 2004

Calibrated for DASY Systems

(Note: non-compatible with DASY2 system!)

DASY - Parameters of Probe: ET3DV6 SN:1782

Sensitivity in Free Space		Diode Compression ^A	
NormX	2.03 $\mu\text{V}/(\text{V}/\text{m})^2$	DCP X	94 mV
NormY	1.72 $\mu\text{V}/(\text{V}/\text{m})^2$	DCP Y	94 mV
NormZ	1.89 $\mu\text{V}/(\text{V}/\text{m})^2$	DCP Z	94 mV

Sensitivity in Tissue Simulating Liquid (Conversion Factors)

Please see Page 7.

Boundary Effect

Head	900 MHz	Typical SAR gradient: 5 % per mm	
	Sensor Center to Phantom Surface Distance	3.7 mm	4.7 mm
	SAR _{be} [%] Without Correction Algorithm	8.0	4.0
	SAR _{be} [%] With Correction Algorithm	0.0	0.1
Head	1800 MHz	Typical SAR gradient: 10 % per mm	
	Sensor Center to Phantom Surface Distance	3.7 mm	4.7 mm
	SAR _{be} [%] Without Correction Algorithm	12.7	8.5
	SAR _{be} [%] With Correction Algorithm	0.2	0.1

Sensor Offset

Probe Tip to Sensor Center	2.7 mm
Optical Surface Detection	in tolerance

The reported uncertainty of measurement is stated as the standard uncertainty of measurement multiplied by the coverage factor $k=2$, which for a normal distribution corresponds to a coverage probability of approximately 95%.

^A numerical linearization parameter, uncertainty not required

Frequency Response of E-Field

(TEM-Cell:ifi110, Waveguide R22)

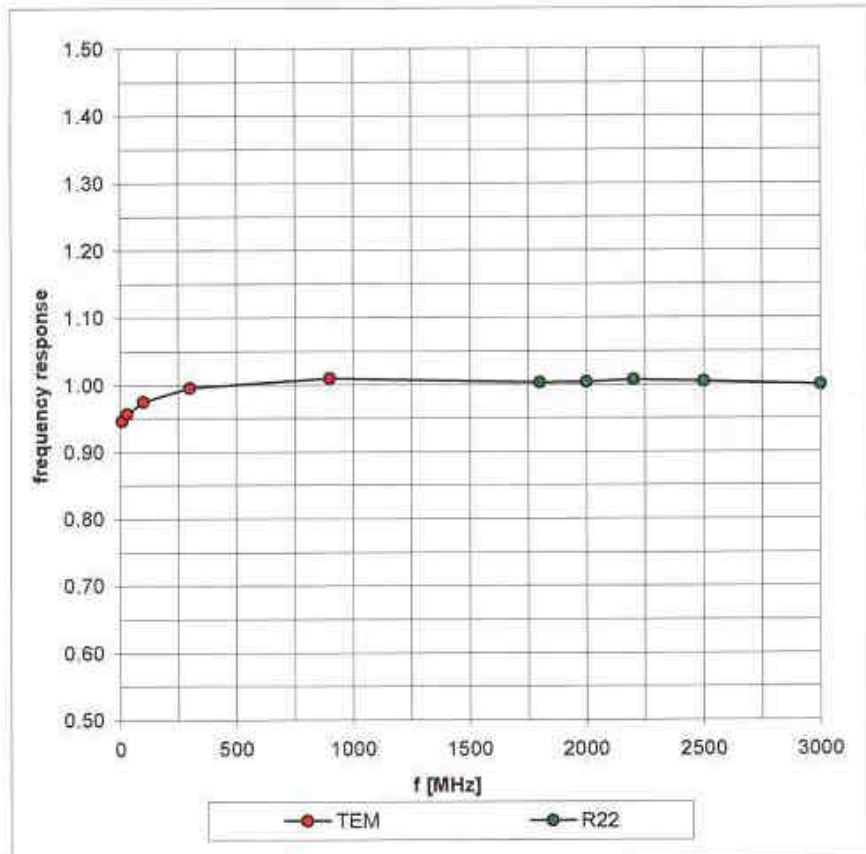

Receiving Pattern (ϕ), $\theta = 0^\circ$

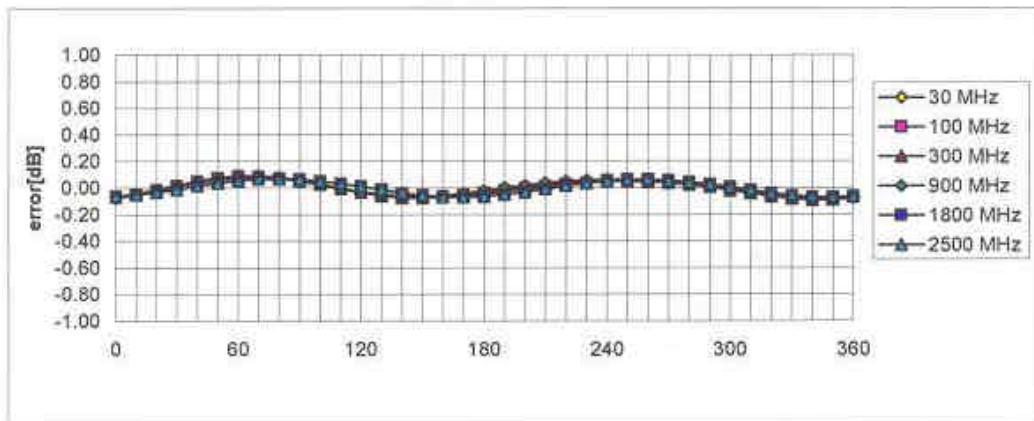
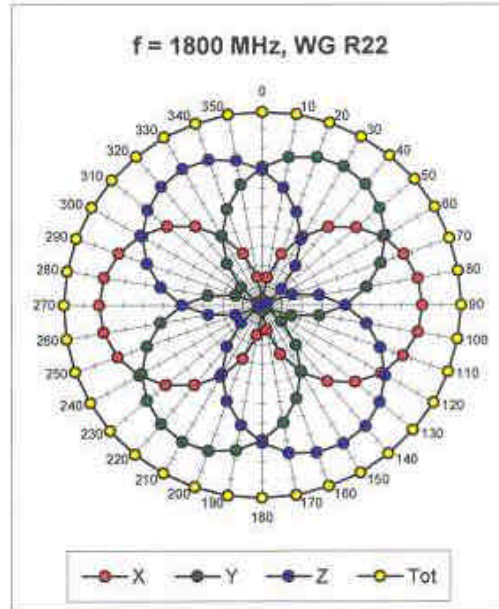
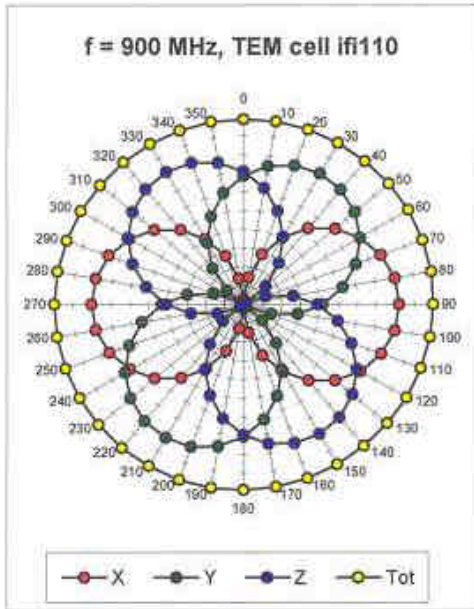

Axial Isotropy Error $\lt; \pm 0.2 \text{ dB}$

Dynamic Range f(SAR_{head}) (Waveguide R22)

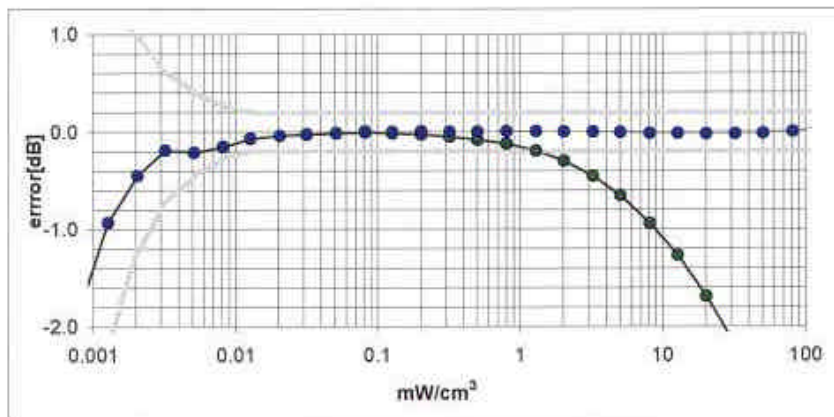
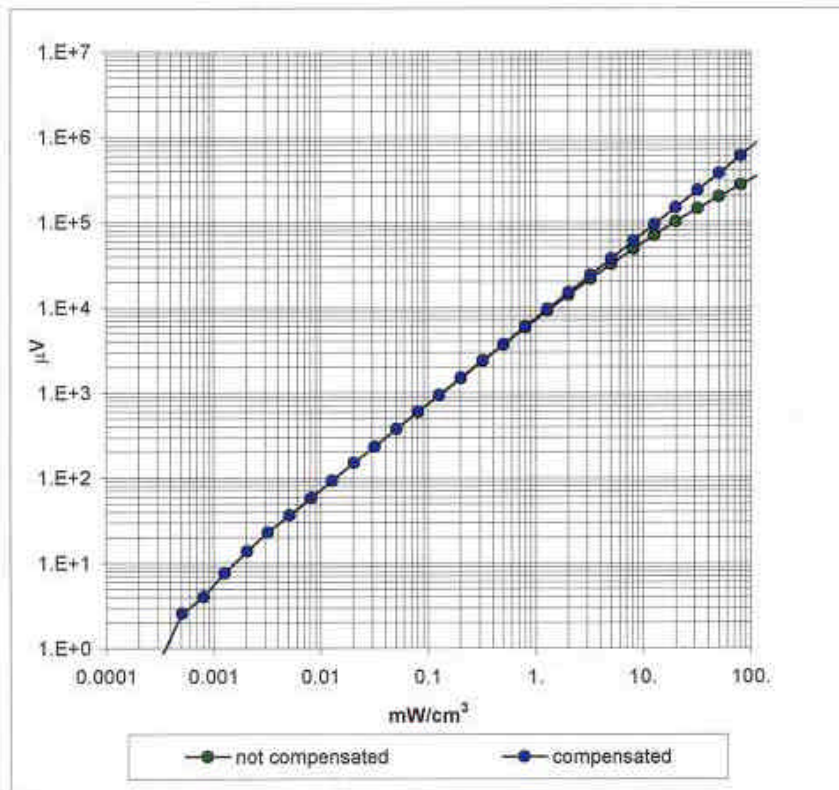

Probe Linearity $\pm 0.2\text{ dB}$

Conversion Factor Assessment

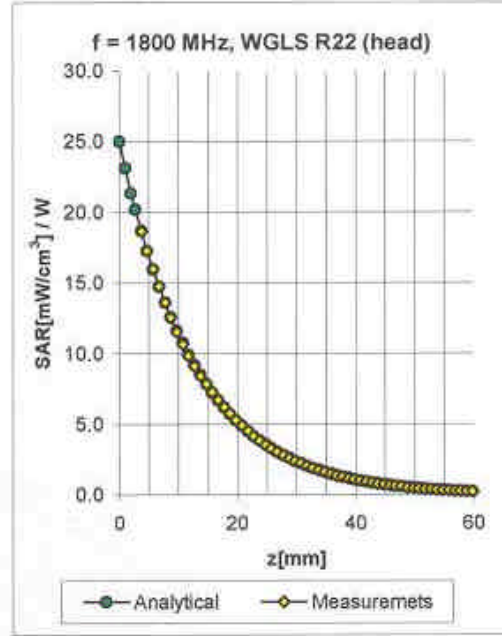
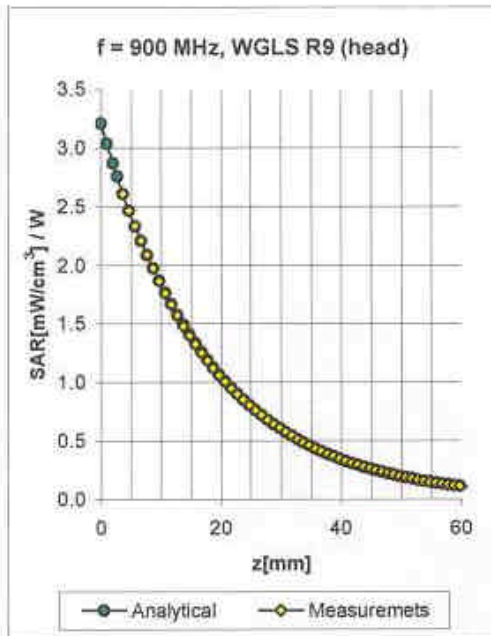

f [MHz]	Validity [MHz] ^B	Tissue	Permittivity	Conductivity	Alpha	Depth	ConvF Uncertainty
900	800-1000	Head	41.5 ± 5%	0.97 ± 5%	0.76	1.59	6.45 ± 11.3% (k=2)
1800	1710-1910	Head	40.0 ± 5%	1.40 ± 5%	0.47	2.62	5.07 ± 11.7% (k=2)
2450	2400-2500	Head	39.2 ± 5%	1.80 ± 5%	0.89	1.98	4.36 ± 9.7% (k=2)
835	785-885	Body	55.2 ± 5%	0.97 ± 5%	0.46	2.19	6.14 ± 9.7% (k=2)
900	850-950	Body	55.0 ± 5%	1.05 ± 5%	0.44	2.31	5.93 ± 9.7% (k=2)
1800	1710-1890	Body	53.3 ± 5%	1.52 ± 5%	0.52	2.80	4.55 ± 10.9% (k=2)
1900	1805-1995	Body	53.3 ± 5%	1.52 ± 5%	0.56	2.86	4.40 ± 11.1% (k=2)
2450	2400-2500	Body	52.7 ± 5%	1.95 ± 5%	1.01	1.71	4.22 ± 9.7% (k=2)

^B The total standard uncertainty is calculated as root-sum-square of standard uncertainty of the Conversion Factor at calibration frequency and the standard uncertainty for the indicated frequency band.

Deviation from Isotropy in HSL

Error (θ, ϕ), $f = 900$ MHz

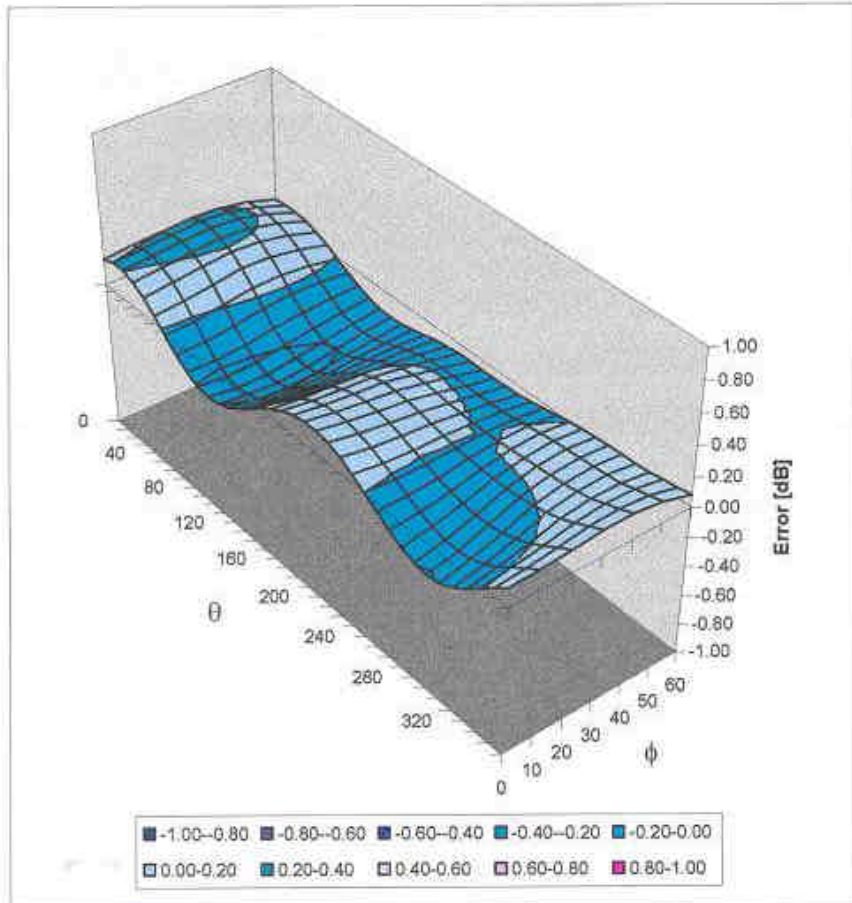

Spherical Isotropy Error $< \pm 0.4$ dB

Additional Conversion Factors for Dosimetric E-Field Probe

Type:	ET3DV6
Serial Number:	1782
Place of Assessment:	Zurich
Date of Assessment:	May 1, 2004
Probe Calibration Date:	April 28, 2004

Schmid & Partner Engineering AG hereby certifies that conversion factor(s) of this probe have been evaluated on the date indicated above. The assessment was performed using the FDTD numerical code SEMCAD of Schmid & Partner Engineering AG. Since the evaluation is coupled with measured conversion factors, it has to be recalculated yearly, i.e., following the re-calibration schedule of the probe. The uncertainty of the numerical assessment is based on the extrapolation from measured value at 900 MHz or at 1800 MHz.

Assessed by:



Dosimetric E-Field Probe ET3DV6 SN:1782

Conversion factor (\pm standard deviation)

450 MHz ConvF $7.6 \pm 8\%$

$\epsilon_r = 43.5 \pm 5\%$
 $\sigma = 0.87 \pm 5\%$ mho/m
(head tissue)

450 MHz ConvF $7.4 \pm 8\%$

$\epsilon_r = 56.7 \pm 5\%$
 $\sigma = 0.94 \pm 5\%$ mho/m
(body tissue)

Important Note:

For numerically assessed probe conversion factors, parameters Alpha and Delta in the DASY software must have the following entries: Alpha = 0 and Delta = 1.

Please see also Section 4.7 of the DASY4 Manual.

Additional Conversion Factors for Dosimetric E-Field Probe

Type:	ET3DV6
Serial Number:	1782
Place of Assessment:	Zurich
Date of Assessment:	May 21, 2004
Probe Calibration Date:	April 28, 2004

Schmid & Partner Engineering AG hereby certifies that conversion factor(s) of this probe have been evaluated on the date indicated above. The assessment was performed using the FDTD numerical code SEMCAD of Schmid & Partner Engineering AG. Since the evaluation is coupled with measured conversion factors, it has to be recalculated yearly, i.e., following the re-calibration schedule of the probe. The uncertainty of the numerical assessment is based on the extrapolation from measured value at 900 MHz or at 1800 MHz.

Assessed by:



Dosimetric E-Field Probe ET3DV6 SN:1782Conversion factor (\pm standard deviation)

75 MHz (65-85 MHz)	ConvF	$8.6 \pm 8\%$	$\epsilon_r = 70.0 \pm 5\%$ $\sigma = 0.70 \pm 5\%$ mho/m (body tissue)
150 MHz (100-200 MHz)	ConvF	$8.9 \pm 8\%$	$\epsilon_r = 52.3 \pm 5\%$ $\sigma = 0.76 \pm 5\%$ mho/m (head tissue)
150 MHz (100-200 MHz)	ConvF	$8.5 \pm 8\%$	$\epsilon_r = 61.9 \pm 5\%$ $\sigma = 0.80 \pm 5\%$ mho/m (body tissue)
1950 MHz (1900-2000 MHz)	ConvF	$4.8 \pm 8\%$	$\epsilon_r = 40.0 \pm 5\%$ $\sigma = 1.40 \pm 5\%$ mho/m (head tissue)

Important Note:

For numerically assessed probe conversion factors, parameters Alpha and Delta in the DASY software must have the following entries: Alpha = 0 and Delta = 1.

Please see also Section 4.7 of the DASY4 Manual.

Additional Conversion Factors for Dosimetric E-Field Probe

Type:

ET3DV6

Serial Number:

1782

Place of Assessment:

Zurich

Date of Assessment:

June 14, 2004

Probe Calibration Date:

April 28, 2004

Schmid & Partner Engineering AG hereby certifies that conversion factor(s) of this probe have been evaluated on the date indicated above. The assessment was performed using the FDTD numerical code SEMCAD of Schmid & Partner Engineering AG. Since the evaluation is coupled with measured conversion factors, it has to be recalculated yearly, i.e., following the re-calibration schedule of the probe. The uncertainty of the numerical assessment is based on the extrapolation from measured value at 900 MHz or at 1800 MHz.

Assessed by:



Dosimetric E-Field Probe ET3DV6 SN:1782

Conversion factor (\pm standard deviation)

300 MHz ConvF 7.4 \pm 8%
 (250-350 MHz)

$\epsilon_r = 58.2 \pm 5\%$ $\sigma = 0.92 \pm 5\%$ mho/m (body tissue)

300 MHz ConvF 7.6 \pm 8%
 (250-350 MHz)

$\epsilon_r = 45.3 \pm 5\%$ $\sigma = 0.87 \pm 5\%$ mho/m (head tissue)

Important Note:

For numerically assessed probe conversion factors, parameters Alpha and Delta in the DASY software must have the following entries: Alpha = 0 and Delta = 1.

Please see also Section 4.7 of the DASY4 Manual.

Client **SGS KES (Dymstec)**

CALIBRATION CERTIFICATE

Object(s) **DAE3 - SD 000 D03 AA - SN: 567**
 Calibration procedure(s) **QA CAL-06.v7**
Calibration procedure for the data acquisition unit (DAE)
 Calibration date: **30.04.2004**
 Condition of the calibrated item **In Tolerance (according to the specific calibration document)**

This calibration statement documents traceability of M&TE used in the calibration procedures and conformity of the procedures with the ISO/IEC 17025 international standard.

All calibrations have been conducted in the closed laboratory facility: environment temperature 22 +/- 2 degrees Celsius and humidity < 75%.

Calibration Equipment used (M&TE critical for calibration)

Model Type	ID #	Cal Date	Scheduled Calibration
Fluke Process Calibrator Type 702	SN: 6295803	8-Sep-03	Sep-04

	Name	Function	Signature
Calibrated by:	Eric Hainfeld	Technician	
Approved by:	Fin Bomhöll	R&D Director	

Date issued: 30.04.2004

This calibration certificate is issued as an intermediate solution until the accreditation process (based on ISO/IEC 17025 International Standard) for Calibration Laboratory of Schmid & Partner Engineering AG is completed.

1. DC Voltage Measurement

A/D - Converter Resolution nominal

High Range: 1LSB = 6.1 μ V, full range = -100...+300 mV
 Low Range: 1LSB = 61nV, full range = -1.....+3mV

DASY measurement parameters: Auto Zero Time: 3 sec; Measuring time: 3 sec

Calibration Factors	X	Y	Z
High Range	404.815	404.585	404.666
Low Range	3.95105	3.95178	3.94236
Connector Angle to be used	in DASY System		83 °

High Range	Input (μ V)	Reading (μ V)	Error (%)
Channel X + Input	200000	200000	0.00
Channel X + Input	20000	19998.36	-0.01
Channel X - Input	20000	-19996.24	-0.02
Channel Y + Input	200000	200000.1	0.00
Channel Y + Input	20000	19997.34	-0.01
Channel Y - Input	20000	-19994.76	-0.03
Channel Z + Input	200000	199999.7	0.00
Channel Z + Input	20000	19995.08	-0.02
Channel Z - Input	20000	-19995.66	-0.02

Low Range	Input (μ V)	Reading (μ V)	Error (%)
Channel X + Input	2000	2000	0.00
Channel X + Input	200	199.41	-0.30
Channel X - Input	200	-200.38	0.19
Channel Y + Input	2000	2000.1	0.00
Channel Y + Input	200	198.84	-0.58
Channel Y - Input	200	-201.23	0.61
Channel Z + Input	2000	2000	0.00
Channel Z + Input	200	199.06	-0.47
Channel Z - Input	200	-201.56	0.78

2. Common mode sensitivity

DASY measurement parameters: Auto Zero Time: 3 sec; Measuring time: 3 sec

	Common mode Input Voltage (mV)	High Range Reading (μ V)	Low Range Reading (μ V)
Channel X	200	2.82	2.30
	-200	-0.12	-0.99
Channel Y	200	0.18	-0.05
	-200	-1.64	-1.75
Channel Z	200	3.51	4.59
	-200	-6.09	-6.64

3. Channel separation

DASY measurement parameters: Auto Zero Time: 3 sec; Measuring time: 3 sec

	Input Voltage (mV)	Channel X (μV)	Channel Y (μV)	Channel Z (μV)
Channel X	200	-	3.51	0.44
Channel Y	200	2.07	-	4.53
Channel Z	200	-0.98	1.54	-

4. AD-Converter Values with inputs shorted

DASY measurement parameters: Auto Zero Time: 3 sec; Measuring time: 3 sec

	High Range (LSB)	Low Range (LSB)
Channel X	16381	16315
Channel Y	16208	16160
Channel Z	15912	15782

5. Input Offset Measurement

DASY measurement parameters: Auto Zero Time: 3 sec; Measuring time: 3 sec

Input 10M Ω

	Average (μV)	min. Offset (μV)	max. Offset (μV)	Std. Deviation (μV)
Channel X	0.36	-0.68	1.66	0.50
Channel Y	-1.49	-2.46	-0.11	0.38
Channel Z	-0.47	-1.74	0.63	0.42

6. Input Offset Current

Nominal Input circuitry offset current on all channels: <25fA

7. Input Resistance

	Zeroing (MOhm)	Measuring (MOhm)
Channel X	0.2001	201.9
Channel Y	0.2001	201.6
Channel Z	0.2000	200.0

8. Low Battery Alarm Voltage

typical values	Alarm Level (VDC)
Supply (+ Vcc)	+7.9
Supply (- Vcc)	-7.6

9. Power Consumption

typical values	Switched off (mA)	Stand by (mA)	Transmitting (mA)
Supply (+ Vcc)	+0.0	+6	+14
Supply (- Vcc)	-0.01	-8	-9

교 정 검 사 성 적 서

CERTIFICATE OF CALIBRATION

① 의뢰기관 Client	(주)에스지에스테스팅코리아		② 교정번호 Certificate No.	D2004-126
③ 측정기 Cal. Item	품 명 Description	Dipole ANTENNA	기기종류 Type of Item	공중선
	제조회사 및 형식 Manufacturer & Model	Schwarzbeck VHAP/UHAP	기기번호 Serial No.	975/958
④ 교정일자 Date of Cal.	2004. 05. 17		⑤ 차기교정일 Recall Date	2005. 05. 17
⑥ 교정환경 Environment	온 도 Temperature	(23±2)℃	습 도 Humidity	55% R.H. 이하
⑦ 교정에 사용한 기준기의 소급성 Calibration Traceability				
•EMI측정기기 교정시스템 1식				
⑧ 교정결과 Calibration Result "교정검사결과" 참조				
⑨ 불확도 Uncertainty "기기명세 및 교정검사결과" 참조				

정보통신기기시험기관의 지정 및 관리 등에 관한 규칙 제 14조의 규정에 의한 전자파 측정설비의 교정검사 결과는 불임과 같습니다.

According to the provision of Article 14 of the Regulations on Designation of Testing Laboratory for Information and Communication Equipment, we certify the calibration results of the EMI equipment above. The results are as following documents.

전파연구소 이천분 
Director, Ichon Branch
Radio Research Laboratory

(주) 이 성적서는 측정기의 정밀정확도에 영향을 미치는 요소(과부하, 온도, 습도 등의 급격한 변화 등)가 발생한 경우에는 무효가 됩니다.

교 정 검 사 결 과

CALIBRATION RESULT

교정번호 : D2004 - 126

(2)페이지중 (2)페이지

Cal . No .

Page of Pages

주파수(MHz)	자유공간손실(dB)	안테나팩타(dB/m)
30	36.76	7.15
40	38.95	9.50
60	43.70	13.63
75	44.63	15.06
90	46.57	16.83
120	50.96	20.27
140	52.58	22.05
180	52.61	22.86
250	56.46	26.21
300	57.54	27.54
400	61.03	30.53
500	63.14	32.56
600	64.59	34.08
800	67.21	36.64
1000	68.82	38.41



이전까지의 측정값 = 10%
 031) 263 - OK

Antenna Factor Table

Company	쎄에스지에스테시스템코리아	Format	Dipole antenna
Model	VHAP/UHAP	Ser NO	975/955
Distance	10M	Tested by	정몽찬
Date	2004-5-17	Weather	Clear
Manufacture	Schwarzbeck		
	VHAP/UHAP-VHAP/UHAP형태로 Ideal Cal일시		
Comment	30, 40 MHz는 1-5.6m Scan 그외의 주파수는 1-4m Scan을 실시하여 자유공간 감쇠량 값을 구함.		

Done - 126

No	Frequency (MHz)	Attenuation (dB)	Gain(ISO) (dBi)	Gain(Dipo) (dBd)	ANT-F (dB/m) (RRL-Meas)	ANT-F (dB/m) (Maker)	Deviation (dB/m)	RRL-RRL	RRL-DUT
1	30	38.78	-7.39	-9.54	7.15	7.45	-0.30	40.47	38.613
2	40	39.95	-7.23	-9.38	9.50	9.95	-0.45	40.99	39.97
3	80	43.70	-7.85	-10.00	13.83	13.50	0.13	43.754	43.726
4	75	44.63	-7.34	-9.49	16.06			45.742	45.184
5	90	46.57	-7.52	-9.67	16.85	17.02	-0.19	47.255	48.611
6	120	50.96	-8.47	-10.62	20.27	19.53	0.74	50.347	50.651
7	150	52.58	-8.31	-10.46	22.06			51.325	51.954
8	180	52.61	-7.53	-9.68	22.88	24.08	-1.22	52.748	62.661
9	250	56.46	-8.03	-10.18	28.21	26.10	0.11	56.792	56.628
10	300	57.54	-7.78	-9.93	27.54	27.35	0.19	57.01	57.274
11	400	61.03	-8.27	-10.42	30.53	29.85	0.58	59.19	60.108
12	500	63.14	-8.38	-10.51	32.56	31.94	0.62	60.53	61.838
13	600	64.59	-8.29	-10.44	34.08	33.72	0.36	63.8	64.194
14	800	67.21	-8.35	-10.50	36.64	36.12	0.52	67.214	67.212
15	1000	68.82	-8.19	-10.34	38.41	38.06	0.35	68.421	68.821

APPENDIX B

Test Laboratory: SGS Testing Korea

AQ-10_Head

DUT: AQ-10; Type: VHF; Serial: none

Communication System: CW; Frequency: 136 MHz; Duty Cycle: 1:1

Medium: H150 Medium parameters used: $f = 136 \text{ MHz}$; $s = 0.743 \text{ mho/m}$; $\epsilon_r = 53.3$; $\rho = 1000$

kg/m^3

Phantom section: Flat Section

DASY4 Configuration:

- Probe: ET3DV6 - SN1782; ConvF(8.9, 8.9, 8.9); Calibrated: 2004-04-28
- Sensor-Surface: 4mm (Mechanical And Optical Surface Detection)
- Electronics: DAE3 Sn567; Calibrated: 2004-04-30
- Phantom: Flat Phantom 4.3; Type: Flat Phantom 4.3; Serial: 1003
- Measurement SW: DASY4, V4.3 Build 16; Postprocessing SW: SEMCAD, V1.8 Build 123

Head_Low/Area Scan (41x151x1): Measurement grid: $dx=20\text{mm}$, $dy=20\text{mm}$

Maximum value of SAR (interpolated) = 0.716 mW/g

Head_Low/Zoom Scan (5x5x7)/Cube 0: Measurement grid: $dx=5\text{mm}$, $dy=5\text{mm}$, $dz=5\text{mm}$

Reference Value = 31.2 V/m ; Power Drift = -0.1 dB

Peak SAR (extrapolated) = 1.06 W/kg

SAR(1 g) = 0.705 mW/g ; SAR(10 g) = n.a.

Warning: Maximum averaged SAR over 10 g is located on the boundary of the measurement cube. This cube might not incorporate the absolute averaged SAR. Please consider a refinement of the Area Scan measurement.

Maximum value of SAR (measured) = 0.737 mW/g

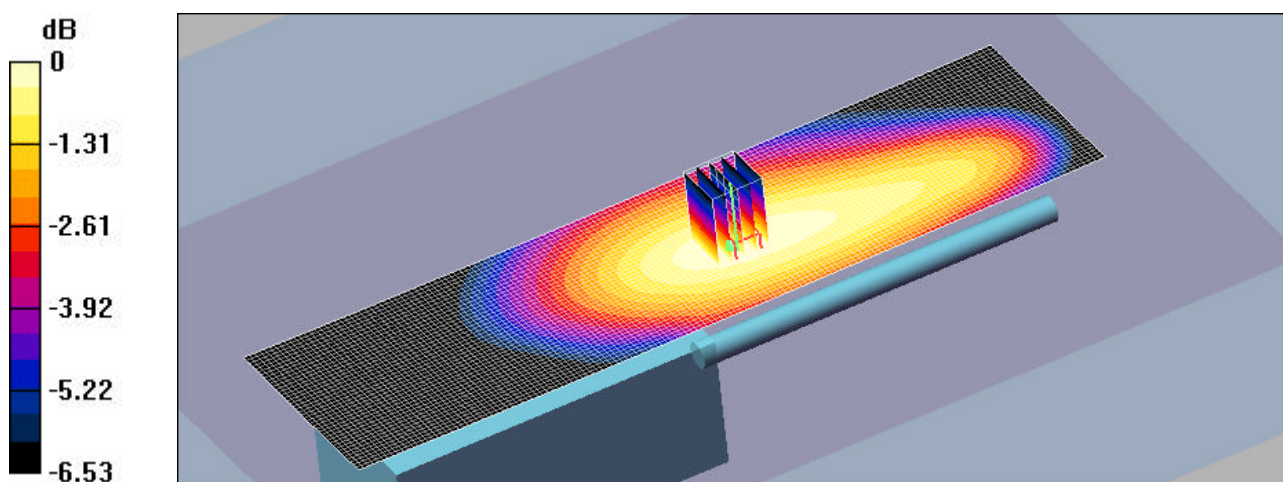

Test Laboratory: SGS Testing Korea

AQ-10_Head

DUT: AQ-10; Type: VHF; Serial: none

Communication System: CW; Frequency: 155 MHz; Duty Cycle: 1:1

Medium: H150 Medium parameters used: $f = 155 \text{ MHz}$; $s = 0.757 \text{ mho/m}$; $\epsilon_r = 51.9$; $\rho = 1000$

kg/m^3

Phantom section: Flat Section

DASY4 Configuration:

- Probe: ET3DV6 - SN1782; ConvF(8.9, 8.9, 8.9); Calibrated: 2004-04-28
- Sensor-Surface: 4mm (Mechanical And Optical Surface Detection)
- Electronics: DAE3 Sn567; Calibrated: 2004-04-30
- Phantom: Flat Phantom 4.3; Type: Flat Phantom 4.3; Serial: 1003
- Measurement SW: DASY4, V4.3 Build 16; Postprocessing SW: SEMCAD, V1.8 Build 123

Head_Mid/Area Scan (41x151x1): Measurement grid: $dx=20\text{mm}$, $dy=20\text{mm}$

Maximum value of SAR (interpolated) = 0.839 mW/g

Head_Mid/Zoom Scan (5x5x7)/Cube 0: Measurement grid: $dx=5\text{mm}$, $dy=5\text{mm}$, $dz=5\text{mm}$

Reference Value = 30.3 V/m ; Power Drift = 0.1 dB

Peak SAR (extrapolated) = 1.91 W/kg

SAR(1 g) = 0.845 mW/g ; SAR(10 g) = n.a.

Warning: Maximum averaged SAR over 10 g is located on the boundary of the measurement cube. This cube might not incorporate the absolute averaged SAR. Please consider a refinement of the Area Scan measurement.

Maximum value of SAR (measured) = 0.867 mW/g

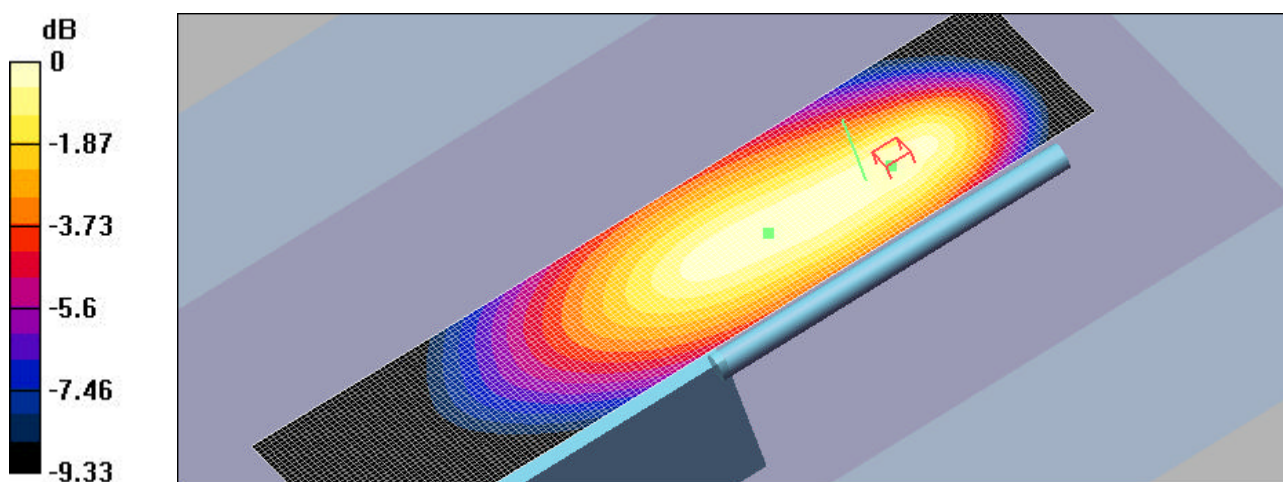

0 dB = 0.867 mW/g

Test Laboratory: SGS Testing Korea

AQ-10_Head

DUT: AQ-10; Type: VHF; Serial: none

Communication System: CW; Frequency: 174 MHz; Duty Cycle: 1:1

Medium: H150 Medium parameters used: $f = 174$ MHz; $s = 0.772$ mho/m; $\epsilon_r = 50.6$; $\rho = 1000$

kg/m³

Phantom section: Flat Section

DASY4 Configuration:

- Probe: ET3DV6 - SN1782; ConvF(8.9, 8.9, 8.9); Calibrated: 2004-04-28
- Sensor-Surface: 4mm (Mechanical And Optical Surface Detection)
- Electronics: DAE3 Sn567; Calibrated: 2004-04-30
- Phantom: Flat Phantom 4.3; Type: Flat Phantom 4.3; Serial: 1003
- Measurement SW: DASY4, V4.3 Build 16; Postprocessing SW: SEMCAD, V1.8 Build 123

Head_High/Area Scan (41x151x1): Measurement grid: dx=20mm, dy=20mm

Maximum value of SAR (interpolated) = 0.755 mW/g

Head_High/Zoom Scan (5x5x7)/Cube 0: Measurement grid: dx=5mm, dy=5mm, dz=5mm

Reference Value = 28.5 V/m; Power Drift = -0.05 dB

Peak SAR (extrapolated) = 1.532 W/kg

SAR(1 g) = 0.634 mW/g; SAR(10 g) = n.a.

Warning: Maximum averaged SAR over 10 g is located on the boundary of the measurement cube. This cube might not incorporate the absolute averaged SAR. Please consider a refinement of the Area Scan measurement.

Maximum value of SAR (measured) = 0.649 mW/g

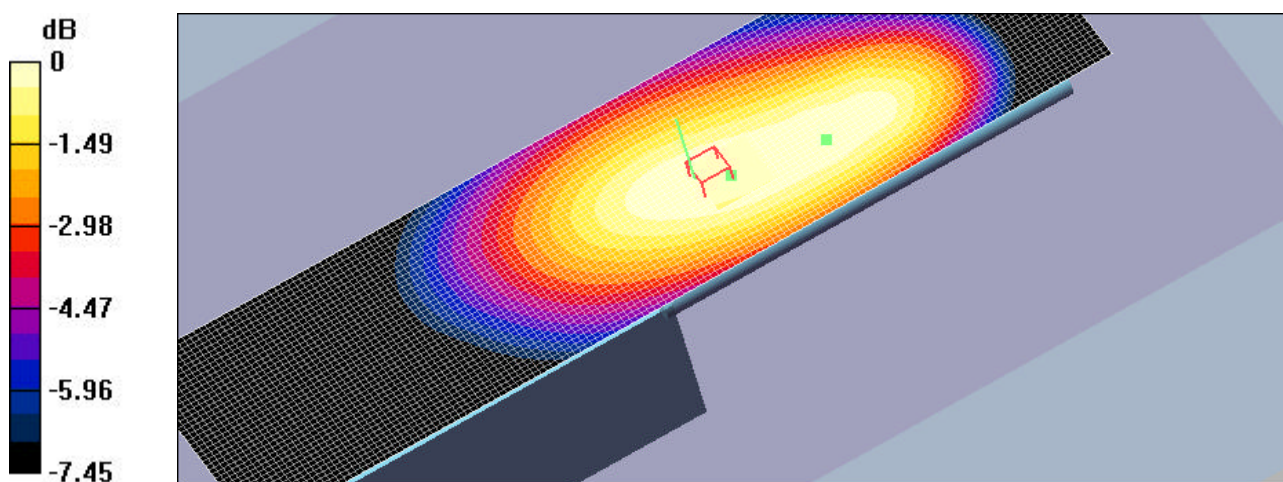

Test Laboratory: SGS Testing Korea

AQ-10_Body

DUT: AQ-10; Type: VHF; Serial: none

Communication System: CW; Frequency: 136 MHz; Duty Cycle: 1:1

Medium: M150 Medium parameters used: $f = 136$ MHz; $s = 0.794$ mho/m; $\epsilon_r = 62.7$; $\rho = 1000$

kg/m³

Phantom section: Flat Section

DASY4 Configuration:

- Probe: ET3DV6 - SN1782; ConvF(8.5, 8.5, 8.5); Calibrated: 2004-04-28
- Sensor-Surface: 4mm (Mechanical And Optical Surface Detection)
- Electronics: DAE3 Sn567; Calibrated: 2004-04-30
- Phantom: Flat Phantom 4.3; Type: Flat Phantom 4.3; Serial: 1003
- Measurement SW: DASY4, V4.3 Build 16; Postprocessing SW: SEMCAD, V1.8 Build 123

Body_Low/Area Scan (41x141x1): Measurement grid: dx=20mm, dy=20mm

Maximum value of SAR (interpolated) = 3.82 mW/g

Body_Low/Zoom Scan (5x5x7)/Cube 0: Measurement grid: dx=5mm, dy=5mm, dz=5mm

Reference Value = 57.2 V/m; Power Drift = -0.03 dB

Peak SAR (extrapolated) = 9.5 W/kg

SAR(1 g) = 3.64 mW/g; SAR(10 g) = n.a.

Warning: Maximum averaged SAR over 10 g is located on the boundary of the measurement cube. This cube might not incorporate the absolute averaged SAR. Please consider a refinement of the Area Scan measurement.

Maximum value of SAR (measured) = 3.69 mW/g

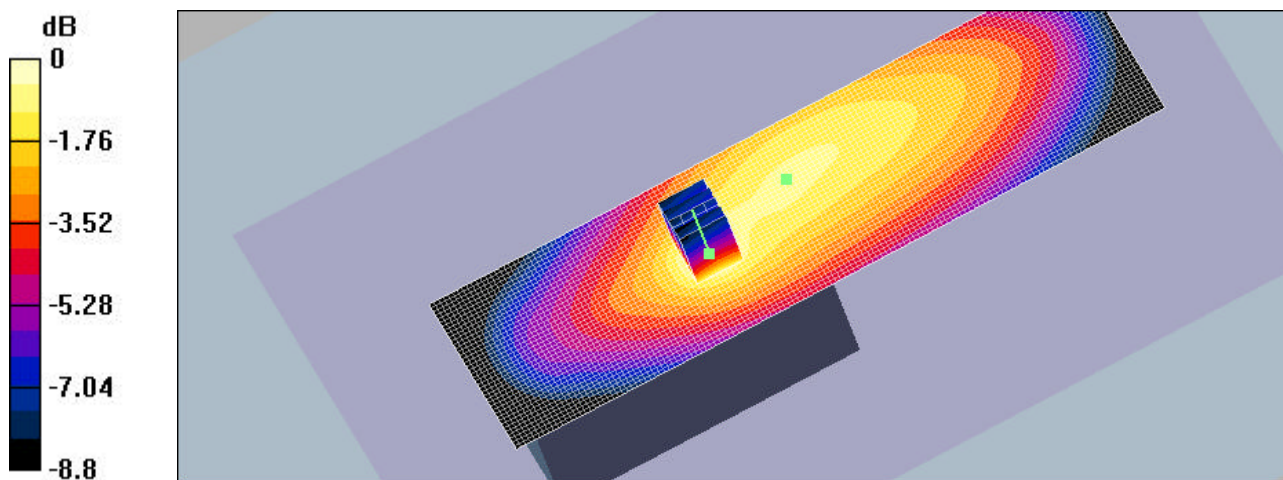

0 dB = 3.69mW/g

Test Laboratory: SGS Testing Korea

AQ-10_Body

DUT: AQ-10; Type: VHF; Serial: none

Communication System: CW; Frequency: 155 MHz; Duty Cycle: 1:1

Medium: M150 Medium parameters used: $f = 155 \text{ MHz}$; $s = 0.806 \text{ mho/m}$; $\epsilon_r = 62$; $\rho = 1000$

kg/m^3

Phantom section: Flat Section

DASY4 Configuration:

- Probe: ET3DV6 - SN1782; ConvF(8.5, 8.5, 8.5); Calibrated: 2004-04-28
- Sensor-Surface: 4mm (Mechanical And Optical Surface Detection)
- Electronics: DAE3 Sn567; Calibrated: 2004-04-30
- Phantom: Flat Phantom 4.3; Type: Flat Phantom 4.3; Serial: 1003
- Measurement SW: DASY4, V4.3 Build 16; Postprocessing SW: SEMCAD, V1.8 Build 123

Body_Mid/Area Scan (41x141x1): Measurement grid: $dx=20\text{mm}$, $dy=20\text{mm}$

Maximum value of SAR (interpolated) = 2.59 mW/g

Body_Mid/Zoom Scan (5x5x7)/Cube 0: Measurement grid: $dx=5\text{mm}$, $dy=5\text{mm}$, $dz=5\text{mm}$

Reference Value = 38.8 V/m; Power Drift = 0.2 dB

Peak SAR (extrapolated) = 6.46 W/kg

SAR(1 g) = 2.47 mW/g; SAR(10 g) = n.a.

Warning: Maximum averaged SAR over 10 g is located on the boundary of the measurement cube. This cube might not incorporate the absolute averaged SAR. Please consider a refinement of the Area Scan measurement.

Maximum value of SAR (measured) = 2.51 mW/g

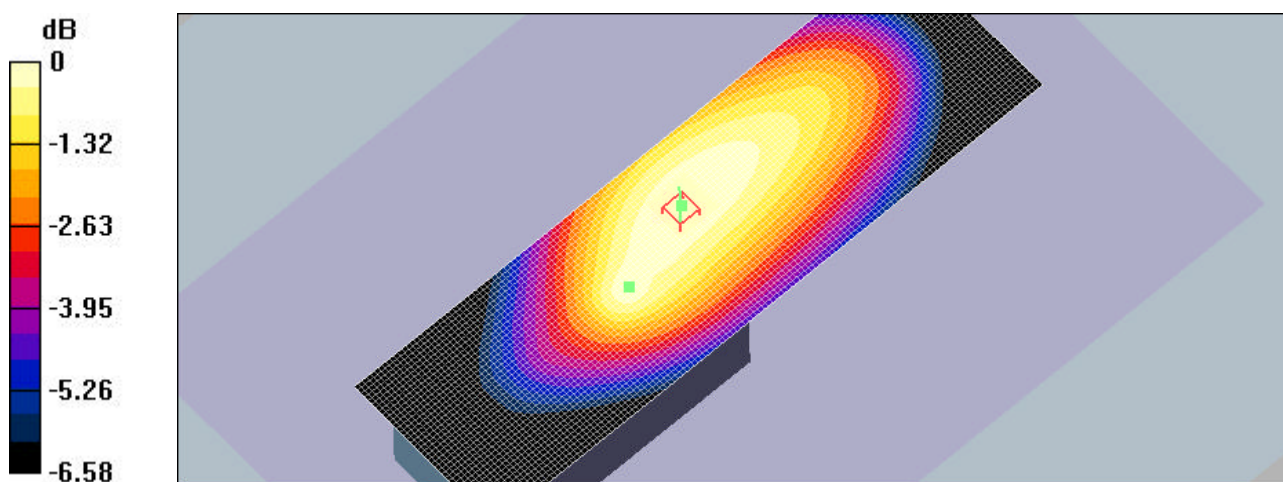

0 dB = 2.51mW/g

Test Laboratory: SGS Testing Korea

AQ-10_Body

DUT: AQ-10; Type: VHF; Serial: none

Communication System: CW; Frequency: 174 MHz; Duty Cycle: 1:1

Medium: M150 Medium parameters used: $f = 174 \text{ MHz}$; $s = 0.819 \text{ mho/m}$; $\epsilon_r = 61.5$; $\rho = 1000$

kg/m^3

Phantom section: Flat Section

DASY4 Configuration:

- Probe: ET3DV6 - SN1782; ConvF(8.5, 8.5, 8.5); Calibrated: 2004-04-28
- Sensor-Surface: 4mm (Mechanical And Optical Surface Detection)
- Electronics: DAE3 Sn567; Calibrated: 2004-04-30
- Phantom: Flat Phantom 4.3; Type: Flat Phantom 4.3; Serial: 1003
- Measurement SW: DASY4, V4.3 Build 16; Postprocessing SW: SEMCAD, V1.8 Build 123

Body_High/Area Scan (41x141x1): Measurement grid: $dx=20\text{mm}$, $dy=20\text{mm}$

Maximum value of SAR (interpolated) = 2.674 mW/g

Body_High/Zoom Scan (5x5x7)/Cube 0: Measurement grid: $dx=5\text{mm}$, $dy=5\text{mm}$, $dz=5\text{mm}$

Reference Value = 41.2 V/m; Power Drift = -0.04 dB

Peak SAR (extrapolated) = 7.12 W/kg

SAR(1 g) = 2.55 mW/g; SAR(10 g) = n.a.

Warning: Maximum averaged SAR over 10 g is located on the boundary of the measurement cube. This cube might not incorporate the absolute averaged SAR. Please consider a refinement of the Area Scan measurement.

Maximum value of SAR (measured) = 2.58 mW/g

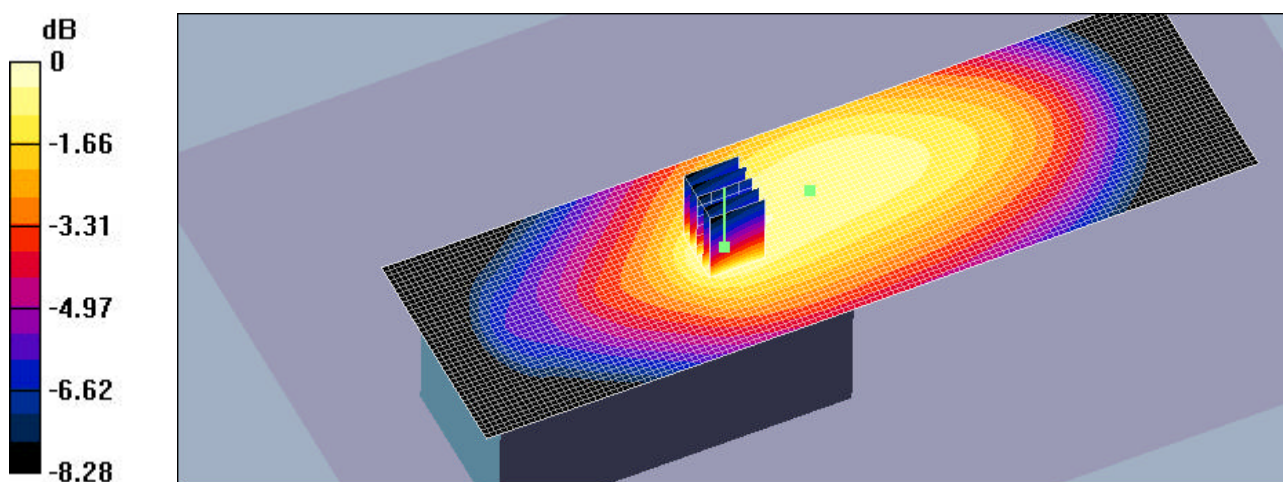

Test Laboratory: SGS Testing Korea

Validation_VHF

DUT: Dipole 300 MHz; Type: UHAP-10dB; Serial: 958

Communication System: CW; Frequency: 300 MHz; Duty Cycle: 1:1

Medium: H300 Medium parameters used: $f = 300 \text{ MHz}$; $s = 0.878 \text{ mho/m}$; $\epsilon_r = 45.49$; $\rho = 1000$

kg/m^3

Phantom section: Flat Section

DASY4 Configuration:

- Probe: ET3DV6 - SN1782; ConvF(7.4, 7.4, 7.4); Calibrated: 2004-04-28
- Sensor-Surface: 4mm (Mechanical And Optical Surface Detection)
- Electronics: DAE3 Sn567; Calibrated: 2004-04-30
- Phantom: Flat Phantom 4.3; Type: Flat Phantom 4.3; Serial: 1003
- Measurement SW: DASY4, V4.3 Build 16; Postprocessing SW: SEMCAD, V1.8 Build 123

Validation 300MHz/Area Scan (61x241x1): Measurement grid: $dx=15\text{mm}$, $dy=15\text{mm}$
Maximum value of SAR (interpolated) = 0.705 mW/g

Validation 300MHz/Zoom Scan (7x7x7)/Cube 0: Measurement grid: $dx=5\text{mm}$, $dy=5\text{mm}$,
 $dz=5\text{mm}$

Reference Value = 26.7 V/m; Power Drift = -0.001 dB

Peak SAR (extrapolated) = 1.232 W/kg

SAR(1 g) = 0.702 mW/g; SAR(10 g) = 0.387 mW/g

Maximum value of SAR (measured) = 0.754 mW/g

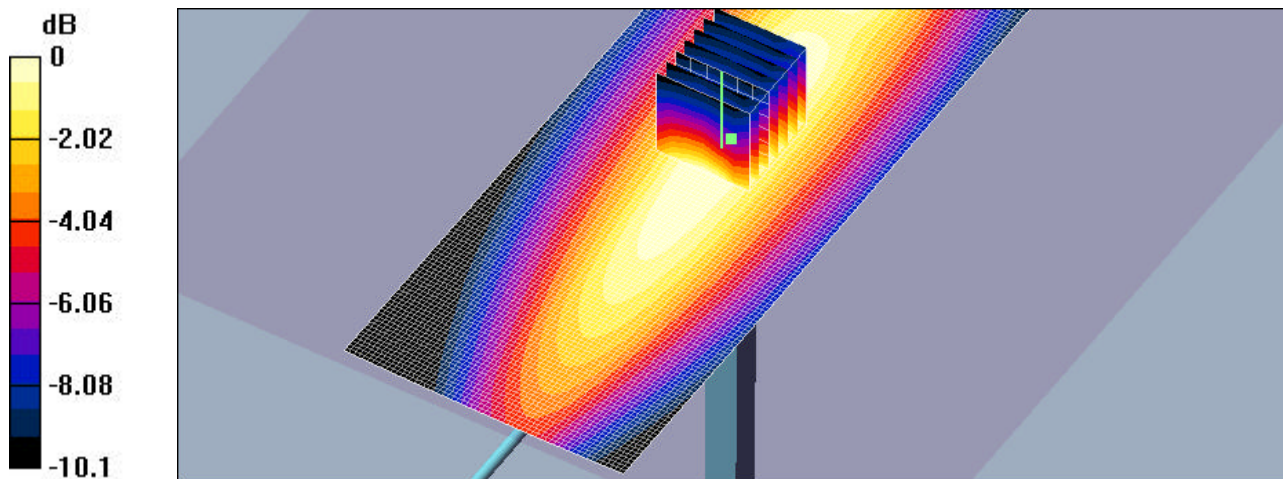

APPENDIX C

SAR System in SGS Testing Korea

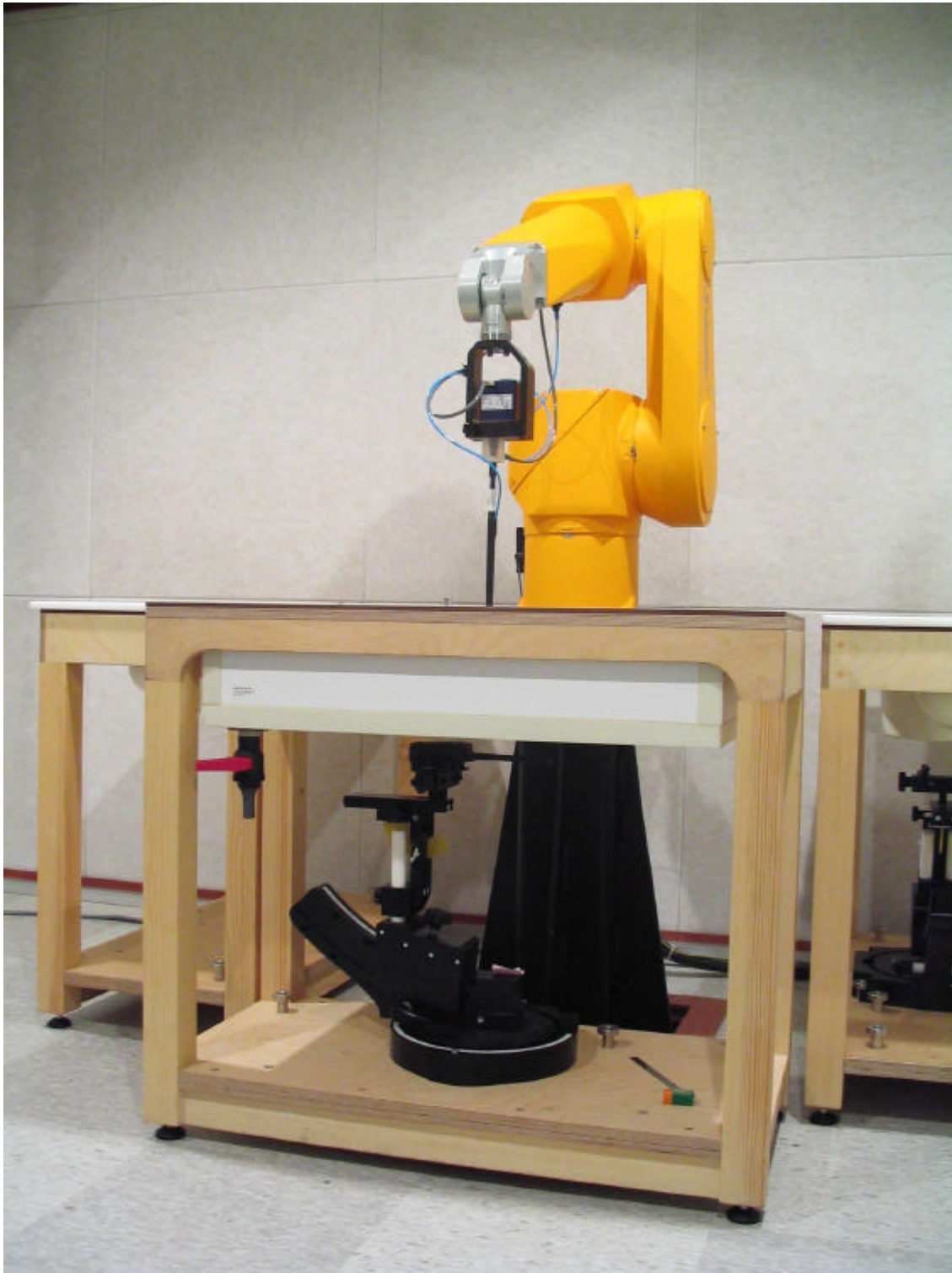

SGS Testing Korea Co., Ltd.

18 - 34, Sanbon - dong, Gunpo - si, Gyeonggi - do, Korea, 435 - 041

Tel. +82 31 428 5700 / Fax. +82 31 427 2371

<http://www.sgstesting.co.kr>

EUT



Front Side



Reverse Side

SGS Testing Korea Co., Ltd.

18 - 34, Sanbon - dong, Gunpo - si, Gyeonggi - do, Korea, 435 - 041

Tel. +82 31 428 5700 / Fax. +82 31 427 2371

<http://www.sgstesting.co.kr>

EUT



Right Side



Left Side

EUT



Top Side



Bottom Side

SGS Testing Korea Co., Ltd.

18 - 34, Sanbon - dong, Gunpo - si, Gyeonggi - do, Korea, 435 - 041

Tel. +82 31 428 5700 / Fax. +82 31 427 2371

<http://www.sgstesting.co.kr>

Head SAR Test

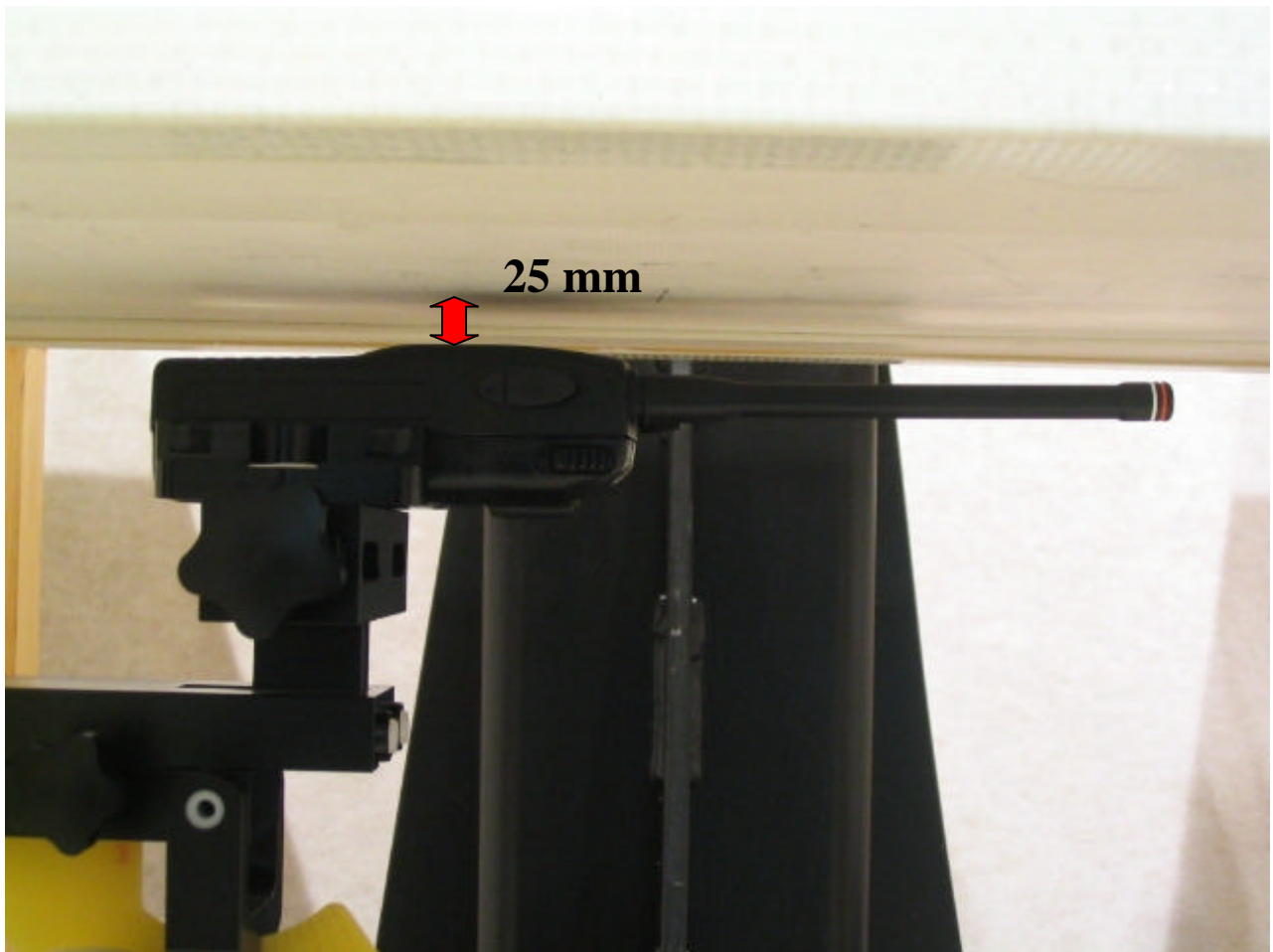

Body SAR Test

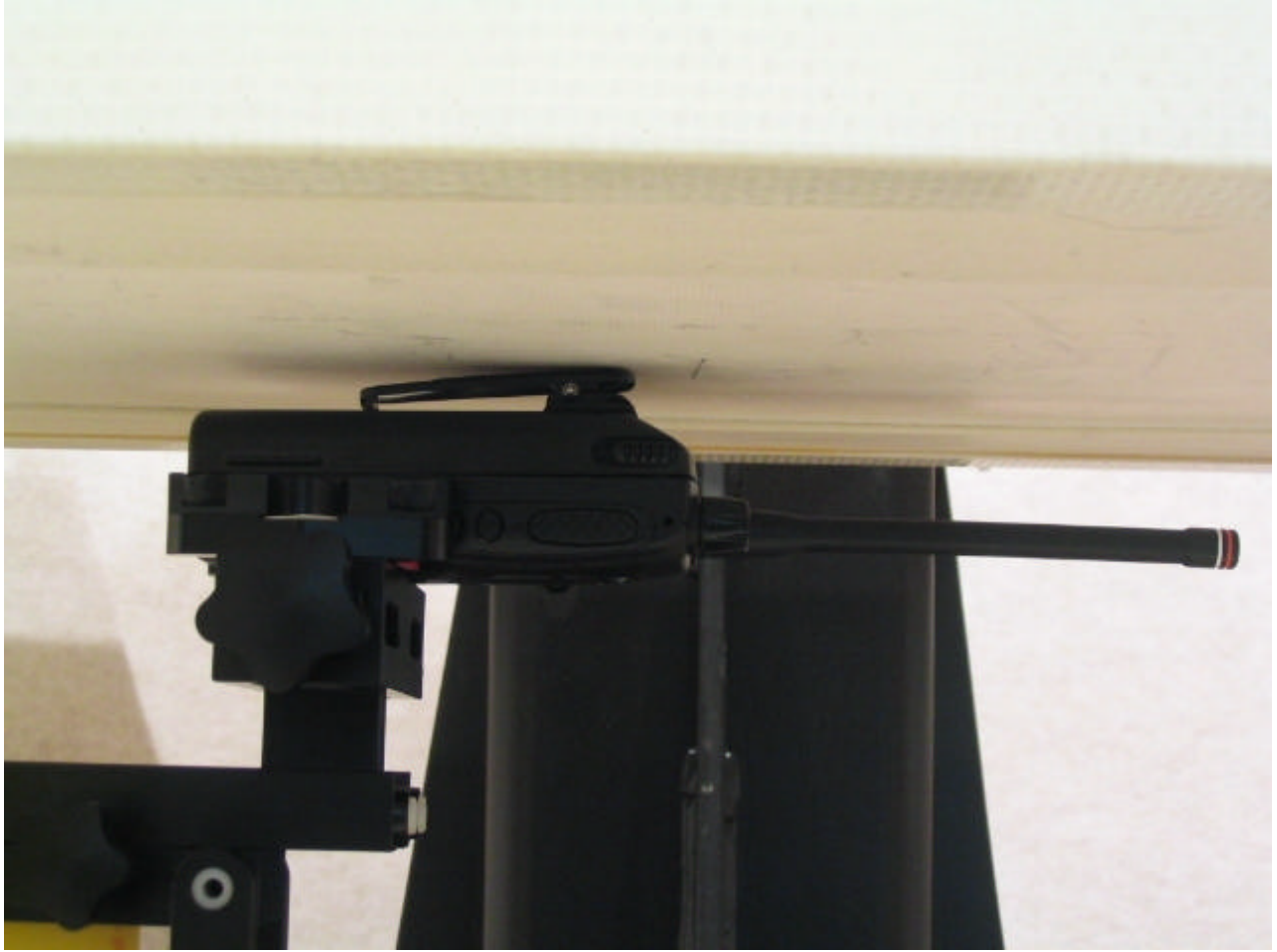

Validation Test



SGS Testing Korea Co., Ltd.

18 - 34, Sanbon - dong, Gunpo - si, Gyeonggi - do, Korea, 435 - 041

Tel. +82 31 428 5700 / Fax. +82 31 427 2371

<http://www.sgstesting.co.kr>

Head Simulated Liquid Temperature



Body Simulated Liquid Temperature

