

TELE RADIO

INDUSTRIAL RADIO REMOTE CONTROLS

PANTHER

Installation instructions



PN-RX-MNB5 (PN-R15-1), PN-RX-MDB11 (PN-R15-2), PN-RX-MNA5 (PN-R15-7),
PN-RX-MDA11 (PN-R15-8), PN-TX-MX8B (PN-T19-2)

Language: English (original)

CONTENTS

Chapter 1: CUSTOMER INFORMATION	1
Chapter 2: FUNCTIONAL SAFETY	3
Chapter 3: PRODUCT PAGES	5
PN-RX-MNB5, PN-RX-MNA5 Base board receiver	5
PN-RX-MDBI I, PN-RX-MDAI I Base board receiver with a Relay expansion board	8
PN-TX-MX8B Transmitter	13
Chapter 4: INSTALLERS GUIDE	17
Default radio mode	17
Switch radio mode in the transmitter	17
Start the transmitter	18
Start the transmitter in menu mode	18
Register the transmitter in the receiver	19
Erase all transmitters from the receiver	21
Turn the transmitter off	21
Replace	21
Frequencies and channels	23
Automatic shutdown	25
Logout	26
Relay functionality	27
Chapter 5: OPERATING MODES	28
Chapter 6: LOAD SELECT MODES	34
Chapter 7: BATTERY GUIDE	38
Chapter 8: CERTIFICATIONS CHAPTER	41

CHAPTER 1: CUSTOMER INFORMATION

THANK YOU FOR PURCHASING A TELE RADIO AB PRODUCT

READ ALL INSTRUCTIONS AND WARNINGS CAREFULLY BEFORE MOUNTING, INSTALLING AND CONFIGURATING THE PRODUCTS.

These instructions are published by Tele Radio AB without any guarantee. The instructions may be removed or revised by Tele Radio AB at any time and without further notice. Corrections and additions will be added to the latest version of the instruction.

IMPORTANT! These instructions are directed to installers. There are separate instructions directed towards end users. The instructions that contain information on the installation and configuration of the radio remote control unit on the machine are not intended to be passed on to the end user. Only such information may be passed on to the end user that is needed to operate the machine correctly by radio remote control.

Tele Radio AB products are covered by a guarantee/ warranty against material, construction or manufacturing faults. During the guarantee/ warranty period, Tele Radio AB may replace the product or faulty parts with new. Work under guarantee/ warranty must be carried out by Tele Radio AB or by an authorized service center specified by Tele Radio AB. Contact your Tele Radio AB representative if you need support or service.

©Tele Radio AB
Datavägen 21
SE-436 36 ASKIM
SWEDEN
Tel: +46-31-748 54 60
Fax: +46-31-68 54 64
www.tele-radio.com

WARNINGS & RESTRICTIONS

WARNING! Tele Radio remote controls are often built into wider applications. We recommend that the system is provided with a wired emergency stop where necessary.

NOTE! We recommend that the functionality of the stop button is being tested at a regular basis: At a minimum, when used for 200 hours. Test the stop button by pressing it and pulling it out.

INSTALLING, CONNECTING AND MOUNTING

- Allow only licensed or qualified personnel to install the product.
- Switch the power supply off to the receiver before connecting the equipment.
- Check that you have connected the power supply to the correct connection terminal.
- To utilize the safety of the system, use the stop relays in the safety circuitry of the object that you want to control.
- Use undamaged cables. No cables should hang loose.
- Avoid installing in areas affected by strong vibrations.
- Place the receiver well away from wind, damp and water.
- Cable glands and vent plugs must face down to prevent water from seeping in.

THE USER

- Make sure that the user is following the instructions.
- Make sure that the user has reached the certified age of your country to operate the equipment.
- Make sure that the user is not under the influence of drugs, alcohol and medicines.
- Allow only qualified personnel to have access to the transmitter and operate the equipment.
- Make sure that the user does not leave the transmitter unsupervised.
- Make sure that the user always turns the transmitter off when not in use.
- Make sure that the user keeps a good overview of the work area.

MAINTENANCE

- Use the stop button to start and turn off the transmitter as often as possible.
- When error messages are shown, it is very important to find out what caused them.
- If the stop button is mechanically damaged, contact your representative for service immediately.
- Always contact your representative for service and maintenance work on the product.
- Write down the serial numbers/ ID codes of the receivers and transmitters used. This information should be recorded on the “Settings document” for your product (download from our web-site).
- Avoid registering transmitters to receivers where it is not being used.
- Keep the safety instruction for future reference. Always download the configurations instruction from our web site for the latest version available.

CHAPTER 2: FUNCTIONAL SAFETY

FUNCTIONAL SAFETY

Safety function

The safety-related stop function in the radio system complies with EN 13849-1:2008 Category 3 PL d. The stop relays on the receiver unit are controlled by the stop button on the transmitter unit. When the stop button is pressed, the stop relays break the power to the safety-related application. The complete end-user system, including the radio system, enters a safe state. The maximum response time for the safety-related stop function is 500ms.

Applicable products

The following transmitter and receiver units are prepared to comply with the appointed safety requirements:

PN-RX-MNB5 (PN-R15-1)
PN-RX-MDB11 (PN-R15-2)
PN-RX-MNA5 (PN-R15-7)
PN-RX-MDA11 (PN-R15-8)
PN-TX-MX8B (PN-T19-2)

NOTE! Both the receiver and the transmitter used in the specific end-user system must be compliant.

Installation

The stop relays on the receiver unit shall be correctly installed on the end-user system, so that opened/deactivated stop relays break the power to the safety-related application. The safety level of the stop function can only be credited when used in a complete end-user system which complies with EN 13849-1:2008 Category 3 PL d.

Configuration

The default configuration of the receiver unit complies with the appointed safety requirements. Any re-configuration that oversteps the safety requirements will be indicated by a LED on the main board of the receiver unit. Before commissioning the radio system, the installer must check the LED indication.

Function LED	Status	Indicates
PL d status LED (red)	ON	Not compliant with PL d
	OFF	Compliant with PL d

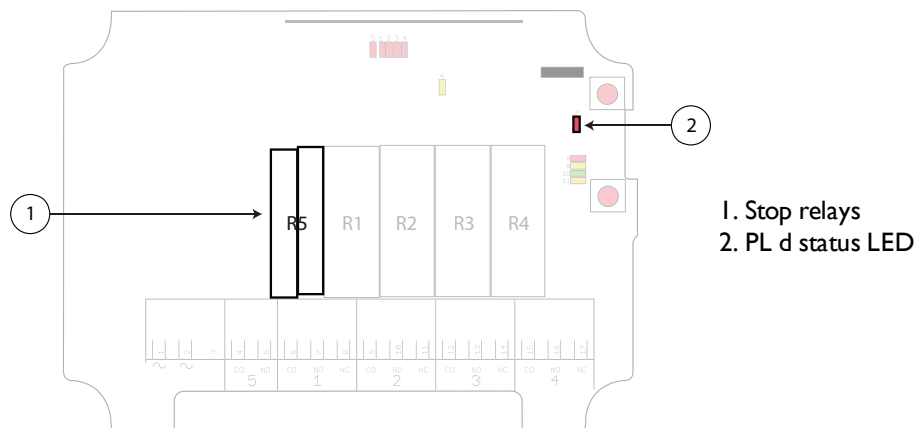

WARNING!

All safety related parameters shall be configured in the following way in order to comply with the appointed safety requirements:

- The system shall be configured in continuous radio mode
- All relays shall be switched off when the radio link is down
- The radio link timeout shall be set to maximum 500ms
- The login/logout function shall be activated
- Custom ID setting shall be deactivated, i.e. the receiver shall always use the unique transmitter ID code

CHAPTER 3: PRODUCT PAGES

PN-RX-MNB5, PN-RX-MNA5 BASE BOARD RECEIVER

WARNING! The receiver must NOT be opened by any other than a qualified installer. Make sure to turn the electricity off before opening the receiver.

Base board:

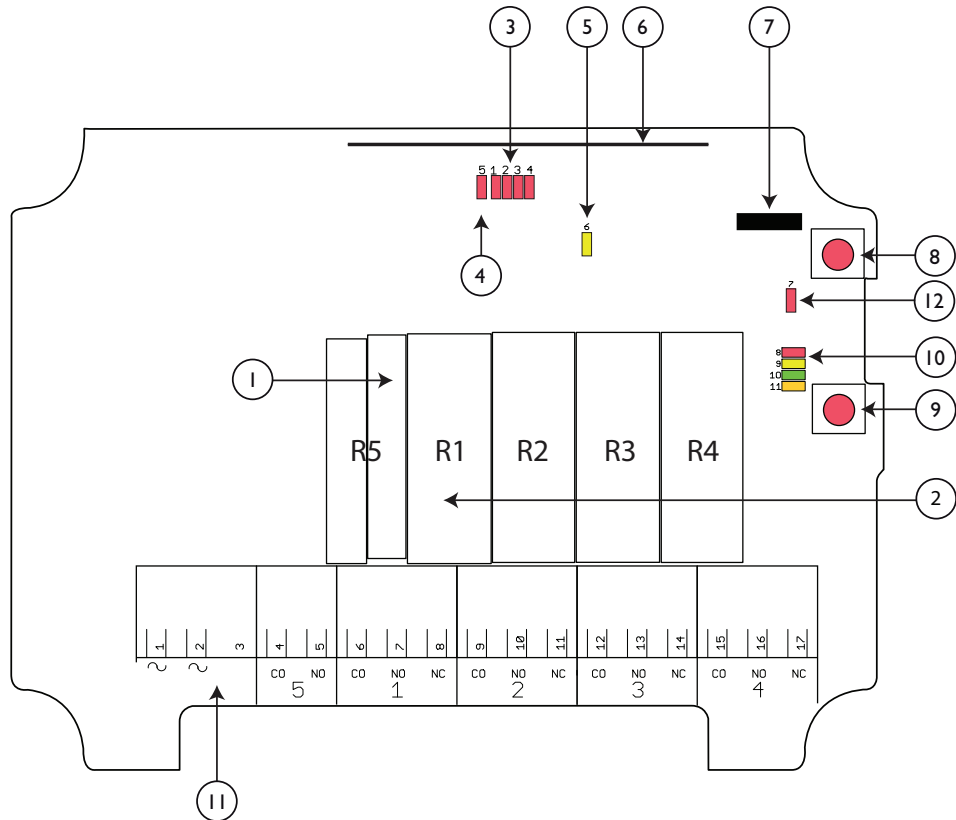



1. Stop relays 5	7. Programming connector
2. Function relays 1-4	8. Function button (Cancel)
3. Function relay LEDs 1-4 (red)	9. Select button (OK)
4. Stop relay LED (red)	10. Function LEDs (8=red, 9=yellow, 10=green, 11=orange)
5. Power LED (yellow)	11. Terminal block for input power
6. Radio module	12. PL d status LED

TERMINAL BLOCK FOR INPUT POWER ON BASE BOARD



WARNING! Make sure to connect the input power according to the tables below.

PN-RX-MNB5, PN-RX-MDB I I

		
1	2	3
48 - 230V AC		

1	48 - 230V AC
2	48 - 230V AC
3	Not used

PN-RX-MNA5, PN-RX-MDA I I

		
1	2	3
24 - 48V AC		

1	24 - 48V AC
2	24 - 48V AC
3	Not used

FUNCTION LEDS INDICATION IN OPERATING MODE

Function LED	Off	On	Indicates
7 (red)		x	Not compliant with PL d
	x		Compliant with PL d
8 (red)	x		No transmitter is registered.
		x	Flashes once: One or more transmitters are registered. No radio transmission established.
		x	Double flash: One or more transmitters are registered and logged in. No radio transmission established.
		x	Radio transmission established.
9 (yellow)		x	Receiving a radio packet from a transmitter other than a Panther.
9 (yellow) 10 (green)			Receiving a radio packet from a transmitter set to the radio mode different from that of a receiver.
9 (yellow) 11 (orange)		x	Received a radio packet from a transmitter that is not registered.
10 (green)		x	Received a radio packet, low signal (RSSI).
11 (orange)		x	Received a radio packet, configuration ID not accepted.
10 (green) 11 (orange)		x	Received a radio packet, custom ID not accepted.
9 (yellow) 10 (green) 11 (orange)		x	1. A radio packet from a registered transmitter received. Another registered transmitter already controlling the transmitter. NOTE! "Radio link" must be activated in the receiver. 2. Active load selection is activated.

PN-RX-MDB11, PN-RX-MDA11 BASE BOARD RECEIVER WITH A RELAY EXPANSION BOARD

WARNING! The receiver must NOT be opened by any other than a qualified installer. Make sure to turn the electricity off before opening the receiver.

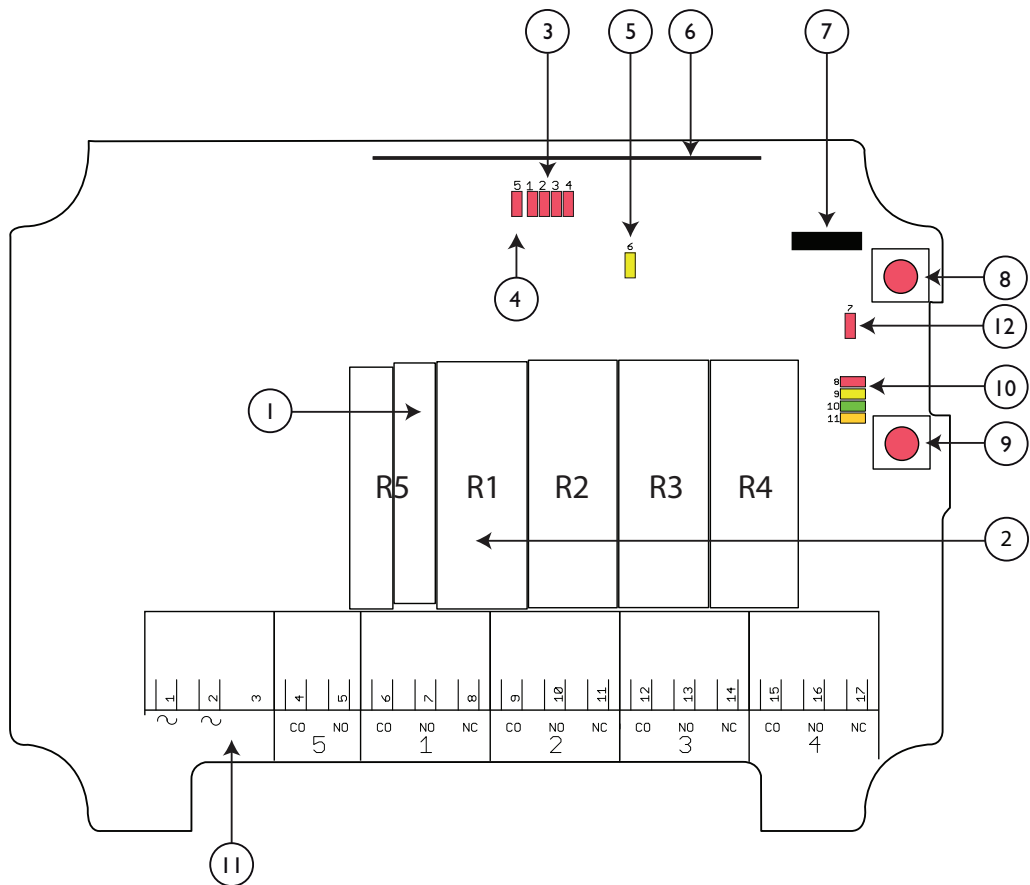

Base board:

1. Stop relays 5	7. Programming connector
2. Function relays 1-4	8. Function button (Cancel)
3. Function relay LEDs 1-4 (red)	9. Select button (OK)
4. Stop relay LED (red)	10. Function LEDs (8=red, 9=yellow, 10=green, 11=orange)
5. Power LED (yellow)	11. Terminal block for input power
6. Radio module	12. PLd status LED

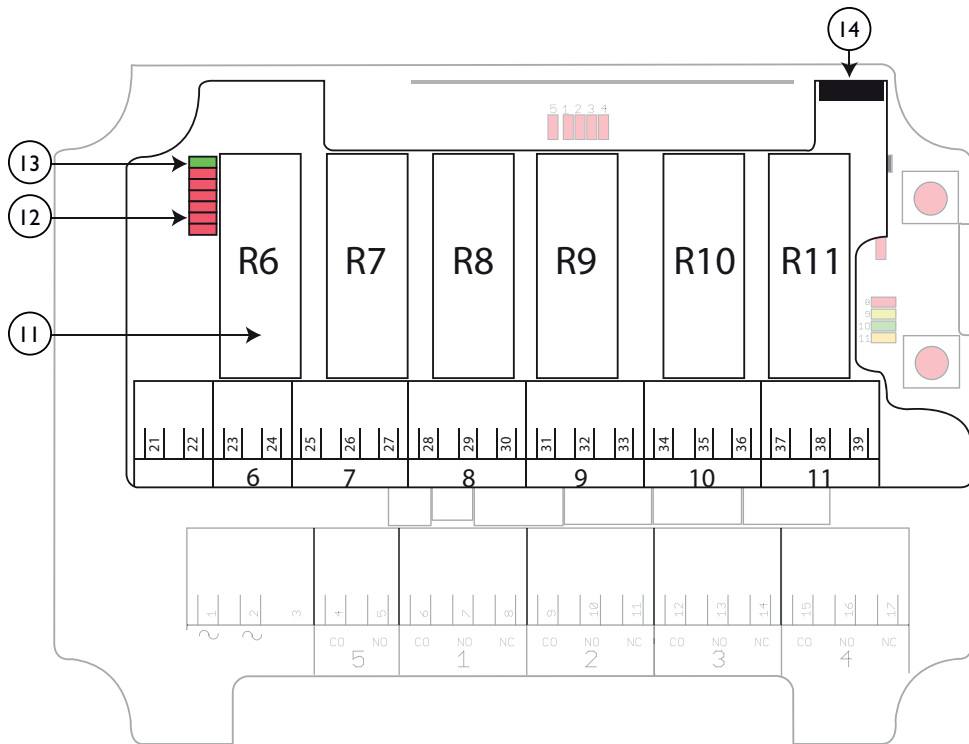

Relay expansion board:

11. Function relays 6-11	13. Communication LED (green)
12. Function relay LEDs 6-11 (red)	14. Programming connector

TERMINAL BLOCK FOR INPUT POWER ON BASE BOARD

WARNING! Make sure to connect the input power according to the tables below.

PN-RX-MNB5, PN-RX-MDB I I

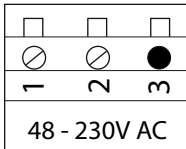

1	48 - 230V AC
2	48 - 230V AC
3	Not used

PN-RX-MNA5, PN-RX-MDA I I

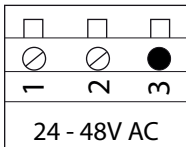

1	24 - 48V AC
2	24 - 48V AC
3	Not used

FUNCTION LEDS INDICATION IN OPERATING MODE

Function LED	Off	On	Indicates
7 (red)		x	Not compliant with PL d
	x		Compliant with PL d
8 (red)	x		No transmitter is registered.
		x	Flashes once: One or more transmitters are registered. No radio transmission established.
		x	Double flash: One or more transmitters are registered and logged in. No radio transmission established.
		x	Radio transmission established.
9 (yellow)		x	Receiving a radio packet from a transmitter other than a Panther.
9 (yellow) 10 (green)			Receiving a radio packet from a transmitter set to the radio mode different from that of a receiver.
9 (yellow) 11 (orange)		x	Received a radio packet from a transmitter that is not registered.
10 (green)		x	Received a radio packet, low signal (RSSI).
11 (orange)		x	Received a radio packet, configuration ID not accepted.
10 (green) 11 (orange)		x	Received a radio packet, custom ID not accepted.
9 (yellow) 10 (green) 11 (orange)		x	1. A radio packet from a registered transmitter received. Another registered transmitter already controlling the transmitter. NOTE! "Radio link" must be activated in the receiver. 2. Active load selection is activated.

TECHNICAL DATA

Number of stop relays	2 (potential free*, 6A, 250V AC)
Number of function relays	PN-RX-MNA5, PN-RX-MNB5: 4 PN-RX-MDA11, PN-RX-MDB11: 10 (potential free*, 10A, 250V AC)
Input power	PN-RX-MNB5, PN-RX-MDB11: 48-230V AC PN-RX-MNA5, PN-RX-MDA11: 24-48V AC
Digital inputs	0
Duplex communication	No
Max. number of registered transmitters	8
IP class	66
Size	120 x 117 x 51 mm/4.7 x 4.6 x 2"
Weight	400 g/0.8 lbs
Operating temperature	-20 - +55°C / -4 - +130°F
Operating frequency	2405-2480 MHz
Number of channels	16 (channel 11-26)
Channel separation	5 MHz
Antenna	1 internal PCB antenna

* potential free means that you have to supply voltage to get voltage out of a relay.

CURRENT CONSUMPTION

Input power	Receivers	Min.*	Max.**
24V AC	PN-RX-MNA5, PN-RX-MDA I I,	0.02A	0.2A
48V AC	PN-RX-MNA5, PN-RX-MDA I I, PN-RX-MNB5, PN-RX-MDB I I	0.01A	0.09A
115V AC	PN-RX-MNB5, PN-RX-MDB I I	0.005A	0.03A
230V AC	PN-RX-MNB5, PN-RX-MDB I I	0.003A	0.02A

*Minimum current consumption= Receiver powered, no radio session established, nothing else activated on the receiver.

**Maximum current consumption= All relays activated on the receiver.

RECEIVER MEASUREMENTS

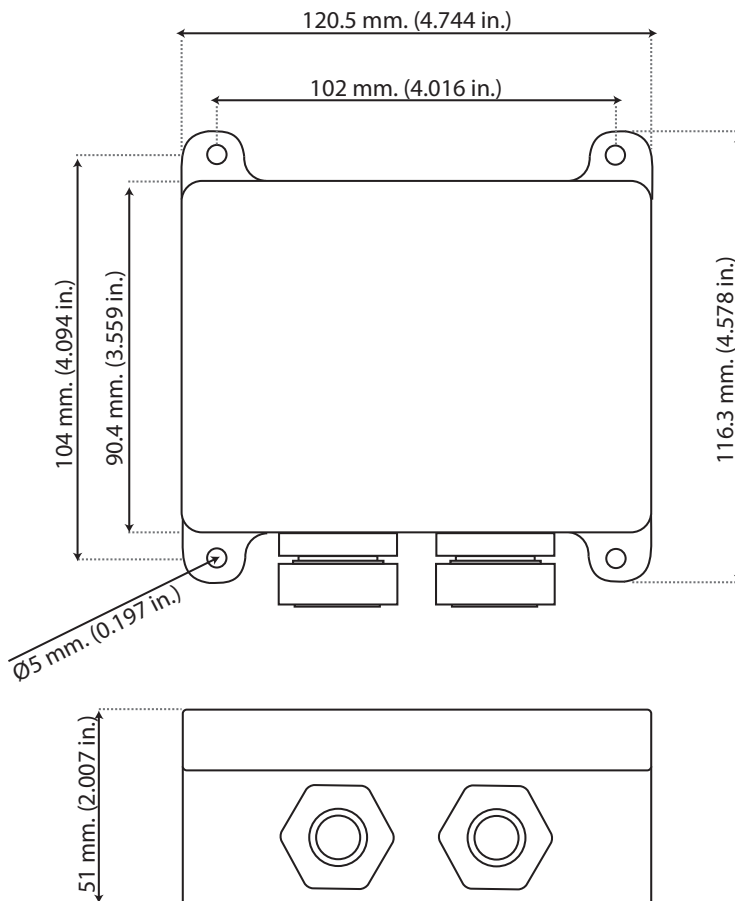

PN-TX-MX8B TRANSMITTER

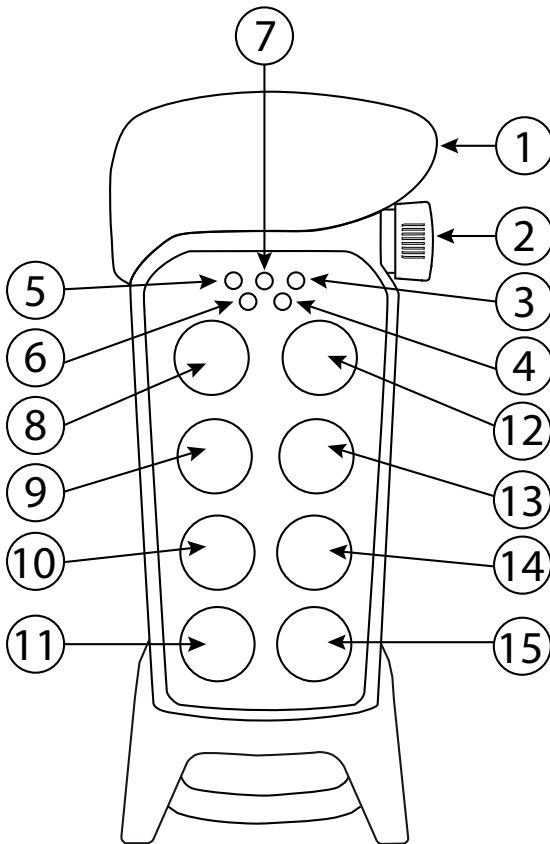

1. Rubber cover	9. Button 3
2. Stop button	10. Button 5
3. LED 2 (red)	11. Button 7 - left start button
4. LED 4 (red)	12. Button 2
5. LED 1 (red)	13. Button 4
6. LED 3 (red)	14. Button 6
7. Top LED (red, green)	15. Button 8 - right start button
8. Button 1	

TRANSMITTER BACKSIDE

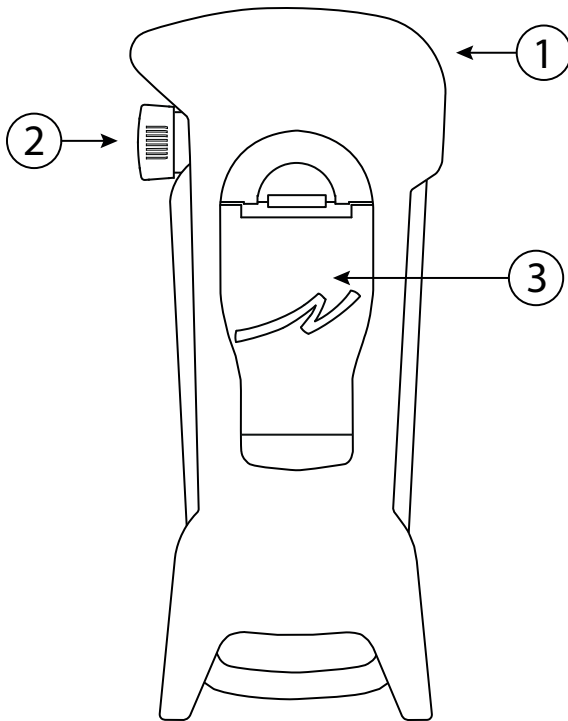

1. Rubber cover
2. Stop button
3. Battery pack

TECHNICAL DATA

NO. OF BUTTONS

PN-TX-MX8B	8 x 2-step buttons
------------	--------------------

BATTERY

PN-TX-MX8B	3 x 1.5V AAA/LR03 in battery pack D4-3
------------	--

ON/OFF SWITCH

PN-TX-MX8B	No
------------	----

DUPLEX COMMUNICATION

PN-TX-MX8B	No
------------	----

SIZE

PN-TX-MX8B	85 x 193 x 43 mm/3.4 x 7.7 x 1.7 in.
------------	--------------------------------------

WEIGHT

PN-TX-MX8B	300 g./ 0.7 lbs.
------------	------------------

OPERATING FREQUENCY

PN-TX-MX8B	2405-2480 MHz
------------	---------------

NO. OF CHANNELS

PN-TX-MX8B	16 (channel 11-26)
------------	--------------------

CHANNEL SEPARATION

PN-TX-MX8B	5 MHz
------------	-------

OPERATING TIME (WITH CONTINUOUS USAGE)

PN-TX-MX8B	Approx. 100 h. with alkaline (depending on settings)
------------	--

IP CLASS

PN-TX-MX8B	65
------------	----

OPERATING TEMPERATURE

PN-TX-MX8B	-20 - +55°C/ -4 - +130°F
------------	--------------------------

NO. OF PIN CODES POSSIBLE

PN-TX-MX8B	1
------------	---

TRANSMITTER MEASUREMENTS

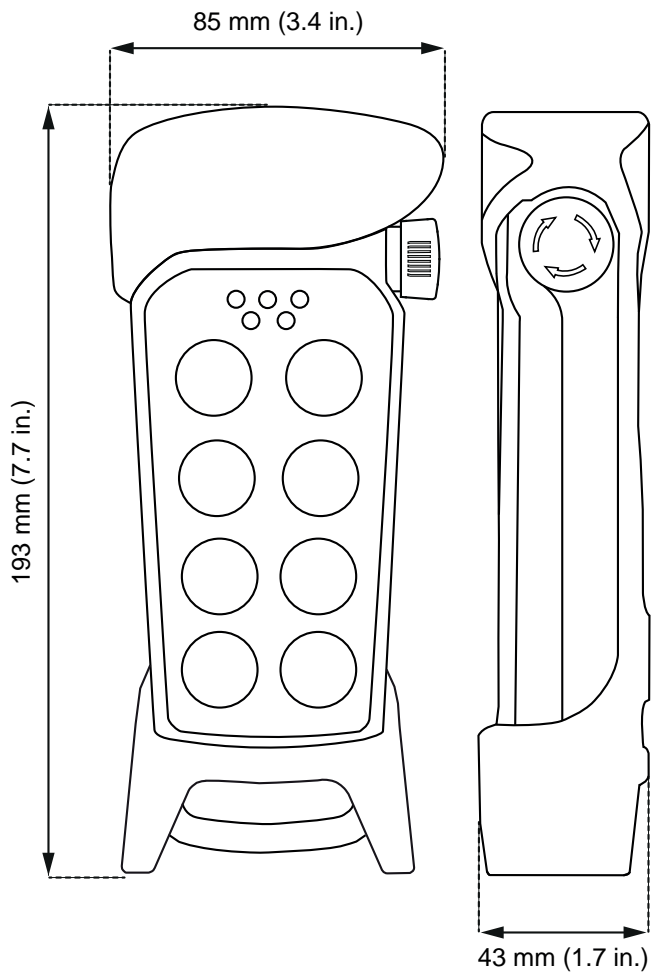

CHAPTER 4: INSTALLERS GUIDE

DEFAULT RADIO MODE

This transmitter is set to continuous radio mode by default. The transmitter starts to transmit continuously as soon as it has been started up. The radio transmission ends when the stop button is pressed. When the system is in continuous radio mode, button 7 + 8 are used as start buttons. When the system is in discontinuous radio mode, no start buttons are used.

To establish a radio link between the transmitter and the receiver, both units need to be set to the same radio mode. If you want to switch to discontinuous radio mode:

1. Set the receiver to an Operating mode that supports discontinuous radio mode.
2. Switch to discontinuous radio mode in the transmitter.

Note that some settings can only be made when the products are transmitting continuously. Those sections are marked with the text: "Only for continuous radio mode".

When selecting Operating mode you have to know if the products are transmitting continuously or discontinuously. Therefore you will find information on the Operating modes pages.

SWITCH RADIO MODE IN THE TRANSMITTER

NOTE! For discontinuous radio mode in the transmitter, the receiver must be set to an Operating mode that supports discontinuous radio mode.

1. Make sure that the stop button is pressed.
2. Press button 8. Keep pressed.
3. Twist and pull out the stop button.
4. Release button 8.
Top LED flashes (green).
5. WITHIN 1 MINUTE FROM PULLING OUT THE STOP BUTTON:
Enter the code: 1-2-3-4 (press the buttons 1, 2, 3, 4).
The transmitter LEDs 1- 4 (red) light up. If the code is invalid, the transmitter turns off. If the code is accepted, the top LED flashes (green), The transmitter LEDs 1-4 (red) starts to flash.
6. WITHIN 1 MINUTE FROM ENTERING THE CODE: Press button 1.
The top LED lights (green). LED 2 flashes (red).
7. Press a button to select radio mode:
Button 1 = continuous radio mode
Button 2 = discontinuous radio mode
8. The top LED flashes (green) 3 times. The transmitter turns off.

START THE TRANSMITTER

NOTE! Only for continuous radio mode.

1. Make sure that the stop button is pressed.
2. Twist and pull out the stop button.
The top LED lights (green when the battery capacity is good, red when the battery capacity is poor), LEDs 3 + 4 flash (red).
3. Press the start buttons (buttons 7 + 8) at the same time for at least 1 second.
LEDs 3 + 4 light (red).
4. Release the start buttons.
LEDs 3 + 4 go out.
The top LED flashes green.

START THE TRANSMITTER IN MENU MODE

1. Make sure that the stop button is pressed.
2. Press button 8. Keep pressed.
3. Twist and pull out the stop button.
4. Release button 8.
Top LED flashes (green).
5. WITHIN 1 MINUTE FROM PULLING OUT THE STOP BUTTON:
Enter the code: 1-2-3-4 (press the buttons 1, 2, 3, 4).
The transmitter LEDs 1 - 4 (red) light up. If the code is invalid, the transmitter turns off. If the code is accepted, the top LED flashes (green), The transmitter LEDs 1-4 (red) starts to flash.
6. WITHIN 1 MINUTE FROM ENTERING THE CODE: Enter a menu by pressing the buttons according to the table below:

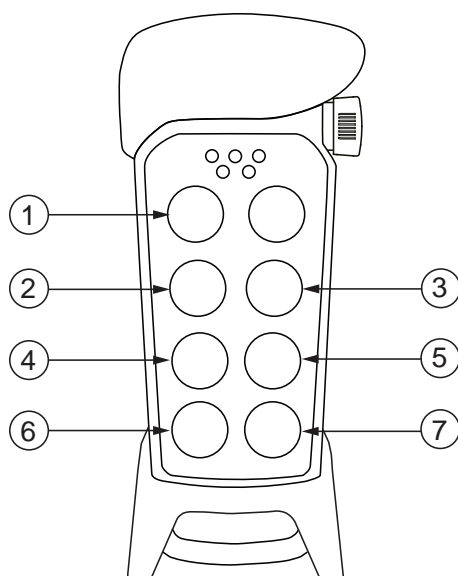

1. Radio mode	6. Logout
2. Replace	7. Shift button
3. Show channel	Shift+3. Switch channel
4. Auto shutdown	Shift+5. Load at start-up
5. Load select mode	

If no buttons are pressed within 1 minute, or if the stop button is pressed, the transmitter will turn off.

REGISTER THE TRANSMITTER IN THE RECEIVER

Register in continuous radio mode

WARNING! Keep only transmitters, that you intend to use, registered in the receiver.

NOTE! Only for continuous radio mode.

1. Make sure that the stop button is pressed.
2. Twist and pull out the stop button.
The top LED lights (green when the battery capacity is good, red when the battery capacity is poor), LEDs 3 + 4 flash (red).
3. Press the start buttons (buttons 7 + 8) at the same time for at least 1 second.
LEDs 3 + 4 light (red).
4. Release the start buttons.
LEDs 3 + 4 go out.
The top LED flashes green.
5. Press the receiver Function button.
The function LED lights red.
6. Press the receiver Select button.

All relay LEDs light red.

7. Press transmitter button 1 and 2. Keep pressed.
All relay LEDs light red.

8. The relay LEDs flash 2 times.

9. Release transmitter button 1 and 2.
The relay LEDs flash 1 time.
The transmitter is registered.

Register in discontinuous radio mode

WARNING! Keep only transmitters, that you intend to use, registered in the receiver.

NOTE! Only for discontinuous radio mode.

1. Press the receiver Function button.
The function LED lights red.

2. Press the receiver Select button.
All relay LEDs light red.

3. Press transmitter button 1 and 2. Keep pressed.
All relay LEDs light red.

4. The relay LEDs flash 2 times.

5. Release transmitter button 1 and 2.
The relay LEDs flash 1 time.
The transmitter is registered.

ERASE ALL TRANSMITTERS FROM THE RECEIVER

1. Press the Function button in the receiver.
The red function LED lights.
2. Press the receiver Select button. Keep pressed.
All relay LEDs light red.
3. All relay LEDs go out.
4. Release the Select button.
All transmitters are erased from the receiver.
If the red function LED flashes, one or more transmitters are still registered in the receiver.

TURN THE TRANSMITTER OFF

1. Press the stop button.

NOTE! When the transmitter is active and the stop button is pressed, all relays go off.

REPLACE

You can replace a registered transmitter with another transmitter without having access to the receiver. Use the new transmitter that you want to replace the old transmitter with.

1. Make sure that the stop button is pressed.
2. Press button 8. Keep pressed.
3. Twist and pull out the stop button.
4. Release button 8.
Top LED flashes (green).
5. WITHIN 1 MINUTE FROM PULLING OUT THE STOP BUTTON:
Enter the code: 1-2-3-4 (press the buttons 1, 2, 3, 4).
The transmitter LEDs 1 - 4 (red) light up. If the code is invalid, the transmitter turns off. If the code is accepted, the top LED flashes (green), The transmitter LEDs 1-4 (red) starts to flash.
6. WITHIN 1 MINUTE FROM ENTERING THE CODE:
Press button 3.
The top LED lights (green). LED 2 flashes (red).
7. Enter the replacement ID code (a maximum of 11 digits) for the transmitter that you want to replace by pressing the transmitter buttons. **IMPORTANT!** When entering the last digit in the code, keep that button pressed until you have pressed the stop button.

IMPORTANT! The replacement ID code is placed in the back of the transmitter. Remove the rubber cover. This label is placed above the battery lid. You will find the correct replacement ID code in the bottom of the replacement code label.



8. Transmitter LED 3 lights (red) when one or more digits have been entered. Transmitter LEDs 3 + 4 (red) light when a maximum number of digits (11) have been entered.

9. Press the stop button. You can now release the button.

10. After approx. 10 seconds the transmitter turns off. **NOTE!** If replacing fails, press the stop button and start over again.

FREQUENCIES AND CHANNELS

Channel	Frequency
11	2405 MHz
12	2410 MHz
13	2415 MHz
14	2420 MHz
15	2425 MHz
16	2430 MHz
17	2435 MHz
18	2440 MHz
19	2445 MHz
20	2450 MHz
21	2455 MHz
22	2460 MHz
23	2465 MHz
24	2470 MHz
25	2475 MHz
26	2480 MHz

Show channel

1. Make sure that the stop button is pressed.
2. Press button 8. Keep pressed.
3. Twist and pull out the stop button.
4. Release button 8.
Top LED flashes (green).
5. WITHIN 1 MINUTE FROM PULLING OUT THE STOP BUTTON:
Enter the code: 1-2-3-4 (press the buttons 1, 2, 3, 4).
The transmitter LEDs 1 - 4 (red) light up. If the code is invalid, the transmitter turns off. If the code is accepted, the top LED flashes (green), The transmitter LEDs 1-4 (red) starts to flash.
6. WITHIN 1 MINUTE FROM ENTERING THE CODE:
Press button 4.
The top LED lights (green).
7. The selected channel will be indicated in the following way:
LED 1 (red) will flash the number of times corresponding to the first digit. LED 2 (red) will flash the number of times corresponding to the second digit.
E.g. for channel 23: LED 1 (red) will flash 2 times, LED 2 (red) will flash 3 times.

Switch channel

1. Make sure that the stop button is pressed.
2. Press button 8. Keep pressed.
3. Twist and pull out the stop button.
4. Release button 8.
Top LED flashes (green).
5. WITHIN 1 MINUTE FROM PULLING OUT THE STOP BUTTON:
Enter the code: 1-2-3-4 (press the buttons 1, 2, 3, 4).
The transmitter LEDs 1 - 4 (red) light up. If the code is invalid, the transmitter turns off. If the code is accepted, the top LED flashes (green), The transmitter LEDs 1-4 (red) starts to flash.
6. WITHIN 1 MINUTE FROM ENTERING THE CODE:
Press button 8. Keep pressed.
7. Press button 4. Release.
8. Release button 8.
The top LED lights (green). LED 2 (red) flashes.
9. Select channel 11-26.
For example: Press button 2 for the first digit in channel 20. To enter the zero, press button 8. Keep pressed. Press button 4. Release button 4. Release button 8.

Press button...	for digit...
1	1
2	2
3	3
4	4
5	5
6	6
8 (shift)+1	7
8 (shift)+2	8
8 (shift)+3	9
8 (shift)+4	0

LED 3 (red) lights when a valid digit has been entered.
LEDs 3 and 4 (red) light when two valid digits have been entered.
The top LED flashes (green) 3 times. The transmitter turns off.

AUTOMATIC SHUTDOWN

NOTE! Only for continuous radio mode.

Turning on automatic shutdown can save battery capacity by automatically turning the transmitter off when no function has been activated for a set time.

Set the time for automatic shutdown

1. Make sure that the stop button is pressed.

2. Press button 8. Keep pressed.

3. Twist and pull out the stop button.

4. Release button 8.

Top LED flashes (green).

5. WITHIN 1 MINUTE FROM PULLING OUT THE STOP BUTTON:

Enter the code: 1-2-3-4 (press the buttons 1, 2, 3, 4).

The transmitter LEDs 1-4 (red) light up. If the code is invalid, the transmitter turns off. If the code is accepted, the top LED flashes (green), The transmitter LEDs 1-4 (red) starts to flash.

6. WITHIN 1 MINUTE FROM ENTERING THE CODE:

Press button 5.

The top LED lights (green). LED 2 flashes (red).

7. Select the time that you want for automatic shutdown by pressing the buttons according to the table:

Press button...	Automatic shutdown time after...
1	3 minutes
2	6 minutes
3	12 minutes
7	No automatic shutdown

The top LED flashes green 3 times. The transmitter turns off.

LOGOUT

NOTE! Only for continuous radio mode.

NOTE! Quick logout can only be made when the transmitter is on and the radio link is up.

Quick logout

1. Press button 7. Keep pressed.
2. Press the stop button.
3. The transmitter is logging out for approx. 10 seconds. The transmitter turns off.

Logout from receiver

1. Press the receiver Select button.
LED 10 (orange) lights.
2. Keep pressed (for more than 4 seconds).
LED 10 (orange) goes off.
3. The transmitter is now logged off. Any other registered transmitter can log in.

Logout from menu mode

1. Make sure that the stop button is pressed.
2. Press button 8. Keep pressed.
3. Twist and pull out the stop button.
4. Release button 8.
Top LED flashes (green).
5. WITHIN 1 MINUTE FROM PULLING OUT THE STOP BUTTON:
Enter the code: 1-2-3-4 (press the buttons 1, 2, 3, 4).
The transmitter LEDs 1-4 (red) light up. If the code is invalid, the transmitter turns off. If the code is accepted, the top LED flashes (green), The transmitter LEDs 1-4 (red) starts to flash.
6. WITHIN 1 MINUTE FROM ENTERING THE CODE:
Press button 7.
The top LED flashes (red).
7. The transmitter is logging out for approx. 10 seconds. The transmitter turns off.

RELAY FUNCTIONALITY

NOTE! If Operating mode 0 is selected, you can not make these settings. Contact your representative for assistance.

NOTE! Momentary relay functionality is default. That means that the relay will only be activated when you press a button on the transmitter. When the button is released, the relay deactivates. Setting a relay to latching means that the relay gets activated every time that you press a button, but in this case the relay remains active until the button is pressed again.

NOTE! Before starting to perform these settings, make sure that the stop relays are deactivated!

NOTE! The settings options depend on the selected Operating mode.

Momentary or latching relay functionality

1. Press the receiver Function button 2 times. LED 9 (yellow) lights. The relay LEDs light.
2. Press the receiver Select button to switch relay functionality. The relay LEDs flash to indicate that a latching or momentary functionality can be set to the corresponding relays.
3. Press the receiver Function button to set latching or momentary functionality:
LED 9 (yellow) off= momentary relay functionality
LED 9 (yellow) on = latching relay functionality
4. Press the receiver Select button to step to the next available relay. When you have stepped through all the available relays, the receiver exits the settings menu.

CHAPTER 5: OPERATING MODES

SELECT OPERATING MODE

NOTE! Go to the Operating modes pages to see what Operating modes that are available when transmitting in continuous/ discontinuous radio mode. Operating modes do not work for both radio modes.

1. Press the receiver Function button 4 times.
LED 11 (orange) lights.

2. Press the receiver Select button to see what Operating mode that is used.
The relay LEDs light according to the table below, LED 11 flashes in orange.

When relay LED no. light(s)...	the selected Operating mode is...
0	0*
1	1
2	2
1+2	3
3	4
1+3	5
ALL	255*

3. Press the receiver Function button to step one Operating mode number at the time.
Example: You know that Operating mode 2 is selected, because relay LED 2 lights. When pressing the Function button one time, you would go to Operating mode 3 and LEDs 1+2 light. If you want to go to Operating mode 4, you would press the Function button one more time and LED 3 lights.

4. Press the receiver Select button to select Operating mode. The receiver exits the Operating mode menu and restarts.

*Operating modes that are reserved for specific customer applications can only be set in the PC program Settings manager. Contact your representative for assistance.

OPERATING MODE 1

NOTE! Only for continuous radio mode.

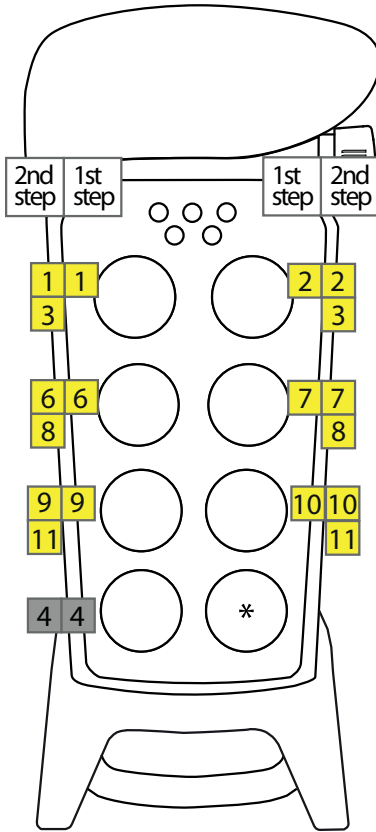

* Depending on transmitter Load select mode

■ Button functions

■ Direction functions

On relays	Relay 5 is active when radio link is up
Work relays	-
Recommended Load select mode	0, 1,3
Load select relays	-
Programmable settings	Relay 4 can be set to latching
Interlocking	Between button pairs: 1-2, 3-4, 5-6
Radio mode	Continuous
Zero position check	Active on all functions

OPERATING MODE 2

NOTE! Only for continuous radio mode.

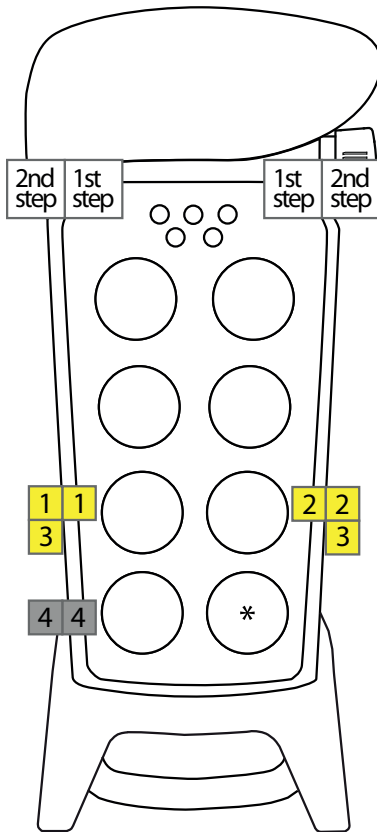

* Depending on transmitter Load select mode

■ Button functions

■ Direction functions

On relays	Relay 5 is active when radio link is up
Work relays	-
Recommended Load select mode	0, 1, 3
Load select relays	-
Programmable settings	Relay 4 can be set to latching
Interlocking	Between button pairs: 5-6
Radio mode	Continuous
Zero position check	Active on all functions

OPERATING MODE 3

NOTE! Only for continuous radio mode.

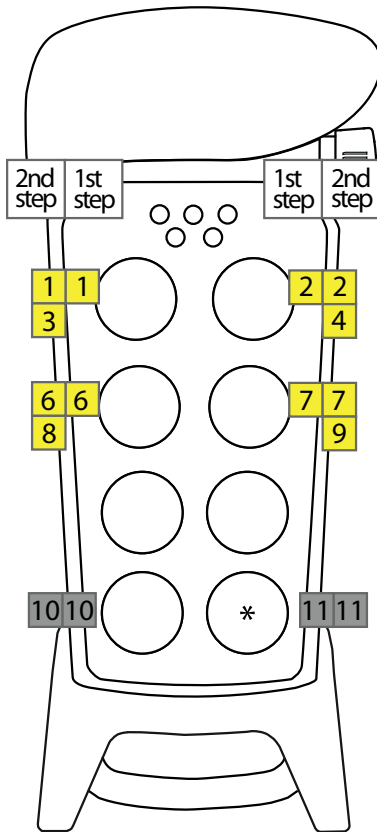

* Depending on transmitter Load select mode

■ Button functions

■ Direction functions

On relays	Relay 5 is active when radio link is up
Work relays	-
Recommended Load select mode	0, 1, 3
Load select relays	-
Programmable settings	Relays 10-11 can be set to latching
Interlocking	Between button pairs: 1- 2, 3- 4
Radio mode	Continuous
Zero position check	Active on all functions

OPERATING MODE 4

NOTE! Only for continuous radio mode.

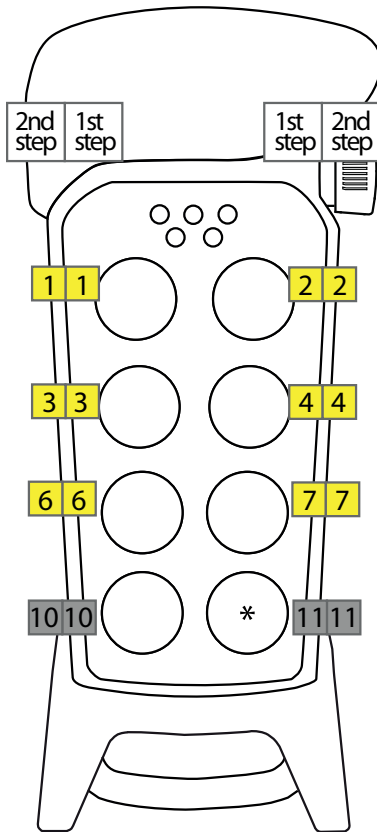

* Depending on transmitter Load select mode

■ Button functions

■ Direction functions

On relays	Relay 5 is active when radio link is up
Work relays	-
Recommended Load select mode	0, 1, 3
Load select relays	-
Programmable settings	Relays 10-11 can be set to latching
Interlocking	Between button pairs: 1- 2, 3- 4, 5-6
Radio mode	Continuous
Zero position check	Active on all functions

OPERATING MODE 5

NOTE! Only for discontinuous radio mode.

NOTE! Discontinuous radio mode cancels the PL d safety classified stop function.

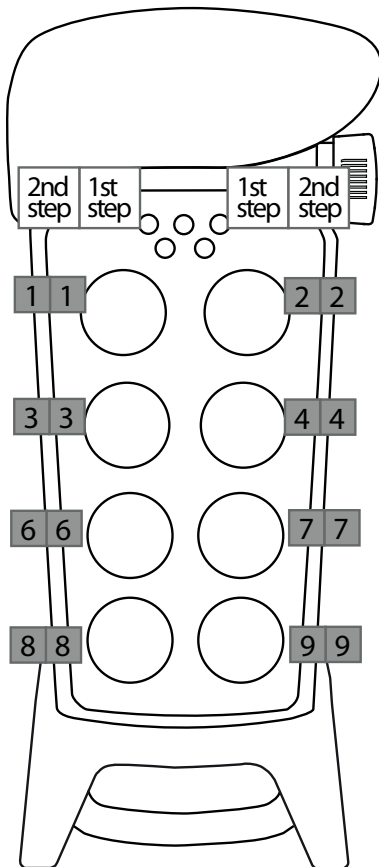

■ Button functions

On relays	-
Work relays	Relay 5 is active when relay 1-4 or 6-11 is active
Recommended Load select mode	0
Load select relays	-
Programmable settings	Relay 1-4, 6-11 can be set to latching
Interlocking	-
Radio mode	Discontinuous
Zero position check	-

CHAPTER 6: LOAD SELECT MODES

MAKE A LOAD SELECTION

NOTE! Only for continuous radio mode.

NOTE! Load select mode 0 is default.

1. Make sure that the stop button is pressed.

2. Press button 8. Keep pressed.

3. Twist and pull out the stop button.

4. Release button 8.

Top LED flashes (green).

5. WITHIN 1 MINUTE FROM PULLING OUT THE STOP BUTTON:

Enter the code: 1234 (press the buttons 1, 2, 3, 4).

The transmitter LEDs 1 - 4 (red) light up. If the code is invalid, the transmitter turns off. If the code is accepted, the top LED flashes (green), The transmitter LEDs 1-4 (red) starts to flash.

6. WITHIN 1 MINUTE FROM ENTERING THE CODE:

Press button 6.

The top LED lights (green). LED 2 flashes (red).

7. To select a Load select mode, press a button according to the table:

Press button...	for Load select mode...	with this load selected at start-up
7	0	none
1	1	A
2	2	A
3	3	A
4	4	A

The top LED flashes (green) 3 times. The transmitter turns off.

LOAD SELECT MODE 0-4

Load select mode 0

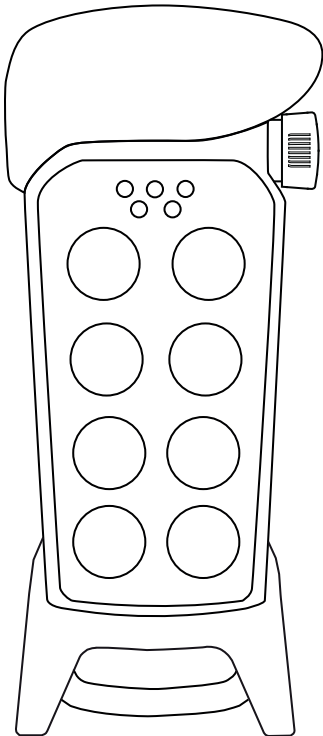

Load select mode 1

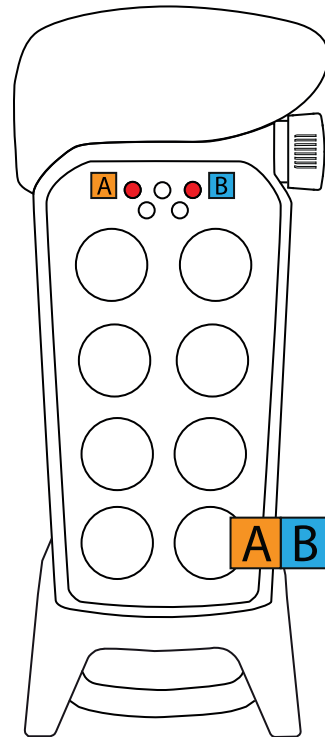

Load select mode 2

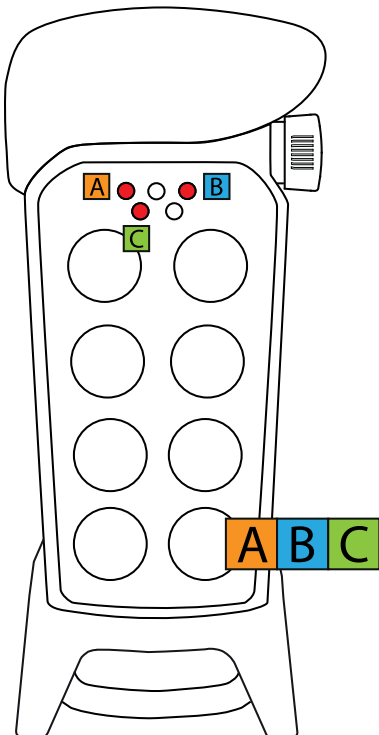

Load select mode 3

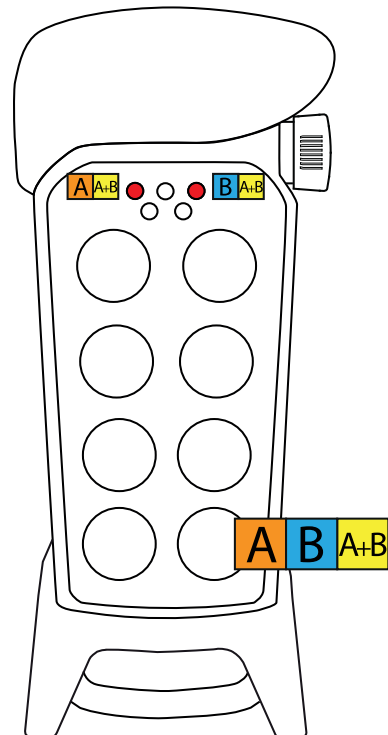

Load select mode 4

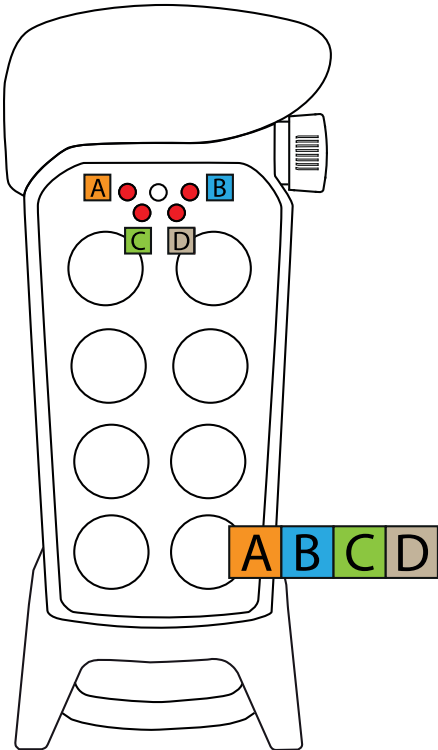

LOAD AT START-UP

NOTE! We recommend starting with Load select before selecting load at start-up.

1. Make sure that the stop button is pressed.
2. Press button 8. Keep pressed.
3. Twist and pull out the stop button.
4. Release button 8.
Top LED flashes (green).
5. WITHIN 1 MINUTE FROM PULLING OUT THE STOP BUTTON:
Enter the code: 1-2-3-4 (press the buttons 1, 2, 3, 4).
The transmitter LEDs 1- 4 (red) light up. If the code is invalid, the transmitter turns off. If the code is accepted, the top LED flashes (green), The transmitter LEDs 1-4 (red) starts to flash.
6. WITHIN 1 MINUTE FROM ENTERING THE CODE:
Press button 8. Keep pressed.
7. Press button 6. Release.
8. Release button 8.
The top LED lights (green). LED 2 (red) flashes.
9. To select Load at start-up, press a button according to the table below:

Press...	for Load at start-up...
Button 7	none
Button 1	A
Button 2	B
Button 3	A+B

CHAPTER 7: BATTERY GUIDE

BATTERY INFORMATION

NOTE! Electronics and batteries must be physically separated before disposal. Make sure that electronics or batteries are not thrown in the household waste.

NOTE! Two different battery solutions - D4-2 and D4-3 - are available for use in the transmitter.

BATTERY TYPE	
D4-2	Replaceable, rechargeable lithium-ion battery
D4-3	Replaceable battery pack with 3 x 1.5V AAA/LR03 batteries

OPERATING TIME	
D4-2	Approx. 150 h.(depending on settings)
D4-3	Approx. 100 h. with alkaline (depending on settings)

CHARGE	
D4-2	Charge in the Tele Radio AB charger unit
D4-3	Do not charge in the Tele Radio AB charger unit. Switch the batteries inside the battery pack.

CHARGING TEMPERATURE	
D4-2	0-45°C/32-113°F
D4-3	Not applicable

SWITCH BATTERIES

Switch batteries in the battery pack D4-3

WARNING! Do not charge the battery pack D4-3 in the Tele Radio AB charger unit or in any other way.

NOTE! Electronics and batteries must be physically separated before disposal. Make sure that electronics or batteries are not thrown in the household waste.

1. Remove the battery pack from the back of the transmitter.
2. Open up the battery pack.
3. Switch the 3 x 1.5V AAA/LR03 batteries. Use alkaline batteries for optimal performance.
4. Put the battery pack back in the transmitter.

BATTERY PRECAUTIONS

Observe the following general battery warnings:

- As batteries contains flammable substances such as lithium or other organic solvents, they may cause heating, rupture or ignition.
- Risk of explosion if battery is replaced with a battery of an incorrect type.
- Do not short circuit, disassemble, deform or heat batteries.
- Never try to charge a visibly damaged or frozen battery.
- Keep batteries out of reach of small children. Should a child swallow a battery, consult a physician immediately.
- Avoid direct soldering to batteries.
- When discarding batteries, insulate the + and - terminals of batteries with insulating/ masking tape. Do not put multiple batteries in the same plastic bag.
- When improperly disposed, batteries may short circuit, causing them to become hot, burst or ignite.
- Store in a cool location. Keep batteries away from direct sunlight, high temperature, and high humidity.
- Do not throw batteries into fire.

ROHS AND WEEE

In accordance with Directive 2011/65/EU on restriction of the use of certain hazardous substances in electrical and electronic equipment (RoHS) and Directive 2012/19/EU on waste electrical and electronic equipment (WEEE), Tele Radio AB strives to minimize the use of hazardous materials, promotes reuse and recycling, and reduces emissions to air, soil and water. When a commercially viable alternative is available, Tele Radio AB strives to restrict or eliminate substances and materials that pose an environmental, health or safety risk.

GUARANTEE, SERVICE, REPAIRS AND MAINTENANCE

The Tele Radio AB products are covered by a guarantee/warranty against material, construction and manufacturing faults. During the guarantee/warranty period, Tele Radio AB may replace the product or faulty parts. Work under guarantee/warranty must be carried out by Tele Radio AB or by an authorized service centre specified by Tele Radio AB.

This is not covered by the guarantee/ warranty:

- Faults resulting from normal wear and tear
- Parts of a consumable nature
- Products that have been subject to unauthorized modifications
- Faults resulting from incorrect installation and use
- Damp and water damage

Maintenance:

- Repairs and maintenance must be carried out by qualified personnel
- Use spare parts from Tele Radio AB only
- Contact your representative if you require service or other assistance
- Keep the product in a dry, clean place
- Keep contacts and antennas clean
- Wipe off dust using a slightly damp, clean cloth

WARNING! Never use cleaning solutions or high-pressure water.

CHAPTER 8: CERTIFICATIONS CHAPTER

FCC STATEMENT

Statement for warning:

To satisfy FCC RF exposure requirements, a separation distance of 20 cm or more should be maintained between the antenna of this device and persons during device operation.

To ensure compliance, operations at closer than this distance is not recommended.

Les antennes installées doivent être situées de façon à ce que la population ne puisse y être exposée à une distance de moins de 20 cm. Installer les antennes de façon à ce que le personnel ne puisse approcher à 20 cm ou moins de la position centrale de l'antenne.

La FCC des États-Unis stipule que cet appareil doit être en tout temps éloigné d'au moins 20 cm des personnes pendant son fonctionnement.

Caution: The user is cautioned that changes or modifications not expressly approved by the party responsible for compliance could void the user's authority to operate the equipment.

This device complies with Industry Canada licence-exempt RSS standard(s) and Part 15 of the FCC Rules. Operation is subject to the following two conditions:

- (1) this device may not cause harmful interference, and
- (2) this device must accept any interference received, including interference that may cause undesired operation.

Le présent appareil est conforme aux CNR d'Industrie Canada applicables aux appareils radio exempts de licence et la partie 15 des Règles FCC. L'exploitation est autorisée aux deux conditions suivantes :

- (1) l'appareil ne doit pas produire de brouillage, et
- (2) l'utilisateur de l'appareil doit accepter tout brouillage radioélectrique subi, même si le brouillage est susceptible d'en compromettre le fonctionnement.

This equipment complies with FCC and IC radiation exposure limits set forth for an uncontrolled environment. End user must follow the specific operating instructions for satisfying RF exposure compliance. This transmitter must not be co-located or operating in conjunction with any other antenna or transmitter.

Cet appareil est conforme aux limites d'exposition au rayonnement RF stipulées par la FCC et l'IC pour une utilisation dans un environnement non contrôlé. L'utilisateur final doit suivre les instructions de fonctionnement spécifiques pour le respect d'exposition aux RF. Les émetteurs ne doivent pas être placés près d'autres antennes ou émetteurs ou fonctionner avec ceux-ci.

Note: this equipment has been tested and found to comply with the limits for a class B digital device, pursuant to part 15 of the FCC rules. These limits are designed to provide reasonable protection against harmful interference in a residential installation. This equipment generates, uses and can radiate radio frequency energy and, if not installed and used in accordance with the instructions, may cause harmful interference to radio communications. However, there is no guarantee that interference will not occur in a particular installation. If this equipment does cause harmful interference to radio or television reception, which can be determined by turning the equipment off and on, the user is encouraged to try to correct the interference by one or more of the following measures:

- reorient or relocate the receiving antenna.
- increase the separation between the equipment and receiver.
- connect the equipment into an outlet on a circuit different from that to which the receiver is connected.
- consult the dealer or an experienced radio/TV technician for help.

Under Industry Canada regulations, this radio transmitter may only operate using an antenna of a type and maximum (or lesser) gain approved for the transmitter by Industry Canada. To reduce potential radio interference to other users, the antenna type and its gain should be so chosen that the equivalent isotropically radiated power (e.i.r.p.) is not more than that necessary for successful communication.

Conformément à la réglementation d'Industrie Canada, le présent émetteur radio peut fonctionner avec une antenne d'un type et d'un gain maximal (ou inférieur) approuvé pour l'émetteur par Industrie Canada. Dans le but de réduire les risques de brouillage radioélectrique à l'intention des autres utilisateurs, il faut choisir le type d'antenne et son gain de sorte que la puissance isotrope rayonnée équivalente (p.i.r.e.) ne dépasse pas l'intensité nécessaire à l'établissement d'une communication satisfaisante.

PRODUCT AND FCC/IC LABELS ON THE TRANSMITTER

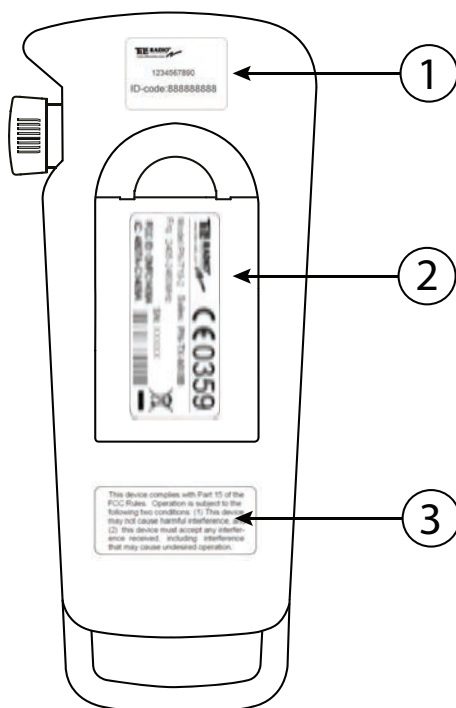

1. Label with replacement ID code
2. Product label
3. FCC statement label

EC/EEA DECLARATION OF CONFORMITY

EC/EEA DECLARATION OF CONFORMITY



The undersigned, representing the following manufacturer:

NAME: Tele Radio AB
ADDRESS: Datavägen 21, SE-436 32 Askim, SWEDEN
TELEPHONE NO: 46-31-7485460 TELEFAX NO: 46-31-685464

Herewith declares that the product(s):

RECEIVERS PN-R15-1, PN-R15-2, PN-R15-7, PN-R15-8

Is in conformity with the provisions of the following harmonized standards, other standards and directives:

2006/42/EC ¹	Directive 2006/42/EC of the European Parliament and of the Council on machinery	
1999/5/EC	Directive 1999/5/EC of the European Parliament and of the Council on radio equipment and telecommunications terminal equipment and the mutual recognition of their conformity (R&TTE)	
2006/95/EC	Directive 2006/95/EC of the European Parliament and of the Council on harmonisation of the laws of the Member states relating to electrical equipment designed for use within certain voltage limits	
2004/108/EC	Directive 2004/108/EC of the European Parliament and of the Council on the approximation of the laws of the Member states relating to electromagnetic compatibility	
2011/65/EC	Directive 2011/65/EC of the European Parliament and of the Council on the restriction of the use of certain hazardous substances in electrical and electronic equipment	
EN 50371	Generic Standard to Demonstrate the Compliance of Low-Power Electronic and Electrical Apparatus with the Basic Restrictions Related to Human Exposure to Electromagnetic Fields (10 MHz–300 GHz)—General Public	HEALTH
EN 60950-1	Information technology equipment—SAFETY—Part 1: General requirements	SAFETY/LVD
EN 301489-1/-17	Electromagnetic compatibility and Radio spectrum Matters (ERM): ElectroMagnetic Compatibility (EMC) standard for radio equipment and services: Part 1: Common technical requirements- Part 17: Specific conditions for Wideband data and HIPERLAN equipment	EMC
EN 300328-1/-2	Electromagnetic compatibility and Radio spectrum Matters (ERM) - Wideband Transmission systems - Data transmission equipment operating in the 2,4 GHz ISM band and using spread spectrum modulation techniques - Part 1: Technical characteristics and test conditions. Part 2: Harmonized EN covering essential requirements under article 3.2 of the R&TTE Directive	RADIO
EN 62061 ²	Safety of machinery - Functional safety of safety-related electrical, electronic and programmable electronic control systems	
EN 60204-1/-32 ²	Safety of machinery - Electrical equipment of machines- Part 1: General requirements. Part 32: Requirements for hoisting machines- Cranes - Controls and control stations	
EN 15011 ²	Cranes - Bridge and gantry cranes	
EN 50581	Technical documentation for the assessment of electrical and electronic products with respect to the restriction of hazardous substances	
EN ISO 13849-1	Safety of machinery- Safety-related parts of control systems- Part 1: General principles for design	Category 3 PL d

1) According to Annex IV, paragraph 21 and article 12 (3), option (a).

2) The products fulfill the relevant parts for cableless controls and electrical equipment when mounted and installed correctly.

Authorized to compile technical file:

NAME: Jesper Ribbe

ADDRESS: Same as manufacturer

Askim November 28th, 2014

Jesper Ribbe

Research & Development Manager, Tele Radio AB

CER-PN-EC007-A01



www.teleradio.com

TELE RADIO SVERIGE
Sweden

TELE RADIO GmbH
Germany

TELE RADIO ASIA
China

TELE RADIO TURKEY
Turkey

TELE RADIO ITALIA
Italy

TELE RADIO LTD
England

TELE RADIO LLC
North & South America

TELE RADIO BV
Benelux

TELE RADIO AS
Norway

TELE RADIO SL
Spain