

Full SAR Test Report

Applicant Name: TELE RADIO AB
 Applicant Address: Datavagen 21, SE-436 32 Askim, Sweden

The following samples were submitted and identified on behalf of the client as:

Sample Description	TRANSMITTER
SGS Ref	MP001
Model Number	T00007-05
Final Hardware Version Tested	--
Final Software Version Tested	--
FCC ID	ONFC0911A
Date Initial Sample Received	09-02,2010
Testing Start Date	10-20,2010
Testing End Date	10-20,2010

According to:
 FCC 47CFR § 2.1093, IEEE Std C95.1-2005
 IEEE1528-2003, OET Bulletin 65 Supplement C

Comments/ Conclusion:
 The configuration tested complied to the certification requirements specified in this report.

Signed for on behalf of SGS

David Lee

Project Manager

Peter Xue

Technical Manager

This document is issued by the Company subject to its General Conditions of Service printed overleaf, available on request or accessible at http://www.sgs.com/terms_and_conditions.htm. and, for electronic format documents to Terms and Conditions for Electronic Documents at www.sgs.com/terms_e-document.htm. Attention is drawn to the limitation of liability, indemnification and jurisdiction issues defined therein. Any holder of this document is advised that information contained hereon reflects the company's findings at the time of its intervention only and within the limits of Client's instructions, if any. The Company's sole responsibility is to its Client and this document does not exonerate parties to a transaction from exercising all their rights and obligation under the transaction documents. This document cannot be reproduced except in full, without prior written approval of the Company. Any unauthorised alteration, forgery or falsification of the content or appearance of this document is unlawful and offenders may be prosecuted to the fullest extent of the law. Unless otherwise stated the results shown in this test report refer only to the sample(s) tested and such sample(s) are retained for 30 days only

SHGSM

Table of Contents

Change History	3
1. Report Overview	4
2. Test Lab Declaration or Comments.....	4
3. Applicant Declaration or Comments.....	4
4. Full Test Report	4
5. Partial Test Report.....	4
6. Measurement Uncertainty	4
7. Testing Environment	6
8. Primary Test Laboratory	6
9. Details of Applicant	6
10. Details of Manufacturer	6
11. Other testing Locations	6
12. Referenced Documents.....	7
13. Primary Laboratory Accreditation Details	8
14. SGS Shanghai Wireless Telecommunications lab, Personnel	9
15. Test Equipment Information	10
15.1 SPEAG DASY4	10
15.2 The SAR Measurement System	11
15.3 Isotropic E-field Probe ES3DV3	13
15.4 SAM Twin Phantom	14
15.5 Device Holder for Transmitters	15
16. Detailed Test Results.....	16
16.1 Summary of Results	16
16.2 Maximum Results	16
16.3 Operation Configurations	16
16.4 Measurement procedure	17
16.5 Detailed Test Results	18
17. Identification of Samples	20
18. Photographs of EUT	21
Annex A Photographs of Test Setup	22
Annex B Tissue Simulant Liquid.....	24
Annex C SAR System Validation.....	25
Annex D Description of Test Position	28
Annex E Calibration certificate	31
Annex E.1 Probe Calibration certificate	31
Annex E.2 DAE Calibration certificate.....	42
Annex E.3 Dipole Calibration certification	47
Annex F Additional SAR Probe Validation.....	56
END OF REPORT	64

Change History

Version	Change Contents	Author	Date
V1.0	First edition	David Lee	11-3, 2010

1. Report Overview

This report details the results of testing carried out on the samples listed in section 17, the results contained in this test report do not relate to other samples of the same product. The manufacturer should ensure that all products in series production are in conformity with the product sample detailed in this report.

This report may only be reproduced and distributed in full. If the product in this test report is used in any configuration other than that detailed in the test report, the manufacturer must ensure the new configuration complies with all relevant standards and certification requirements. Any mention of SGS Shanghai Wireless Telecommunications lab or testing done by SGS Shanghai Wireless Telecommunications lab made in connection with the distribution or use of the tested product must be approved in writing by SGS Shanghai Wireless Telecommunications lab.

2. Test Lab Declaration or Comments

The customer declares that the difference between T00007-05 and T00007-03 is only the button of the front cover.

Product T00007-05 has 3 buttons and T00007-03 8 buttons. So only worstcase of the product was measured, report GSM10434850S01 for T00007-03 is referred.

3. Applicant Declaration or Comments

None

4. Full Test Report

A full test report contains, within the results section, all the applicable test cases from the certification requirements of the permanent reference documents of the listed certification bodies.

5. Partial Test Report

A partial test report contains within the results section a sub-set of all the applicable test cases from the certification requirements of the permanent reference documents of the listed certification bodies.

6. Measurement Uncertainty

Measurements and results are all in compliance with the standards listed in section 12 of this report. All measurements and results are recorded and maintained at the laboratory performing the tests and measurement uncertainties are taken into account when comparing measurements to pass/ fail criteria.

a	b1	c	d	e = f(d,k)	g	i = cxg/e	k
Uncertainty Component	Section	Tol	Prob .	Div.	Ci	1g	Vi
	in P1528	(%)	Dist.		(1g)	ui (%)	(Veff)
Probe calibration	E.2.1	6.3	N	1	1	6.3	∞
Axial isotropy	E.2.2	0.5	R	$\sqrt{3}$	$(1-c_p)^{1/2}$	0.20	∞
hemispherical isotropy	E.2.2	2.6	R	$\sqrt{3}$	$\sqrt{c_p}$	1.06	∞
Boundary effect	E.2.3	0.8	R	$\sqrt{3}$	1	0.46	∞
Linearity	E.2.4	0.6	R	$\sqrt{3}$	1	0.35	∞
System detection limit	E.2.5	0.25	R	$\sqrt{3}$	1	0.15	∞
Readout electronics	E.2.6	0.3	N	1	1	0.3	∞
Response time	E.2.7	0	R	$\sqrt{3}$	1	0	∞
Integration time	E.2.8	2.6	R	$\sqrt{3}$	1	1.5	∞
RF ambient Condition -Noise	E.6.1	3	R	$\sqrt{3}$	1	1.73	∞
RF ambient Condition - reflections	E.6.1	3	R	$\sqrt{3}$	1	1.73	∞
Probe positioning- mechanical tolerance	E.6.2	1.5	R	$\sqrt{3}$	1	0.87	∞
Probe positioning- with respect to phantom	E.6.3	2.9	R	$\sqrt{3}$	1	1.67	∞
Max. SAR evaluation	E.5.2	1	R	$\sqrt{3}$	1	0.58	∞
Test sample positioning	E.4.2	4	N	1	1	3.7	9
Device holder uncertainty	E.4.1	3.6	N	1	1	3.6	∞
Output power variation -SAR drift measurement	6.62	5	R	$\sqrt{3}$	1	2.89	∞
Phantom uncertainty (shape and thickness tolerances)	E.3.1	4	R	$\sqrt{3}$	1	2.31	∞
Liquid conductivity - deviation from target values	E.3.2	5	R	$\sqrt{3}$	0.64	1.85	∞
Liquid conductivity - measurement uncertainty	E.3.2	4	N	1	0.64	2.56	5
Liquid permittivity - deviation from target values	E.3.3	5	R	$\sqrt{3}$	0.6	1.73	∞
Liquid permittivity - measurement uncertainty	E.3.3	4	N	1	0.6	2.40	5
Combined standard uncertainty				RSS		10.71	430
Expanded uncertainty (95% CONFIDENCE INTERVAL)				K=2		21.43	

7. Testing Environment

Normal Temperature	+20 to +24 °C
Relative Humidity	35 to 60 %

8. Primary Test Laboratory

Name:	Wireless Telecommunications Laboratory SGS-CSTC Standards Technical Services(Shanghai) Co., Ltd
Address:	9F, 3rd Building, No.889, Yishan Rd, Xuhui District, Shanghai, China 200233
Telephone:	+86 (0) 21 6140 2666
Fax:	+86 (0) 21 5450 0149
Internet:	http://www.cn.sgs.com
Contact:	Mr. Peter Xue
Email:	peter.xue@sgs.com

9. Details of Applicant

Name:	TELE RADIO AB
Address:	Datavagen 21, SE-436 32 Askim, Sweden
Telephone:	+46 (0)31-748 54 60
Fax	+46 (0)31-68 54 64
Contact:	Kitty
Email:	kitty@job-tech.cn

10. Details of Manufacturer

Name:	TELE RADIO AB
Address:	Datavagen 21, SE-436 32 Askim, Sweden
Telephone:	+46 (0)31-748 54 60
Fax	+46 (0)31-68 54 64
Contact:	Kitty
Email:	kitty@job-tech.cn

11. Other testing Locations

Name:	Not Required
Address:	--
Telephone:	--
Contact:	--
Fax	--
Email:	--

12. Referenced Documents

The Equipment under Test (EUT) has been tested at SGS's (own or subcontracted) laboratories according to FCC 47CFR § 2.1093, IEEE Std C95.1-2005, IEEE1528-2003, OET Bulletin 65 Supplement C

The following table summarizes the specific reference documents such as harmonized standards or test specifications which were used for testing as SGS's (own or subcontracted) laboratories.

Identity	Document Title	Version
FCC 47CFR § 2.1093	Radiofrequency radiation exposure evaluation:portable devices	2001
IEEE Std C95.1-2005	IEEE Standard for Safety Levels with Respect to Human Exposure to Radio Frequency Electromagnetic Fields, 3 kHz to 300 GHz.	2005
IEEE1528-2003	IEEE Recommended Practice for Determining the Peak Spatial-Average Specific Absorption Rate (SAR) in the Human Head from Wireless Communications Devices: Measurement Techniques	2003
OET Bulletin 65 Supplement C	Additional Information for Evaluating Compliance of Mobile and Portable Devices with FCC Limits for Human Exposure to Radiofrequency Emissions	2001
KDB 447498 D01	Mobile and Portable Device RF Exposure Procedures and Equipment Authorization Policies	-
KDB 248227 D01	SAR Measurement Procedures for 802.11a/b/g Transmitters	-

Human Exposure	Uncontrolled Environment General Population
Spatial Peak SAR	1.60 W/kg (averaged over a mass of 1g)

Table 12-1 RF Exposure Limits

Notes:

1. Uncontrolled environments are defined as locations where there is potential exposure of individuals who have no knowledge or control of their potential exposure.

13. Primary Laboratory Accreditation Details



SHGSM

14. SGS Shanghai Wireless Telecommunications lab, Personnel

SGS Wireless Shanghai Project Management Team and list of approved Testers for SGS Wireless Shanghai.

Surname	Forename	Initials
CAI	CAI	CAICAI
Xue	Peter	PETERXUE
Xu	Anya	ANYA
Ni	Lemon	LEMONNI
Tao	Kevin	KEVINTAO
Wang	Lawrence	LAWRENCE
Zhang	Sean	SEANZH
Ruan	Roger	ROGER
Zhang	Zenger	ZENGER
Tang	Eva	EVATANG
Ho	James	JAMESHO
Tang	Kenny	KENNY
Hailiang	Cai	HAILIANG
Nie	Neo	Neo
Gong	Tina	Tina
Nie	Marina	Marina
Xu	Jesse	Jesse
Wang	Willam	Willam
Lee	David	David
Liu	Magi	Magi

Version 2010-09-10

15. Test Equipment Information

15.1 SPEAG DASY4

Test Platform	SPEAG DASY4 Professional			
Location	SGS SH Lab #8			
Manufacture	SPEAG			
Description	SAR Test System (Frequency range 300MHz-3GHz) 835, 900, 1800, 1900, 2000, 2450 frequency band HAC Extension			
Software Reference	DASY4: V4.7 Build 80 SEMCAD: V1.8 Build 186			
Hardware Reference				
Equipment	Model	Serial Number	Calibration Date	Due date of calibration
Robot	RX90L	F03/5V32A1/A01	n/a	n/a
Phantom	SAM 12	TP-1283	n/a	n/a
DAE	DAE3	569	2009-11-18	2010-11-17
E-Field Probe	ES3DV3	3088	2009-11-19	2010-11-18
Validation Kits	D2450V2	733	2009-11-25	2010-11-24
Agilent Network Analyzer	E5071B	MY42100549	2009-11-25	2010-11-24
RF Bi-Directional Coupler	ZABDC20-252H	n/a	2010-05-21	2011-05-20
Agilent Signal Generator	E4438C	14438CATO-19719	2009-11-30	2010-11-29
Mini-Circuits Preamplifier	ZHL-42	D041905	2009-11-30	2010-11-29
Agilent Power Meter	E4416A	GB41292095	2009-11-25	2010-11-24
Agilent Power Sensor	8481H	MY41091234	2009-11-25	2010-11-24
R&S Power Sensor	NRP-Z92	100025	2010-04-12	2011-04-11
R&S Universal Radio Communication Tester	CMU200	103633	2009-11-26	2010-11-25

15.2 The SAR Measurement System

A photograph of the SAR measurement System is given in Fig. 15-1.

This SAR Measurement System uses a Computer-controlled 3-D stepper motor system (Speag Dasy 4 professional system). A Model ES3DV3 3088 E-field probe is used to determine the internal electric fields. The SAR can be obtained from the equation $SAR = \sigma (|E|^2) / \rho$ where σ and ρ are the conductivity and mass density of the tissue-simulant.

The DASY4 system for performing compliance tests consists of the following items:

A standard high precision 6-axis robot (Stabile RX family) with controller, teach pendant and software. An arm extension is for accommodation the data acquisition electronics (DAE).

A dosimetric probe, i.e., an isotropic E-field probe optimized and calibrated for usage in tissue simulating liquid. The probe is equipped with an optical surface detector system.

Data acquisition electronics (DAE) which performs the signal amplification, signal multiplexing, AD-conversion, offset measurements, mechanical surface detection, collision detection, etc. The unit is battery powered with standard or rechargeable batteries. The signal is optically transmitted to the EOC.

The Electro-optical converter (EOC) performs the conversion between optical and electrical of the signals for the digital communication to DAE and for the analog signal from the optical surface detection. The EOC is connected to the measurement server.

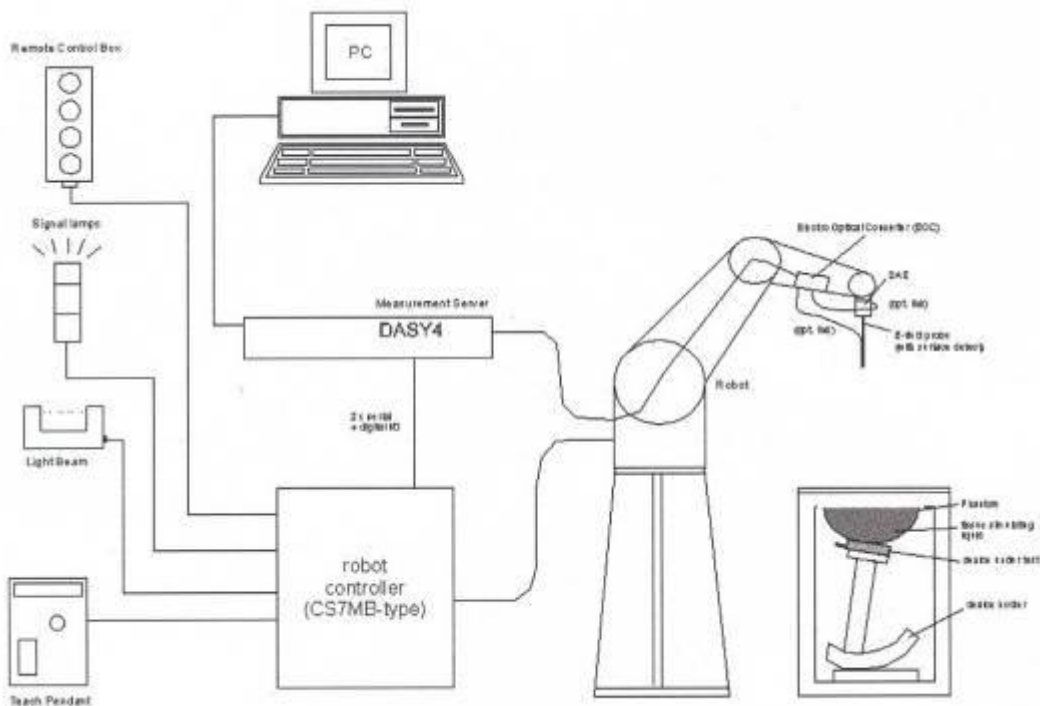

Fig. 15-1 SAR System Configuration

- Y The function of the measurement server is to perform the time critical tasks such as signal filtering, control of the robot operation and fast movement interrupts.
- Y A probe alignment unit which improves the (absolute) accuracy of the probe positioning.
- Y A computer operating Windows 2000.

- ÿ DASY4 software.
- ÿ Remote control with teach pendant and additional circuitry for robot safety such as warning lamps, etc.
- ÿ The SAM twin phantom enabling testing left-hand, right-hand and BodyWorn usage.
- ÿ The device holder for handheld mobile phones.
- ÿ Tissue simulating liquid mixed according to the given recipes.
- ÿ Validation dipole kits allowing to validating the proper functioning of the system

15.3 Isotropic E-field Probe ES3DV3

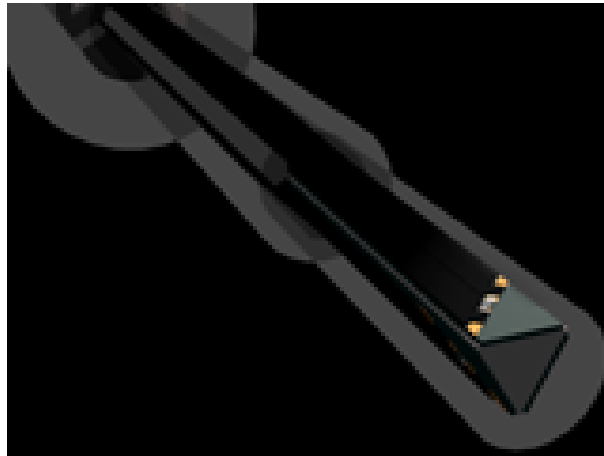

Fig. 15-2 E-field Probe

Construction	Symmetrical design with triangular core Interleaved sensors Built-in shielding against static charges PEEK enclosure material (resistant to organic solvents, e.g., DGBE)
Calibration	Basic Broad Band Calibration in air Conversion Factors (CF) for HSL 900 and HSL 1810 Additional CF for other liquids and frequencies upon request
Frequency	10 MHz to 4 GHz; Linearity: ± 0.2 dB (30 MHz to 4 GHz)
Directivity	± 0.2 dB in HSL (rotation around probe axis) ± 0.3 dB in tissue material (rotation normal to probe axis)
Dynamic Range	5 μ W/g to > 100 mW/g; Linearity: ± 0.2 dB
Dimensions	Overall length: 330 mm (Tip: 20 mm) Tip diameter: 3.9 mm (Body: 12 mm) Distance from probe tip to dipole centers: 2.0 mm
Application	General dosimetry up to 4 GHz Dosimetry in strong gradient fields Compliance tests of mobile phones

15.4 SAM Twin Phantom

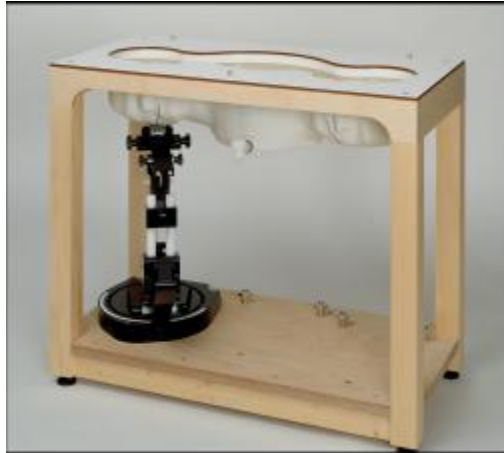

Fig. 15-3 SAM Twin Phantom

The SAM twin phantom is a fiberglass shell phantom with 2mm shell thickness (except the ear region where shell thickness increases to 6mm). It has three measurement areas:

- Left hand
- Right hand
- Flat phantom

A white cover is provided to tap the phantom during off-periods to prevent water evaporation and changes in the liquid parameters. Free space scans of devices on the cover are possible.

On the phantom top, three reference markers are provided to identify the phantom position with respect to the robot.

Phantom specification:

Description	The shell corresponds to the specifications of the Specific Anthropomorphic Mannequin (SAM) phantom defined in IEEE 1528-2003, CENELEC 50361 and IEC 62209. It enables the dosimetric evaluation of left and right hand phone usage as well as body mounted usage at the flat phantom region. A cover prevents evaporation of the liquid. Reference markings on the phantom allow the complete setup of all predefined phantom positions and measurement grids by teaching three points with the robot.
Shell Thickness	2+0.2mm, Center ear point: 6+0.2mm
Filling Volume	Approx.25 liters
Dimensions	Length: 1000mm, Width: 500mm, Height: 850mm

15.5 Device Holder for Transmitters



Fig. 15-4 Device Holder for Transmitters

The SAR in the phantom is approximately inversely proportional to the square of the distance between the source and the liquid surface. For a source in 5mm distance, a positioning uncertainty of $\pm 0.5\text{mm}$ would produce a SAR uncertainty of $\pm 20\%$. An accurate device positioning is therefore crucial for accurate and repeatable measurements. The positions, in which the devices must be measured, are defined by the standards.

The DASY device holder is designed to cope with different positions given in the standard. It has two scales for the device rotation (with respect to the body axis) and the device inclination (with respect to the line between the ear reference points). The rotation centers for both scales are the ear reference point (ERP). Thus the device needs no repositioning when changing the angles.

The DASY device holder has been made out of low-loss POM material having the following dielectric parameters: relative permittivity $\epsilon = 3$ and loss tangent $\tan \delta = 0.02$. The amount of dielectric material has been reduced in the closest vicinity of the device, since measurements have suggested that the influence of the clamp on the test results could thus be lowered.

16. Detailed Test Results

16.1 Summary of Results

16.1.1 Measurement of RF conducted Power

Unit: dBm

Mode			
Band	Channel	Frequency	Power
2450 band	11	2405MHz	5.75
	19	2445MHz	17.3
	26	2480MHz	5.54

16.1.2 Measurement of SAR average value

Band	EUT Position	Test Configuration	Averaged SAR over 1g (W/kg)			SAR limit 1g (W/kg)	Verdict
			CH11	CH19	CH26		
			2405MHz	2445MHz	2480MHz		
2450band	Body Worn	Front of EUT facing phantom	0.087	--	--	1.6	Passed

16.2 Maximum Results

The maximum measured SAR values for BodyWorn configuration are given in section 16.2.1.

16.2.1 BodyWorn Configuration

Frequency Band	EUT Position	Conducte d Power (dBm)	SAR, Averaged over 1g (W/kg)	Power Drift (dB)	SAR limit (W/kg)	Verdict
2450band	Front of EUT facing phantom/Low	5.75	0.087	-0.320	1.6	Passed

16.2.2 Maximum Drift

Maximum Drift during measurement	0.320
----------------------------------	-------

16.2.3 Measurement Uncertainty

Extended Uncertainty (k=2) 95%	21.43%
--------------------------------	--------

16.3 Operation Configurations

The EUT is measured using chipset based test mode software to ensure the results are consistent and reliable.

- The 802.11b mode is tested at 11(2405MHz),19(2445MHz),26(2480MHz) channels.

SHGSM

2. The EUT is at the lowest data rate during test.

3. Test reduction has been adopted according to conducted output power and produced SAR level:

Low and High channel SAR are optional if SAR value produced in the middle channel is 3dB lower than the applicable SAR limit;

4. The (max.cube) labeling indicates that during the grid scanning an additional peak was found which within 2dB of the highest peak

16.4 Measurement procedure

Step 1: Power reference measurement

The SAR measurement was taken at a selected spatial reference point to monitor power variations during testing. This fixed location point was measured and used as a reference value.

Step 2: Area scan

The SAR distribution at the exposed side of the head was measured at a distance of 4mm from the inner surface of the shell. The area covered the entire dimension of the head and the horizontal grid spacing was 15mm*15mm or 10mm*10mm. Based on the area scan data, the area of the maximum absorption was determined by spline interpolation.

Step 3: Zoom scan

Around this point, a volume of 30mm*30mm*30mm (fine resolution volume scan, zoom scan) was assessed by measuring 7*7*7 points. On this basis of this data set, the spatial peak SAR value was evaluated with the following procedure:

The data at the surface was extrapolated, since the center of the dipoles is 2.0mm away from the tip of the probe and the distance between the surface and the lowest measuring point is 1.2mm. (This can be variable. Refer to the probe specification) the extrapolation was based on a least square algorithm. A polynomial of the fourth order was calculated through the points in z-axes. This polynomial was then used to evaluate the points between the surface and the probe tip. The maximum interpolated value was searched with a straight-forward algorithm. Around this maximum the SAR values averaged over the spatial volumes (1g or 10g) were computed using the 3D-Spline interpolation algorithm. The volume was integrated with the trapezoidal algorithm. One thousand points (10*10*10) were interpolated to calculate the average. All neighboring volumes were evaluated until no neighboring volume with a higher average value was found.

Step 4: Power reference measurement (drift)

The SAR value at the same location as in step 1 was again measured. (If the value changed by more than 5%, the evaluation should be done repeatedly)

16.5 Detailed Test Results

16.5.1 FrontSide-Low

Date/Time: 2010-10-20 9:01:12

Test Laboratory: **SGS-GSM**

FCC OET65 Protocol (Body Worn) 3 KEY Front Low

DUT: GLEMO; Type: 2450 band; Serial: 10153

Communication System: **CW**; Frequency: **2405 MHz**; Duty Cycle: **1:1**

Medium: HSL2450-Body Medium parameters used: $f = 2405 \text{ MHz}$; $\sigma = 1.94 \text{ mho/m}$; $\epsilon_r = 52.3$; $\rho = 1000 \text{ kg/m}^3$

Phantom section: **Flat Section**

DASY4 Configuration:

- Probe: ES3DV3 - SN3088; ConvF(4.2, 4.2, 4.2); Calibrated: 2009-11-19
- Sensor-Surface: 4mm (Mechanical Surface Detection)
- Electronics: DAE3 Sn569; Calibrated: 2009-11-18
- Phantom: SAM 12; Type: SAM V4.0; Serial: TP-1283
- Measurement SW: DASY4, V4.7 Build 80; Postprocessing SW: SEMCAD, V1.8 Build 186

Body Worn - Low Front/Area Scan (61x101x1): **Measurement grid: dx=15mm, dy=15mm**

Maximum value of SAR (interpolated) = 0.089 mW/g

Body Worn - Low Front/Zoom Scan (7x7x7)/Cube 0: **Measurement grid: dx=5mm, dy=5mm, dz=5mm**

Reference Value = 2.56 V/m; Power Drift = 0.320 dB

Peak SAR (extrapolated) = 0.206 W/kg

SAR(1 g) = 0.087 mW/g; SAR(10 g) = 0.035 mW/g

Maximum value of SAR (measured) = 0.101 mW/g

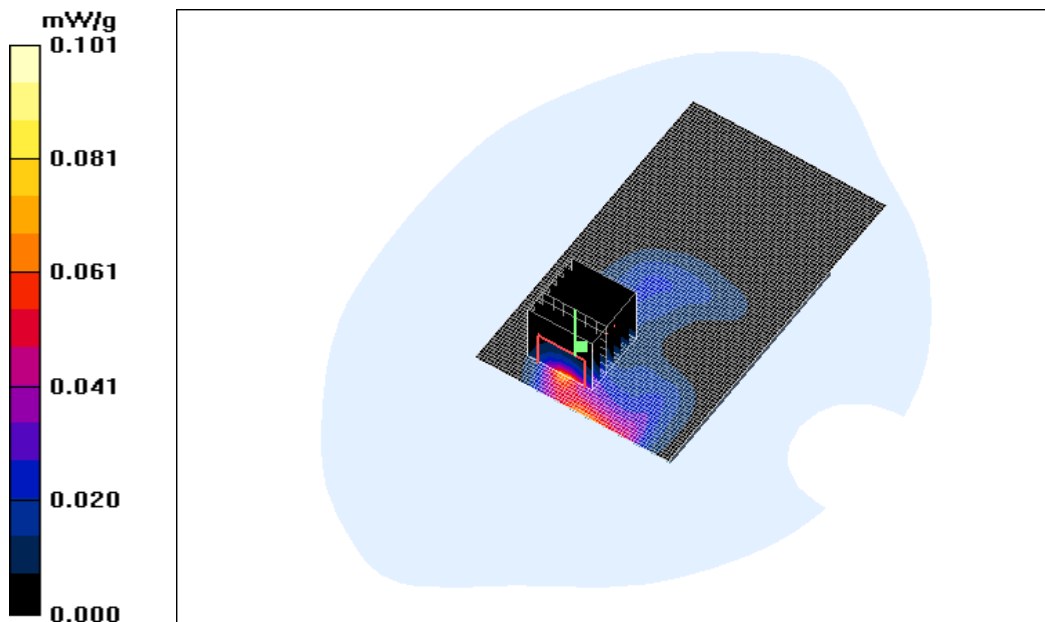

SHGSM

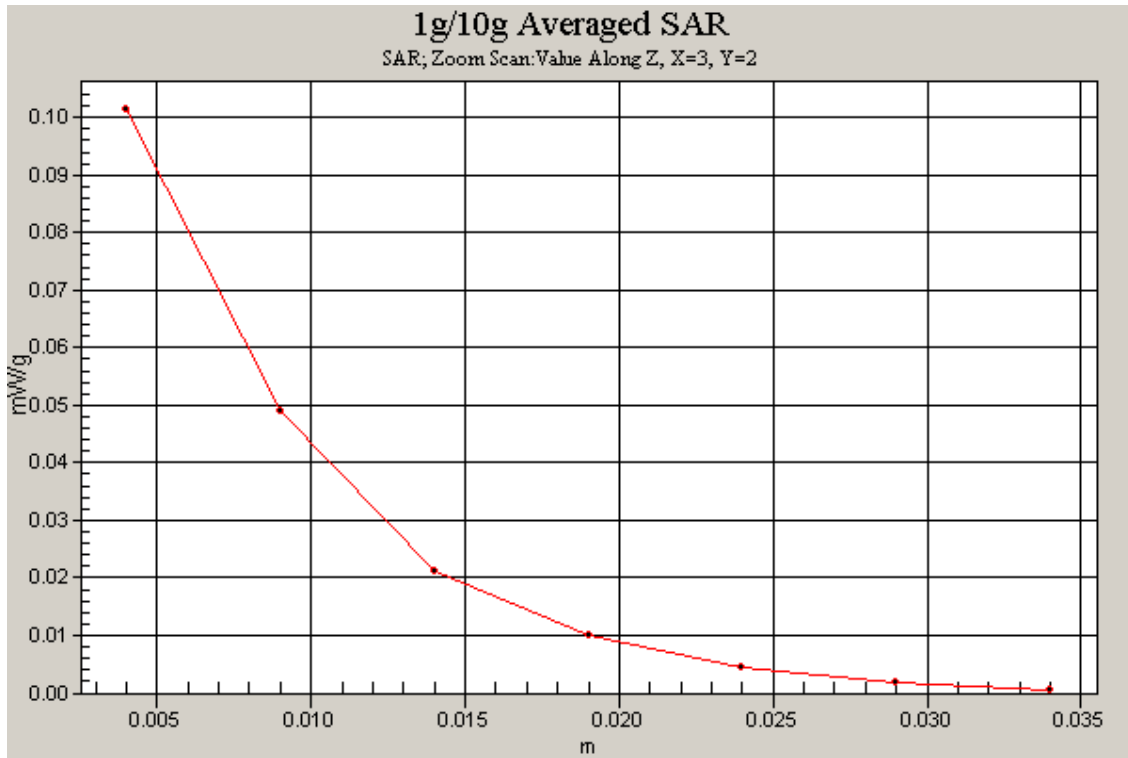

17. Identification of Samples

Product Name	TRANSMITTER
Marketing Name	T00007-05
Final Hardware Version	--
Final Software Version	--
Normal Voltage	4.5V
High Voltage	--
Low Voltage	--
Antenna Type	Inner antenna
Frequency Bands	Tx/Rx: 2.405~2.480GHz
Reference Number	GSM10434850S02
IMEI	10153
Date of receipt	09-02,2010
Date of Testing Start	10-20,2010
Date of Testing End	10-20,2010

18. Photographs of EUT



Fig.17-1 Front View



Fig.17-2 Back View

Annex A Photographs of Test Setup

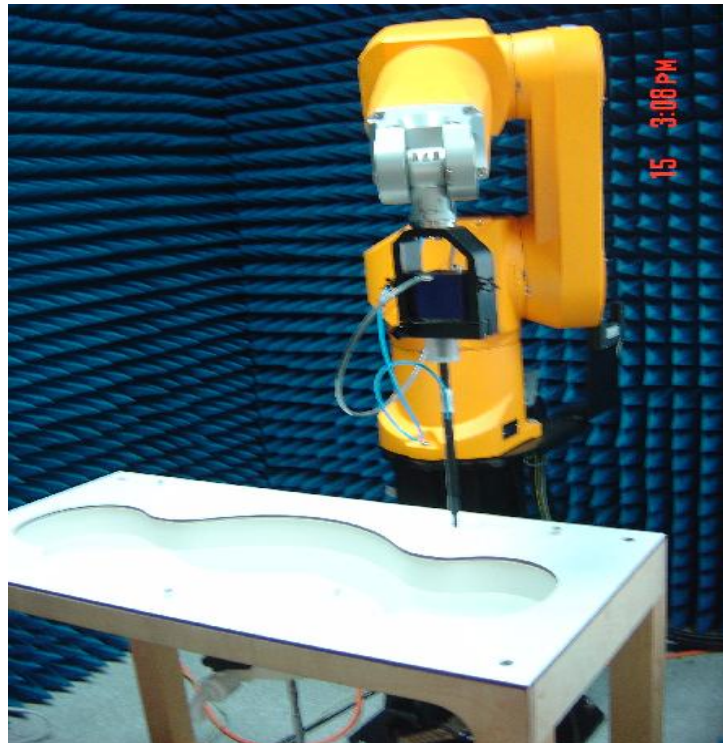

Fig.A-1 Photograph of the SAR measurement System

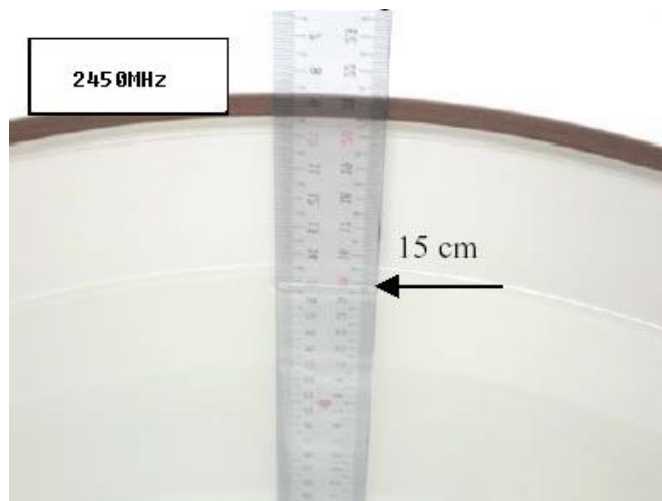

Fig.A-2 Photograph of the Tissue Simulant
Liquid depth 15cm for Body Worn



Fig.A-3a Photograph of Front side of the EUT status



Fig.A-3b Photograph of Back side of the EUT status

Annex B Tissue Simulant Liquid

Annex B.1 Recipes for Tissue Simulant Liquid

The following tables give the recipes for tissue simulating liquids to be used in different frequency bands.

Frequency (MHz)	835		900		1800-2000		2450	
Tissue Type	Head	Body	Head	Body	Head	Body	Head	Body
Ingredient (% by weight)								
Water	40.30	50.75	40.30	50.75	55.24	70.17	62.7	73.26
Salt (NaCl)	1.38	0.94	1.38	0.94	0.31	0.39	0.5	0.04
Sucrose	57.90	48.21	57.90	48.21	0	0	0	0
HEC	0.24	0	0.24	0	0	0	0	0
Bactericide	0.18	0.10	0.10	0.10	0	0	0	0
DGBE	0	0	0	0	44.45	29.44	36.8	26.7
Measurement dielectric parameters								
Dielectric Constant	41.9	55.0	41.1	54.5	39.2	53.2	39.8	52.5
Conductivity (S/m)	0.93	0.97	1.04	1.06	1.45	1.59	1.88	1.78
Target values								
Dielectric Constant	41.5	55.2	41.5	55.0	40.0	53.3	39.2	52.7
Conductivity (S/m)	0.90	0.97	0.97	1.05	1.40	1.52	1.80	1.95
Salt: 99+% Pure Sodium Chloride					Sucrose: 98+% Pure Sucrose			
Water: De-ionized, 16 MΩ ⁺ resistivity					HEC: Hydroxyethyl Cellulose			
DGBE: 99+% Di(ethylene glycol) butyl ether, [2-(2-butoxyethoxy)ethanol]								

Table B-1 Recipe of Tissue Simulat Liquid

Annex B.2 Measurement for Tissue Simulant Liquid

The dielectric properties for this Tissue Simulant Liquids were measured by using the Agilent Model 85070D Dielectric Probe (rates frequency band 200 MHz to 20 GHz) in conjunction with Agilent E5071B Network Analyzer (300 KHz-8500 MHz). The Conductivity (σ) and Permittivity (ρ) are listed in Table 1. For the SAR measurement given in this report. The temperature variation of the Tissue Simulant Liquids was 22±2°C.

Frequency (MHz)	Tissue Type	Limit/Measured	Permittivity (ρ)	Conductivity (σ)	Temp (°C)
2450	Body	Recommended Limit	52.7±5% (50.07~55.34)	1.95±5% (1.85~2.05)	22±2
		Measured, 10-20,2010	51.63	2.01	21.7

Table B-2 Measurement result of Tissue electric parameters

Annex C SAR System Validation

The microwave circuit arrangement for system verification is sketched in Fig. C-1. The daily system accuracy verification occurs within the flat section of the SAM phantom. A SAR measurement was performed to see if the measured SAR was within +/- 10% from the target SAR values. These tests were done at 835&1900MHz. The tests were conducted on the same days as the measurement of the EUT. The obtained results from the system accuracy verification are displayed in the table C-1 (A power level of 250mw was input to the dipole antenna). During the tests, the ambient temperature of the laboratory was in the range 22°C, the relative humidity was in the range 60% and the liquid depth above the ear reference points was above 15 cm in all the cases. It is seen that the system is operating within its specification, as the results are within acceptable tolerance of the reference values.

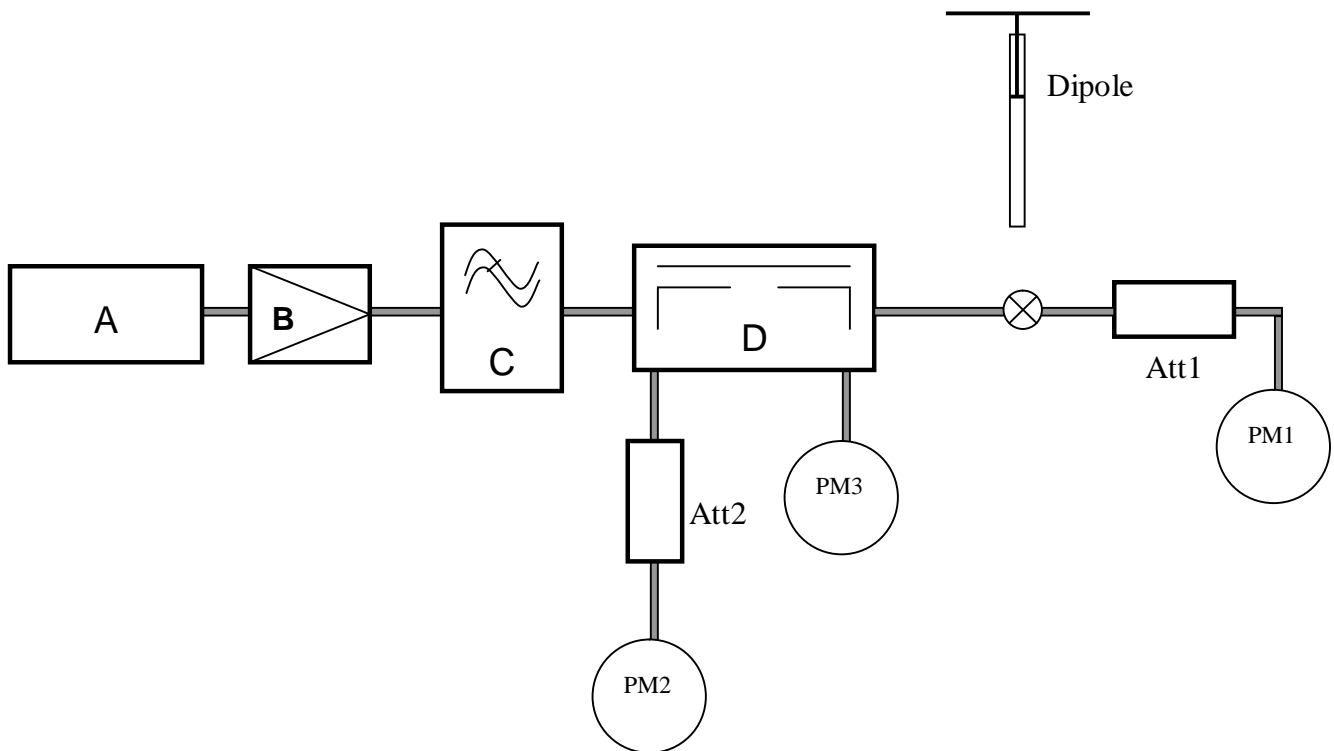

Fig. C-1 the microwave circuit arrangement used for SAR system verification

- A. Agilent E4438C Signal Generator
- B. Mini-Circuit ZHL-42 Preamplifier
- C. Mini-Circuit VLF-2500+ Low Pass Filter
- D. Mini-Circuits ZABDC20-252H-N+ Bi-DIR Coupling
- PM1. Power Sensor NRP-Z92
- PM2. Agilent Model E4416A Power Meter
- PM3. Power Sensor NRP-Z92

Validation Kit	Frequency (MHz)	Tissue Type	Limit/Measurement		
			Condition	Recommended/Measured	1g
D2450V2	2450	Body	Normalized to 1mW(for nominal Head TSL parameters)	Recommended Limit	50.28±10% (45.25-55.31)
			Normalized to 1W(for nominal Head TSL parameters)	-	52.23
			250mW input power	Measured, 10-20, 2010	13.3

Table C-1 SAR System Validation Result

System Validation for 2450MHz-Body

Date/Time: 2010-10-20 8:14:22

Test Laboratory: SGS-GSM

System Performance Check at 2450MHz

DUT: Dipole 2450 MHz; Type: D2450V2; Serial: D2450V2 - SN:733

Communication System: CW; Frequency: 2450 MHz; Duty Cycle: 1:1

Medium: HSL2450-Body Medium parameters used: $f = 2450$ MHz; $\sigma = 2.01$ mho/m; $\epsilon_r = 51.6$; $\rho = 1000$ kg/m³

Phantom section: Flat Section

DASY4 Configuration:

- Probe: ES3DV3 - SN3088; ConvF(4.2, 4.2, 4.2); Calibrated: 2009-11-19
- Sensor-Surface: 4mm (Mechanical Surface Detection)
- Electronics: DAE3 Sn569; Calibrated: 2009-11-18
- Phantom: SAM 12; Type: SAM V4.0; Serial: TP-1283
- Measurement SW: DASY4, V4.7 Build 80; Postprocessing SW: SEMCAD, V1.8 Build 186

d=10mm, Pin=250mW/Area Scan (61x101x1): **Measurement grid: dx=15mm, dy=15mm**

Maximum value of SAR (interpolated) = 16.6 mW/g

d=10mm, Pin=250mW/Zoom Scan (7x7x7) (7x7x7)/Cube 0: **Measurement grid: dx=5mm, dy=5mm, dz=5mm**

Reference Value = 51.3 V/m; Power Drift = 0.019 dB

Peak SAR (extrapolated) = 28.3 W/kg

SAR(1 g) = 13.3 mW/g; SAR(10 g) = 6.06 mW/g

Maximum value of SAR (measured) = 15.1 mW/g

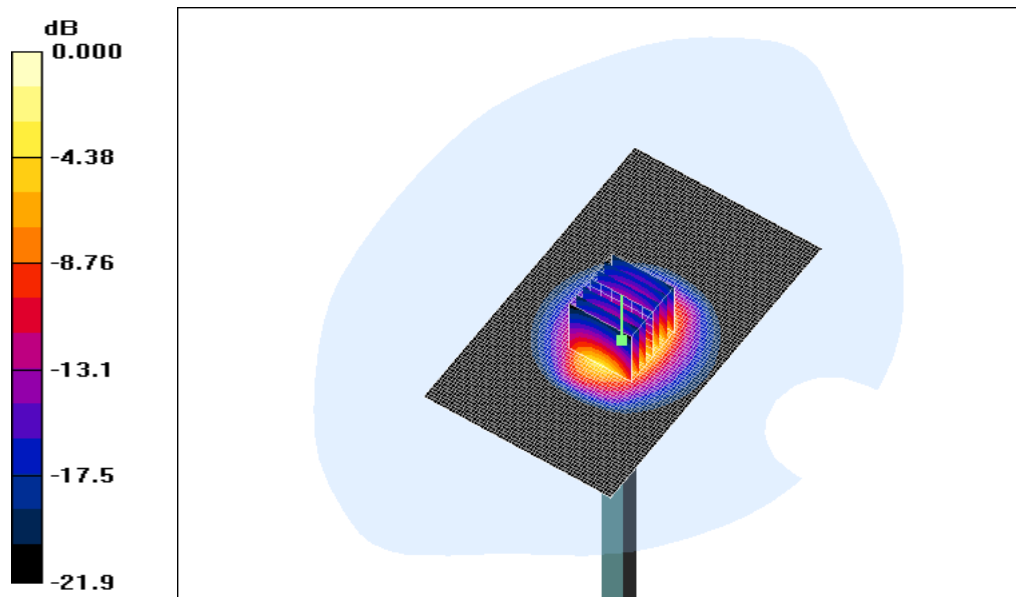

0 dB = 15.1mW/g

SHGSM

Annex D Description of Test Position

Annex D.1 SAM Phantom Shape

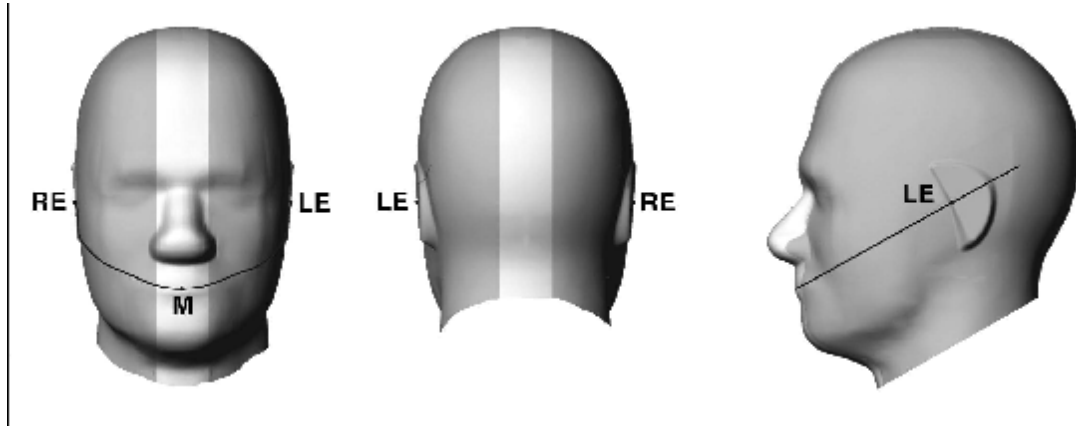

Figure D-1 front, back, and side views of SAM (model for the phantom shell). Full-head model is for illustration purposes only-procedures in this recommended practice are intended primarily for the phantom setup of Figure D-2. Note: The center strip including the nose region has a different thickness tolerance.

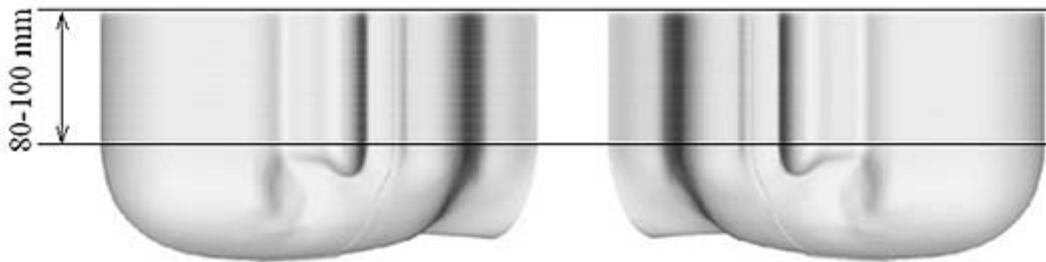

Figure D-2 Sagittally bisected phantom with extended perimeter (shown placed on its side as used for SAR measurements)

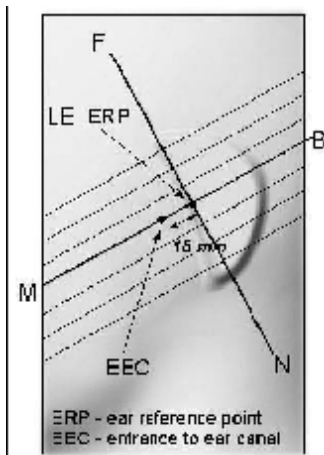

Figure D-3 Close-up side view of phantom showing the ear region, N-F and B-M lines, and seven cross-sectional plane locations

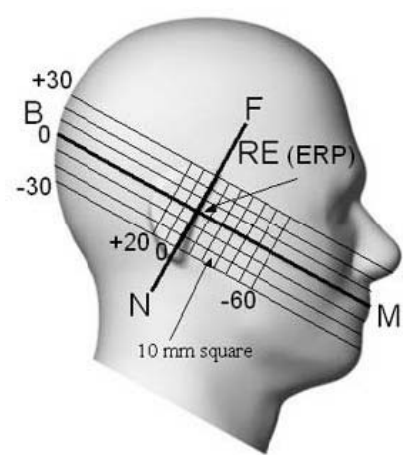

Figure D-4 Side view of the phantom showing relevant markings and seven cross-sectional plane locations

Annex D.2 EUT constructions

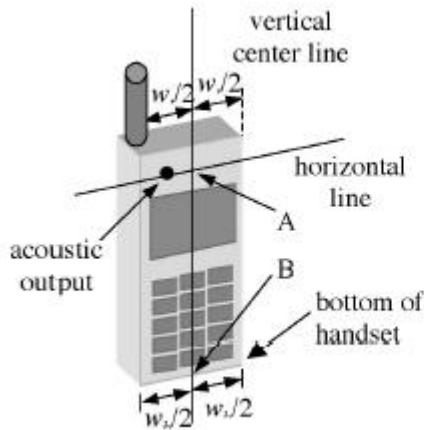

Figure D-5a Handset vertical and horizontal reference lines-“fixed case”

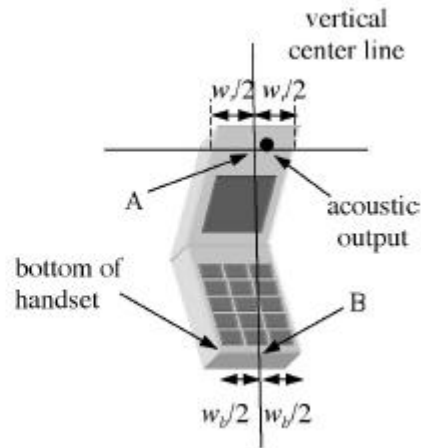

Figure D-5b Handset vertical and horizontal reference lines-“clam-shell case”

Annex D.3 Definition of the “cheek” position

- a) Position the device with the vertical centre line of the body of the device and the horizontal line crossing the centre of the ear piece in a plane parallel to the sagittal plane of the phantom ("initial position" see Figure 1-7). While maintaining the device in this plane, align the vertical centre line with the reference plane containing the three ear and mouth reference points (M, RE and LE) and align the centre of the ear piece with the line RE-LE;
- b) Translate the mobile phone box towards the phantom with the ear piece aligned with the line LE-RE until the phone touches the ear. While maintaining the device in the reference plane and maintaining the phone contact with the ear, move the bottom of the box until any point on the front side is in contact with the cheek of the phantom or until contact with the ear is lost.

Annex D.4 Definition of the “tilted” position

- a) Position the device in the “cheek” position described above;
- b) While maintaining the device in the reference plane described above and pivoting against the ear, move it outward away from the mouth by an angle of 15 degrees or until contact with the ear is lost.

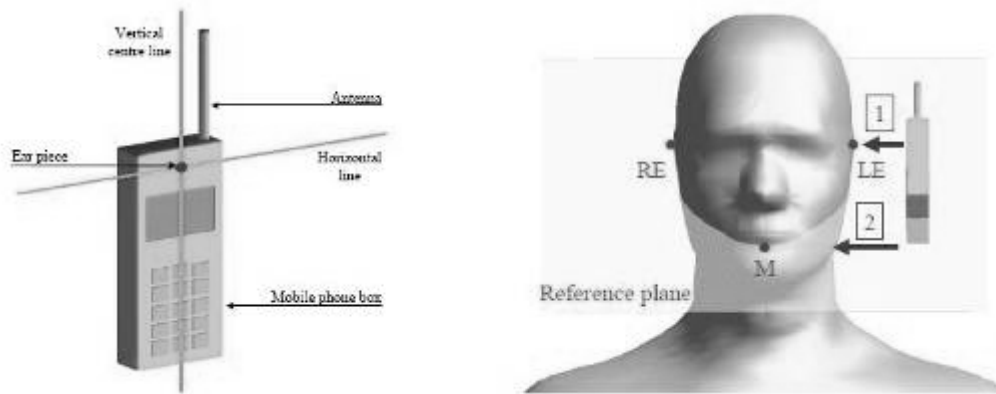

Figure D-6 Definition of the reference lines and points, on the phone and on the phantom and initial position

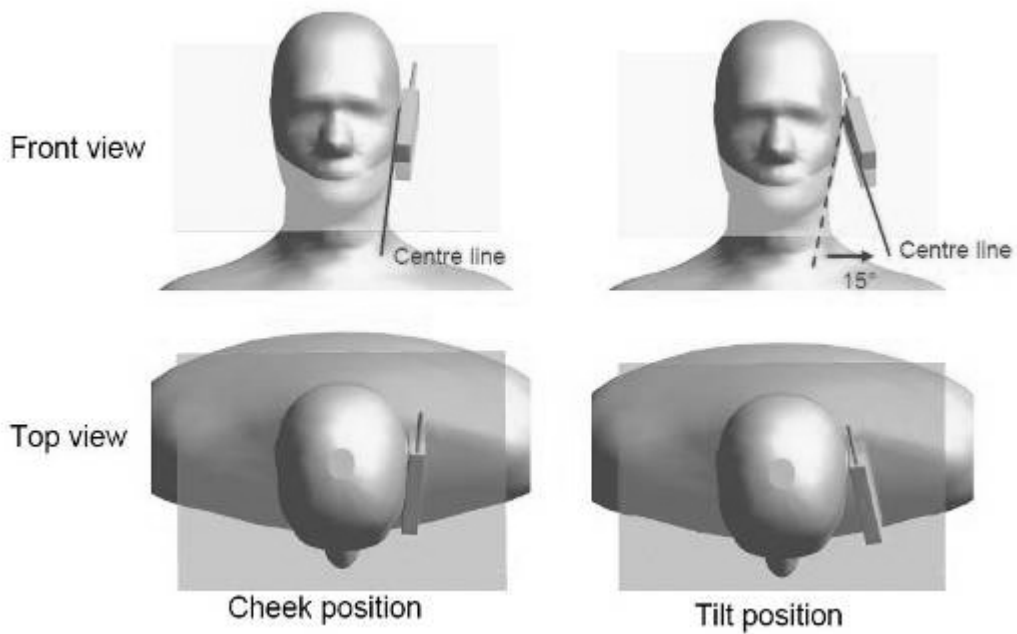

Figure D-7 “Cheek” and “tilt” positions of the mobile phone on the left side

Annex E Calibration certificate
 Annex E.1 Probe Calibration certificate

Calibration Laboratory of
 Schmid & Partner
 Engineering AG
 Zeughausstrasse 43, 8004 Zurich, Switzerland



S Schweizerischer Kalibrierdienst
 C Service suisse d'étalonnage
 S Servizio svizzero di taratura
 S Swiss Calibration Service

Accredited by the Swiss Accreditation Service (SAS)
 The Swiss Accreditation Service is one of the signatories to the EA
 Multilateral Agreement for the recognition of calibration certificates

Accreditation No.: SCS 108

Client: SGS SH (Auden)

Certificate No: ES3-3088_Nov09

CALIBRATION CERTIFICATE			
Object	ES3DV3 - SN:3088		
Calibration procedure(s)	QA CAL-01.v3, QA CAL-23.v3 and QA CAL-25.v2 Calibration procedure for dosimetric E-field probes		
Calibration date:	November 19, 2009		
<p>This calibration certificate documents the traceability to national standards, which realize the physical units of measurements (SI). The measurements and the uncertainties with confidence probability are given on the following pages and are part of the certificate.</p> <p>All calibrations have been conducted in the closed laboratory facility: environment temperature (22 ± 3°C and humidity < 70%).</p> <p>Calibration Equipment used (MATE critical for calibration):</p>			
Primary Standards	ID #	Cal Date (Certificate No.)	Scheduled Calibration
Power meter F4419R	QR41262874	1-Apr-08 (No. 217-31030)	Apr-10
Power sensor E4412A	MY41485277	1-Apr-08 (No. 217-31030)	Apr-10
Power sensor E4412A	MY41488087	1-Apr-08 (No. 217-31030)	Apr-10
Reference 3 dB Attenuator	SN: 85054 (3c)	31-Mar-09 (No. 217-01026)	Mar-10
Reference 20 dB Attenuator	SN: 85066 (20b)	31-Mar-09 (No. 217-01026)	Mar-10
Reference 30 dB Attenuator	SN: 85129 (30b)	31-Mar-09 (No. 217-01027)	Mar-10
Reference Probe ES3DV2	SN: 3013	2-Jan-06 (No. ES3-3013_Jan06)	Jan-10
DAE4	SN: 660	28-Sep-09 (No. DAE4-660_Sep09)	Sep-10
Secondary Standards	ID #	Check Date (in house)	Scheduled Check
RF generator HP 8548C	US3642U01/U0	4-Aug-99 (in house check Oct-09)	In house check: Oct-11
Network Analyzer HP 8723E	US3739088	18-Oct-01 (in house check Oct-05)	In house check: Oct-10
Calibrated by:	Name Jeton Kasrab	Function Laboratory Technician	Signature
Approved by:	Name Kolja Polovic	Function Technical Manager	Signature
			Issued: November 24, 2009
This calibration certificate shall not be reproduced except in full without written approval of the laboratory.			

Certificate No. ES3-3088_Nov09

Page 1 of 11

Calibration Laboratory of
Schmid & Partner
 Engineering AG
 Zeughausstrasse 43, 8004 Zurich, Switzerland



S Schweizerischer Kalibrierdienst
C Service suisse d'étalonnage
S Servizio svizzero di taratura
S Swiss Calibration Service

Accredited by the Swiss Accreditation Service (SAS)
 The Swiss Accreditation Service is one of the signatories to the EA
 Multilateral Agreement for the recognition of calibration certificates

Accreditation No.: **SCS 108**

Glossary:

TSL	issue simulating liquid
NORM _{x,y,z}	sensitivity in free space
ConvF	sensitivity in TSL / NORM _{x,y,z}
DCP	diode compression point
CF	crest factor (1/duty_cycle) of the RF signal
A, B, C	modulation dependent linearization parameters
Polarization φ	φ rotation around probe axis
Polarization θ	θ rotation around an axis that is in the plane normal to probe axis (at measurement center), i.e., θ = 0 is normal to probe axis

Calibration is Performed According to the Following Standards:

- a) IEEE Std 1528-2003, "IEEE Recommended Practice for Determining the Peak Spatial-Averaged Specific Absorption Rate (SAR) in the Human Head from Wireless Communications Devices: Measurement Techniques", December 2003
- b) IEC 62209-1, "Procedure to measure the Specific Absorption Rate (SAR) for hand-held devices used in close proximity to the ear [frequency range of 300 MHz to 3 GHz]", February 2005

Methods Applied and Interpretation of Parameters:

- **NORM_{x,y,z}**: Assessed for E-field polarization θ = 0 (f ≤ 900 MHz in TEM-cell; f > 1800 MHz: R22 waveguide). NORM_{x,y,z} are only intermediate values, i.e., the uncertainties of NORM_{x,y,z} does not effect the E²-field uncertainty inside TSL (see below ConvF).
- **NORM(θ)_{x,y,z} = NORM_{x,y,z} * frequency_response** (see Frequency Response Chart). This linearization is implemented in DASY4 software versions later than 4.2. The uncertainty of the frequency response is included in the stated uncertainty of ConvF.
- **DCP_{x,y,z}**: DCP are numerical linearization parameters assessed based on the data of power sweep with CW signal (no uncertainty required). DCP does not depend on frequency nor media.
- **A_{x,y,z}; B_{x,y,z}; C_{x,y,z}; VR_{x,y,z}**: A, B, C are numerical linearization parameters assessed based on the data of power sweep for specific modulation signal. The parameters do not depend on frequency nor media. VR is the maximum calibration range expressed in RMS voltage across the diode.
- **ConvF and Boundary Effect Parameters**: Assessed in flat phantom using E-field (or Temperature Transfer Standard for f ≤ 800 MHz) and inside waveguide using analytical field distributions based on power measurements for f > 800 MHz. The same setups are used for assessment of the parameters applied for boundary compensation (alpha, depth) of which typical uncertainty values are given. These parameters are used in DASY4 software to improve probe accuracy close to the boundary. The sensitivity in TSL corresponds to NORM_{x,y,z} * ConvF whereby the uncertainty corresponds to that given for ConvF. A frequency dependent ConvF is used in DASY version 4.4 and higher which allows extending the validity from ± 50 MHz to ± 100 MHz.
- **Spherical isotropy (3D deviation from isotropy)**: In a field of low gradients realized using a fat phantom exposed by a patch antenna.
- **Sensor Offset**: The sensor offset corresponds to the offset of virtual measurement center from the probe tip (on probe axis). No tolerance required.

ES3DV3 SN:3088

November 19, 2009

Probe ES3DV3

SN:3088

Manufactured:	July 20, 2005
Last calibrated:	December 22, 2008
Recalibrated:	November 19, 2009

Calibrated for DASY Systems

(Note: non-compatible with DASY2 system!)

Certificate No: E53-3C88_Nov09

Page 3 of 11

ES3DV3 SN:3088

November 19, 2009

DASY - Parameters of Probe: ES3DV3 SN:3088

Basic Calibration Parameters

	Sensor X	Sensor Y	Sensor Z	Unc (k=2)
Norm $(\mu V/(\sqrt{V/m})^2)^{\frac{1}{2}}$	1.32	1.27	1.26	$\pm 10.1\%$
DCP $(mV)^{\frac{1}{2}}$	94.2	94.4	94.3	

Modulation Calibration Parameters

UID	Communication System Name	PAR		A	B	C	VR	Unc ^e (k=2)
				dB	dBuV		mV	
10000	CW	0.00	X	0.00	0.00	1.00	300.0	$\pm 1.5\%$
			Y	0.00	0.00	-1.00	300.0	
			Z	0.00	0.00	1.00	300.0	

The reported uncertainty of measurement is stated as the standard uncertainty of measurement multiplied by the coverage factor k=2, which for a normal distribution corresponds to a coverage probability of approximately 95%.

^a The uncertainties of Norm X, Y, Z do not affect the E² field uncertainty inside TEL (see Pages 6 and 8).

^d Numerical linearization parameter: uncertainty not required.

^e Uncertainty is determined using the maximum deviation from linear response applying rectangular distribution and is expressed for the square of the field value.

ES3DV3 SN:3088

November 19, 2009

DASY - Parameters of Probe: ES3DV3 SN:3088

Calibration Parameter Determined in Head Tissue Simulating Media

f [MHz]	Validity [MHz] [Ⓒ]	Permittivity	Conductivity	ConvF X	ConvF Y	ConvF Z	Alpha	Depth Unc (k-Z)
900	± 50 / ± 100	41.5 ± 5%	0.97 ± 5%	5.84	5.84	5.84	0.90	1.06 ± 11.0%
1810	± 50 / ± 100	40.0 ± 5%	1.40 ± 5%	5.00	5.00	5.00	0.38	1.75 ± 11.0%
1900	+ 50 / + 100	40.0 ± 5%	1.40 ± 5%	4.97	4.97	4.97	0.48	1.53 ± 11.0%
2450	± 50 / ± 100	39.2 ± 5%	1.80 ± 5%	4.40	4.40	4.40	0.43	1.79 ± 11.0%

[Ⓒ] The validity of ± 100 MHz only applies for DASY v4.4 and higher (see Page 2). The uncertainty is the RSS of the ConvF uncertainty at calibration frequency and the uncertainty to the indicated frequency band.

ES3DV3 SN:3088

November 19, 2009

DASY - Parameters of Probe: ES3DV3 SN:3088

Calibration Parameter Determined in Body Tissue Simulating Media

f [MHz]	Validity [MHz] ²	Permittivity	Conductivity	ConvF X	ConvF Y	ConvF Z	Alpha	Depth Unc (k=2)
500	± 50 / ± 100	55.0 ± 5%	1.05 ± 5%	5.68	5.68	5.68	0.97	1.07 ± 11.0%
1610	± 50 / ± 100	53.3 ± 5%	1.52 ± 5%	4.76	4.76	4.76	0.41	1.88 ± 11.0%
1900	± 50 / ± 100	53.3 ± 5%	1.52 ± 5%	4.58	4.58	4.58	0.36	2.13 ± 11.0%
2450	± 50 / ± 100	52.7 ± 5%	1.95 ± 5%	4.20	4.20	4.20	0.99	1.04 ± 11.0%

² The validity of ± 100 MHz only applies for DASY v4.4 and higher (see Page 2). The uncertainty is the RSE of the ConvF uncertainty at calibration frequency and the uncertainty for the indicated frequency band.

ES3DV3 SN:3088

November 19, 2009

Frequency Response of E-Field

(TEM-Cell:ifi110 EXX, Waveguide: R22)

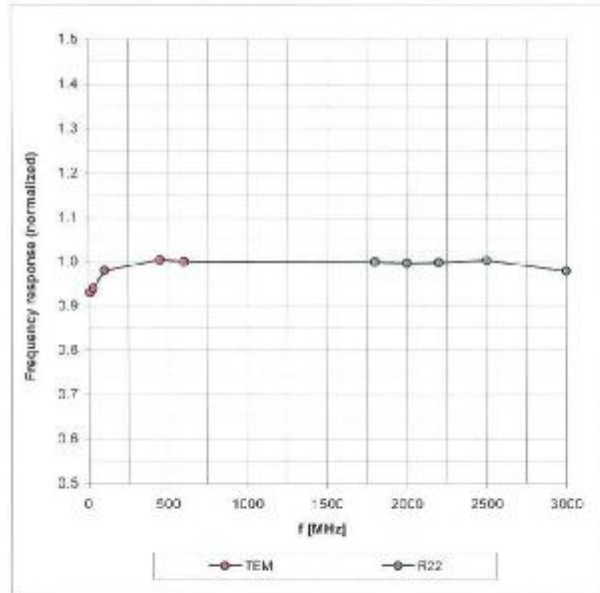

Uncertainty of Frequency Response of E-field: $\pm 6.3\%$ (k=2)

ES3DV3 SN:3088

November 19, 2009

Receiving Pattern (ϕ), $\theta = 0^\circ$

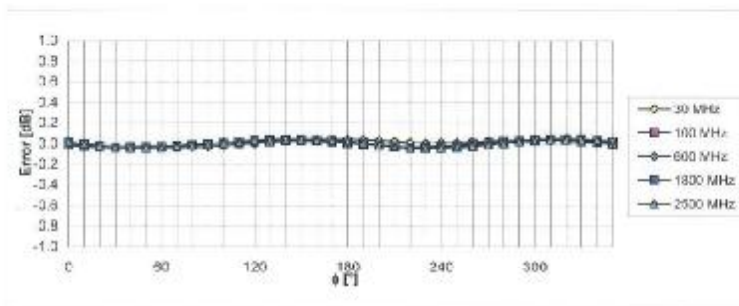
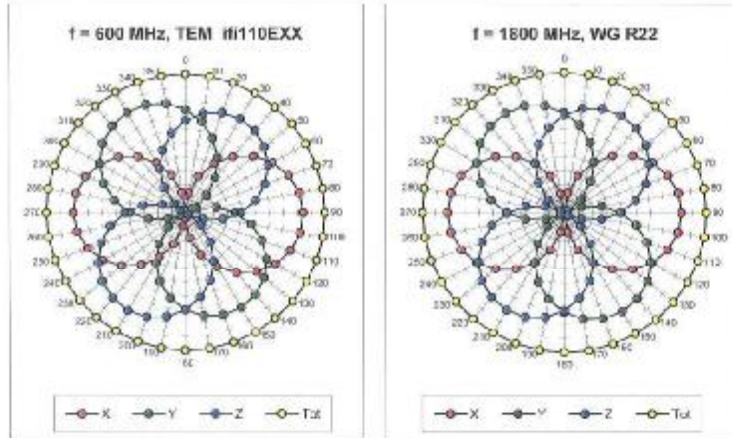

Uncertainty of Axial Isotropy Assessment: $\pm 0.5\%$ (k=2)

ES3DV3 SN:3088

November 19, 2009

Dynamic Range $f(SAR_{head})$ (Waveguide R22, $f = 1800$ MHz)

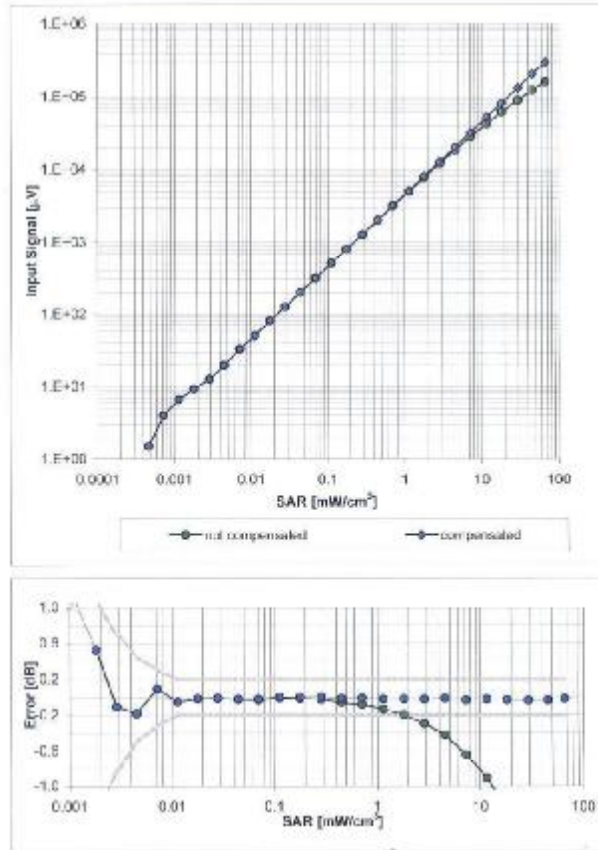

Uncertainty of Linearity Assessment: $\pm 0.6\%$ ($k=2$)

ES3DV3 SN:3086

November 19, 2009

Conversion Factor Assessment

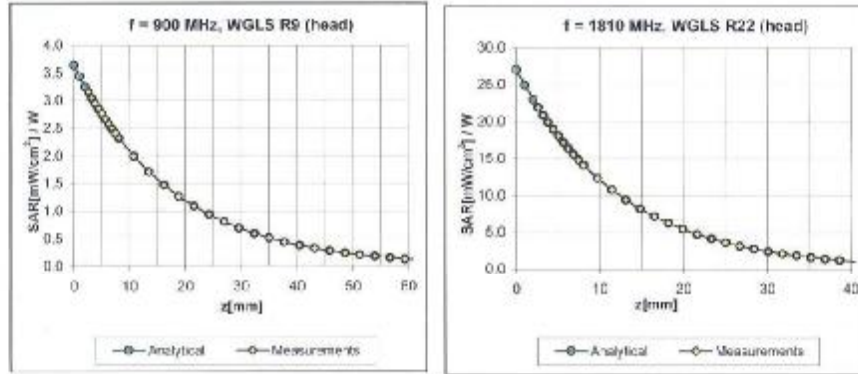

Deviation from Isotropy in HSL

Error (ϕ, θ), f = 900 MHz

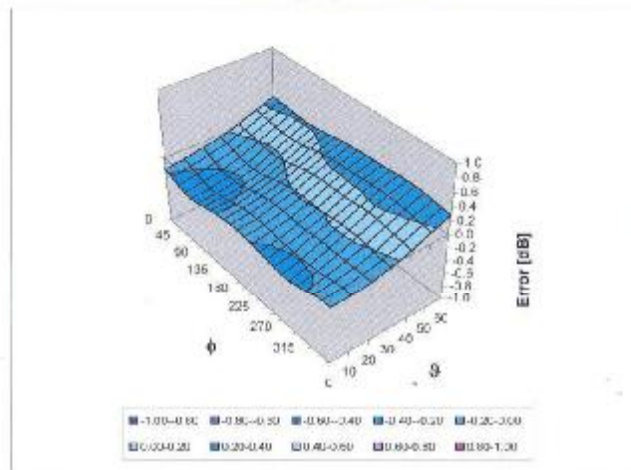

Uncertainty of Spherical Isotropy Assessment: $\pm 2.6\%$ (k=2)

ES3DV3 SN:3088

November 19, 2009

Other Probe Parameters

Sensor Arrangement	Triangular
Connector Angle (°)	Not applicable
Mechanical Surface Detection Mode	enabled
Optical Surface Detection Mode	disabled
Probe Overall Length	337 mm
Probe Body Diameter	10 mm
Tip Length	10 mm
Tip Diameter	4.0 mm
Probe Tip to Sensor X Calibration Point	2 mm
Probe Tip to Sensor Y Calibration Point	2 mm
Probe Tip to Sensor Z Calibration Point	2 mm
Recommended Measurement Distance from Surface	3 mm

Annex E.2 DAE Calibration certificate

**Calibration Laboratory of
Schmid & Partner
Engineering AG**
Zaughausstrasse 43, 8004 Zurich, Switzerland



S Schweizerischer Kalibrierdienst
C Service suisse d'étalonnage
S Servizio svizzero di taratura
S Swiss Calibration Service

Accredited by the Swiss Accreditation Service (SAS)
The Swiss Accreditation Service is one of the signatories to the EA
Multilateral Agreement for the recognition of calibration certificates

Accreditation No.: SCS 108

Client **SGS - SH (Auden)**

Certificate No: **DAE3-569 Nov09**

CALIBRATION CERTIFICATE

Object **DAE3 - SD 000 D03 AA - SN: 569**

Calibration procedure(s) **QA CAL-08.v12
Calibration procedure for the data acquisition electronics (DAE)**

Calibration date: **November 18, 2009**

This calibration certificate documents the traceability to national standards, which realize the physical units of measurements (SI).
The measurements and the uncertainties with confidence probability are given on the following pages and are part of the certificate.

All calibrations have been conducted in the closed laboratory facility: environment temperature (22 ± 3)°C and humidity < 70%.

Calibration Equipment used (M&TE critical for calibration)

Primary Standards	ID #	Cal Date / Certificate No.	Scheduled Calibration
Keifley Multimeter Type 2001	SN: 0610278	1-Oct-09 / No: 9055	Oct-10
Secondary Standards	ID #	Check Date (in house)	Scheduled Check
Calibrator Box V1.1	SE UMS 005 AB 1004	05-Jun-09 (in house check)	In house check: Jun-10

Calibrated by:	Name Dominique Stalten	Function Technician	Signature
Approved by:	Name Frits Bonhout	Function R&D Director	Signature

Issued: November 18, 2009

This calibration certificate shall not be reproduced except in full without written approval of the laboratory.

**Calibration Laboratory of
Schmid & Partner
Engineering AG**
Zeughausstrasse 43, 8004 Zurich, Switzerland



S Schweizerischer Kalibrierdienst
C Service suisse d'étalonnage
S Servizio svizzero di taratura
S Swiss Calibration Service

Accredited by the Swiss Accreditation Service (SAS)
The Swiss Accreditation Service is one of the signatories to the EA
Multilateral Agreement for the recognition of calibration certificates

Accreditation No.: SCS 108

Glossary

DAE data acquisition electronics
Connector angle information used in DASY system to align probe sensor X to the robot coordinate system.

Methods Applied and Interpretation of Parameters

- **DC Voltage Measurement:** Calibration Factor assessed for use in DASY system by comparison with a calibrated instrument traceable to national standards. The figure given corresponds to the full scale range of the voltmeter in the respective range.
- **Connector angle:** The angle of the connector is assessed measuring the angle mechanically by a tool inserted. Uncertainty is not required.
- The following parameters as documented in the Appendix contain technical information as a result from the performance test and require no uncertainty.
 - **DC Voltage Measurement Linearity:** Verification of the Linearity at +10% and -10% of the nominal calibration voltage. Influence of offset voltage is included in this measurement.
 - **Common mode sensitivity:** Influence of a positive or negative common mode voltage on the differential measurement.
 - **Channel separation:** Influence of a voltage on the neighbor channels not subject to an input voltage.
 - **AD Converter Values with inputs shorted:** Values on the internal AD converter corresponding to zero input voltage
 - **Input Offset Measurement:** Output voltage and statistical results over a large number of zero voltage measurements.
 - **Input Offset Current:** Typical value for information; Maximum channel input offset current, not considering the input resistance.
 - **Input resistance:** DAE input resistance at the connector, during internal auto-zeroing and during measurement.
 - **Low Battery Alarm Voltage:** Typical value for information. Below this voltage, a battery alarm signal is generated.
 - **Power consumption:** Typical value for information. Supply currents in various operating modes.

DC Voltage Measurement

AD - Converter Resolution nominal

High Range: 1LSB = 0.1µV full range = -100...+300 mV

Low Range: 1LSB = 0.1nV full range = -1...+3mV

DASY measurement parameters: Auto Zero Time: 3 sec; Measuring time: 3 sec

Calibration Factors	X	Y	Z
High Range	404.766 ± 0.1% (k=2)	404.352 ± 0.1% (k=2)	404.129 ± 0.1% (k=2)
Low Range	3.94150 ± 0.7% (k=2)	3.93629 ± 0.7% (k=2)	3.95193 ± 0.7% (k=2)

Connector Angle

Connector Angle to be used in DASY system	264.0 ° ± 1 °
---	---------------

Appendix

1. DC Voltage Linearity

High Range	Reading (μV)	Difference (μV)	Error (%)
Channel X + Input	20000.4	3.78	0.00
Channel X + Input	20001.03	0.33	0.00
Channel X - Input	-19995.39	5.31	-0.03
Channel Y + Input	200010.9	3.93	0.00
Channel Y + Input	19997.76	-2.84	-0.01
Channel Y - Input	-20002.85	-3.05	0.02
Channel Z + Input	200008.6	4.33	0.00
Channel Z + Input	19999.52	-0.88	-0.00
Channel Z - Input	-20001.79	0.01	0.01

Low Range	Reading (μV)	Difference (μV)	Error (%)
Channel X + Input	1999.7	-0.28	-0.01
Channel X + Input	199.60	-0.40	-0.20
Channel X - Input	-201.13	-1.23	0.62
Channel Y + Input	2000.0	0.02	0.00
Channel Y + Input	199.28	-0.82	-0.41
Channel Y - Input	-201.40	-1.50	0.75
Channel Z + Input	1999.9	-0.17	-0.01
Channel Z + Input	196.61	-1.39	-0.70
Channel Z - Input	-201.65	-1.75	0.88

2. Common mode sensitivity

DASY measurement parameters: Auto Zero Time: 3 sec; Measuring time: 3 sec

	Common mode Input Voltage (mV)	High Range Average Reading (μV)	Low Range Average Reading (μV)
Channel X	200	-3.14	-5.24
	-200	6.52	4.85
Channel Y	200	7.98	7.35
	-200	-8.52	-8.82
Channel Z	200	-5.05	-5.64
	-200	3.96	4.09

3. Channel separation

DASY measurement parameters: Auto Zero Time: 3 sec; Measuring time: 3 sec

	Input Voltage (mV)	Channel X (μV)	Channel Y (μV)	Channel Z (μV)
Channel X	200	-	2.19	0.12
Channel Y	200	2.65	-	3.55
Channel Z	200	1.86	-0.43	-

4. AD-Converter Values with inputs shorted

DASY measurement parameters: Auto Zero Time: 3 sec; Measuring time: 3 sec

	High Range (LSB)	Low Range (LSB)
Channel X	16392	14986
Channel Y	15762	16421
Channel Z	16298	16514

5. Input Offset Measurement

DASY measurement parameters: Auto Zero Time: 3 sec; Measuring time: 3 sec

Input: 10V/5

	Average (μV)	min. Offset (μV)	max. Offset (μV)	Std. Deviation (μV)
Channel X	-0.18	-1.21	0.79	0.33
Channel Y	-0.61	-1.80	0.79	0.30
Channel Z	-0.97	-2.37	-0.10	0.36

6. Input Offset Current

Nominal input circuitry offset current on all channels: <251A

7. Input Resistance

	Zeroing (MOhm)	Measuring (MOhm)
Channel X	0.2000	199.8
Channel Y	0.2000	204.0
Channel Z	0.2001	204.9

8. Low Battery Alarm Voltage (verified during pre test)

Typical values	Alarm Level (VDC)
Supply (+ Vcc)	+7.9
Supply (- Vcc)	-7.6

9. Power Consumption (verified during pre test)

Typical values	Switched off (mA)	Stand by (mA)	Transmitting (mA)
Supply (+ Vcc)	+0.0	+6	+14
Supply (- Vcc)	-0.01	-3	-9

Annex E.3 Dipole Calibration certification
 D2450V2

Calibration Laboratory of
 Schmid & Partner
 Engineering AG
 Zeughausstrasse 43, 8004 Zurich, Switzerland



S Schweizerischer Kalibrierdienst
 C Service suisse d'étalonnage
 S Servizio svizzero di taratura
 S Swiss Calibration Service

Accredited by the Swiss Accreditation Service (SAS)
 The Swiss Accreditation Service is one of the signatories to the EA
 Multilateral Agreement for the recognition of calibration certificates

Accreditation No.: SCS 108

Client SGS-SH (Auden)

Certificate No: D2450V2-733_Nov09

CALIBRATION CERTIFICATE			
Object	D2450V2 - SN: 733		
Calibration procedure(s)	QA CAL-05.v7 Calibration procedure for dipole validation kits		
Calibration date:	November 25, 2009		
<p>This calibration certificate documents the traceability to national standards, which realize the physical units of measurements (SI). The measurements and the uncertainties with confidence probability are given on the following pages and are part of the certificate.</p> <p>All calibrations have been conducted in the closed laboratory facility: environment temperature (22 ± 3)°C and humidity < 70%.</p> <p>Calibration Equipment used (MSTE critical for calibration):</p>			
Primary Standards	ID #	Cal Date (Certificate No.)	Scheduled Calibration
Power meter EPM-442A	GB37490704	06-Oct-09 (No. 217-01086)	Oct-10
Power sensor HP 8451A	US37292783	08-Oct-09 (No. 217-01086)	Oct-10
Reference 20 dB Attenuator	SN: 5088 (20g)	31-Mar-09 (No. 217-01025)	Mar-10
Type-N mismatch combination	SN: 5047.2 / 05327	31-Mar-09 (No. 217-01025)	Mar-10
Reference Probe ESSDV3	SN: 3205	28-Jun-09 (No. ES3-3205_Jun09)	Jun-10
DAE4	SN: 601	07-Mar-09 (No. DAE4-601_Mar09)	Mar-10
Secondary Standards	ID #	Check Date (in house)	Scheduled Check
Power sensor HP 8481A	MY41082317	18-Oct-02 (in house check Oct-09)	In house check: Oct-11
RF generator R&S SMT-06	100005	4-Aug-99 (in house check Oct-09)	In house check: Oct-11
Network Analyzer HP 8753E	US37320589 S4206	18-Oct-01 (in house check Oct-08)	In house check: Oct-10
Calibrated by:	Name Jelco Kestrel	Function Laboratory Technician	Signature
Approved by:	Name Kolja Pokovic	Technical Manager	
			Issued: November 26, 2009
This calibration certificate shall not be reproduced except in full without written approval of the laboratory.			

**Calibration Laboratory of
Schmid & Partner
Engineering AG**
Zeughausstrasse 43, 8004 Zurich, Switzerland



S Schweizerischer Kalibrierdienst
S Service suisse d'étalonnage
C Servizio svizzero di taratura
S Swiss Calibration Service

Accredited by the Swiss Accreditation Service (SAS)
The Swiss Accreditation Service is one of the signatories to the EA
Multilateral Agreement for the recognition of calibration certificates

Accreditation No.: **SCS 108**

Glossary:

TSL tissue simulating liquid
ConvF sensitivity in TSL / NORM x,y,z
N/A not applicable or not measured

Calibration is Performed According to the Following Standards:

- a) IEEE Std 1528-2003, "IEEE Recommended Practice for Determining the Peak Spatial-Averaged Specific Absorption Rate (SAR) in the Human Head from Wireless Communications Devices: Measurement Techniques", December 2003
- b) IEC 62209-1, "Procedure to measure the Specific Absorption Rate (SAR) for hand-held devices used in close proximity to the ear (frequency range of 300 MHz to 3 GHz)", February 2005
- c) Federal Communications Commission Office of Engineering & Technology (FCC OET), "Evaluating Compliance with FCC Guidelines for Human Exposure to Radiofrequency Electromagnetic Fields; Additional Information for Evaluating Compliance of Mobile and Portable Devices with FCC Limits for Human Exposure to Radiofrequency Emissions", Supplement C (Edition 01-01) to Bulletin 65

Additional Documentation:

- d) DASY4/5 System Handbook

Methods Applied and Interpretation of Parameters:

- *Measurement Conditions:* Further details are available from the Validation Report at the end of the certificate. All figures stated in the certificate are valid at the frequency indicated.
- *Antenna Parameters with TSL:* The dipole is mounted with the spacer to position its feed point exactly below the center marking of the flat phantom section, with the arms oriented parallel to the body axis.
- *Feed Point Impedance and Return Loss:* These parameters are measured with the dipole positioned under the liquid filled phantom. The impedance stated is transformed from the measurement at the SMA connector to the feed point. The Return Loss ensures low reflected power. No uncertainty required.
- *Electrical Delay:* One-way delay between the SMA connector and the antenna feed point. No uncertainty required.
- *SAR measured:* SAR measured at the stated antenna input power.
- *SAR normalized:* SAR as measured, normalized to an input power of 1 W at the antenna connector.
- *SAR for nominal TSL parameters:* The measured TSL parameters are used to calculate the nominal SAR result.

Measurement Conditions

DASY system configuration, as far as not given on page 1.

DASY Version	DASY6	V5.2
Extrapolation	Advanced Extrapolation	
Phantom	Modular Flat Phantom V4.9	
Distance Dipole Center - TSL	10 mm	with Spacer
Zoom Scan Resolution	dx, dy, dz = 5 mm	
Frequency	2450 MHz ± 1 MHz	

Head TSL parameters

The following parameters and calculations were applied.

	Temperature	Permittivity	Conductivity
Nominal Head TSL parameters	22.0 °C	39.2	1.80 mho/m
Measured Head TSL parameters	(22.0 ± 0.2) °C	39.2 ± 6 %	1.80 mho/m ± 6 %
Head TSL temperature during test	(22.0 ± 0.2) °C	---	---

SAR result with Head TSL

SAR averaged over 1 cm ³ (1 g) of Head TSL	Condition	
SAR measured	250 mW input power	13.3 mW / g
SAR normalized	normalized to 1W	53.2 mW / g
SAR for nominal Head TSL parameters	normalized to 1W	53.2 mW / g ± 17.0 % (k=2)

SAR averaged over 10 cm ³ (10 g) of Head TSL	condition	
SAR measured	250 mW input power	6.25 mW / g
SAR normalized	normalized to 1W	25.0 mW / g
SAR for nominal Head TSL parameters	normalized to 1W	25.0 mW / g ± 16.5 % (k=2)

Body TSL parameters

The following parameters and calculations were applied.

	Temperature	Permittivity	Conductivity
Nominal Body TSL parameters	22.0 °C	52.7	1.95 mho/m
Measured Body TSL parameters	(22.0 ± 0.2) °C	52.6 ± 6 %	1.99 mho/m ± 6 %
Body TSL temperature during test	(21.8 ± 0.2) °C	---	---

SAR result with Body TSL

SAR averaged over 1 cm ³ (1 g) of Body TSL	Condition	
SAR measured	250 mW input power	12.7 mW / g
SAR normalized	normalized to 1W	50.8 mW / g
SAR for nominal Body TSL parameters	normalized to 1W	50.3 mW / g ± 17.0 % (k=2)

SAR averaged over 10 cm ³ (10 g) of Body TSL	condition	
SAR measured	250 mW input power	5.86 mW / g
SAR normalized	normalized to 1W	23.4 mW / g
SAR for nominal Body TSL parameters	normalized to 1W	23.3 mW / g ± 16.5 % (k=2)

Appendix

Antenna Parameters with Head TSL

Impedance, transformed to feed point	54.4 Ω + 2.1 j Ω
Return Loss	- 26.8 dB

Antenna Parameters with Body TSL

Impedance, transformed to feed point	48.6 Ω + 4.1 j Ω
Return Loss	- 27.1 dB

General Antenna Parameters and Design

Electrical Delay (one direction)	1.144 ns
----------------------------------	----------

After long term use with 100W radiated power, only a slight warming of the dipole near the feedpoint can be measured.

The dipole is made of standard semirigid coaxial cable. The center conductor of the feeding line is directly connected to the second arm of the dipole. The antenna is therefore short-circuited for DC-signals.

No excessive force must be applied to the dipole arms, because they might bend or the soldered connections near the feedpoint may be damaged.

Additional EUT Data

Manufactured by	SPEAG
Manufactured on	May 07, 2003

DASY5 Validation Report for Head TSL

Date/Time: 25.11.2009 13:30:12

Test Laboratory: SPEAG, Zurich, Switzerland

DUT: Dipole 2450 MHz; Type: D2450V2; Serial: D2450V2 - SN:733

Communication System: CW; Frequency: 2450 MHz; Duty Cycle: 1:1

Medium: HSL U11 BB

Medium parameters used: $f = 2450$ MHz; $\sigma = 1.8$ mho/m; $\epsilon_r = 39.2$; $\rho = 1000$ kg/m³

Phantom section: Flat Section

Measurement Standard: DASY5 (IEEE/IEC/ANSI C63.19-2007)

DASY5 Configuration:

- Probe: ES3DV3 - SN3205; Cmf(4.53, 4.53, 4.53); Calibrated: 26.06.2009
- Sensor-Surface: 3mm (Mechanical Surface Detection)
- Electronics: DAET S0601; Calibrated: 07.03.2009
- Phantom: Flat Phantom 5.0 (front); Type: QD000P50AA; Serial: 1001
- Measurement SW: DASY5, V5.2 Build 157; SEMCAD X Version 14.0 Build 57

Pin=250 mW /d=10mm, dist=3.0mm (ES-Probe)/Zoom Scan (7x7x7)/Cube 0: Measurement grid: dx=5mm, dy=5mm, dz=5mm

Reference Value = 102.1 V/m; Power Drift = 0.059 dB

Peak SAR (extrapolated) = 27 W/kg

SAR(1 g) = 13.3 mW/g; SAR(10 g) = 6.25 mW/g

Maximum value of SAR (measured) = 17.4 mW/g

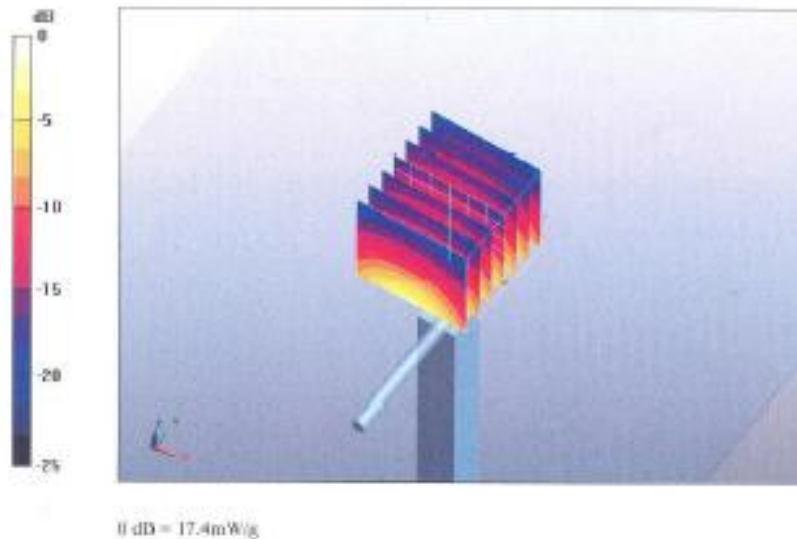

Impedance Measurement Plot for Head TSL

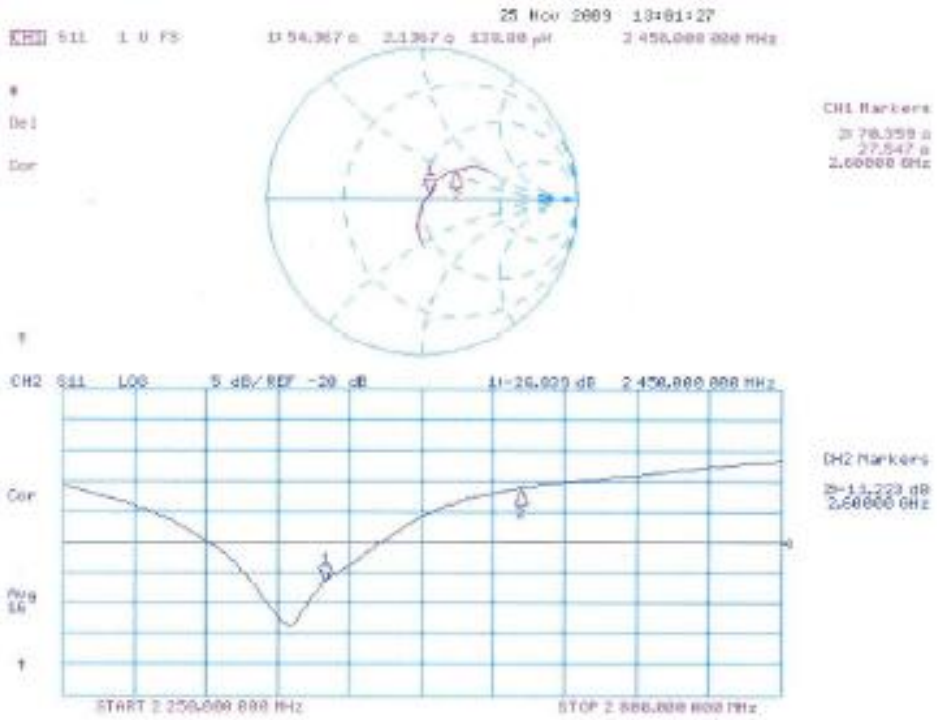

DASY5 Validation Report for Body

Date/Time: 18.11.2009 14:57:55

Test Laboratory: SPEAG, Zurich, Switzerland

DUT: Dipole 2450 MHz; Type: D2450V2; Serial: D2450V2 - SN: 733

Communication System: CW; Frequency: 2450 MHz; Duty Cycle: 1:1

Medium: MSL U10 BB

Medium parameters used: $f = 2450$ MHz; $\sigma = 1.99$ mho/m; $\epsilon_0 = 52.6$; $\rho = 1000$ kg/m³

Phantom section: Flat Section

Measurement Standard: DASY5 (IEEE/IEC/ANSI C63.19-2007)

DASY5 Configuration:

- Probe: ES3DV3 - SN3205; Conf(4.31, 4.31, 4.31); Calibrated: 26.06.2009
- Sense-Surface: 3mm (Mechanical Surface Detection)
- Electronics: DAE4 50601; Calibrated: 07.03.2009
- Phantom: Flat Phantom 5.0 (back); Type: QD000P50AA; Serial: 1002
- Measurement SW: DASY5, VS.2 Build 157; SEMCAD X Version 14.0 Build 57

Pin250 mW /d=10mm, dist=3.0mm (ES-Probe)/Zoom Scan (7x7x7)/Cube 0: Measurement grid: dx=5mm, dy=5mm, dz=5mm

Reference Value = 94.4 V/m; Power Drift = 0.017 dB

Peak SAR (extrapolated) = 28.2 W/kg

SAR(1 g) = 12.7 mW/g; SAR(10 g) = 5.86 mW/g

Maximum value of SAR (measured) = 16.7 mW/g

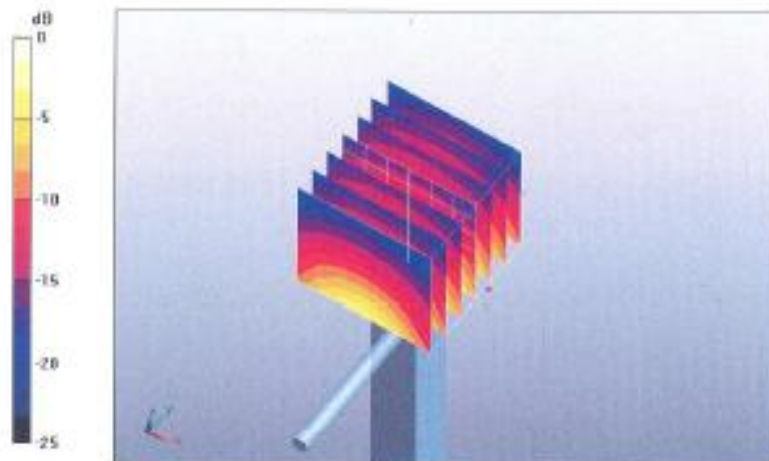

0 dB = 16.7mW/g

Impedance Measurement Plot for Body TSL

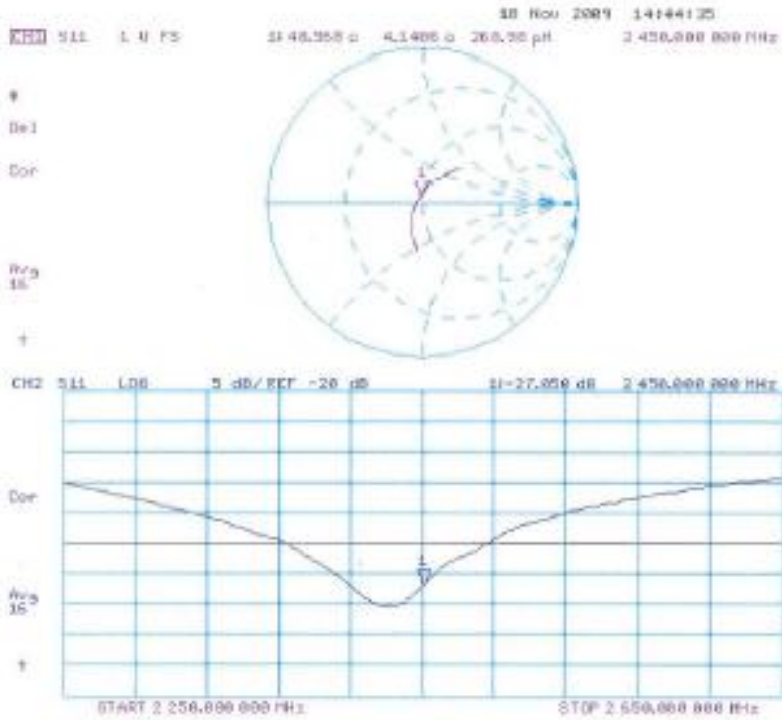

Annex F Additional SAR Probe Validation

SAR PROBE CALIBRATION

Model No. : S62

FCC ID : YCNS62

The following procedures are recommended for DUT measurements at 150MHz to 3GHz to minimize probe calibration and tissue dielectric parameter discrepancies.

a) In general, CUT SAR measurements below 300 MHz should be within +/- 50 MHz of the probe calibration frequency.

SEE ALSO ITEM c).

b) At 300 MHz to 3 GHz, DUT measurements should be within +/- 100 MHz of the probe calibration frequency.

SEE ALSO ITEM c).

c) Measurements exceeding 50% of these intervals, I.E.,

+/- 25 MHz, DUT $f < 300$ MHz, OR

+/- 50 MHz, DUT $f \geq 300$ MHz,

SHALL APPLY THE FOLLOWING ADDITIONAL STEPS:

1) When the actual tissue dielectric parameters used for probe calibration are available (careful about some probe manuf.list only nominal or range on calib.cert), the differences for relative permittivity and conductivity between probe calibration and routine measurements should each be less than or equal to 5 % while also satisfying the required +/- 5% tolerances in target dielectric parameters.

<Head 900 MHz>

The test frequencies are properly matched as this is a cellular band. The probe calibration for permittivity and conductivity is within +/-5%, were the probe calibrated centre frequency at 900MHz has permittivity and conductivity of 41.5 and 0.97 respectively. At the probe extreme frequencies the following are true: at 800MHz the permittivity and conductivity are 39.4 and 0.86 respectively. At 1000MHz the permittivity and conductivity are 43.6 and 1.03 respectively.

The probe was calibrated at these parameters in order to cover the frequency range 800MHz to 1000MHz.

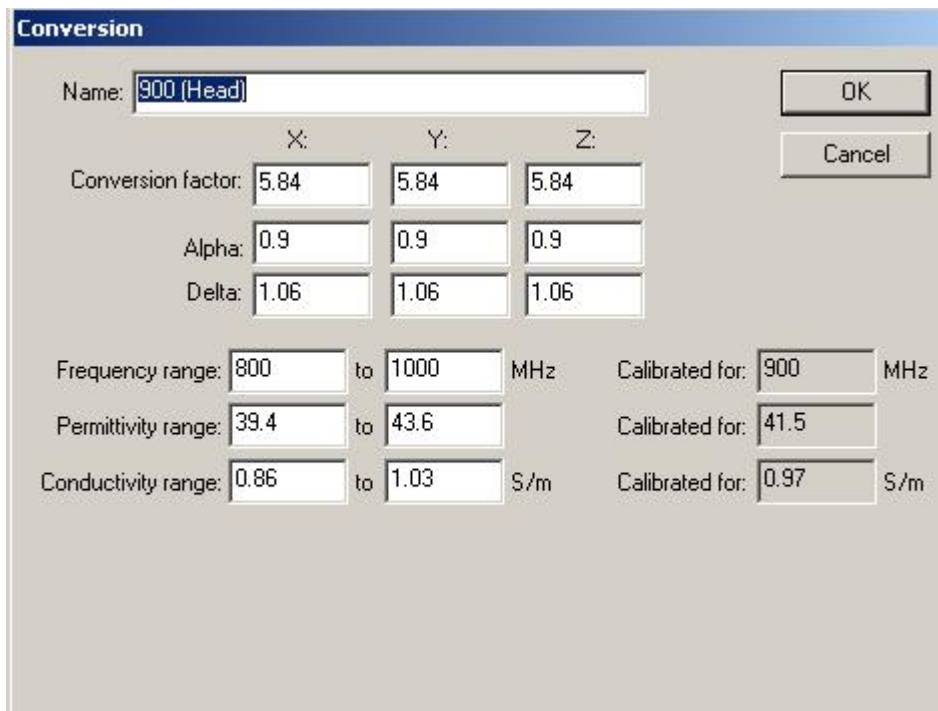

	X:	Y:	Z:		
Name:	900 (Head)				
Conversion factor:	5.84	5.84	5.84		
Alpha:	0.9	0.9	0.9		
Delta:	1.06	1.06	1.06		
Frequency range:	800	to	1000	MHz	Calibrated for: 900 MHz
Permittivity range:	39.4	to	43.6		Calibrated for: 41.5
Conductivity range:	0.86	to	1.03	S/m	Calibrated for: 0.97 S/m

<Body 900 MHz>

The test frequencies are properly matched as this is a cellular band. The probe calibration for permittivity and conductivity is within +/-5%, were the probe calibrated centre frequency at 900MHz has permittivity and conductivity of 55.0 and 1.05 respectively. At the probe extreme frequencies the following are true: at 800MHz the permittivity and conductivity are 52.3 and 0.92 respectively. At 1000MHz the permittivity and conductivity are 57.8 and 1.10 respectively.

The probe was calibrated at these parameters in order to cover the frequency range 800MHz to 1000MHz.

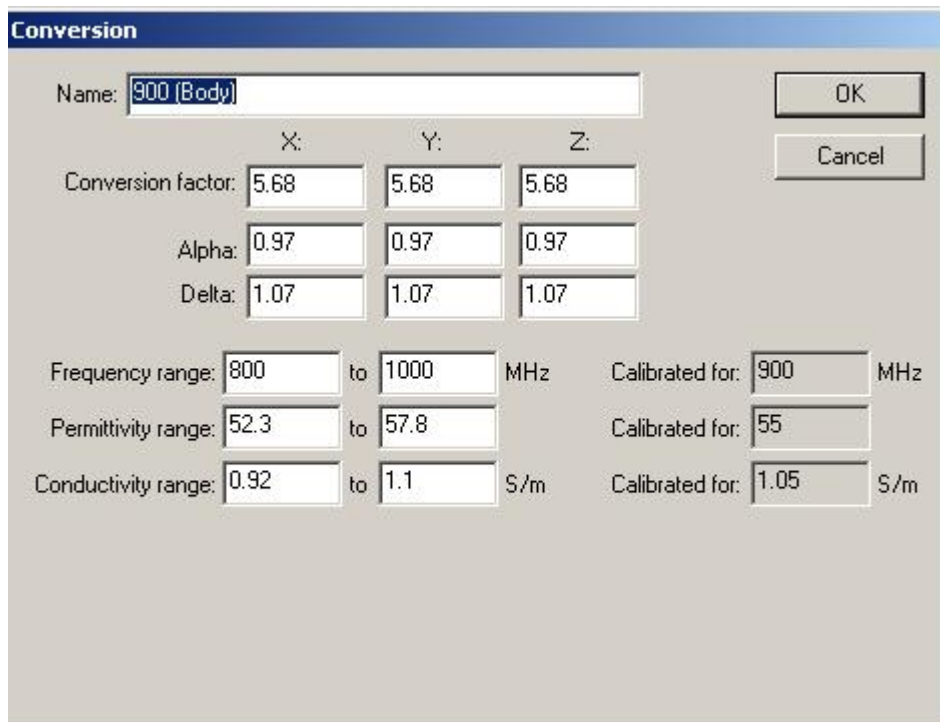

	X:	Y:	Z:	
Name:	900 (Body)			OK
Conversion factor:	5.68	5.68	5.68	Cancel
Alpha:	0.97	0.97	0.97	
Delta:	1.07	1.07	1.07	
Frequency range:	800	to	1000	MHz
Calibrated for:	900			MHz
Permittivity range:	52.3	to	57.8	
Calibrated for:	55			
Conductivity range:	0.92	to	1.1	S/m
Calibrated for:	1.05			S/m

<Head 1810 MHz>

The test frequencies are properly matched as this is a cellular band. The probe calibration for permittivity and conductivity is within +/-5%, were the probe calibrated centre frequency at 1810MHz has permittivity and conductivity of 40.0 and 1.40 respectively. At the probe extreme frequencies the following are true: at 1710MHz the permittivity and conductivity are 38.0 and 1.29 respectively. At 1910MHz the permittivity and conductivity are 42.0 and 1.47 respectively.

The probe was calibrated at these parameters in order to cover the frequency range 1710MHz to 1910MHz.

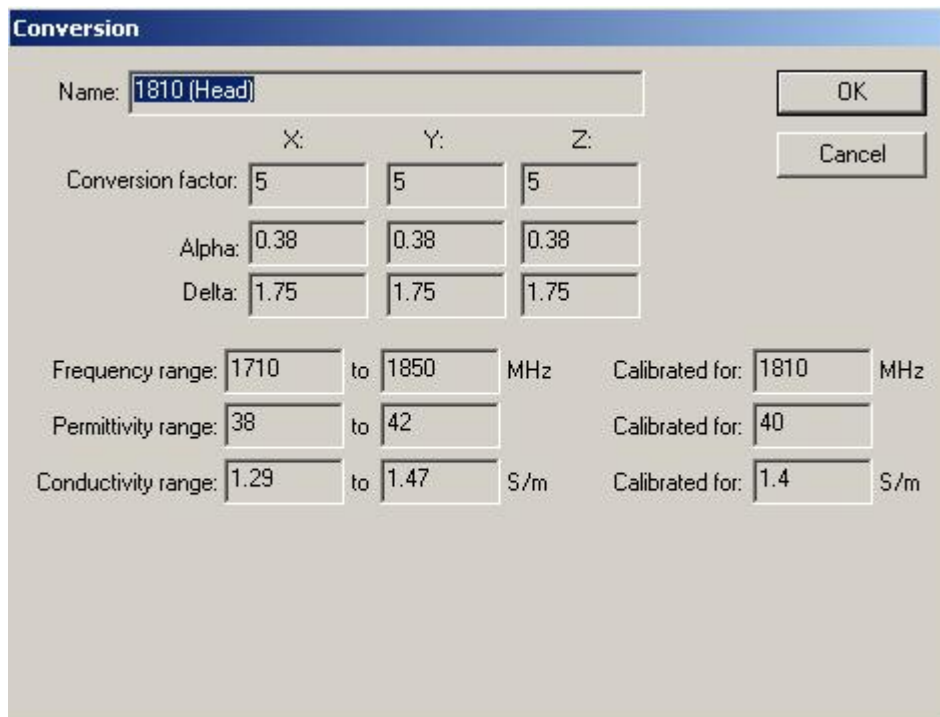

Name:			1810 (Head)			OK	
Conversion factor:			X: 5	Y: 5	Z: 5	Cancel	
Alpha:			0.38	0.38	0.38		
Delta:			1.75	1.75	1.75		
Frequency range:		1710	to	1850	MHz	Calibrated for:	1810 MHz
Permittivity range:		38	to	42		Calibrated for:	40
Conductivity range:		1.29	to	1.47	S/m	Calibrated for:	1.4 S/m

<Body 1810 MHz>

The test frequencies are properly matched as this is a cellular band. The probe calibration for permittivity and conductivity is within +/-5%, were the probe calibrated centre frequency at 1810MHz has permittivity and conductivity of 53.3 and 1.52 respectively. At the probe extreme frequencies the following are true: at 1710MHz the permittivity and conductivity are 50.6 and 1.38 respectively. At 1910MHz the permittivity and conductivity are 56.0 and 1.60 respectively.

The probe was calibrated at these parameters in order to cover the frequency range 1710MHz to 1910MHz.

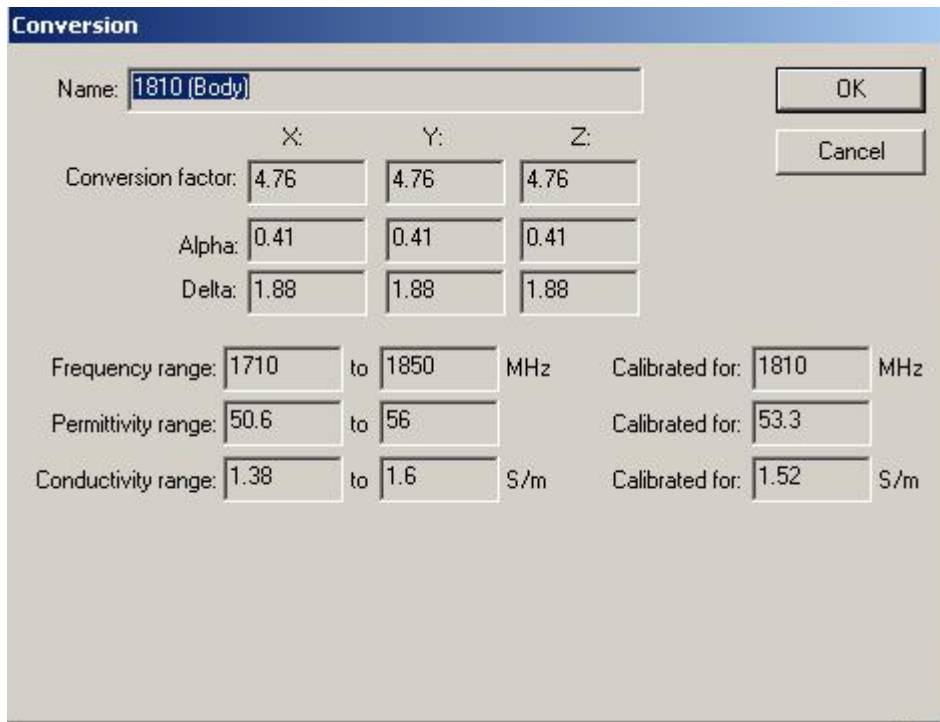

Conversion						
Name:	1810 (Body)					OK
	X:	Y:	Z:			
Conversion factor:	4.76	4.76	4.76			
Alpha:	0.41	0.41	0.41			
Delta:	1.88	1.88	1.88			
Frequency range:	1710	to	1850	MHz	Calibrated for:	1810 MHz
Permittivity range:	50.6	to	56		Calibrated for:	53.3
Conductivity range:	1.38	to	1.6	S/m	Calibrated for:	1.52 S/m
						Cancel

The target permittivity and conductivity at 835 MHz is 41.5 and 0.90 and 1900 MHz is 40.0 and 1.40 respectively which is within the calibrated range of the probe parameter. The following parameters are declared in the probe calibration certificate.

DASY - Parameters of Probe: ES3DV3 SN:3088

Calibration Parameter Determined in Head Tissue Simulating Media

f [MHz]	Validity [MHz] ^c	Permittivity	Conductivity	ConvF X	ConvF Y	ConvF Z	Alpha	Depth Unc (k=2)
900	± 50 / ± 100	41.5 ± 5%	0.97 ± 5%	5.84	5.84	5.84	0.90	1.06 ± 11.0%
1810	± 50 / ± 100	40.0 ± 5%	1.40 ± 5%	5.00	5.00	5.00	0.38	1.75 ± 11.0%
1900	± 50 / ± 100	40.0 ± 5%	1.40 ± 5%	4.97	4.97	4.97	0.48	1.53 ± 11.0%
2450	± 50 / ± 100	39.2 ± 5%	1.80 ± 5%	4.40	4.40	4.40	0.43	1.79 ± 11.0%

^c The validity of ± 100 MHz only applies for DASY v4.4 and higher (see Page 2). The uncertainty is the RSS of the ConvF uncertainty at calibration frequency and the uncertainty for the indicated frequency band.

Calibration Parameter Determined in Body Tissue Simulating Media

f [MHz]	Validity [MHz] ^c	Permittivity	Conductivity	ConvF X	ConvF Y	ConvF Z	Alpha	Depth Unc (k=2)
900	± 50 / ± 100	55.0 ± 5%	1.05 ± 5%	5.68	5.68	5.68	0.97	1.07 ± 11.0%
1810	± 50 / ± 100	53.3 ± 5%	1.52 ± 5%	4.76	4.76	4.76	0.41	1.88 ± 11.0%
1900	± 50 / ± 100	53.3 ± 5%	1.52 ± 5%	4.58	4.58	4.58	0.36	2.13 ± 11.0%
2450	± 50 / ± 100	52.7 ± 5%	1.95 ± 5%	4.20	4.20	4.20	0.99	1.04 ± 11.0%

^c The validity of ± 100 MHz only applies for DASY v4.4 and higher (see Page 2). The uncertainty is the RSS of the ConvF uncertainty at calibration frequency and the uncertainty for the indicated frequency band.

<Head 850 MHz>

Liquid		Parameters	Target	Measured	Deviation[%]
Medium	Freq.[MHZ]				
Body	825.0	Permittivity	41.6	41.93	0.79
		Conductivity	0.90	0.897	-0.33
	835.0	Permittivity	41.5	41.81	0.75
		Conductivity	0.90	0.907	0.78
	845.0	Permittivity	41.5	41.70	0.48
		Conductivity	0.91	0.917	0.77

<Body 850 MHz>

Liquid		Parameters	Target	Measured	Deviation[%]
Medium	Freq.[MHZ]				
Body	825.0	Permittivity	55.2	55.20	0
		Conductivity	0.97	0.9477	-2.30
	835.0	Permittivity	55.2	55.14	-0.11
		Conductivity	0.97	0.958	-1.24
	845.0	Permittivity	55.2	55.09	0.2
		Conductivity	0.98	0.969	-1.12

<Head 1900 MHz>

Liquid		Parameters	Target	Measured	Deviation[%]
Medium	Freq.[MHZ]				
Body	1850	Permittivity	40	38.90	-2.75
		Conductivity	1.4	1.431	2.21
	1880	Permittivity	40	38.72	-3.20
		Conductivity	1.4	1.466	4.71
		Permittivity	40	38.63	-3.43

SHGSM

	1910	Conductivity	1.4	1.469	4.93
--	------	--------------	-----	-------	------

<Body 1900 MHz>

Liquid		Parameters	Target	Measured	Deviation[%]
Medium	Freq.[MHZ]				
Body	1850	Permittivity	53.3	53.85	1.03
		Conductivity	1.52	1.464	-3.68
	1880	Permittivity	53.3	53.82	0.98
		Conductivity	1.52	1.502	-1.18
	1910	Permittivity	53.3	53.79	1.89
		Conductivity	1.52	1.534	0.92

2) when nominal tissue dielectric parameters are PROVIDED in the probe calibration data, the tissue dielectric parameters measured for routine measurements should be less than the target relative permittivity and higher than the target conductivity values, to minimize SAR underestimations. Otherwise, a thorough analysis of the effective frequency interval supported by the probe calibration and dielectric medium should be included in the SAR report to substantiate the test results-SEE ITEM d).

Alternatively, the measured 1-g SAR may be compensated with respect to +5%tolerance in relative permittivity and -5%tolerances in conductivity, computed according to valid SAR sensitivity data, to reduce SAR underestimation and maintain conservatism.

d) When thorough analysis is required for the additional steps, the following SHALL ASSO BE ADDRESSED. These other items can contribute to additional SAR differences, especially when the probe calibration, tissue dielectric parameters and device test frequencies are misaligned.

- 1) the probe conversion factor and its frequency response, with respect to the tissue dielectric media used during probe calibration and routine measurements, should be examined to determine if the effective frequency intervals is adequate for the intended measurements, should be examined to determine if the effective frequency interval is adequate for the intended measurements to satisfy protocol requirements.
- 2) Measurements within the required frequency intervals should satisfy an expanded probe calibration uncertainty (k=2) less than or equal to 15%for all measurement conditions.
- 3) When SAR is reported within 10% of the SAR limit, differences in field conditions and effects of output power levels on signal modulation between probe calibration and routine measurements should be examined to determine probe calibration validity.

- 4) Probe isotropy should also be assessed by rotating the probe in 15 degree increments at the peak SAR location of the zoom scan and accounted for in the measurement uncertainty.

The measured SAR values in the report are all below 10% of the SAR limit.

The measurement within the required frequency interval satisfy an expanded probe calibration uncertainty ($k=2$) $\leq 15\%$ for all measurement conditions. Please refer to SAR report for probe and dipole calibration certificates produce by the system manufacturer.

As you can see we used the conductivity and permittivity parameters which are within $\pm 5\%$ of the target values.

END OF REPORT