

# CATEYE MICRO Wireless

CYCLOCOMPUTER  
CC - MC100W  
Owner's Manual



U.S. Pat. Nos. 4633216/4636769/4642606/5236759 and Design Pat. Pending  
Copyright© 2004 CATEYE Co., Ltd.  
CCMC1W-041129 066600370 2



Max.  
Distance  
70 cm

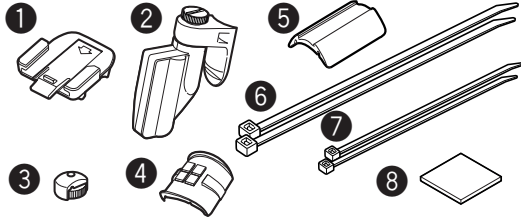
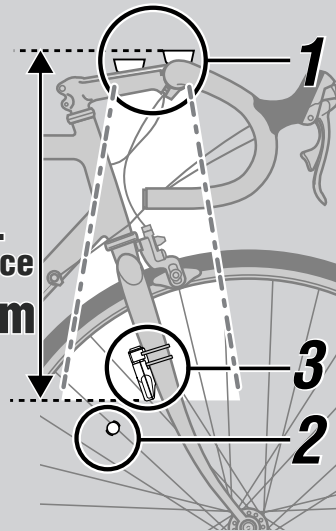

**Component name**

- ① Bracket
- ② Speed Sensor A
- ③ Magnet
- ④ Magnet Rubber Pad
- ⑤ Sensor Rubber Pad
- ⑥ Nylon Ties (L x 2)
- ⑦ Nylon Ties (S x 2)
- ⑧ Double-sided tape

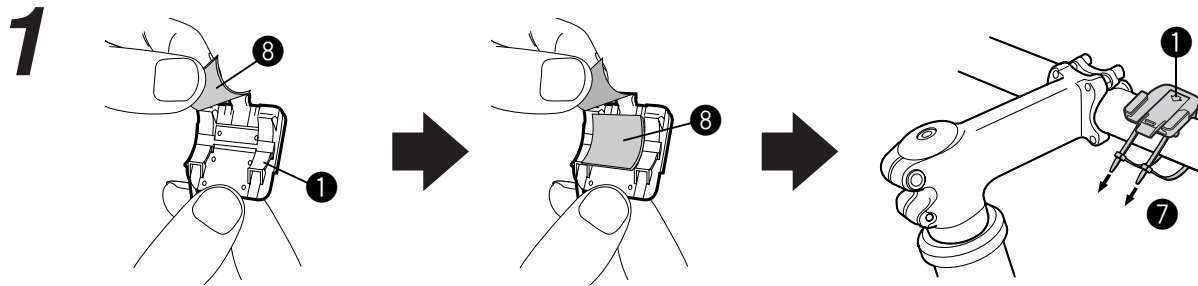

or

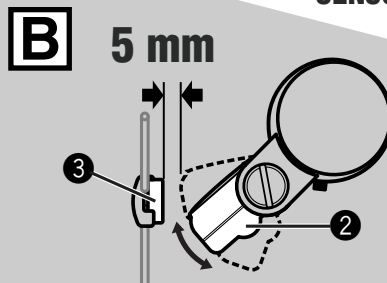
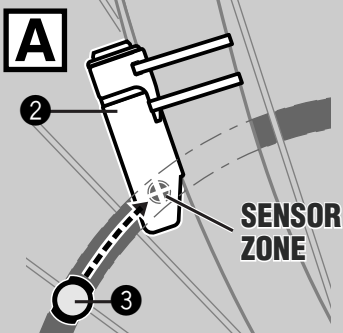
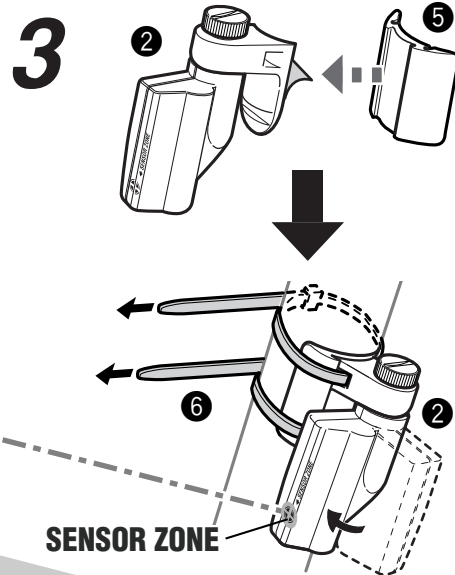
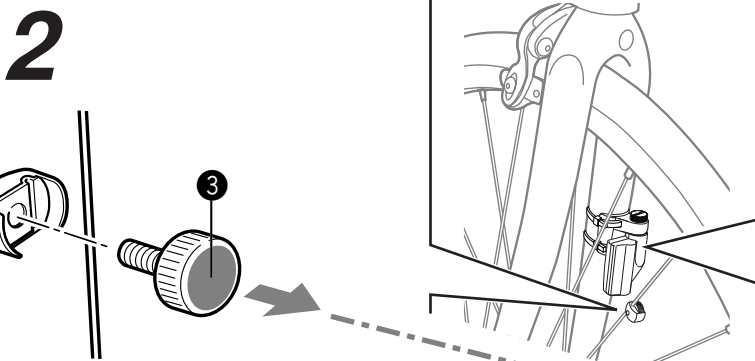

SETTING

1. All Clear

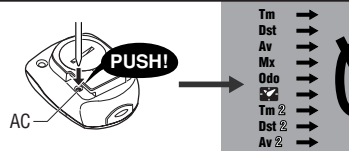

2. Select km/h or mph

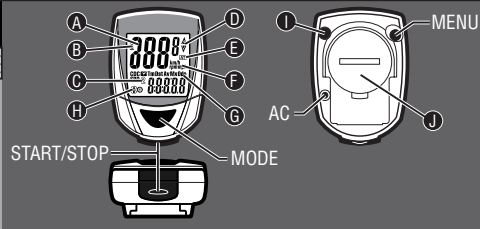
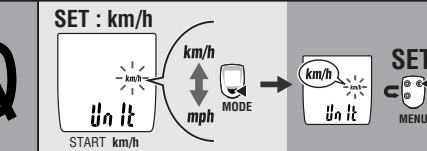

3. Wheel Circumference

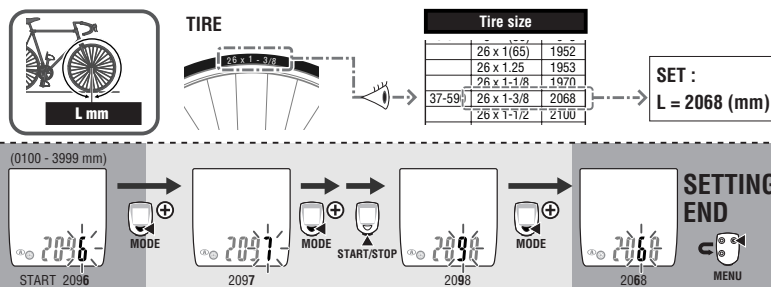

ETRTO	Tire size	L (mm)	ETRTO	Tire size	L (mm)	ETRTO	Tire size	L (mm)
	12 x 1.75	935		26 x 7/8	1920	32-630	27 x 1-1/4	2161
	14 x 1.50	1020	23-571	26 x 1(59)	1913		27 x 1-3/8	2169
	14 x 1.75	1055		26 x 1(65)	1952		650 x 35A	2090
	16 x 1.50	1185		26 x 1.25	1953		650 x 38A	2125
47-305	16 x 1.75	1195		26 x 1-1/8	1970	18-622	650 x 38B	2105
	18 x 1.50	1340	37-590	26 x 1-3/8	2068		700 x 18C	2070
	18 x 1.75	1350		26 x 1-1/2	2100		700 x 19C	2080
47-406	20 x 1.75	1515		26 x 1.40	2005	20-622	700 x 20C	2086
	20 x 1-3/8	1615	40-559	26 x 1.50	2010	23-622	700 x 23C	2096
	22 x 1-3/8	1770	47-559	26 x 1.75	2023	25-622	700 x 25C	2105
	22 x 1-1/2	1785	50-559	26 x 1.95	2050	28-622	700 x 28C	2136
	24 x 1	1753	54-559	26 x 2.00	2055		700 x 30C	2170
	24 x 3/4 Tubular	1785		26 x 2.10	2068	32-622	700 x 32C	2155
	24 x 1-1/8	1795	57-559	26 x 2.125	2070		700C Tubular	2130
	24 x 1-1/4	1905		26 x 2.35	2083	37-622	700 x 35C	2168
47-507	24 x 1.75	1890		57-559	26 x 3.00		700 x 38C	2180
	24 x 2.00	1925		27 x 1	2145	40-622	700 x 40C	2200
	24 x 2.125	1965		27 x 1-1/8	2155			

OPERATION FLOW

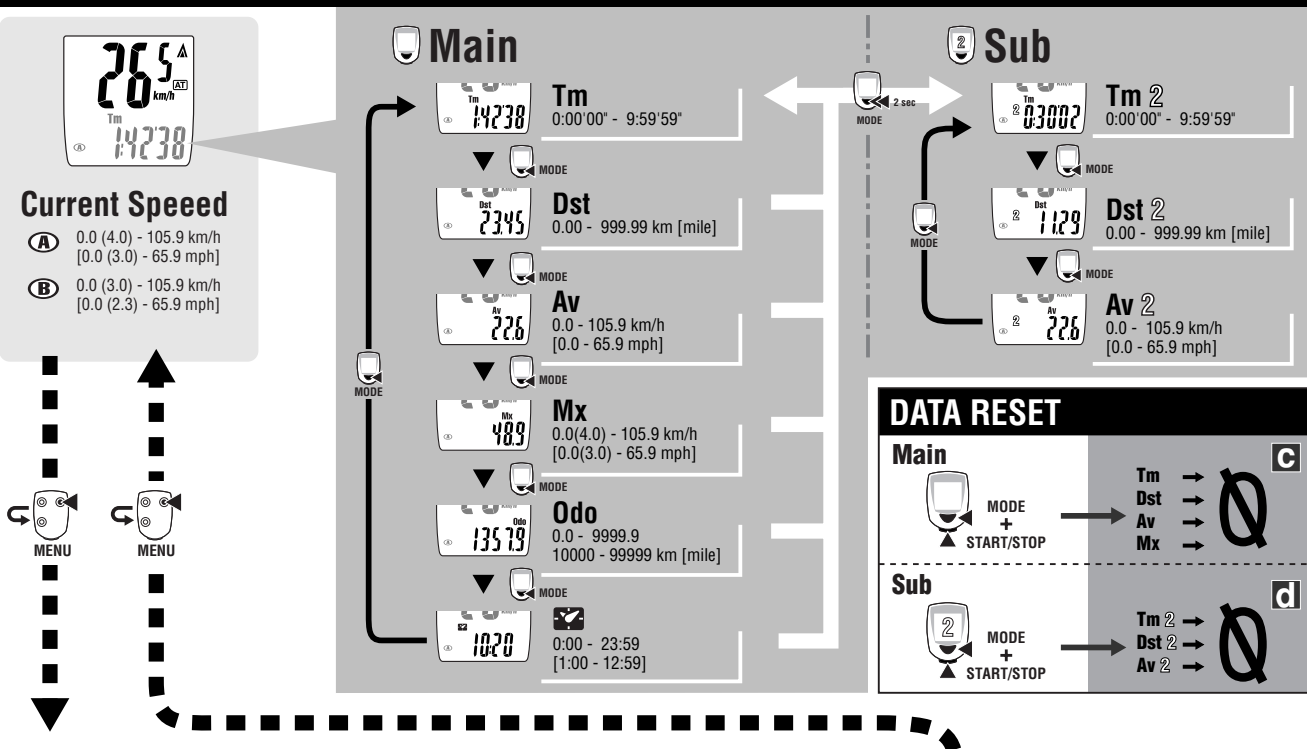

MENU FLOW

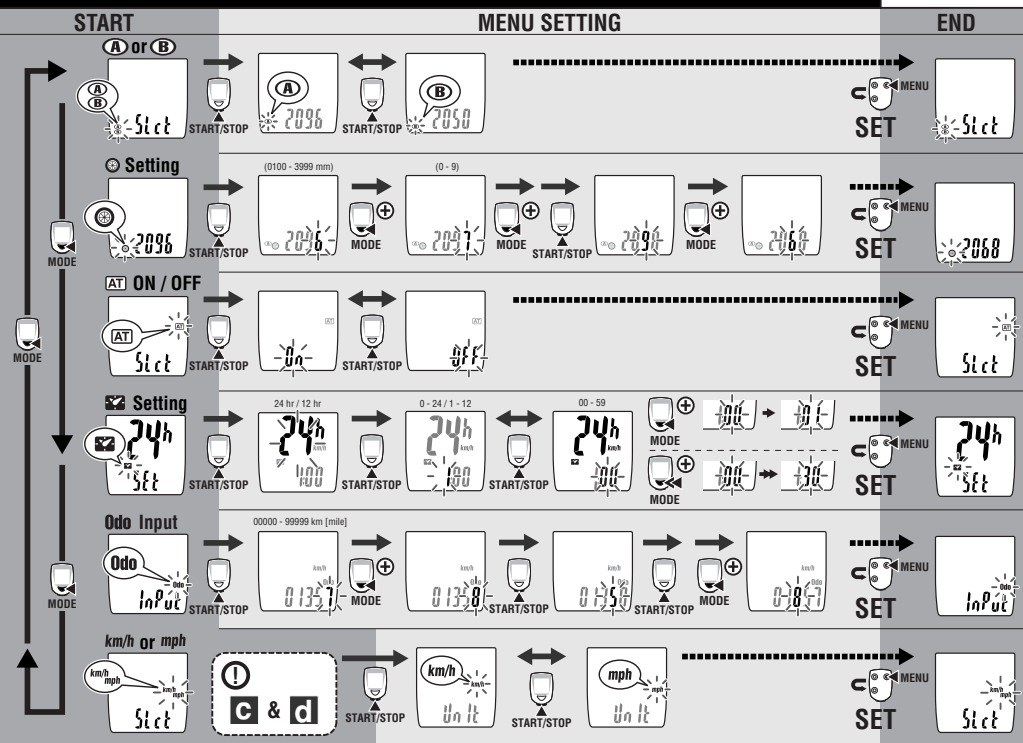

BATTERY

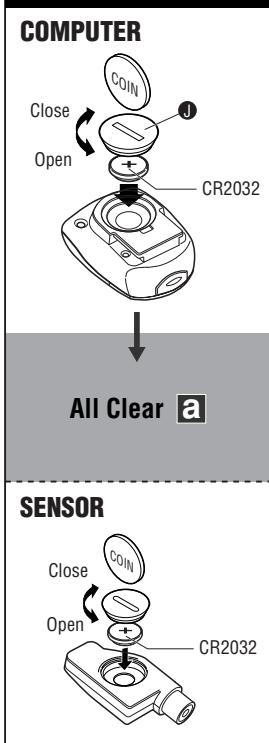

CC-MC100W MICRO Wireless



**CAUTION**

- Do not concentrate on the computer while riding. Be sure to ride safely!
- Install the magnet, sensor, and bracket securely. Check these periodically.
- Dispose of used batteries according to local regulations. If swallowed, consult a doctor immediately.
- Avoid having the computer in hot direct sunlight for extended periods.
- Do not disassemble the computer.
- Clean the computer and accessories with a soft cloth dampened with a neutral detergent. Do not use thinners, benzene, or alcohol on the computer.

**Wireless Sensor**

The sensor was designed to receive signals within a limited range to prevent sensor signal interference. Thus, the sensor and computer must be relatively close. If the temperature or battery power is low, they may need to be even closer than normal. The sensor must be installed at the top of the fork, and the distance between the sensor and the computer should not exceed approximately 70 cm. Install the computer on the stem, with its bottom surface facing the sensor. (Take into account the angle of the stem.)

Interference may occur, resulting in malfunction, if the computer is:

- Near a TV, PC, radio, motor, or in a car or train.
- Close to a railroad crossing, railway tracks, TV stations and/or radar base.
- Close to a second bicycle with wireless sensors.

**Correct installation of sensor and magnet**

- A** Attach the magnet so that it passes through the sensor zone of the sensor .
- B** Be sure to have a 5 mm-or-less clearance between the sensor and magnet .

**Part names**

- A** Current Speed
- B** Sensor signal reception icon Flashes in sync with sensor signals.
- C** Sub measurement icon
- D** Pace arrow  
Indicates whether the current speed is faster or slower than the average speed. (▲ Faster ▼ Slower)
- E** Auto mode icon
- F** Speed unit **km/h mph**
- G** Mode symbol **D**  
Indicates the mode currently selected.
- Tm (Tm 2)** ..... [Elapsed Time]
- Dst (Dst 2)** ..... [Trip Distance]
- Av (Av 2)** ..... [Average Speed]
- Mx** ..... [Maximum Speed]
- Odo** ..... [Total Distance]
- Clock** ..... [Clock]

- H** Wheel size icon
- I** Backlight button
- J** Battery Case Cover

**Starting/Stopping measurement**

This computer allows automatic (Auto-mode) or manual measurement. During measurement, the speed unit icon flashes. The maximum speed and total distance will update, regardless of measurement.

**Auto-mode (automatic measurement)**

If the icon is visible, measurement is automatic. In Auto-mode, starting/stopping measurement using the START/STOP button is impossible.

**Manual measurement**

If the icon does not light, starting/stopping the measurement using the START/STOP button is possible.  
\* Use the menu screen to toggle between Auto-mode ON and OFF. For further information, see the MENU FLOW.

**Switching Mode symbol** **D**

Press the MODE button to switch measurement according to the OPERATION FLOW.  
Press the MODE button for 2 seconds to switch from Main to Sub measurement.

**Sub measurement**

When Main measurement starts/stops, Sub measurement starts/stops accordingly. Note, however, that the main and sub measurements must be reset individually.  
Resetting Main and Sub measurement at different times allows interval measurement to be carried out.  
\* In the sub measurement the pace arrow compares the current speed to average speed 2.

**Resetting data** ..... Main : Sub :

To reset measurement data, display the Main/Sub measurement data and press the START/STOP and MODE buttons simultaneously. Trip distance is not reset.

**Backlight**

Press the backlight button to illuminate the display for 3 seconds. If the battery is low, the wheel size icon flashes and the display does not illuminate.

**Power-saving function**

If the computer has not received a signal for 10 minutes, power-saving mode will activate and only the clock will be displayed. When the computer receives a sensor signal again, the measuring screen reappears. If two weeks' inactivity elapses, power-saving mode will change to SLEEP mode. Pressing the MODE or START/STOP button in SLEEP mode brings up the measuring screen.

**Dual Wheel Size**

Two wheel sizes (Wheel sizes and ) can be registered on the computer. This is useful when the computer is shared between two bicycles or when one bicycle uses different wheel sizes at different times. Wheel size B has pre-programmed for a 26x1.95" size tire.

\* Use the menu screen to toggle between and . For further information, see the MENU FLOW.

**Changing the computer settings**

If the MENU button is pressed with the measuring screen displayed, the menu screen appears. Press the START/STOP button when measurement has stopped and no signal is being received to change menu settings.

**Setting the clock**

Set the clock via Settings in the MENU FLOW.  
\* For the Speed unit, reset Main and Sub measurement data before changing settings.  
\* For further information, see the MENU FLOW.

**Maintenance**

To clean the computer or accessories, use diluted neutral detergent on a soft cloth, and then wipe it off with a dry cloth.

**Troubleshooting**

No display.  
Is battery in the computer run down?  
Replace it, and re-enter the correct information. (All Clear ).  
Incorrect data appears.  
Do all clear operation. (All Clear ).  
Pressing the START/STOP button does not calculate Elapsed Time.  
Is the icon illuminated?  
To start/stop measurement using the START/STOP button, turn off Auto-mode.

The sensor signal icon does not flash. (The speed is not displayed.)  
[If the signal icon does not flash, reduce the distance between the sensor and computer, adjust the position of the magnet, and spin the wheel again. If the icon now flashes, this indicates that the computer and sensor are too far apart or that the battery is low.]

Is the clearance between the sensor and magnet too great?  
Does the magnet pass through the sensor zone?  
Adjust the positions of the magnet and sensor.

Is the computer installed at the correct angle?  
Install the computer with its bottom surface facing the sensor.  
Is the distance between the computer and sensor too great?  
Install the sensor closer to the computer.

Is the sensor battery weak?  
In winter, battery performance degrades.  
Replace it.

Is the computer's battery weak?  
Replace it with a new one. (All Clear ).

**Replacing the Battery**

**Computer**

If the Wheel Size icon ( or ) flashes, replace the battery. The Total Distance can be entered manually. Before removing the battery, note the current Total Distance. Install a new lithium battery (CR2032) with the (+) side facing upward. Then re-start the computer according to the SETTING procedure, and then set the clock from the MENU FLOW.

**Sensor**

If sensor reception is poor, replace the battery. Then check the positions of the battery and magnet.

**Specification**

Battery ..... Computer: Lithium Battery CR2032 X 1  
Sensor: Lithium Battery CR2032 X 1  
Battery Life ..... Computer: approx. 1 year (If the computer is used for 1 hour/day without the backlight on)  
Sensor: until Total Distance reaches about 10,000 km (6,250 mile)  
\* This is the average figure of being used under 20°C temperature and the distance between the computer and the sensor is 65 cm.  
\* If the backlight is used frequently, the battery life diminishes accordingly.  
Controller ..... 4-bit 1-chip microcomputer (crystal controlled oscillator)  
Display ..... Liquid crystal display  
Sensor ..... No contact magnetic sensor  
Wheel Circumference Range ..... 0100 mm - 3999 mm (default figure A : 2095 mm, B : 2050 mm)  
Working Temperature ..... 0°C - 40°C (32°F - 104°F)  
Dimension/Weight ..... 52.5 x 38 x 22 mm [2-3/32" x 1-1/2" x 7/8"] / 30 g [1.06 oz]

\* The factory-loaded battery life might be shorter than the above-mentioned specification.  
\* The specifications and design are subject to change without notice.

**Standard Parts**

**#169-6590**

Parts Kit

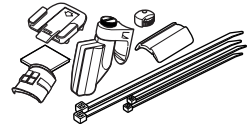

**#169-6580**

Speed Sensor A

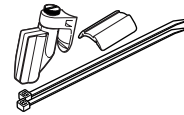

**#169-6570**

Bracket kit



**#169-9691**

Wheel Magnet



**#166-5150**

Lithium Battery (CR2032)



**Option Parts**

**#169-6667**

Center Mount Kit

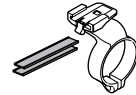

**#169-9760**

Magnet for Composite Wheel

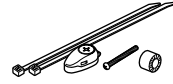

**#169-9690**

Hi-Power Wheel Magnet



This device complies with Part 15 of the FCC Rules. Operation is subject to the following two conditions: (1) This device may not cause harmful interference, and (2) this device must accept any interference received, including interference that may cause undesired operation.  
**Modifications** The FCC requires the user to be notified that any changes or modifications made to this device that are not expressly approved by CatEye Co., Ltd. may void the user's authority to operate the equipment.

**LIMITED WARRANTY - 2-Year Computer/Sensor only**

(Accessories/Attachments and Battery Consumption excluded)

If trouble occurs during normal use, the part of the Main Unit or sensor will be repaired or replaced free of charge. The service must be performed by CatEye Co., Ltd. To return the product, pack it carefully and remember to enclose the warranty certificate with instruction for repair. Please write or type your name and address clearly on the warranty certificate. Insurance, handling and transportation charges to our service shall be borne by person desiring service.

**CATEYE CO., LTD.**

2-8-25, Kuwazu, Higashi Sumiyoshi-ku, Osaka 546-0041 Japan  
Attn: CATEYE Customer Service Section

**Service & Research Address for USA**

CATEYE Service and Research Center  
1705 14th St. 115 Boulder, CO 80302  
Phone: 303.443.4595  
Toll Free: 800.5CATEYE  
Fax: 303.473.0006  
E-mail: service@cateye.com  
URL: http://www.cateye.com