

Wireless Professional Weather Station

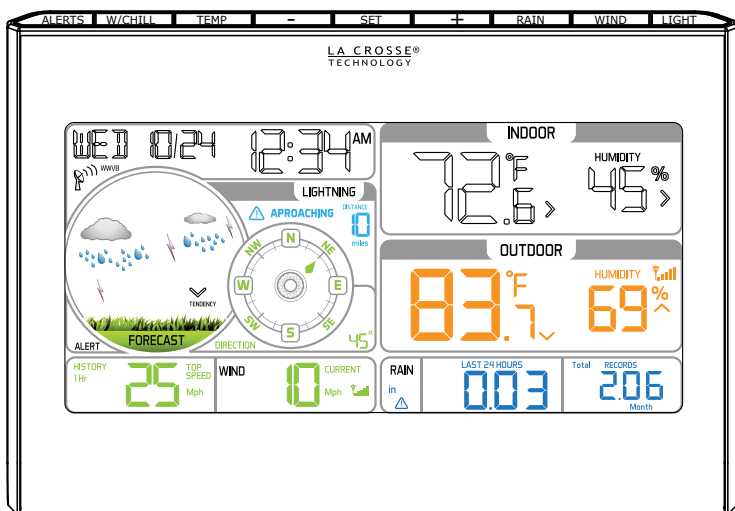
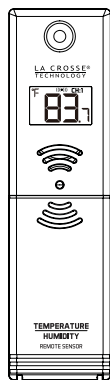
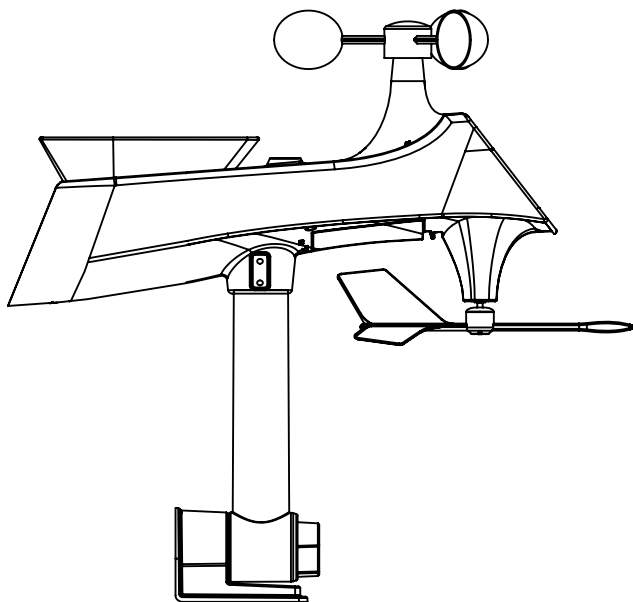

Table of Contents

Setup Preparation	2
Search for Temperature/Humidity Sensor	2
Search for Multi-sensor	2
Initial Setup and Assembly	3
Mounting Instructions	6
Mounting Continued	7
LCD Features	8
LCD Features Continued	9
Button Functions	10
Settings: Time, Date, Units	11
Wind Speed Readings	13
Reset Wind Speed History	13
Wind Direction Readings	14
Lightning Detection Readings	14
Rainfall Readings	15
Reset Rainfall History	15
HIGH/LOW Temperature and Humidity Readings	16
Reset HIGH/LOW Temperature and Humidity Readings	16
Wind Chill, Heat Index, Dew Point Readings	17
Ice Alert	17
Set Weather Alerts	18
Temperature/Humidity Trend Arrows	21
Color Weather Forecast	21
Forecast Tendency Arrows	22
WWVB Atomic Time Signal Search	22
Replace Windcups	23
Replace Directional Vane	23
Multi-sensor Solar Panel	24
Factory Reset/Clear Memory	24
Care and Maintenance	25
Warranty and Support	25
Specifications	26
FCC Statement	27
Canada Statement	27

Setup Preparation

Welcome!

Here are some items needed to setup your station (not included):

1. Phillips head screwdriver for assembly.
2. Fresh Batteries: 5 (five) AA alkaline or lithium batteries for the sensors.
3 (three) AAA alkaline batteries for the station (optional).

For best results:

- Remove weather station and sensors from the package and place together on a table or bench, within easy reach.
- Place batteries and screwdriver within reach of setup location.
- Keep sensors and weather station 5-10 feet apart for the first 15 minutes after installing batteries.
- Each sensor reads independently to the weather station. Before permanently mounting sensors, place them in desired location for 1 hour to be sure there is a steady reading to the weather station.
- Maximum transmission range is 330 ft. (100 m) open air.
- If sensor connection is lost, search for the sensors.

Search for Temperature/Humidity Sensor

- Hold the **TEMP** button for 2 seconds to search for the sensor.
- The tower icon will flash for 3 minutes indicating the search.

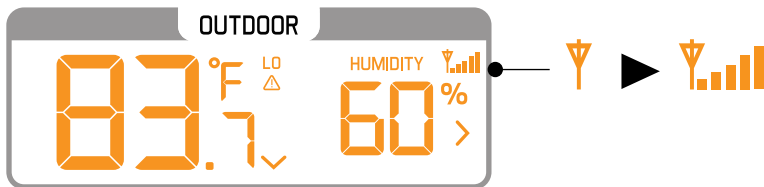

Search for Multi-sensor

- Hold the **WIND** button for two seconds.
- The tower icon will flash for 3 minutes indicating the search.



Initial Setup and Assembly

TX231RW Multi-Sensor

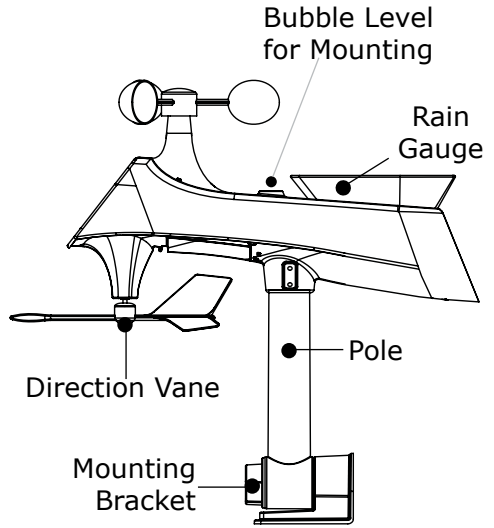
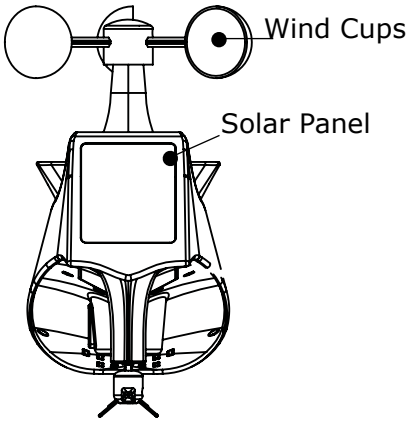

1. Install 3 AA batteries into the bottom of the Multi-sensor.
2. The red LED light on the bottom, will flash every 30 seconds when transmitting.

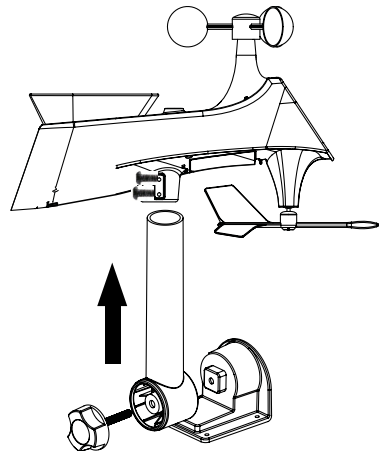
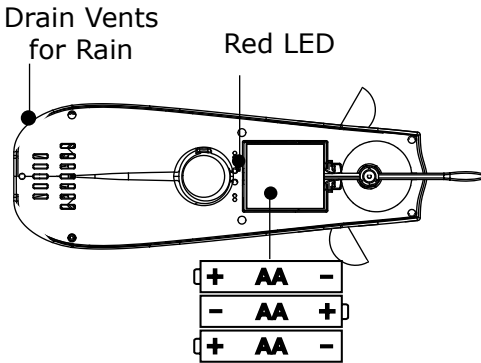

3. Insert pole into bottom of sensor and secure with two screws.

Note: Your own mounting pole (1.2 inches, 3.1 cm, not included) may be inserted into the sensor, instead of using the mounting bracket and pole included.

4. Align the square opening on the bottom or the pole over the square of the mounting bracket.

5. Turn the knob to tighten the bracket to the pole.

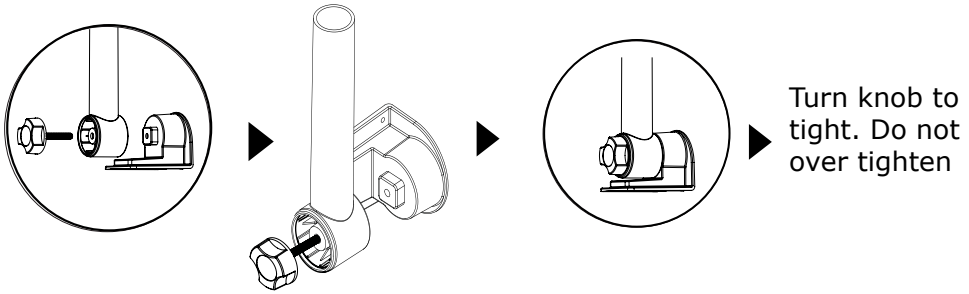

TX232TH Sensor

1. Insert 2 AA batteries into the temperature/humidity sensor.
2. The red LED light will flash every 58 seconds when transmitting.
3. The transmission icon will show briefly when transmitting.
4. You can select a different channel on the sensor if you suspect interference.

Note: Two hours after initial setup, the temperature/humidity sensor will search for the Atomic time signal.

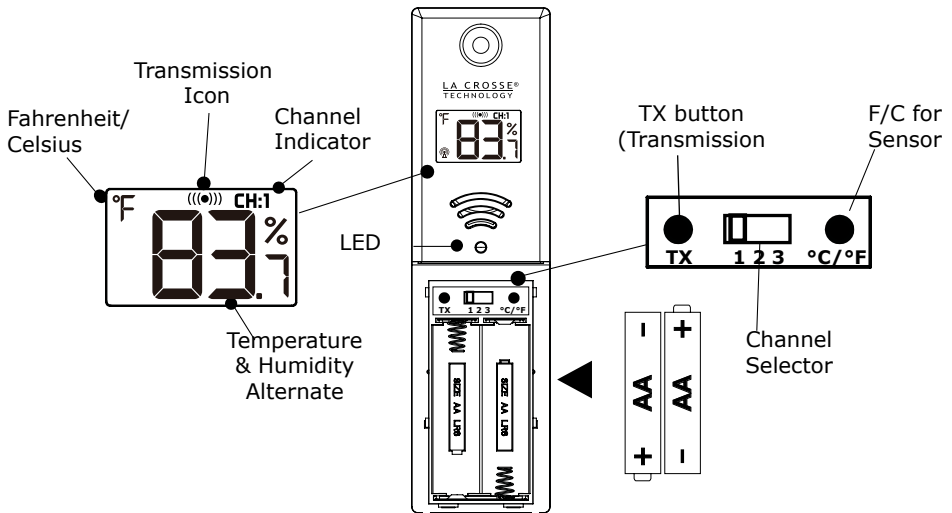

Note: At temperatures below 14°F (-10°C) the sensor display will turn off to protect the LCD. Sensor will still transmit data.

Weather Station

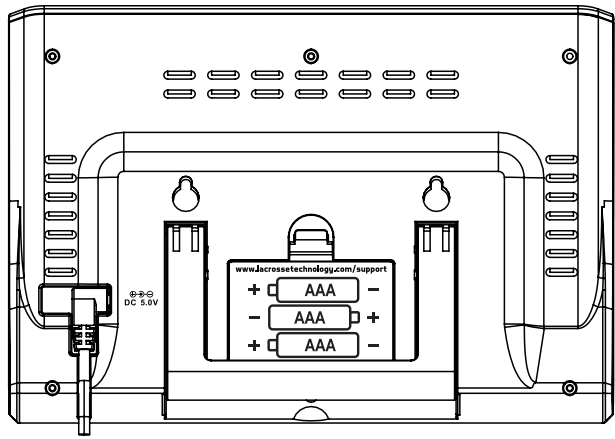
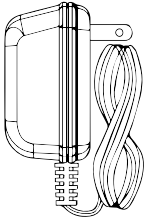

1. Insert the 5 volt AC adapter into the back of the weather station.
2. Insert 3 AAA batteries into the weather station (optional).
3. Keep both sensors and the weather station together for 15 minutes to lock in the sensor signals.
4. (Optional)-Spin the wind cups to simulate wind speed. Take the Multi-sensor to the sink and slowly drip water into the rain bucket to simulate rain.
5. After 15 minutes, follow the mounting instructions for proper placement of each sensor.

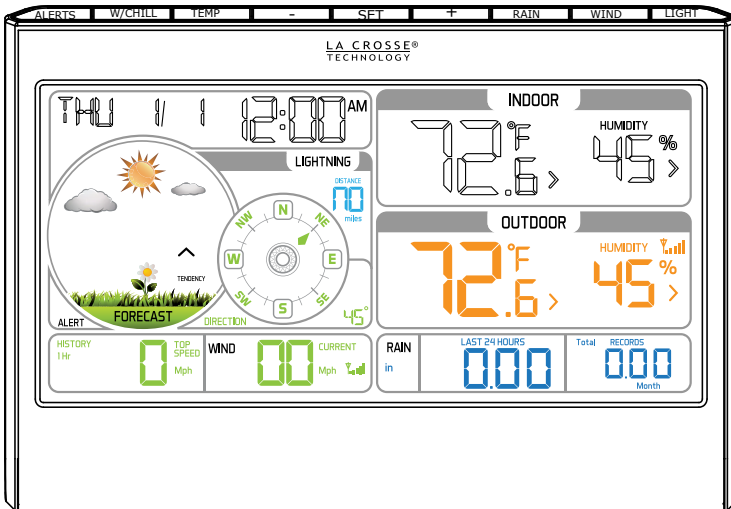

Note: Your weather station should have readings in all sections. Wind and Rain will show 0's (connected) until wind or rain occur or are simulated.

Mounting Instructions

TX232TH-LCD Temperature/Humidity Sensor

Option 1:

- Install one mounting screw into a wall leaving some extended.
- Place the transmitter onto the screw, gently pull the transmitter down to lock the screw into place.

Option 2:

- Insert the mounting screw through the front of the transmitter and into the wall.
- Tighten the screw to snug (do not over tighten).
- Mount the temperature/humidity sensor on a north-facing wall or in a well shaded location. Sun will make it read high.
- Under an eave or deck rail is preferred.
- Be sure the outdoor sensor is mounted vertically to drain moisture.
- Avoid mounting under a metal roof and use stainless screws for best WWVB reception and RCC transmission.
- The maximum wireless transmission range to the weather station is over 330 feet (100 meters) in open air, not

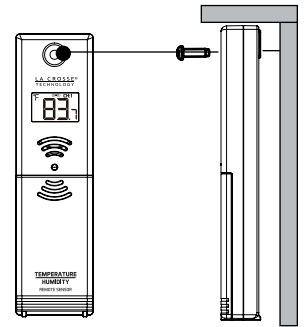
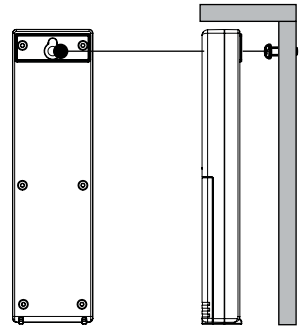

TX231RW Multi-sensor

- For most accurate wind speed and rainfall readings, mount the Multi-sensor in an open area clear for 50 feet in all directions.
- Mount with the solar panel facing south so the wind direction is correct. See N, S, E W, embossed on the top of the sensor.
- Use the bubble level on the top of the sensor to ensure it is level, for accurate rainfall readings.

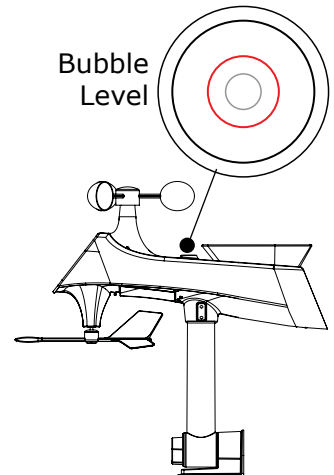

Mounting continued

- The maximum wireless transmission range to the station is over 330 feet (100 meters) in open air, not including walls or trees.
- Mount sensor vertically.
- Cups should be on the top of the sensor.
- Attach to mounting surface with screws through the mounting bracket.
- The sensor can be mounted from the bottom or from the side.

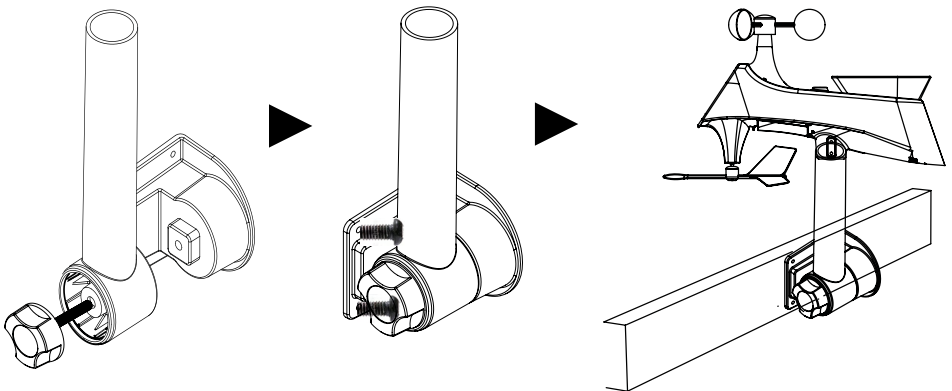
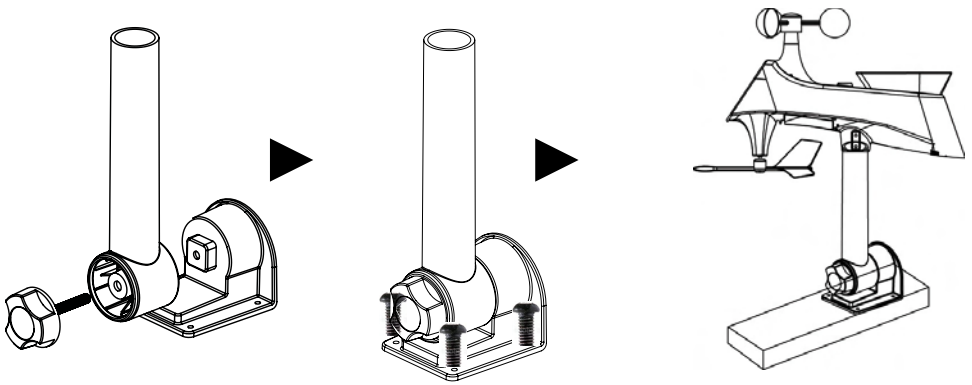

Alternatively:

- Insert your own mounting pole sensor.
- Tighten screws
- Mounting bracket would not be used.

LCD Features

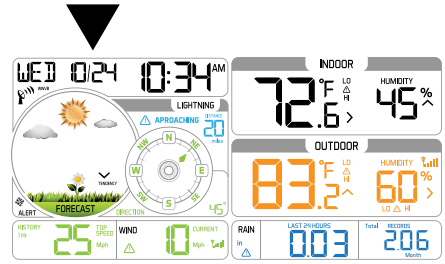
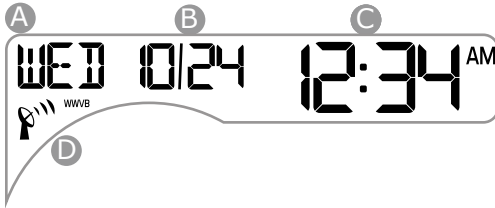

Time/Date

- A Weekday
- B Month/Date
- C Hours/Minutes
- D Atomic Time Signal Icon

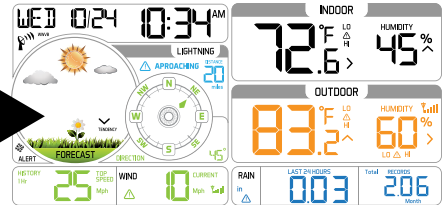
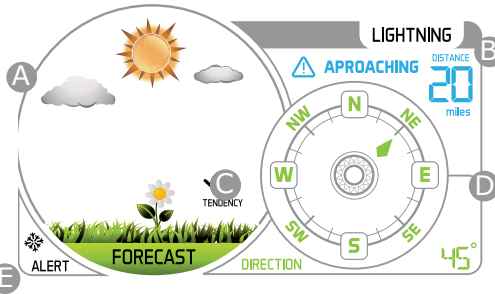

Forecast, Lightning, Wind Direction

- A Animated Forecast
- B Lightning Detection
- C Forecast Tendency Arrow
- D Wind Direction Compass Rose
- E Frost Alert Icon
- F Wind Direction Degrees/Letters

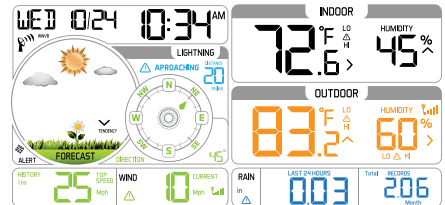
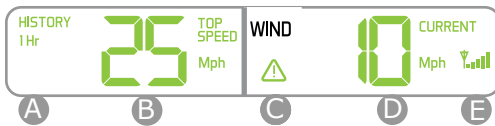

Wind Speed/History

- A Wind History (1 Hour Default)
- B Top Speed (Last 60 minutes)
- C Wind Speed Alert Icon
- D Current Speed (30 Second Average)
- E Multi-sensor Reception

LCD Features continued

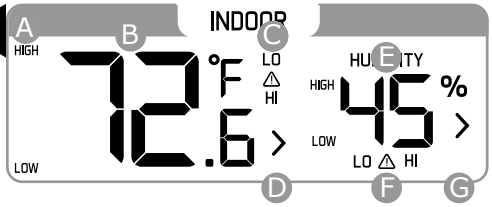
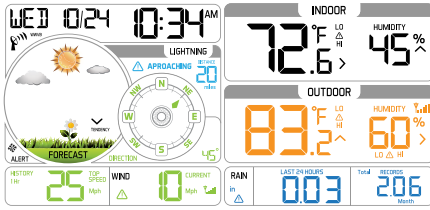

Indoor Temperature/Humidity

- A HIGH/LOW Temp. Records
- B Indoor Temperature
- C Temperature Alert Icons
- D Temperature Trend Arrow
- E Indoor Humidity
- F Humidity Alert Icons
- G Humidity Trend Arrow

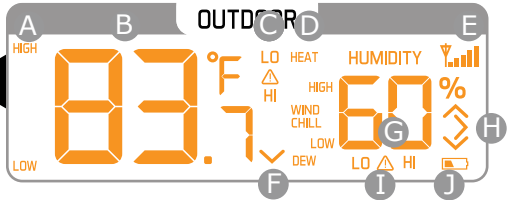
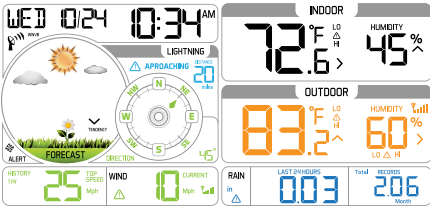

Outdoor Temperature/Humidity

- A HIGH/LOW Temperature Records
- B Outdoor Temperature
- C Temperature Alert Icons
- D Heat Index/Wind Chill/Dew Point
- E Temperature Reception Icon
- F Temperature Trend Arrow
- G Outdoor Humidity
- H Humidity Trend Arrow
- I Humidity Alert Icons
- J Low Battery Icon-TH Sensor

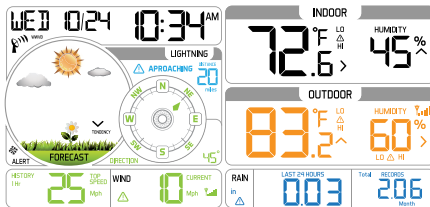

Rainfall

- A Rainfall Alert Icon (24 Hours)
- B 24 Hour Running Rainfall Total
- C Rainfall History Records (1 hour default)

Button Functions



ALERTS

Normal Alerts:

- Hold 2 seconds to enter alert setting mode

Alerts Mode:

- Press to confirm and move to next item

W/CHILL

Normal Alerts:

- Press once to view Wind Chill
- Press twice to view Heat Index
- Press 3 times to view Dew Point

TEMP

Normal Alerts:

- Hold 2 seconds to search for TH sensor
- Press and release to view HIGH/LOW temperature and humidity with time stamp

MINUS

Setting Mode and Alert Mode:

- Press to decrease value by one
- Hold to decrease quickly

Wind, Rain, Temp Mode:

- Hold 5 seconds to reset select readings to current

Alert Mode:

- Press to arm/disarm alerts

SET

Setting Mode and Alert Mode:

- Press to decrease value by one
- Hold to decrease quickly

Wind, Rain, Temp Mode:

- Hold 5 seconds to reset readings to current

PLUS

Setting Mode and Alert Mode:

- Press to increase value by one
- Hold to increase quickly

Alerts Mode:

- Press to arm/disarm alerts

RAIN

Normal Mode:

- Press and release to show 1hr, 24hr, 7days, month, year and total of rainfall
- The reading will display and stay on the record selected

WIND

Normal Mode:

- Press to show 1 hour, 24 hour, 7 days, month and year of max wind speed
- If user doesn't press this button, the unit will return to normal display 1 hour, after 30 seconds
- Hold for 2 seconds to search for the Multi-sensor

LIGHT

Normal Mode:

- Press to change the LCD backlight brightness: HI/LOW/OFF
- Press this button to open back light for 10 seconds. (without adapter)

Wind, Rain, Temp, Alerts Mode:

- Press to exit any setting mode

Settings: Time, Date, Units

- Hold the **SET** button two seconds to enter time set mode.
- Press the **+** or **-** buttons to adjust the values.
- Hold the **+** or **-** buttons to adjust quickly.
- Press the **SET** button to confirm adjustments and move to the next item.
- Press the **LIGHT** button at any time to exit.

Setting order:

1. BEEP ON/OFF
2. WWVB ON/OFF (Atomic Time Signal) 
3. Time Zone
4. DST ON/OFF (Daylight Saving Time Indicator)
5. Hour and Minutes
6. Year, Month and Date
7. Calendar format Month/Day or Day/Month
8. Fahrenheit or Celsius
9. Rainfall Inches or Millimeters
10. Wind Direction in degrees or cardinal direction
11. Wind Speed MPH or KPH
12. Lightening Miles or Kilometers

Note: Press the **LIGHT** button at any time to exit or wait 30 seconds without pressing a button.

1. Beep ON (default) or OFF



2. WWVB ON (default) or OFF

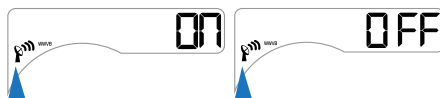

3. Select Time Zone (EST Default)

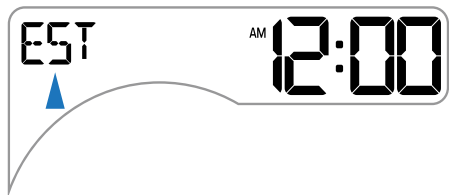

Time Zone	
AST	Atlantic
EST	Eastern
CST	Central
MST	Mountain
PST	Pacific
AKT	Alaska
HAT	Hawaiian

4. Select DST ON (default) or OFF



5. Set Hours and Minutes



6. Set Year and Month



7. Set Date and Date Format



8. Fahrenheit or Celsius



9. Rainfall IN or MM



10. Direction: degrees or letters

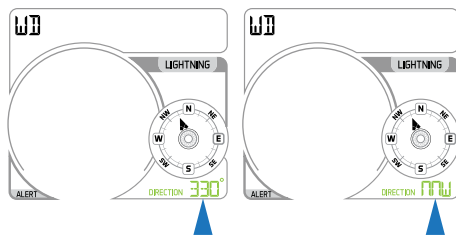

11. Wind speed MPH or KPH

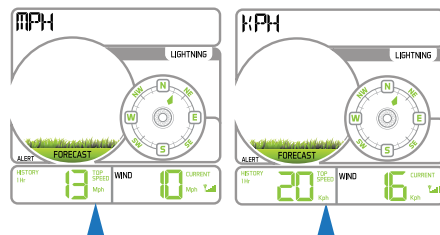

12. Lightening miles / kilometers

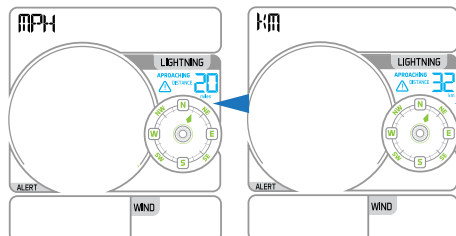

Wind Speed Readings-Updates Every 30 seconds

Current Speed: 30 second average of the wind speed.

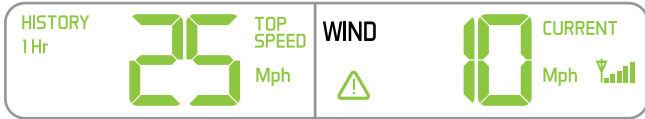

Top Speed: Highest instantaneous reading in the past 60 minutes. Updates, when a higher wind speed has occurred.

Wind History:

Press and release the **WIND** button to view the maximum wind history values.

- One Hour: past 60 minute period (default record no time stamp)
- 24-hour: Past 24 hour period, from last record
- 7 Days: Past 7-day period, from last record
- Month: Defined by Calendar Month i.e. January 1 - January 31
- Year: Defined by Calendar Year i.e. January 1 - December 31

24 Hour

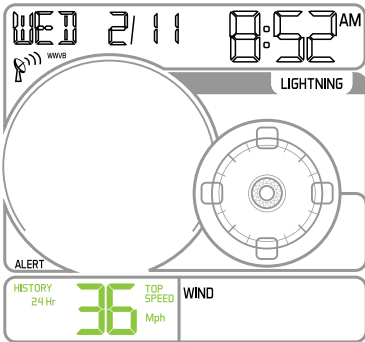

7 Days

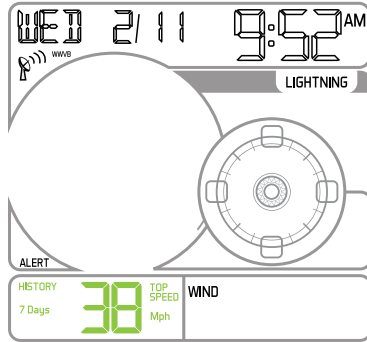

Month

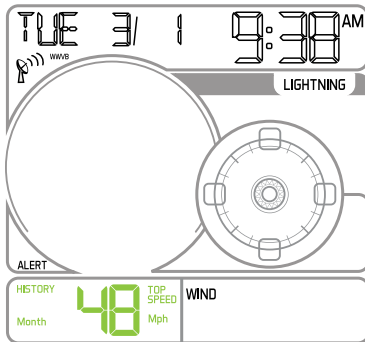

Year

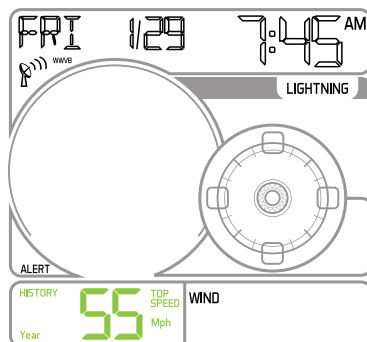

Reset Wind Speed History:

- While viewing individual values, hold the **MINUS** button for five seconds to reset the value.
- Wind Speed, time and date stamp will reset to current.

Wind Direction Readings

Compass Rose:

- The Compass Rose displays the cardinal directions in usable format.
- The large diamond on the rose indicates the wind direction.

Degrees or Letters:

- Below the rose the wind direction is displayed in degrees.
- In the settings section, you can choose the direction to display in letters. EX: 40° would read as NE.

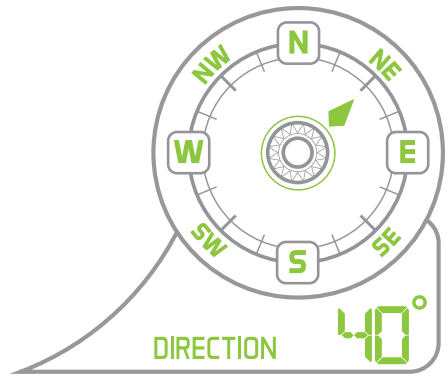

Lightning Detection Readings

The lightning detection sensor tracks the EMP (Electro Magnetic Pulse) emitted by a discharge up to 25 miles away.

- Indicates the *closest* discharge (miles or kilometers) to your sensor.
- This sensor is not designed to count the number of Cloud-to-Ground or Cloud-to-Cloud discharges.
- When a closer discharge occurs the number will update.
- After 60 minutes of no closer discharge, NO will be displayed.
- If additional discharges are farther away, the number displayed remains the closest discharge.
- In the settings menu you can select to display approaching distance in miles or kilometers.



Lightning Detected 10 miles from your sensor in the past 20 minutes



No Lightning

Note: On occasion, turning on florescent lights, magnetic switches, or other electrical discharges may provide a false lightning reading.

Rainfall Readings

Last 24 Hours: Total rain that occurred from now, back 24 hours.
24 hour rainfall is constantly displayed.



Press and release the **RAIN** button to view rain history:

- **One Hour:** past 60 minute periods (default record no time stamp)
- **Day:** 24 hr period from 12:00am - 11:59pm. With time stamp
- **7 Days:** Past 7-day period, from last record
- **Month:** Defined by Calendar Month i.e. January 1 - January 31
- **Year:** Defined by Calendar Year i.e. January 1 - December 31
- **Total:** running total since station was powered up.

Day 12:00am - 11:59pm

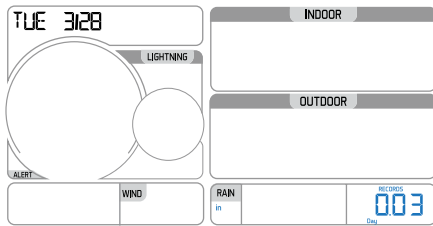

7-day

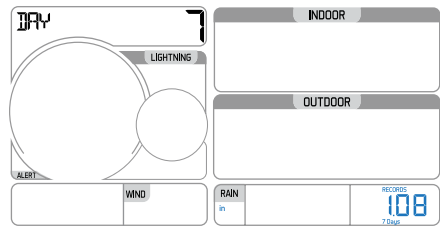

Month

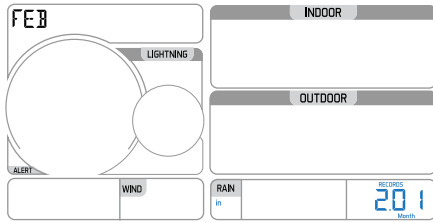

Year

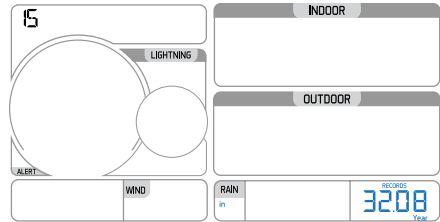

Total (since setup)

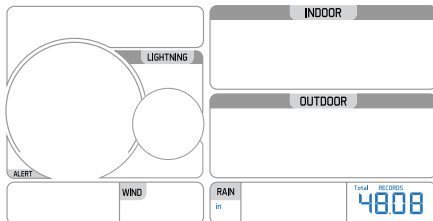

Reset Rainfall History:

- While viewing individual values, hold the **MINUS** button for five seconds to reset the value.
- Rainfall, time and date stamp will reset to current.

High/Low Temperature/Humidity Readings

View: Press and release the **TEMP** button to view indoor and outdoor temperature/humidity values with time and date.

- Indoor temperature HIGH
- Indoor temperature LOW
- Indoor humidity HIGH
- Indoor humidity LOW
- Outdoor temperature HIGH
- Outdoor temperature LOW
- Outdoor humidity HIGH
- Outdoor humidity LOW

Indoor Temperature HIGH

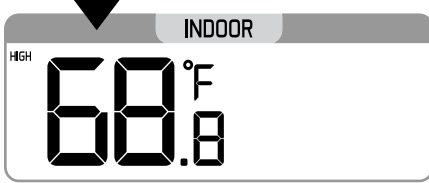

Indoor Temperature LOW

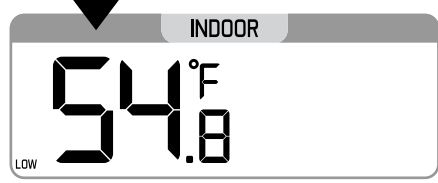

Indoor Humidity HIGH

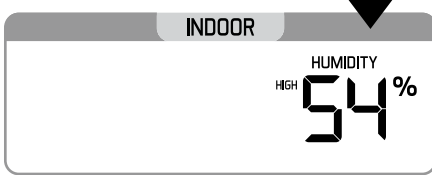

Indoor Humidity LOW

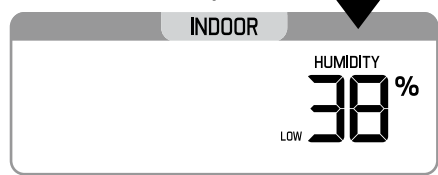

Outdoor Temperature HIGH

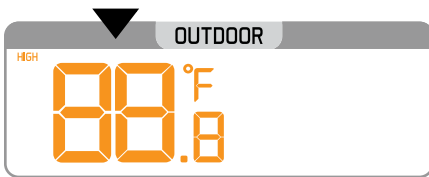

Outdoor Temperature LOW

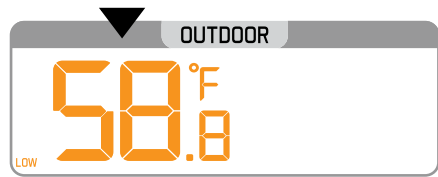

Outdoor Humidity HIGH



Outdoor Humidity LOW

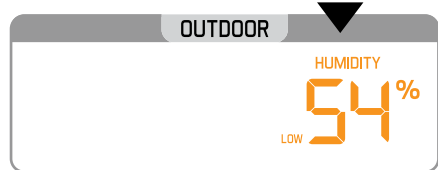

Reset High/LOW Temperature/Humidity Records:

- While viewing individual values, hold the **MINUS** button for five seconds to reset the value.
- Temperature, humidity, time and date stamp will reset to current.

Wind Chill-Heat Index-Dew Point Readings

- Press **W/CHILL** button once to view Wind Chill
- Press twice to view Heat Index
- Press 3 times to view Dew Point

Wind Chill °F

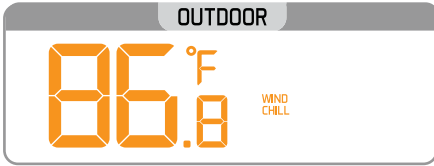

Wind Chill °C

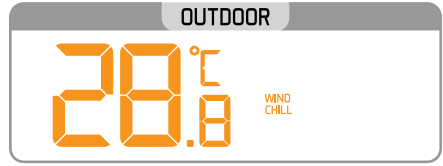

Heat Index °F

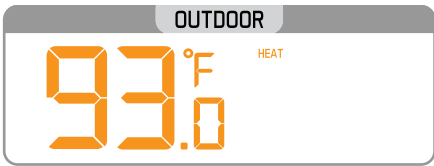

Heat Index °C

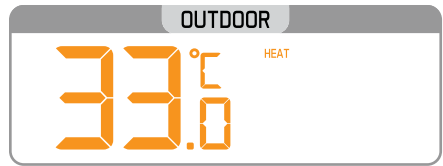

Dew Point °F

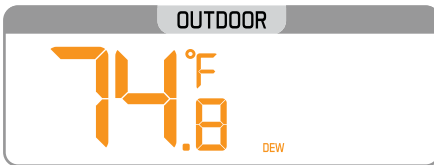

Dew Point °C

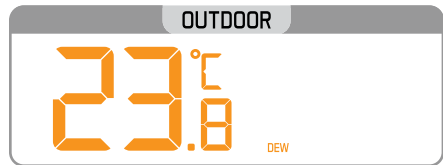

Ice Alert

Ice Alert Range:

- 28.4 °F to 37.4 °F (-2 °C to 3 °C)
- When the outdoor temperature reaches the ice alert range, the ice alert icon will flash (no sound)
- When the temperature is above 37.4 °F (3 °C) or below 28.4 °F (-2 °C), the alert icon will not show.

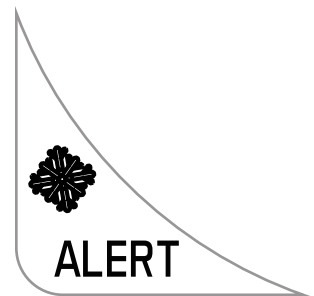

Set Weather Alerts

Important:

- The alerts menu is in the order listed below.
- Leave an alert OFF (disarmed) to skip setting that alert value.
- The alert icon will show when the alert is active. 
- When armed alert value is reached, station will beep until a button is pressed. The flashing alert icon will indicate if is a LOW or HI alert.
- Press any button to stop the temp alert sound. The alert icon will flash while value is in alert range.

Alert Setting Order:

- Indoor LOW Temperature ON/OFF
- Indoor LOW Temperature Value 32°F to 122°F (0°C to 50°C)
- Indoor HIGH Temperature ON/OFF
- Indoor HIGH Temperature Value 32°F to 122°F (0°C to 50°C)

- Indoor LOW Humidity ON/OFF
- Indoor LOW Humidity Value 10%RH-99%RH
- Indoor HIGH Humidity ON/OFF
- Indoor HIGH Humidity Value 10%RH-99%RH

- Outdoor LOW Temperature ON/OFF
- Outdoor LOW Temperature Value -40°F-140°F (-40°C-60°C)
- Outdoor HIGH Temperature ON/OFF
- Outdoor HIGH Temperature Value -40°F-140°F (-40°C-60°C)

- Outdoor LOW Humidity ON/OFF
- Outdoor LOW Humidity Value 10%RH-99%RH
- Outdoor HIGH Humidity ON/OFF
- Outdoor HIGH Humidity Value 10%RH-99%RH

- Lightning ON/OFF
- Lightning Value 0-25 miles (0-40 kilometers)

- 24-hour Rainfall ON/OFF
- 24-hour Rainfall Value 0-393 inches (0-99.9mm)

- Top Wind Speed ON/OFF
- Top Wind Speed Value 0-111.8 (0-180kph)

To set alerts:

1. Hold the **ALERTS** button to enter alert set mode
2. Indoor LOW temperature alert OFF will show.

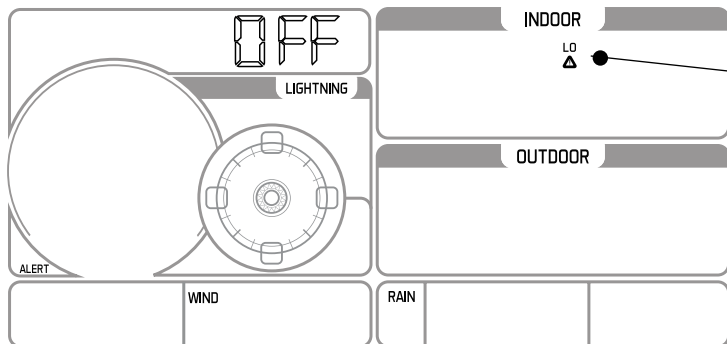

Indoor LO Alert
OFF (unarmed)

Choose ON:
(+/- button)

Skip:
(ALERTS button)

3. If you wish to set this alert value, press the **+** or **-** buttons to arm this alert (ON).

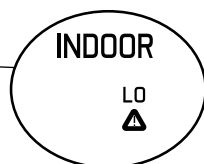
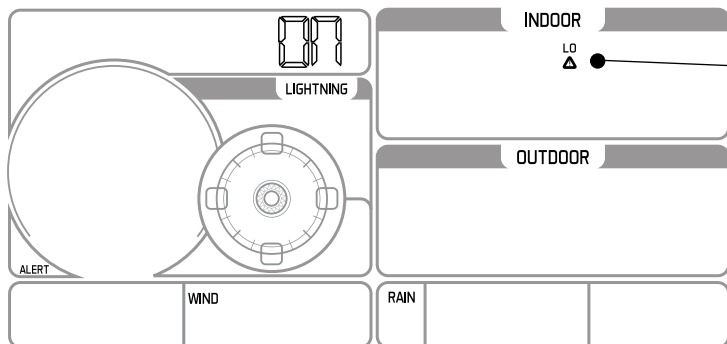

Indoor LO Alert
ON (armed)

Press ALERTS button
to set value

4. When the alert is armed (ON) press the **ALERTS** button to set the alert value.

5. The Indoor LOW temperature alert value will flash.

6. Press the **+** or **-** buttons to change the alert value.

7. Press the **ALERTS** button to confirm and move to the next alert.

8. Press the **LIGHT** button to exit.

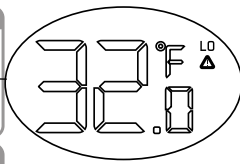
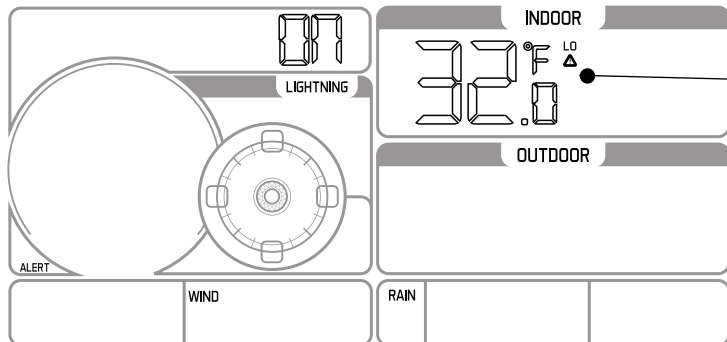

Adjust value:
(+/- button)

9. If you do not wish to set an alert, press the **ALERTS** button again to move to the next alert.

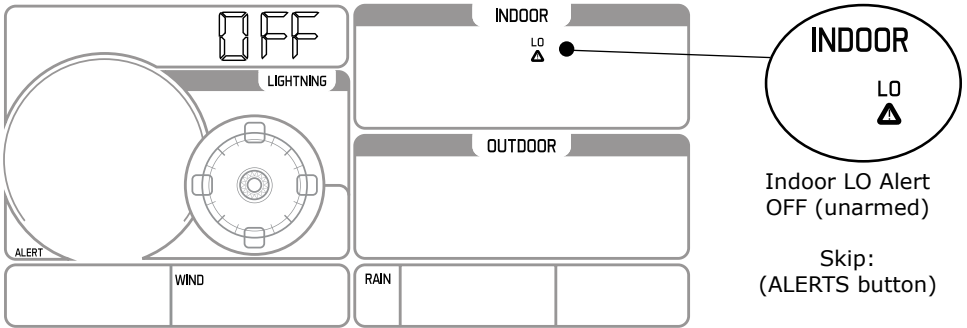

10. If you do not wish to set an alert, press the **ALERTS** button again to move to the next alert.

11. Press and release the **ALERTS** button until you get to the alert you wish to set.

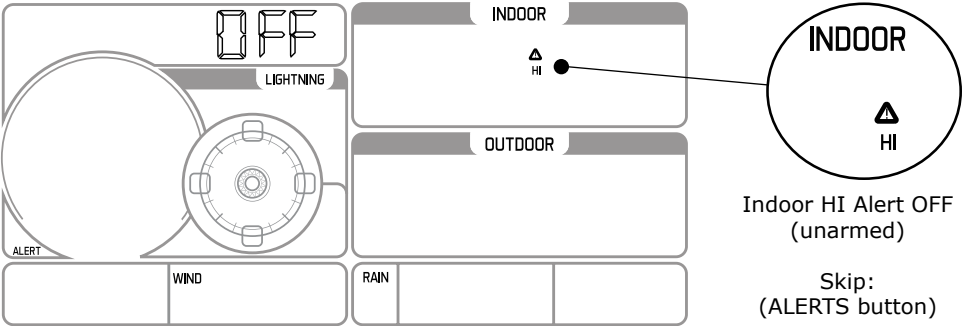

12. To set the alert, first press the **+** or **-** buttons to turn the alert ON.

13. When the alert is armed (ON), press the **ALERTS** button to set the alert value. The alert value will flash.

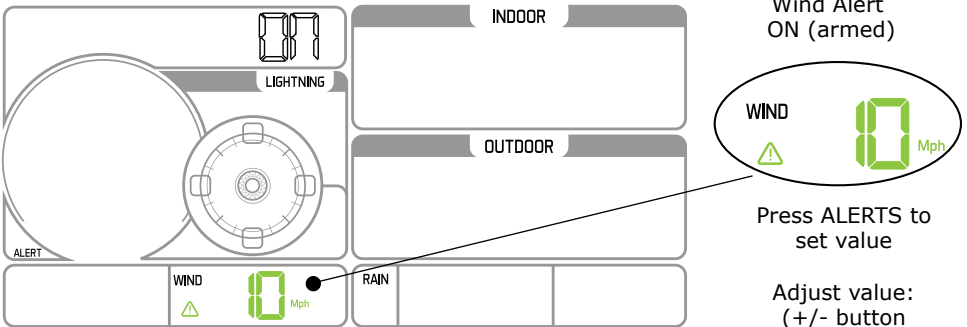

14. Press the **+** or **-** buttons to change the alert value.

15. Press the **ALERTS** button to confirm and move to the next alert.
Or press the **LIGHT** button to exit.



Temperature/Humidity Trend Arrows

The temperature (2°F/1°C) and humidity (3%) trend indicators update every 30 minutes. The trend reflects changes over the past 3 hours. E.G.: At 3:00 — compares to 12:00 data; at 3:30 — compares to 12:30.

Temperature or Humidity increased in past 3 hours 	Temperature or Humidity did not change in past 3 hours 	Temperature or Humidity decreased in past 3 hours 
--	---	--

Color Weather Forecast

Intelligent Weather Forecast:

This station learns. Please allow 30 days for barometric calibration. This will ensure an accurate personal forecast for your location.

Six color forecast icons use changing atmospheric pressure to predict weather conditions for the next 12-hours with 70-75% accuracy.

Sunny

Partly Sunny

Cloudy

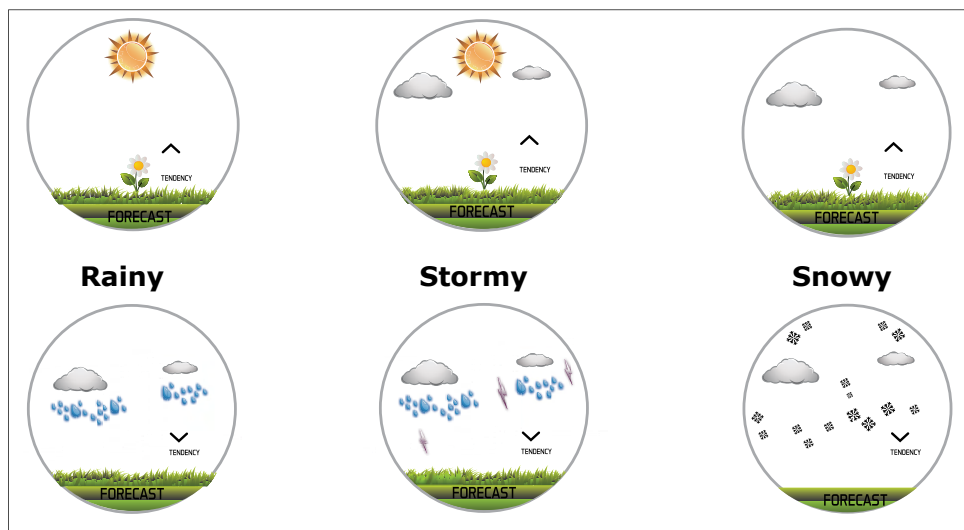

Note: Snowy icon will appear in place of rainy and stormy icons when the outdoor temperature is below 32°F.

Forecast Tendency Arrows

The forecast trend indicators update every 30 minutes. The trend reflects changes in pressure (1 hPa) over the past 3 hours.

E.G.: At 3:00 — compares to 12:00 data; at 3:30 — compares to 12:30.

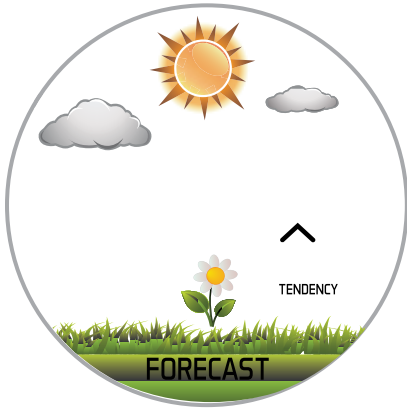

Pressure is rising, weather expected to improve



Pressure is unchanged



Pressure is falling, weather expected to worsen

WWVB Atomic Time Signal



- The Temperature/Humidity Sensor receives the Atomic Time Signal (WWVB) from Fort Collins, CO.
- The sensor will search for WWVB signal up to 5 minutes, then return to transmitting temp/humidity. The first search is 2 hours after startup.
- The atomic time search initiates every six hours until successful reception. Each following night.
- The tower icon shows when sensor have received the signal.
- **For information about WWVB visit:**
www.nist.gov/pml/div688/grp40/wwvb.cfm

Replace Wind Cups

1. Loosen the screw on side of cups
2. Remove cups
3. Install new cups
4. Tighten screw

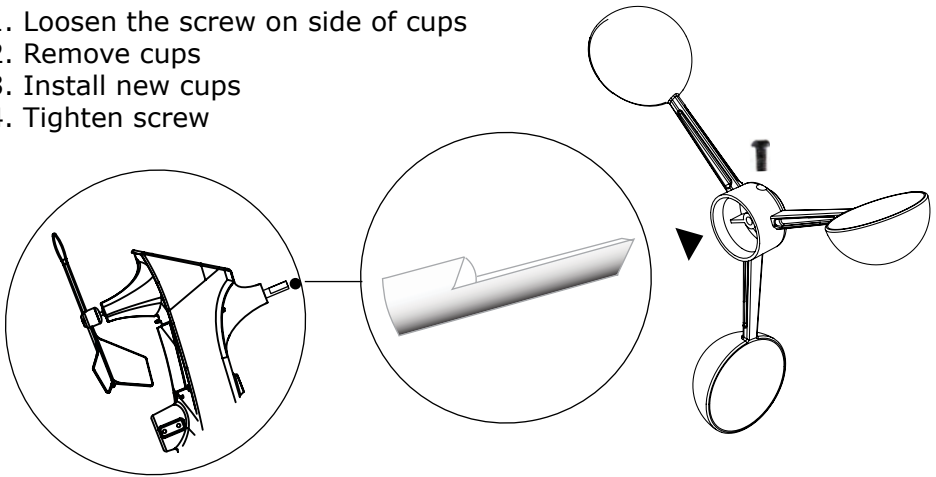

Note: The screw in the wind cups will fit on the flat side of the metal stem on the sensor.

Replace Directional Vane

1. Loosen the screw on side of vane
2. Remove direction vane
3. Install new vane
4. Tighten screw

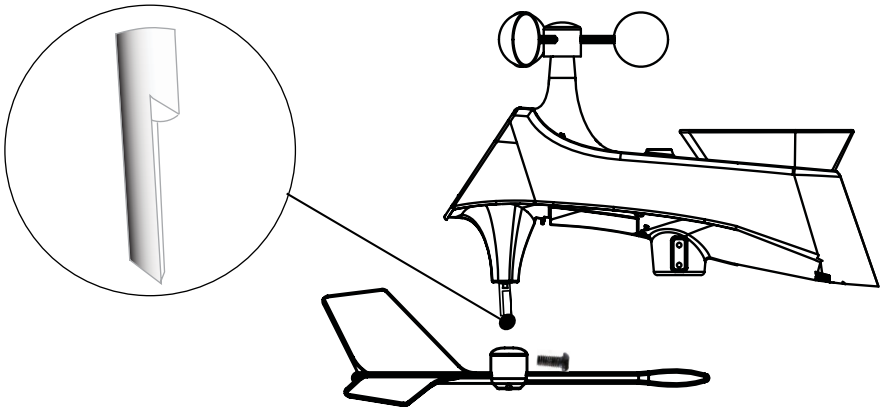

Note: The directional vane attached to the stem on the sensor. The screw will tighten to the flat side of the stem for a secure fit.

Multi-sensor Solar Panel

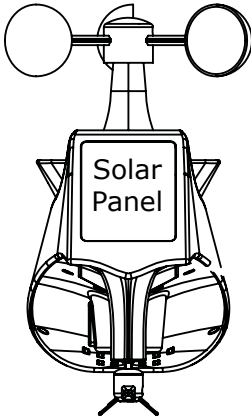

- The solar panel will operate the sensor with sufficient sunlight.
- Batteries are required to operate the sensor at night or days without sufficient sunlight.
- The solar panel extends the battery life.

Factory Reset/Clear Memory



The factory reset will return the weather station to its default settings. This will clear all previous recorded history, so you may want to write down data before taking this step.

1. Hold the **LIGHT** and **ALERTS** buttons together for 5 seconds to reset the weather station, clear all records, and return all settings to default.
2. The weather station will fully populate, then return to a normal display and search for outdoor sensors.
3. While searching for the outdoor sensors the Wind Speed, Outdoor Temperature/Humidity and Rainfall totals will show dashes.
4. Once connected to the outdoor sensors (allow 3 minutes) the Wind Speed, Outdoor Temperature/Humidity, and Rainfall will show current readings.

Note: In the absence of wind or rain, these readings will show 00's, indicating sensor connection.

Care and Maintenance

- Do not mix old and new batteries
- Do not mix Alkaline, Standard, Lithium or Rechargeable Batteries
- Always purchase the correct size and grade of battery most suitable for the intended use.
- Replace all batteries of a set at the same time.
- Clean the battery contacts and also those of the device prior to battery installation.
- Ensure the batteries are installed correctly with regard to polarity (+ and -).
- Remove batteries from equipment which is not to be used for an extended period of time.
- Remove expired batteries promptly.
- Improper use or unauthorized opening of housing voids warranty.
- If the product is not working properly, change the batteries and/or check the AC adapter connection.

Warranty and Support Information

La Crosse Technology, Ltd. provides a 1-year limited time warranty (from date of purchase) on this product relating to manufacturing defects in materials & workmanship.

Before returning a product, please contact our friendly customer support with questions or visit our online help (FAQS):

Phone: 1-608-782-1610

Online Product Support:

www.lacrossetechnology.com/support

Product Registration:

www.lacrossetechnology.com/support/register

View full warranty details online at:

www.lacrossetechnology.com/warranty_info.pdf

Warranty Address:

La Crosse Technology, Ltd
2830 S. 26th St.
La Crosse, WI 54601

Protected under U.S. Patents:

5,978,738 | 6,076,044 | RE43903



Specifications:

Indoor:

- Temperature Range: 32°F to 122°F (0°C to 50°C)
- Humidity Range: 10% to 99% RH
- Update interval: About every 30 seconds

TH Sensor:

- Temperature Range: -40°F to 140°F (-40°C to 60°C)
- Humidity Range: 10% to 99% RH

- Update interval: About every 58 seconds
- Transmission Range: 330 ft (100 m) RF 915MHz open air

Multi-sensor:

- Wind Speed Range: 0-111.8 mph (0-180 kmh)
- Wind Direction: 0-359 degrees

- Rainfall: 0-393.7 inches (0-9999.9 mm)
- Lightning Range: 0-25 miles (0-40 km)

- Update interval: About every 30 seconds
- Transmission Range: 330 ft (100 m) RF 915MHz open air

Power:

- Weather Station: 5-Volt 0.5A adapter included (Primary)
- Adapter Number: K06S5050050U
- Optional Battery: 3-AAA, IEC, LR3 batteries (not included)

- Multi-sensor: 3-AA, IEC, LR6 batteries (not included)

- TH Sensor: 2-AA, IEC, LR6 batteries (not included)

Battery Life:

- Weather Station: 60 to 48 months when using adapter.

- Multi-sensor/TH sensor: over 24 month with reputable batteries

Dimensions:

- Weather Station: 7.60" W x 5.24" H x 0.90" D in
(193.04 W x 133.10 H x 22.86 D mm)

- Multi-sensor: 13.62" W x 13" H x 5.16" D in
(345.95 x 330.20 x 131.06 mm)

- TH sensor: 1.67" W x 6.14" H x 0.83" D
(42.42 W x 155.96 H x 21.02 D mm)

FCC Statement

This equipment has been tested and found to comply with the limits for a Class B digital device, pursuant to part 15 of the FCC Rules. These limits are designed to provide reasonable protection against harmful interference in a residential installation. This equipment generates, uses and can radiate radio frequency energy and, if not installed and used in accordance with the instructions, may cause harmful interference to radio communications. However, there is no guarantee that interference will not occur in a particular installation.

If this equipment does cause harmful interference to radio or television reception, which can be determined by turning the equipment off and on, the user is encouraged to try to correct the interference by one or more of the following measures:

- Reorient or relocate the receiving antenna.
- Increase the separation between the equipment and receiver.
- Connect the equipment into an outlet on a circuit different from that to which the receiver is connected.
- Consult the dealer or an experienced radio/TV technician for help.

This device must not be co-located or operating in conjunction with any other antenna or transmitter.

Operation is subject to the following two conditions:

- (1) This device may not cause harmful interference, and
- (2) This device must accept any interference received, including interference that may cause undesired operation.

Caution!

The manufacturer is not responsible for any radio or TV interference caused by unauthorized changes or modifications to this equipment. Such changes or modifications could void the user authority to operate the equipment.

All rights reserved. This manual may not be reproduced in any form, even in part, or duplicated or processed using electronic, mechanical or chemical process without the written permission of the publisher.

This booklet may contain errors or misprints. The information it contains is regularly checked and corrections are included in subsequent editions. We disclaim any responsibility for any technical error or printing error, or their consequences. All trademarks and patents are recognized.

Canada Statement

This device complies with Industry Canada's licence-exempt RSSs. Operation is subject to the following two conditions:

- (1) This device may not cause interference; and
- (2) This device must accept any interference, including interference that may cause undesired operation of the device.

Le présent appareil est conforme aux CNR d'Industrie Canada applicables aux appareils radio exempts de licence. L'exploitation est autorisée aux deux conditions suivantes :

- (1) l'appareil ne doit pas produire de brouillage;
- (2) l'utilisateur de l'appareil doit accepter tout brouillage radioélectrique subi, même si le brouillage est susceptible d'en compromettre le fonctionnement.