

LA CROSSE®
TECHNOLOGY

Wireless Professional Color Weather Station



SET UP GUIDE

Table of Contents

BASICS		FORECAST		WIND	
Initial Setup	03	Viewing Forecast Data	07	Viewing Wind Data	08
Station Settings	04	Seasonal Foliage	07	Wind Speed Records	09
Buttons	05	Moon Phase	07	Reset Records	09
Atomic Time	06	Pressure Number	08		
LCD Display Brightness	06				
Auto-Dim Settings	06				
RAIN		TEMP. AND HUMIDITY		SENSORS	
Viewing Rain Data	10	Viewing Temperature & Humidity Data	12	Search for Sensors	15
Rainfall Records	10	Temperature & Humidity Records	13	Placement & Mounting	16-18
Reset Records	10	“Feels Like” Temperature & Dew Point	13	Cyclone Sensor Cleaning	19
Rain Cylinder Graph	11	Temperature Decimals	14		
Days Since Last Rain	11	Customizable Alerts	14		
Auto-scroll	11				
SUPPORT		APPENDIX			
Stay in Touch	20	Specifications	21-22		
We’re Here to Help	20	Coin Cell Battery	23		
Warranty & Patents	20	Warnings & Statements	23-24		
Double Warranty Offer	24				

BASICS

Initial Setup

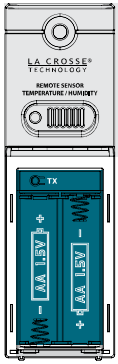

Thermo-Hygro Sensor
(TX141TH-Bv4)

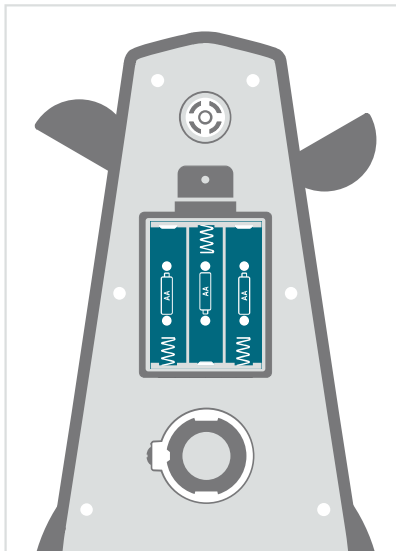

Bottom of Cyclone Sensor
(TX145WSDR)

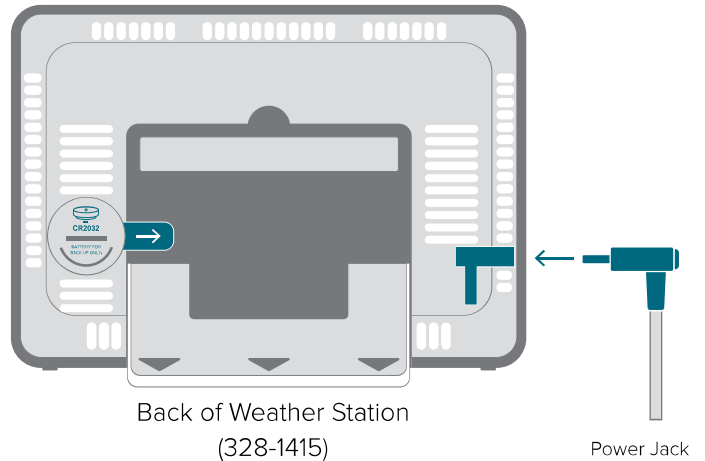

Back of Weather Station
(328-1415)

Power Jack

Power Up

Thermo-Hygro Sensor: Install 2 fresh “AA” batteries according to polarity and replace battery cover. The red LED light will flash when transmitting.

Cyclone Sensor: Install 3 fresh “AA” batteries according to polarity and replace battery cover.

Weather Station: Insert the 5V Power Adapter into an outlet, and then plug it into the Power Jack on the back of the station. Next, remove the Insulation Tab from the Station’s Battery Compartment. About 30 seconds after powering the station on, it will automatically enter the Settings Menu. See the next page for more details.

Note: It may take up to 10 minutes for the sensor data to appear on your station’s screen.

BASICS

Station Settings

1. 30 seconds after powering the station on, it will automatically enter the settings menu.
2. To manually set your time, date, and other settings, hold the **SET** button until the display changes to enter the Settings Menu.

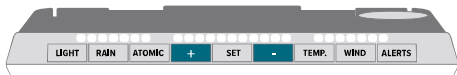

Use the **+/-** buttons on the top of the station to adjust the values.

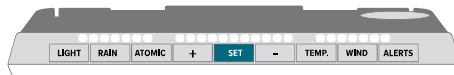

Press the **SET** button to confirm selection and move to next step.

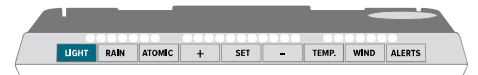

You may exit the Settings Menu at any time by pressing the **LIGHT** button.

Settings Menu Order

Greeting • Language • Beep On/Off • Atomic On/Off • DST (Automatic, All Year, No)
Time Zone • 12/24 Hour Time • Hour • Minute • Year • Month • Date
(Month/Date or Date/Month) • Fahrenheit/Celsius • Decimal On/Off • Pressure Units (InHg/hPa)
Pressure Number Setting* • Rainfall Inches/Millimeters • Wind Speed Units (MPH or KMH)
Wind Direction (Letters or Degrees) • Thank You

* The default pressure reading is 29.92 INHg (1013 hPa).

Notes:

Language: The language selected in this menu will control other menu items as well as your full weekday readout.

Atomic OFF: When Atomic OFF is selected, you will move directly to 12/24 Hour Time setting.

Daylight Saving Time: Select Automatic for DST adjustments at the correct dates during the year.

Weekday: Will set automatically when your Year, Month, and Date are set.

BASICS

Buttons

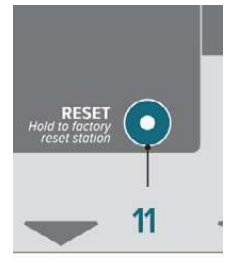
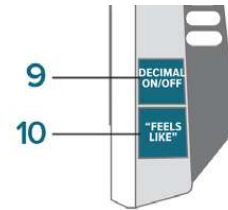
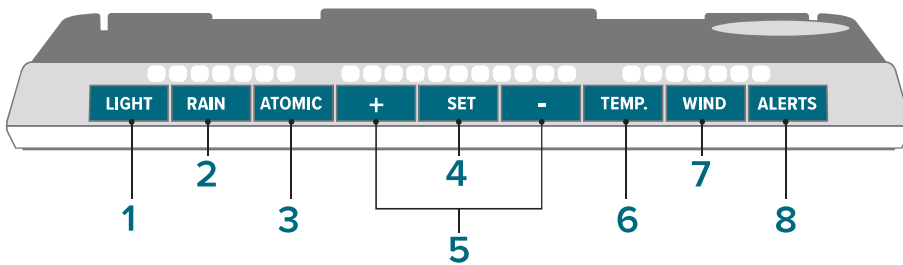

1. LIGHT

Press to adjust backlight. Hold to enter Auto-Dim settings.

2. RAIN

Press and release to toggle through Rain History. Hold to search for Cyclone Sensor.

3. ATOMIC

Hold to search for Atomic Time Signal.

4. PLUS/MINUS +/-

Press to adjust values. Hold to adjust quickly. In alerts settings, press to turn alerts on or off.

5. SET

Hold to enter Settings Menu. Press to confirm settings in menu.

6. TEMP.

Press and release to toggle through Temp. and Humidity History. Hold to search for TH Sensor.

7. WIND

Press and release to toggle through Wind History. Hold to search for Cyclone Sensor.

8. ALERTS

Hold to enter Alerts Settings Menu. Press to confirm options in menu.

9. DECIMAL ON/OFF

Press to turn Temperature Decimal Values ON or OFF.

10. "FEELS LIKE" TEMPERATURE

Press and release to toggle through Feels Like HI/LO Records and current Dew Point.

11. RESET

Hold to reset station to factory defaults. All history will be lost.

BASICS

Atomic Time

- Your station will automatically search for the Atomic Time Signal at UTC 7:00, 8:00, 9:00, 10:00, and 11:00.
- Hold the **ATOMIC** button to manually start or stop a search for the WWVB Atomic Time Signal.
- The Tower Icon (📶) will flash while searching, and remain solid on screen when the WWVB Signal is received.
- For information about WWVB Atomic Time visit: bit.ly/atomic_time

LCD Display Brightness

Adjusting the LCD Display Brightness (Backlight)

Press the **LIGHT** button to adjust the backlight intensity. There are 4 brightness levels, plus an off option.



Auto-Dim Backlight Settings

Program your display to automatically dim during preselected times.

1. Hold the **LIGHT** button until the display changes, to enter the Auto-Dim Settings.
2. Press the **+/-** buttons to turn the Auto-Dim feature on or off. Press **LIGHT** to confirm.
3. Press the **+/-** buttons to adjust the starting hour. Press **LIGHT** to confirm.
4. Press the **+/-** buttons to adjust the stopping hour. Press **LIGHT** to confirm and exit.

Note: Only the starting and stopping hour can be set.



FORECAST

Viewing Forecast Data

Forecast Icons

- The forecast icons use the station's internal barometer to predict conditions to come within the next 12 hours.
- For the most accurate forecasts, allow 7-10 days for station calibration.
- The Snow Icon will show when outdoor temperatures are below 32°F (0°C) and precipitation is predicted.

Note:

- For more info on how these icons work, visit: bit.ly/forecast_vid
- At elevations above 6,200 feet forecast icons may not change.

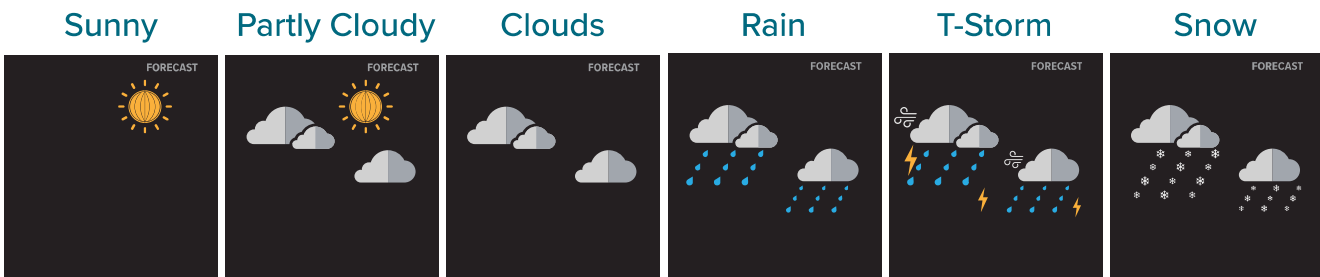

Seasonal Foliage

- The foliage scene in the forecast section changes seasonally.
- The dates are pre-programmed.

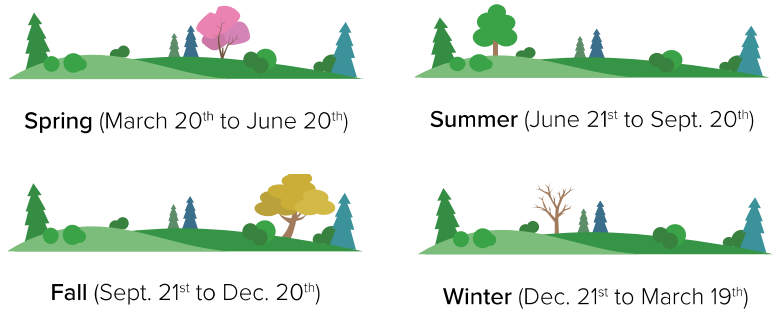

Moon Phase

- The moon phase is based on the Lunar Calendar and the year, month, and date settings.
- Moon Phase will show from 7:00pm to 6:59am regardless of forecast.

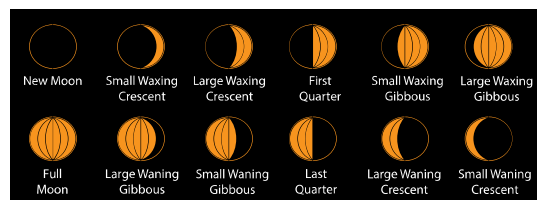

FORECAST

Pressure Number

Your Relative Pressure reading will come from your station's internal barometer. Allow up to 10 days for automatic calibration or set the pressure number manually within the station's Settings Menu (see page 04).

30.03 INHG

FORECAST

WIND

Viewing Wind Data

- 1. COMPASS ROSE**
Displays cardinal direction with animated arrows (16 directions total).
- 2. CURRENT WIND DIRECTION**
Large Arrow indicates current wind direction.
- 3. CURRENT WIND SPEED**
The top wind speed recorded in the past 31 seconds.
- 4. WIND SPEED ALERT**
Appears if a wind speed alert is set and active.
- 5. TOP WIND SPEED 1 HR**
The top wind speed recorded in the past 60 minutes.
- 6. PREVAILING DIRECTION ARROW**
Prevailing Wind Direction over the past hour.
- 7. ANIMATED WIND CUPS**
Cups will spin faster as current wind speed increases.
- 8. RECEPTION ICON**
Indicates the station is receiving data from the Cyclone sensor.
- 9. CURRENT WIND DIRECTION**
Choose between cardinal points (letters) or degrees in the Settings Menu.
- 10. PREVAILING WIND DIRECTION**
Prevailing direction over the past hour. Choose between cardinal points (letters) or degrees in the Settings Menu.



WIND

Wind Speed History

Viewing Wind Speed History Records

Press and release the **WIND** button to toggle through your top wind speed records with time and date stamps. While viewing your MONTH record, use the **+ (PLUS)** button to further toggle through your current and past 11 monthly top wind speed records.



Reset Wind Speed History Records

While viewing a wind speed record, press and hold the **- (MINUS)** button until the individual value resets to the current wind speed, time, and date.

RAIN

Viewing Rain Data



1. RECEPTION ICON

Indicates the station is receiving data from the sensor.

2. RAIN ALERT

Appears if a 24-Hr Rainfall alert is set and active.

3. AUTO-SCROLL ICON

When active, station will automatically scroll through all Rain History.

4. RAIN HISTORY

Shows Rain time frame: 1 Hour, 24 Hours, 7 Days, Month, Year, Total.

5. CURRENT RAINFALL

Current Rainfall for time frame selected.

6. RAIN CYLINDER GRAPH

Segments will adjust with Rain Reading shown.

Viewing Rainfall Records

Press and release the **RAIN** button to toggle through rainfall records with time and date stamps.

Example of Rainfall Records

See rainfall records for the past 1 hour, 24 hours, 7 days, month, year, and total since start up.



Month

Resets at the Start of Every Month

When viewing the monthly record, press and release the **PLUS (+)** button to toggle through the current month and past 11 months of rainfall records.

Reset Rainfall Records

While viewing a rainfall record, press and hold the **- (MINUS)** button until 0.00 appears on the LCD. That reading will be reset to the current value.

RAIN

Rain Graph

- The Rain Graph has 10 segments which change based on rainfall totals.
- The scale values automatically adjust when over 1-inch (25.4 mm) of rain is measured.

Note: If over 70 Inches (999 mm) is measured, the graph will appear full.

Days Since Last Rain

- After 24 hours of no rainfall, the station will start counting days without rain.
- Rainfall readings can be viewed by pressing the rain button.
- When new rainfall occurs, your station will automatically switch back to the last rainfall reading viewed.

Rainfall Auto-Scroll Option

- Program your station to toggle through all available rainfall data.
- When auto-scroll is active, each rain record will show for five seconds, then move to the next record.
- When auto-scroll is off, the station will stay on the last rain record displayed. You can press and release the **RAIN** button to view the other records individually.
- To activate press and release the **RAIN** button until the word AUTOSCROLL appears on the display.
- The Auto-Scroll Icon (🔄) located in the rain section will appear to show it is active.
- To deactivate the Auto-Scroll option, press and release the **RAIN** button until the Auto-Scroll Icon (🔄) disappears.
- The station will stay on your current selection.

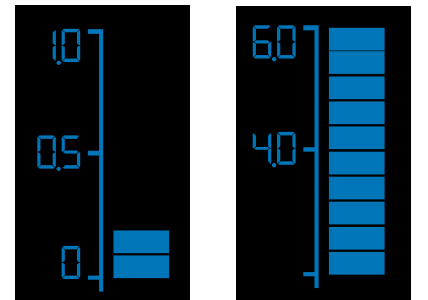

Up to 1" Example
Each Segment Equals 0.1"

Over 1" Example
Each Segment Equals 0.4"



TEMPERATURE & HUMIDITY

Viewing Temperature & Humidity Data



- 1. INDOOR ICON** Indicates indoor readings.
- 2. INDOOR TEMPERATURE**
Current indoor temperature
- 3. INDOOR HUMIDITY**
Current indoor humidity
- 4. INDOOR TEMPERATURE ALERTS** Appear if a high (↑) or low (↓) alert is set & active.
- 5. INDOOR HUMIDITY ALERTS** Appear if a high (↑) or low (↓) alert is set & active.
- 6. OUTDOOR TEMPERATURE**
Current outdoor temperature
- 7. RECEPTION ICON** Indicates the station is receiving data from the sensor
- 8. LOW BATTERY ICON** Indicates low battery in the outdoor sensor
- 9. OUTDOOR TEMPERATURE ALERTS** Appear if a high (↑) or low (↓) alert is set & active.
- 10. OUTDOOR SENSOR INDICATOR** Indicates outdoor temperature is coming from the TH sensor.
- 11. FEELS LIKE TEMPERATURE**
Shows both wind chill and heat index.
- 12. OUTDOOR HUMIDITY**
Current outdoor humidity
- 13. OUTDOOR HUMIDITY ALERTS** Appear if a high (↑) or low (↓) alert is set & active.

TEMPERATURE & HUMIDITY

Temperature & Humidity Records

Viewing Temperature & Humidity Records

Press and release the **TEMP.** button to toggle through indoor/outdoor records with time and date stamps.

Records Viewing Order

1. Outdoor High Temperature
2. Outdoor Low Temperature
3. Outdoor High Humidity
4. Outdoor Low Humidity
5. Indoor High Temperature
6. Indoor Low Temperature
7. Indoor High Humidity
8. Indoor Low Humidity

Reset Temperature & Humidity Records

While viewing a temperature or humidity record, press and hold the **- (MINUS)** button until dashes appear on the LCD. That reading will be reset to the current value.

Viewing “Feels Like” and Dew Point

Press and release the **FEELS LIKE** button on the side of the station to toggle through your “Feels Like” High and Low Records as well as current Dew Point reading.

“Feels Like” reading indicates both Wind Chill and Heat Index values when conditions are met.

- **Wind Chill:** When temperature is below 50°F (10°C) and there is 5 MPH (8 KPH) of sustained wind speed.
- **Heat Index:** When temperature is above 80°F (27°C).
- **Current Temperature:** When the temperature is between 51°F and 79°F (10.5°C and 26.1°C), the readings will remain the same as the outdoor value regardless of wind speed.



Outdoor High Temperature Record Example

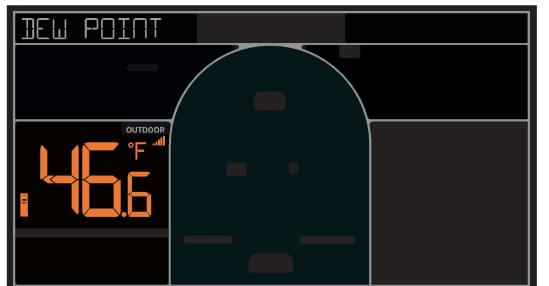

TEMPERATURE & HUMIDITY

Temperature Decimals

Press and release the **DECIMAL ON/OFF** button on the side of the station to turn the temperature decimals ON or OFF. This can also be set within the station's Settings Menu covered on page **04**.

ALERTS

Customizable Alerts

Setting Custom Alerts

1. Hold the **ALERTS** button to enter the Alert Settings Menu.
2. Use the **+/-** buttons to activate/deactivate individual alerts, or press the **ALERTS** button to skip to the next option.
3. Once activated, use the **+/-** buttons to adjust the values. Press the **ALERTS** button to confirm and move forward.

Alert Setting Order

- | | |
|-----------------------------|----------------------------|
| 1. High Wind Speed | 6. Outdoor Low Humidity |
| 2. 24-Hour Rainfall | 7. Indoor High Temperature |
| 3. Outdoor High Temperature | 8. Indoor Low Temperature |
| 4. Outdoor Low Temperature | 9. Indoor High Humidity |
| 5. Outdoor High Humidity | 10. Indoor Low Humidity |

Activating/Deactivating Alerts

Hold the **ALERTS** button to enter alert settings.
Press and release the **+/-** buttons to activate or deactivate alerts.

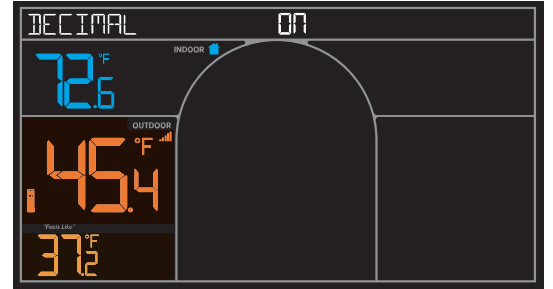

High Wind Speed Alert Example





Outdoor Low Temperature Alert Example

ALERTS

Triggered Alerts

- When an alert value is reached, the station will beep 5 times each minute until out of the alert range. Press any button to stop the alert sound.
- The Alert Icon will remain flashing until out of the alert range.



Active alerts are indicated by the  and high  or low  icons located in their respective sections on the LCD.

Note: The default setting for alerts is OFF.

SENSORS

Search for Sensors

If you are seeing “NO” or dashes for your outdoor readings, please try the following steps:

1. Hold the **TEMP** button to search for your Thermo-hygro Sensor. Hold the **WIND** or **RAIN** button to search for your Cyclone Sensor. The Reception Indicator  will begin to animate for either sensor.
2. If after 3 minutes the sensor still isn't connected, bring the sensor inside, install fresh batteries, then hold the **ALERTS** and **LIGHT** button together to restart the station.
3. If your outdoor data is still not appearing after these steps, please contact our support staff.

Lost Connection to Thermo-hygro Sensor



Lost Connection to Cyclone Sensor



SENSORS

Sensor Placement & Mounting



For Accurate Outdoor Temperature/Humidity Measurements

- Insert a mounting screw through the hole at the top to securely mount the sensor. It can also hang from the back using a nail.
- Mount the sensor vertically in a protected well-shaded area. Keeping it out of direct weather elements such as sunlight, rain, snow, etc. will help avoid inaccurate readings.
- For additional protection against weather elements, a Sensor Weather Shield: <https://bit.ly/weather-shield> can be purchased separately.
- The maximum wireless transmission range to the station is up to 330ft (100m) in open air. This does not include walls, floors, or other large obstructions.
- For online video instructions visit: bit.ly/th_sensor_mounting



For Accurate Cyclone Sensor Measurements

- Use the built-in Bubble Level to ensure the Cyclone Sensor (especially the rain gauge) is mounted level.
- Ensure the Solar Panel is facing to the South. This helps optimize battery life and transmit correct wind direction data.
- Ideally, the Cyclone Sensor should be mounted on the tallest object in your area. Avoid positioning the sensor parallel or below eaves, roof lines, trees, or other objects that may obstruct wind and rain readings.
- Make sure all the screws on the Mounting Bracket, Wind Cups, Wind Vane, and Battery Compartment are securely fastened.
- The Cyclone Sensor should be mounted with the Wind Cups on the top.

SENSORS

Cyclone Sensor Mounting

Basic Installation

Fence posts, poles, decks, and mailboxes are common mounting options due to their convenience. Many users prefer these types of locations as the data they provide is accurate from their ground level. However, because the wind in these spots is often affected by obstructions, the readings may differ when compared to local reporting stations.

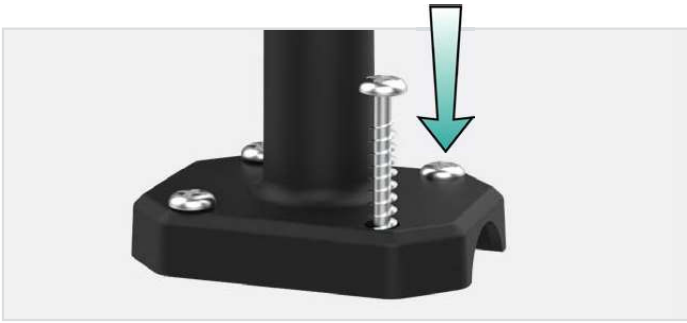

1. Mount the Mast to a flat surface with the four provided screws.

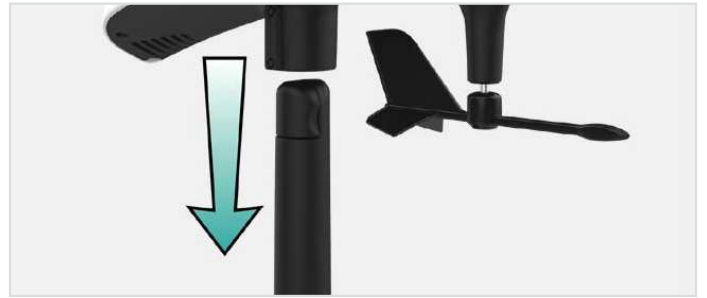

2. Place the Cyclone Sensor on top of the Mast. Ensure the Solar Panel is facing south.



3. Check the integrated Bubble Level or use your own across the Rain Funnel to ensure the sensor is level.



4. Secure the Cyclone Sensor to the Mast by tightening the screws on the side. After screws are tightened, double check the sensor has remained level through the installation process.

SENSORS

Cyclone Sensor Mounting

Flexible Installation



Install the Hand Screw to the bracket, then Secure the Cyclone Sensor to the Mast by tightening the screws on the side.

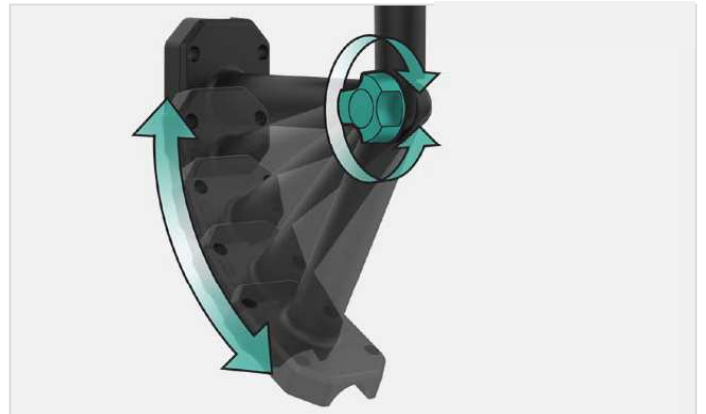

This configuration allows you to attach the sensor to angled locations and easily make adjustments to ensure the Mast and Sensor are level.

Advanced Installation

Some advanced installation options include tripods, wall mounts, chimney mounts, and many others. Any of these can be combined with U-bolts for attachment onto a tall cylindrical conduit using our Adjustable Base. These options will require additional equipment and possibly professional help for best results.



Freestanding Pole Setup

1" Maximum Outside Pole Diameter



Tripod Setup Example

1" Maximum Outside Pole Diameter

SENSORS

Cleaning the Cyclone Sensor

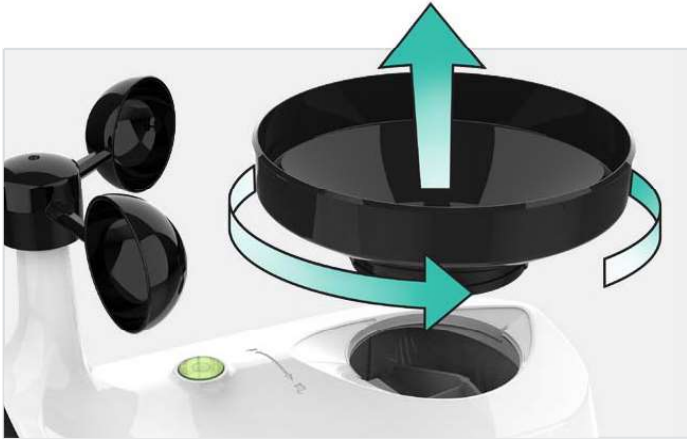

1. Remove the Rain Funnel by firmly twisting the funnel counter-clockwise and lifting up.

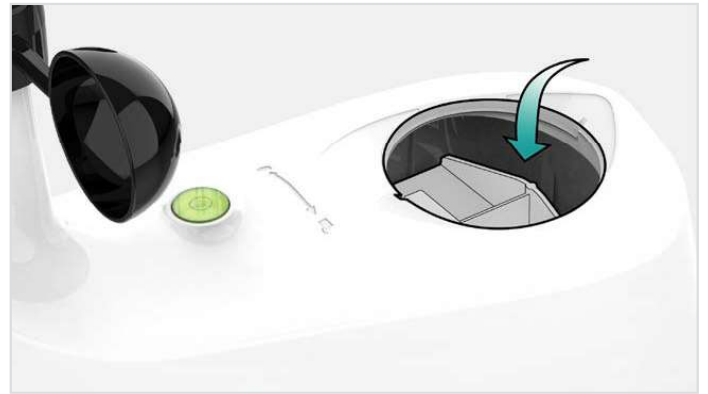

2. Clear any leaves, insects, or other debris to allow the Rain Tipper to rock freely. Check and clear the Drainage Holes located on the underside of the sensor.



3. After cleaning, re-install the Rain Funnel by placing it back into the sensor and twisting clockwise until secure.

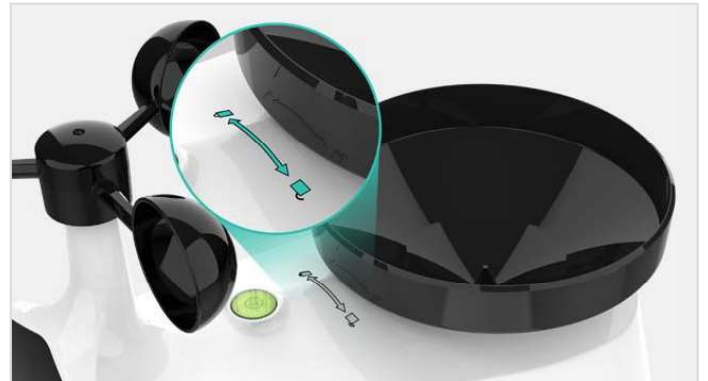

4. You should feel the funnel lock into place when one of the arrows lines up with the center of the Lock/Unlock Line.

Tip: Remove the Cyclone Sensor's batteries before cleaning to avoid accidental rain readings.

SUPPORT

Stay in Touch!

Ask questions, watch setup videos, and provide feedback on our social media outlets. Follow La Crosse Technology on YouTube, Twitter, Facebook and Instagram.



We're Here to Help

If you require additional assistance, get in touch with our friendly customer support team based in La Crosse, WI.

Phone: 1.608.782.1610

Online: bit.ly/contact_techsupport

Self Help: bit.ly/328-1415_support

Our knowledgeable customer support team is available:
Mon-Fri 8am-6pm CST

SCAN HERE
*Additional Info.
and Support ▼*



Warranty and Patents

La Crosse Technology, Ltd. provides a **1-year limited time warranty** (from date of purchase) on this product relating to manufacturing defects in materials & workmanship. La Crosse Technology, Ltd, 2830 S. 26th St., La Crosse, WI 54601

For Full Warranty Details, Visit: www.lacrossetechnology.com/pages/warranty

Patents: www.lacrossetechnology.com/pages/patents

APPENDIX

Specifications

Weather Station (328-1415)

Temperature Range: 32°F to 122°F (0°C to 50°C)

Humidity Range: 10% - 99% RH

Relative Pressure Range: 23.62 to 32.48 inHg (800 to 1100 hPa)

Power Requirements: 5-volt power adapter (included) GPU280500150WAOO

The plug on the power adapter is intended to serve as the disconnect device, the socket-outlet shall be installed near the equipment and shall be easily accessible.

Battery Backup: CR2032 coin cell battery (included)

Dimensions: 8.23" L x 3.27" W x 5.83" H (20.9cm L x 8.32cm W x 14.8cm H)

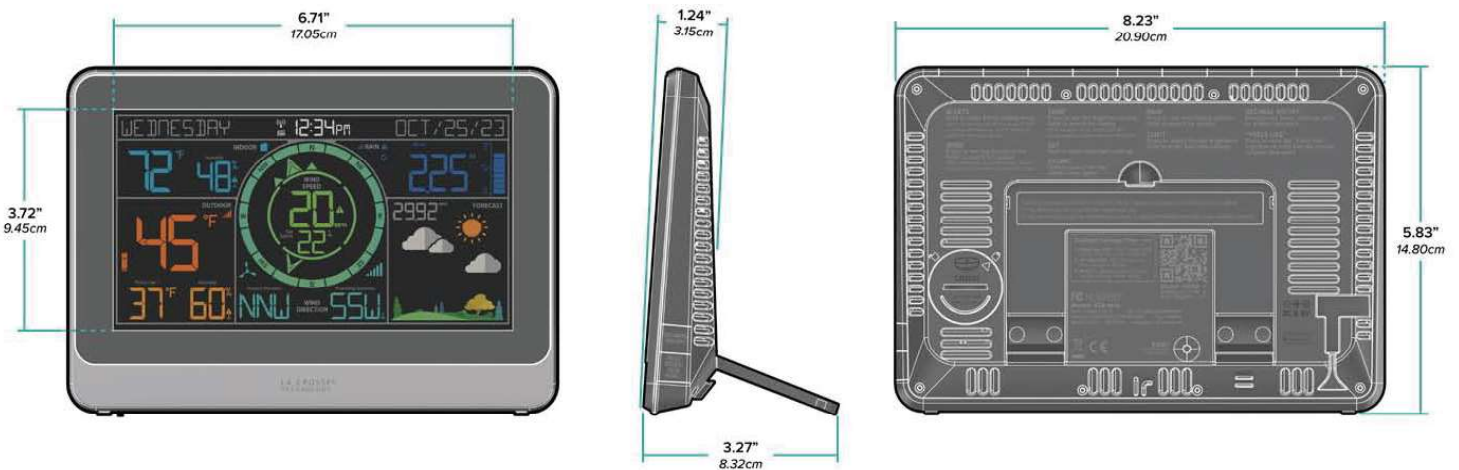

Thermo-hygro Sensor (TX141TH-Bv4)

Temperature Range: -40°F to 140°F (-40°C to 60°C)

Humidity Range: 10% - 99% RH

Transmission Range: Over 330 feet

(100 meters) in open air RF 433MHz

Update Interval: About every 51 seconds

Power: 2-AA, LR6 batteries (not included)

Battery Life: Over 24 months

Dimensions: 1.58" L x 0.83" W x 5.08" H (3.99cm L x 2.1cm W x 12.99cm H)

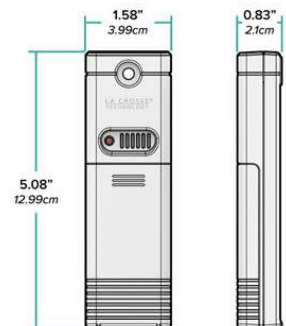

CYCLONE PRO WIND SENSOR (TX145WSDR)

Wind Speed Range: 0 to 111 mph (0 to 178 kph)

Rainfall Range: 0 to 393.6 Inches (0 to 9999 mm)

Transmission Range: 400 feet (121 meters) open air

Power Requirements: 3 "AA" Batteries (not included)

Update Interval: Every 31 Seconds

Dimensions: 13.80" L x 5.18" W x 17.44" H (34.04cm L x 13.15cm W x 44.3cm H) with full Bracket

13.80" L x 5.18" W x 12.47" H (34.04cm L x 13.15cm W x 31.69cm H) with short Bracket

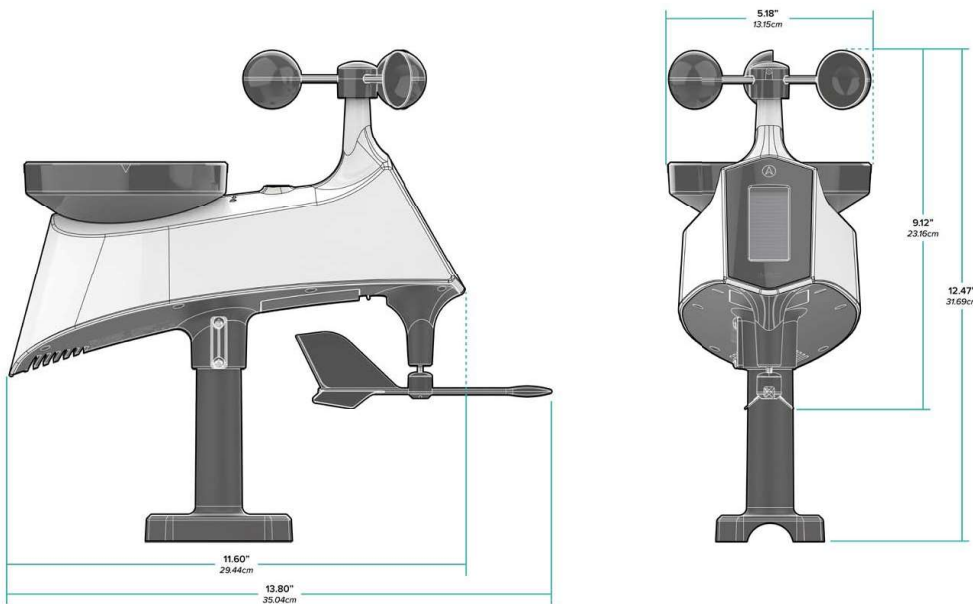

Canada Statement

This device contains licence-exempt transmitter(s)/receiver(s) that comply with Innovation, Science and Economic Development Canada's licence-exempt RSS(s). Operation is subject to the following two conditions: (1) This device may not cause interference; and (2) This device must accept any interference, including interference that may cause undesired operation of the device. The device meets the exemption from the routine evaluation limits in section 2.5 of RSS 102 and compliance with RSS-102 RF exposure, users can obtain Canadian information on RF exposure and compliance. This transmitter must not be co-located or operating in conjunction with any other antenna or transmitter. **This product complies with the IC RF exposure limit set forth for an uncontrolled environment and is safe for intended operation as described in this manual.**

Avis d'Industrie Canada

Le présent appareil est conforme aux CNR d'industrie Canada applicables aux appareils radio exempts de licence. L'exploitation est autorisée aux deux conditions suivantes: 1) l'appareil ne doit pas produire de brouillage; et 2) l'utilisateur de l'appareil doit accepter le brouillage radioélectrique subi même si le brouillage est susceptible d'en compromettre le fonctionnement. mauvais fonctionnement de l'appareil.

Déclaration d'exposition aux radiations:

Ce produit est conforme à la limite d'exposition IC RF définie pour un environnement non contrôlé et est sûr pour le fonctionnement prévu comme décrit dans ce manuel.

APPENDIX

Coin Cell Battery

Replace the Coin Cell Battery

1. Use a screwdriver to turn the battery cover to the left to remove it.
2. Pull back the metal pin and gently remove the battery.
3. Insert a fresh CR2032 battery with the + side up and snap it into place.
4. Replace the battery cover and use the screwdriver to turn it to the right to lock.

Battery Replacement Instructions

When batteries of different brand or type are used together, or new and old batteries are used together, some batteries may be over-discharged due to a difference of voltage or capacity. This can result in venting, leakage, and rupture and may cause personal injury.

- Do not mix Alkaline, Lithium, Standard, or Rechargeable batteries.
- Always purchase the correct size and grade of battery most suitable for the intended use.
- Always replace the whole set of batteries at one time, taking care not to mix old and new ones, or batteries of different types.
- Clean the battery contacts and also those of the device prior to battery installation.
- Ensure the batteries are installed correctly with regard to polarity (+ and -).
- Remove batteries from product during periods of non-use. Battery leakage can cause corrosion and damage to this product.
- Remove used batteries promptly.
- For recycling and disposal of batteries, and to protect the environment, please check the internet or your local phone directory for local recycling centers and/or follow local government regulations.

WARNING

1. This product contains a coin cell battery.
2. If swallowed, it could cause severe injury or death in just 2 hours.
3. Seek medical attention immediately.

WARNING: KEEP BATTERIES OUT OF REACH OF CHILDREN

1. Swallowing may lead to serious injury in as little as 2 hours or death, due to chemical burns and potential perforation of the esophagus.
2. If you suspect your child has swallowed or inserted a coin cell battery, immediately seek urgent medical assistance.
3. Examine devices and make sure the battery compartment is correctly secured, e.g. that the screw or other mechanical fastener is tightened.
4. Do not use if compartment is not secure.
5. Dispose of used coin cell batteries immediately and safely.
6. Flat batteries can still be dangerous.
7. Tell others about the risk associated with coin cell batteries and how to keep their children safe.

  **WARNING: CHOKING HAZARD—Small Parts**
Not for children under 3 yrs.

California Residents

CA WARNING:

This product can expose you to chemicals including acrylonitrile, butadiene, and styrene, which are known to the State of California to cause cancer and birth defects or other reproductive harm. For more information, go to: www.P65Warnings.ca.gov

FCC Statement

This equipment has been tested and found to comply with the limits for a Class B digital device, pursuant to part 15 of the FCC Rules. These limits are designed to provide reasonable protection against harmful interference in a residential installation. This equipment generates, uses and can radiate radio frequency energy and, if not installed and used in accordance with the instructions, may cause harmful interference to radio communications. However, there is no guarantee that interference will not occur in a particular installation. If this equipment does cause harmful interference to radio or television reception, which can be determined by turning the equipment off and on, the user is encouraged to try to correct the interference by one or more of the following measures:

- Reorient or relocate the receiving antenna.
- Increase the separation between the equipment and receiver.
- Connect the equipment into an outlet on a circuit different from that to which the receiver is connected.
- Consult the dealer or an experienced radio/TV technician for help.

This device complies with Part 15 of the FCC Rules. Operation is subject to the following two conditions:

- (1) This device may not cause harmful interference, and
- (2) This device must accept any interference received, including interference that may cause undesired operation.

Caution!

Any changes or modifications not expressly approved by the party responsible for compliance could void the user's authority to operate the equipment.

All rights reserved. This manual may not be reproduced in any form, even in part, or duplicated or processed using electronic, mechanical or chemical process without the written permission of the publisher. This booklet may contain errors or misprints. The information it contains is regularly checked and corrections are included in subsequent editions. We disclaim any responsibility for any technical error or printing error, or their consequences. All trademarks and patents are recognized.

LA CROSSE[®]
TECHNOLOGY

DOUBLE YOUR WARRANTY

Scan the QR Code or visit: bit.ly/328-1415_register to register your product and double the standard 1-year warranty for free by opting to receive occasional product emails.



Scan Here