

# LA CROSSE® TECHNOLOGY

PROFESSIONAL

## Remote Monitoring **Weather Station**



---

## Welcome!

-----

Congratulations on your new Professional Weather Station and welcome to the La Crosse Technology family! This product was designed with you in mind by our hometown team of weather enthusiasts based in La Crosse, Wisconsin.

Instructional Manual

Model: C84428

DC: 061317

[www.lacrossetechnology.com/C84428](http://www.lacrossetechnology.com/C84428)

# Table of Contents

3	<a href="#">Step 1: Power Up</a>	16	<a href="#">Feels Like Temperature</a>
3	<a href="#">Step 2: Station Options</a>	16	<a href="#">Temperature   Humidity Trend Arrows</a>
4	<a href="#">Step 3: Mounting Basics</a>	16	<a href="#">Season Changes in Foliage</a>
5	<a href="#">Introducing La Crosse <b>View</b><sup>™</sup></a>	17	<a href="#">Backlight Brightness</a>
5	<a href="#">Wi-Fi Network Requirements</a>	17	<a href="#">Low Battery Icons</a>
6	<a href="#">La Crosse View<sup>™</sup> Offers Expanded Forecasts from National Weather Service (NWS)</a>	18	<a href="#">Sensor Search   Sensor ID</a>
7	<a href="#">New Data Stream Technology</a>	18	<a href="#">Delete Your Sensor ID</a>
8	<a href="#">Simple Status Messages</a>	19	<a href="#">Settings Menu C84428</a>
9	<a href="#">Your Station's Features - Standalone or Connected</a>	20	<a href="#">Factory Reset C84428</a>
10	<a href="#">Detailed Sensor Set Up and Mounting</a>	20	<a href="#">Your LTV-D1 Bonus Station</a>
13	<a href="#">Wind Speed Readings</a>	22	<a href="#">Help Us, Help You</a>
13	<a href="#">Wind Speed History</a>	22	<a href="#">Let's Be Social</a>
13	<a href="#">Reset Wind Speed History</a>	22	<a href="#">Specifications</a>
14	<a href="#">Rainfall Readings</a>	22	<a href="#">Care and Maintenance</a>
14	<a href="#">Reset Rainfall Readings</a>	23	<a href="#">Warranty and Support</a>
15	<a href="#">HI   LO Temperature/Humidity Records</a>	23	<a href="#">FCC Statement</a>
15	<a href="#">Reset HI   LO Temperature/Humidity Records</a>		
15	<a href="#">Daily HI   LO Temperatures</a>		

## **Step 1. Power UP**

### **Insert the included batteries (in any order):**

- 2-C batteries into Wind speed sensor
- 2-AA batteries into Thermo-hygro sensor
  - 2-AA batteries into Rain sensor
- 5 volt power cord (required) into C84428 station  
3-AA batteries optional backup for time and date\*
- 2-AAA batteries into LTV-D1 bonus station

**Note:** Press and release the SENSOR button on the station to confirm sensor ID's on station match the bar codes on your Thermo-Hygro, Wind Speed and Rain sensors.



123456-ABC

If they do not match, you may have picked up a neighbors sensor.  
See Delete Sensor on [page 18](#).

\*Batteries operation only will not update sensor or Wi-Fi data. Power cord is required.

## **STEP 2: STATION OPTIONS**

### **OPTION 1**

CONNECT WITH LA CROSSE VIEW™ APP

**The easiest and fastest way to setup your station!**

Enjoy all of the standalone station features along with the enhanced feature set from your La Crosse View™ app!

**Not Interested in Connecting to La Crosse View™? No Problem!**

These enhanced features are optional & your weather station will function as a standalone unit without connecting to the app.

### **OPTION 2**

STANDALONE STATION (NOT CONNECTED)

**Full Weather Station Features**

Monitor your backyard temperature, humidity, wind speed, and rainfall information on the easy-to-read LCD display.

Click [here](#) to go to your standalone station's features!

## WHAT'S NEXT? STEP 2 CONTINUED...

### OPTION 1

CONNECT TO LA CROSSE VIEW™

#### DOWNLOAD

Visit the App Store or Google Play Store to download the free La Crosse View™ app on your mobile device.



#### CHECK YOUR NETWORK

Confirm that your mobile device is connected to a 2.4GHz Wi-Fi Network before you connect your station

#### LAUNCH

Open the app on your iOS or Android device.

#### FOLLOW INSTRUCTIONS

The La Crosse View™ app will walk you through creating an account and automatically sets your time & local forecast.

#### Make Sure Your Station is Ready to Connect

When connecting to the app, ensure the Wi-Fi Indicator icon is blinking. If it is not, perform a Wi-Fi search by pressing & holding the + & - buttons together.

### OPTION 2

STANDALONE STATION

#### STATION SETUP

To enter the setup menu, hold the **SET** button.

Press and release the - or + buttons to make adjustments.

Push the **SET** button to confirm.

#### SETUP ORDER

<u>1</u>	<u>2</u>	<u>3</u>
Beep (ON/OFF)	12/24 Hour Time Format	Hour
<u>4</u>	<u>5</u>	<u>6</u>
Minutes	Year	Month
<u>7</u>	<u>8</u>	<u>9</u>
Date	Temperature (°F/°C)	Connection Prompt*

\*Note: This prompt is a reminder that the app is necessary to connect (optional).

#### CAN I CONNECT LATER?

Of course! You can always connect your station to the app. See the full manual for more details.

## STEP 3: MOUNTING BASICS

At this time, all of your sensor information should be displayed on your station. Here are a few quick tips for mounting your sensors:

#### THERMO-HYGRO

Keep out of direct sunlight & ensure the sensor is well-ventilated.

We recommend mounting under a deck or eave facing north.

#### RAIN

Mount in an open area, preferably off the ground on a level platform.

Clean out the bucket regularly to avoid debris; this can affect readings.

#### WIND

Ensure the sensor is mounted vertically – an unobstructed rooftop is ideal.

Your wind sensor should be the tallest object in the area to avoid any obstructions.

For detailed sensor setup and mounting instructions, see [page 10](#).

# INTRODUCING



Connecting You to Your Home **Anytime, Anywhere.**

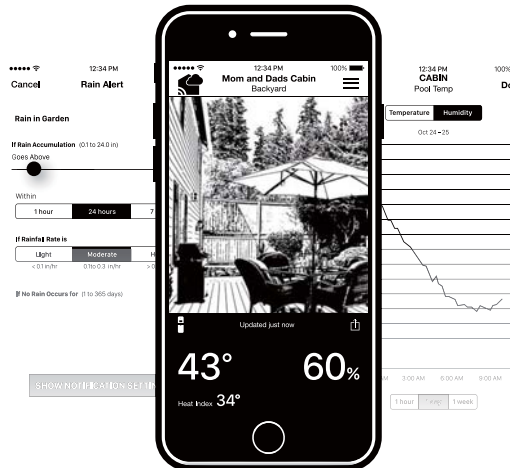

## TAKE YOUR STATION TO THE NEXT LEVEL!

### ON-THE-GO HOME MONITORING

Check Current Indoor/Outdoor Readings, View History Charts, and More

### SUPERIOR APP EXPERIENCE

Use Your Own Photos and Receive Free Push Notifications on the New, Easy-to-Navigate App

### ENHANCED DISPLAY FEATURES

Receive Local National Weather Service (NWS) such as Forecast & Precipitation on Your Color Display

### FRIENDS & FAMILY SHARED ACCOUNTS

No Need to Share Logins or Passwords!

Invite Friends & Family to Download the App & Monitor Your Home's Data

## Wi-Fi Network Requirements

In order for your station to connect to your Wi-Fi, it will need to meet the following requirements:

- Confirm that your mobile device is connected to a 2.4GHz (802.11 b/g/n) Wi-Fi Network before you connect your station
- Weather station power cord use is required for Wi-Fi connection.

### IOS Requirements:

Mobile device with iOS 8.0 (or higher) with cellular or Wi-Fi service

### Android Requirements:

Mobile device with Android OS 4.1 (or higher) with cellular or Wi-Fi service

### Tips:

- Do not use public Wi-Fi networks.
- Your weather station and mobile device must be within 10 feet of each other during setup.
- Hold the PLUS and MINUS buttons together for 3 seconds to have your station search for your Wi-Fi.
- If you change your Wi-Fi network, hold the RAIN and LIGHT buttons together for 5 seconds to complete a factory restart. This will reset the Wi-Fi settings so you can connect to your new network.

**Note:** Your station may take up to 3 minutes to reacquire all sensors.

**Note:** in the event of a power outage, or your station being unplugged temporarily, your station should automatically reconnect to your existing Wi-Fi network.

**Note:** Weather station power cord use is required.  
Batteries operation only, will not update sensor or Wi-Fi data.

### Wi-Fi Indicator:



**Solid:** indicates that your Wi-Fi connection is good.

**Flashing:** Searching for connection

**Not displayed:** Not Connected

**One, two or three bars:** Wi-Fi signal strength.

## **La Crosse View™ Offers: Expanded Forecasts from National Weather Service (NWS)**

### NWS (National Weather Service) Daily HI | LO temperature

**Note:** When not using the App, the daily HI | LO will come from your outdoor sensor.

### NWS Chance of Precipitation

The letters NWS will show in the forecast area

### NWS Additional Forecast Icons

**Standard Icons:** • Sunny • Partly Sunny • Clouds • Rain • T-Storm • Snow

**Additional Icons:** • Windy • Light Rain • Severe T-Storm • Light Snow • Wintry Mix • Blizzard • Fog • Ice

### NWS Wind Direction

The words “NWS Wind Direction” will show, and the blue circle will change to indicate wind direction.

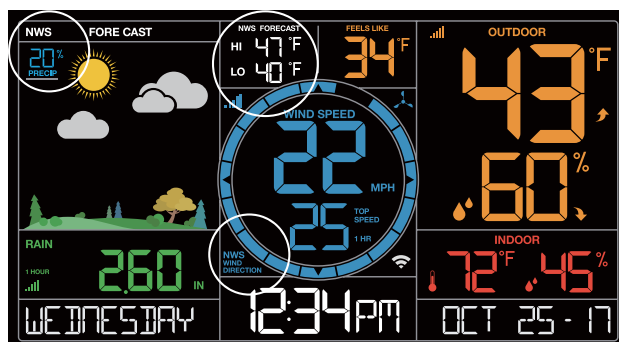

# New Data Stream Technology

Use the Data Stream Menu in the La Crosse View™ app to select up to 4 items to stream on your station.

1. Open the La Crosse View™ app and select your station.
  2. Scroll down to the Data Stream section and press the blue icon. 
  3. Follow the app's instructions to add the "Data Streams" you'd like displayed on your station
- Allow a few minutes for all the data to show on your station.

## Data Stream Items:

### National Weather Service (NWS)

Selectable Forecast on Your Display  
(Wind, Snow, & Sky Conditions, probability of Thunderstorms, Hail or Tornadoes)

### National Institutes of Standard and Technology (NIST)

Automatically sets Time and Date Based on Your Zip Code

### Personal Message

Enter Up to 20 Characters for Special Events or Reminders

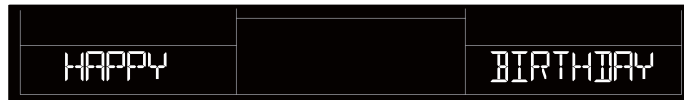
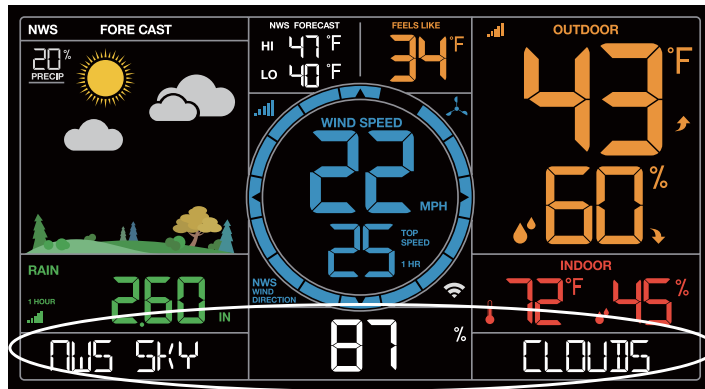

## Simple Status Messages

Your station has built in status messages for your convenience. Press and release the SET button to view.

**Note:** Only one relevant status message will display.

### “ALL OK CONNECTED”

- Your station is connected, there are no problems.

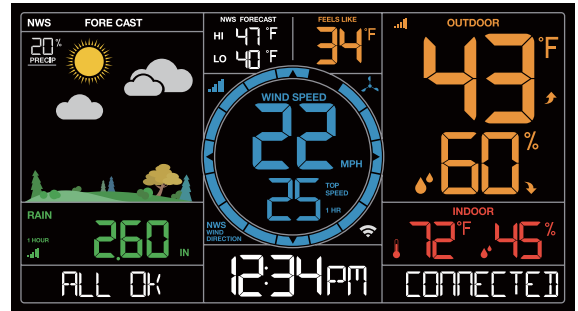

### “LOST WIFI”

- Check your power cord connection. (must use power cord to connect)
- Check your router connection (use 2.4GHz)
- Check your network connection.
- Hold the + and - buttons together for 3 seconds to search for Wi-Fi

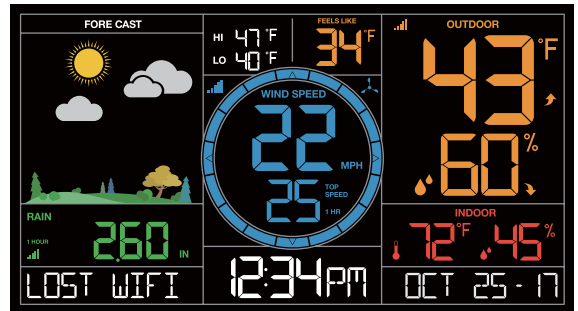

### “NO CONNECT APP SERVER”

- The Wi-Fi router connection is working.
- Check your connection to the La Crosse View app.
- Is there an update to install?

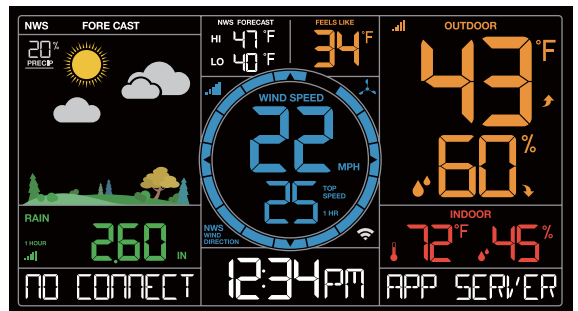

### “NO NIST SERVER”

- This indicates an error on the NIST server.
- Your time will be maintained by your weather station until the NIST updates resume.
- The NIST will resolve this.
- Very rare to have this error.

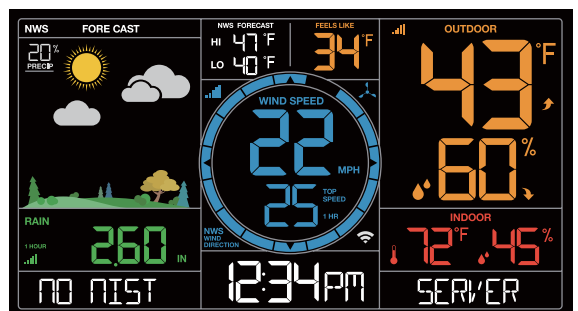

### “NO NWS SERVER”

- This indicates an error on the NWS server.
- NWS Expanded Forecast, Wind Direction, and selected data streams will not update or show.
- The NWS will resolve this.
- Very rare to have this error.

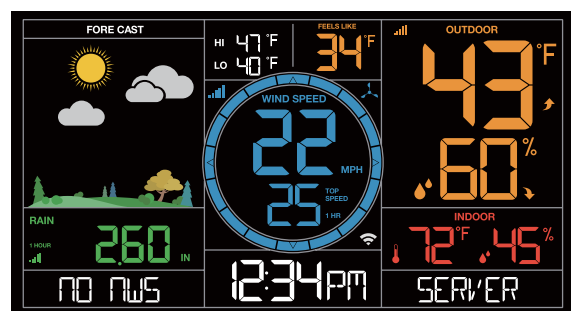



# Your Station's Features - Standalone or Connected

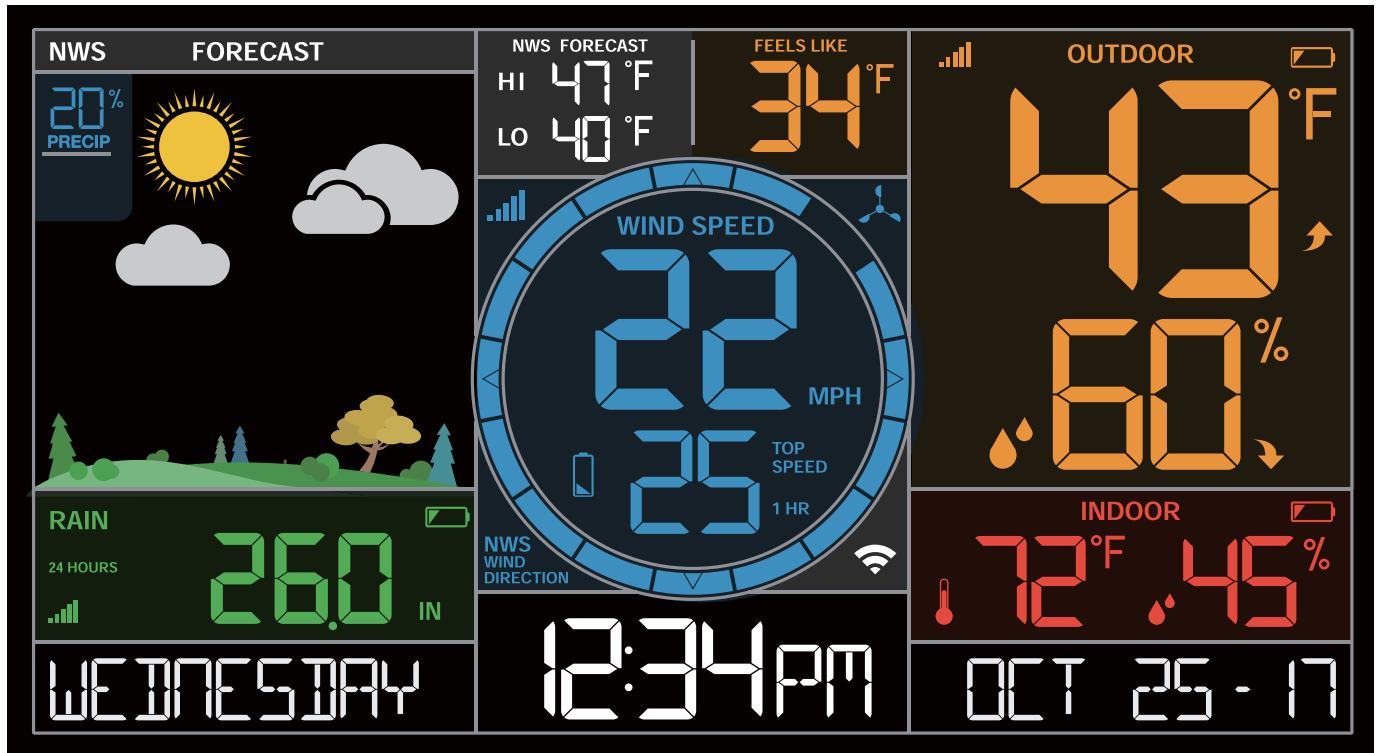

**NWS**

NWS Forecast Information:  
Precipitation, HI | LO, Wind Direction, etc.



Sensor Reception Icon



Weather Forecast Icons



Trend Arrows



Low Battery Icons



Fahrenheit or Celsius - Temperature

**IN**

Inches or Millimeters of Rain



Percentage - Relative Humidity



Wind Speed Icon



Relative Humidity Icon

**MPH**

Miles or Kilometers - Wind Speed



Temperature Icon



Wi-Fi Connection Icon



Standalone station's can only display time and date information as shown here



Connected station's offer the ability to display custom data, controlled with the La Crosse View™ app

# Detailed Sensor Set Up and Mounting

## LTV-W1 Wind Speed Sensor

1. Turn the battery cover of your wind sensor left.
2. Install fresh “C” batteries.
3. Carefully align and turn battery cover right to tighten.
4. There is a blue LED light on the sensor that will flash when transmitting.

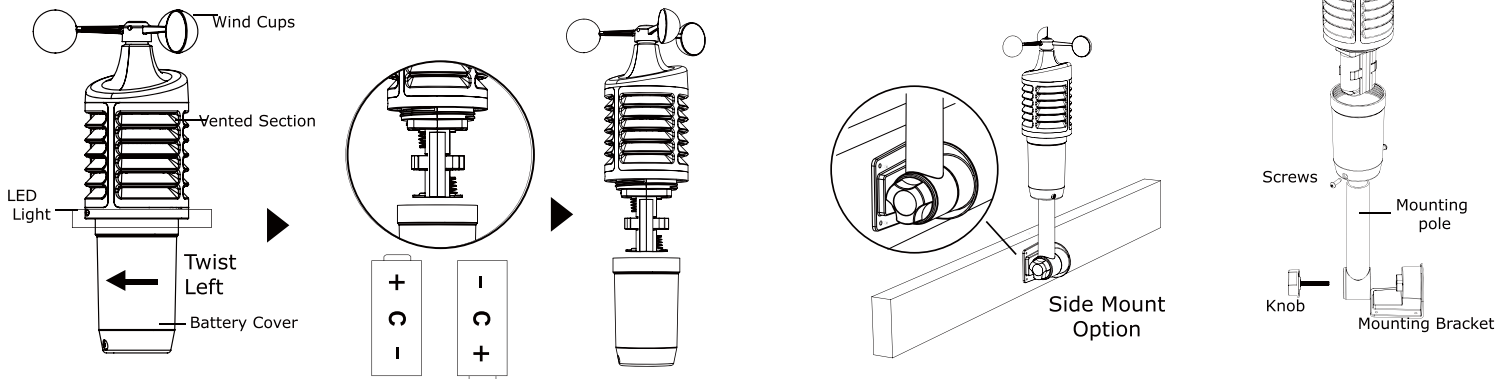

### Mounting:

- Position in an open area that will have the least amount of interference with wind speed.
  - Mount your sensor vertically with the wind cups on top.
- The maximum wireless transmission range to the wind station is up to 400 feet (121 meters) in open air, not including walls or trees.

1. Insert the included mounting pole into your sensor.
2. Tighten screws.
3. Insert bottom of pole into mounting bracket. Tighten knob to secure
4. Use screws through the bottom of the mounting bracket to attach.

### Alternatively:

1. Insert your own mounting pole ( up to 1.179” ) into the sensor.
2. Tighten screws

## LTV-TH2 Thermo-Hygro Sensor

1. Slide the battery cover off the front of your sensor.
2. Install 2-AA batteries according to polarity and replace battery cover.

### Mounting:

1. Use the hole at the top to hang your sensor from the back using a nail.  
Or, insert one mounting screw through the front of your sensor.
2. Mount your sensor on a north-facing wall or in any shaded area. Under an eave or deck rail is preferred.
3. The maximum wireless transmission range to the weather station is up to 400 feet (121 meters) in open air, not including walls or floors.
4. Be sure your sensor is mounted vertically, to allow moisture to drain out properly.

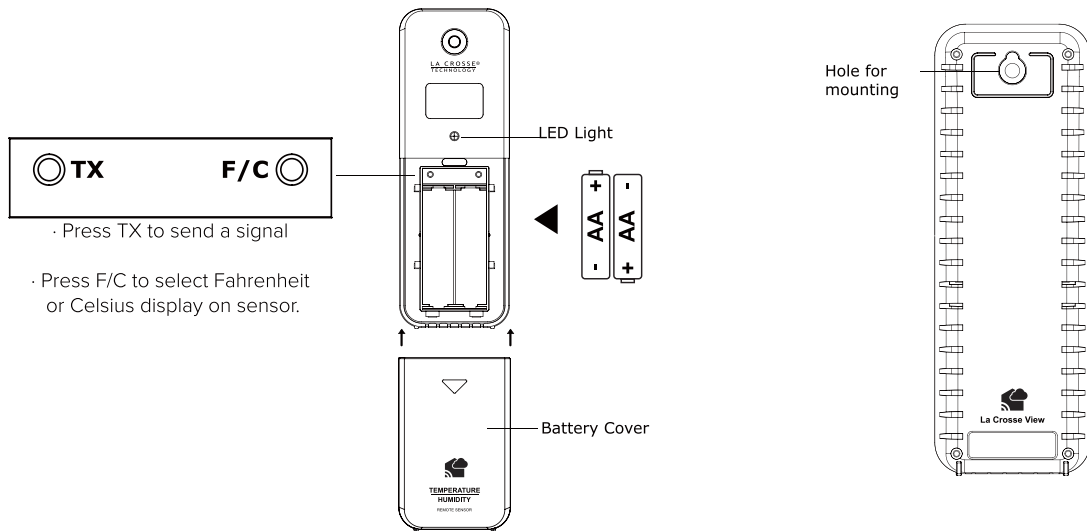

### LTV-R2 Rain Sensor:

1. Flip open both side tabs on your rain sensor and lift off the funnel portion.
2. Pull up on the battery cover and remove.
3. Install 2-AA batteries according to polarity.
4. Reposition the battery cover over the battery compartment, and firmly push down to lock it back into place
5. Remove cardboard piece placed under rocker for shipping.
6. Place the funnel portion back over the sensor and lock the side tabs.

### Mounting:

1. Mount in an open area, on a stationary, level platform for a more accurate rain count.

**Note:** Avoid placing the bottom of the rain sensor in a depression that would not allow proper water drainage.

2. Insert the mounting screws through the holes in the bottom of your rain sensor.
3. Mount your rain sensor at least 3 feet and optimally 6 feet in the air and in direct line of sight to your station.
4. Your rain sensor should be accessible to allow for periodic cleaning of debris or insects.
5. The maximum wireless transmission range to your station is up to 400 feet (121 meters) in open air, not including walls or floors.

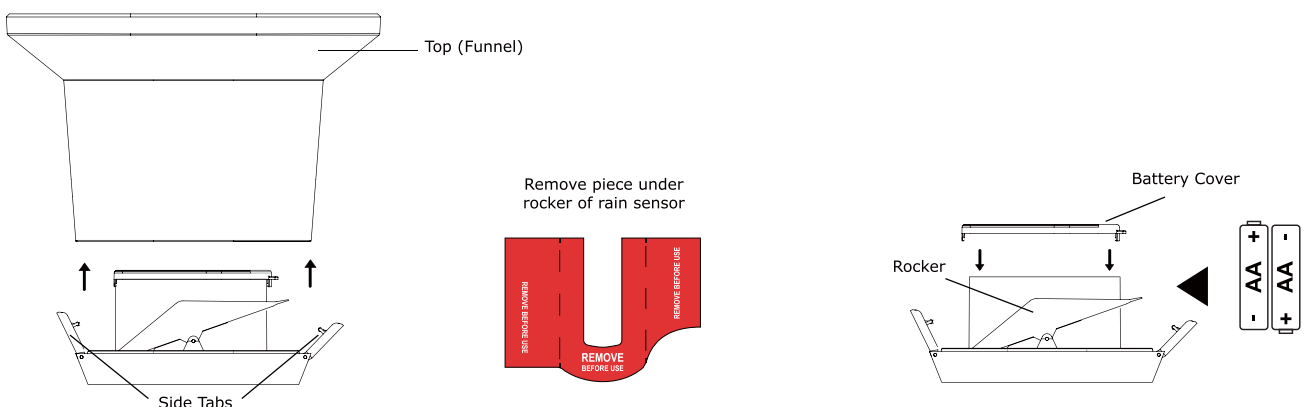

## C84428

1. Insert the power cord into a wall outlet then into your station.

Optional: insert 3 AA batteries into your station to maintain time/date in the event of a power outage.

### Mounting:

1. Place your station near an outlet. Power cord is required for operation.
2. Use the mounting holes on the back to place your station on a wall.
3. Use the pull down stand on the back of your station to place on a desk or counter.
4. Your station should remain in good Wi-Fi range of your wireless router to use all the remote monitoring options using the La Crosse View™ app.

For more information on manually setting you weather station see [page 20](#).

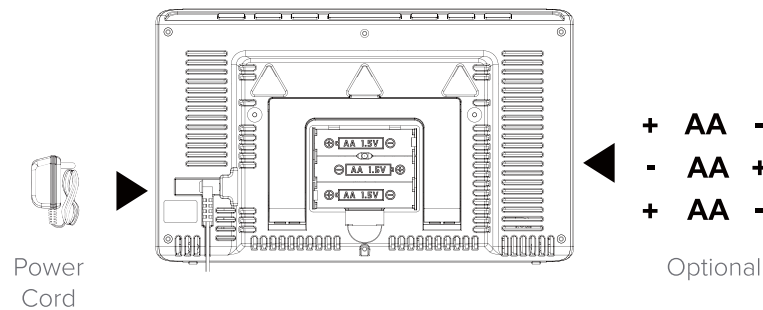

## LTV-D1

1. Insert 2 AAA batteries into your bonus station according to polarity.

### Mounting:

1. Place your bonus station on a desk or counter top.
  2. Use the mounting hole on the back to place your station on a wall.
- Note:** The bonus station does not connect to the La Crosse View app.

For more information on setting you bonus station see [page 21](#).

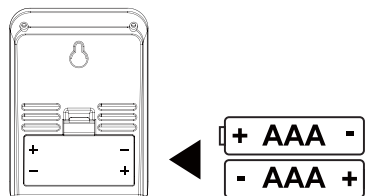

## Wind Speed Readings

### Wind Speed:

Reflects highest current wind speed

### Top Speed:

Reflects highest wind speed in the past 60 minutes.

### Wind Cup animation:

The wind cups spinning speed will vary with actual wind speed.  
When wind speed is higher, the cups spin faster.

### Blue Circle:

The blue circle will remain solid, when operating as a standalone station.

**Note:** When station is synced to the La Crosse View™ App, the circle will forecast NWS Wind Direction.

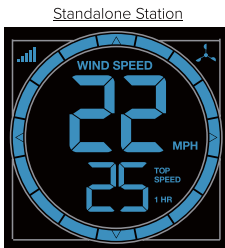

## Wind Speed History

Simply press and release the WIND button to cycle through the Wind History (other readings will disappear temporarily).

### One Hour:

Past 60 minute period (default Top Speed record, always shown)

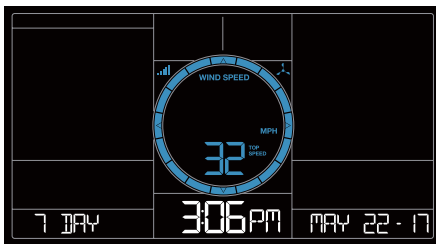

### 24 hour:

Past 24 hour period, from last record

### 7 Days:

Past 7-day period, from last record

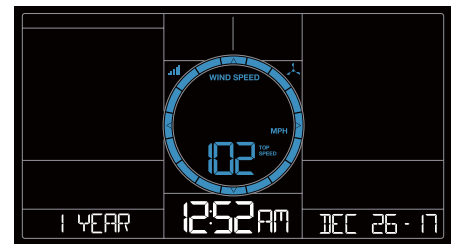

### Current Month:

Defined by Calendar Month i.e. January 1 - January 31

Press and release the PLUS button to view previous months.

### Year:

Defined by Calendar Year i.e. January 1 - December 31

## Reset Wind Speed History

1. Press and release the WIND button to view individual wind speed readings.
2. Hold the MINUS button for five seconds to reset the individual value.
3. Wind speed history reading will reset to current wind speed, time and date.
4. Press and release the LIGHT button, or wait 20 seconds to return to a full, normal display.

## Rainfall Readings

Simply press and release the RAIN button to cycle through the exact history you'd like displayed (other readings will disappear temporarily). Your station will stay on your selection. Press and release the LIGHT button, or wait 20 seconds to return to a full, normal display.

### **NOW:**

Rain readings from the start of a rain event until no rain has accumulated for 30 minutes. After a 30 minute period of no rainfall, this number will reset to zero.

### **1 Hour:**

Rainfall in the past 60 minutes (last twelve 5 minute samples).  
Example: current time is 6:49, 1HOUR is the accumulated rain between 5:50 to 6:49.

### **24 Hours:**

Rainfall for the past 24 hours. Updates at each full hour. This is a running total.

### **7 Days:**

Rainfall from the last 7 consecutive 24 hour rainfall readings. Updates each day at midnight. Not a subject to the calendar. Be sure your time is set.

### **1 Month:**

Current Month: First day to current day. Current month will show. Press and release the PLUS button to view previous months.

### **1 Year:**

Current month plus past 11 months total. Current year will show. Press and release the PLUS button to view previous months.

### **Total:**

Total rainfall since station was powered on or reset.

**Note:** As time passes without rain, the 1 hour, 24 hour, and 7 day rain totals will count down to zero.

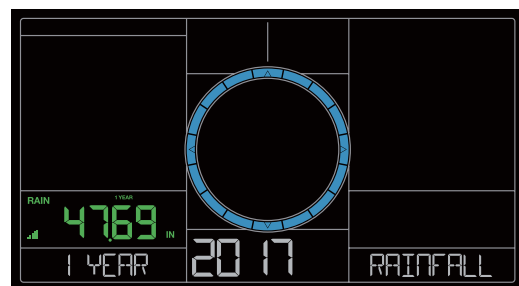
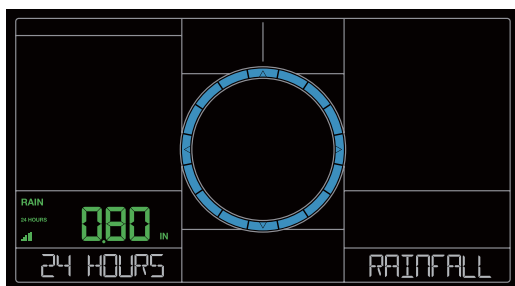

## Reset Rainfall Readings

1. Press the RAIN button to view individual rain readings.
2. Hold the MINUS button for five seconds to reset the individual value.
3. Rainfall reading will reset to 0.00
4. Press and release the LIGHT button, or wait 20 seconds to return to a full, normal display.

## HI | LO Temperature/Humidity Records

Press and release the TEMP button to view your HI and LO records with time and date of occurrence.  
A new HI or LO record will replace the existing record.

### Viewing order:

- Outdoor HI Temp with Time/Date
- Outdoor LO Temp with Time/Date
- Outdoor HI Humidity with Time/Date
- Outdoor LO Humidity with Time/Date
  
- Indoor HI Temp with Time/Date
- Indoor LO Temp with Time/Date
- Indoor HI Humidity with Time/Date
- Indoor LO Humidity with Time/Date
  
- Feels Like HI with time and date stamp
- Feels Like LO with time and date stamp
  - Outdoor Dew Point

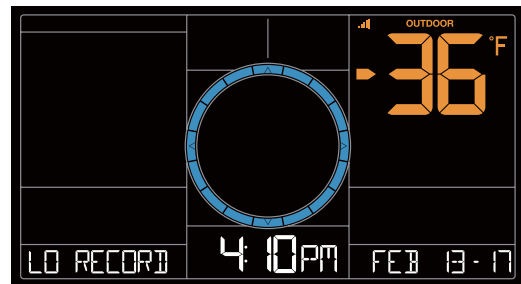
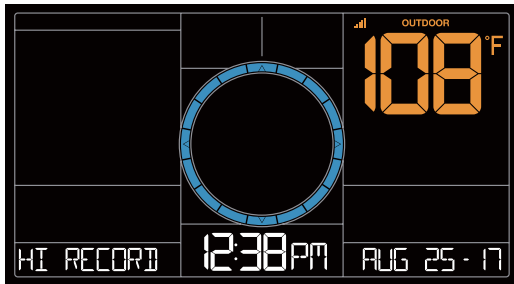

## Reset HI | LO Temperature/Humidity Records

1. Press the TEMP button to view individual readings.
2. Hold the MINUS button for five seconds to reset the individual value.
3. HI | LO reading will reset to current temperature, humidity, and current time/date.

## Daily HI | LO Temperatures

- When your station is connected to the La Crosse View™ app, you will see NWS FORECAST over the HI | LO temperatures.
- This indicates the daily HI | LO values displayed are from the National Weather Service.
- When you operate your station as a standalone unit, the daily HI | LO readings comes from your outdoor sensor.
- The daily HI | LO temperatures cannot be reset.

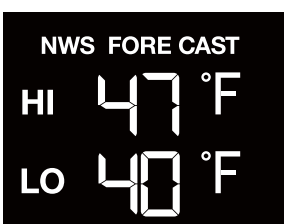

**Note:** The NWS Forecast of HI or LO temperatures will not match the HI and LO temperature from your sensor or on the La Crosse View™ app.

## Feels Like Temperature



Your “Feels Like” temperature is a combination of outdoor temperature/humidity and wind speed.

- When outdoor temperature is higher than 80°F, Heat Index will show as the Feels Like Temperature.
- When outdoor temperature is lower than 50°F, Wind Chill will show as the Feels Like Temperature.
- When outdoor temperature is between 50°F and 80°F, will show current outdoor temp as the Feels Like Temperature.



## Temperature | Humidity Trend Arrows

Your temperature (2°F / 1°C) and humidity (3%) trend indicators (arrows) update every 15 minutes. The trend reflects changes over the past one hour period.

-  UP ARROW: Temperature/Humidity is rising
-  RIGHT ARROW: Temperature/ Humidity is steady
-  DOWN ARROW: Temperature/Humidity is falling

## Seasonal Changes in Foliage

The tree foliage will change seasonally on your weather station. The dates are programmed into your weather station for an automatic foliage change.

### **Spring**



March 20th – June 20th

### **Summer**



June 21st – Sept. 20th

### **Autumn**



Sept. 21st – Dec 20th

### **Winter**



Dec 21st – Mar 19th



## Backlight Brightness (5 levels)

Your station has 5 levels of brightness for the backlight:

- When operating with the AC adapter press and release the LIGHT button to adjust the backlight:  
Intensity Levels: 0% | 3% | 20% | 50% | 100%
- When operating on battery power only, press the LIGHT button to activate the backlight for 10 seconds at 100%.

## Low Battery Icons

- Battery icon by Outdoor Temperature, replace batteries in your Thermo-Hygro sensor.
- Battery icon by Wind, replace batteries in your Wind sensor.
- Battery icon by Rain, replace batteries in your rain sensor.
- Battery icon by Indoor Temperature, replace batteries in your station.

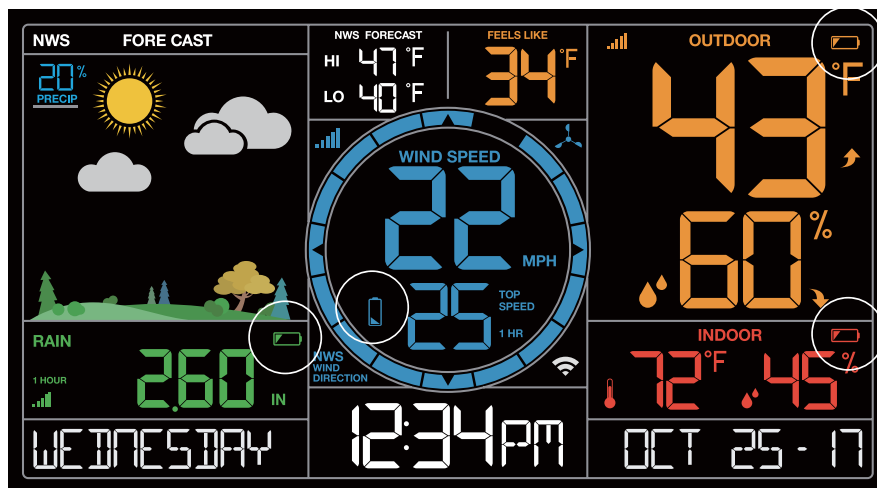

## Sensor Search | Sensor ID

Each of your sensors has an individual ID number, located on its bar code. This sensor ID is visible on your station by pressing the SENSOR button.

### View ID numbers:

- Press and release the SENSOR button to view individual station and sensor ID numbers. All other information will disappear temporarily.

### Search for all sensors:

- While viewing sensor ID, hold the SENSOR button for 3 seconds to search for all sensors.
  - The station will search for all sensor ID numbers on the station.
- Note:** Add-on sensor ID's will only show in the La Crosse View™ app.
- The sensor reception icon will flash for each sensor while searching.
- The sensor reception icon will be solid when sensor signal is acquired.
  - Allow up to 3 minutes to receive sensor signal.

View Sensor ID Number

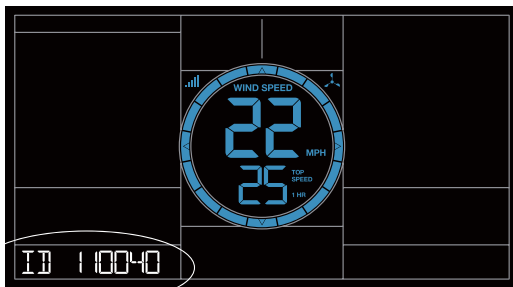

Deleted Sensor ID Number

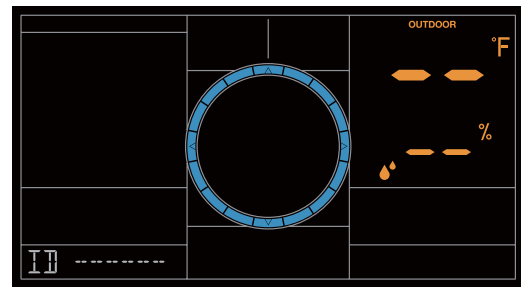

## Delete Your Sensor ID

In the rare event you need to replace your sensor, you will first need to delete the old sensor ID from your station.

1. Remove batteries from your old sensor.
2. Press and release the SENSOR button to view your sensor ID number.
3. While viewing your sensor ID, hold the MINUS button for 5 seconds to delete your old sensor ID. Dashes will show for the ID number.
4. Your station will search for a new sensor.
5. Install batteries in your new sensor and allow up to three minutes for your new sensor readings and ID to appear on your station.

**Note:** When replacing your Thermo-hygro sensor, press the TX button (under the battery cover) to send a signal immediately. The Rain and Wind sensors do not have a TX button.

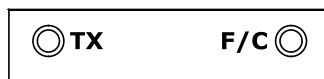

## Settings Menu C84428

When operating as a standalone station, you can manually adjust your stations settings

**Note:** When using the La Crosse View app, time and date will be set automatically.

1. Hold the SET button for 3 seconds to enter settings menu.
2. Press and release the + or - buttons to adjust the flashing values. Hold to adjust quickly.
3. Press and release the SET button to confirm and move to the next item.

**Note:** Press and release the LIGHT button any time to exit settings.

### Settings menu order:

1. BEEP ON | OFF
2. 12h/24h hour format
3. Hour
4. Minutes
5. Year
6. Month
7. Date

8. Temperature Fahrenheit | Celsius

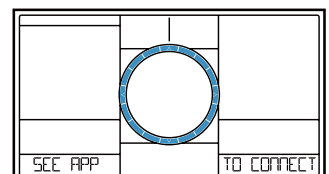
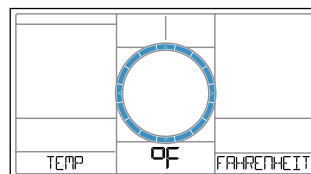
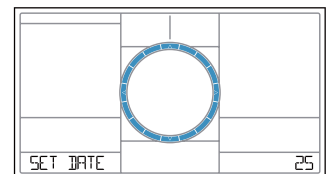
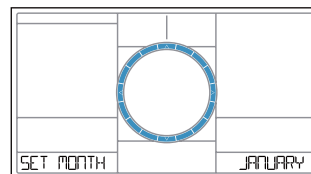
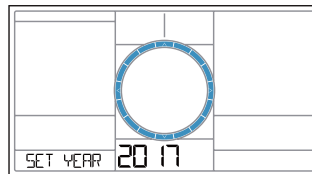
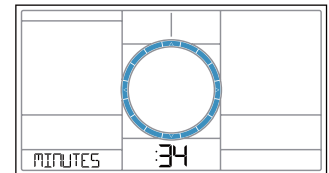
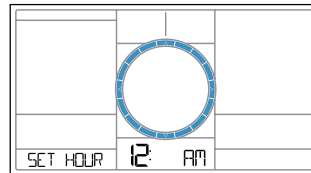
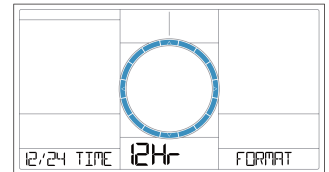
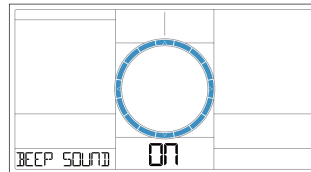

**Note:** SEE APP TO CONNECT will show as a reminder to connect to La Crosse View™ (optional).

- Press the LIGHT button to exit Settings Menu.

## Factory Reset C84428

A Factory Reset will remove all sensor ID numbers and Wi-Fi settings and return your station to default settings.

1. Hold the RAIN and LIGHT button together for 5 seconds.
2. Your station will reset and search for all sensors.
3. Allow up to 3 minutes to reacquire all sensors.
4. You will need to reconnect to your La Crosse View™ app by following the steps on [page 4](#).

## LTV-D1 Bonus Station

- As an added bonus, we have included a LTV-D1 to provide basic temperature and humidity in another room.
- Your bonus station receives information from your professional Thermo-hygro sensor

### Settings Menu

Your Bonus Station does not connect to La Crosse View and will need to be set manually:

1. Hold the SET/IN-OUT button for 3 seconds to enter setting menu
2. Press and release the +/SEARCH button to adjust settings. Hold to adjust quickly.
3. Press and release the SET/IN-OUT button to move to next item

#### **Setting order:**

1. 12/24 Hour Time
2. Hour
3. Minutes
4. Fahrenheit/Celsius

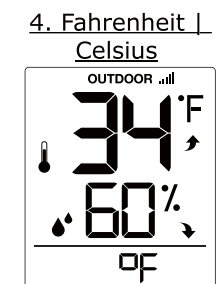
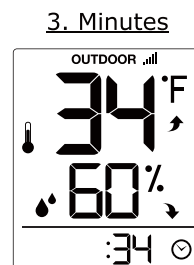
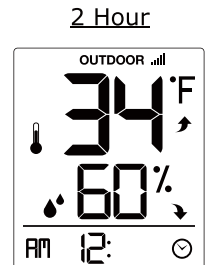
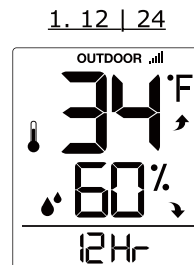

#### **View Indoor or Outdoor Data**

Press and release the SET/IN-OUT button to switch between:

- Outdoor temperature/ humidity
- Indoor temperature/humidity readings.

#### **Search for Outdoor Sensor**

In the rare event your bonus station loses connection with the Thermo-hygro sensor, the outdoor readings will show dashes.

- Simply hold the +/SEARCH button for three seconds to search for the sensor.
- The sensor reception icon will flash for each sensor while searching. 

#### **Restart**

1. Remove batteries for 15 minutes.
2. Press any button 20 times.
3. Install fresh batteries.
4. Allow up to 3 minutes to connect to your Thermo-hygro sensor

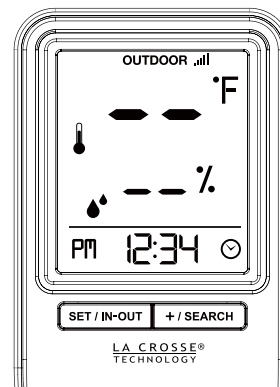

## Help Us, Help You!

If you have ideas for features or support solutions you'd like to see us make, please let us know! We truly want to make owning a La Crosse Technology product not only a practical experience, but also a fun one. So email us at: [store@lacrossetechnology.com](mailto:store@lacrossetechnology.com)

## Let's Be Social!

Follow us on our social media outlets for the latest promotions, product support, and awesome giveaways.



## Specifications

### Indoor

**Temperature Range:** 32° F to 122° F (0° C to 50° C)

**Humidity Range:** 10% RH to 99%RH

### Thermo-hygro Sensor

**Temperature Range:** -40° F to 140° F (-40° C to 60° C)

**Note:** Temperatures below -20°F (-29°C) require Lithium batteries in the outdoor sensor.

**Humidity Range:** 10% RH to 99%RH

**Transmission Range:** Up to 400 feet (121 meters) in open air, RF 915 MHz

### Wind Speed Sensor

**Wind Speed Range:** 0-111 mph (0-178 kmh)

**Transmission Range:** Up to 400 feet (121 meters) in open air, RF 915 MHz

### Rain Sensor

**Rainfall Range:** 0-393.6 inches ( 0-9999 mm)

**Transmission Range:** Up to 400 feet (121 meters) in open air, RF 915 MHz

### Wi-Fi

**Transmission:** RF 2.4 GHz

## Power

<b>C84428 Station:</b>	5.0 Volt 500mA power cord included (Required) AC6: HX06-0500600-AU-001
Optional Battery Backup:	3-AA batteries included, backup for time and date
<b>LTV-TH2 Thermo-hygro Sensor:</b>	2-AA batteries included
<b>LTV-W1 Wind Speed Sensor:</b>	2-C batteries included
<b>LTV-R2 Rain Sensor:</b>	2-AA batteries included
<b>LTV-D1 Bonus Station:</b>	2-AAA batteries included

## Battery Life

<b>C84428 Station:</b>	48-60 months with power cord use
<b>LTV-TH2, LTV-W1, &amp; LTV-R2 Sensors:</b>	over 24 months with reputable batteries.
<b>LTV-D1 Bonus Station:</b>	over 12 months with reputable batteries.

## Dimensions

<b>C84428 Station:</b>	8.98" L x 1.0" W x 5.43" H (22.8cm L x 2.6 cm W x 13.8cm H)
<b>LTV-TH2 Thermo-hygro Sensor:</b>	1.97" L x 0.75" W x 5.73" H (5.0cm L x 1.91cm W x 14.55cm H)
<b>LTV-W1 Wind Speed Sensor:</b>	7.10" L x 7.10" W x 18.57" H (18.03cm L x 18.03cm W x 47.17cm H) with mounting bracket/pole
<b>LTV-R2 Rain Sensor:</b>	7.14" L x 3.43" W x 4.94" H (18.13cm L x 8.72cm W x 12.54cm H)
<b>LTV-D1 Bonus Station:</b>	2.64" L x 1.32" W x 3.62" H ( 6.7 cm L x 3.35cm W x 9.19cm H)

## Care and Maintenance

- Do not mix old and new batteries.
- Do not mix Alkaline, Standard, Lithium, or Rechargeable Batteries.
- Always purchase the correct size and grade of battery most suitable for intended use.
  - Replace all batteries of a set at the same time.
- Clean the battery contacts and also those of the device prior to battery installation.
  - Ensure the batteries are installed with correct polarity (+ and -).
- Remove batteries from equipment when it is not used for an extended period of time.
  - Promptly remove expired batteries.

# **Warranty and Support**

La Crosse Technology, Ltd. provides a 1-year limited time warranty (from date of purchase) on this product relating to manufacturing defects in materials & workmanship.

Before returning a product, please contact our friendly customer support with questions or visit our online help:

Phone: 1-844-200-8452

Online Product Support and Registration: [www.lacrossetechnology.com/support](http://www.lacrossetechnology.com/support)

## **FCC Statement**

This equipment has been tested and found to comply with the limits for a Class B digital device, pursuant to part 15 of the FCC Rules. These limits are designed to provide reasonable protection against harmful interference in a residential installation. This equipment generates, uses and can radiate radio frequency energy and, if not installed and used in accordance with the instructions, may cause harmful interference to radio communications. However, there is no guarantee that interference will not occur in a particular installation.

If this equipment does cause harmful interference to radio or television reception, which can be determined by turning the equipment off and on, the user is encouraged to try to correct the interference by one or more of the following measures:

- Reorient or relocate the receiving antenna.
- Increase the separation between the equipment and receiver.
- Connect the equipment into an outlet on a circuit different from that to which the receiver is connected.
- Consult the dealer or an experienced radio/TV technician for help.

This device must not be co-located or operating in conjunction with any other antenna or transmitter.

### **Operation is subject to the following two conditions:**

- (1) This device may not cause harmful interference, and
- (2) This device must accept any interference received, including interference that may cause undesired operation.

### **Caution!**

The manufacturer is not responsible for any radio or TV interference caused by unauthorized changes or modifications to this equipment. Such changes or modifications could void the user authority to operate the equipment.

This equipment must be installed and operated in accordance with provided instructions and the antenna(s) used for this transmitter must be installed to provide a separation distance of at least 20 cm from all persons and must not be co-located or operating in conjunction with any other antenna or transmitter

All rights reserved. This manual may not be reproduced in any form, even in part, or duplicated or processed using electronic, mechanical or chemical process without the written permission of the publisher. This booklet may contain errors or misprints. The information it contains is regularly checked and corrections are included in subsequent editions. We disclaim any responsibility for any technical error or printing error, or their consequences.

All trademarks and patents are recognized.

Made in China - Printed in China

## Canada Statement

This device complies with Industry Canada's licence-exempt RSSs. Operation is subject to the following two conditions:

- (1) This device may not cause interference; and
- (2) This device must accept any interference, including interference that may cause undesired operation of the device.

Le présent appareil est conforme aux CNR d'Industrie Canada applicables aux appareils radio exempts de licence. L'exploitation est autorisée aux deux conditions suivantes :

- (1) l'appareil ne doit pas produire de brouillage;
- (2) l'utilisateur de l'appareil doit accepter tout brouillage radioélectrique subi, même si le brouillage est susceptible d'en compromettre le fonctionnement.

The device meets the exemption from the routine evaluation limits in section 2.5 of RSS 102 and compliance with RSS-102 RF exposure, users can obtain Canadian information on RF exposure and compliance.

Le dispositif rencontre l'exemption des limites courantes d'évaluation dans la section 2.5 de RSS 102 et la conformité à l'exposition de RSS-102 rf, utilisateurs peut obtenir l'information canadienne sur l'exposition et la conformité de rf.

This transmitter must not be co-located or operating in conjunction with any other antenna or transmitter. This equipment should be installed and operated with a minimum distance of 20 centimeters between the radiator and your body.

Cet émetteur ne doit pas être Co-placé ou ne fonctionnant en même temps qu'aucune autre antenne ou émetteur. Cet équipement devrait être installé et actionné avec une distance minimum de 20 centimètres entre le radiateur et votre corps.