

前壳  
后壳  
电池门  
围栏  
按钮  
挂孔套  
塞子  
镜片  
导光柱

白色射出(陶瓷白), 不喷漆, 丝印一道PANTONE COOL GREY 11C  
PANTONE 429C射出, 不喷漆, 丝印两道黑色  
白色射出(陶瓷白), 不喷漆, 丝印一道PANTONE COOL GREY 11C  
白色射出(陶瓷白), 不喷漆, 不丝印  
白色射出(陶瓷白), 不喷漆, 不丝印  
白色射出(陶瓷白), 不喷漆, 不丝印  
白色射出(陶瓷白), 不喷漆, 不丝印  
透明射出, 不喷漆, 不丝印  
透明射出, 不喷漆, 不丝印

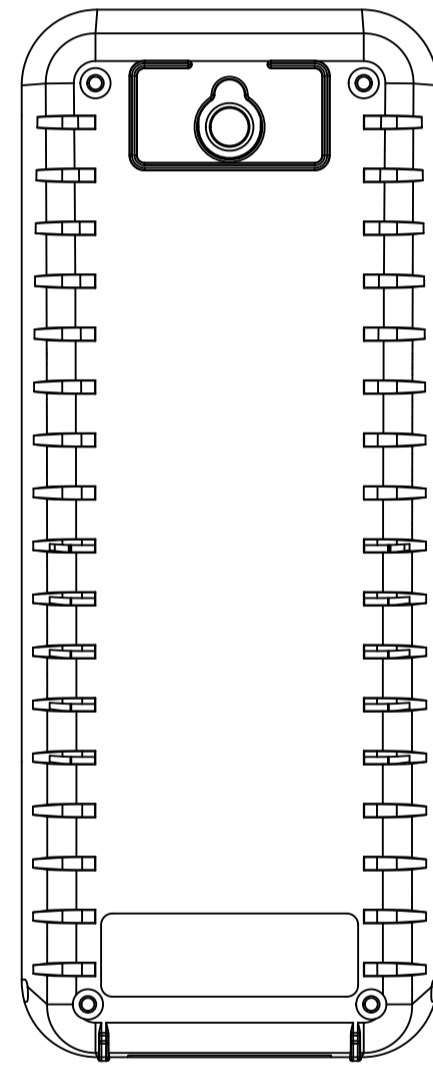

福州汉强电子有限公司			
机型	LTV-THP1		
制作	刘国泉	经理核准	
核准	结构	电子	业务
版本	V1.0	日期	19.02.22

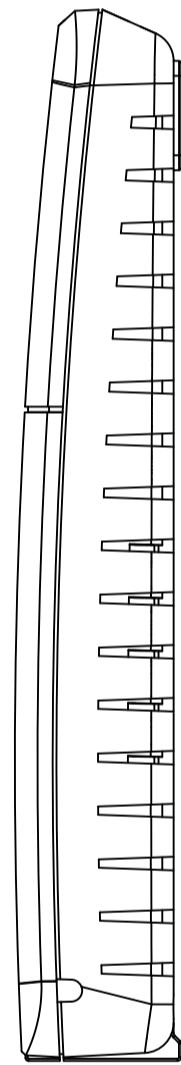
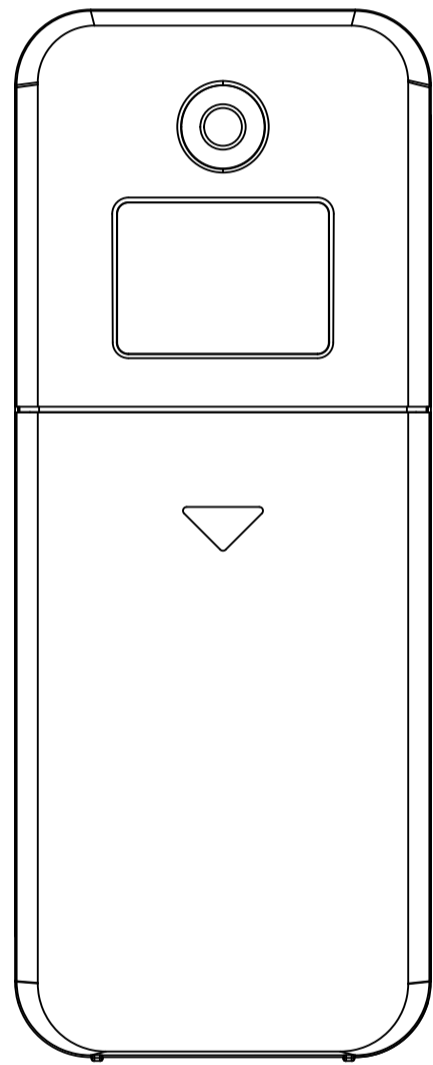
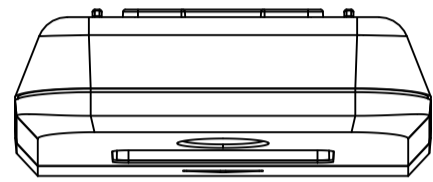
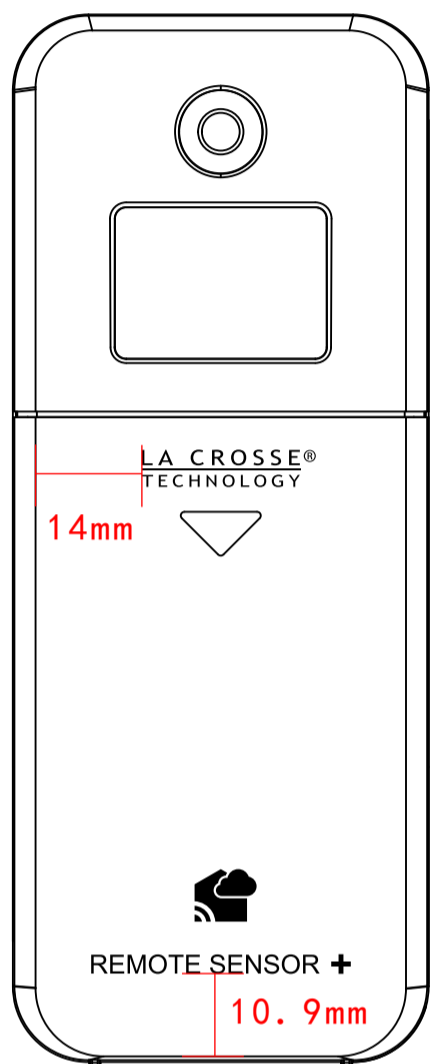
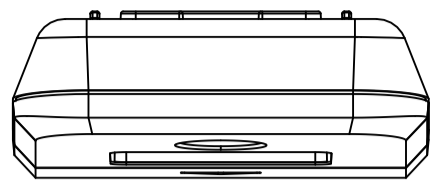

丝印一道Cool Gray 11C

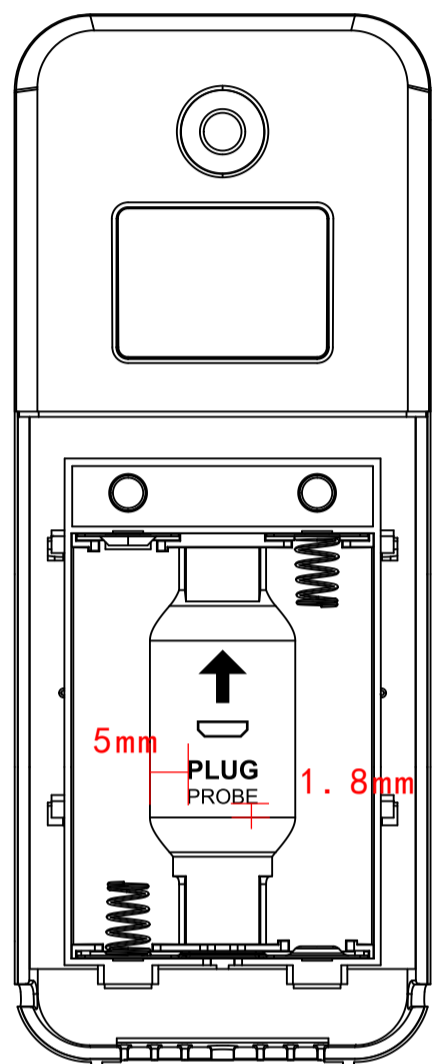

丝印一道Cool Gray 11C

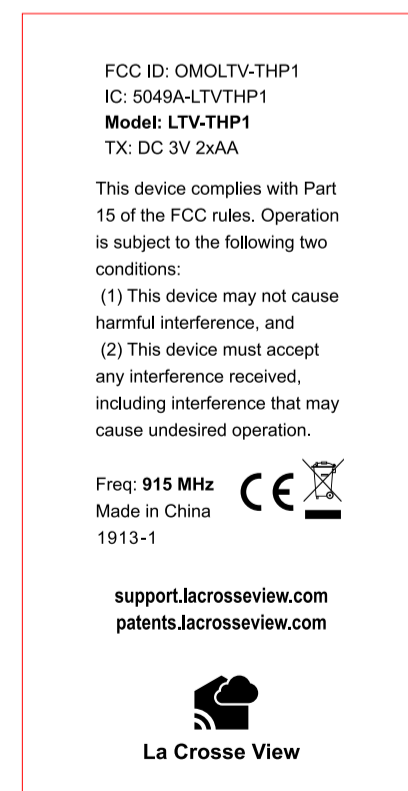
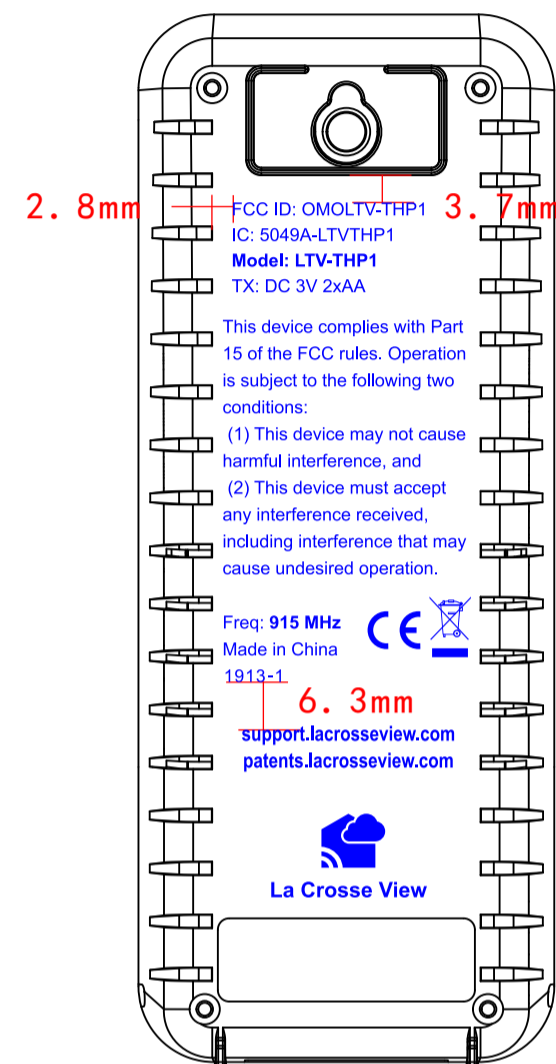
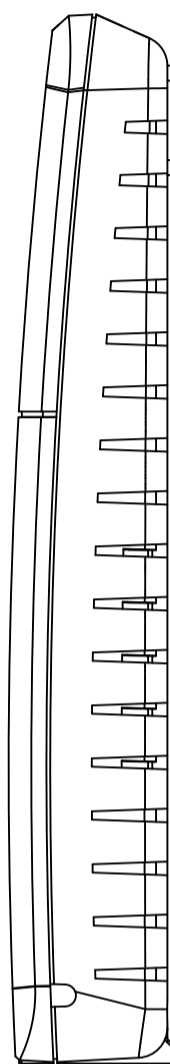

丝印两道黑色

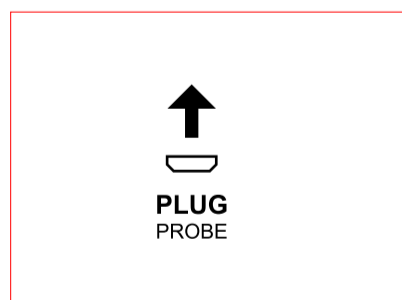
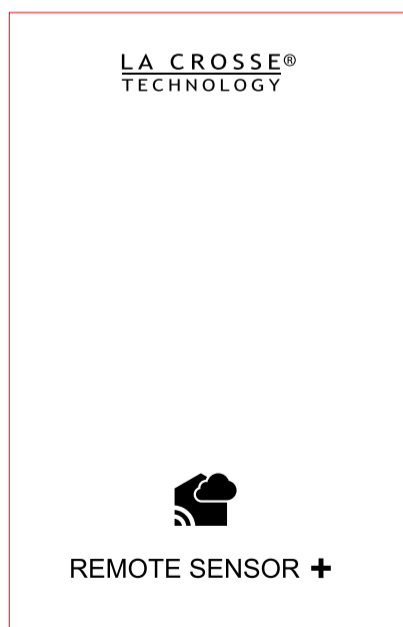

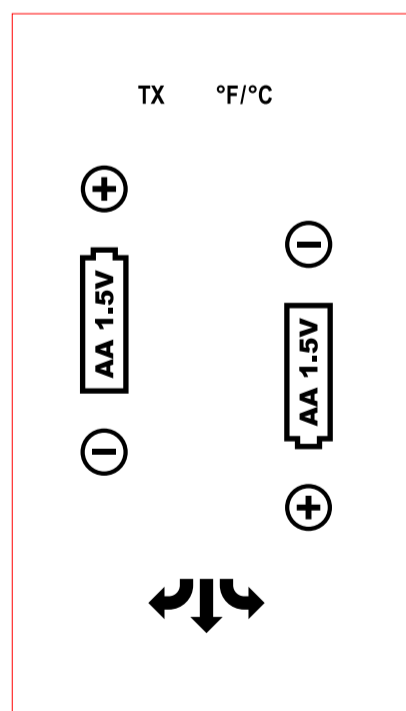
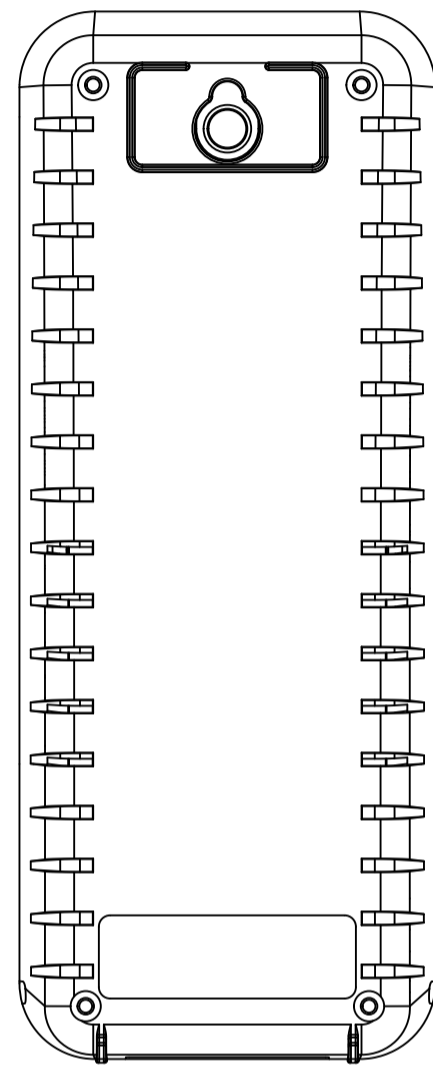
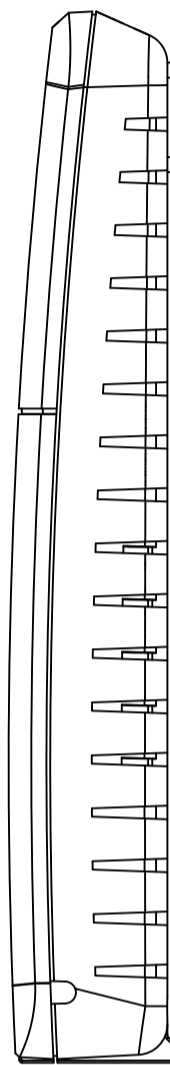
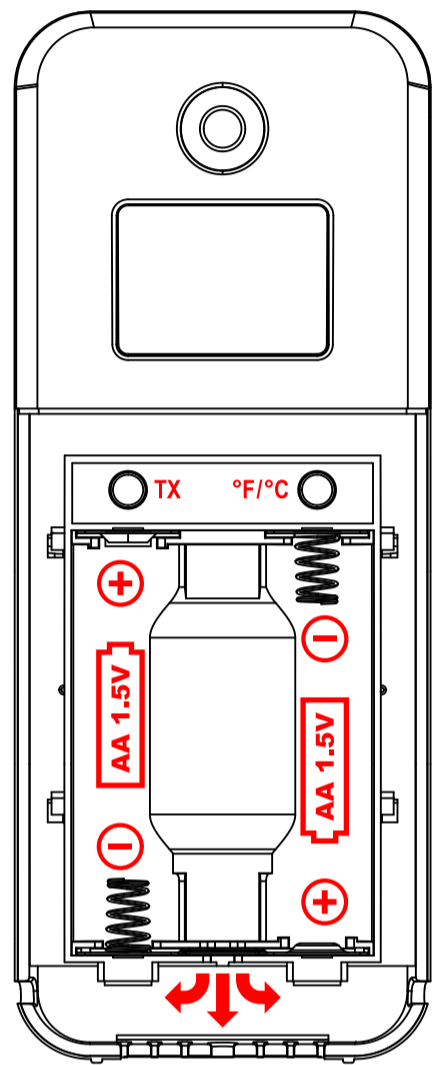
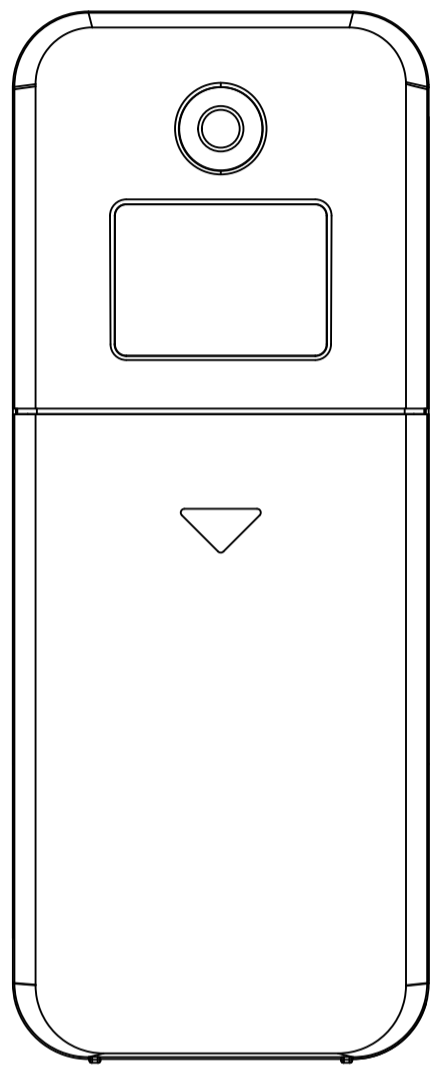
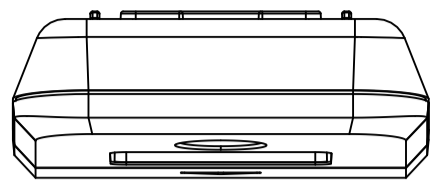

刻凸字,字高0.3mm  
 互换镶件  
 比例1:1

前壳  
 后壳  
 电池门  
 围栏  
 按钮  
 挂孔  
 塞子  
 镜片  
 导光柱

抛光,亮面  
 皮纹同TX008款后壳皮纹  
 抛光,亮面  
 无皮纹,亮面  
 无皮纹,亮面  
 无皮纹,亮面  
 无皮纹,亮面  
 抛光,亮面  
 抛光,亮面