

## FCC/IC - TEST REPORT

Report Number : **68.950.18.0034.01** Date of Issue: March 27, 2018

Model : **IFT1018**

Product Type : **TABLET**

Applicant : **Icon Health and Fitness, Inc.**

Address : **1500 South 1000 West, Logan, Utah, United States**

Manufacturer : **Icon Health and Fitness, Inc.**

Address : **1500 South 1000 West, Logan, Utah, United States**

Test Result :  **Positive**     **Negative**

Total pages including  
Appendices : **48**

*TÜV SÜD Certification and Testing (China) Co., Ltd. Shenzhen Branch is a subcontractor to TÜV SÜD Product Service GmbH according to the principles outlined in ISO 17025.*

*TÜV SÜD Certification and Testing (China) Co., Ltd. Shenzhen Branch reports apply only to the specific samples tested under stated test conditions. Construction of the actual test samples has been documented. It is the manufacturer's responsibility to assure that additional production units of this model are manufactured with identical electrical and mechanical components. The manufacturer/importer is responsible to the Competent Authorities in Europe for any modifications made to the production units which result in non-compliance to the relevant regulations. TÜV SÜD Certification and Testing (China) Co., Ltd. Shenzhen Branch shall have no liability for any deductions, inferences or generalizations drawn by the client or others from TÜV SÜD Certification and Testing (China) Co., Ltd. Shenzhen Branch issued reports.*

*This report is the confidential property of the client. As a mutual protection to our clients, the public and ourselves, extracts from the test report shall not be reproduced except in full without our written approval*



# 1 Table of Contents

1	Table of Contents .....	2
2	Details about the Test Laboratory.....	3
3	Description of the Equipment under Test .....	4
4	Summary of Test Standards.....	5
5	Summary of Test Results.....	6
6	General Remarks .....	7
7	Test Setups .....	8
8	Systems test configuration.....	9
9	Technical Requirement .....	10
9.1	Conducted Emission.....	10
9.2	Conducted Average output power .....	13
9.3	6dB bandwidth .....	14
9.4	Power spectral density.....	20
9.5	Spurious RF conducted emissions .....	26
9.6	Band edge .....	36
9.7	Spurious radiated emissions for transmitter .....	40
10	Test Equipment List.....	47
11	System Measurement Uncertainty .....	48

## 2 Details about the Test Laboratory

### Details about the Test Laboratory

#### Test Site 1

Company name: TÜV SÜD Certification and Testing (China) Co., Ltd. Shenzhen Branch  
Building 12&13, Zhiheng Wisdomland Business Park,  
Nantou Checkpoint Road 2, Nanshan District,  
Shenzhen City, 518052,  
P. R. China

FCC Registration Number: 514049

IC Registration Number: 10320A-1

Telephone: 86 755 8828 6998  
Fax: 86 755 8828 5299

### 3 Description of the Equipment under Test

#### Description of the Equipment Under Test

Product:	TABLET
Model no.:	IFT1018
IC:	3673A-IFT1018
FCC ID:	OMCIFT1018
Options and accessories:	NIL
Rating:	3.8VDC, 6000mAh (supplied by an internal rechargeable battery pack) or 5VDC, 2000mA (charging by an external adapter) Model: SAW12-050-2000UB Input: 100 – 240VAC, 50/60Hz, 0.3A Output: 5VDC, 2000mA
RF Transmission Frequency:	2412-2462MHz for 802.11b/g/nHT20
No. of Operated Channel:	11
Modulation:	CCK, DQPSK, DBPSK for 802.11b QPSK,BPSK for 802.11g/n
Antenna Type:	Integrated Antenna
Antenna Gain:	2.23dBi
Description of the EUT:	The Equipment Under Test (EUT) is a TABLET with WIFI function operating at 2.4GHz

## 4 Summary of Test Standards

Test Standards	
FCC Part 15 Subpart C 10-1-2016 Edition	PART 15 - RADIO FREQUENCY DEVICES Subpart C - Intentional Radiators
RSS-Gen Issue 4 November 2014	General Requirements for the Certification of Radio Apparatus.
RSS-247 Issue 2 2017	Digital Transmission Systems (DTS), Frequency Hopping Systems (FHSS) and License-Exempt Local Area Network (LE-LAN) Devices

All the test methods were according to KDB558074 D01 v4.0 DTS Measurement Guidance and ANSI C63.10 (2013).

## 5 Summary of Test Results

Technical Requirements					
FCC Part 15 Subpart C/RSS-247 Issue 2/RSS-Gen Issue 4					
Test Condition			Pages	Test Result	Test Site
§15.207	RSS-GEN 8.8	Conducted emission AC power port	10	Pass	Site 1
§15.247(b)(1)	RSS-247 Clause 5.4(2)	Conducted Average output power	13	Pass	Site 1
§15.247(e)	RSS-247 Clause 5.2(2)	Power spectral density*	20	Pass	Site 1
§15.247(a)(2)	RSS-247 Clause 5.2(1)	6dB bandwidth	14	Pass	Site 1
§15.247(a)(1)	RSS-247 Clause 5.1(1)	20dB bandwidth and 99% Occupied Bandwidth	14	Pass	Site 1
§15.247(a)(1)	RSS-247 Clause 5.1(2)	Carrier frequency separation	--	N/A	--
§15.247(a)(1)(iii)	RSS-247 Clause 5.1(4)	Number of hopping frequencies	--	N/A	--
§15.247(a)(1)(iii)	RSS-247 Clause 5.1(4)	Dwell Time	--	N/A	--
§15.247(d)	RSS-247 Clause 5.5	Spurious RF conducted emissions	26	Pass	Site 1
§15.247(d)	RSS-247 Clause 5.5	Band edge	36	Pass	Site 1
§15.247(d) & §15.209 &	RSS-247 Clause 5.5 & RSS-GEN 6.13	Spurious radiated emissions for transmitter and receiver	40	Pass	Site 1
§15.203	RSS-GEN 8.3	Antenna requirement	See note 1	Pass	--

Remark 1: N/A – Not Applicable.

Note 1: The EUT uses an integrated antenna, which gain is 2.23dBi. According to §15.203, it is considered sufficiently to comply with the provisions of this section.

## 6 General Remarks

### Remarks

This submittal(s) (test report) is intended for FCC ID: OMCIFT1018, IC: 3673A-IFT1018, complies with Section 15.207, 15.209, 15.205, 15.247 of the FCC Part 15, Subpart C and RSS 247 and RSS-Gen rules.

### SUMMARY:

All tests according to the regulations cited on page 5 were

- Performed

- **Not** Performed

The Equipment under Test

- **Fulfills** the general approval requirements.

- **Does not** fulfill the general approval requirements.

Sample Received Date: January 25, 2018

Testing Start Date: January 25, 2018

Testing End Date: February 01, 2018

- TÜV SÜD Certification and Testing (China) Co., Ltd. Shenzhen Branch -

Reviewed by:

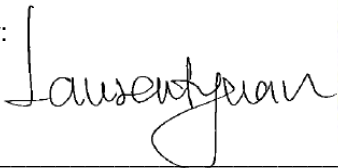

Laurent Yuan  
EMC Project Manager



Prepared by:

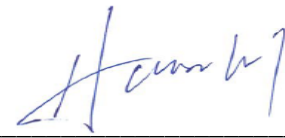

Aaron Lai  
EMC Project Engineer

## 7 Test Setups

### 7.1 Radiated test setups

Below 1GHz

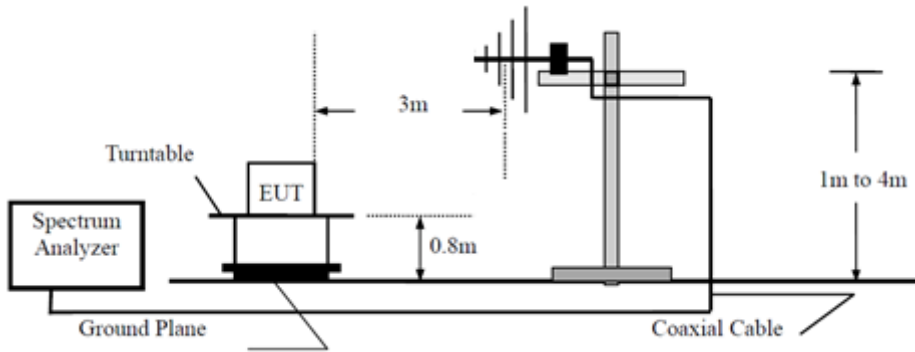

Above 1GHz

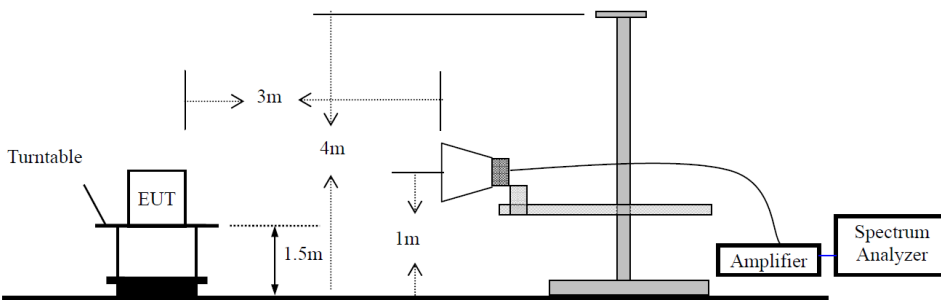

### 7.2 Conducted RF test setups

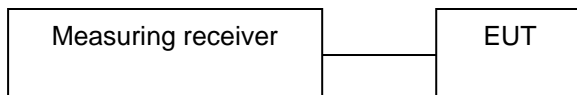

### 7.3 AC Power Line Conducted Emission test setups

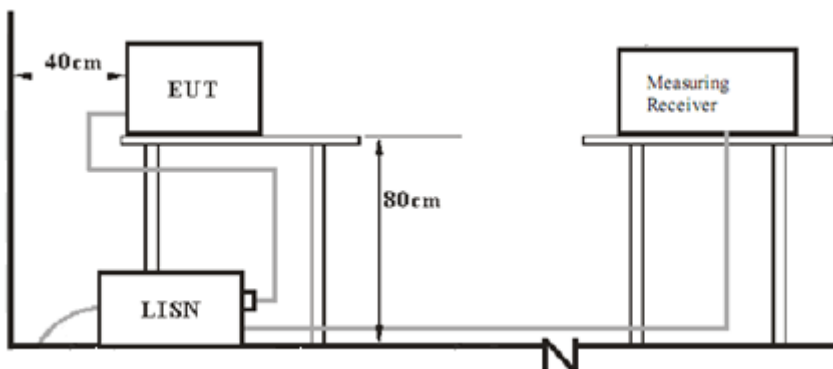



## 8 Systems test configuration

Auxiliary Equipment Used during Test:

DESCRIPTION	MANUFACTURER	MODEL NO.(SHIELD)	S/N(LENGTH)
---	---	---	---

Test software: RF test tool

The system was configured to channel 1, 6 and 11 for the test.

## 9 Technical Requirement

### 9.1 Conducted Emission

#### Test Method

1. The EUT was placed on a table, which is 0.8m above ground plane
2. The power line of the EUT is connected to the AC mains through a Artificial Mains Network (A.M.N.).
3. Maximum procedure was performed to ensure EUT compliance
4. A EMI test receiver is used to test the emissions from both sides of AC line

#### Limit

Frequency MHz	QP Limit dB $\mu$ V	AV Limit dB $\mu$ V
0.150-0.500	66-56*	56-46*
0.500-5	56	46
5-30	60	50

Decreasing linea

## Conducted Emission

Product Type : TABLET  
 M/N : IFT1018  
 Operating Condition : TX  
 Test Specification : Live  
 Comment : AC 120V/60Hz

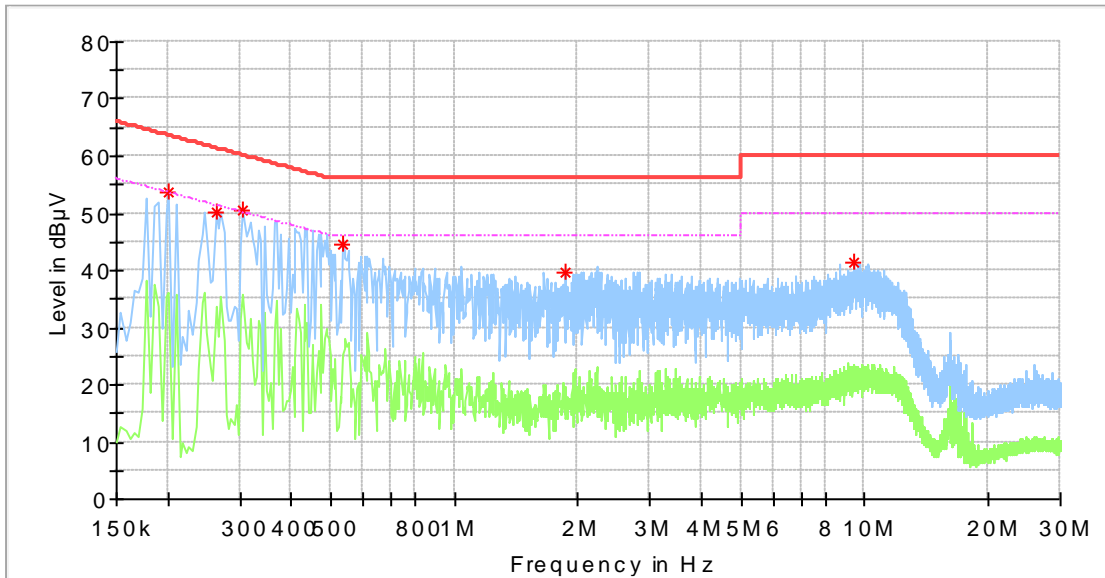

Frequency (MHz)	MaxPeak (dBµV)	Average (dBµV)	Limit (dBµV)	Margin (dB)	Line	Corr. (dB)
0.202000	53.69	---	63.53	9.84	L1	10.2
0.262000	50.21	---	61.37	11.16	L1	10.2
0.306000	50.65	---	60.08	9.43	L1	10.2
0.534000	44.40	---	56.00	11.60	L1	10.2
1.858000	39.72	---	56.00	16.28	L1	10.3
9.398000	41.23	---	60.00	18.77	L1	10.6

Remark : "\*" Correct factor=cable loss + LISN factor

### Conducted Emission

Product Type : TABLET  
 M/N : IFT1018  
 Operating Condition : TX  
 Test Specification : Neutral  
 Comment : AC 120V/60Hz

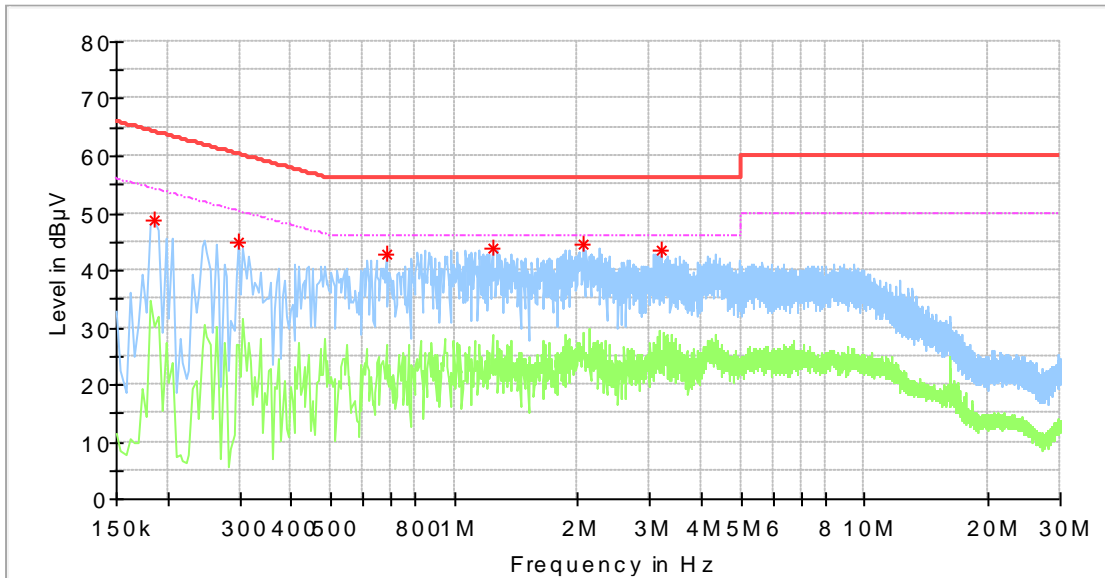

Frequency (MHz)	MaxPeak (dBµV)	Average (dBµV)	Limit (dBµV)	Margin (dB)	Line	Corr. (dB)
0.186000	48.61	---	64.21	15.61	N	10.3
0.298000	44.87	---	60.30	15.43	N	10.3
0.682000	42.79	---	56.00	13.21	N	10.4
1.238000	43.90	---	56.00	12.10	N	10.4
2.062000	44.61	---	56.00	11.39	N	10.4
3.210000	43.45	---	56.00	12.55	N	10.5

Remark : “\*” Correct factor=cable loss + LISN factor

## 9.2 Conducted Average output power

### Test Method

1. Setting the highest output power level of the EUT:
2. Connect to gated RF average power meter.

### Test Setup

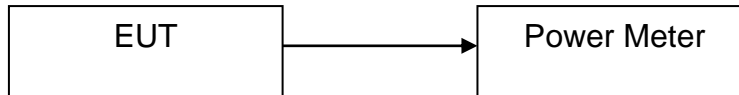

### Limits

According to §15.247 (b) (3), conducted Average output power limit as below:

Frequency Range MHz	Limit W	Limit dBm
2400-2483.5	≤1	≤30

Test result as below table  
802.11b

Frequency MHz	Conducted Average Output Power dBm	Result
Top channel 2412MHz	13.4	Pass
Middle channel 2437MHz	13.4	Pass
Bottom channel 2462MHz	13.4	Pass

802.11g

Frequency MHz	Conducted Average Output Power dBm	Result
Top channel 2412MHz	12.3	Pass
Middle channel 2437MHz	12.3	Pass
Bottom channel 2462MHz	12.3	Pass

802.11nHT20

Frequency MHz	Conducted Average Output Power dBm	Result
Top channel 2412MHz	11.5	Pass
Middle channel 2437MHz	11.3	Pass
Bottom channel 2462MHz	11.4	Pass

### 9.3 6dB bandwidth

#### Test Method

1. Use the following spectrum analyzer settings:  
RBW=100K, VBW $\geq$ 3RBW, Sweep = auto, Detector function = peak, Trace = max hold
2. Use the automatic bandwidth measurement capability of an instrument, may be employed using the X dB bandwidth mode with X set to 6 dB, care shall be taken so that the bandwidth measurement is not influenced by any intermediate power nulls in the fundamental emission that might be  $\geq$  6 dB.
3. Allow the trace to stabilize, record the X dB Bandwidth value.

#### Limit

Limit [kHz]

≥500

Test result

802.11b

Frequency MHz	99% bandwidth MHz	6dB bandwidth MHz	Result
Bottom channel 2412MHz	10.029	12.199	Pass
Middle channel 2437MHz	9.986	12.243	Pass
Top channel 2462MHz	10.029	12.243	Pass

802.11g

Frequency MHz	99% bandwidth MHz	6dB bandwidth MHz	Result
Bottom channel 2412MHz	15.412	16.367	Pass
Middle channel 2437MHz	15.456	16.410	Pass
Top channel 2462MHz	15.803	16.410	Pass

802.11nHT20

Frequency MHz	99% bandwidth MHz	6dB bandwidth MHz	Result
Bottom channel 2412MHz	17.670	17.627	Pass
Middle channel 2437MHz	17.627	17.626	Pass
Top channel 2462MHz	17.627	17.670	Pass

6dB bandwidth

802.11b

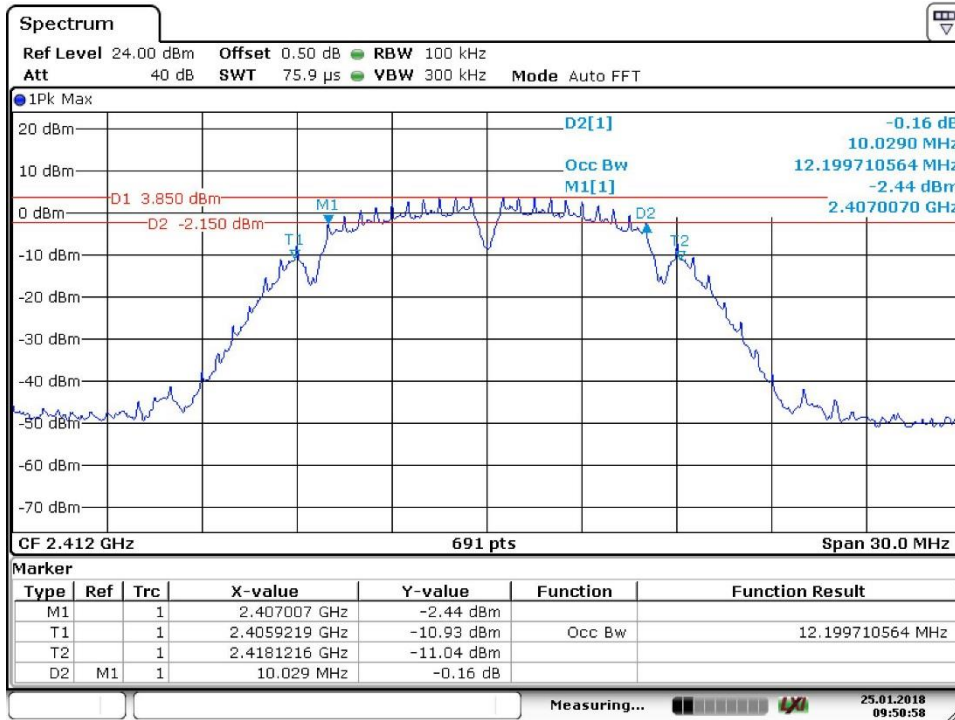

Date: 25.JAN.2018 09:50:58

2412MHz

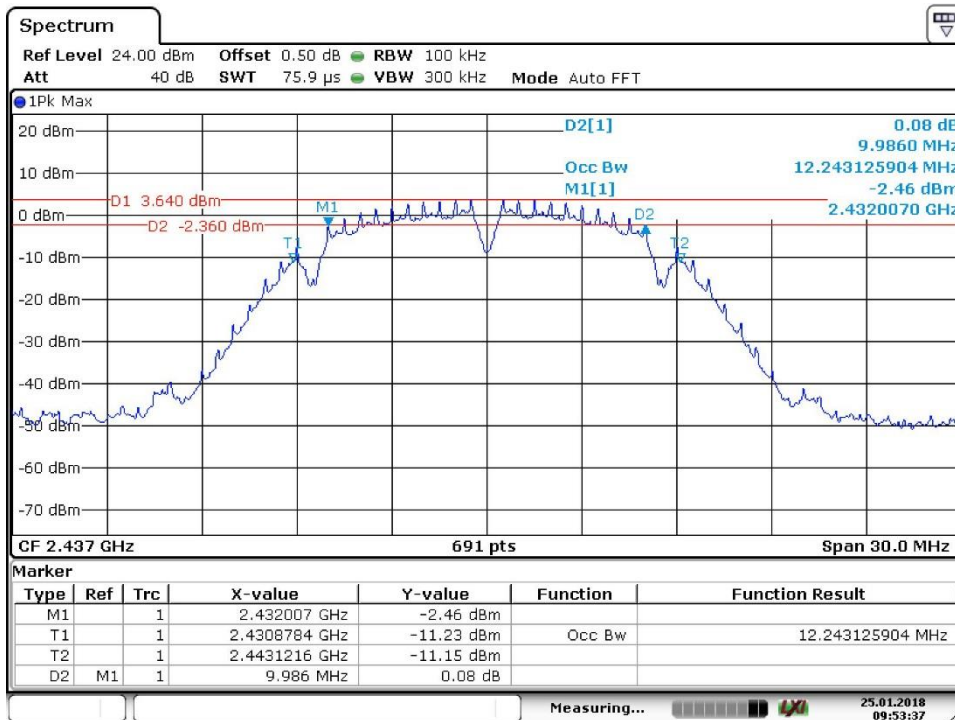

Date: 25.JAN.2018 09:53:37

2437MHz

**6dB bandwidth**

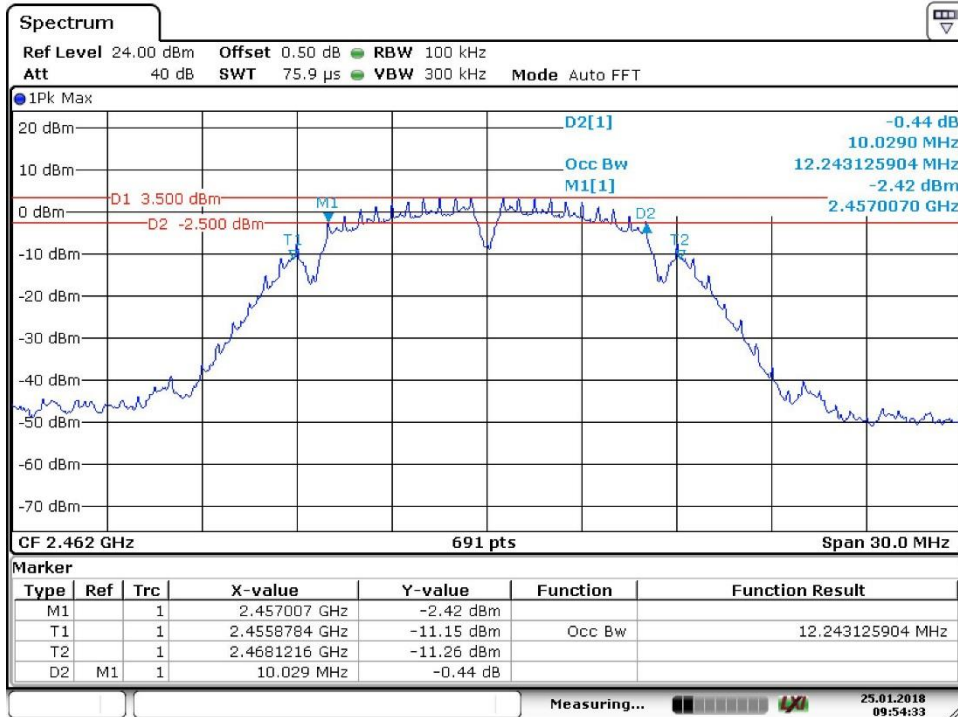

Date: 25.JAN.2018 09:54:32

2462MHz

802.11g

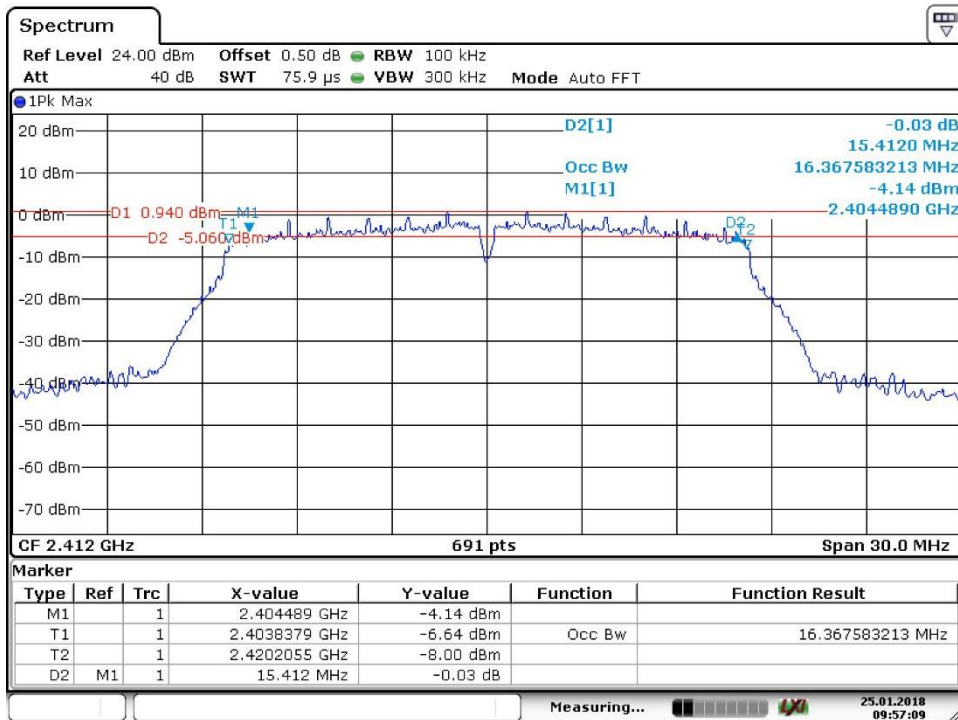

Date: 25.JAN.2018 09:57:09

2412MHz



6dB bandwidth

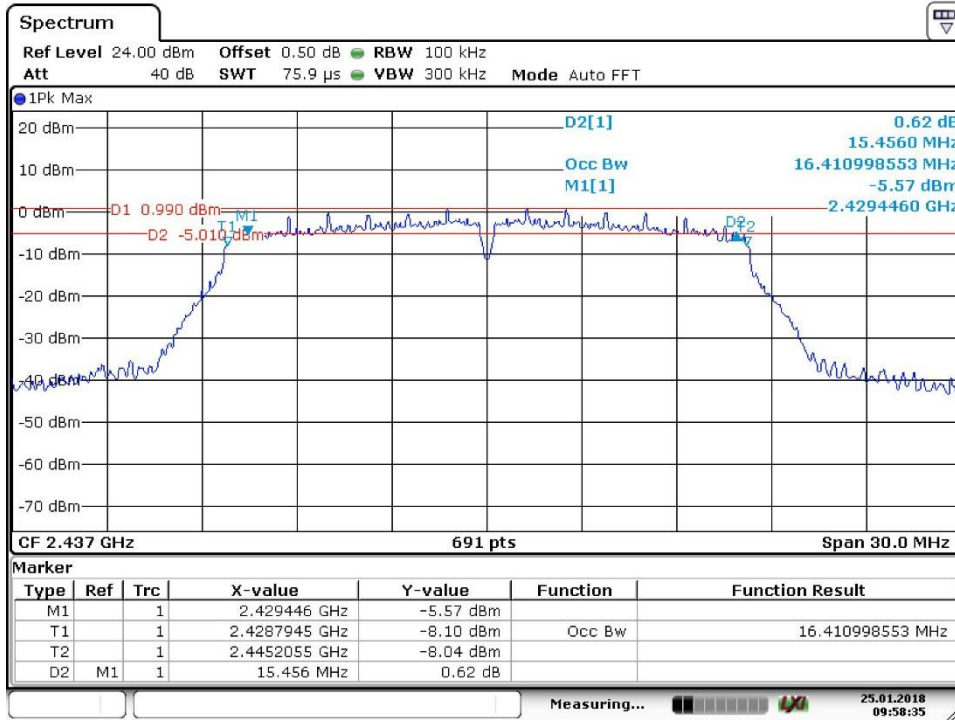

Date: 25.JAN.2018 09:58:35

2437MHz

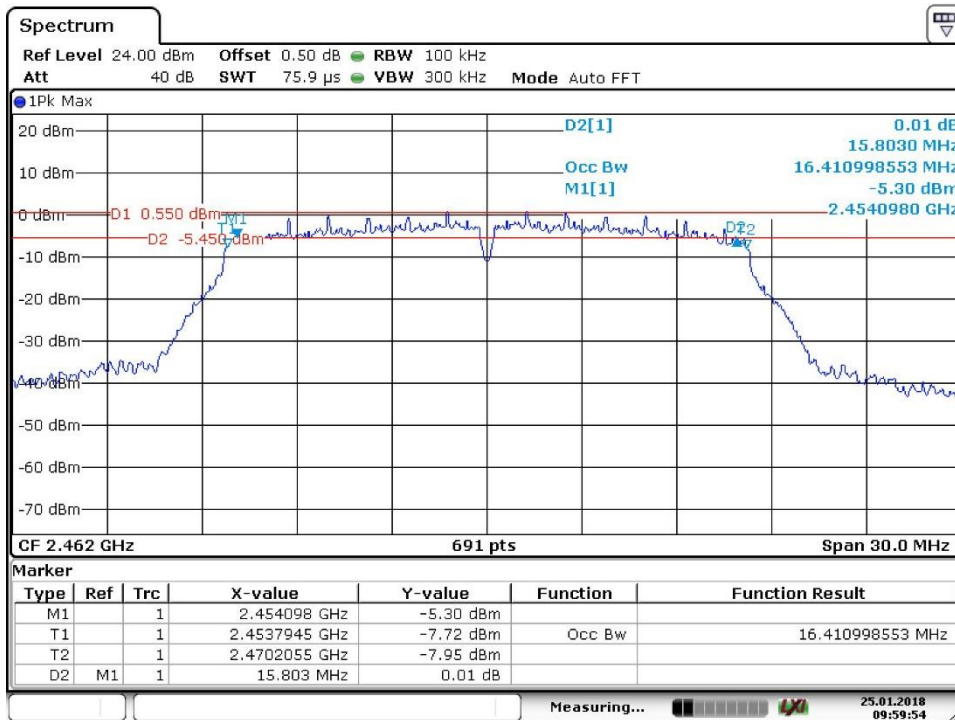

Date: 25.JAN.2018 09:59:55

2462MHz

6dB bandwidth

802.11nHT20

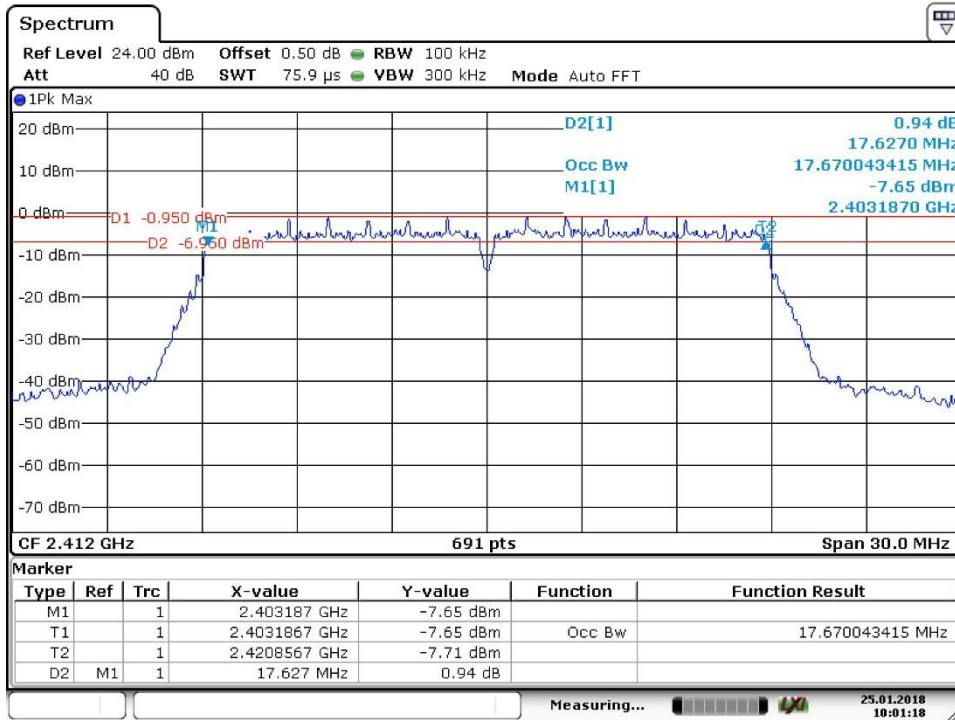

Date: 25.JAN.2018 10:01:18

2412MHz

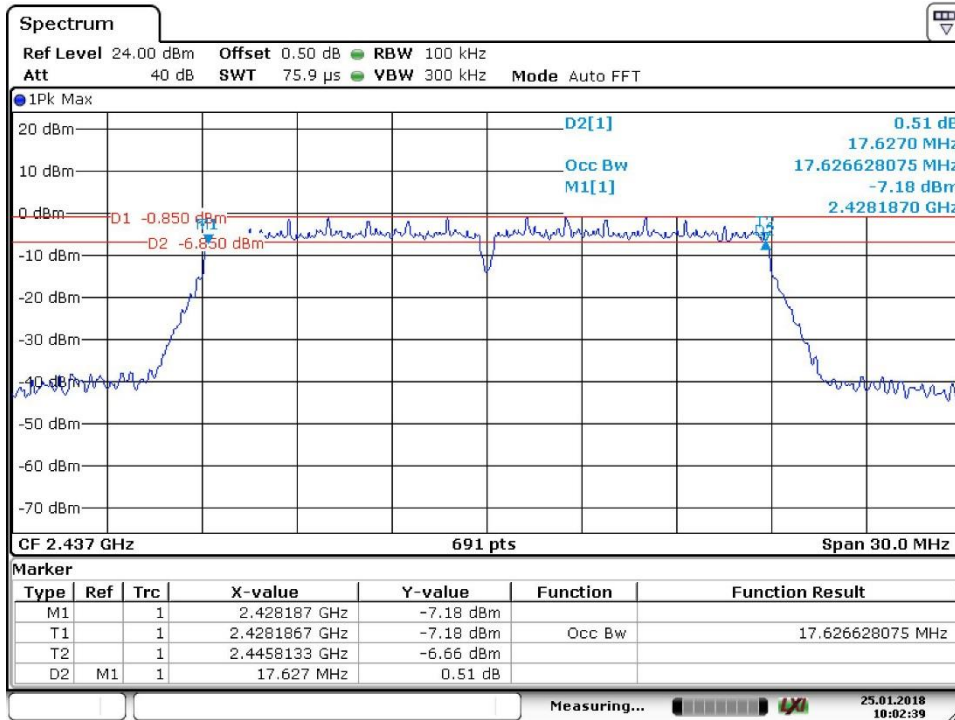

Date: 25.JAN.2018 10:02:39

2437MHz

**6dB bandwidth**

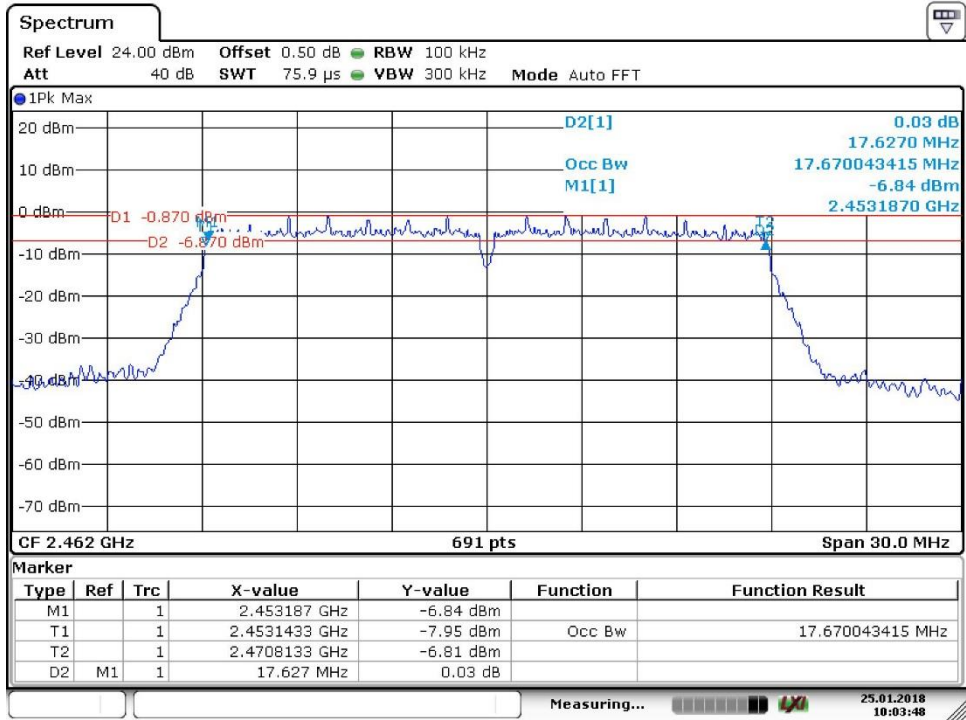

Date: 25.JAN.2018 10:03:48

2462MHz

## 9.4 Power spectral density

### Test Method

This procedure shall be used if maximum peak conducted output power was used to demonstrate compliance:

1. Set analyzer center frequency to DTS channel center frequency. RBW=3kHz, VBW $\geq$ 3RBW, Span=1.5 times DTS bandwidth, Detector=Peak, Sweep=auto, Trace= max hold.
2. Allow trace to fully stabilize, use the peak marker function to determine the maximum amplitude level within the RBW.
3. Repeat above procedures until other frequencies measured were completed.

### Limit

Limit [dBm]

$\leq 8$

Test result

802.11b

Frequency MHz	Power spectral density dBm	Result
Top channel 2412MHz	-11.53	Pass
Middle channel 2437MHz	-10.11	Pass
Bottom channel 2462MHz	-7.36	Pass

802.11g

Frequency MHz	Power spectral density dBm	Result
Top channel 2412MHz	-12.58	Pass
Middle channel 2437MHz	-13.13	Pass
Bottom channel 2462MHz	-12.31	Pass

802.11nHT20

Frequency MHz	Power spectral density dBm	Result
Top channel 2412MHz	-13.31	Pass
Middle channel 2437MHz	-13.71	Pass
Bottom channel 2462MHz	-11.49	Pass

## Power Spectral Density

802.11b

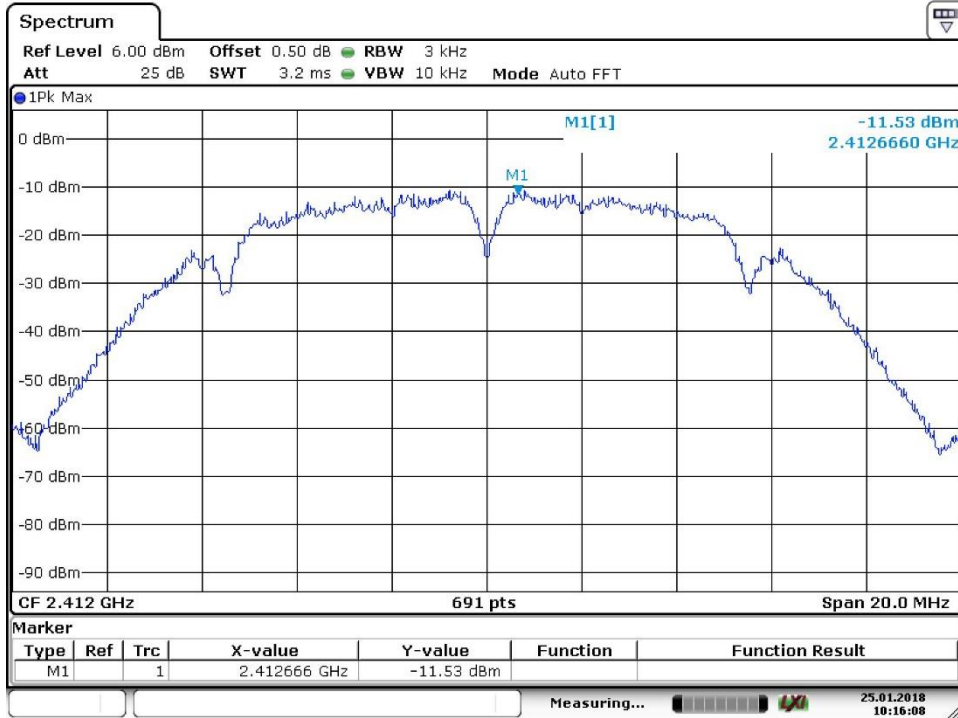

Date: 25.JAN.2018 10:16:08

2412MHz

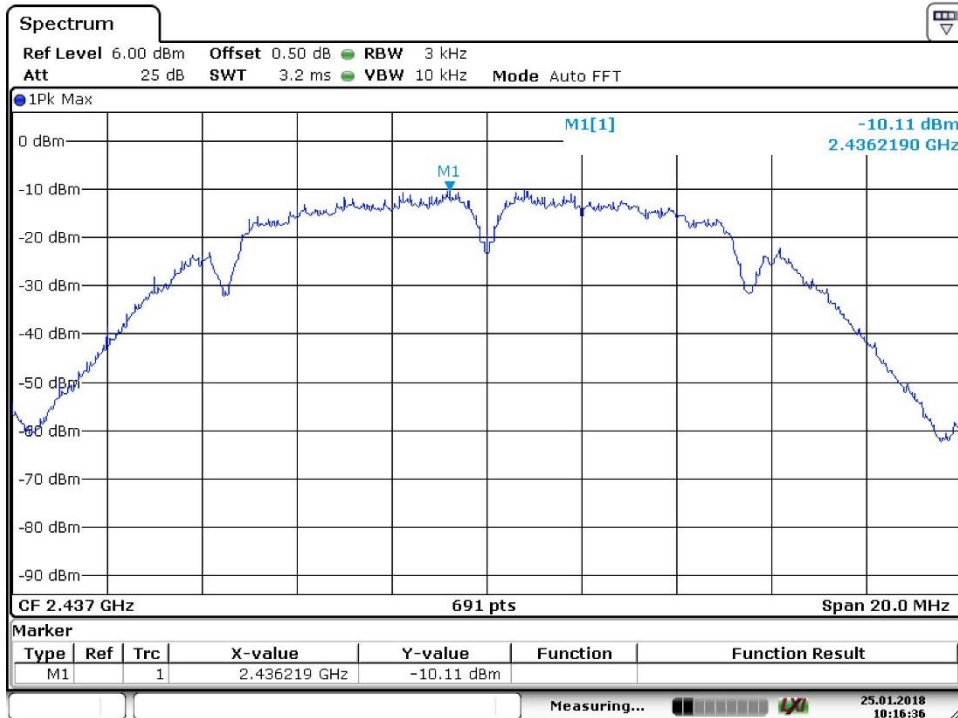

Date: 25.JAN.2018 10:16:36

2437MHz

### Power Spectral Density

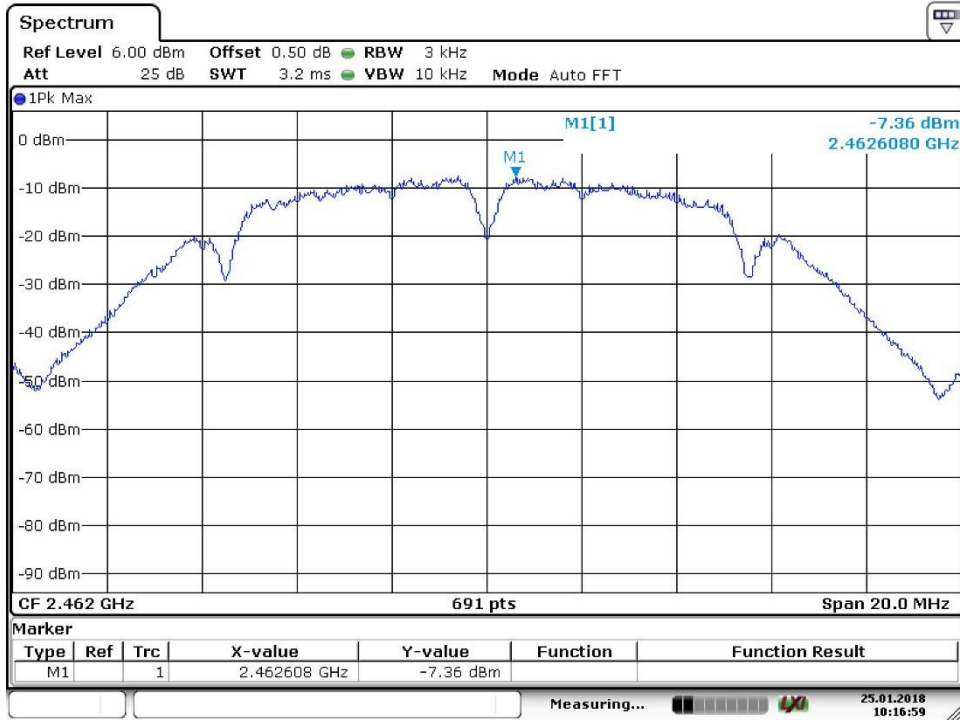

Date: 25 JAN.2018 10:16:59

2462MHz

802.11g

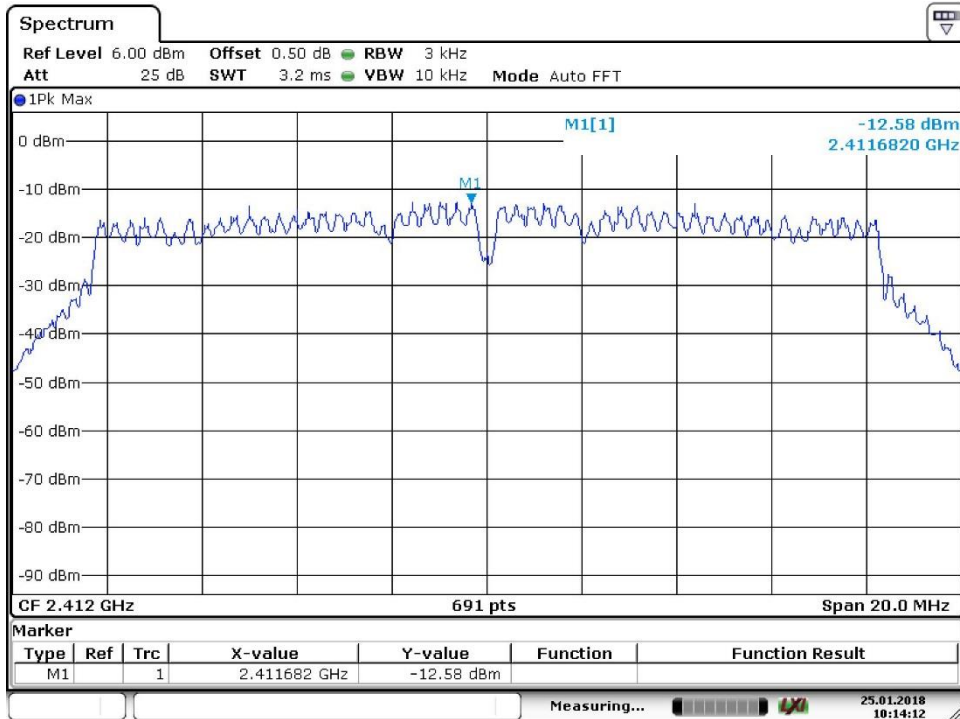

Date: 25 JAN.2018 10:14:12

2412MHz

## Power Spectral Density

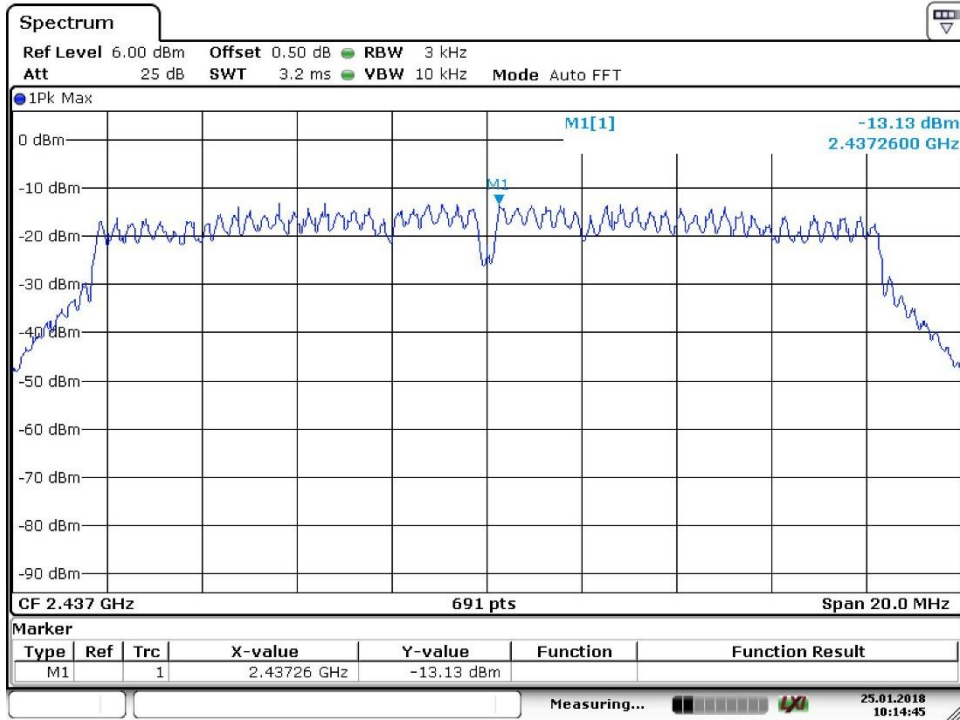

Date: 25. JAN. 2018 10:14:46

2437MHz

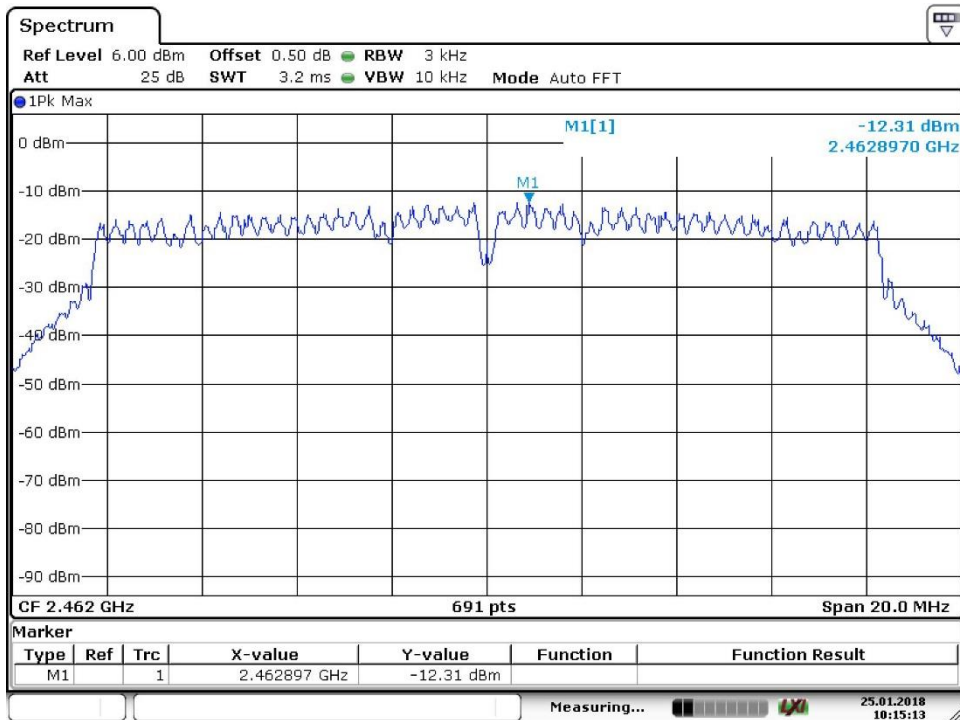

Date: 25. JAN. 2018 10:15:13

2462MHz

## Power Spectral Density

802.11nHT20

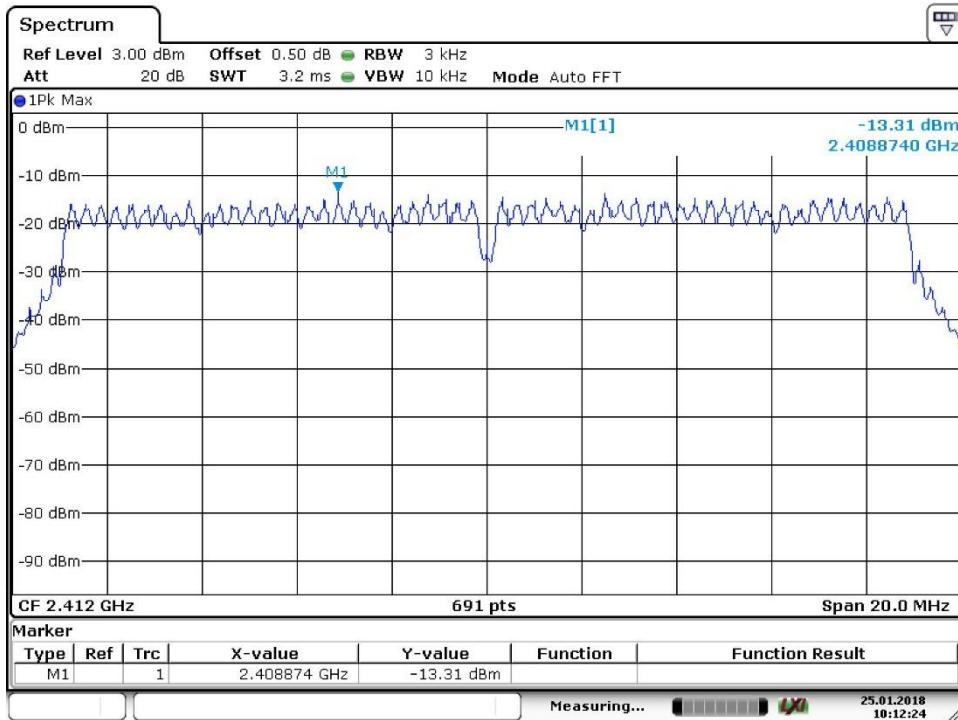

Date: 25.JAN.2018 10:12:24

2412MHz

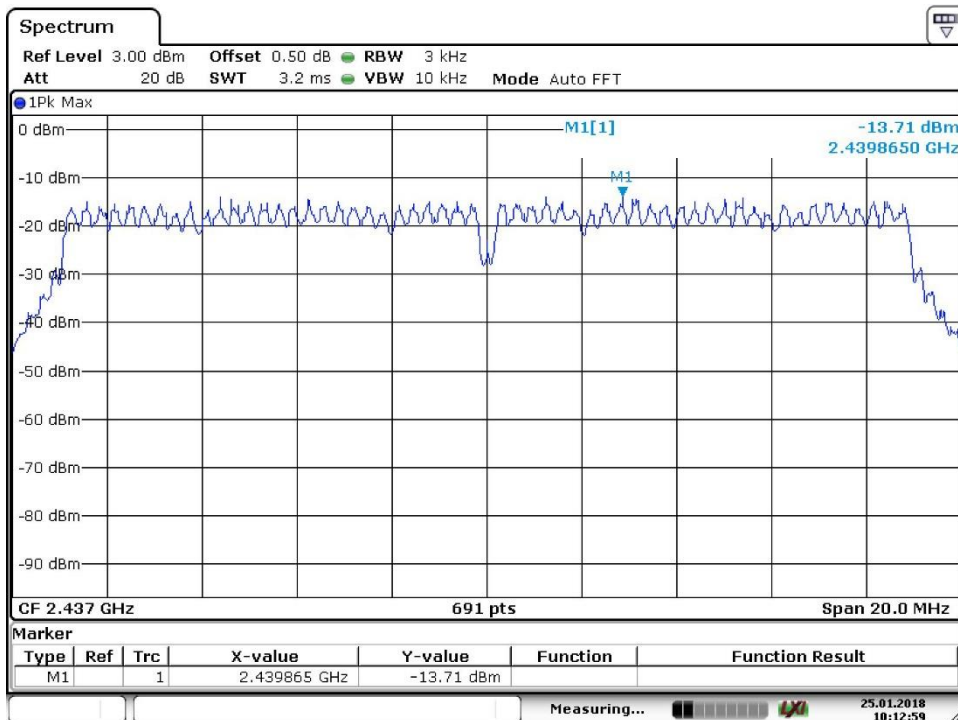

Date: 25.JAN.2018 10:12:59

2437MHz



## Power Spectral Density

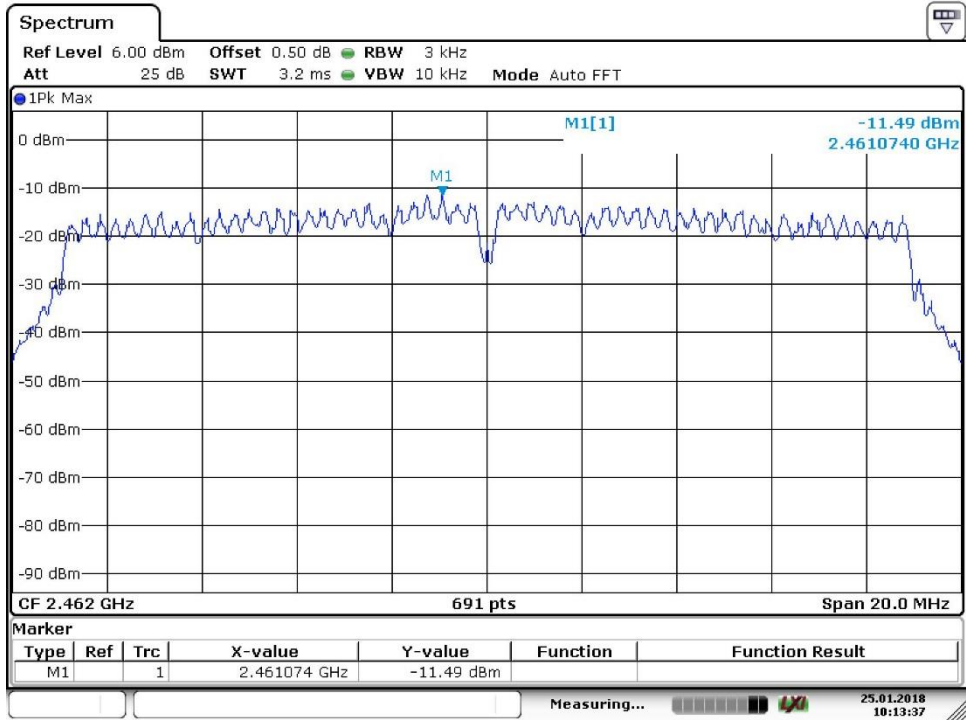

Date: 25 JAN.2018 10:13:37

2462MHz

## 9.5 Spurious RF conducted emissions

### Test Method

1. Establish a reference level by using the following procedure:
  - a. Set RBW=100 kHz. VBW $\geq$ 3RBW. Detector =peak, Sweep time = auto couple, Trace mode = max hold.
  - b. Allow trace to fully stabilize, use the peak marker function to determine the maximum PSD level.
2. Use the maximum PSD level to establish the reference level.
  - a. Set the center frequency and span to encompass frequency range to be measured.
  - b. Use the peak marker function to determine the maximum amplitude level. Ensure that the amplitude of all unwanted emissions outside of the authorized frequency band (excluding restricted frequency bands) are attenuated by at least the minimum requirements, report the three highest emissions relative to the limit.
3. Repeat above procedures until other frequencies measured were completed.

### Limit

Frequency Range MHz	Limit (dBc)
30-25000	-20

## Spurious RF conducted emissions

802.11b

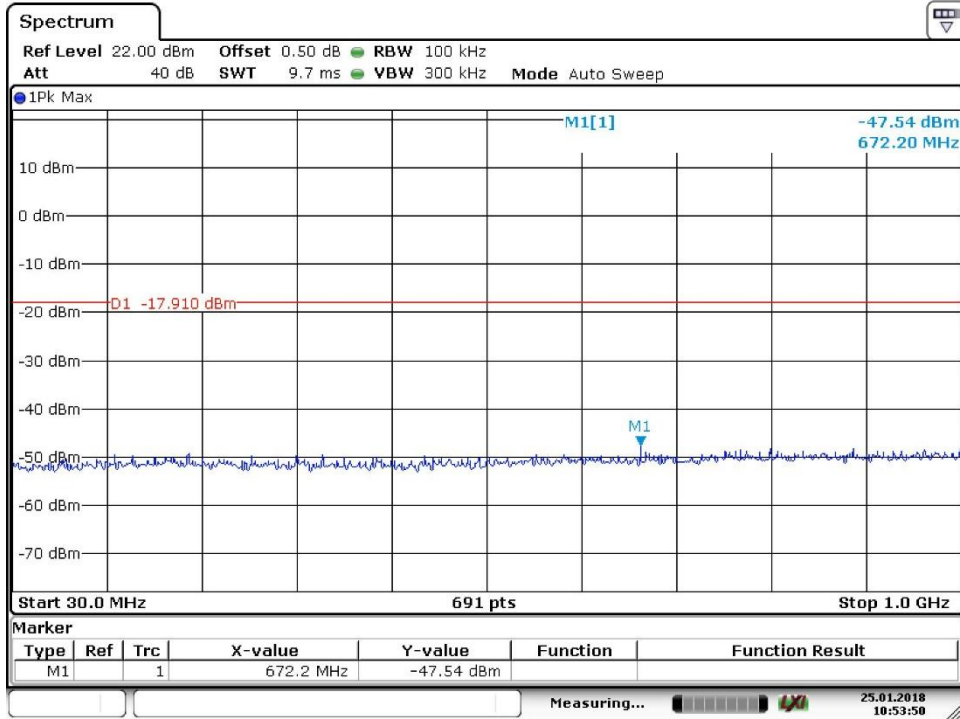

Date: 25.JAN.2018 10:53:50

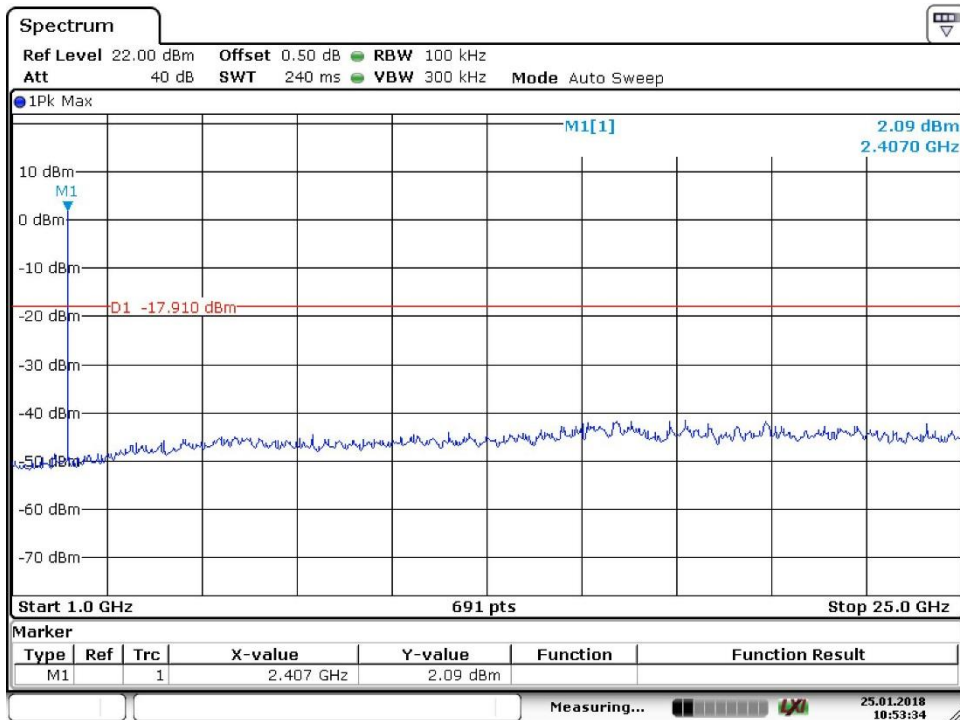

Date: 25.JAN.2018 10:53:33

2412MHz

## Spurious RF conducted emissions

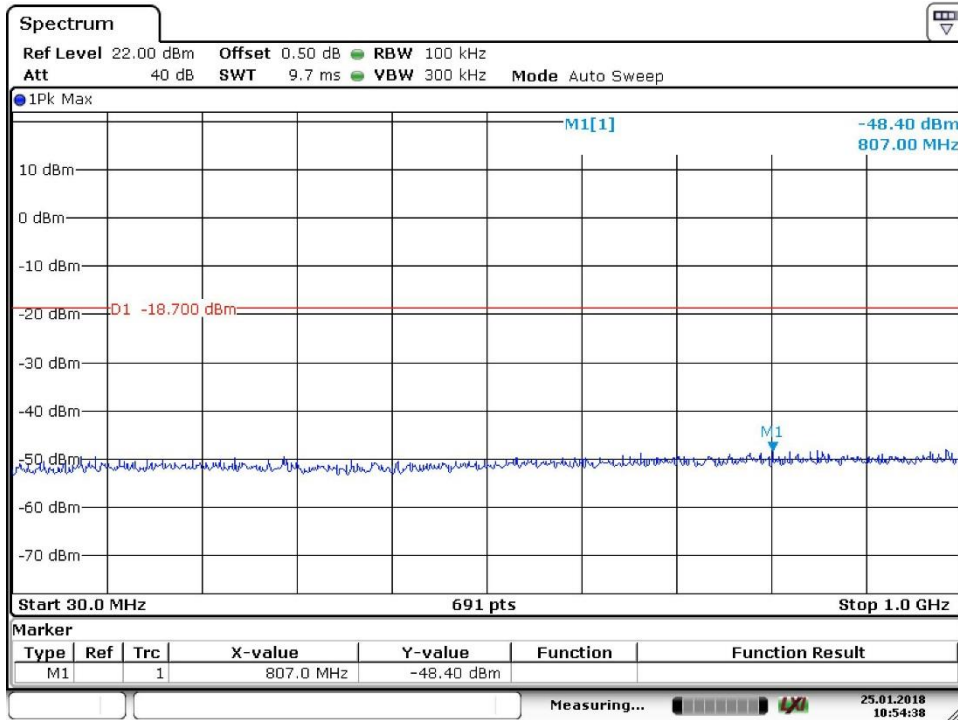

Date: 25.JAN.2018 10:54:39

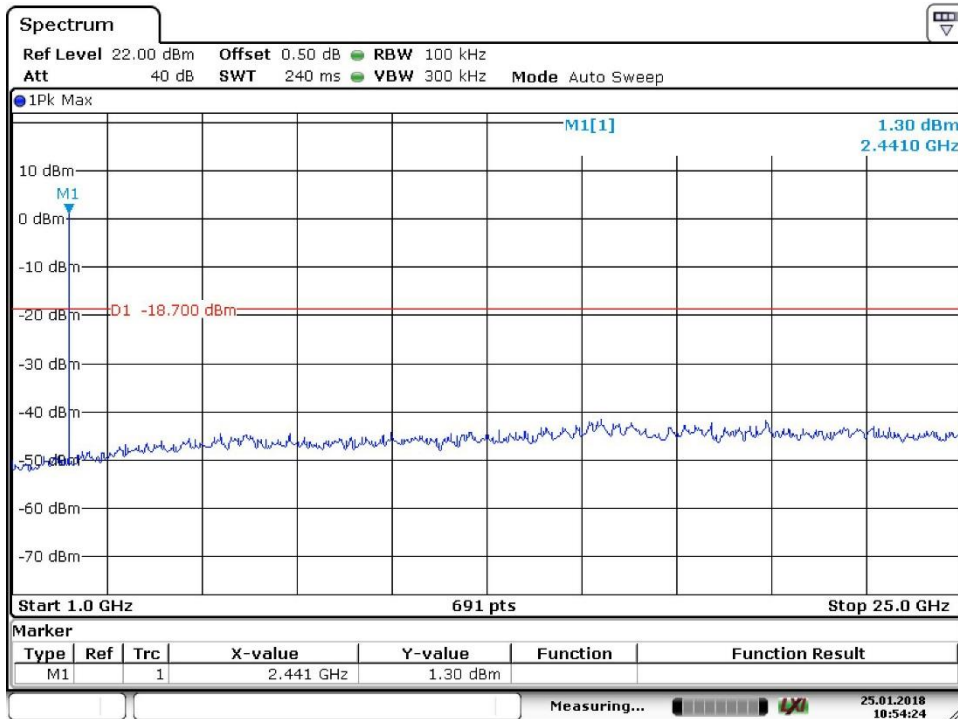

Date: 25.JAN.2018 10:54:25

2437MHz

## Spurious RF conducted emissions

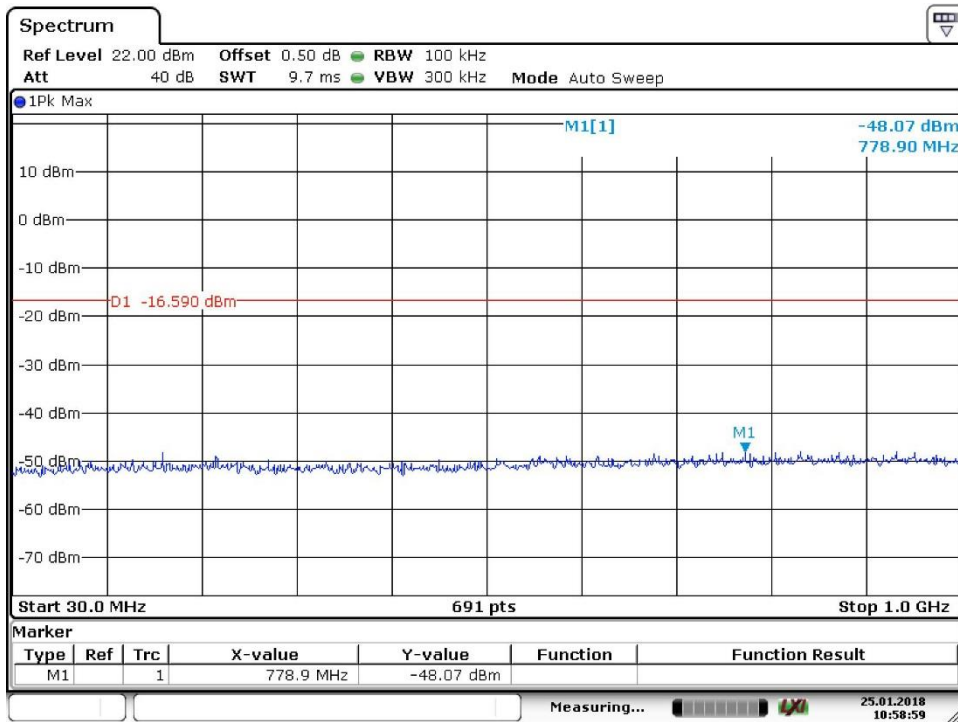

Date: 25.JAN.2018 10:58:59

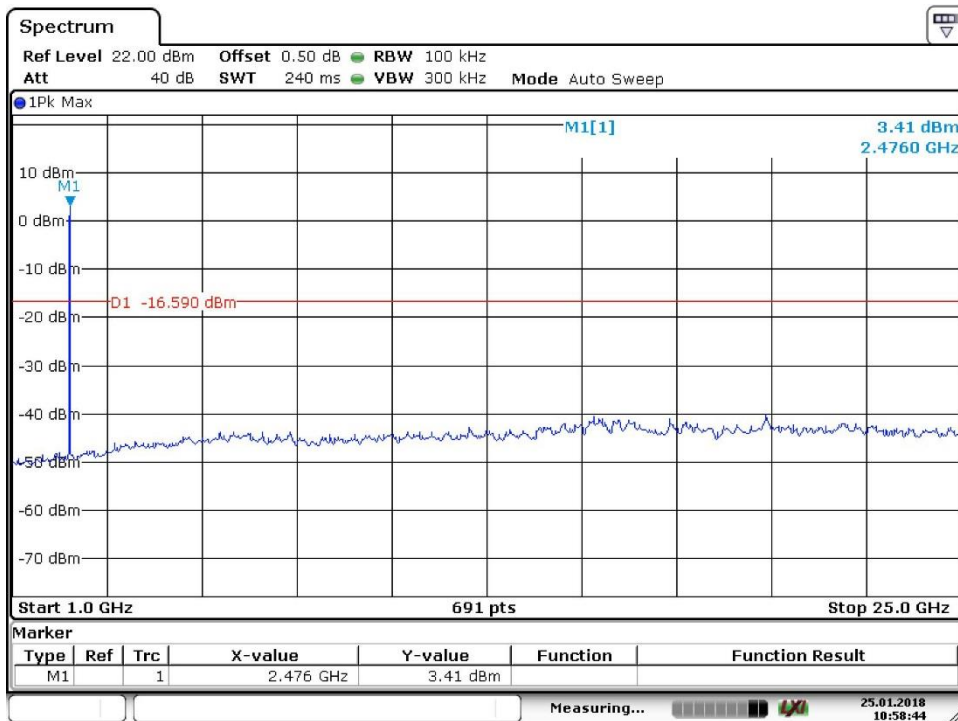

Date: 25.JAN.2018 10:58:44

2462MHz

## Spurious RF conducted emissions

802.11g

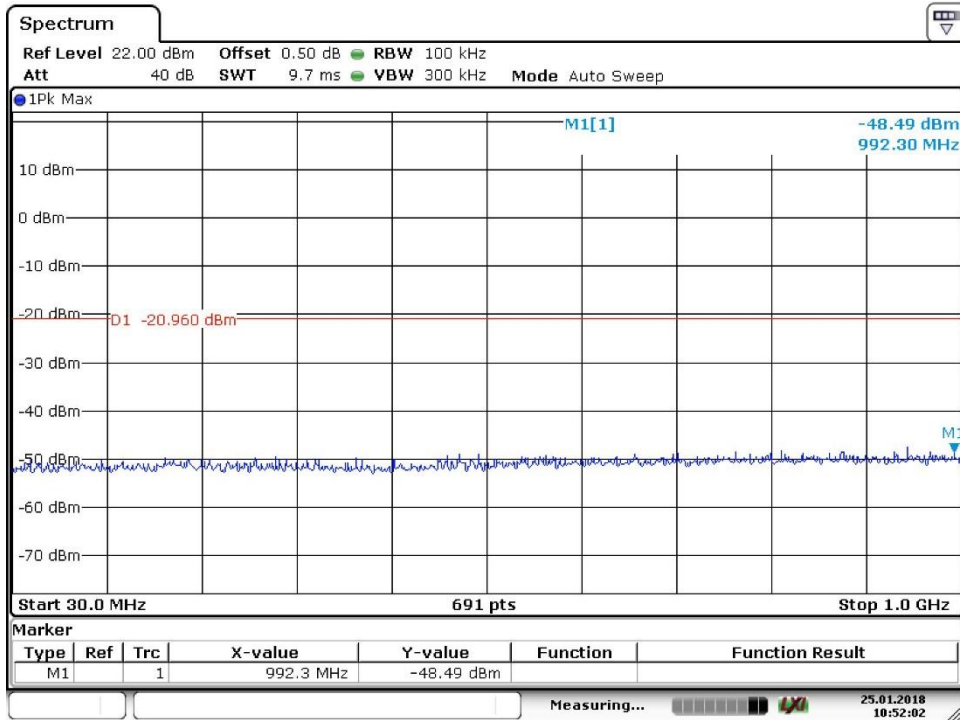

Date: 25.JAN.2018 10:52:03

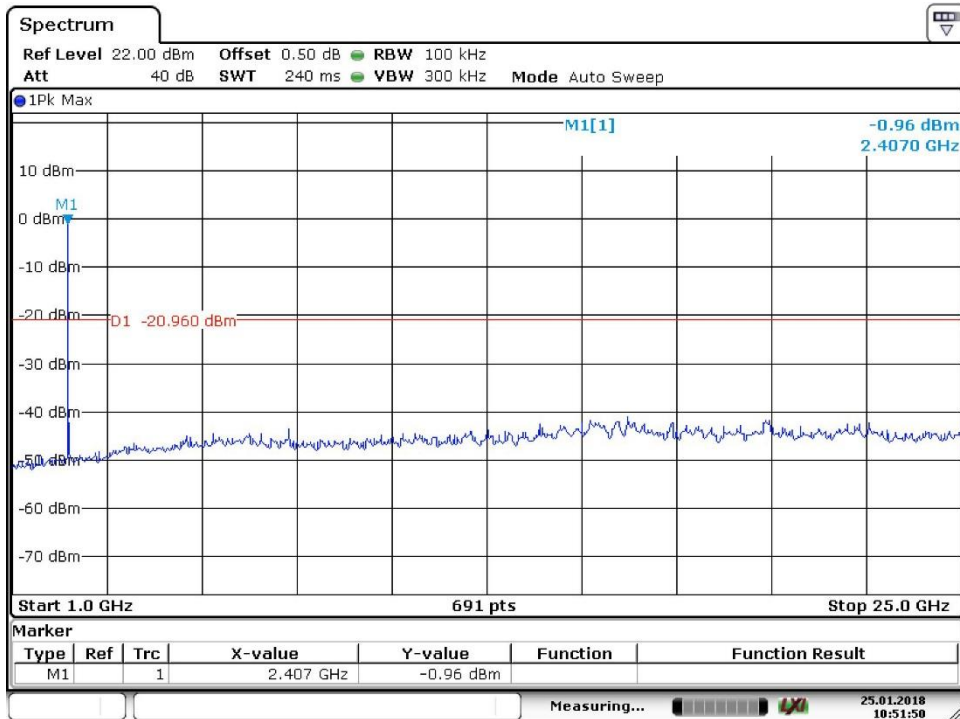

Date: 25.JAN.2018 10:51:50

2412MHz

## Spurious RF conducted emissions

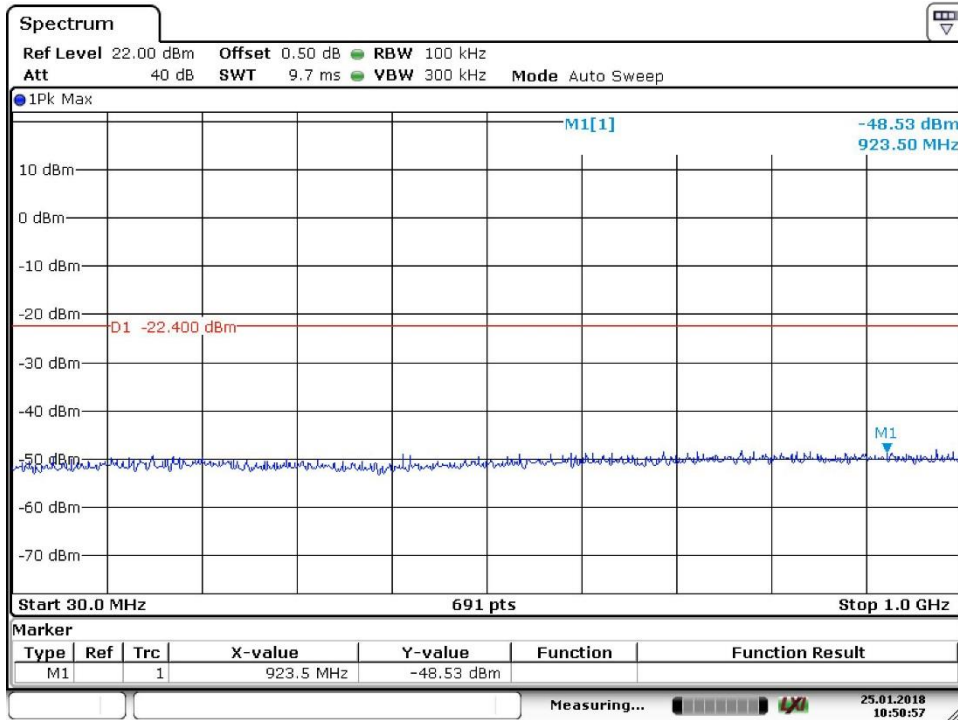

Date: 25.JAN.2018 10:50:58

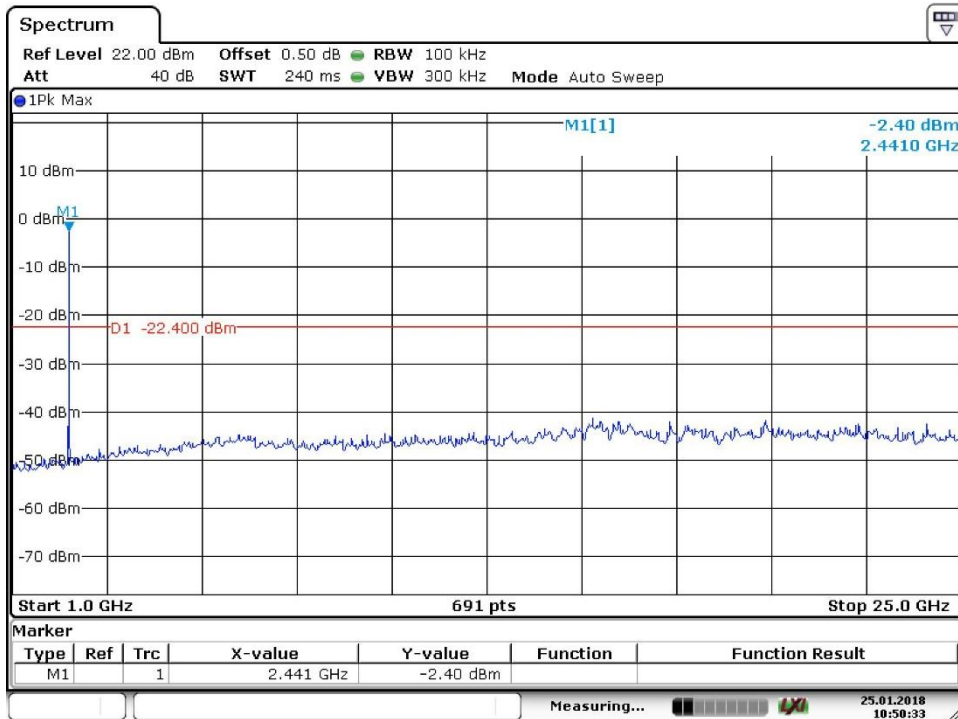

Date: 25.JAN.2018 10:50:33

2437MHz

## Spurious RF conducted emissions

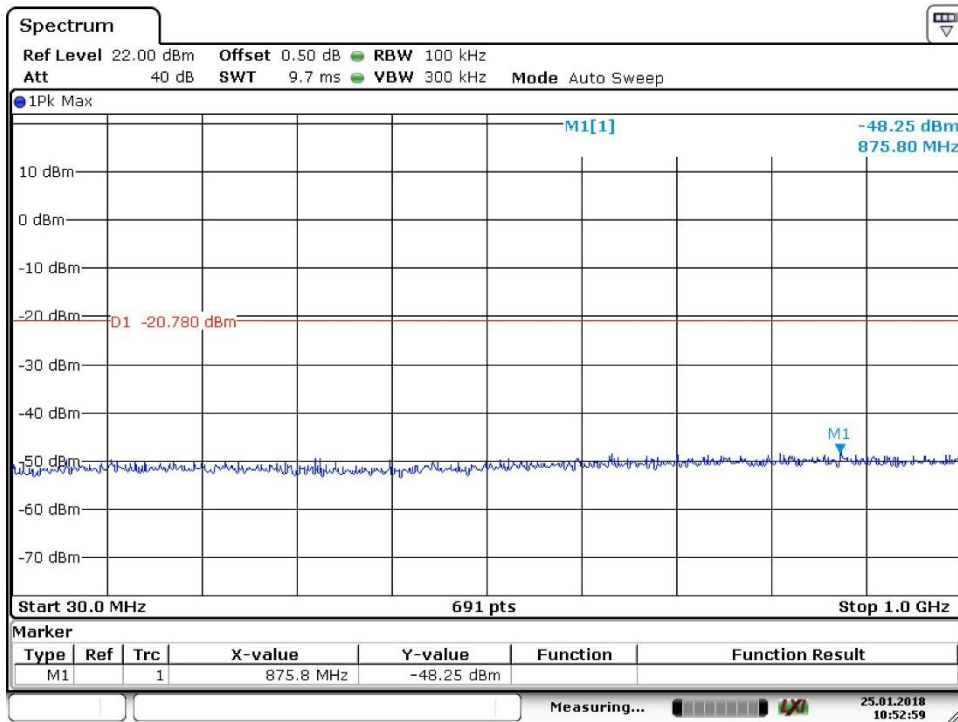

Date: 25.JAN.2018 10:52:59

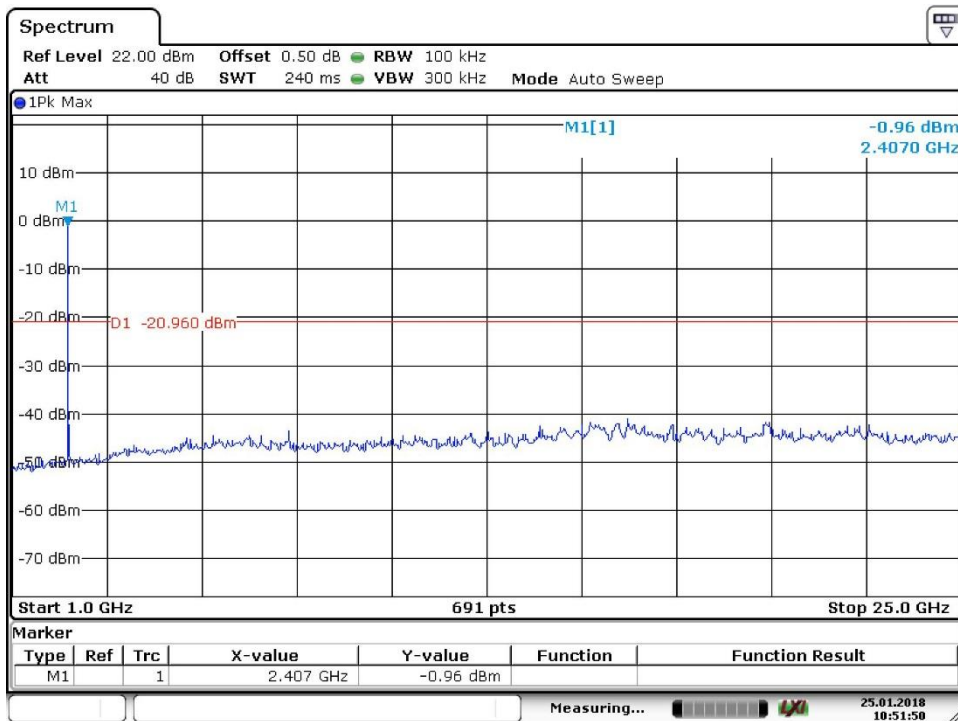

Date: 25.JAN.2018 10:51:50

2462MHz



## Spurious RF conducted emissions

802.11nHT20

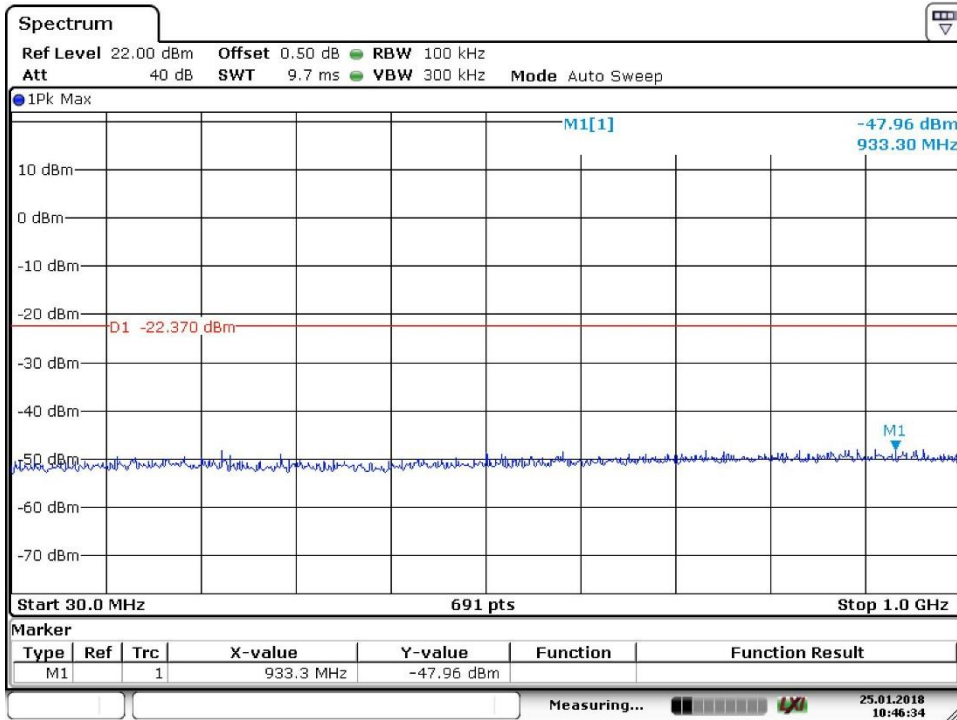

Date: 25.JAN.2018 10:46:34

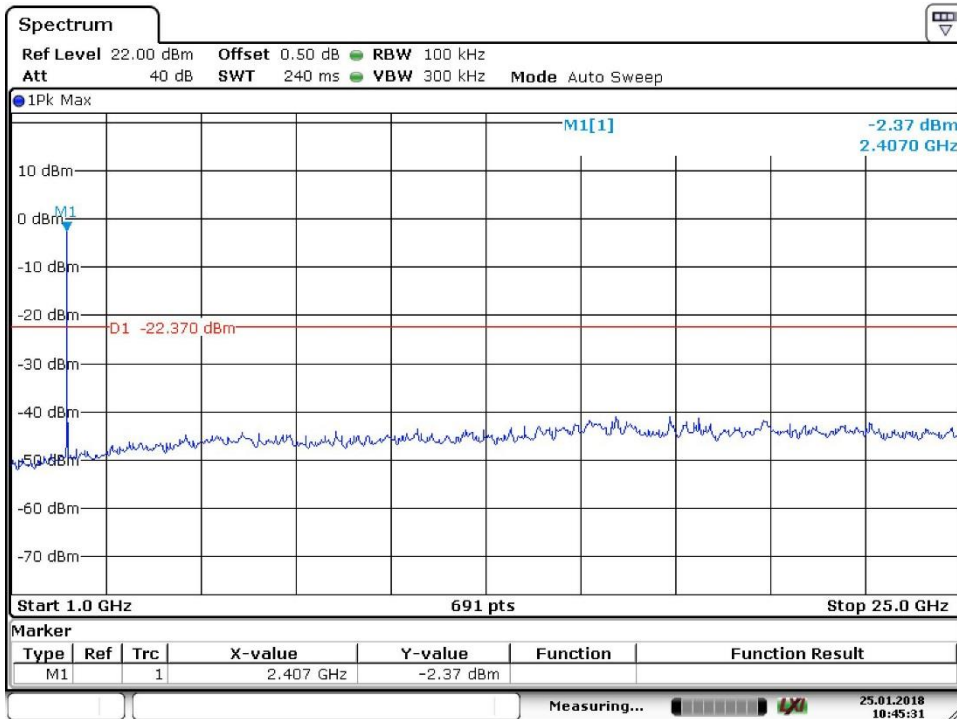

Date: 25.JAN.2018 10:45:31

2412MHz

## Spurious RF conducted emissions

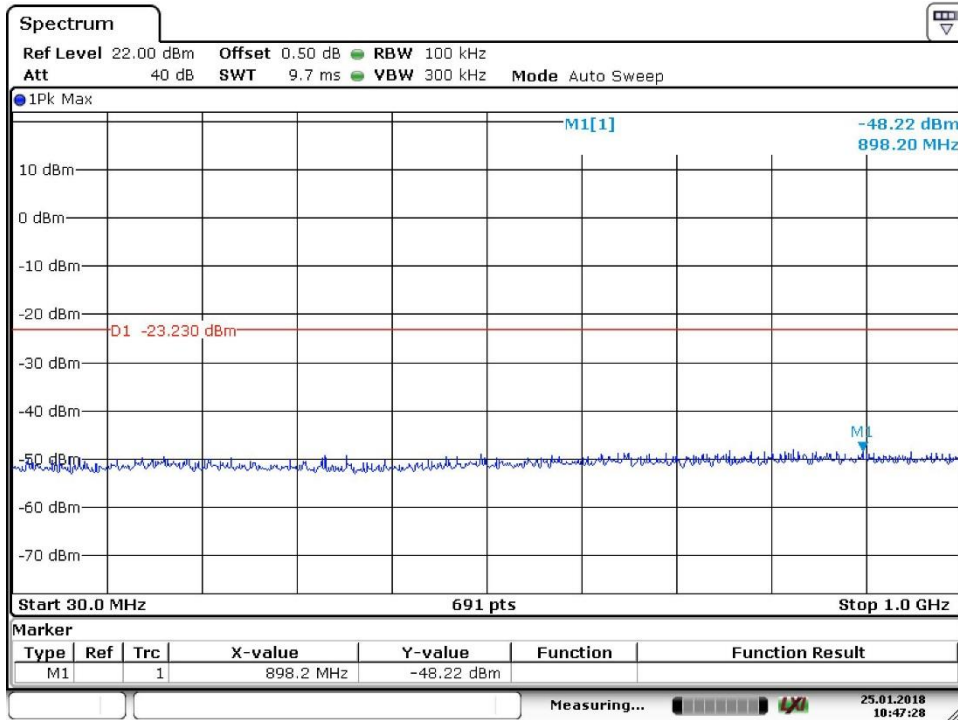

Date: 25.JAN.2018 10:47:29

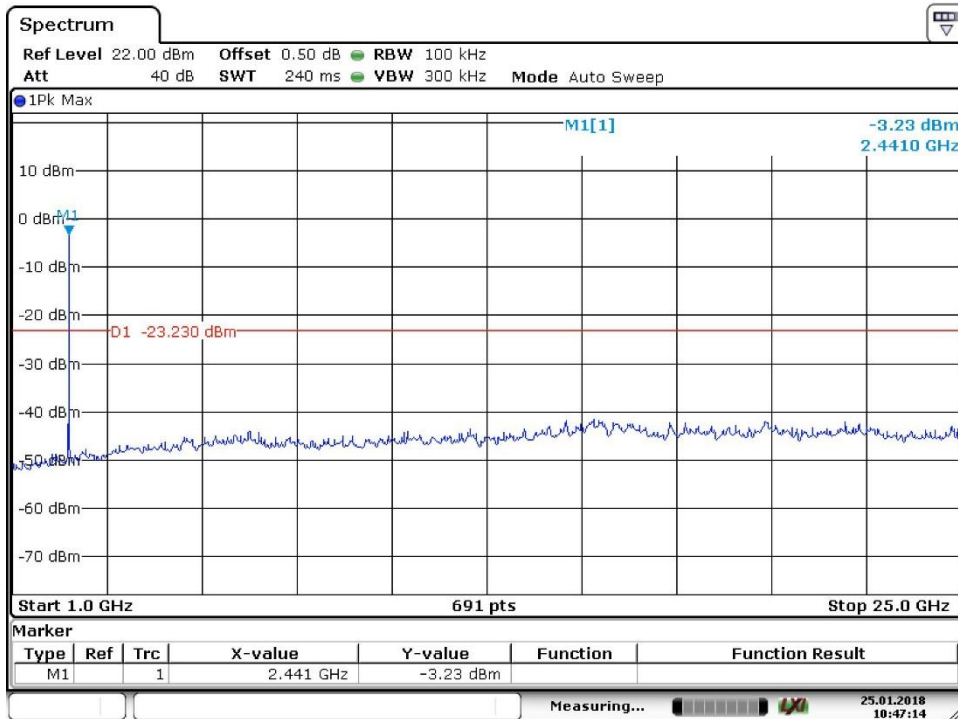

Date: 25.JAN.2018 10:47:15

2437MHz

## Spurious RF conducted emissions

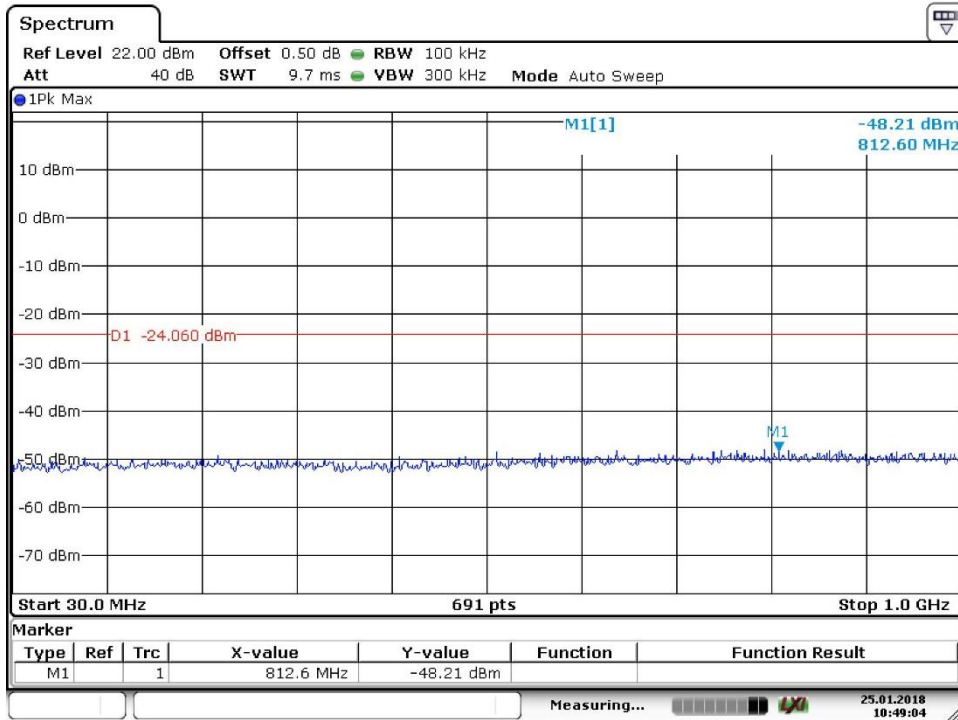

Date: 25.JAN.2018 10:49:04

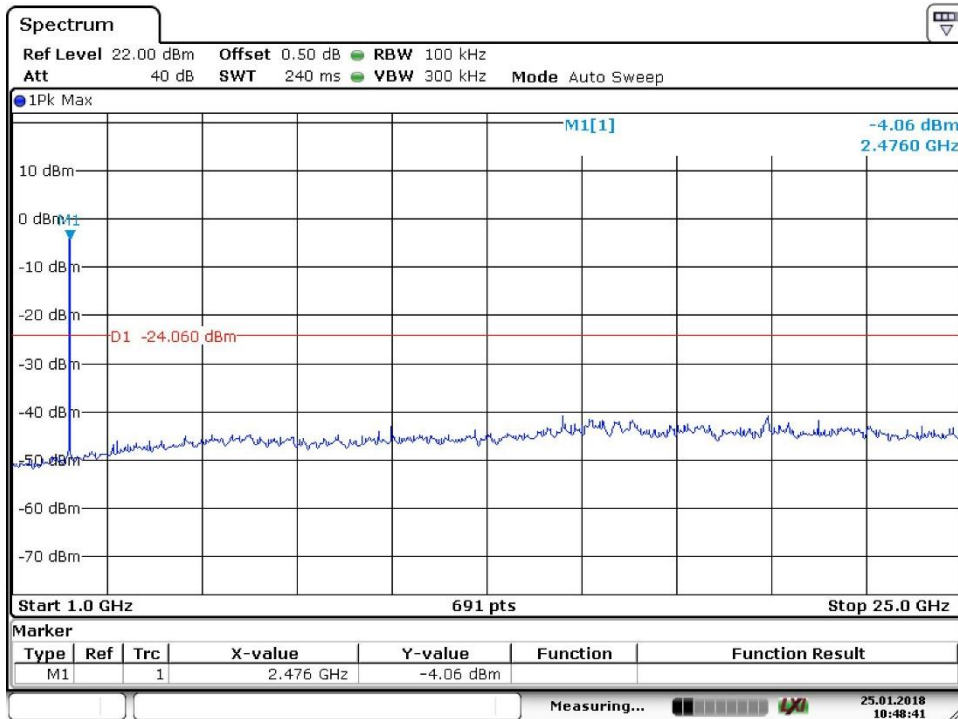

Date: 25.JAN.2018 10:48:42

2462MHz

## 9.6 Band edge

### Test Method

- 1 Use the following spectrum analyzer settings:  
Span = wide enough to capture the peak level of the in-band emission and all spurious  
RBW = 100 kHz, VBW ≥ RBW, Sweep = auto, Detector function = peak, Trace = max hold.
- 2 Allow the trace to stabilize, use the peak and delta measurement to record the result.
- 3 The level displayed must comply with the limit specified in this Section.

### Limit

Frequency Range MHz	Limit (dBc)
30-25000	-20

### Test result

802.11b

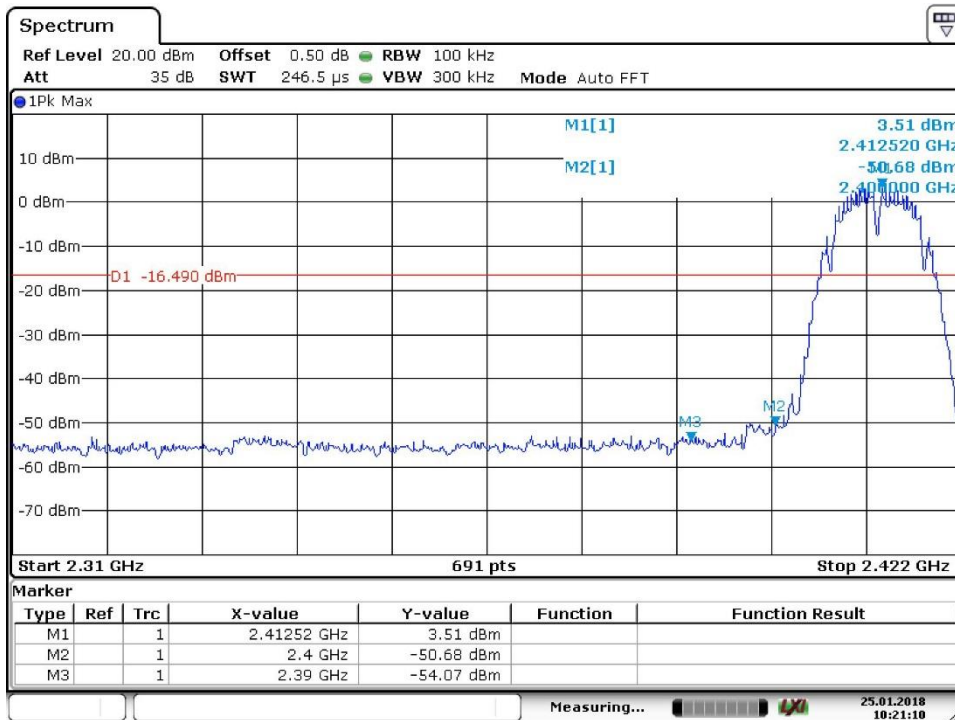

Date: 25 JAN.2018 10:21:10

2412MHz

**Band edge**

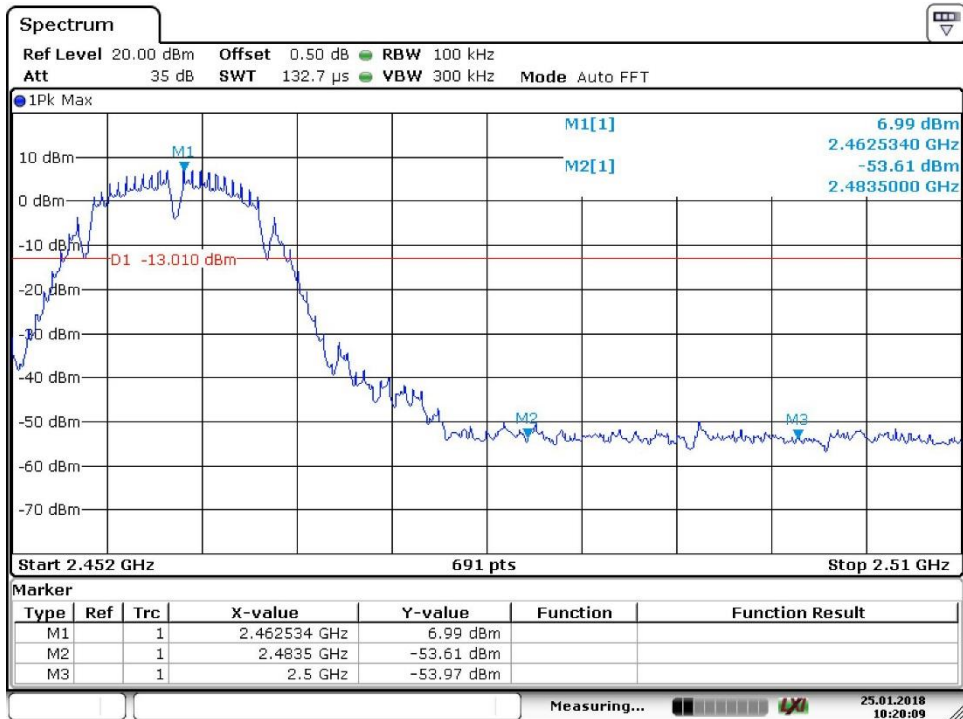

Date: 25.JAN.2018 10:20:09

2462MHz

802.11g

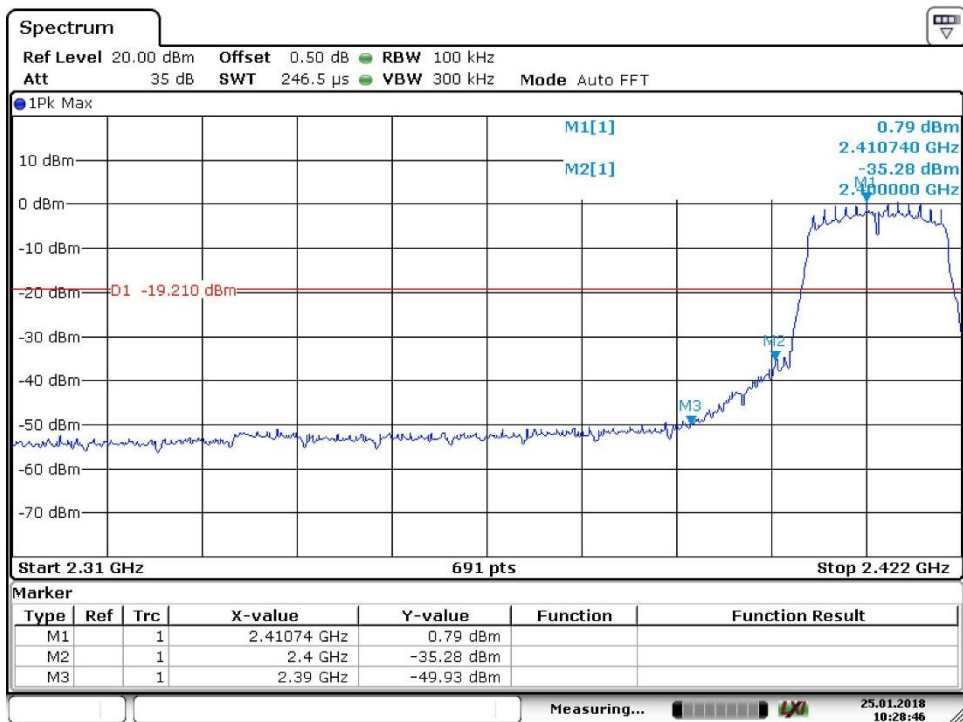

Date: 25.JAN.2018 10:28:46

2412MHz

**Band edge**

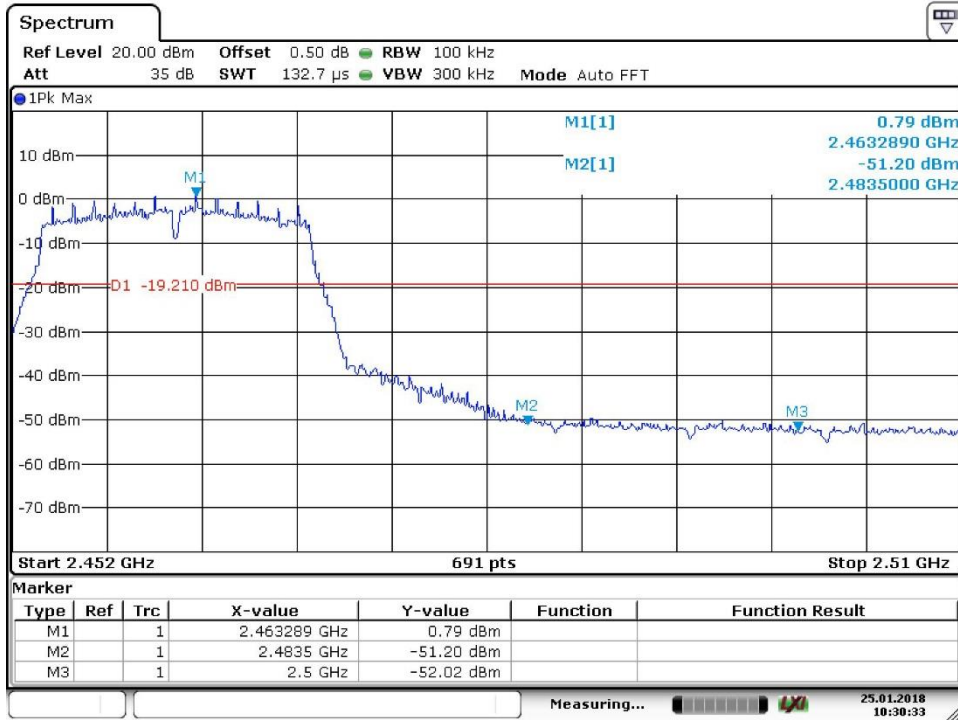

Date: 25.JAN.2018 10:30:34

2462MHz

802.11nHT20

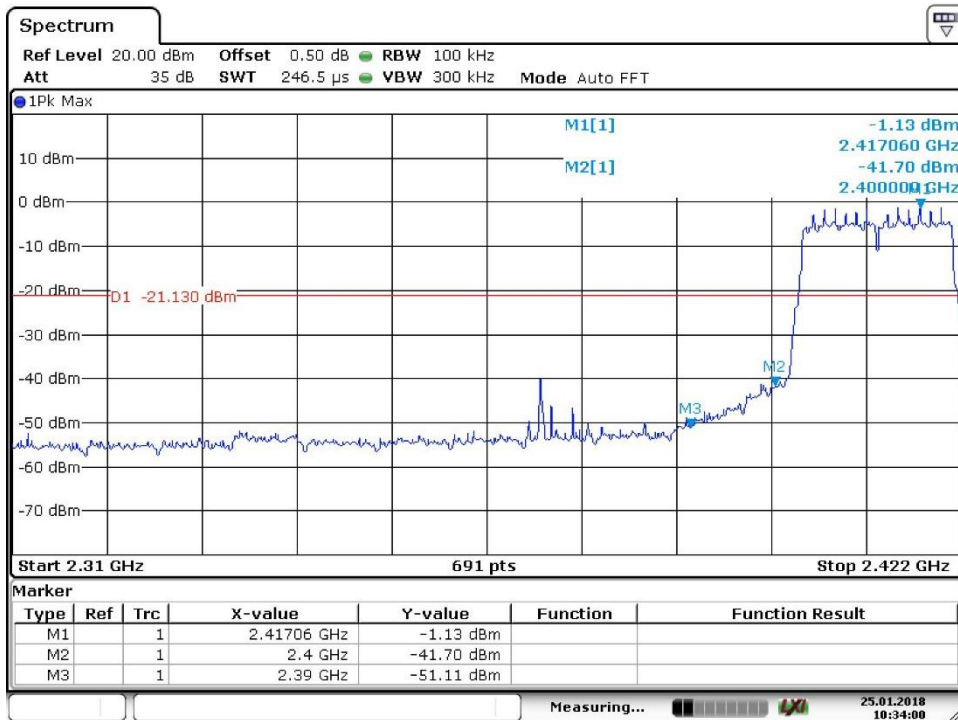

Date: 25.JAN.2018 10:34:01

2412MHz

**Band edge**

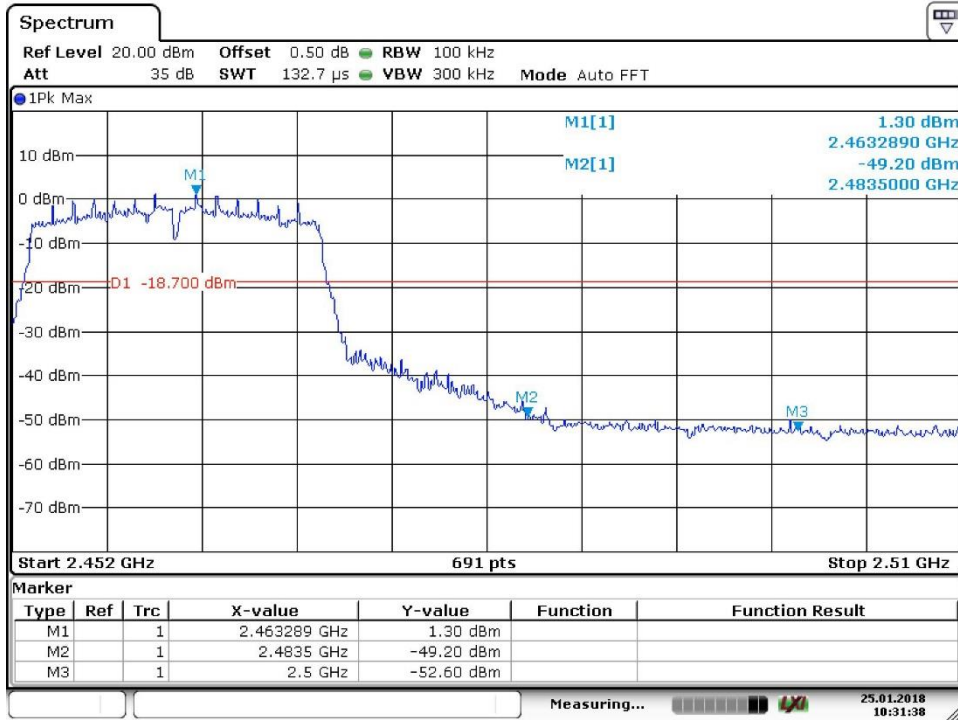

Date: 25 JAN 2018 10:31:38

2462MHz

## 9.7 Spurious radiated emissions for transmitter

### Test Method

- 1: The EUT was placed on a turn table which is 1.5m above ground plane for above 1GHz and 0.8m above ground for below 1GHz at 3meter chamber room for test. The table was rotated 360 degrees to determine the position of the highest radiation.
- 2: The EUT was set 3 meters away from the interference – receiving antenna, which was mounted on the top of a variable – height antenna tower.
- 3: The height of antenna is varied from one meter to four meters above the ground to determine the maximum value of the field strength. Both horizontal and vertical polarizations of the antenna are set to make the measurement.
- 4: For each suspected emission, the EUT was arranged to its worst case and then the antenna was tuned to heights from 1 meter to 4 meters and the rotatable table was turned from 0 degrees to 360 degrees to find the maximum reading.
- 5: Use the following spectrum analyzer settings According to C63.10:  
For Above 1GHz  
Span = wide enough to capture the peak level of the in-band emission and all spurious  
RBW = 1MHz, VBW  $\geq$  RBW for peak measurement and VBW = 10Hz for average measurement, Sweep = auto, Detector function = peak, Trace = max hold.

#### For Below 1GHz

Use the following spectrum analyzer settings:

Span = wide enough to capture the peak level of the in-band emission and all spurious  
RBW = 100 KHz, VBW  $\geq$  RBW for peak measurement, Sweep = auto, Detector function = peak, Trace = max hold.

### Note:

- 1: The resolution bandwidth and video bandwidth of test receiver/spectrum analyzer is 120 KHz for Quasi-peak detection (QP) at frequency below 1GHz.
- 2: The resolution bandwidth of test receiver/spectrum analyzer is 1MHz and the video bandwidth is 3MHz for peak detection (PK) at frequency above 1GHz.
- 3: The resolution bandwidth of test receiver/spectrum analyzer is 1MHz and the video bandwidth is 3MHz for RMS Average ((duty cycle < 98%) for Average detection (AV) at frequency above 1GHz, then the measurement results was added to a correction factor ( $20\log(1/\text{duty cycle})$ ).
- 4: The resolution bandwidth of test receiver/spectrum analyzer is 1MHz and the video bandwidth is 10Hz (duty cycle > 98%) for Average detection (AV) at frequency above 1GHz.



## Limit

The radio emission outside the operating frequency band shall be at least 20 dB below that in the 100 kHz bandwidth within the band that contains the highest level of the desired power. Radiated emissions which fall in the restricted bands, as defined in section 15.205, must comply with the radiated emission limits specified in section 15.209.

Frequency MHz	Field Strength uV/m	Field Strength dB $\mu$ V/m	Detector
30-88	100	40	QP
88-216	150	43.5	QP
216-960	200	46	QP
960-1000	500	54	QP
Above 1000	500	54	AV
Above 1000	5000	74	PK



**Spurious radiated emissions for transmitter**

According to C63.10, if the peak (or quasi-peak) measured value complies with the average limit, it is unnecessary to perform an average measurement, so AV emission value did not show in below table if the peak value complies with average limit.

**Transmitting spurious emission test result as below:**

802.11b

2412MHz (30MHz – 1GHz)

Frequency MHz	Emission Level dBuV/m	Polarization	Limit dBµV/m	Margin dB	Detector	Corr. dB	Result
30.32	36.12	Horizontal	40.00	3.88	QP	-26.5	Pass
31.50	28.22	Vertical	40.00	11.78	QP	-25.5	Pass

2412MHz (Above 1GHz)

Frequency MHz	Emission Level dBuV/m	Polarization	Limit dBµV/m	Margin dB	Detector	Corr. dB/m	Result
4823.90 *	39.46	Horizontal	74.00	34.54	PK	2.6	Pass
4848.75 *	42.02	Vertical	74.00	37.42	PK	2.7	Pass

Remark:

- (1) Data of measurement within this frequency range shown “-” in the table above means the reading of emissions are attenuated more than 20db below the permissible limits or the field strength is too small to be measured.
- (2) “\*” means the emission(s) appear within the restrict bands shall follow the requirement of section 15.205.

### Spurious radiated emissions for transmitter

#### 2437MHz (30MHz – 1GHz)

Frequency MHz	Emission Level dBuV/m	Polarization	Limit dBuV/m	Margin dB	Detector	Corr. dB	Result
--	--	Horizontal	--	--	QP	--	--
--	--	Vertical	--	--	QP	--	--

#### 2437MHz (Above 1GHz)

Frequency MHz	Emission Level dBuV/m	Polarization	Limit dBuV/m	Margin dB	Detector	Corr. dB/m	Result
4874.06 *	41.09	Horizontal	74.00	32.91	PK	2.6	Pass
4874.06 *	37.70	Vertical	74.00	36.30	PK	2.7	Pass

Remark:

- (1) Data of measurement within this frequency range shown "--" in the table above means the reading of emissions are attenuated more than 20db below the permissible limits or the field strength is too small to be measured.
- (2) "\*" means the emission(s) appear within the restrict bands shall follow the requirement of section 15.205.

#### 2462MHz (30MHz – 1GHz)

Frequency MHz	Emission Level dBuV/m	Polarization	Limit dBuV/m	Margin dB	Detector	Corr. dB	Result
--	--	Horizontal	--	--	QP	--	--
--	--	Vertical	--	--	QP	--	--

#### 2462MHz (Above 1GHz)

Frequency MHz	Emission Level dBuV/m	Polarization	Limit dBuV/m	Margin dB	Detector	Corr. dB/m	Result
7023.28	38.54	Horizontal	74.00	35.46	PK	5.8	Pass
7890.46	37.83	Vertical	74.00	36.17	PK	7.0	Pass

Remark:

- (1) Data of measurement within this frequency range shown "--" in the table above means the reading of emissions are attenuated more than 20db below the permissible limits or the field strength is too small to be measured.
- (2) "\*" means the emission(s) appear within the restrict bands shall follow the requirement of section 15.205.

### Spurious radiated emissions for transmitter

802.11g

2412MHz (30MHz – 1GHz)

Frequency MHz	Emission Level dBuV/m	Polarization	Limit dB $\mu$ V/m	Margin dB	Detector	Corr. dB	Result
--	--	Horizontal	--	--	QP	--	--
--	--	Vertical	--	--	QP	--	--

2412MHz (Above 1GHz)

Frequency MHz	Emission Level dBuV/m	Polarization	Limit dB $\mu$ V/m	Margin dB	Detector	Corr. dB/m	Result
7477.50 *	39.54	Horizontal	74.00	34.46	PK	6.6	Pass
8770.78	40.54	Vertical	74.00	33.46	PK	9.0	Pass

Remark:

- (3) Data of measurement within this frequency range shown “-” in the table above means the reading of emissions are attenuated more than 20db below the permissible limits or the field strength is too small to be measured.
- (4) “\*” means the emission(s) appear within the restrict bands shall follow the requirement of section 15.205.

2437MHz (30MHz – 1GHz)

Frequency MHz	Emission Level dBuV/m	Polarization	Limit dB $\mu$ V/m	Margin dB	Detector	Corr. dB	Result
--	--	Horizontal	--	--	QP	--	--
--	--	Vertical	--	--	QP	--	--

2437MHz (Above 1GHz)

Frequency MHz	Emission Level dBuV/m	Polarization	Limit dB $\mu$ V/m	Margin dB	Detector	Corr. dB/m	Result
9400.78 *	41.09	Horizontal	74.00	37.74	PK	8.7	Pass
9380.62 *	41.39	Vertical	74.00	32.61	PK	8.9	Pass

Remark:

- (3) Data of measurement within this frequency range shown “-” in the table above means the reading of emissions are attenuated more than 20db below the permissible limits or the field strength is too small to be measured.
- (4) “\*” means the emission(s) appear within the restrict bands shall follow the requirement of section 15.205.

### Spurious radiated emissions for transmitter

#### 2462MHz (30MHz – 1GHz)

Frequency	Emission Level	Polarization	Limit	Margin	Detector	Corr.	Result
MHz	dBuV/m		dB $\mu$ V/m	dB		dB	
--	--	Horizontal	--	--	QP	--	--
--	--	Vertical	--	--	QP	--	--

#### 2462MHz (Above 1GHz)

Frequency	Emission Level	Polarization	Limit	Margin	Detector	Corr.	Result
MHz	dBuV/m		dB $\mu$ V/m	dB		dB/m	
7051.40	38.91	Horizontal	74.00	35.09	PK	6.0	Pass
5986.40	35.70	Vertical	74.00	38.30	PK	3.9	Pass

Remark:

- (3) Data of measurement within this frequency range shown “-” in the table above means the reading of emissions are attenuated more than 20db below the permissible limits or the field strength is too small to be measured.
- (4) “\*” means the emission(s) appear within the restrict bands shall follow the requirement of section 15.205.

#### 802.11nHT20

#### 2412MHz (30MHz – 1GHz)

Frequency	Emission Level	Polarization	Limit	Margin	Detector	Corr.	Result
MHz	dBuV/m		dB $\mu$ V/m	dB		dB	
--	--	Horizontal	--	--	QP	--	--
--	--	Vertical	--	--	QP	--	--

#### 2412MHz (Above 1GHz)

Frequency	Emission Level	Polarization	Limit	Margin	Detector	Corr.	Result
MHz	dBuV/m		dB $\mu$ V/m	dB		dB/m	
7021.40	38.18	Horizontal	74.00	41.79	PK	5.8	Pass
5638.12	36.00	Vertical	74.00	38.00	PK	3.3	Pass

Remark:

- (1) Data of measurement within this frequency range shown “-” in the table above means the reading of emissions are attenuated more than 20db below the permissible limits or the field strength is too small to be measured.
- (2) “\*” means the emission(s) appear within the restrict bands shall follow the requirement of section 15.205.

### Spurious radiated emissions for transmitter

#### 2437MHz (30MHz – 1GHz)

Frequency MHz	Emission Level dBuV/m	Polarization	Limit dBuV/m	Margin dB	Detector	Corr. dB	Result
--	--	Horizontal	--	--	QP	--	--
--	--	Vertical	--	--	QP	--	--

#### 2437MHz (Above 1GHz)

Frequency MHz	Emission Level dBuV/m	Polarization	Limit dBuV/m	Margin dB	Detector	Corr. dB/m	Result
8247.18 *	39.73	Horizontal	74.00	34.27	PK	7.8	Pass
7527.65 *	39.11	Vertical	74.00	34.89	PK	6.6	Pass

Remark:

- (1) Data of measurement within this frequency range shown "--" in the table above means the reading of emissions are attenuated more than 20db below the permissible limits or the field strength is too small to be measured.
- (2) "\*" means the emission(s) appear within the restrict bands shall follow the requirement of section 15.205.

#### 2462MHz (30MHz – 1GHz)

Frequency MHz	Emission Level dBuV/m	Polarization	Limit dBuV/m	Margin dB	Detector	Corr. dB	Result
--	--	Horizontal	--	--	QP	--	--
--	--	Vertical	--	--	QP	--	--

#### 2462MHz (Above 1GHz)

Frequency MHz	Emission Level dBuV/m	Polarization	Limit dBuV/m	Margin dB	Detector	Corr. dB/m	Result
8738.90	40.86	Horizontal	74.00	33.14	PK	8.7	Pass
8735.15	40.72	Vertical	74.00	33.28	PK	8.8	Pass

Remark:

- (1) Data of measurement within this frequency range shown "--" in the table above means the reading of emissions are attenuated more than 20db below the permissible limits or the field strength is too small to be measured.
- (2) "\*" means the emission(s) appear within the restrict bands shall follow the requirement of section 15.205.

## 10 Test Equipment List

### Radiated Emission Test

DESCRIPTION	MANUFACTURER	MODEL NO.	SERIAL NO.	CAL. DUE DATE
EMI Test Receiver	Rohde & Schwarz	ESR 26	101269	2018-7-14
Trilog Super Broadband Test Antenna	Schwarzbeck	VULB 9163	707	2018-7-14
Horn Antenna	Rohde & Schwarz	HF907	102294	2018-7-14
Pre-amplifier	Rohde & Schwarz	SCU 18	102230	2018-7-14
Signal Generator	Rohde & Schwarz	SMY01	839369/005	2018-7-7
Attenuator	Agilent	8491A	MY39264334	2018-7-7
3m Semi-anechoic chamber	TDK	9X6X6	----	2020-7-7
Test software	Rohde & Schwarz	EMC32	Version 9.15.00	N/A

### Conducted Emission Test

DESCRIPTION	MANUFACTURER	MODEL NO.	SERIAL NO.	CAL. DUE DATE
EMI Test Receiver	Rohde & Schwarz	ESR 3	101782	2018-7-14
LISN	Rohde & Schwarz	ENV4200	100249	2018-7-14
LISN	Rohde & Schwarz	ENV432	101318	2018-7-14
LISN	Rohde & Schwarz	ENV216	100326	2018-7-14
ISN	Rohde & Schwarz	ENY81	100177	2018-7-14
ISN	Rohde & Schwarz	ENY81-CA6	101664	2018-7-14
High Voltage Probe	Rohde & Schwarz	TK9420(VT9420)	9420-584	2018-7-14
RF Current Probe	Rohde & Schwarz	EZ-17	100816	2018-7-14
Attenuator	Shanghai Huaxiang	TS2-26-3	080928189	2018-7-7
Test software	Rohde & Schwarz	EMC32	Version9.15.00	N/A

#### C - Conducted RF tests

- Conducted peak output power
- 6dB bandwidth
- Power spectral density\*
- Spurious RF conducted emissions
- Band edge

## 11 System Measurement Uncertainty

For a 95% confidence level, the measurement expanded uncertainties for defined systems, in accordance with the recommendations of ISO 17025 were:

System Measurement Uncertainty	
Test Items	Extended Uncertainty
Uncertainty for Radiated Spurious Emission 25MHz-3000MHz	Horizontal: 4.98dB; Vertical: 5.06dB;
Uncertainty for Radiated Spurious Emission 3000MHz-18000MHz	Horizontal: 4.95dB; Vertical: 4.94dB;
Uncertainty for Radiated Spurious Emission 18000MHz-40000MHz	Horizontal: 5.14dB; Vertical: 5.12dB;
Uncertainty for Conducted RF test with TS 8997	Power level test involved: 2.06dB Frequency test involved: $1.16 \times 10^{-7}$