

FCC PART 15E TEST REPORT FOR CERTIFICATION  
On Behalf of

Icon Health and Fitness, Inc.

Tablet

Model Number: MP32-ARGON2-MIRROR

FCC ID: OMC422475

Prepared for:	Icon Health and Fitness, Inc.
	1500 South 1000 West, Logan Utah, United States 84321
Prepared By:	EST Technology Co., Ltd.
	Chilingxiang, Qishantou, Santun, Houjie, Dongguan, Guangdong, China
	Tel: 86-769-83081888-808



Report Number:	ESTE-R2010004
Date of Test:	Sep. 07~Oct. 30, 2020
Date of Report:	Nov. 03, 2020

## TABLE OF CONTENTS

Description	Page
TEST REPORT VERIFICATION.....	3
1. GENERAL INFORMATION.....	5
1.1. Description of Device (EUT).....	5
1.2. The antenna information for EUT.....	5
2. SUMMARY OF TEST.....	6
2.1. Summary of test result.....	6
2.2. Test Facilities.....	7
2.3. Measurement uncertainty for EST Technology Co., Ltd.....	8
2.4. Assistant equipment used for test.....	8
2.5. Block Diagram.....	8
2.6. Test Mode.....	9
2.7. Channel List.....	10
2.8. Power Setting of Test Software.....	11
2.9. Duty Cycle of Test Signal.....	12
2.10. Test Equipment List.....	15
3. 6DB BANDWIDTH & 26DB BANDWIDTH & 99% OCCUPIED BANDWIDTH.....	17
3.1. Limit.....	17
3.2. Test Setup.....	17
3.3. Spectrum Analyzer Setting.....	17
3.4. Test Procedure.....	18
3.5. Test Result.....	19
3.6. Test Result.....	21
4. MAXIMUM CONDUCTED OUTPUT POWER.....	33
4.1. Limit.....	33
4.2. Test Setup.....	33
4.3. Test Procedure.....	33
4.4. Test Result.....	34
5. PEAK POWER SPECTRAL DENSITY.....	35
5.1. Limit.....	35
5.2. Test Setup.....	35
5.3. Spectrum Analyzer Setting.....	35
5.4. Test Procedure.....	35
5.5. Test Result.....	35
6. UNWANTED EMISSIONS AND BAND EDGE.....	45
6.1. Limit.....	45
6.2. Test Setup.....	46
6.3. Spectrum Analyzer Setting.....	47
6.4. Test Procedure.....	48
6.5. Test Result.....	49
7. FREQUENCY STABILITY.....	87
7.1. Limit.....	87
7.2. Test Setup.....	87
7.3. Spectrum Analyzer Setting.....	87
7.4. Test Procedure.....	88

- 7.5. Test Result..... 89
- 8. AC POWER LINE CONDUCTED EMISSIONS .....93
  - 8.1. Limit..... 93
  - 8.2. Test Setup..... 93
  - 8.3. Spectrum Analyzer Setting..... 93
  - 8.4. Test Procedure..... 93
  - 8.5. Test Result..... 94
- 9. ANTENNA REQUIREMENTS .....98
  - 9.1. Limit..... 98
  - 9.2. Test Result..... 98
- 10. TEST SETUP PHOTO .....99

## EST Technology Co., Ltd.

<b>Applicant:</b>	Icon Health and Fitness, Inc.		
<b>Address:</b>	1500 South 1000 West, Logan Utah, United States 84321		
<b>Manufacturer:</b>	Icon Health and Fitness, Inc.		
<b>Address:</b>	1500 South 1000 West, Logan Utah, United States 84321		
<b>E.U.T:</b>	Tablet		
<b>Model Number:</b>	MP32-ARGON2-MIRROR		
<b>Power Supply:</b>	DC 24V From Adapter Input AC 100-240V, 50/60Hz		
<b>Trade Name:</b>	-----	<b>Serial No.:</b>	-----
<b>Date of Receipt:</b>	Sep. 07, 2020	<b>Date of Test:</b>	Sep. 07~Oct. 30, 2020
<b>Test Specification:</b>	FCC Part 15 Subpart E 15.407 ANSI C63.10:2013 FCC KDB 789033 D02 General UNII Test Procedures New Rules v02r01 FCC KDB 662911 D01 Multiple Transmitter Output v02r01		
<b>Test Result:</b>	The device described above is tested by EST Technology Co., Ltd. The measurement results were contained in this test report and EST Technology Co., Ltd. was assumed full responsibility for the accuracy and completeness of these measurements. Also, this report shows that the EUT to be technically compliance with the FCC Rules and Regulations Part 15 Subpart E requirements.  This report applies to above tested sample only and shall not be reproduced in part without written approval of EST Technology Co., Ltd. <p style="text-align: right;">Date: Nov. 03, 2020</p>		
<b>Prepared by:</b>	<b>Reviewed by:</b>	<b>Approved by:</b>	
			
Ring Yang / Assistant	Seven Wang / Engineer	Iceman Hu / Manager	
<b>Other Aspects:</b>			
None.			
Abbreviations: OK/P=passed    fail/F=failed    n.a/N=not applicable    E.U.T=equipment under tested			
This test report is based on a single evaluation of one sample of above mentioned products ,It is not permitted to be duplicated in extracts without written approval of EST Technology Co., Ltd.			

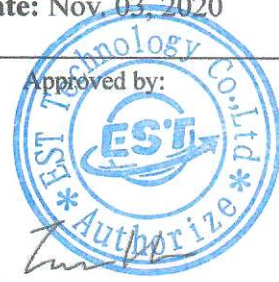

## 1. GENERAL INFORMATION

### 1.1. Description of Device (EUT)

FCC ID	:	OMC422475
Product Name	:	Tablet
Model Number	:	MP32-ARGON2-MIRROR
Software Version	:	MKA2M
Hardware Version	:	A594C
Operation frequency	:	U-NII-1: 5150 MHz~5250 MHz U-NII-2A: 5250 MHz~5350 MHz U-NII-2C: 5470MHz~5600MHz & 5650MHz~5725MHz U-NII-3: 5725 MHz~5850 MHz
Number of channel	:	U-NII-1: IEEE 802.11a / n HT20 : 4 Channels; IEEE 802.11n HT40: 2 Channels; U-NII-2A: IEEE 802.11a / n HT20 : 4 Channels; IEEE 802.11n HT40 : 2 Channels; U-NII-2C: IEEE 802.11a / n HT20: 8 Channels; IEEE 802.11n HT40: 3 Channels; U-NII-3: IEEE 802.11a / n HT20 : 5 Channels; IEEE 802.11n HT40 : 2 Channels;
Modulation	:	OFDM(QPSK, BPSK, 16-QAM, 64-QAM)
Transmit Data Rate	:	IEEE 802.11a: 54, 48, 36, 24, 18, 12, 9, 6Mbps; IEEE 802.11n: up 150Mbps;
Channels Spacing	:	IEEE 802.11a: 20MHz; IEEE 802.11n HT20: 20MHz; IEEE 802.11n HT40:40MHz;
Transmit Power	:	IEEE 802.11a: 12.79dBm IEEE 802.11n HT20: 13.32dBm IEEE 802.11n HT40: 12.75dBm
Sample Type	:	Prototype production

**Note:**

For a more detailed features description, please refer to the manufacturer's specifications or the user's manual.

### 1.2. The antenna information for EUT

Ant No.	Brand	Model Name	Antenna Type	Connector	Gain (dBi)
1	N/A	N/A	Internal	N/A	2.9

## 2. SUMMARY OF TEST

### 2.1. Summary of test result

Report Section	Description of Test Item	FCC Standard Section	Results
3	6dB Bandwidth & 26dB Bandwidth & 99% Occupied Bandwidth	15.407(a) 15.407(e)	PASS
4	Maximum Conducted Output Power	15.407(a)	PASS
5	Peak Power Spectral Density	15.407(a)	PASS
6	Unwanted Emissions and Band Edge	15.205 15.209 15.407(b)	PASS
7	Frequency Stability	15.407(g)	PASS
8	AC Power Line Conducted Emissions	15.207 15.407(b)(6)	PASS
9	Antenna Requirement	15.203	PASS

Note:

(1) "N/A" denotes test is not applicable in this test report

## 2.2. Test Facilities

- EMC Lab : Certificated by CNAS, CHINA  
Registration No.: L5288  
This Certificate is valid until: November 12, 2023
- Certificated by FCC, USA  
Designation Number: CN1215  
This Certificate is valid until: January 31, 2022
- Certificated by A2LA, USA  
Registration No.: 4366.01  
This Certificate is valid until: January 31, 2022
- Certificated by Industry Canada  
CAB identifier No.: CN0035  
This Certificate is valid until: January 31, 2022
- Certificated by VCCI, Japan  
Registration No.:C-14103; T-20073; R-13663;  
R-20103; G-20097  
Date of registration: Apr. 20, 2020  
This Certificate is valid until: Apr. 19, 2023
- Certificated by TUV Rheinland, Germany  
Registration No.: UA 50413872 0001  
Date of registration: July 31, 2018
- Certificated by Intertek  
Registration No.: 2011-RTL-L2-64  
Date of registration: November 08, 2018
- Name of Firm : EST Technology Co., Ltd.
- Site Location : Chilingxiang, Qishantou, Santun, Houjie, Dongguan, Guangdong, China

2.3. Measurement uncertainty for EST Technology Co., Ltd.

Test Item	Uncertainty
Uncertainty for Conduction emission test	2.54dB
Uncertainty for Radiation Emission test (30MHz-1GHz)	3.62
Uncertainty for Radiation Emission test (1GHz to 18GHz)	4.86
Uncertainty for spurious emissions test (18GHz to 40GHz)	4.67
Uncertainty for radio frequency	7×10 <sup>-8</sup>
Uncertainty for conducted RF Power	0.20dB
Uncertainty for Power density test	0.26dB
Temperature	±0.6°C
Humidity	±4.0 %
Volatage DC	±1.0%
Volatage (AC, <10KHz)	±1.5%

Note:

This uncertainty represents an expanded uncertainty expressed at approximately the 95% confidence level using a coverage factor of k=2.

2.4. Assistant equipment used for test

Item	Equipment	Brand	Model Name/Type No.	FCC ID	Series No.
A	Adapter	Huntkey	HKA12024050-6B	-	-

Item	Shielded Type	Ferrite Core	Length	Note
1	NO	NO	1.5m	AC Cable

2.5. Block Diagram

For radiated emissions test: EUT was placed on a turn table, which is 0.8 (or 1.5) meter high above ground.

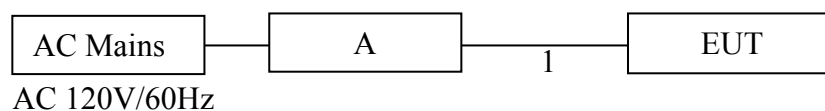

(EUT: Tablet)



## 2.6. Test Mode

Pre-scan has been combined all possible modulations and data rates to determine the worst case test mode, the worst case test mode was selected for the final test as listed below.

Test Item	Test Mode	Channel	Modulation	Data rate
6dB Bandwidth	IEEE 802.11a	149/157/165	OFDM	6Mbps
	IEEE 802.11n HT20	149/157/165	OFDM	MCS0
	IEEE 802.11n HT40	151/159	OFDM	MCS0
26dB Bandwidth	IEEE 802.11a	36/40/48/52/60/64/100/116/140	OFDM	6Mbps
	IEEE 802.11n HT20	36/40/48/52/60/64/100/116/140	OFDM	MCS0
	IEEE 802.11n HT40	38/46/54/62/102/114/134	OFDM	MCS0
99% Occupied Bandwidth	IEEE 802.11a	36/40/48/52/60/64/100/116/140/ 149/157/165	OFDM	6Mbps
	IEEE 802.11n HT20	36/40/48/52/60/64/100/116/140/ 149/157/165	OFDM	MCS0
	IEEE 802.11n HT40	38/46/54/62/102/114/134/151/159	OFDM	MCS0
Maximum Conducted Output Power	IEEE 802.11a	36/40/48/52/60/64/100/116/140/ 149/157/165	OFDM	6Mbps
	IEEE 802.11n HT20	36/40/48/52/60/64/100/116/140/ 149/157/165	OFDM	MCS0
	IEEE 802.11n HT40	38/46/54/62/102/114/134/151/159	OFDM	MCS0

Peak Power Spectral Density	IEEE 802.11a	36/40/48/52/60/64/100/116/140/ 149/157/165	OFDM	6Mbps
	IEEE 802.11n HT20	36/40/48/52/60/64/100/116/140/ 149/157/165	OFDM	MCS0
	IEEE 802.11n HT40	38/46/54/62/102/114/134/151/159	OFDM	MCS0
Unwanted Emissions and Band Edge(Above 1GHz)	IEEE 802.11a	36/40/48/52/60/64/100/116/140/ 149/157/165	OFDM	6Mbps
	IEEE 802.11n HT20	36/40/48/52/60/64/100/116/140/ 149/157/165	OFDM	MCS0
	IEEE 802.11n HT40	38/46/54/62/102/114/134/151/159	OFDM	MCS0
Unwanted Emissions Below 1GHz	IEEE 802.11a	100	OFDM	6Mbps
Frequency Stability	Unmodulation	36/64/100/149	N/A	N/A
AC Power Line Conducted Emissions	IEEE 802.11a	100	OFDM	6Mbps

Note:

1. In radiated measurement, the EUT had been pre-scan on the positioned of each 3 axis(X, Y, Z), the worst case was found when positioned on **X-plane**.

2.7. Channel List

Band	Mode	Channel	Frequency (MHz)
U-NII-1	IEEE 802.11a & n HT20	36	5180
		40	5200
		44	5220
		48	5240
	IEEE 802.11n HT40	38	5190
		46	5230
U-NII-2A	IEEE 802.11a & n HT20	52	5260
		56	5280
		60	5300
		64	5320
	IEEE 802.11n HT40	54	5270
		62	5310
U-NII-2C	IEEE 802.11a & n HT20	100	5500
		104	5520
		108	5540
		112	5560
		116	5580
		120	5600
		124	5620
		128	5640
		132	5660
		136	5680
	140	5700	
	IEEE 802.11n HT40	102	5510
		110	5550
		118	5590
126		5630	
U-NII-3	IEEE 802.11a & n HT20	149	5745
		153	5765
		157	5785
		161	5805
		165	5825
	IEEE 802.11n HT40	151	5755
		159	5795

2.8. Power Setting of Test Software

Software Name	N/A		
U-NII-1			
Frequency(MHz)	5180	5200	5240
IEEE 802.11a Setting	17	17	17
IEEE 802.11n HT20 Setting	16.5	16.5	16.5
Frequency(MHz)	5190	5230	
IEEE 802.11n HT40 Setting	16.5	16.5	
U-NII-2A			
Frequency(MHz)	5260	5300	5320
IEEE 802.11a Setting	17	17	17
IEEE 802.11n HT20 Setting	16.5	16.5	16.5
Frequency(MHz)	5270	5310	
IEEE 802.11n HT40 Setting	16.5	16.5	
U-NII-2C			
Frequency(MHz)	5500	5580	5700
IEEE 802.11a Setting	17	17	17
IEEE 802.11n HT20 Setting	16.5	16.5	16.5
Frequency(MHz)	5510	5670	
IEEE 802.11n HT40 Setting	16.5	16.5	
U-NII-3			
Frequency(MHz)	5745	5785	5825
IEEE 802.11a Setting	17	17	17
IEEE 802.11n HT20 Setting	16.5	16.5	16.5
Frequency(MHz)	5755	5795	
IEEE 802.11n HT40 Setting	16.5	16.5	

## 2.9. Duty Cycle of Test Signal

Temperature	25°C	Relative Humidity		60%	Test Voltage		120V/60Hz
Mode	Frequency (MHz)	On time (ms)	Total Time (ms)	Duty Cycle (%)	Duty Factor (dB)	1/T (Hz)	VBW Setting (Hz)
IEEE 802.11a	5180	1.42609	1.57391	90.61	0.43	701	701
IEEE 802.11n HT20	5180	1.30435	1.45217	89.82	0.47	767	767
IEEE 802.11n HT40	5190	0.66087	0.80870	81.72	0.88	1513	1513

Note:

1. Duty Cycle=On Time/Total Time×100%.
2. Duty Factor=10×LOG(1/Duty Cycle).
3. If duty cycle <98 %, the conducted average output power and average power spectral density should be add duty factor.
4. If duty cycle ≥98 %,the EUT is consider to be transmitting continuously,the conducted average output power and average power spectral density no need to add duty factor.
5. The on-time time is transmission duration(T).
6. The VBW Setting is use for RMS measurement in Unwanted Emissions and Band Edge(Above 1GHz ) Test.

### IEEE 802.11a 5180MHz

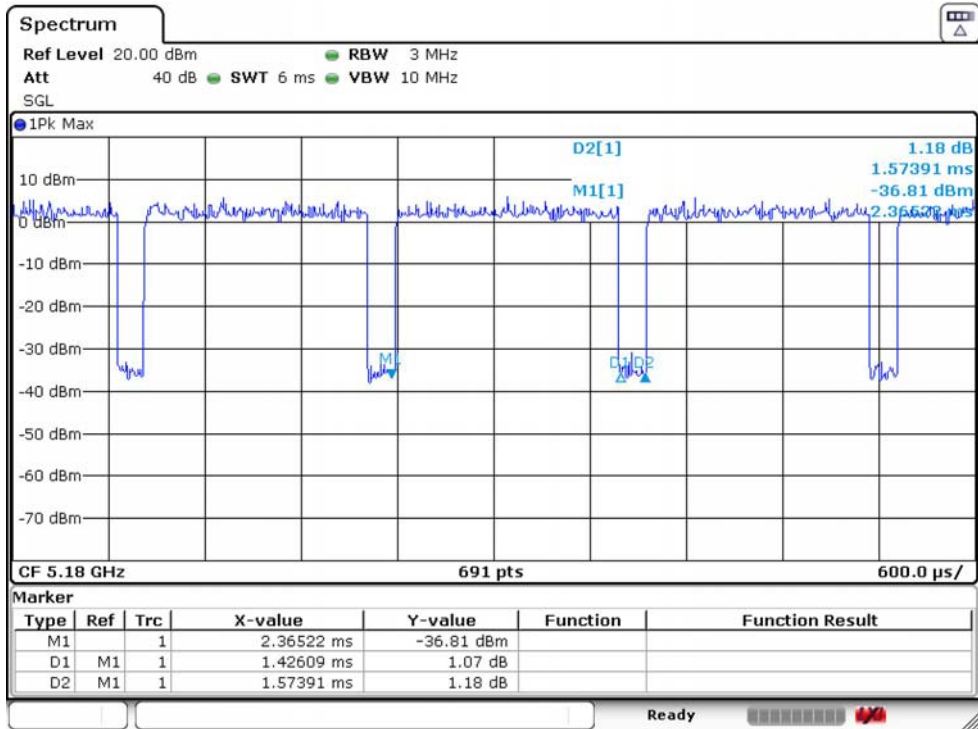

### IEEE 802.11n HT20 5180MHz

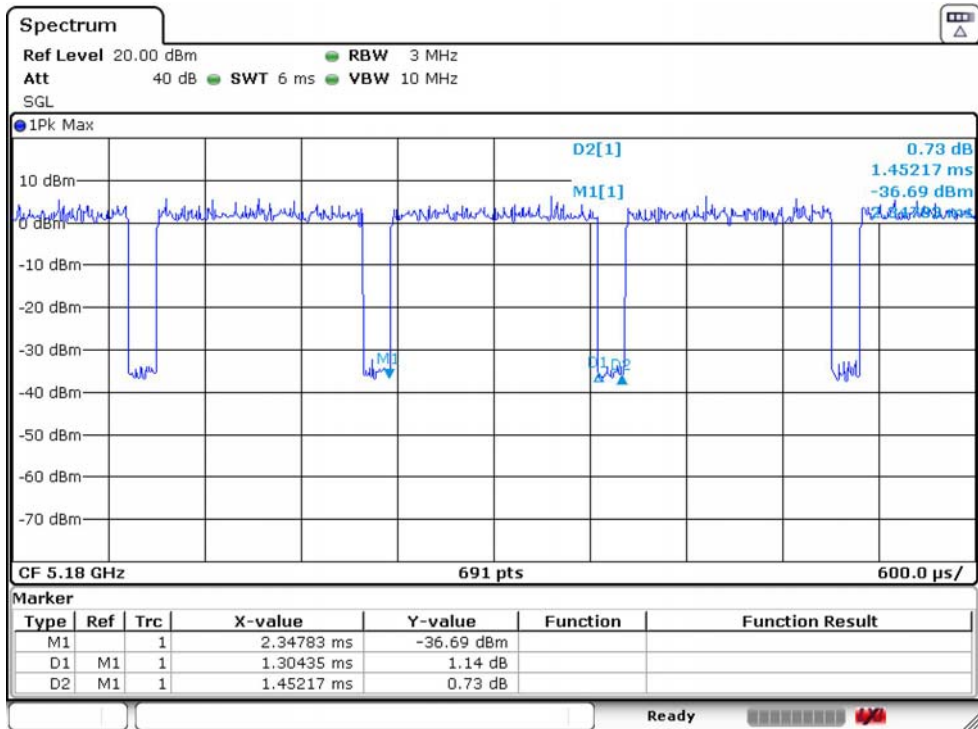

### IEEE 802.11n HT40 5190MHz

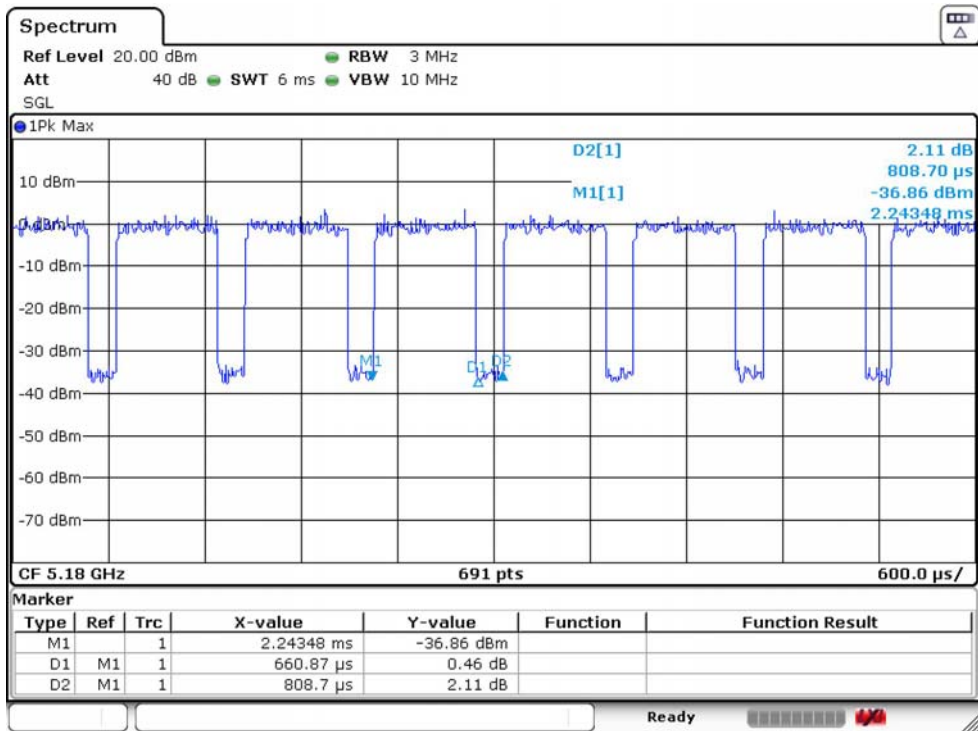

## 2.10. Test Equipment List

For AC power conducted emissions test						
Equipment	Manufacturer	Model No.	Serial No.	Calibration Body	Last Cal.	Next Cal.
EMI Test Receiver	Rohde & Schwarz	ESHS30	EST-E001	LISAI	June 13,20	1 Year
Artificial Mains Network	Rohde & Schwarz	ENV216	EST-E002	LISAI	June 13,20	1 Year
Pulse Limiter	Rohde & Schwarz	ESH3-Z2	EST-E078	LISAI	June 13,20	1 Year
Test Software	Audix	e3-6.111221a	N/A	N/A	N/A	N/A

For radiated emissions test(9KHz-30MHz)						
Equipment	Manufacturer	Model No.	Serial No.	Calibration Body	Last Cal.	Next Cal.
EMI Test Receiver	Rohde & Schwarz	ESR7	EST-E047	LISAI	June 13,20	1 Year
Active Loop Antenna	SCHWARZECK	FMZB 1519B	EST-E054	LISAI	June 13,20	1 Year
Test Software	Audix	e3-6.111221a	N/A	N/A	N/A	N/A
9kHz-30MHz Cable	N/A	EST-001	N/A	N/A	N/A	N/A

For radiated emissions test(30MHz-1000MHz)						
Equipment	Manufacturer	Model No.	Serial No.	Calibration Body	Last Cal.	Next Cal.
EMI Test Receiver	Rohde & Schwarz	ESR7	EST-E047	LISAI	June 13,20	1 Year
Bilog Antenna	Teseq	CBL 6111D	EST-E034	LISAI	June 13,20	1 Year
Test Software	Audix	e3-6.111221a	N/A	N/A	N/A	N/A
30-1000MHz Cable	N/A	EST-002	N/A	N/A	N/A	N/A

For radiated emissions test(Above 1000MHz)						
Equipment	Manufacturer	Model No.	Serial No.	Calibration Body	Last Cal.	Next Cal.
Horn Antenna	SCHWARZECK	BBHA 9120 D	EST-E031	LISAI	June 13,20	1 Year
Signal Amplifier	SCHWARZECK	BBV9718	EST-E032	LISAI	June 13,20	1 Year
Spectrum Analyzer	Rohde & Schwarz	FSV40	EST-E069	LISAI	June 13,20	1 Year
Test Software	Audix	e3-6.111221a	N/A	N/A	N/A	N/A
Above 1GHz Cable	N/A	EST-003	N/A	N/A	N/A	N/A

For connect EUT antenna terminal test						
Equipment	Manufacturer	Model No.	Serial No.	Calibration Body	Last Cal.	Next Cal.
TS 8997	Rohde &Schwarz	/	/	/	/	/
Open Switch and Control Unit	Rohde &Schwarz	OSP-B157WB	EST-E036	LISAI	June 13,20	1 Year
Signal and Spectrum Analyzer	Rohde &Schwarz	FSV	EST-E037	LISAI	June 13,20	1 Year
Signal Generator	Rohde &Schwarz	SMB100A	EST-E038	LISAI	June 13,20	1 Year
Vector Signal Generator	Rohde &Schwarz	SMBV100A	EST-E039	LISAI	June 13,20	1 Year
Test Software	Rohde &Schwarz	WMS32	V10.50.00	N/A	N/A	N/A
Temperature controller	Terchy	MHQ	EST-E101	LISAI	June 13,20	1 Year



### 3. 6dB BANDWIDTH & 26dB BANDWIDTH & 99% OCCUPIED BANDWIDTH

#### 3.1. Limit

Band	Frequency (MHz)	Test Item	Limit
U-NII-1	5150-5250	26dB Bandwidth&99% Occupied Bandwidth	N/A
U-NII-2A	5250-5350	26dB Bandwidth&99% Occupied Bandwidth	N/A
U-NII-2C	5470-5725	26dB Bandwidth&99% Occupied Bandwidth	N/A
U-NII-3	5725-5850	6dB Bandwidth&99% Occupied Bandwidth	6dB Bandwidth $\geq$ 500KHz

#### 3.2. Test Setup

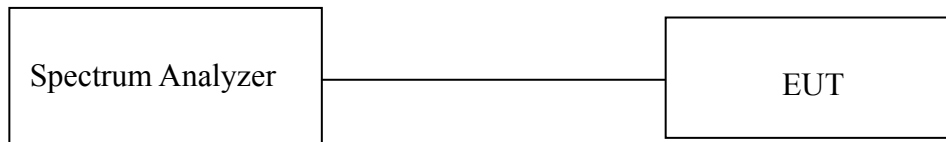

#### 3.3. Spectrum Analyzer Setting

6dB Bandwidth	
Spectrum Parameters	Setting
RBW	100KHz
VBW	300KHz
Span	40MHz(20MHz Bandwidth mode) 60MHz(40MHz Bandwidth mode) 120MHz(80MHz Bandwidth mode)
Sweep Time	Auto
Detector	Peak
Trace Mode	Max Hold

26dB Bandwidth	
Spectrum Parameters	Setting
RBW	approximately 1% of the emission bandwidth
VBW	>RBW
Span	40MHz(20MHz Bandwidth mode) 60MHz(40MHz Bandwidth mode) 120MHz(80MHz Bandwidth mode)
Sweep Time	Auto
Detector	Peak
Trace Mode	Max Hold

99% Occupied Bandwidth	
Spectrum Parameters	Setting
RBW	1% to 5% of the OBW
VBW	approximately three times the RBW
Span	between 1.5 times and 5.0 times the OBW
Sweep Time	Auto
Detector	Peak
Trace Mode	Max Hold

### 3.4. Test Procedure

**For 26dB Bandwidth Measurement :**

- a. Connect EUT antenna terminal to the spectrum analyzer with RF cable.
- b. Spectrum analyzer setting parameters in accordance with section 3.3.
- c. Set the EUT transmit continuously with maximum output power.
- d. Allow trace to stabilize, measure the maximum width of the emission that is 26 dB down from the peak of the emission. Compare this with the RBW setting of the instrument. Readjust RBW and repeat measurement as needed until the RBW/EBW ratio is approximately 1%.
- e. Repeat above procedures until all modes and channels were measured.
- f. Record the results in the test report.

**For 6dB Bandwidth Measurement :**

- a. Connect EUT antenna terminal to the spectrum analyzer with RF cable.
- b. Spectrum analyzer setting parameters in accordance with section 3.3.
- c. Set the EUT transmit continuously with maximum output power.
- d. Allow trace to stabilize, measure the maximum width of the emission that is constrained by the frequencies associated with the two outermost amplitude points (upper and lower frequencies) that are attenuated by 6 dB relative to the maximum level measured in the fundamental emission.
- e. Repeat above procedures until all modes and channels were measured.
- f. Record the results in the test report.

**For 99% Occupied Bandwidth Measurement :**

- a. Connect EUT antenna terminal to the spectrum analyzer with RF cable.
- b. Spectrum analyzer setting parameters in accordance with section 3.3.
- c. Set the EUT transmit continuously with maximum output power.
- d. Allow trace to stabilize, use the 99% power bandwidth function to measure bandwidth.
- e. Repeat above procedures until all modes and channels were measured.
- f. Record the results in the test report.

3.5. Test Result

Temperature	25℃	Relative Humidity		60%	Test Voltage	120V/60Hz
26dB Bandwidth&99% Occupied Bandwidth						
BAND	Test Mode	Fre (MHz)	26dB Bandwidth (MHz)	99% Occupied Bandwidth (MHz)	Calculate Power Limit (W)	Calculate Power Limit (dBm)
U-NII-1	IEEE 802.11a	5180	20.203	16.888		
		5200	19.971	17.088		
		5240	19.913	16.981		
	IEEE 802.11n HT20	5180	20.260	17.807		
		5200	20.318	17.834		
		5240	20.318	17.941		
IEEE 802.11n HT40	5190	40.376	36.654			
	5230	40.463	36.601			
U-NII-2A	IEEE 802.11a	5260	20.029	16.874	0.2500	23.98
		5300	19.971	16.848	0.2500	23.98
		5320	19.913	16.914	0.2500	23.98
	IEEE 802.11n HT20	5260	20.260	17.861	0.2500	23.98
		5300	20.318	17.994	0.2500	23.98
		5320	20.203	17.847	0.2500	23.98
	IEEE 802.11n HT40	5270	40.637	36.601	0.2500	23.98
		5310	40.550	36.681	0.2500	23.98

BAND	Test Mode	Fre (MHz)	26dB Bandwidth (MHz)	99% Occupied Bandwidth (MHz)	Calculate Power Limit (W)	Calculate Power Limit (dBm)
U-NII-2C	IEEE 802.11a	5500	20.087	16.728	0.2500	23.98
		5580	20.029	17.061	0.2500	23.98
		5700	20.029	16.861	0.2500	23.98
	IEEE 802.11n HT20	5500	20.260	17.874	0.2500	23.98
		5580	20.260	17.847	0.2500	23.98
		5700	20.492	17.807	0.2500	23.98
	IEEE 802.11n HT40	5510	40.810	36.681	0.2500	23.98
		5670	40.550	36.654	0.2500	23.98

Temperature	25°C	Relative Humidity	60%	Test Voltage	120V/60Hz	
6dB Bandwidth&99% Occupied Bandwidth						
BAND	Test Mode	Frequency (MHz)	6dB Bandwidth (MHz)	99% Occupied Bandwidth (MHz)	6dB BW Min Limit (MHz)	Result
U-NII-3	IEEE 802.11a	5745	15.448	16.901	0.5	PASS
		5785	15.901	17.034	0.5	PASS
		5825	15.675	16.874	0.5	PASS
	IEEE 802.11n HT20	5745	17.008	17.901	0.5	PASS
		5785	16.914	17.874	0.5	PASS
		5825	16.914	17.954	0.5	PASS
	IEEE 802.11n HT40	5755	35.172	36.734	0.5	PASS
		5795	35.172	36.788	0.5	PASS

Note :

For Band U-NII-2A and U-NII-2C, the maximum conducted output power limit is 250mw or  $11+10 \times \text{Log B}$ , which is lesser, where B is the 26dB Bandwidth in MHz. So in this section, the maximum conducted output power limit can calculate with 26dB Bandwidth.

### 3.6. Test Result

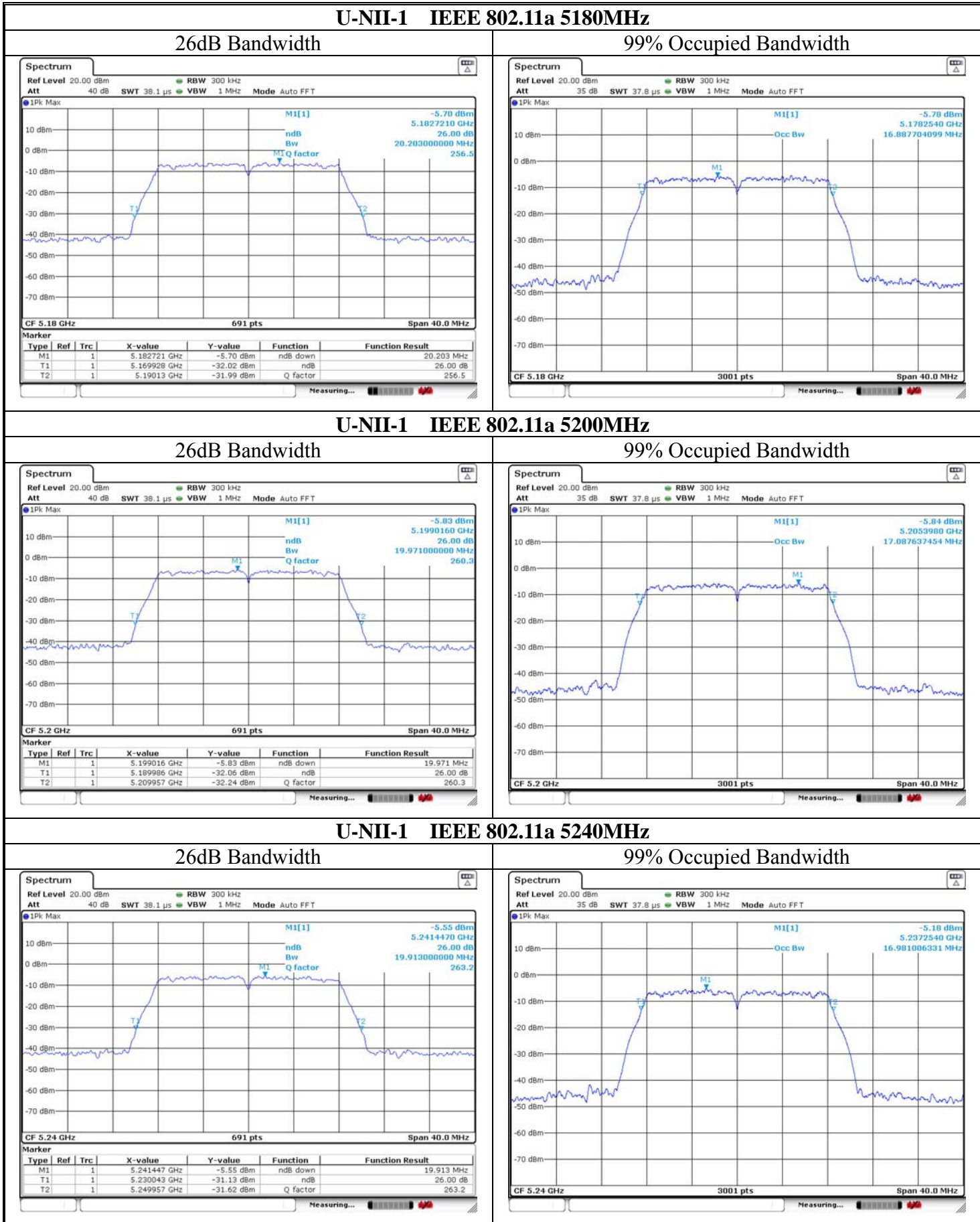

**U-NII-1 IEEE 802.11n HT20 5180MHz**

26dB Bandwidth

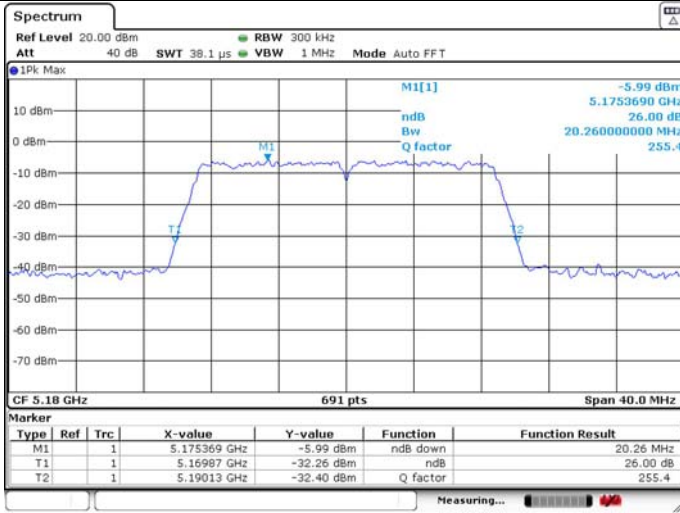

99% Occupied Bandwidth

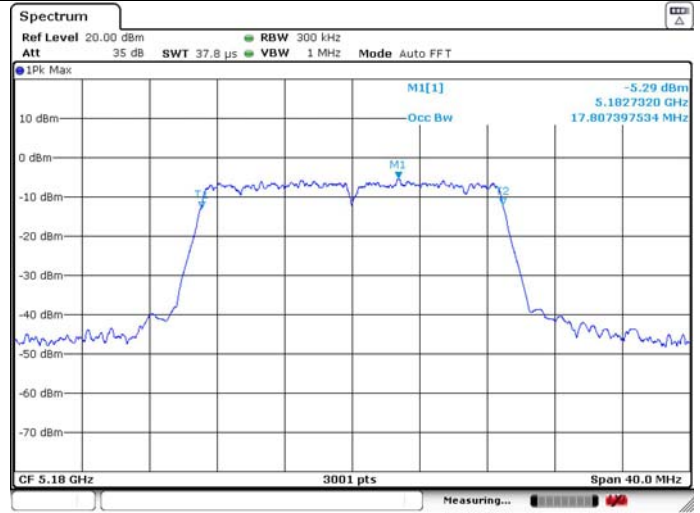

**U-NII-1 IEEE 802.11n HT20 5200MHz**

26dB Bandwidth

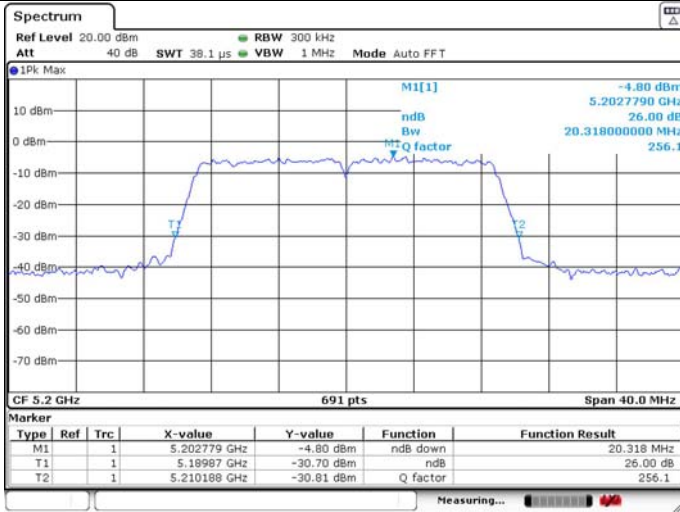

99% Occupied Bandwidth

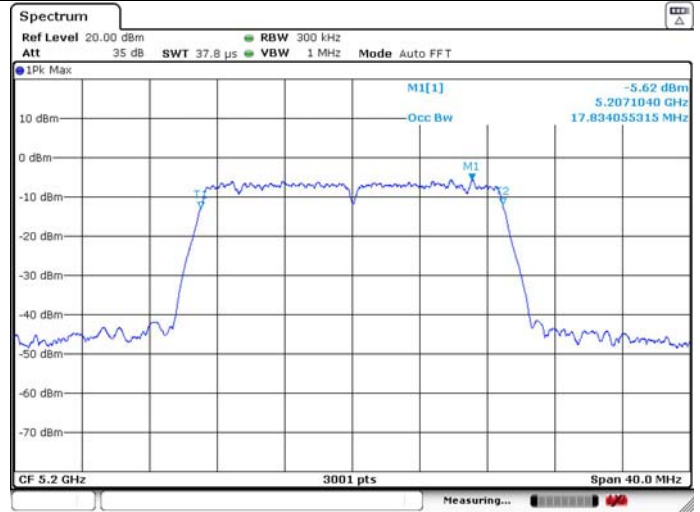

**U-NII-1 IEEE 802.11n HT20 5240MHz**

26dB Bandwidth

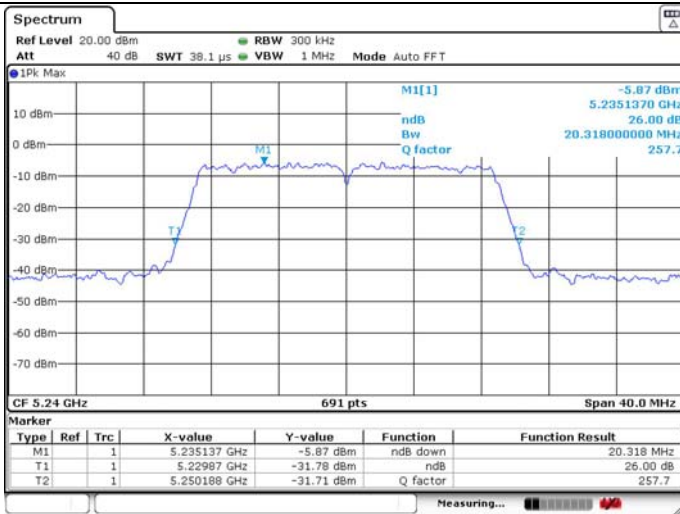

99% Occupied Bandwidth

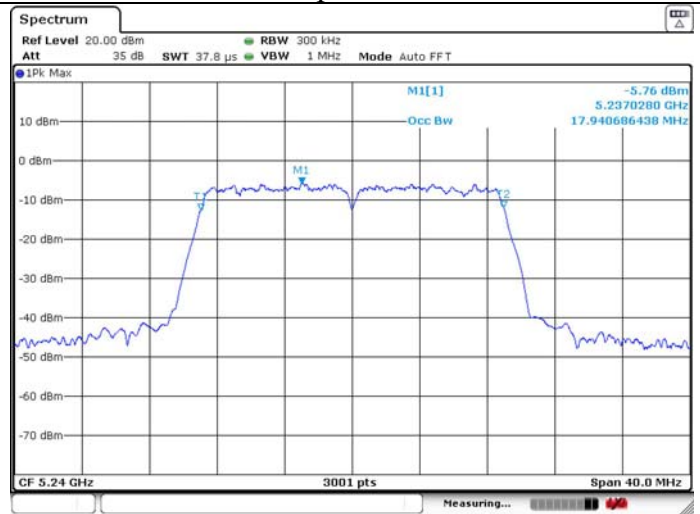



### U-NII-1 IEEE 802.11n HT40 5190MHz

**26dB Bandwidth**

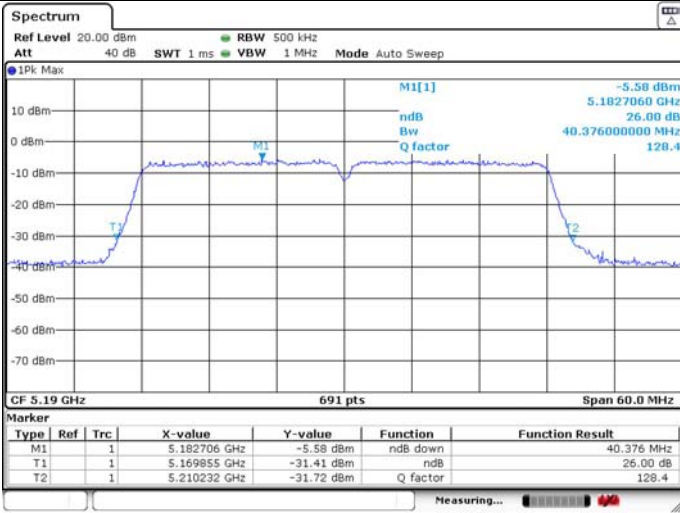

**99% Occupied Bandwidth**

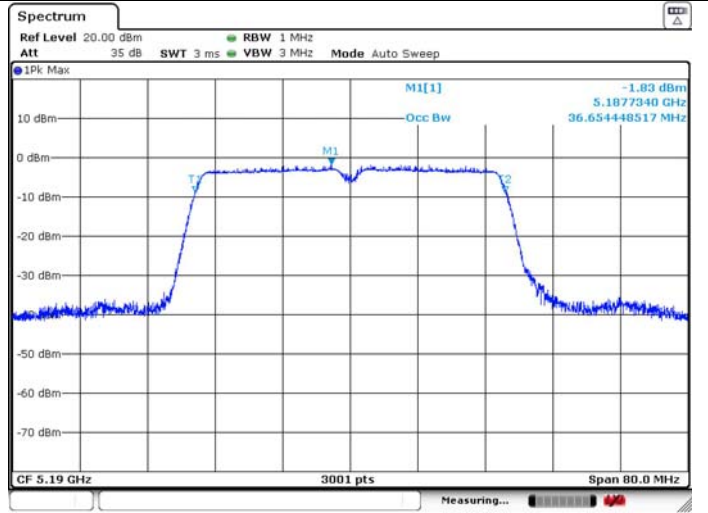

### U-NII-1 IEEE 802.11n HT40 5230MHz

**26dB Bandwidth**

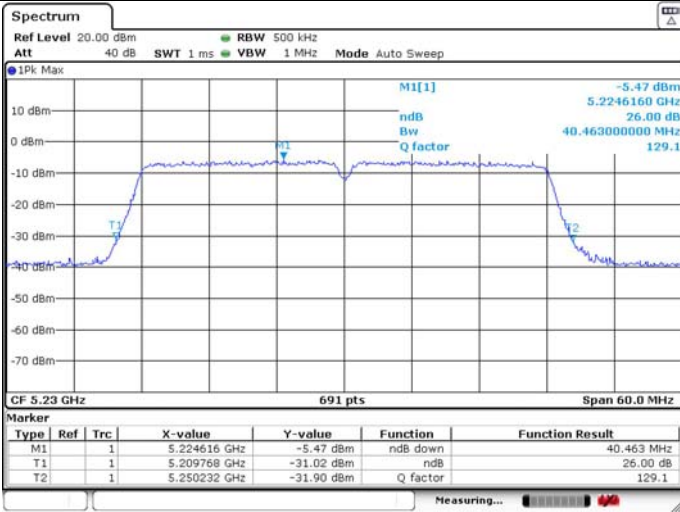

**99% Occupied Bandwidth**

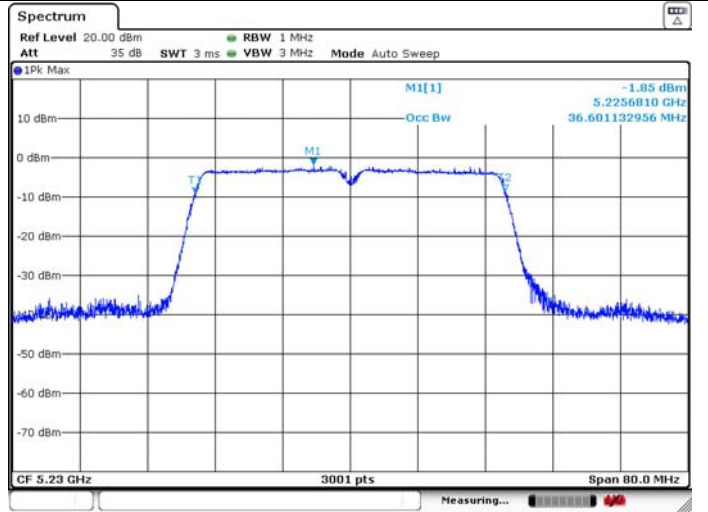

**U-NII-2A IEEE 802.11a 5260MHz**

26dB Bandwidth

99% Occupied Bandwidth

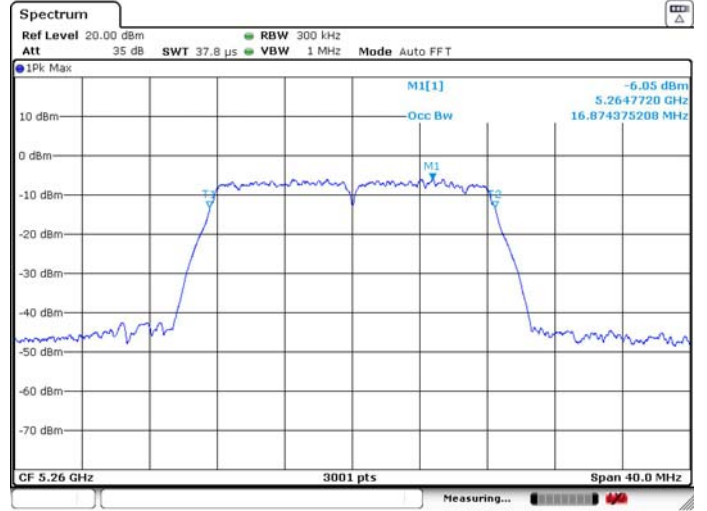
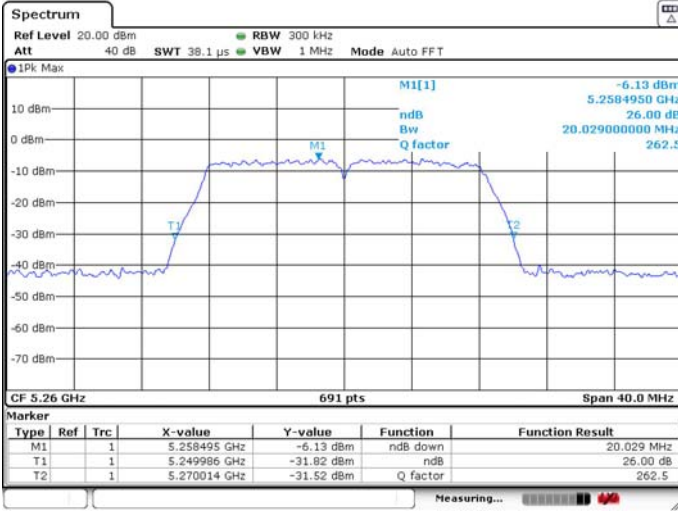

**U-NII-2A IEEE 802.11a 5300MHz**

26dB Bandwidth

99% Occupied Bandwidth

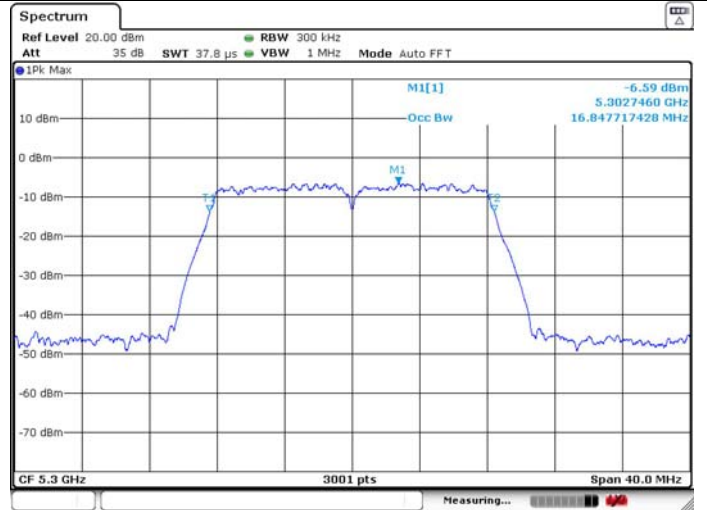
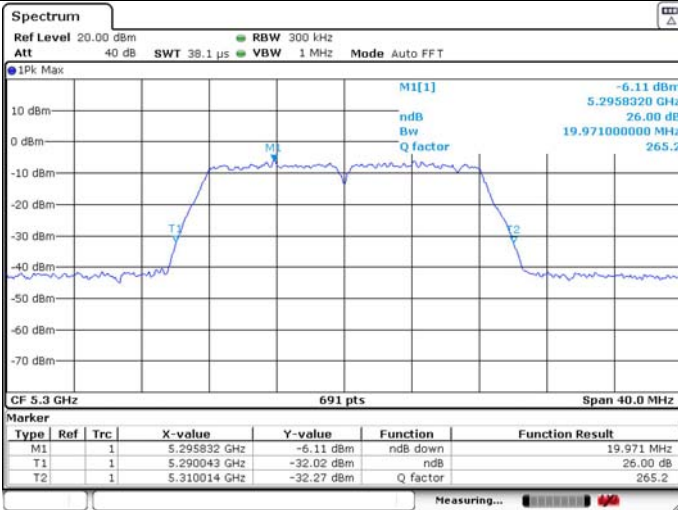

**U-NII-2A IEEE 802.11a 5320MHz**

26dB Bandwidth

99% Occupied Bandwidth

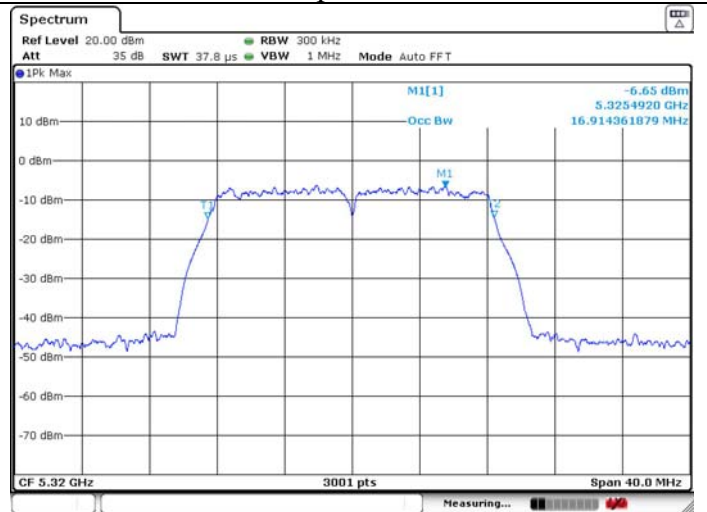
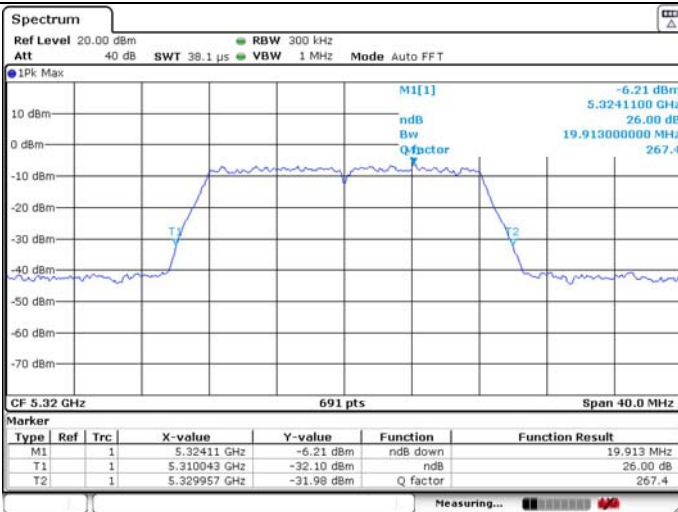



**U-NII-2A IEEE 802.11n HT20 5260MHz**

26dB Bandwidth

99% Occupied Bandwidth

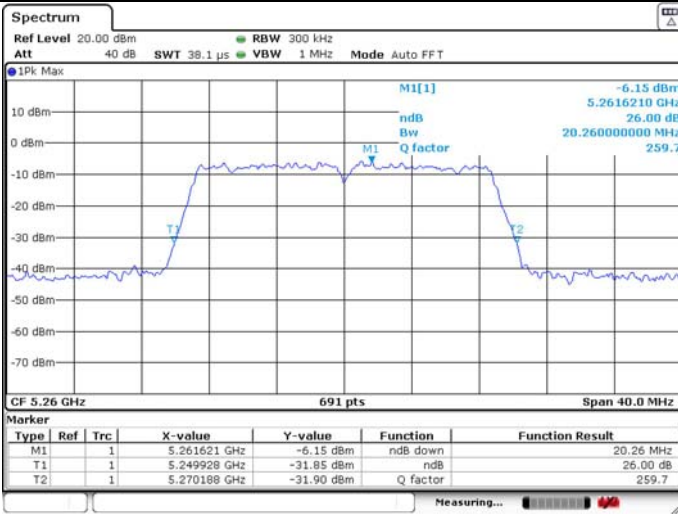

**U-NII-2A IEEE 802.11n HT20 5300MHz**

26dB Bandwidth

99% Occupied Bandwidth

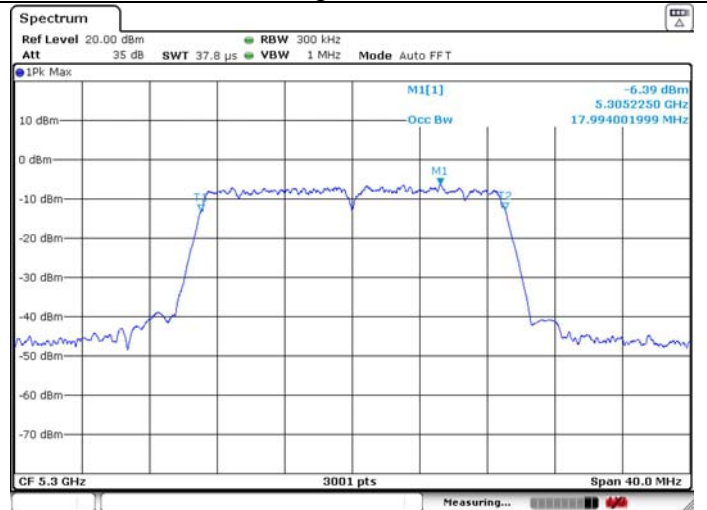
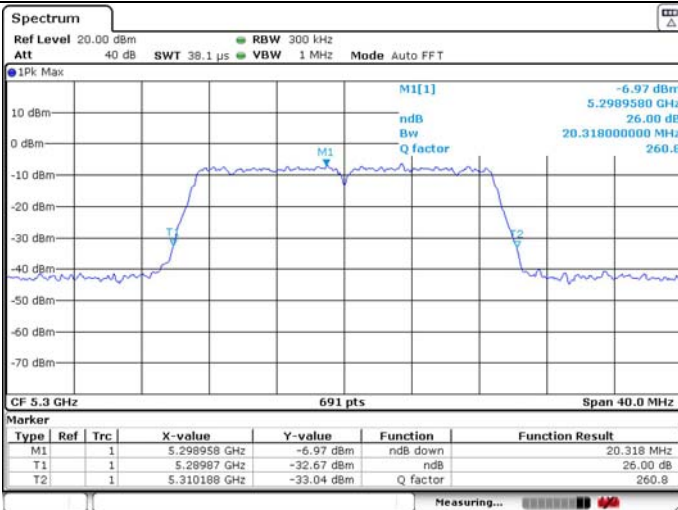

**U-NII-2A IEEE 802.11n HT20 5320MHz**

26dB Bandwidth

99% Occupied Bandwidth

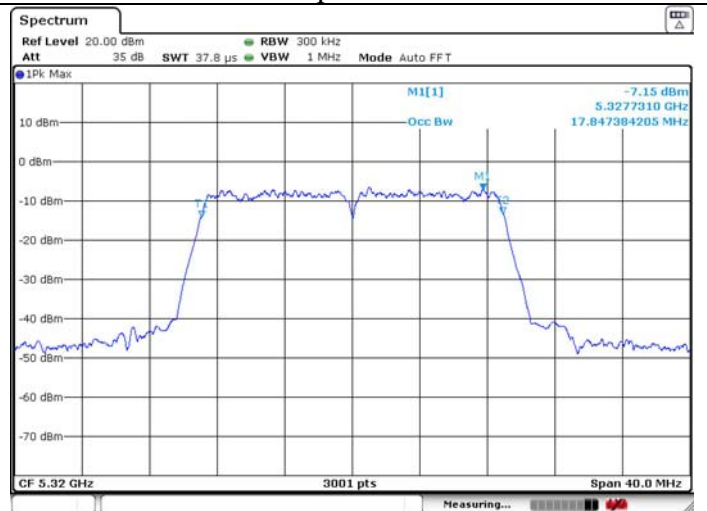
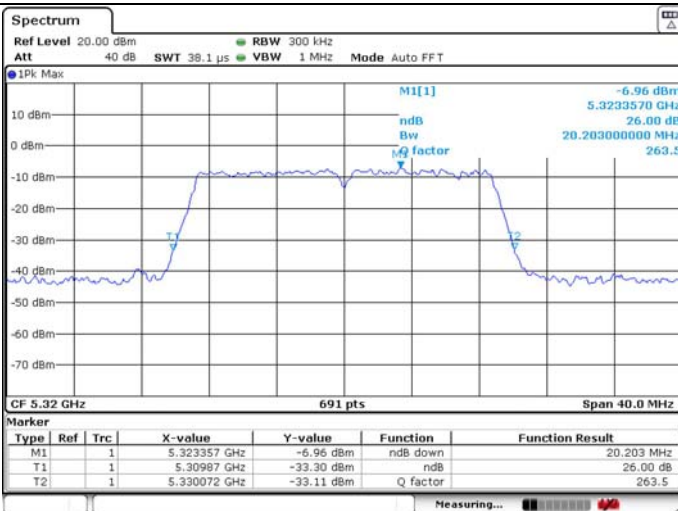

**U-NII-2A IEEE 802.11n HT40 5270MHz**

26dB Bandwidth

99% Occupied Bandwidth

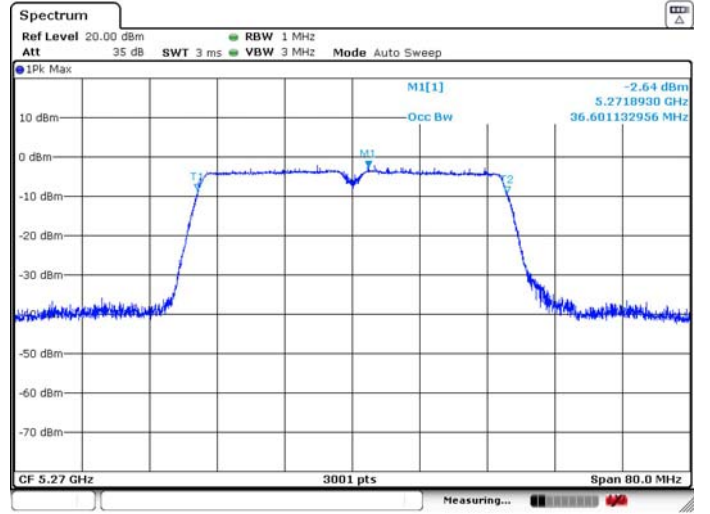
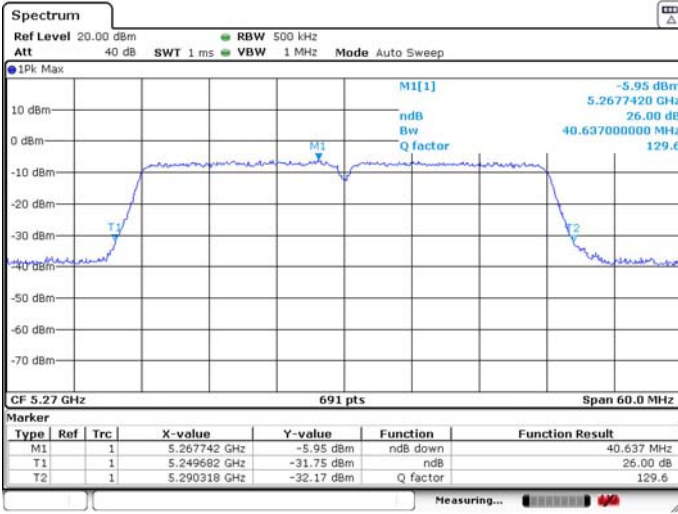

**U-NII-2A IEEE 802.11n HT40 5310MHz**

26dB Bandwidth

99% Occupied Bandwidth

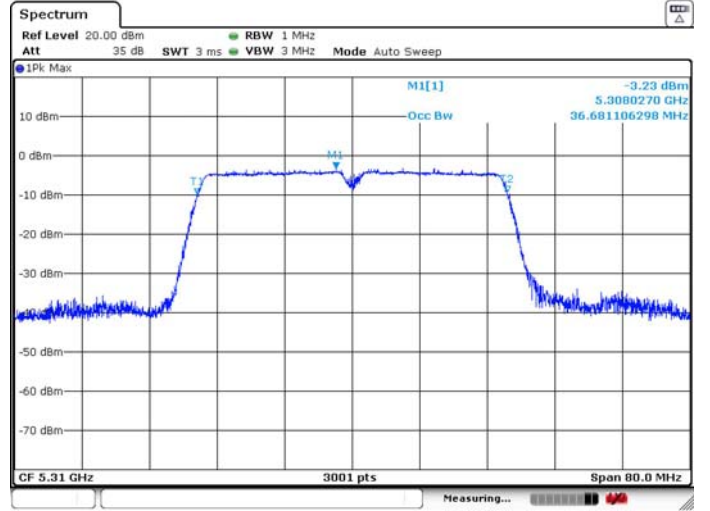
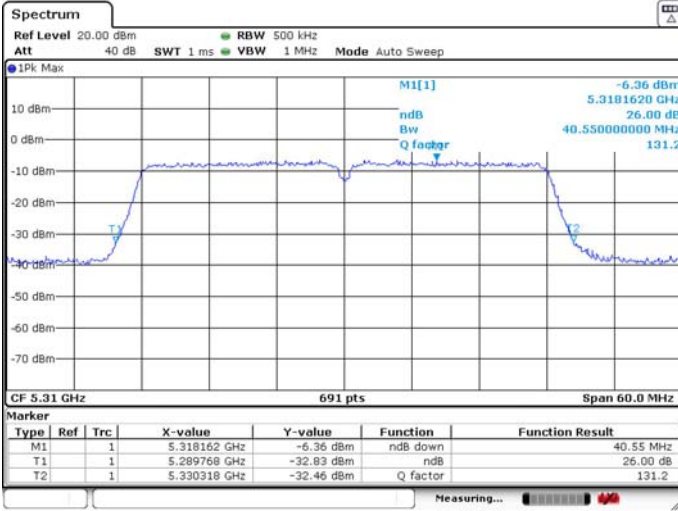

**U-NII-2C IEEE 802.11a 5500MHz**

26dB Bandwidth

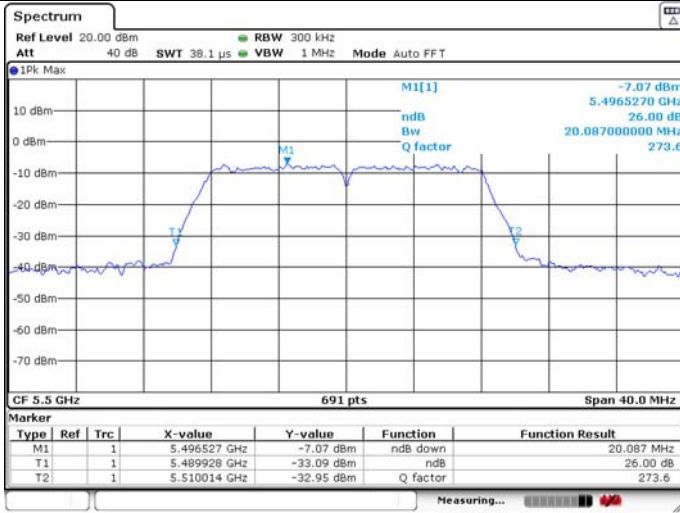

99% Occupied Bandwidth

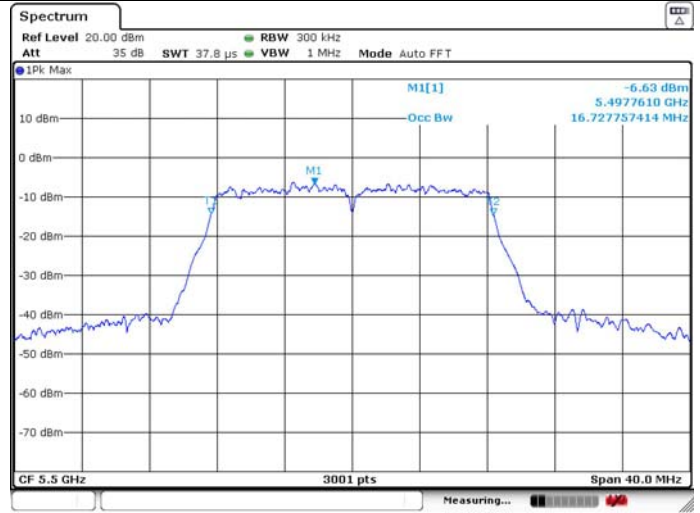

**U-NII-2C IEEE 802.11a 5580MHz**

26dB Bandwidth

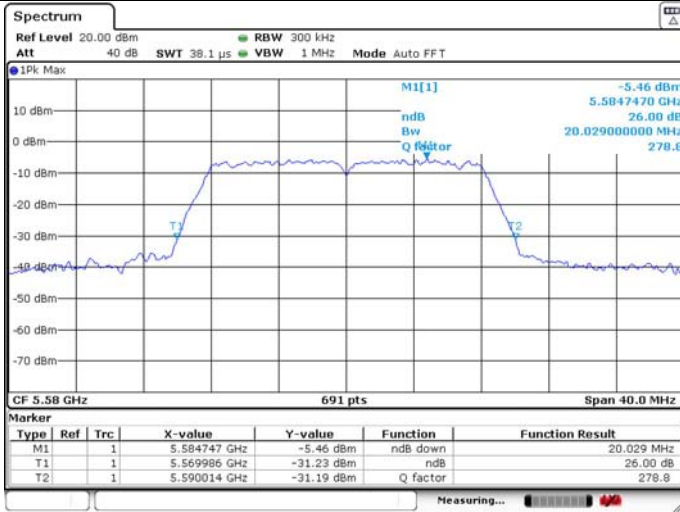

99% Occupied Bandwidth

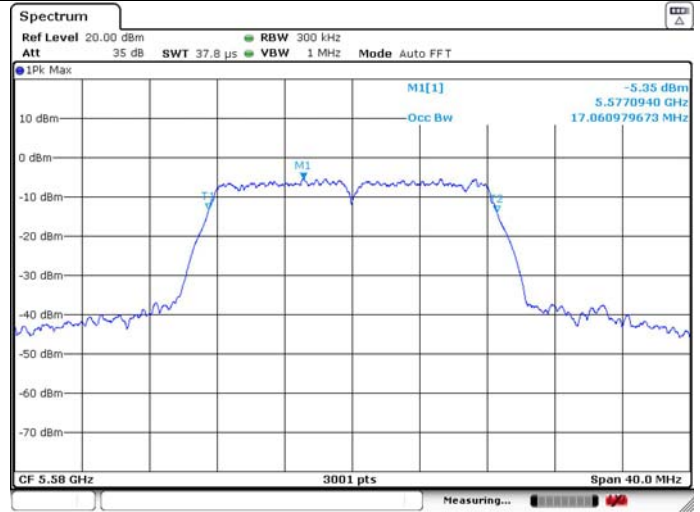

**U-NII-2C IEEE 802.11a 5700MHz**

26dB Bandwidth

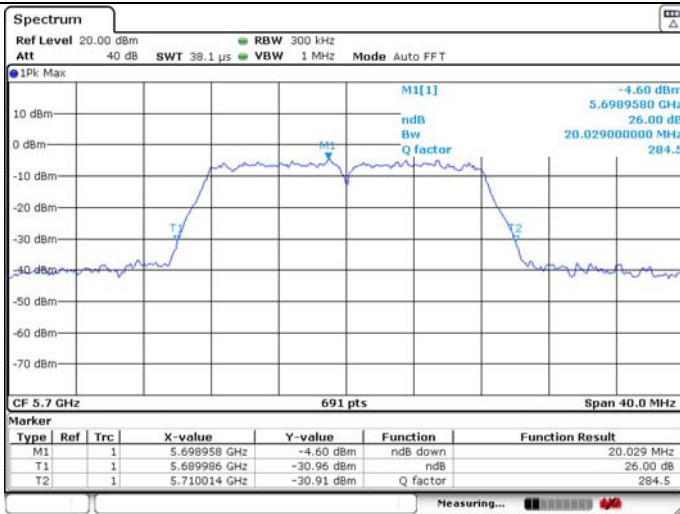

99% Occupied Bandwidth

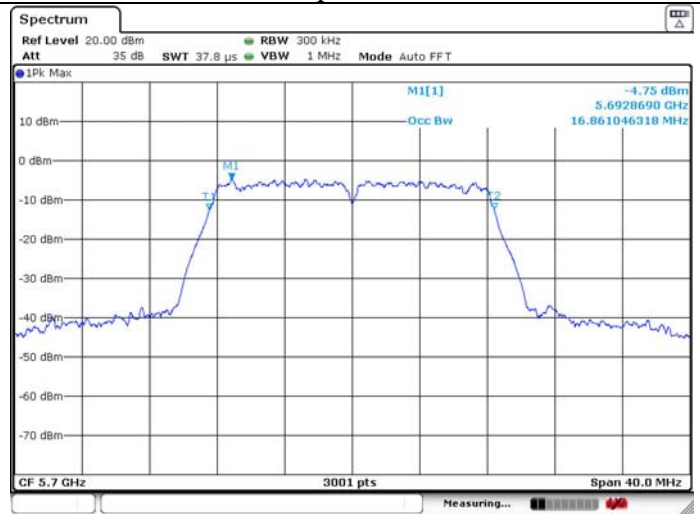

**U-NII-2C IEEE 802.11n HT20 5500MHz**

26dB Bandwidth

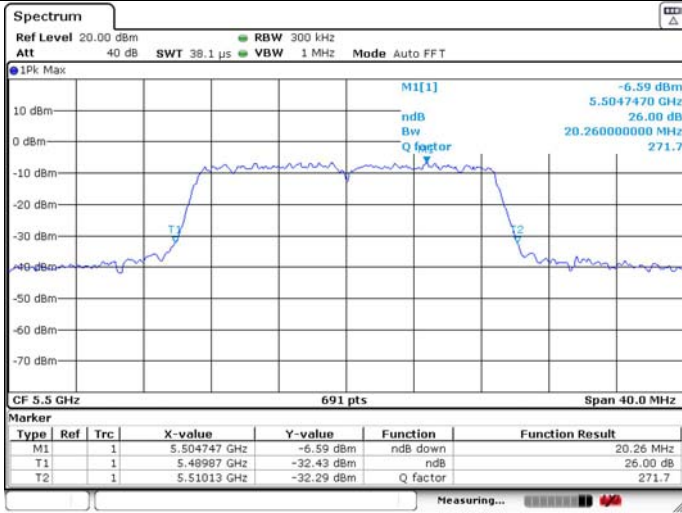

99% Occupied Bandwidth

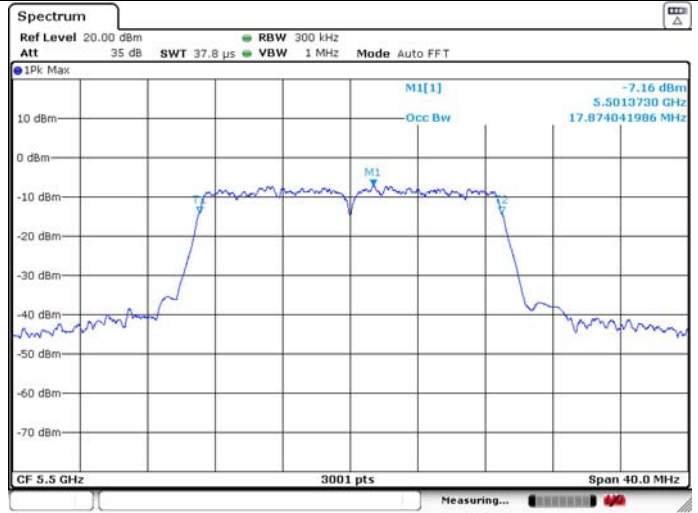

**U-NII-2C IEEE 802.11n HT20 5580MHz**

26dB Bandwidth

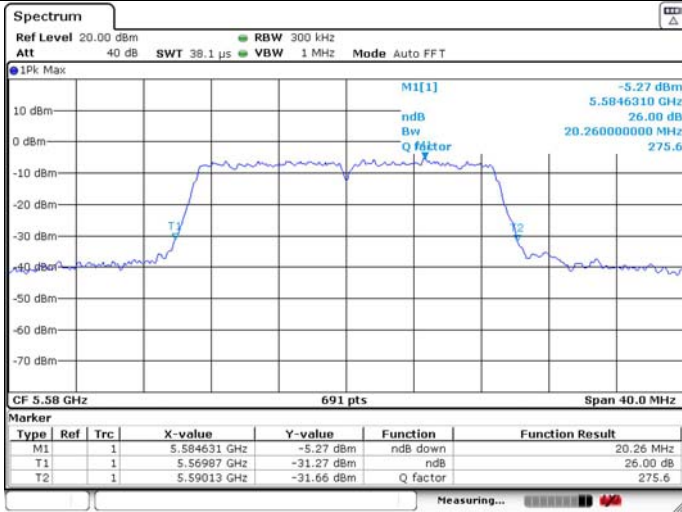

99% Occupied Bandwidth

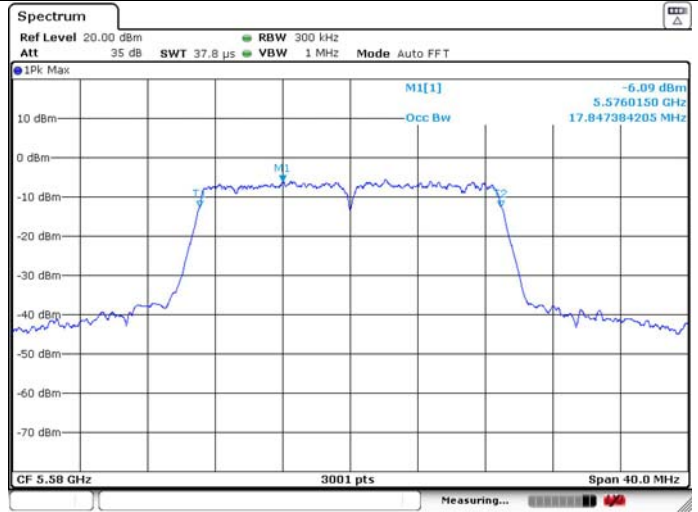

**U-NII-2C IEEE 802.11n HT20 5700MHz**

26dB Bandwidth

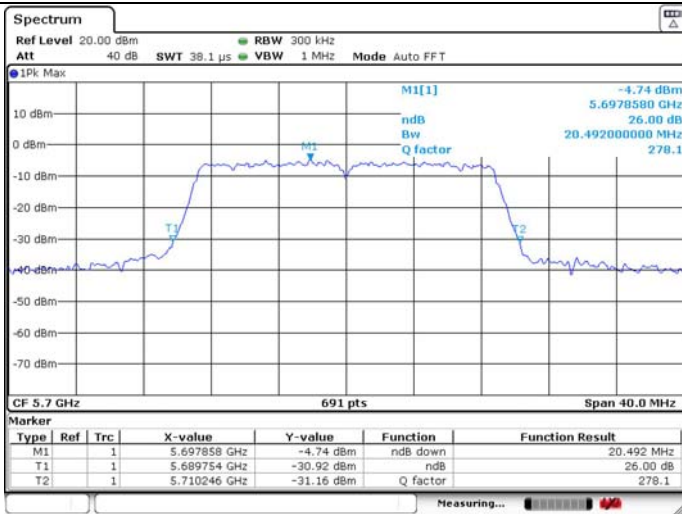

99% Occupied Bandwidth

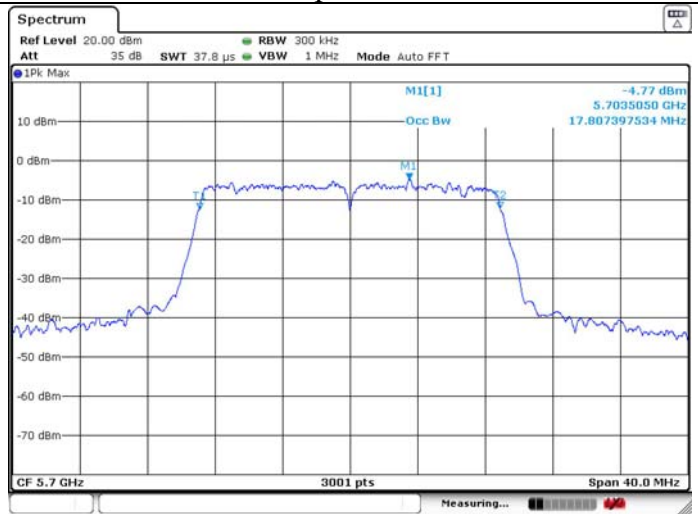



**U-NII-2C IEEE 802.11n HT40 5510MHz**

26dB Bandwidth

99% Occupied Bandwidth

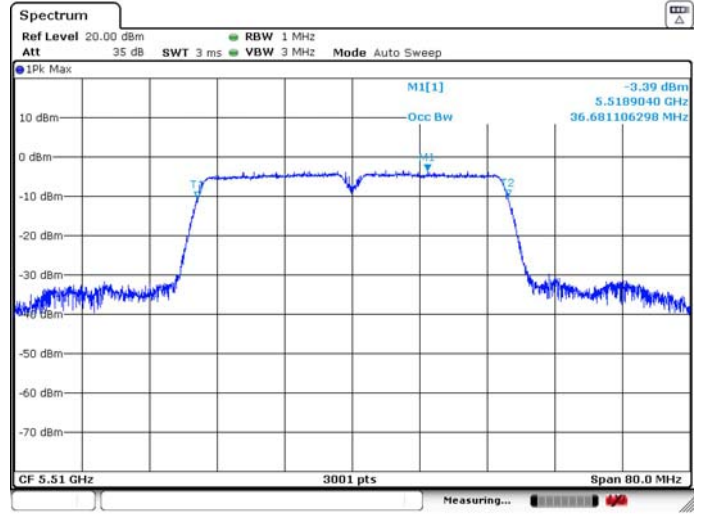
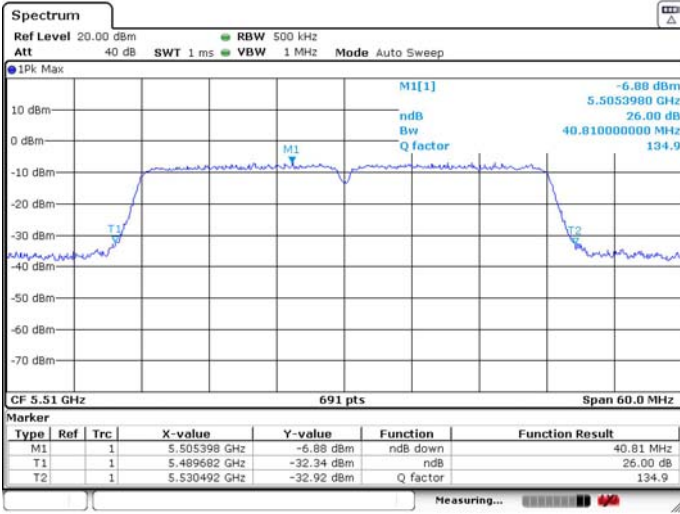

**U-NII-2C IEEE 802.11n HT40 5670MHz**

26dB Bandwidth

99% Occupied Bandwidth

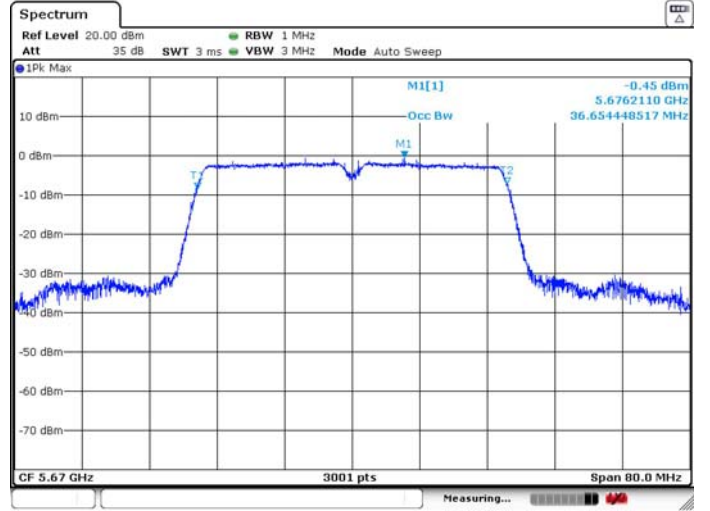
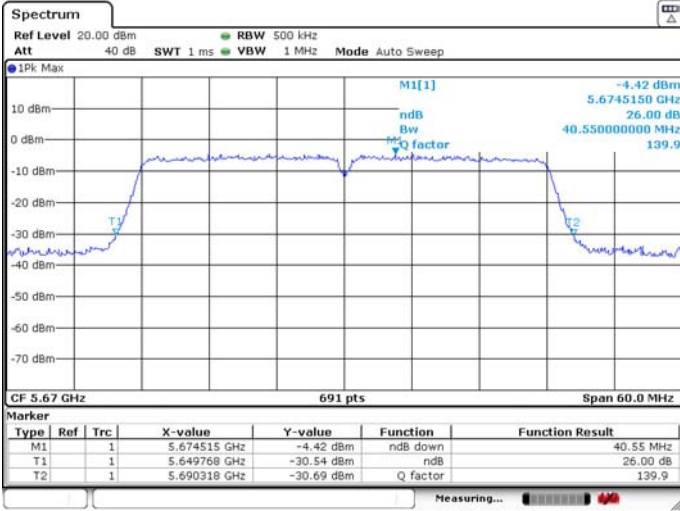

### U-NII-3 IEEE 802.11a 5745MHz

6dB Bandwidth

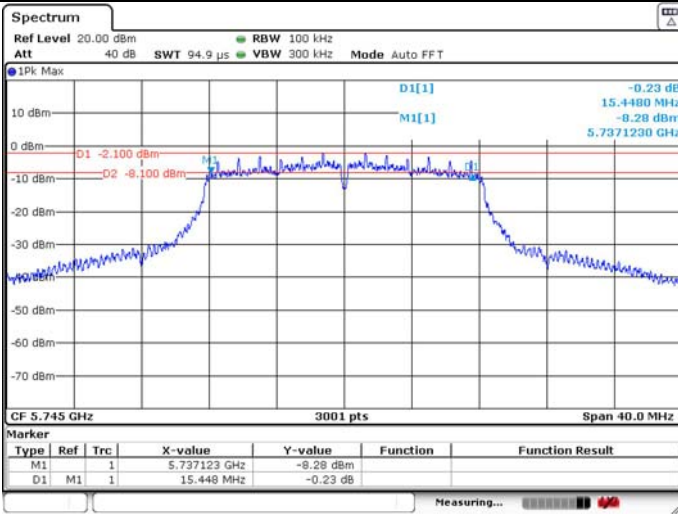

99% Occupied Bandwidth



### U-NII-3 IEEE 802.11a 5785MHz

6dB Bandwidth

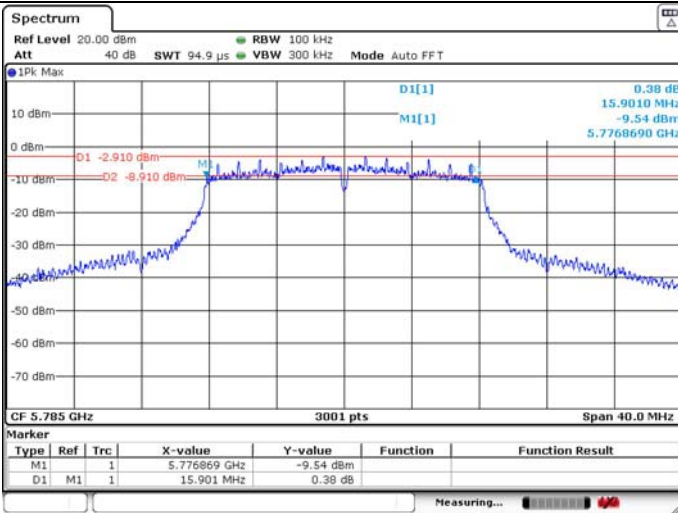

99% Occupied Bandwidth



### U-NII-3 IEEE 802.11a 5825MHz

6dB Bandwidth

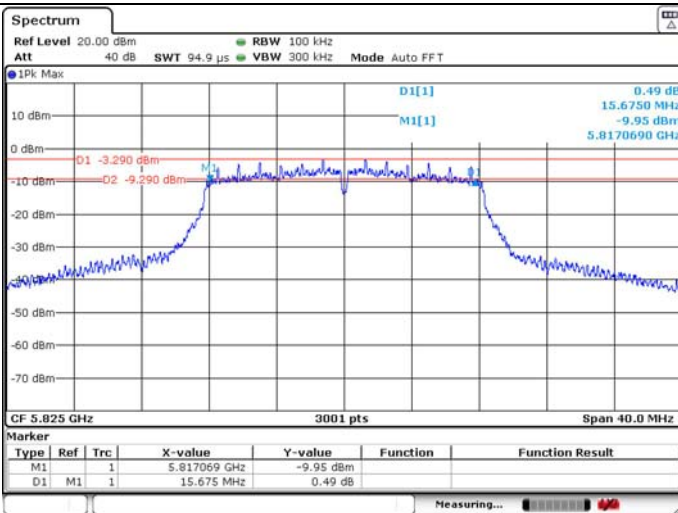

99% Occupied Bandwidth

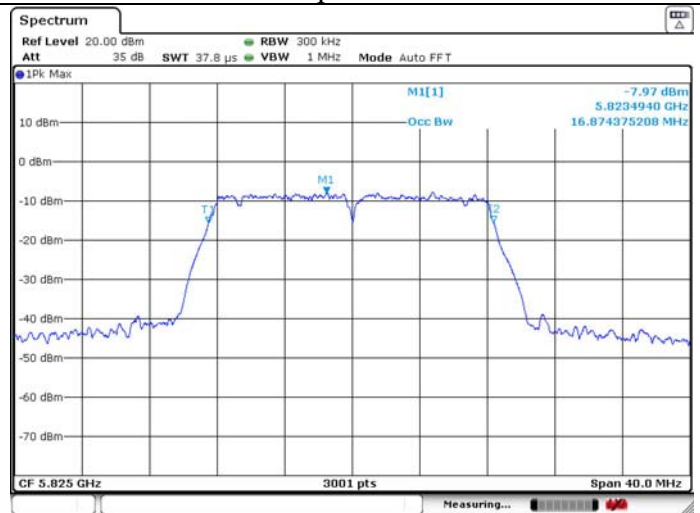

### U-NII-3 IEEE 802.11n HT20 5745MHz

6dB Bandwidth

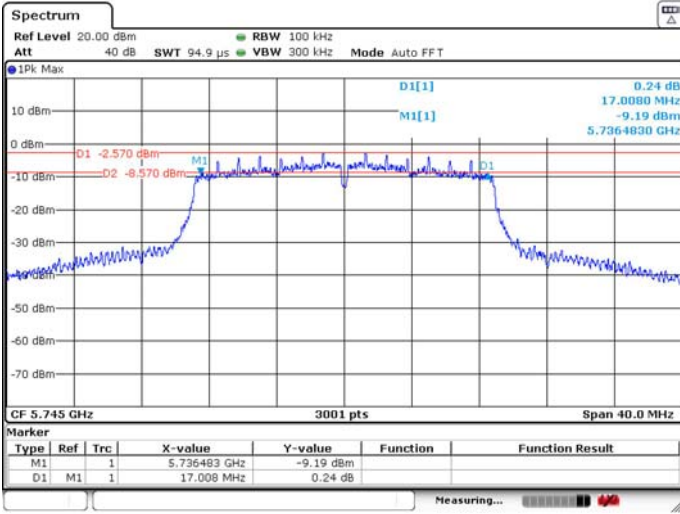

99% Occupied Bandwidth

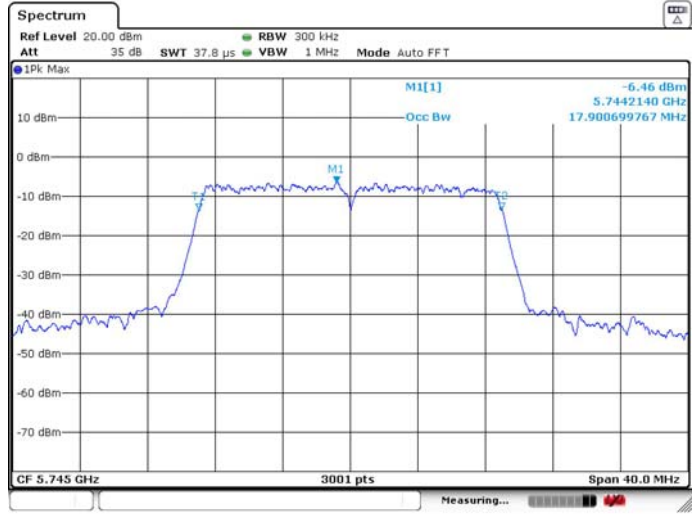

### U-NII-3 IEEE 802.11n HT20 5785MHz

6dB Bandwidth

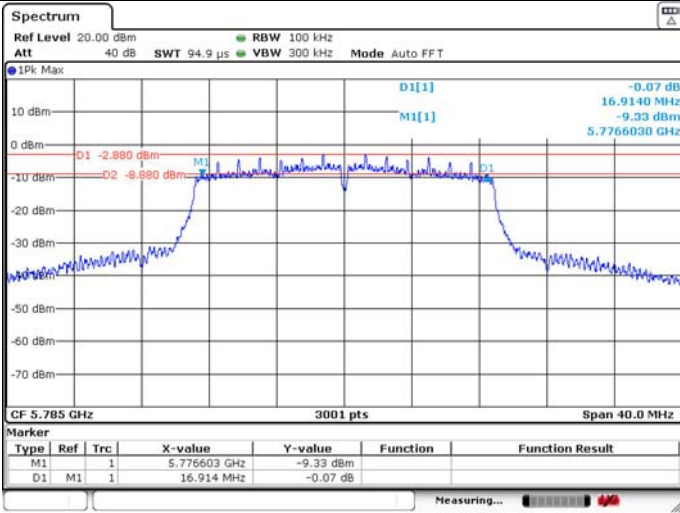

99% Occupied Bandwidth

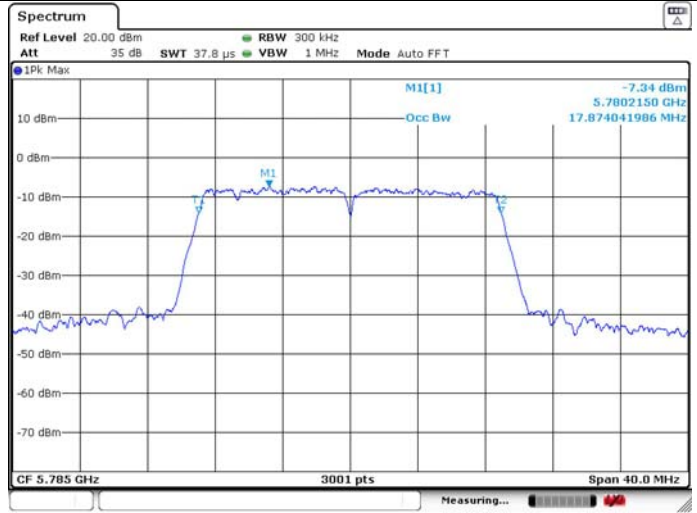

### U-NII-3 IEEE 802.11n HT20 5825MHz

6dB Bandwidth

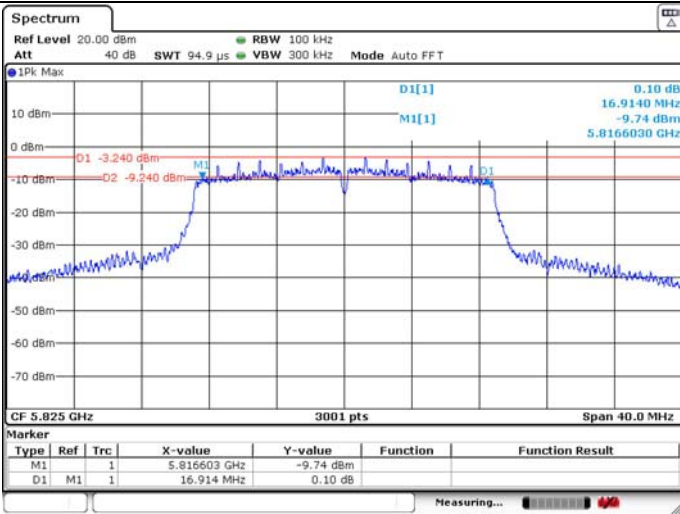

99% Occupied Bandwidth

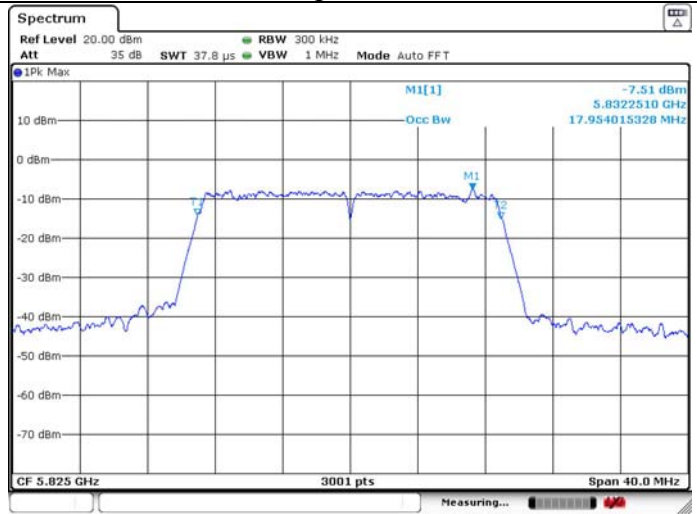

### U-NII-3 IEEE 802.11n HT40 5755MHz

**6dB Bandwidth**

**99% Occupied Bandwidth**

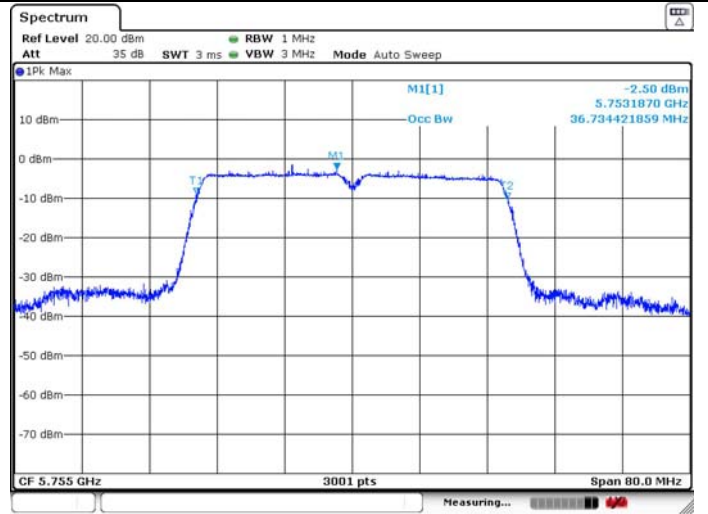
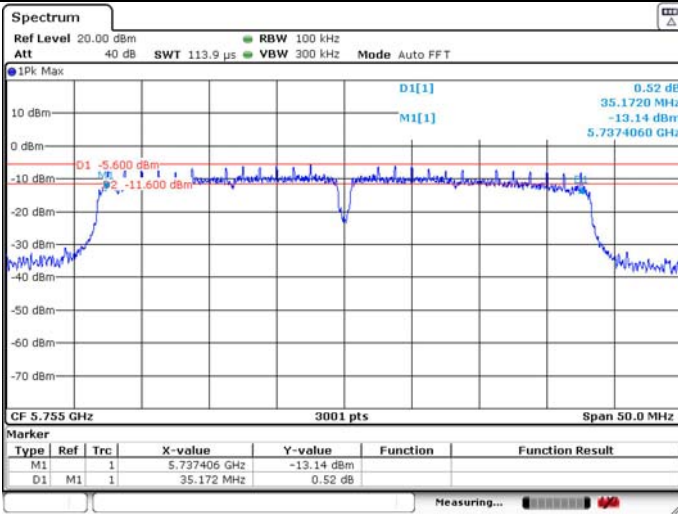

### U-NII-3 IEEE 802.11n HT40 5795MHz

**6dB Bandwidth**

**99% Occupied Bandwidth**

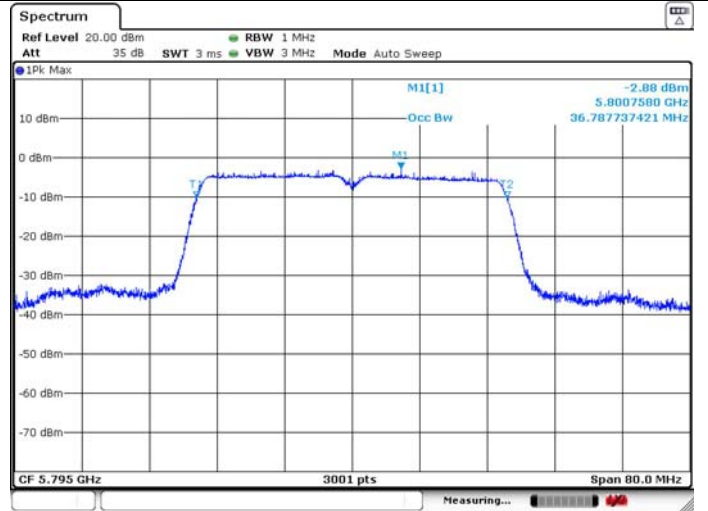
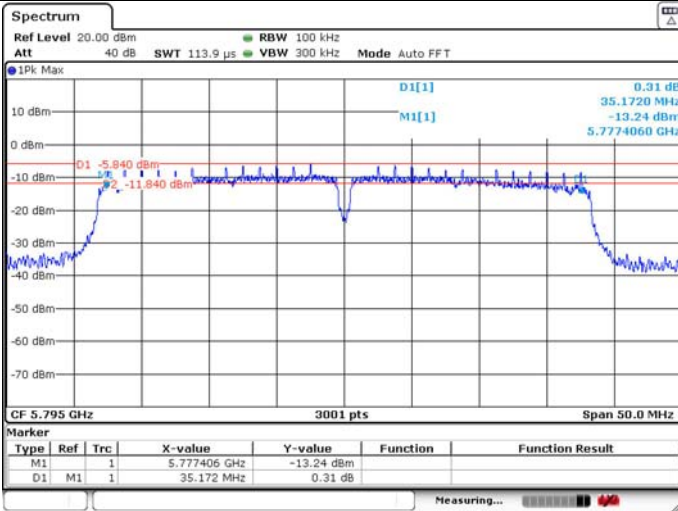



## 4. MAXIMUM CONDUCTED OUTPUT POWER

### 4.1. Limit

Band	EUT Type	Limit
U-NII-1	Outdoor Access Point	1W(30dBm) (Max. e.i.r.p $\leq$ 125mW at any elevation angle above 30 degrees as measured from the horizon)
	Indoor Access Point	1W(30dBm)
	Fixed point-to-point Access Point	1W(30dBm)
	Mobile and Portable Client Device	250mW(23.98dBm)
U-NII-2A	All Device	250mW(23.98dBm) or 11dBm+10 log B, Which is lesser. (B is 26dB Bandwidth in MHz)
U-NII-2C	All Device	250mW(23.98dBm) or 11dBm+10 log B, Which is lesser. (B is 26dB Bandwidth in MHz)
U-NII-3	All Device	1W(30dBm)

Note:

For the Band U-NII-2A and U-NII-2C, the maximum conducted output power limit calculate result refer to section 3.5.

### 4.2. Test Setup

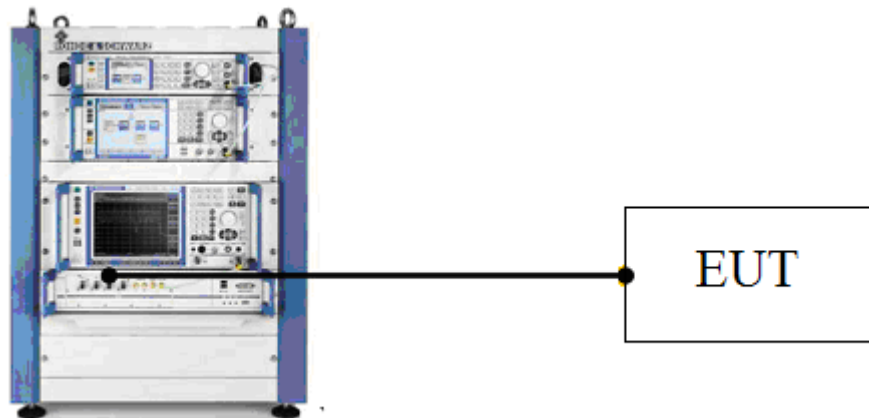

### 4.3. Test Procedure

- a. Connect EUT antenna terminal to the OSP-B157WB with RF cable.
- b. Set the EUT transmit continuously with maximum output power.
- c. Through the test software in TS 8897 to control a wideband gated RF power meter provided that the gate parameters are adjusted such that the power is measured only when the EUT is transmitting at its maximum power control level. Because the measurement is made only during the ON time of the transmitter, no duty cycle correction factor is required.
- d. Repeat above procedures until all modes and channels were measured.
- e. Record the results in the test report.

## 4.4. Test Result

Temperature	26°C	Relative Humidity		47%	Test Voltage	120V/60Hz
BAND	Test Mode	Frequency (MHz)	Conducted AVG Output Power (dBm)	Conducted AVG Output Power (W)	Limit (dBm)	Result
U-NII-1	IEEE 802.11a	5180	13.10	0.0204	23.98	PASS
		5200	12.37	0.0172	23.98	PASS
		5240	12.12	0.0163	23.98	PASS
	IEEE 802.11n HT20	5180	13.11	0.0205	23.98	PASS
		5200	12.42	0.0175	23.98	PASS
		5240	12.16	0.0164	23.98	PASS
	IEEE 802.11n HT40	5190	12.89	0.0194	23.98	PASS
5230		12.09	0.0162	23.98	PASS	
U-NII-2A	IEEE 802.11a	5260	13.04	0.0202	23.98	PASS
		5300	11.98	0.0158	23.98	PASS
		5320	11.50	0.0141	23.98	PASS
	IEEE 802.11n HT20	5260	13.11	0.0205	23.98	PASS
		5300	12.20	0.0166	23.98	PASS
		5320	11.53	0.0142	23.98	PASS
	IEEE 802.11n HT40	5270	13.06	0.0202	23.98	PASS
		5310	10.86	0.0122	23.98	PASS

BAND	Test Mode	Frequency (MHz)	Conducted AVG Output Power (dBm)	Conducted AVG Output Power (W)	Limit (dBm)	Result
U-NII-2C	IEEE 802.11a	5500	10.10	0.0102	23.98	PASS
		5580	10.86	0.0122	23.98	PASS
		5700	10.09	0.0102	23.98	PASS
	IEEE 802.11n HT20	5500	10.15	0.0104	23.98	PASS
		5580	10.95	0.0124	23.98	PASS
		5700	10.15	0.0103	23.98	PASS
	IEEE 802.11n HT40	5510	9.14	0.0082	23.98	PASS
5670		11.44	0.0139	23.98	PASS	
U-NII-3	IEEE 802.11a	5745	10.37	0.0109	30.00	PASS
		5785	10.75	0.0119	30.00	PASS
		5825	10.25	0.0106	30.00	PASS
	IEEE 802.11n HT20	5745	10.43	0.0110	30.00	PASS
		5785	10.78	0.0120	30.00	PASS
		5825	10.24	0.0106	30.00	PASS
	IEEE 802.11n HT40	5755	11.08	0.0128	30.00	PASS
		5795	9.66	0.0092	30.00	PASS

## 5. PEAK POWER SPECTRAL DENSITY

### 5.1. Limit

Band	EUT Type	Limit
U-NII-1	Outdoor Access Point	17dBm/MHz
	Indoor Access Point	17dBm/MHz
	Fixed point-to-point Access Point	17dBm/MHz
	Mobile and Portable Client Device	11dBm/MHz
U-NII-2A	All Device	11dBm/MHz
U-NII-2C	All Device	11dBm/MHz
U-NII-3	All Device	30dBm/500KHz

### 5.2. Test Setup



### 5.3. Spectrum Analyzer Setting

Spectrum Parameters	Setting
RBW	1MHz(For U-NII-1&U-NII-2A&U-NII-2C) 500KHz(For U-NII-3)
VBW	3MHz(For U-NII-1&U-NII-2A&U-NII-2C) 2MHz(For U-NII-3)
Span	encompass the entire 26 dB EBW or 99% OBW of the signal
Sweep Time	Auto
Number of Sweep Point	$\geq 2 \times \text{SPAN}/\text{RBW}$
Detector	RMS(power averaging)
Trace Average	$\geq 100$ traces

### 5.4. Test Procedure

- a. Connect EUT antenna terminal to the spectrum analyzer with RF cable.
- b. Spectrum analyzer setting parameters in accordance with section 5.3.
- c. Set the EUT transmit continuously with maximum output power.
- d. Allow trace to stabilize, use the marker-to-peak function to set the marker to the average of the emission.
- e. If the duty cycle of test signal  $< 98\%$ , the result = max measured value +  $10 \times \log(1/\text{duty cycle})$ ;  
If the duty cycle of test signal  $\geq 98\%$ , the result = max measured value.
- f. Repeat above procedures until all modes and channels were measured.
- g. Record the results in the test report.

### 5.5. Test Result

Temperature	25°C	Relative Humidity	60%	Test Voltage	120V/60Hz
-------------	------	-------------------	-----	--------------	-----------

BAND	Test Mode	Fre (MHz)	Power Density (dBm/MHz)	Duty Factor (dB)	Total Power Density (dBm/MHz)	Limit (dBm/MHz)	Result
U-NII-1	IEEE 802.11a	5180	0.81	0.43	1.24	11.00	PASS
		5200	1.52	0.43	1.95	11.00	PASS
		5240	0.83	0.43	1.26	11.00	PASS
	IEEE 802.11n HT20	5180	0.96	0.47	1.43	11.00	PASS
		5200	0.56	0.47	1.03	11.00	PASS
		5240	0.63	0.47	1.10	11.00	PASS
	IEEE 802.11n HT40	5190	-2.03	0.88	-1.15	11.00	PASS
5230		-2.50	0.88	-1.62	11.00	PASS	
U-NII-2A	IEEE 802.11a	5260	0.09	0.43	0.52	11.00	PASS
		5300	-0.35	0.43	0.08	11.00	PASS
		5320	-0.49	0.43	-0.06	11.00	PASS
	IEEE 802.11n HT20	5260	0.09	0.47	0.56	11.00	PASS
		5300	-0.67	0.47	-0.20	11.00	PASS
		5320	-0.84	0.47	-0.37	11.00	PASS
	IEEE 802.11n HT40	5270	-2.81	0.88	-1.93	11.00	PASS
5310		-2.92	0.88	-2.04	11.00	PASS	
U-NII-2C	IEEE 802.11a	5500	-0.54	0.43	-0.11	11.00	PASS
		5580	1.19	0.43	1.62	11.00	PASS
		5700	1.28	0.43	1.71	11.00	PASS
	IEEE 802.11n HT20	5500	-0.96	0.47	-0.49	11.00	PASS
		5580	1.67	0.47	2.14	11.00	PASS
		5700	1.17	0.47	1.64	11.00	PASS
	IEEE 802.11n HT40	5510	-3.46	0.88	-2.58	11.00	PASS
		5590	-2.33	0.88	-1.45	11.00	PASS
5670		-0.41	0.88	0.47	11.00	PASS	

BAND	Test Mode	Fre (MHz)	Power Density (dBm/500KHz)	Duty Factor (dB)	Total Power Density (dBm/500KHz)	Limit (dBm/500KHz)	Result
U-NII-3	IEEE 802.11a	5745	-2.10	0.43	-1.67	30.00	PASS
		5785	-2.64	0.43	-2.21	30.00	PASS
		5825	-3.90	0.43	-3.47	30.00	PASS
	IEEE 802.11n HT20	5745	-2.36	0.47	-1.89	30.00	PASS
		5785	-2.72	0.47	-2.25	30.00	PASS
		5825	-4.02	0.47	-3.55	30.00	PASS
	IEEE 802.11n HT40	5755	-5.42	0.88	-4.54	30.00	PASS
		5795	-5.55	0.88	-4.67	30.00	PASS

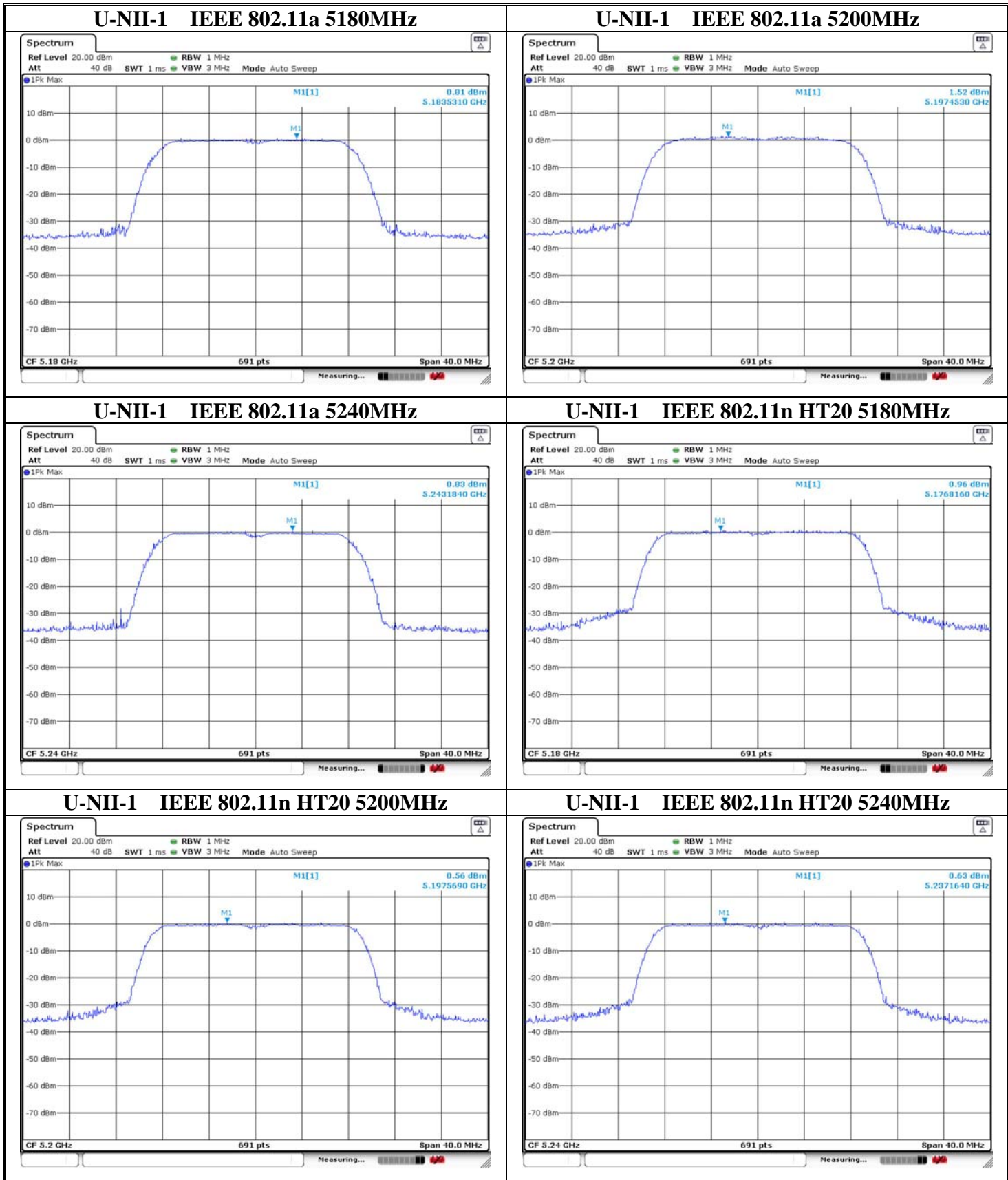

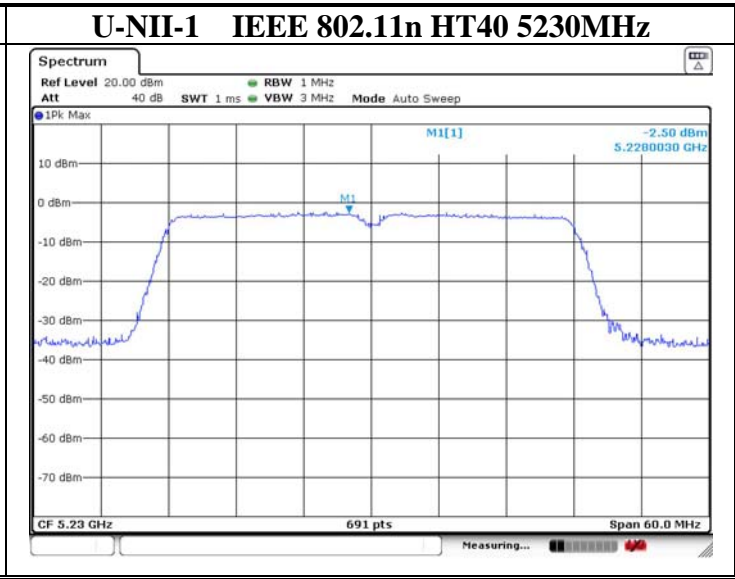
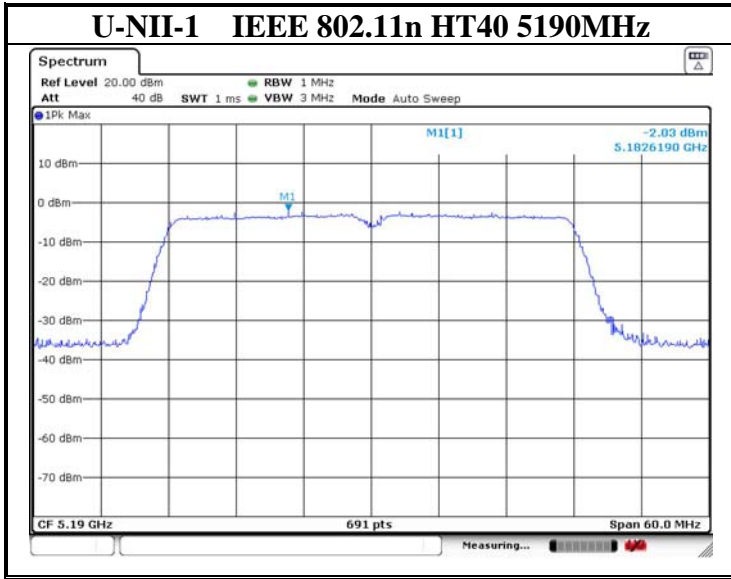

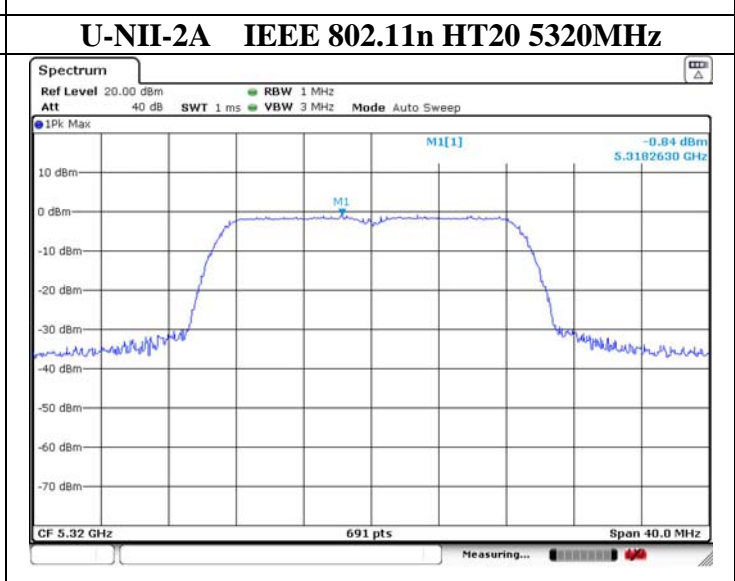
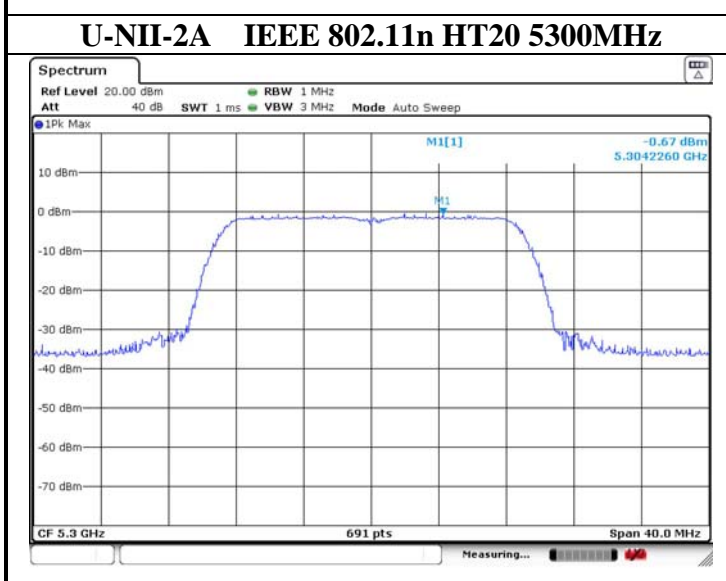
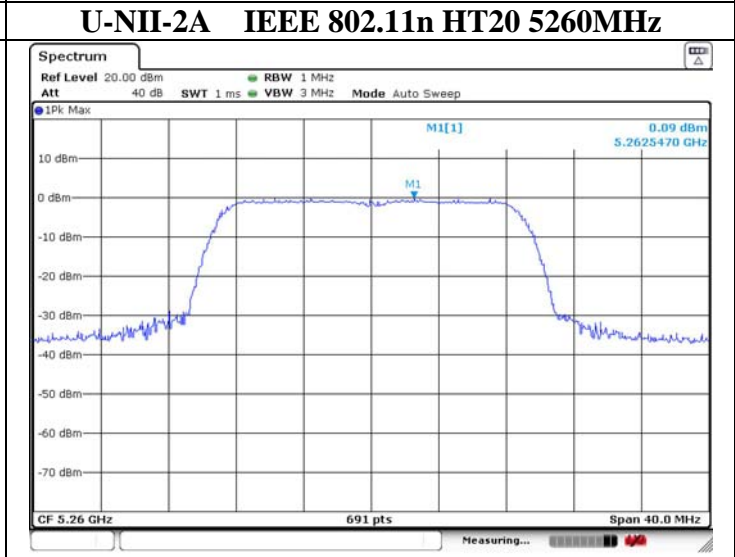
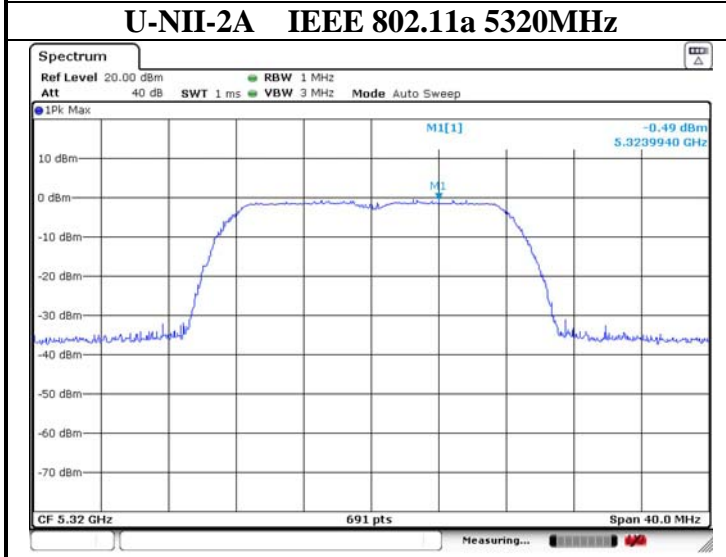
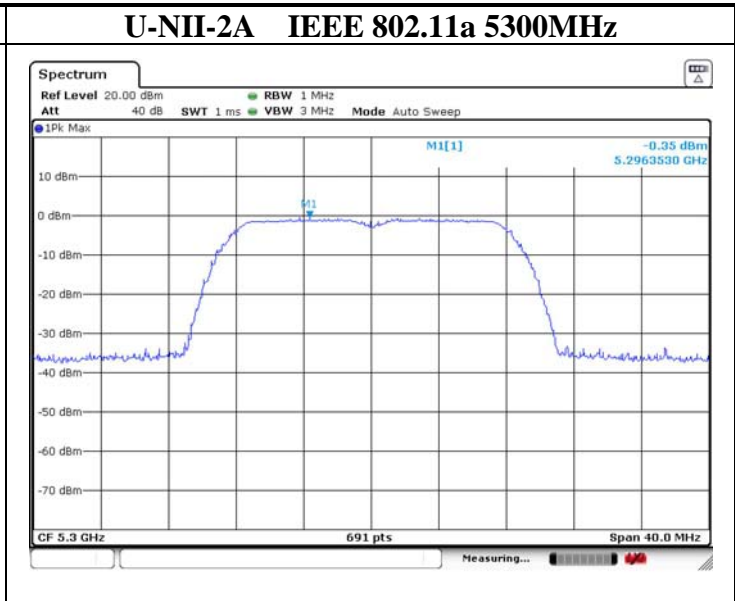
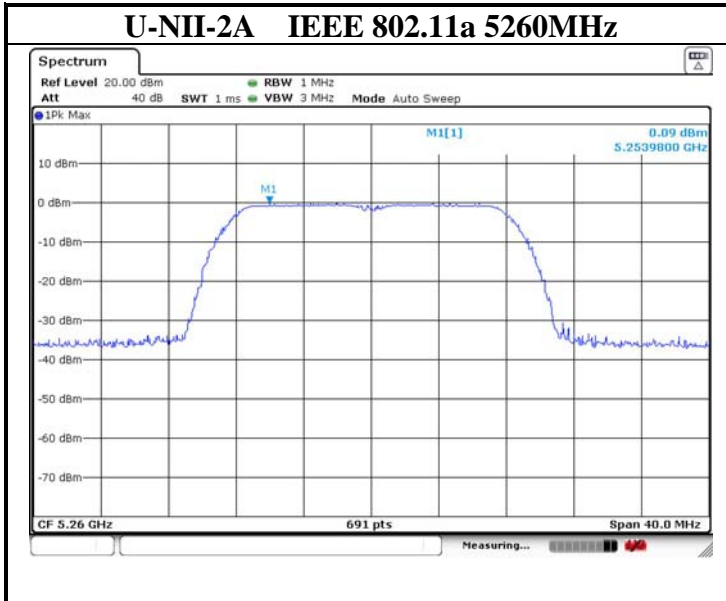

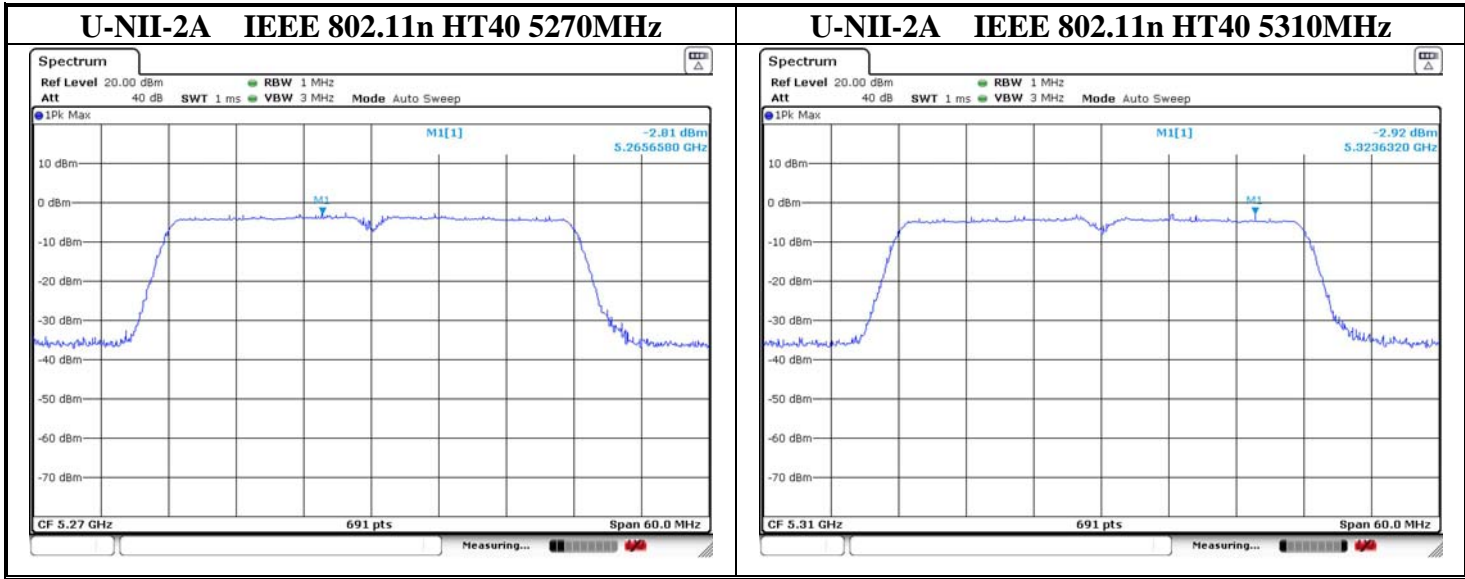



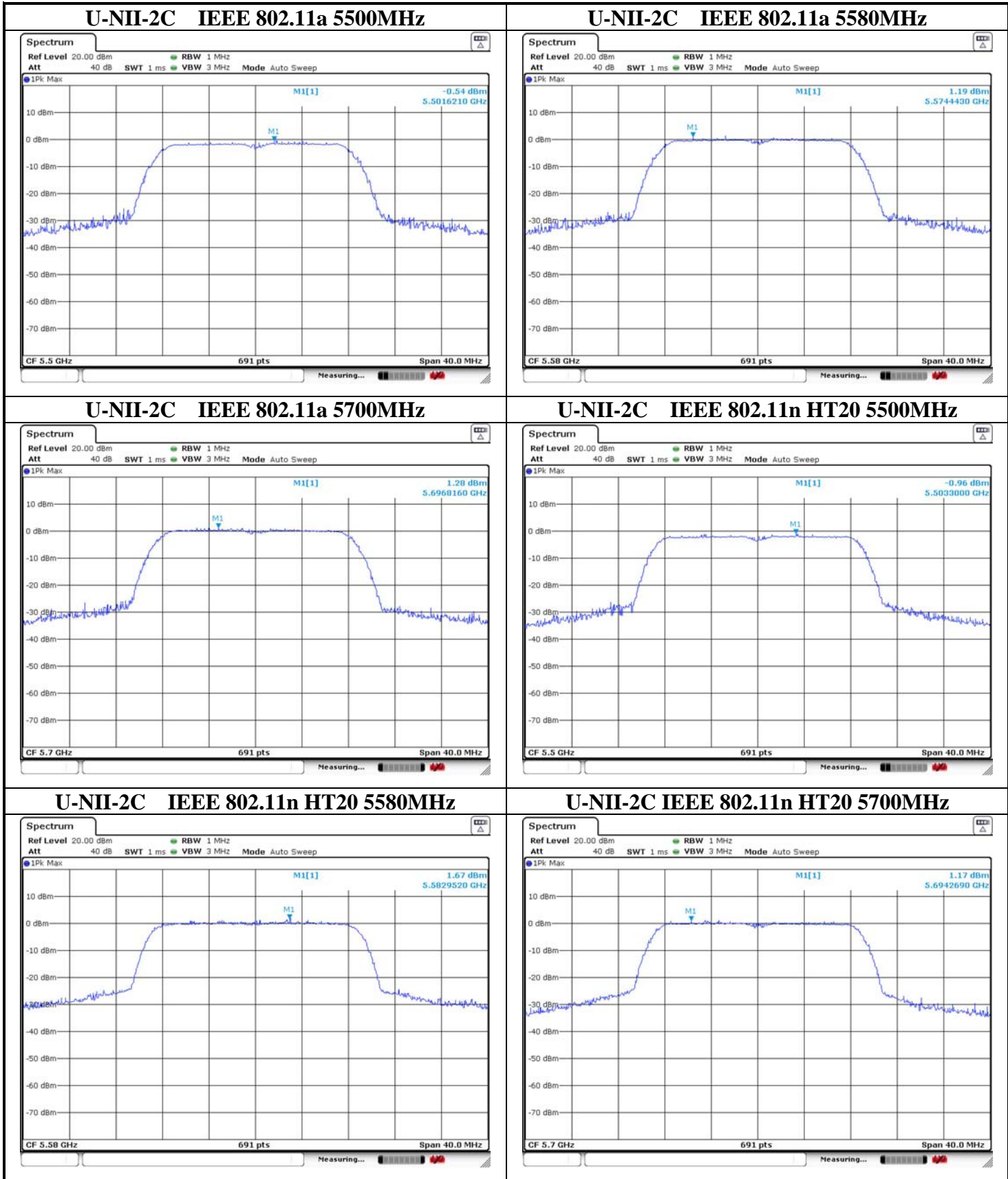

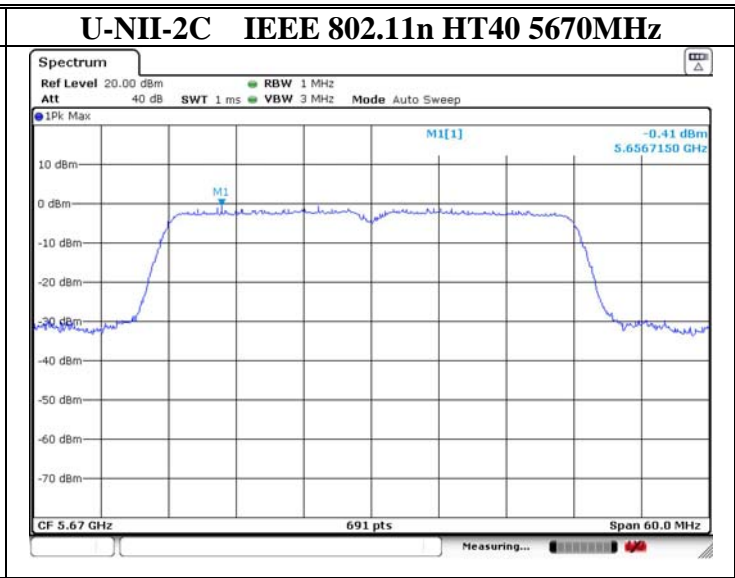
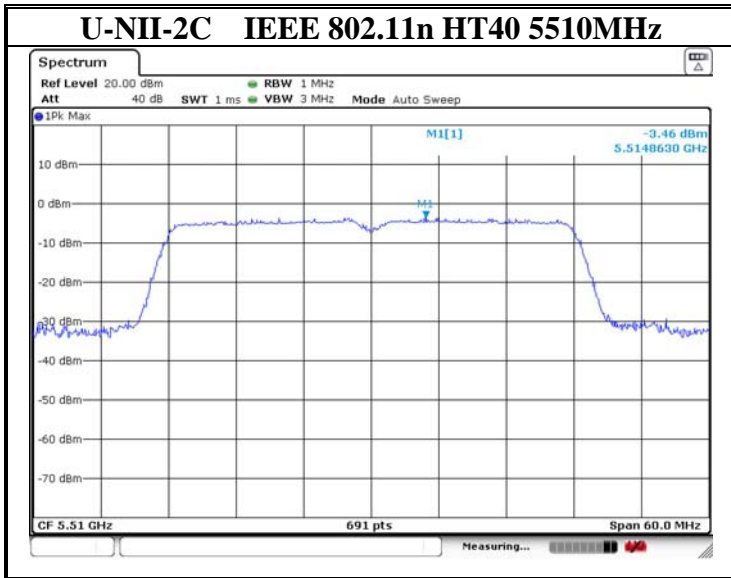

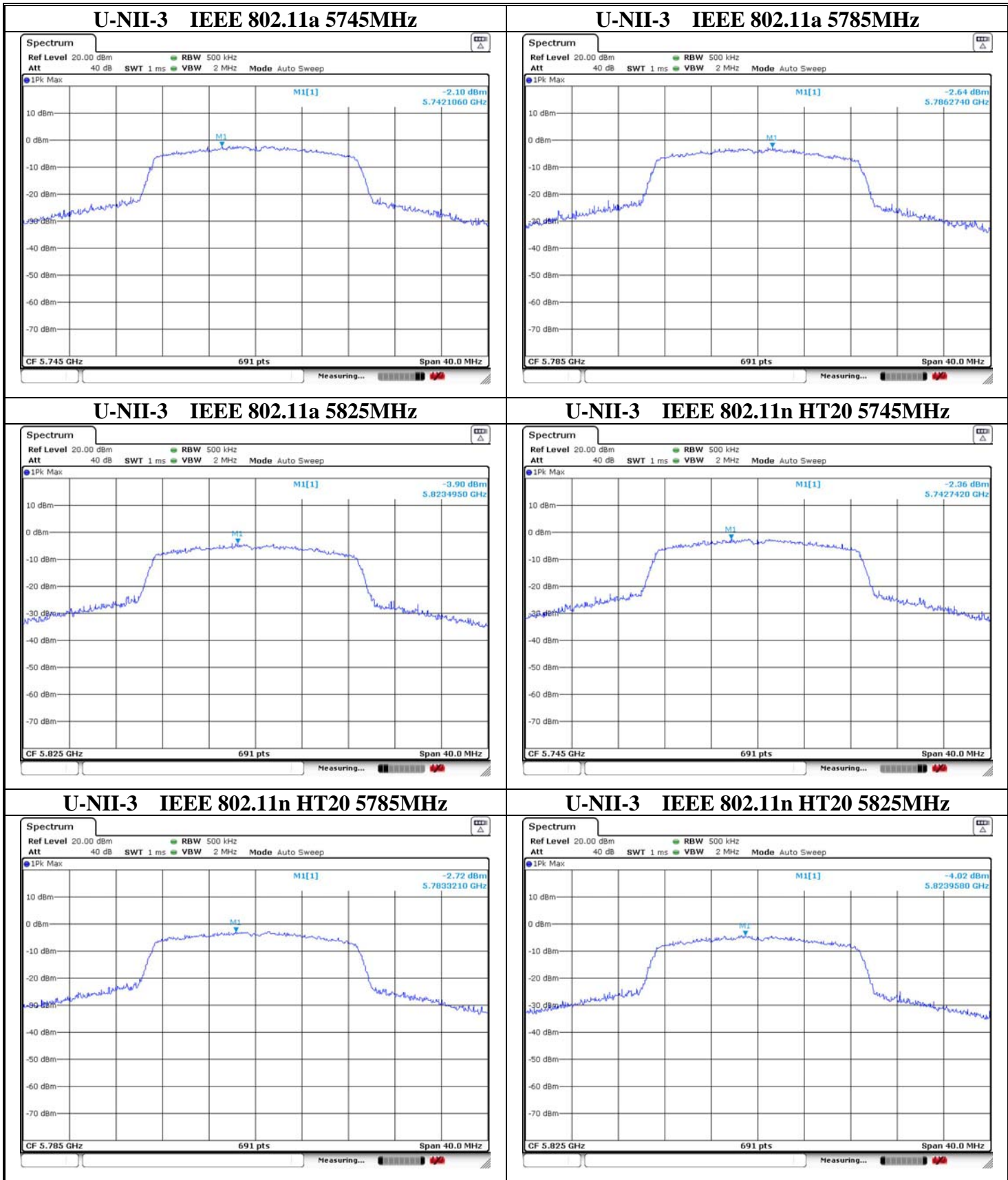

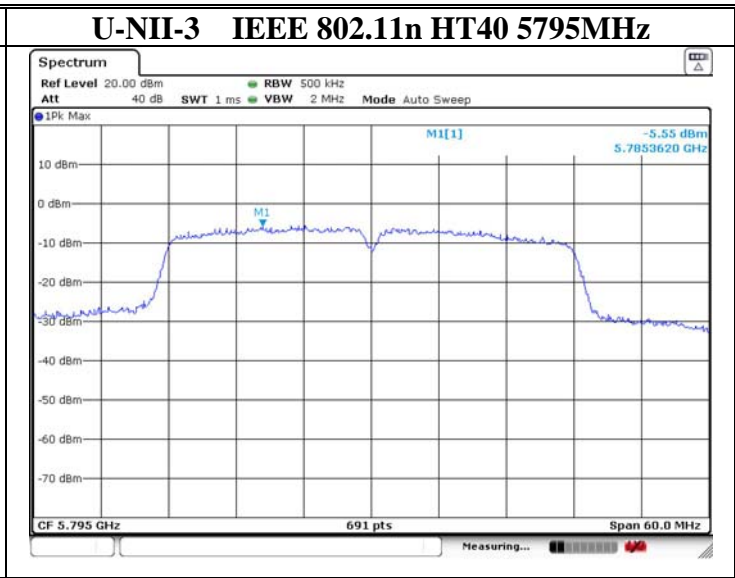
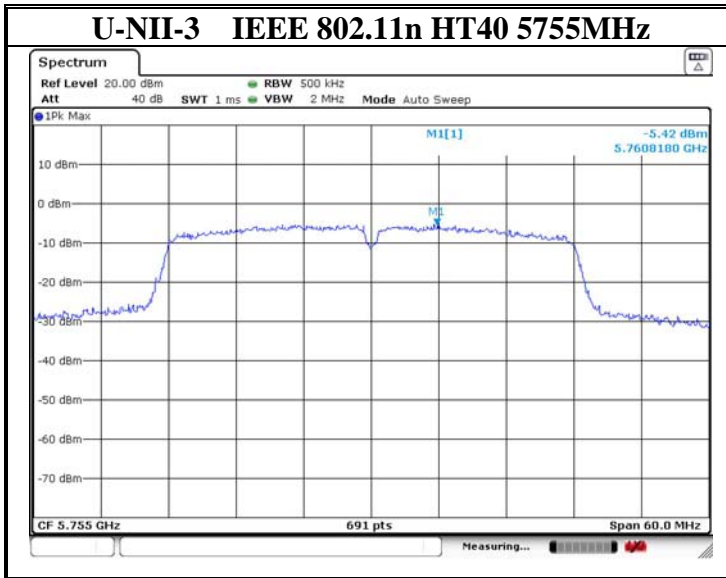

## 6. UNWANTED EMISSIONS AND BAND EDGE

### 6.1. Limit

The maximum emissions outside of the frequency bands of operation shall be attenuated in accordance with the following limits:

- (1) For transmitters operating in the 5.15-5.25 GHz band: All emissions outside of the 5.15-5.35 GHz band shall not exceed an e.i.r.p. of -27 dBm/MHz.
- (2) For transmitters operating in the 5.25-5.35 GHz band: All emissions outside of the 5.15-5.35 GHz band shall not exceed an e.i.r.p. of -27 dBm/MHz.
- (3) For transmitters operating in the 5.47-5.725 GHz band: All emissions outside of the 5.47-5.725 GHz band shall not exceed an e.i.r.p. of -27 dBm/MHz.
- (4) For transmitters operating in the 5.725-5.85 GHz band: All emissions shall be limited to a level of -27 dBm/MHz at 75 MHz or more above or below the band edge increasing linearly to 10 dBm/MHz at 25 MHz above or below the band edge, and from 25 MHz above or below the band edge increasing linearly to a level of 15.6 dBm/MHz at 5 MHz above or below the band edge, and from 5 MHz above or below the band edge increasing linearly to a level of 27 dBm/MHz at the band edge.

The unwanted emissions which fall in Restricted bands shall not exceed the field strength levels specified in the following table:

15.209 Radiated emission limits

Frequency (MHz)	Field Strength(μV/m)	Distance(m)
0.009-0.490	2400/F(kHz)	300
0.490-1.705	24000/F(kHz)	30
1.705-30	30	30
30-88	100	3
88-216	150	3
216-960	200	3
Above 960	500	3

15.205 Restricted frequency band

MHz	MHz	MHz	GHz
0.090 - 0.110	16.42 - 16.423	399.9 - 410	4.5 - 5.15
<sup>1</sup> 0.495 - 0.505	16.69475 - 16.69525	608 - 614	5.35 - 5.46
2.1735 - 2.1905	16.80425 - 16.80475	960 - 1240	7.25 - 7.75
4.125 - 4.128	25.5 - 25.67	1300 - 1427	8.025 - 8.5
4.17725 - 4.17775	37.5 - 38.25	1435 - 1626.5	9.0 - 9.2
4.20725 - 4.20775	73 - 74.6	1645.5 - 1646.5	9.3 - 9.5
6.215 - 6.218	74.8 - 75.2	1660 - 1710	10.6 - 12.7
6.26775 - 6.26825	108 - 121.94	1718.8 - 1722.2	13.25 - 13.4
6.31175 - 6.31225	123 - 138	2200 - 2300	14.47 - 14.5
8.291 - 8.294	149.9 - 150.05	2310 - 2390	15.35 - 16.2
8.362 - 8.366	156.52475 - 156.52525	2483.5 - 2500	17.7 - 21.4
8.37625 - 8.38675	156.7 - 156.9	2690 - 2900	22.01 - 23.12
8.41425 - 8.41475	162.0125 - 167.17	3260 - 3267	23.6 - 24.0
12.29 - 12.293	167.72 - 173.2	3332 - 3339	31.2 - 31.8
12.51975 - 12.52025	240 - 285	3345.8 - 3358	36.43 - 36.5
12.57675 - 12.57725	322 - 335.4	3600 - 4400	( <sup>2</sup> )

Note:

1.  $\text{dB}\mu\text{V}/\text{m} = 20\text{Log}(\mu\text{V}/\text{m})$
2. Above 1GHz the formula is used to convert the EIRP to field strength  

$$E[\text{dB}\mu\text{V}/\text{m}] = \text{EIRP}[\text{dBm}] - 20 \log (d[\text{m}]) + 104.77,$$
 where E is field strength and d is distance at which the field strength limit is specified in the applicable requirements.  
 for example, 3m field strength  $(\text{dB}\mu\text{V}/\text{m}) = \text{EIRP} - 20\text{log}(3) + 104.77 = \text{EIRP} + 95.2$

6.2. Test Setup

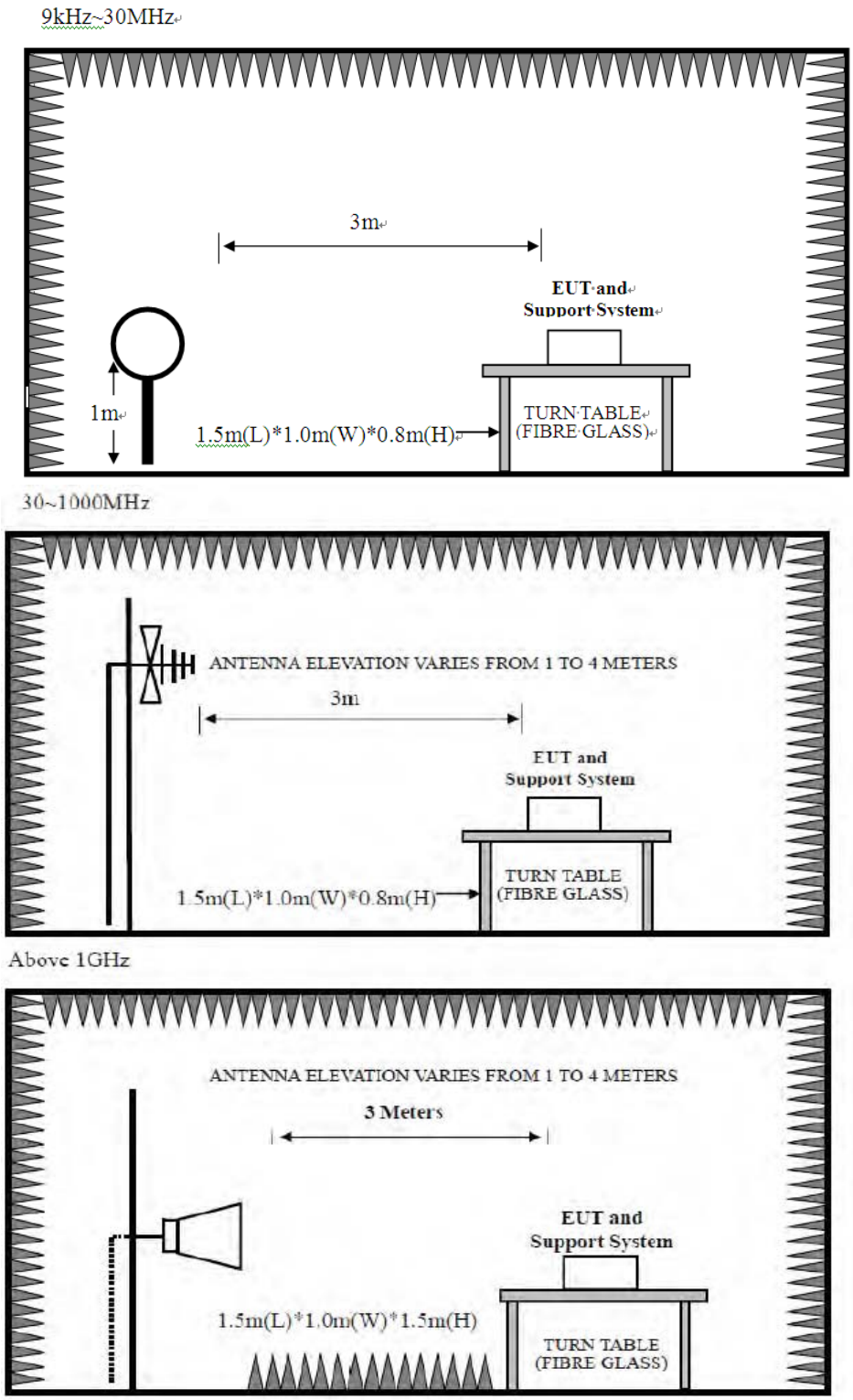



### 6.3. Spectrum Analyzer Setting

For 9KHz-150KHz

Spectrum Parameters	Setting
RBW	300Hz(for Peak&AVG)/CISPR 200Hz(for QP)
VBW	300Hz(for Peak&AVG)/CISPR 200Hz(for QP)
Start frequency	9KHz
Stop frequency	150KHz
Sweep Time	Auto
Detector	PEAK/QP/AVG
Trace Mode	Max Hold

Note : For 9KHz-90KHz&110KHz-150KHz,the detector is average,other frequency is CISPR QP detector.

For 150KHz-30MHz

Spectrum Parameters	Setting
RBW	9KHz
VBW	9KHz
Start frequency	150KHz
Stop frequency	30MHz
Sweep Time	Auto
Detector	QP
Trace Mode	Max Hold

Note : For 150KHz-490KHz,the detector is average,other frequency is CISPR QP detector.

For 30MHz-1GHz

Spectrum Parameters	Setting
RBW	120KHz
VBW	300KHz
Start frequency	30MHz
Stop frequency	1GHz
Sweep Time	Auto
Detector	QP
Trace Mode	Max Hold

For Above 1GHz

Spectrum Parameters	Setting
RBW	1MHz
VBW	PEAK Measurement
	AVG Measurement Duty cycle $\geq 98\%$ , VBW=10Hz Duty cycle $< 98\%$ , VBW $\geq 1/T$ Video bandwidth mode=RMS (power averaging)
Start frequency	1GHz
Stop frequency	40GHz
Sweep Time	Auto
Detector	PEAK
Trace Mode	Max Hold

Note : T is the on-time time of the duty cycle,when EUT transmit continuously with maximum output power,unit is seconds. reference section 2.7 for the on-time time.

## 6.4. Test Procedure

- a. EUT was placed on a turn table, which is 0.8 meter high above ground for below 1GHz test, and which is 1.5 meter high above ground for above 1GHz test.
- b. EUT is set 3 meters away from the receiving antenna, which is mounted on a antenna tower.
- c. Set the EUT transmit continuously with maximum output power.
- d. The turn table can rotate 360 degrees to determine the position of the maximum emission level.
- e. The antenna can be moved up and down between 1 meter and 4 meters to find out the maximum emission level. Both horizontal and vertical polarization of the antenna are set on test.
- f. Spectrum analyzer setting parameters in accordance with section 6.3.
- g. Repeat above procedures until all channels were measured.
- h. Record the results in the test report.

## 6.5. Test Result

### Radiated Emissions Below 1GHz

EST Technology

Chilingxiang, Qishantou, Santun,  
Houjie, Dongguan, Guangdong, China  
Tel: +86-769-83081888  
Fax: +86-769-83081878

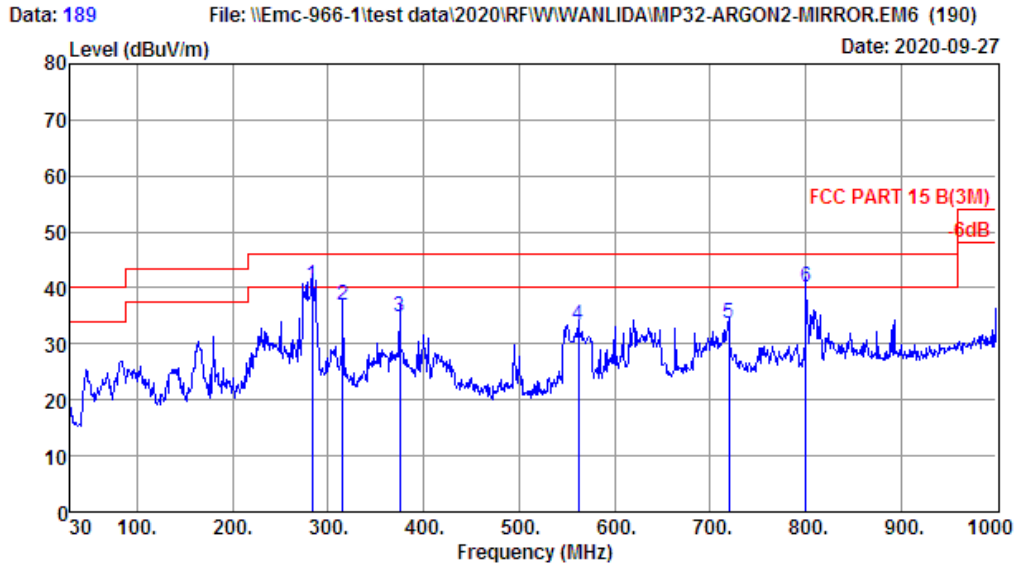

Site no. : 1# 966 Chamber Data no. : 189  
 Dis. / Ant. : 3m 37062 Ant. pol. : HORIZONTAL  
 Limit : FCC PART 15 B(3M)  
 Env. / Ins. : Temp:24.2';Humi:51%;Press:101.82kPa  
 Engineer : Pablo  
 EUT : Tablet  
 Power : DC 24V From Adapter Input AC 120V/60Hz  
 M/N : MP32-ARGON2-MIRROR  
 Test Mode : TX Mode

	Freq. (MHz)	ANT Factor (dB/m)	Cable Loss (dB)	Reading (dBuV)	Emission Level (dBuV/m)	Limit (dBuV/m)	Margin (dB)	Remark
1	283.17	12.88	1.78	25.80	40.46	46.00	5.54	QP
2	315.18	13.85	1.91	21.27	37.03	46.00	8.97	QP
3	375.32	15.60	2.19	17.04	34.83	46.00	11.17	QP
4	562.53	19.83	2.87	10.54	33.24	46.00	12.76	QP
5	719.67	21.70	3.44	8.50	33.64	46.00	12.36	QP
6	800.18	22.90	3.58	13.52	40.00	46.00	6.00	QP

Remarks: 1. Emission Level= Antenna Factor + Cable Loss + Reading.  
 2. Margin= Limit - Emission Level.  
 3. The emission levels that are 20dB below the official limit are not reported.

Data: 190 File: \\Emc-966-1\test data\2020\RF\W\WANLIDA\MP32-ARGON2-MIRROR.EM6 (190) Date: 2020-09-27

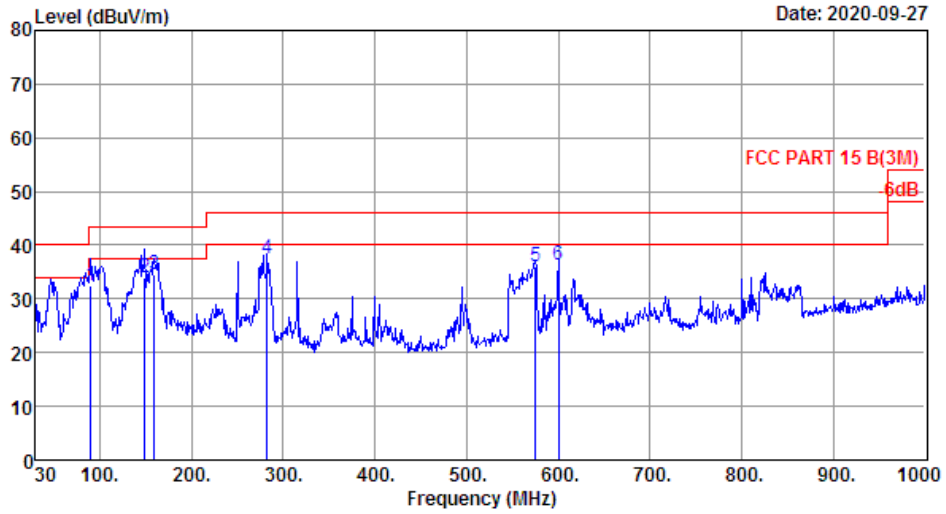

Site no. : 1# 966 Chamber Data no. : 190  
 Dis. / Ant. : 3m 37062 Ant. pol. : VERTICAL  
 Limit : FCC PART 15 B(3M)  
 Env. / Ins. : Temp:24.2';Humi:51%;Press:101.82kPa  
 Engineer : Pablo  
 EUT : Tablet  
 Power : DC 24V From Adapter Input AC 120V/60Hz  
 M/N : MP32-ARGON2-MIRROR  
 Test Mode : TX Mode

	Freq. (MHz)	ANT Factor (dB/m)	Cable Loss (dB)	Reading (dBuV)	Emission Level (dBuV/m)	Limit (dBuV/m)	Margin (dB)	Remark
1	90.14	9.30	0.79	22.50	32.59	43.50	10.91	QP
2	149.31	11.62	1.09	21.20	33.91	43.50	9.59	QP
3	159.01	11.30	1.14	22.02	34.46	43.50	9.04	QP
4	282.20	12.72	1.76	22.95	37.43	46.00	8.57	QP
5	575.14	19.95	2.90	13.19	36.04	46.00	9.96	QP
6	600.36	20.40	2.97	12.90	36.27	46.00	9.73	QP

Remarks: 1. Emission Level= Antenna Factor + Cable Loss + Reading.  
 2. Margin= Limit - Emission Level.  
 3. The emission levels that are 20dB below the official limit are not reported.

Note:

1. The amplitude of 9KHz to 30MHz spurious emission that is attenuated by more than 20dB below the permissible limit has no need to be reported.
2. All channels had been pre-test, only the worst case was reported.

### Radiated Emissions Above 1G

EST Technology

Chilingxiang, Qishantou, Santun,  
Houjie, Dongguan, Guangdong, China  
Tel: +86-769-83081888  
Fax: +86-769-83081878

Data: 75 File: \\Emc-966-1\test data\2020\RF\W\WANLIDA\MP32-ARGON2-MIRROR.EM6 (176) Date: 2020-09-15

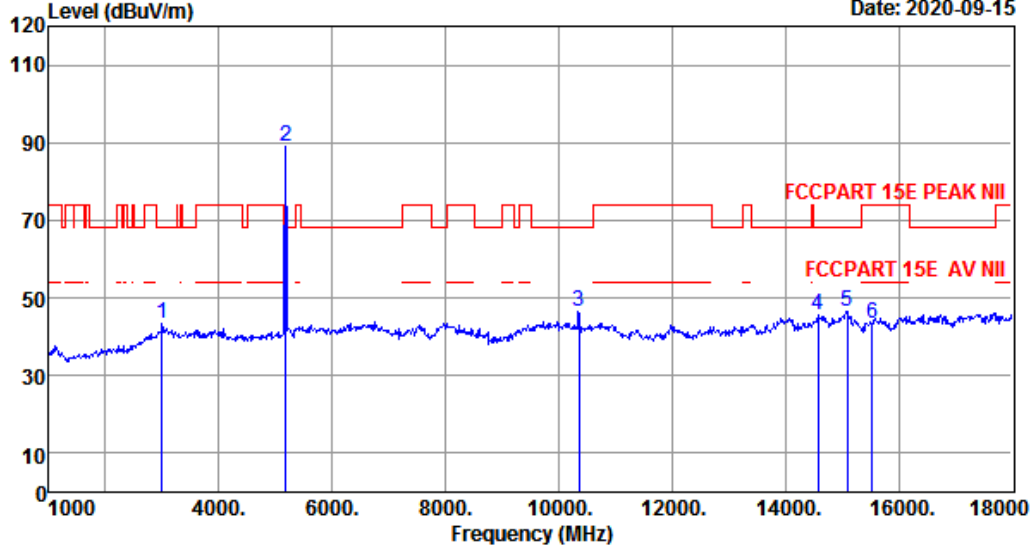

Site no. : 1# 966 Chamber Data no. : 75  
 Dis. / Ant. : 3m ANT9120D 1-18G Ant. pol. : HORIZONTAL  
 Limit : FCCPART 15E PEAK NII  
 Env. / Ins. : Temp:26.4';Humi:54%;Press:101.52kPa  
 Engineer : Pablo  
 EUT : Tablet  
 Power : DC 24V From Adapter Input AC 120V/60Hz  
 M/N : MP32-ARGON2-MIRROR  
 Test Mode : IEEE 802.11n HT20 TX 5180MHz

	Freq. (MHz)	Ant. Factor (dB/m)	Cable Loss (dB)	Amp Factor (dB)	Reading (dBuV)	Emission Level (dBuV/m)	Limits (dBuV/m)	Margin (dB)	Remark
1	2989.00	28.56	2.17	34.41	47.01	43.33	68.20	24.87	Peak
2	5180.00	32.20	3.52	34.63	87.77	88.86	68.20	-20.66	Peak
3	10360.00	39.27	5.99	34.31	35.38	46.33	68.20	21.87	Peak
4	14583.00	40.98	6.89	34.47	32.16	45.56	68.20	22.64	Peak
5	15093.00	40.81	6.74	34.57	33.63	46.61	68.20	21.59	Peak
6	15540.00	40.31	6.46	34.39	30.86	43.24	74.00	30.76	Peak

Remarks: 1. Emission Level= Antenna Factor + Cable Loss - Amp Factor + Reading.  
 2. Margin= Limit - Emission Level.  
 3. The emission levels that are 20dB below the official limit are not reported.

Data: 76 File: \\Emc-966-1\test data\2020\RF\W\WANLIDA\MP32-ARGON2-MIRROR.EM6 (176) Date: 2020-09-15

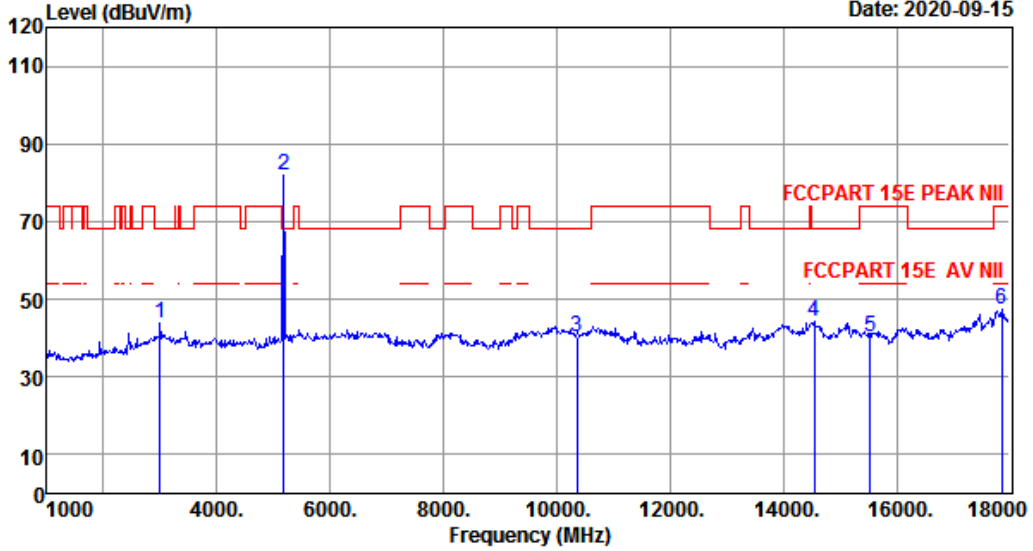

Site no. : 1# 966 Chamber Data no. : 76  
 Dis. / Ant. : 3m ANT9120D 1-18G Ant. pol. : VERTICAL  
 Limit : FCCPART 15E PEAK NII  
 Env. / Ins. : Temp:26.4';Humi:54%;Press:101.52kPa  
 Engineer : Pablo  
 EUT : Tablet  
 Power : DC 24V From Adapter Input AC 120V/60Hz  
 M/N : MP32-ARGON2-MIRROR  
 Test Mode : IEEE 802.11n HT20 TX 5180MHz

	Freq. (MHz)	Ant. Factor (dB/m)	Cable Loss (dB)	Amp Factor (dB)	Reading (dBuV)	Emission Level (dBuV/m)	Limits (dBuV/m)	Margin (dB)	Remark
1	2989.00	28.56	2.17	34.41	47.51	43.83	68.20	24.37	Peak
2	5180.00	32.20	3.52	34.63	80.80	81.89	68.20	-13.69	Peak
3	10360.00	39.27	5.99	34.31	29.56	40.51	68.20	27.69	Peak
4	14549.00	40.99	6.89	34.46	31.03	44.45	68.20	23.75	Peak
5	15540.00	40.31	6.46	34.39	27.83	40.21	74.00	33.79	Peak
6	17864.00	47.82	8.15	34.31	25.81	47.47	74.00	26.53	Peak

Remarks: 1. Emission Level= Antenna Factor + Cable Loss - Amp Factor + Reading.  
 2. Margin= Limit - Emission Level.  
 3. The emission levels that are 20dB below the official limit are not reported.

Data: 77 File: \\Emc-966-1\test data\2020\RF\W\WANLIDA\MP32-ARGON2-MIRROR.EM6 (176) Date: 2020-09-15

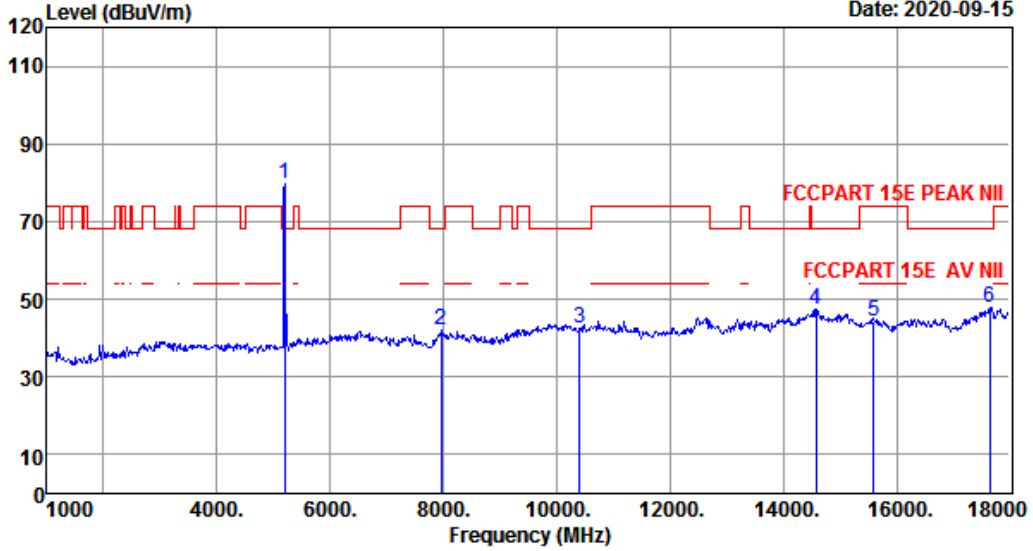

Site no. : 1# 966 Chamber Data no. : 77  
 Dis. / Ant. : 3m ANT9120D 1-18G Ant. pol. : VERTICAL  
 Limit : FCCPART 15E PEAK NII  
 Env. / Ins. : Temp:26.4';Humi:54%;Press:101.52kPa  
 Engineer : Pablo  
 EUT : Tablet  
 Power : DC 24V From Adapter Input AC 120V/60Hz  
 M/N : MP32-ARGON2-MIRROR  
 Test Mode : IEEE 802.11n HT20 TX 5200MHz

	Freq. (MHz)	Ant. Factor (dB/m)	Cable Loss (dB)	Amp Factor (dB)	Reading (dBuV)	Emission Level (dBuV/m)	Limits (dBuV/m)	Margin (dB)	Remark
1	5200.00	32.24	3.53	34.62	78.47	79.62	68.20	-11.42	Peak
2	7953.00	36.89	5.77	34.89	34.38	42.15	68.20	26.05	Peak
3	10400.00	39.31	5.99	34.32	31.72	42.70	68.20	25.50	Peak
4	14583.00	40.98	6.89	34.47	33.88	47.28	68.20	20.92	Peak
5	15600.00	40.24	6.53	34.36	31.88	44.29	74.00	29.71	Peak
6	17643.00	46.05	8.01	34.34	27.88	47.60	68.20	20.60	Peak

Remarks: 1. Emission Level= Antenna Factor + Cable Loss - Amp Factor + Reading.  
 2. Margin= Limit - Emission Level.  
 3. The emission levels that are 20dB below the official limit are not reported.



Data: 78 File: \\Emc-966-1\test data\2020\RF\W\WANLIDA\MP32-ARGON2-MIRROR.EM6 (176) Date: 2020-09-15

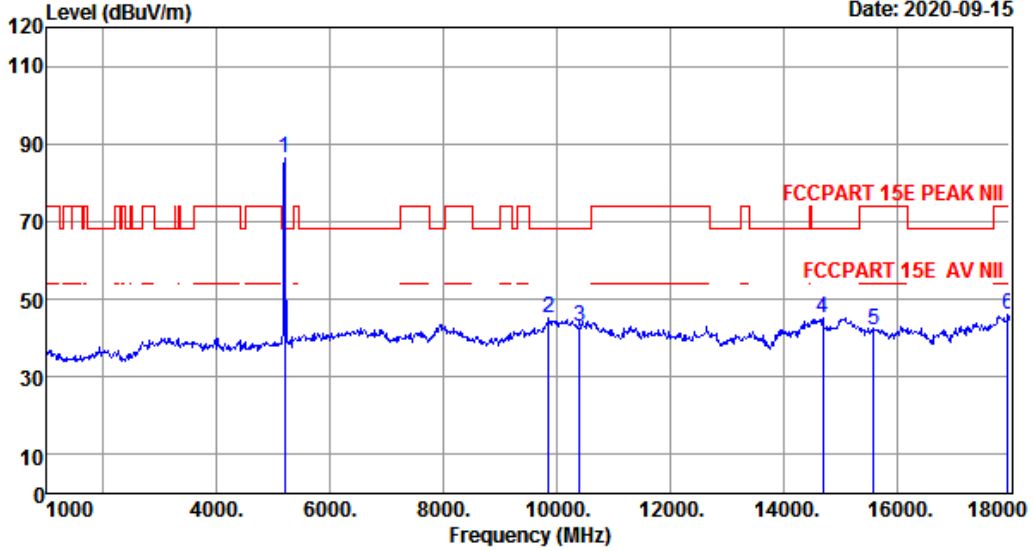

Site no. : 1# 966 Chamber Data no. : 78  
 Dis. / Ant. : 3m ANT9120D 1-18G Ant. pol. : HORIZONTAL  
 Limit : FCCPART 15E PEAK NII  
 Env. / Ins. : Temp:26.4';Humi:54%;Press:101.52kPa  
 Engineer : Pablo  
 EUT : Tablet  
 Power : DC 24V From Adapter Input AC 120V/60Hz  
 M/N : MP32-ARGON2-MIRROR  
 Test Mode : IEEE 802.11n HT20 TX 5200MHz

	Freq. (MHz)	Ant. Factor (dB/m)	Cable Loss (dB)	Amp Factor (dB)	Reading (dBuV)	Emission Level (dBuV/m)	Limits (dBuV/m)	Margin (dB)	Remark
1	5200.00	32.24	3.53	34.62	85.18	86.33	68.20	-18.13	Peak
2	9857.00	38.62	5.78	34.23	34.85	45.02	68.20	23.18	Peak
3	10400.00	39.31	5.99	34.32	31.95	42.93	68.20	25.27	Peak
4	14702.00	40.96	6.86	34.51	32.03	45.34	68.20	22.86	Peak
5	15600.00	40.24	6.53	34.36	29.54	41.95	74.00	32.05	Peak
6	17966.00	48.63	8.22	34.30	23.42	45.97	74.00	28.03	Peak

Remarks: 1. Emission Level= Antenna Factor + Cable Loss - Amp Factor + Reading.  
 2. Margin= Limit - Emission Level.  
 3. The emission levels that are 20dB below the official limit are not reported.

Data: 79 File: \\Emc-966-1\test data\2020\RF\W\WANLIDA\MP32-ARGON2-MIRROR.EM6 (176) Date: 2020-09-15

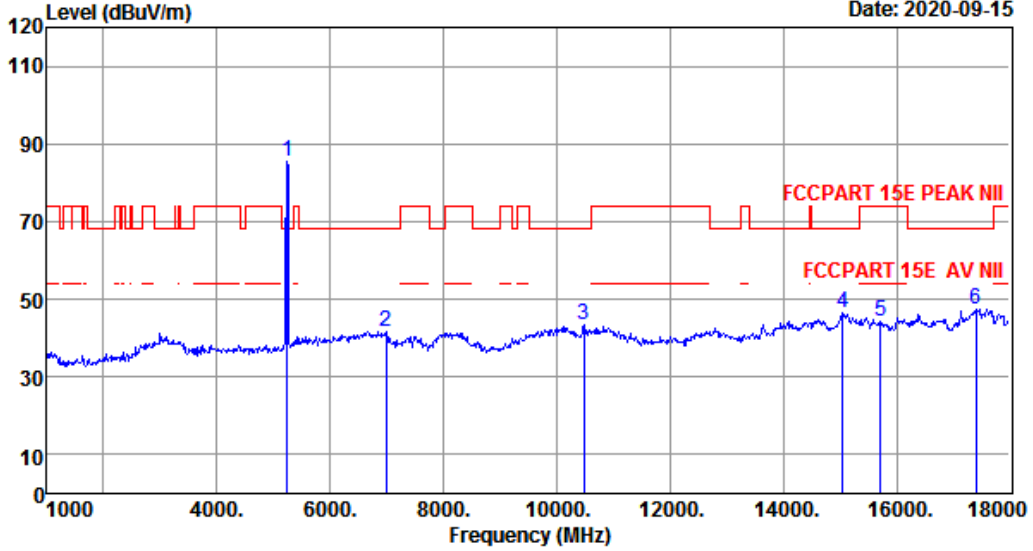

Site no. : 1# 966 Chamber Data no. : 79  
 Dis. / Ant. : 3m ANT9120D 1-18G Ant. pol. : HORIZONTAL  
 Limit : FCCPART 15E PEAK NII  
 Env. / Ins. : Temp:26.4';Humi:54%;Press:101.52kPa  
 Engineer : Pablo  
 EUT : Tablet  
 Power : DC 24V From Adapter Input AC 120V/60Hz  
 M/N : MP32-ARGON2-MIRROR  
 Test Mode : IEEE 802.11n HT20 TX 5240MHz

	Freq. (MHz)	Ant. Factor (dB/m)	Cable Loss (dB)	Amp Factor (dB)	Reading (dBuV)	Emission Level (dBuV/m)	Limits (dBuV/m)	Margin (dB)	Remark
1	5240.00	32.31	3.55	34.61	84.30	85.55	68.20	-17.35	Peak
2	6984.00	35.76	5.12	34.79	35.60	41.69	68.20	26.51	Peak
3	10480.00	39.39	6.02	34.35	32.29	43.35	68.20	24.85	Peak
4	15042.00	40.86	6.78	34.59	33.38	46.43	68.20	21.77	Peak
5	15720.00	40.10	6.65	34.31	31.72	44.16	74.00	29.84	Peak
6	17405.00	44.15	7.82	34.36	29.88	47.49	68.20	20.71	Peak

Remarks: 1. Emission Level= Antenna Factor + Cable Loss - Amp Factor + Reading.  
 2. Margin= Limit - Emission Level.  
 3. The emission levels that are 20dB below the official limit are not reported.

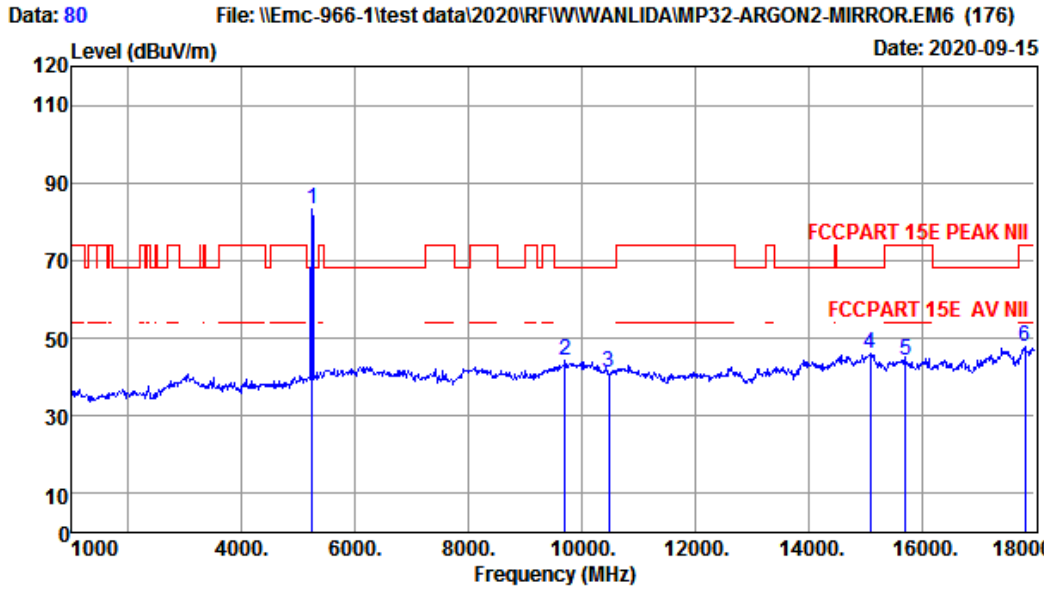

Site no. : 1# 966 Chamber Data no. : 80  
 Dis. / Ant. : 3m ANT9120D 1-18G Ant. pol. : VERTICAL  
 Limit : FCCPART 15E PEAK NII  
 Env. / Ins. : Temp:26.4';Humi:54%;Press:101.52kPa  
 Engineer : Pablo  
 EUT : Tablet  
 Power : DC 24V From Adapter Input AC 120V/60Hz  
 M/N : MP32-ARGON2-MIRROR  
 Test Mode : IEEE 802.11n HT20 TX 5240MHz

	Freq. (MHz)	Ant. Factor (dB/m)	Cable Loss (dB)	Amp Factor (dB)	Reading (dBuV)	Emission Level (dBuV/m)	Limits (dBuV/m)	Margin (dB)	Remark
1	5240.00	32.31	3.55	34.61	81.85	83.10	68.20	-14.90	Peak
2	9704.00	38.31	5.66	34.26	34.62	44.33	68.20	23.87	Peak
3	10480.00	39.39	6.02	34.35	30.24	41.30	68.20	26.90	Peak
4	15093.00	40.81	6.74	34.57	32.93	45.91	68.20	22.29	Peak
5	15720.00	40.10	6.65	34.31	31.70	44.14	74.00	29.86	Peak
6	17830.00	47.54	8.13	34.32	26.42	47.77	74.00	26.23	Peak

Remarks: 1. Emission Level= Antenna Factor + Cable Loss - Amp Factor + Reading.  
 2. Margin= Limit - Emission Level.  
 3. The emission levels that are 20dB below the official limit are not reported.

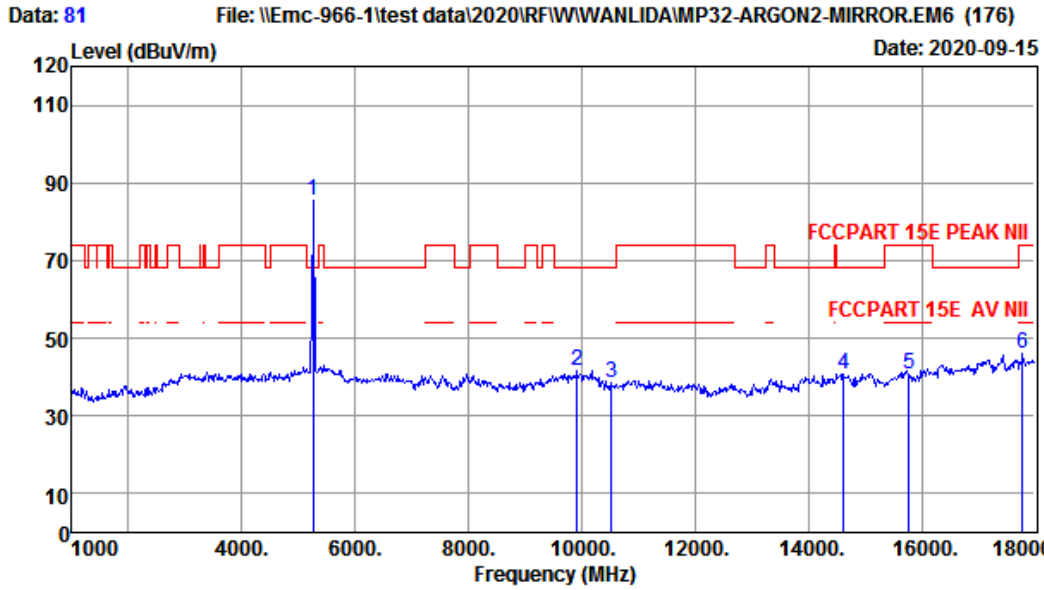

Site no. : 1# 966 Chamber Data no. : 81  
 Dis. / Ant. : 3m ANT9120D 1-18G Ant. pol. : VERTICAL  
 Limit : FCCPART 15E PEAK NII  
 Env. / Ins. : Temp:26.4';Humi:54%;Press:101.52kPa  
 Engineer : Pablo  
 EUT : Tablet  
 Power : DC 24V From Adapter Input AC 120V/60Hz  
 M/N : MP32-ARGON2-MIRROR  
 Test Mode : IEEE 802.11n HT20 TX 5260MHz

	Freq. (MHz)	Ant. Factor (dB/m)	Cable Loss (dB)	Amp Factor (dB)	Reading (dBuV)	Emission Level (dBuV/m)	Limits (dBuV/m)	Margin (dB)	Remark
1	5260.00	32.39	3.57	34.59	83.87	85.24	68.20	-17.04	Peak
2	9925.00	38.76	5.84	34.21	31.22	41.61	68.20	26.59	Peak
3	10520.00	39.43	6.02	34.36	27.44	38.53	68.20	29.67	Peak
4	14617.00	40.98	6.88	34.48	27.54	40.92	68.20	27.28	Peak
5	15780.00	40.05	6.69	34.29	28.24	40.69	74.00	33.31	Peak
6	17779.00	47.14	8.10	34.32	25.14	46.06	74.00	27.94	Peak

Remarks: 1. Emission Level= Antenna Factor + Cable Loss - Amp Factor + Reading.  
 2. Margin= Limit - Emission Level.  
 3. The emission levels that are 20dB below the official limit are not reported.

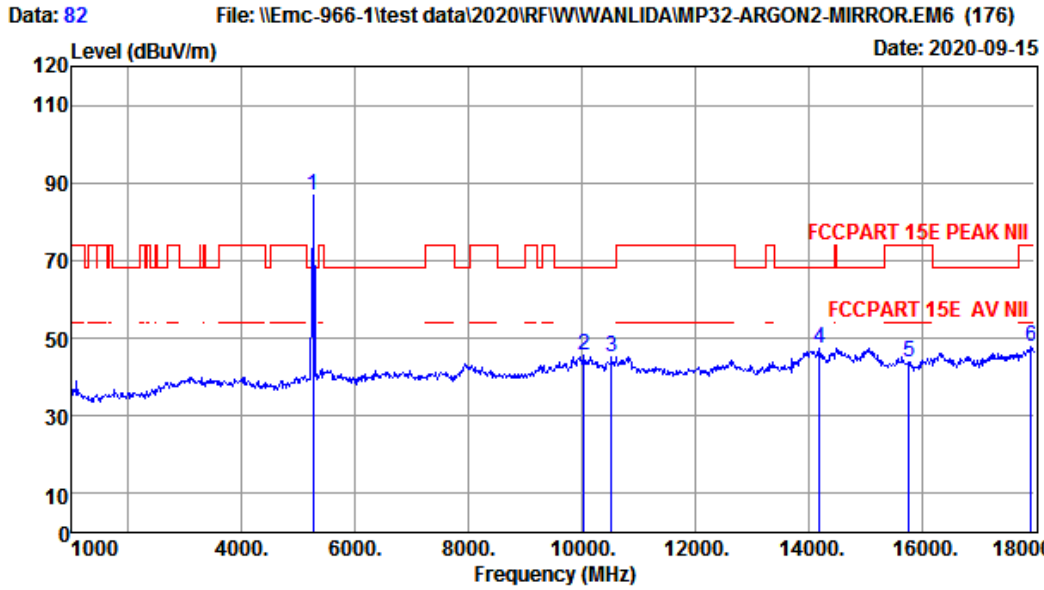

Site no. : 1# 966 Chamber Data no. : 82  
 Dis. / Ant. : 3m ANT9120D 1-18G Ant. pol. : HORIZONTAL  
 Limit : FCCPART 15E PEAK NII  
 Env. / Ins. : Temp:26.4';Humi:54%;Press:101.52kPa  
 Engineer : Pablo  
 EUT : Tablet  
 Power : DC 24V From Adapter Input AC 120V/60Hz  
 M/N : MP32-ARGON2-MIRROR  
 Test Mode : IEEE 802.11n HT20 TX 5260MHz

	Freq. (MHz)	Ant. Factor (dB/m)	Cable Loss (dB)	Amp Factor (dB)	Reading (dBuV)	Emission Level (dBuV/m)	Limits (dBuV/m)	Margin (dB)	Remark
1	5260.00	32.39	3.57	34.59	85.36	86.73	68.20	-18.53	Peak
2	10044.00	38.95	5.90	34.22	34.88	45.51	68.20	22.69	Peak
3	10520.00	39.43	6.02	34.36	34.01	45.10	68.20	23.10	Peak
4	14192.00	41.06	6.67	34.36	33.88	47.25	68.20	20.95	Peak
5	15780.00	40.05	6.69	34.29	31.19	43.64	74.00	30.36	Peak
6	17932.00	48.36	8.20	34.31	25.67	47.92	74.00	26.08	Peak

Remarks: 1. Emission Level= Antenna Factor + Cable Loss - Amp Factor + Reading.  
 2. Margin= Limit - Emission Level.  
 3. The emission levels that are 20dB below the official limit are not reported.

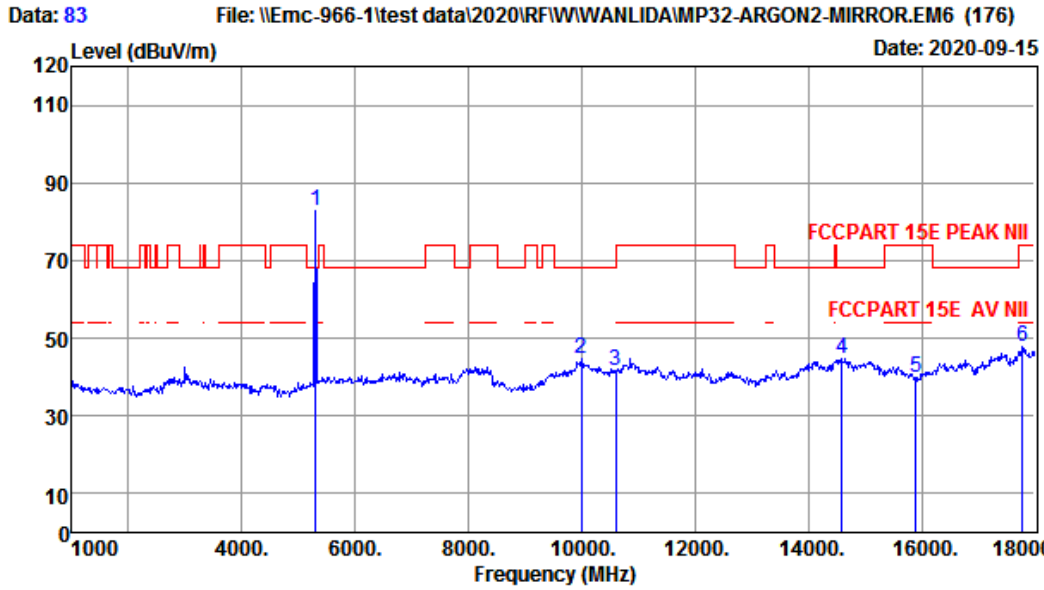

Site no. : 1# 966 Chamber Data no. : 83  
 Dis. / Ant. : 3m ANT9120D 1-18G Ant. pol. : HORIZONTAL  
 Limit : FCCPART 15E PEAK NII  
 Env. / Ins. : Temp:26.4';Humi:54%;Press:101.52kPa  
 Engineer : Pablo  
 EUT : Tablet  
 Power : DC 24V From Adapter Input AC 120V/60Hz  
 M/N : MP32-ARGON2-MIRROR  
 Test Mode : IEEE 802.11n HT20 TX 5300MHz

	Freq. (MHz)	Ant. Factor (dB/m)	Cable Loss (dB)	Amp Factor (dB)	Reading (dBuV)	Emission Level (dBuV/m)	Limits (dBuV/m)	Margin (dB)	Remark
1	5300.00	32.46	3.59	34.58	81.35	82.82	68.20	-14.62	Peak
2	9993.00	38.90	5.89	34.20	34.13	44.72	68.20	23.48	Peak
3	10600.00	39.51	6.04	34.38	30.62	41.79	68.20	26.41	Peak
4	14600.00	40.98	6.88	34.48	31.26	44.64	68.20	23.56	Peak
5	15900.00	39.91	6.81	34.24	27.20	39.68	74.00	34.32	Peak
6	17779.00	47.14	8.10	34.32	26.92	47.84	74.00	26.16	Peak

Remarks: 1. Emission Level= Antenna Factor + Cable Loss - Amp Factor + Reading.  
 2. Margin= Limit - Emission Level.  
 3. The emission levels that are 20dB below the official limit are not reported.

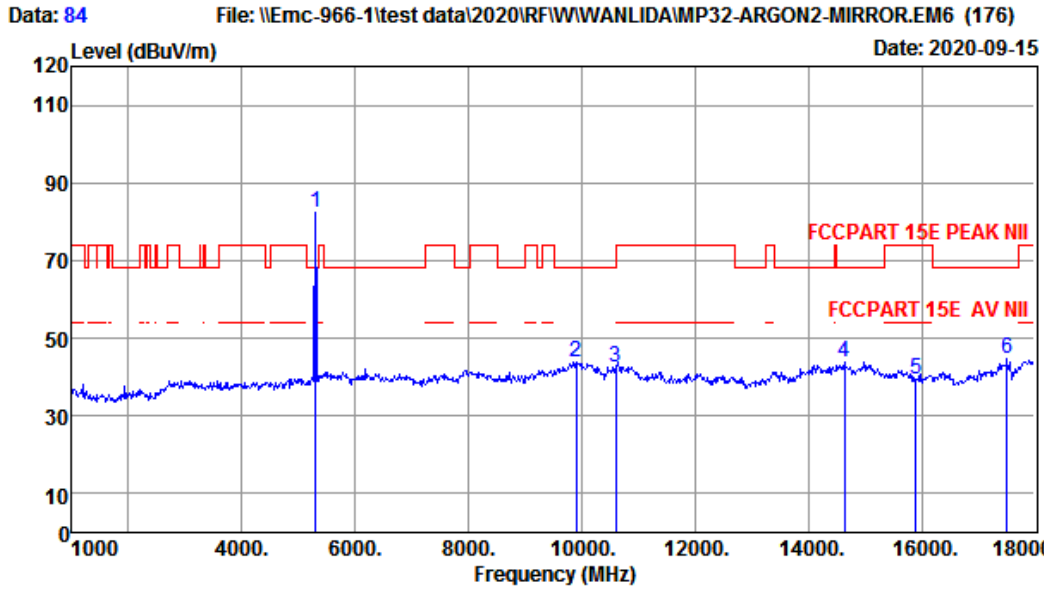

Site no. : 1# 966 Chamber Data no. : 84  
 Dis. / Ant. : 3m ANT9120D 1-18G Ant. pol. : VERTICAL  
 Limit : FCCPART 15E PEAK NII  
 Env. / Ins. : Temp:26.4';Humi:54%;Press:101.52kPa  
 Engineer : Pablo  
 EUT : Tablet  
 Power : DC 24V From Adapter Input AC 120V/60Hz  
 M/N : MP32-ARGON2-MIRROR  
 Test Mode : IEEE 802.11n HT20 TX 5300MHz

	Freq. (MHz)	Ant. Factor (dB/m)	Cable Loss (dB)	Amp Factor (dB)	Reading (dBuV)	Emission Level (dBuV/m)	Limits (dBuV/m)	Margin (dB)	Remark
1	5300.00	32.46	3.59	34.58	80.76	82.23	68.20	-14.03	Peak
2	9908.00	38.73	5.82	34.22	33.46	43.79	68.20	24.41	Peak
3	10600.00	39.51	6.04	34.38	31.39	42.56	68.20	25.64	Peak
4	14634.00	40.97	6.88	34.49	30.68	44.04	68.20	24.16	Peak
5	15900.00	39.91	6.81	34.24	26.98	39.46	74.00	34.54	Peak
6	17507.00	44.97	7.92	34.35	25.96	44.50	68.20	23.70	Peak

Remarks: 1. Emission Level= Antenna Factor + Cable Loss - Amp Factor + Reading.  
 2. Margin= Limit - Emission Level.  
 3. The emission levels that are 20dB below the official limit are not reported.



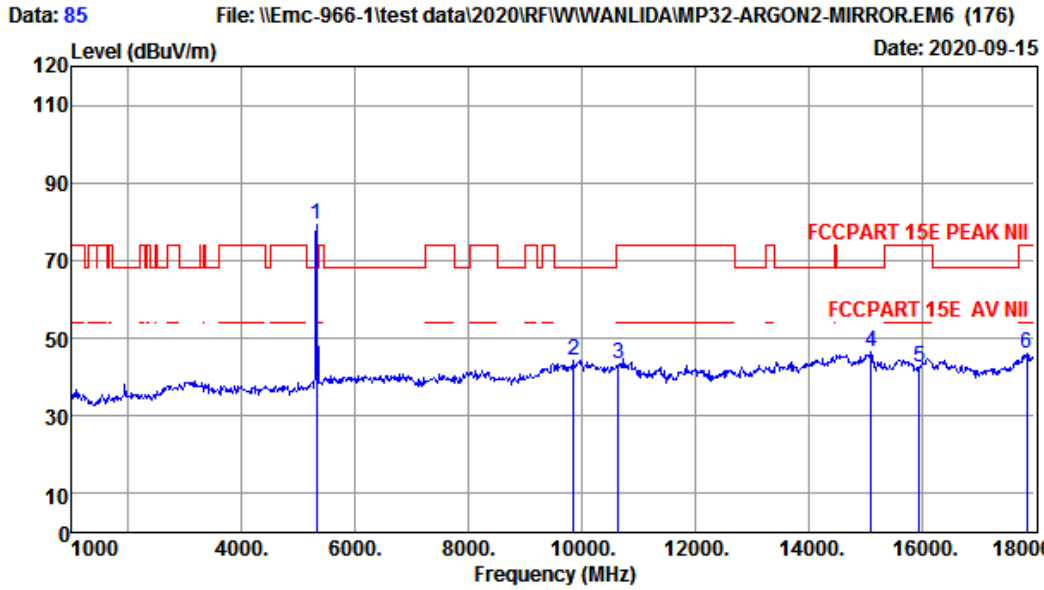

Site no. : 1# 966 Chamber Data no. : 85  
 Dis. / Ant. : 3m ANT9120D 1-18G Ant. pol. : VERTICAL  
 Limit : FCCPART 15E PEAK NII  
 Env. / Ins. : Temp:26.4';Humi:54%;Press:101.52kPa  
 Engineer : Pablo  
 EUT : Tablet  
 Power : DC 24V From Adapter Input AC 120V/60Hz  
 M/N : MP32-ARGON2-MIRROR  
 Test Mode : IEEE 802.11n HT20 TX 5320MHz

	Freq. (MHz)	Ant. Factor (dB/m)	Cable Loss (dB)	Amp Factor (dB)	Reading (dBuV)	Emission Level (dBuV/m)	Limits (dBuV/m)	Margin (dB)	Remark
1	5320.00	32.50	3.60	34.57	77.64	79.17	68.20	-10.97	Peak
2	9857.00	38.62	5.78	34.23	34.30	44.47	68.20	23.73	Peak
3	10640.00	39.54	6.04	34.39	32.13	43.32	74.00	30.68	Peak
4	15110.00	40.79	6.73	34.56	33.43	46.39	68.20	21.81	Peak
5	15960.00	39.84	6.88	34.21	30.02	42.53	74.00	31.47	Peak
6	17864.00	47.82	8.15	34.31	24.35	46.01	74.00	27.99	Peak

Remarks: 1. Emission Level= Antenna Factor + Cable Loss - Amp Factor + Reading.  
 2. Margin= Limit - Emission Level.  
 3. The emission levels that are 20dB below the official limit are not reported.

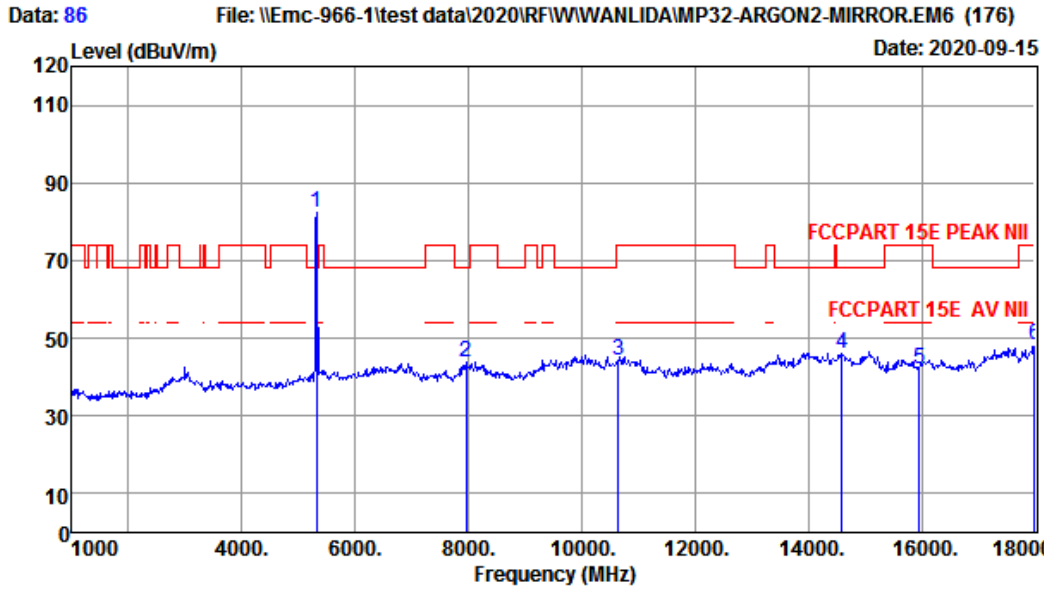

Site no. : 1# 966 Chamber Data no. : 86  
 Dis. / Ant. : 3m ANT9120D 1-18G Ant. pol. : HORIZONTAL  
 Limit : FCCPART 15E PEAK NII  
 Env. / Ins. : Temp:26.4';Humi:54%;Press:101.52kPa  
 Engineer : Pablo  
 EUT : Tablet  
 Power : DC 24V From Adapter Input AC 120V/60Hz  
 M/N : MP32-ARGON2-MIRROR  
 Test Mode : IEEE 802.11n HT20 TX 5320MHz

	Freq. (MHz)	Ant. Factor (dB/m)	Cable Loss (dB)	Amp Factor (dB)	Reading (dBuV)	Emission Level (dBuV/m)	Limits (dBuV/m)	Margin (dB)	Remark
1	5320.00	32.50	3.60	34.57	80.76	82.29	68.20	-14.09	Peak
2	7953.00	36.89	5.77	34.89	36.17	43.94	68.20	24.26	Peak
3	10640.00	39.54	6.04	34.39	33.23	44.42	74.00	29.58	Peak
4	14600.00	40.98	6.88	34.48	32.89	46.27	68.20	21.93	Peak
5	15960.00	39.84	6.88	34.21	29.43	41.94	74.00	32.06	Peak
6	18000.00	48.90	8.24	34.30	25.57	48.41	74.00	25.59	Peak

Remarks: 1. Emission Level= Antenna Factor + Cable Loss - Amp Factor + Reading.  
 2. Margin= Limit - Emission Level.  
 3. The emission levels that are 20dB below the official limit are not reported.

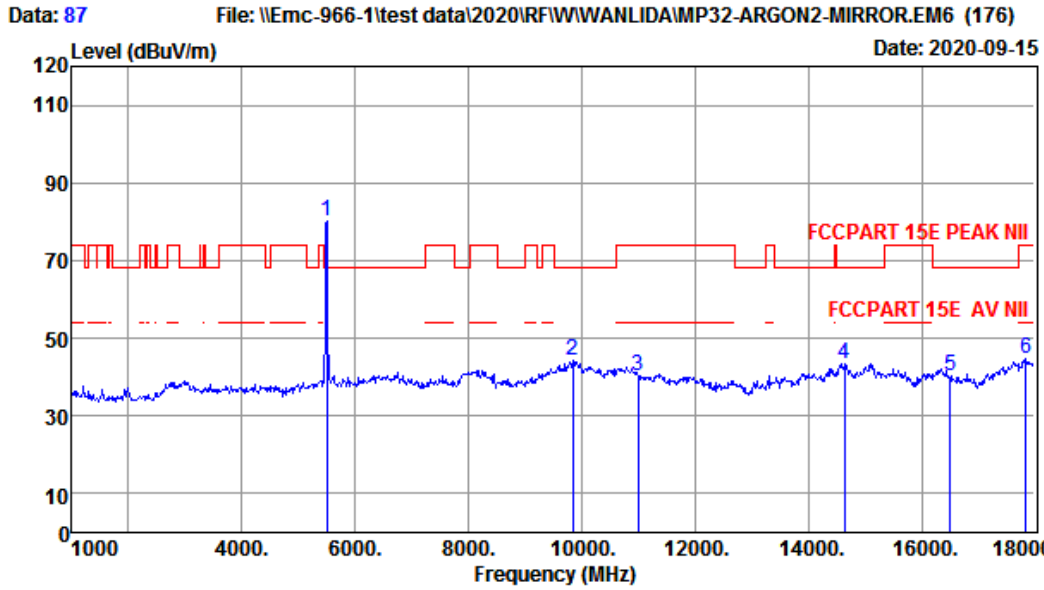

Site no. : 1# 966 Chamber Data no. : 87  
 Dis. / Ant. : 3m ANT9120D 1-18G Ant. pol. : VERTICAL  
 Limit : FCCPART 15E PEAK NII  
 Env. / Ins. : Temp:26.4';Humi:54%;Press:101.52kPa  
 Engineer : Pablo  
 EUT : Tablet  
 Power : DC 24V From Adapter Input AC 120V/60Hz  
 M/N : MP32-ARGON2-MIRROR  
 Test Mode : IEEE 802.11n HT20 TX 5500MHz

	Freq. (MHz)	Ant. Factor (dB/m)	Cable Loss (dB)	Amp Factor (dB)	Reading (dBuV)	Emission Level (dBuV/m)	Limits (dBuV/m)	Margin (dB)	Remark
1	5500.00	32.90	3.71	34.50	78.19	80.30	68.20	-12.10	Peak
2	9840.00	38.59	5.77	34.23	34.13	44.26	68.20	23.94	Peak
3	11000.00	39.90	6.11	34.50	28.89	40.40	74.00	33.60	Peak
4	14634.00	40.97	6.88	34.49	30.04	43.40	68.20	24.80	Peak
5	16500.00	40.36	7.12	34.30	27.18	40.36	68.20	27.84	Peak
6	17847.00	47.68	8.14	34.32	23.17	44.67	74.00	29.33	Peak

Remarks: 1. Emission Level= Antenna Factor + Cable Loss - Amp Factor + Reading.  
 2. Margin= Limit - Emission Level.  
 3. The emission levels that are 20dB below the official limit are not reported.

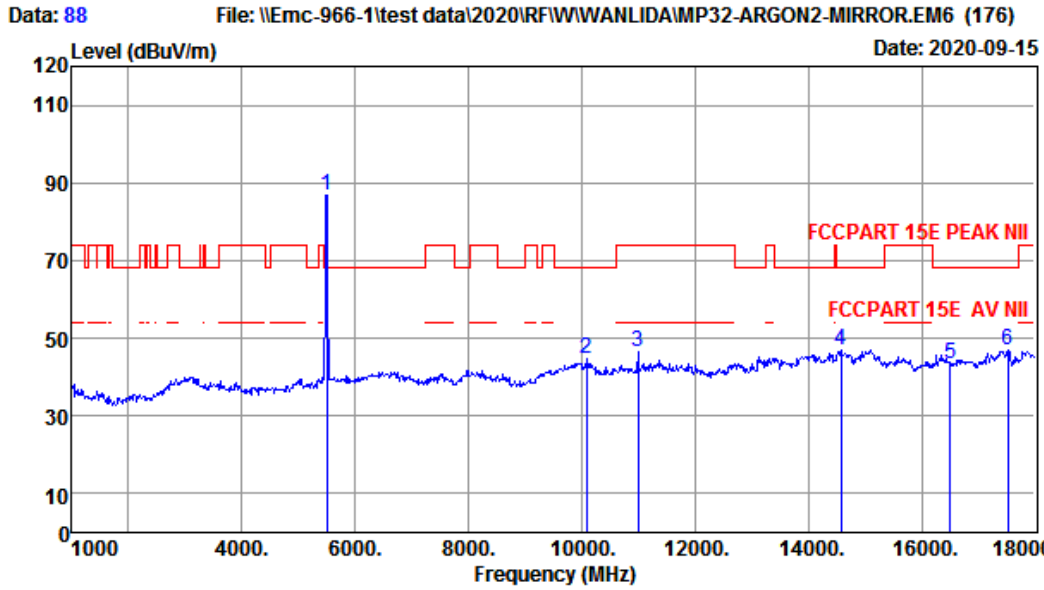

Site no. : 1# 966 Chamber Data no. : 88  
 Dis. / Ant. : 3m ANT9120D 1-18G Ant. pol. : HORIZONTAL  
 Limit : FCCPART 15E PEAK NII  
 Env. / Ins. : Temp:26.4';Humi:54%;Press:101.52kPa  
 Engineer : Pablo  
 EUT : Tablet  
 Power : DC 24V From Adapter Input AC 120V/60Hz  
 M/N : MP32-ARGON2-MIRROR  
 Test Mode : IEEE 802.11n HT20 TX 5500MHz

	Freq. (MHz)	Ant. Factor (dB/m)	Cable Loss (dB)	Amp Factor (dB)	Reading (dBuV)	Emission Level (dBuV/m)	Limits (dBuV/m)	Margin (dB)	Remark
1	5500.00	32.90	3.71	34.50	84.90	87.01	68.20	-18.81	Peak
2	10078.00	38.98	5.91	34.23	33.87	44.53	68.20	23.67	Peak
3	11000.00	39.90	6.11	34.50	35.16	46.67	74.00	27.33	Peak
4	14583.00	40.98	6.89	34.47	33.58	46.98	68.20	21.22	Peak
5	16500.00	40.36	7.12	34.30	30.33	43.51	68.20	24.69	Peak
6	17524.00	45.10	7.93	34.35	28.35	47.03	68.20	21.17	Peak

Remarks: 1. Emission Level= Antenna Factor + Cable Loss - Amp Factor + Reading.  
 2. Margin= Limit - Emission Level.  
 3. The emission levels that are 20dB below the official limit are not reported.

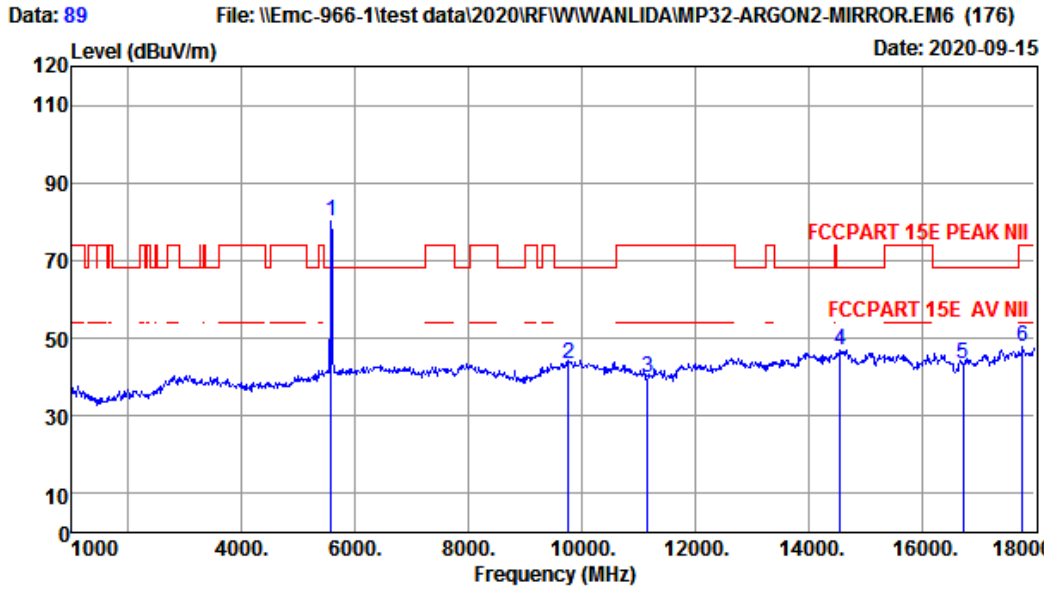

Site no. : 1# 966 Chamber Data no. : 89  
 Dis. / Ant. : 3m ANT9120D 1-18G Ant. pol. : VERTICAL  
 Limit : FCCPART 15E PEAK NII  
 Env. / Ins. : Temp:26.4';Humi:54%;Press:101.52kPa  
 Engineer : Pablo  
 EUT : Tablet  
 Power : DC 24V From Adapter Input AC 120V/60Hz  
 M/N : MP32-ARGON2-MIRROR  
 Test Mode : IEEE 802.11n HT20 TX 5580MHz

	Freq. (MHz)	Ant. Factor (dB/m)	Cable Loss (dB)	Amp Factor (dB)	Reading (dBuV)	Emission Level (dBuV/m)	Limits (dBuV/m)	Margin (dB)	Remark
1	5580.00	32.89	3.79	34.47	78.08	80.29	68.20	-12.09	Peak
2	9772.00	38.45	5.72	34.24	33.57	43.50	68.20	24.70	Peak
3	11160.00	39.90	6.12	34.55	28.55	40.02	74.00	33.98	Peak
4	14566.00	40.99	6.89	34.47	33.33	46.74	68.20	21.46	Peak
5	16740.00	40.62	7.26	34.35	29.97	43.50	68.20	24.70	Peak
6	17779.00	47.14	8.10	34.32	26.89	47.81	74.00	26.19	Peak

Remarks: 1. Emission Level= Antenna Factor + Cable Loss - Amp Factor + Reading.  
 2. Margin= Limit - Emission Level.  
 3. The emission levels that are 20dB below the official limit are not reported.

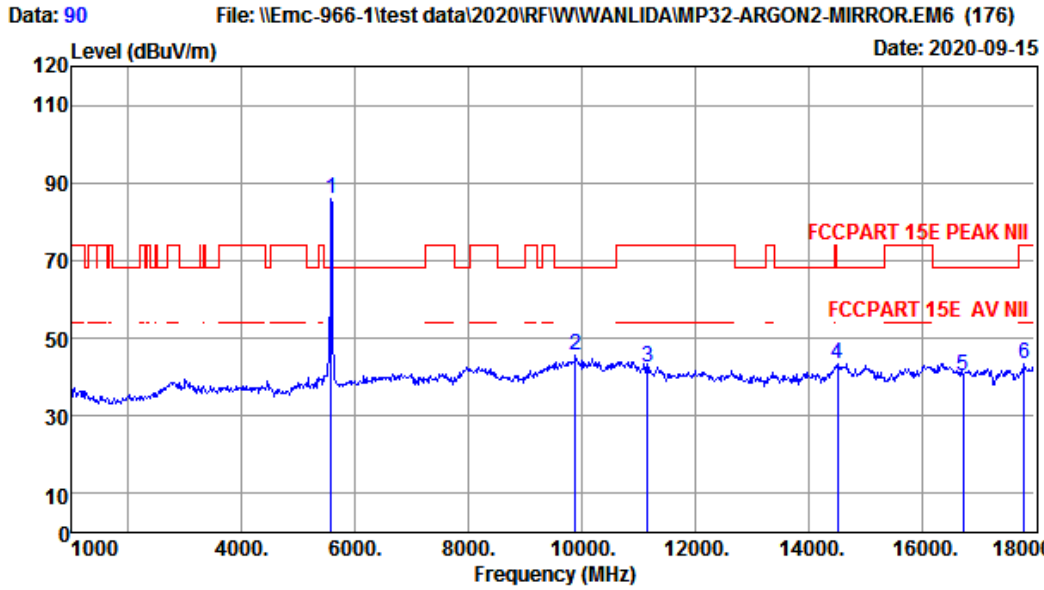

Site no. : 1# 966 Chamber Data no. : 90  
 Dis. / Ant. : 3m ANT9120D 1-18G Ant. pol. : HORIZONTAL  
 Limit : FCCPART 15E PEAK NII  
 Env. / Ins. : Temp:26.4';Humi:54%;Press:101.52kPa  
 Engineer : Pablo  
 EUT : Tablet  
 Power : DC 24V From Adapter Input AC 120V/60Hz  
 M/N : MP32-ARGON2-MIRROR  
 Test Mode : IEEE 802.11n HT20 TX 5580MHz

	Freq. (MHz)	Ant. Factor (dB/m)	Cable Loss (dB)	Amp Factor (dB)	Reading (dBuV)	Emission Level (dBuV/m)	Limits (dBuV/m)	Margin (dB)	Remark
1	5580.00	32.89	3.79	34.47	83.67	85.88	68.20	-17.68	Peak
2	9891.00	38.69	5.81	34.22	35.18	45.46	68.20	22.74	Peak
3	11160.00	39.90	6.12	34.55	31.21	42.68	74.00	31.32	Peak
4	14515.00	41.00	6.90	34.45	30.04	43.49	68.20	24.71	Peak
5	16740.00	40.62	7.26	34.35	26.91	40.44	68.20	27.76	Peak
6	17813.00	47.41	8.12	34.32	22.05	43.26	74.00	30.74	Peak

Remarks: 1. Emission Level= Antenna Factor + Cable Loss - Amp Factor + Reading.  
 2. Margin= Limit - Emission Level.  
 3. The emission levels that are 20dB below the official limit are not reported.

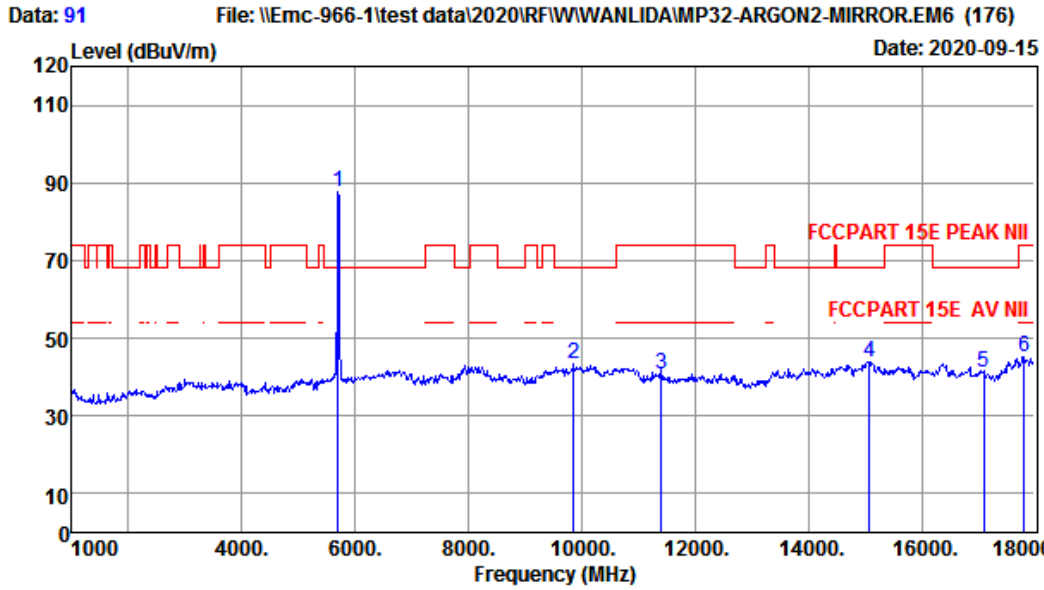

Site no. : 1# 966 Chamber Data no. : 91  
 Dis. / Ant. : 3m ANT9120D 1-18G Ant. pol. : HORIZONTAL  
 Limit : FCCPART 15E PEAK NII  
 Env. / Ins. : Temp:26.4';Humi:54%;Press:101.52kPa  
 Engineer : Pablo  
 EUT : Tablet  
 Power : DC 24V From Adapter Input AC 120V/60Hz  
 M/N : MP32-ARGON2-MIRROR  
 Test Mode : IEEE 802.11n HT20 TX 5700MHz

	Freq. (MHz)	Ant. Factor (dB/m)	Cable Loss (dB)	Amp Factor (dB)	Reading (dBuV)	Emission Level (dBuV/m)	Limits (dBuV/m)	Margin (dB)	Remark
1	5700.00	32.86	3.94	34.42	85.17	87.55	68.20	-19.35	Peak
2	9857.00	38.62	5.78	34.23	33.27	43.44	68.20	24.76	Peak
3	11400.00	39.90	6.14	34.62	29.14	40.56	74.00	33.44	Peak
4	15076.00	40.82	6.76	34.57	30.90	43.91	68.20	24.29	Peak
5	17100.00	41.71	7.52	34.39	26.40	41.24	68.20	26.96	Peak
6	17813.00	47.41	8.12	34.32	23.92	45.13	74.00	28.87	Peak

Remarks: 1. Emission Level= Antenna Factor + Cable Loss - Amp Factor + Reading.  
 2. Margin= Limit - Emission Level.  
 3. The emission levels that are 20dB below the official limit are not reported.



Data: 92 File: \\Emc-966-1\test data\2020\RF\W\WANLIDA\MP32-ARGON2-MIRROR.EM6 (176) Date: 2020-09-15

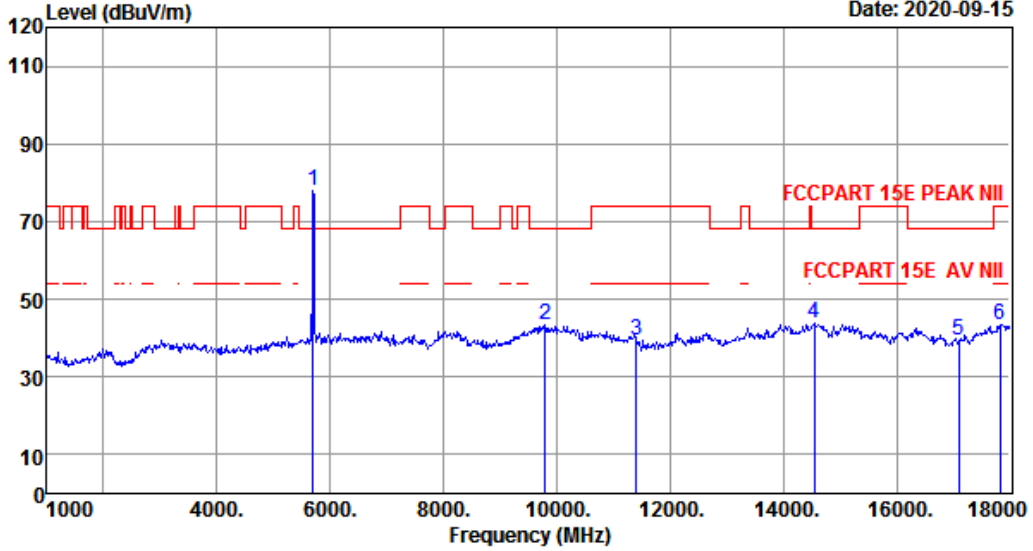

Site no. : 1# 966 Chamber Data no. : 92  
 Dis. / Ant. : 3m ANT9120D 1-18G Ant. pol. : VERTICAL  
 Limit : FCCPART 15E PEAK NII  
 Env. / Ins. : Temp:26.4';Humi:54%;Press:101.52kPa  
 Engineer : Pablo  
 EUT : Tablet  
 Power : DC 24V From Adapter Input AC 120V/60Hz  
 M/N : MP32-ARGON2-MIRROR  
 Test Mode : IEEE 802.11n HT20 TX 5700MHz

	Freq. (MHz)	Ant. Factor (dB/m)	Cable Loss (dB)	Amp Factor (dB)	Reading (dBuV)	Emission Level (dBuV/m)	Limits (dBuV/m)	Margin (dB)	Remark
1	5700.00	32.86	3.94	34.42	75.74	78.12	68.20	-9.92	Peak
2	9789.00	38.49	5.73	34.24	33.63	43.61	68.20	24.59	Peak
3	11400.00	39.90	6.14	34.62	28.16	39.58	74.00	34.42	Peak
4	14549.00	40.99	6.89	34.46	30.23	43.65	68.20	24.55	Peak
5	17100.00	41.71	7.52	34.39	24.43	39.27	68.20	28.93	Peak
6	17830.00	47.54	8.13	34.32	22.22	43.57	74.00	30.43	Peak

Remarks: 1. Emission Level= Antenna Factor + Cable Loss - Amp Factor + Reading.  
 2. Margin= Limit - Emission Level.  
 3. The emission levels that are 20dB below the official limit are not reported.

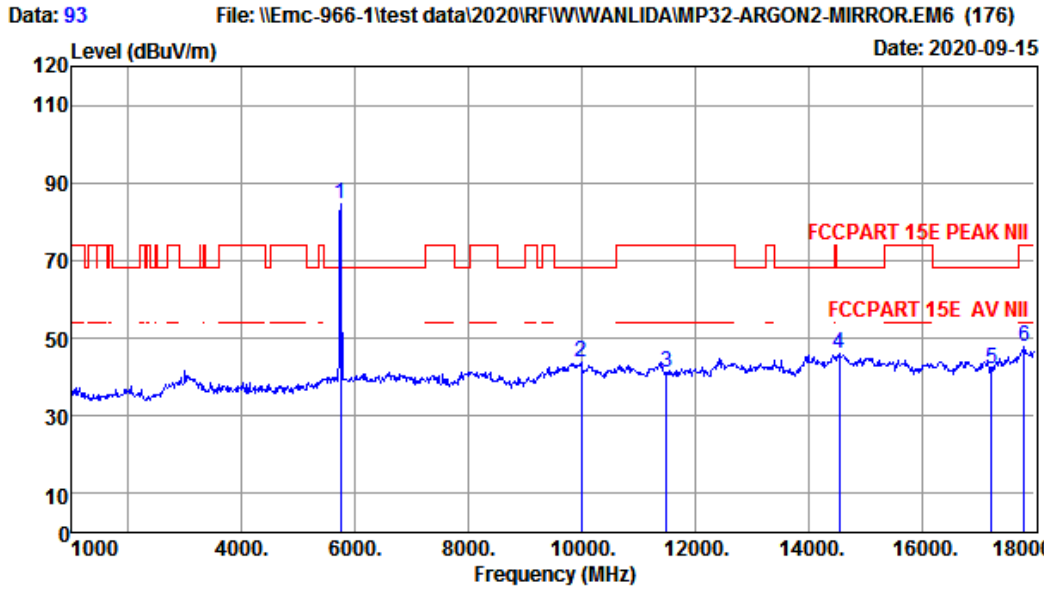

Site no. : 1# 966 Chamber Data no. : 93  
 Dis. / Ant. : 3m ANT9120D 1-18G Ant. pol. : HORIZONTAL  
 Limit : FCCPART 15E PEAK NII  
 Env. / Ins. : Temp:26.4';Humi:54%;Press:101.52kPa  
 Engineer : Pablo  
 EUT : Tablet  
 Power : DC 24V From Adapter Input AC 120V/60Hz  
 M/N : MP32-ARGON2-MIRROR  
 Test Mode : IEEE 802.11n HT20 TX 5745MHz

	Freq. (MHz)	Ant. Factor (dB/m)	Cable Loss (dB)	Amp Factor (dB)	Reading (dBuV)	Emission Level (dBuV/m)	Limits (dBuV/m)	Margin (dB)	Remark
1	5745.00	32.85	4.00	34.40	82.33	84.78	68.20	-16.58	Peak
2	9993.00	38.90	5.89	34.20	33.04	43.63	68.20	24.57	Peak
3	11490.00	39.90	6.15	34.65	29.66	41.06	74.00	32.94	Peak
4	14549.00	40.99	6.89	34.46	32.46	45.88	68.20	22.32	Peak
5	17235.00	42.80	7.65	34.38	25.85	41.92	68.20	26.28	Peak
6	17813.00	47.41	8.12	34.32	26.54	47.75	74.00	26.25	Peak

Remarks: 1. Emission Level= Antenna Factor + Cable Loss - Amp Factor + Reading.  
 2. Margin= Limit - Emission Level.  
 3. The emission levels that are 20dB below the official limit are not reported.

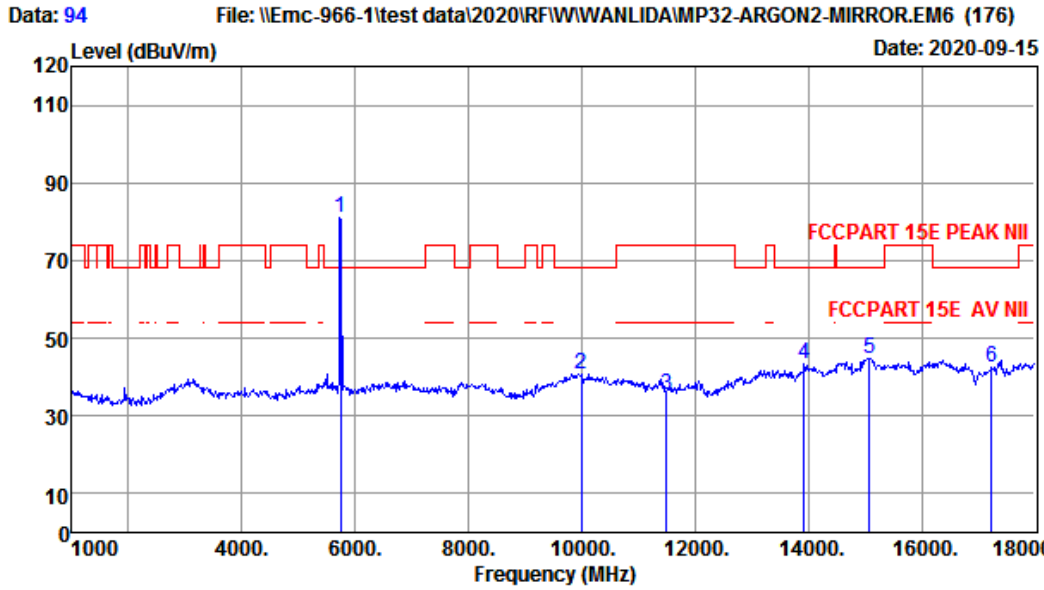

Site no. : 1# 966 Chamber Data no. : 94  
 Dis. / Ant. : 3m ANT9120D 1-18G Ant. pol. : VERTICAL  
 Limit : FCCPART 15E PEAK NII  
 Env. / Ins. : Temp:26.4';Humi:54%;Press:101.52kPa  
 Engineer : Pablo  
 EUT : Tablet  
 Power : DC 24V From Adapter Input AC 120V/60Hz  
 M/N : MP32-ARGON2-MIRROR  
 Test Mode : IEEE 802.11n HT20 TX 5745MHz

	Freq. (MHz)	Ant. Factor (dB/m)	Cable Loss (dB)	Amp Factor (dB)	Reading (dBuV)	Emission Level (dBuV/m)	Limits (dBuV/m)	Margin (dB)	Remark
1	5745.00	32.85	4.00	34.40	78.77	81.22	68.20	-13.02	Peak
2	9993.00	38.90	5.89	34.20	30.05	40.64	68.20	27.56	Peak
3	11490.00	39.90	6.15	34.65	24.19	35.59	74.00	38.41	Peak
4	13920.00	40.96	6.50	34.31	30.07	43.22	68.20	24.98	Peak
5	15076.00	40.82	6.76	34.57	31.82	44.83	68.20	23.37	Peak
6	17235.00	42.80	7.65	34.38	26.32	42.39	68.20	25.81	Peak

Remarks: 1. Emission Level= Antenna Factor + Cable Loss - Amp Factor + Reading.  
 2. Margin= Limit - Emission Level.  
 3. The emission levels that are 20dB below the official limit are not reported.

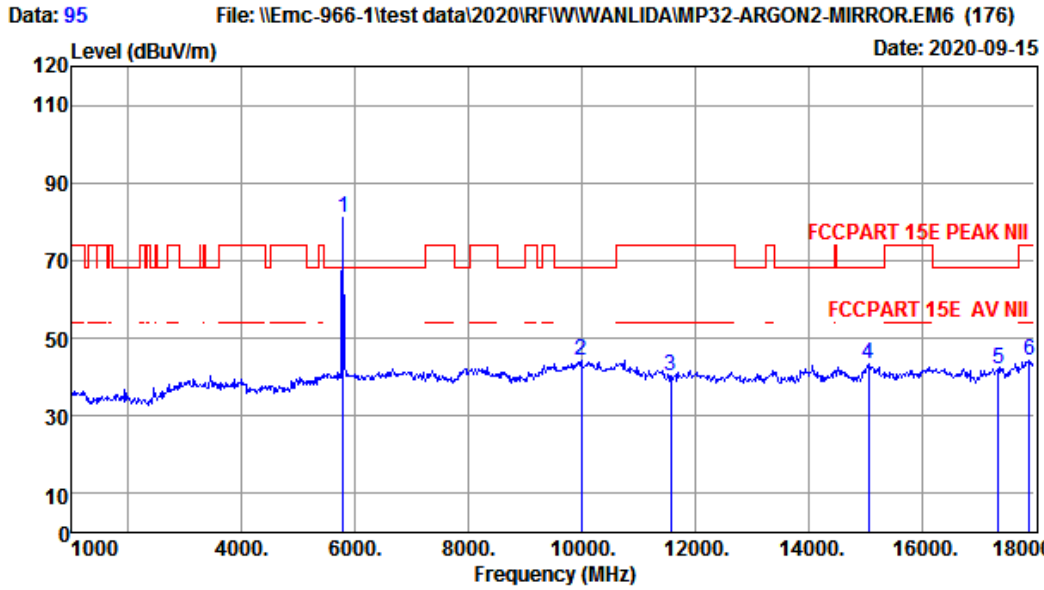

Site no. : 1# 966 Chamber Data no. : 95  
 Dis. / Ant. : 3m ANT9120D 1-18G Ant. pol. : VERTICAL  
 Limit : FCCPART 15E PEAK NII  
 Env. / Ins. : Temp:26.4';Humi:54%;Press:101.52kPa  
 Engineer : Pablo  
 EUT : Tablet  
 Power : DC 24V From Adapter Input AC 120V/60Hz  
 M/N : MP32-ARGON2-MIRROR  
 Test Mode : IEEE 802.11n HT20 TX 5785MHz

	Freq. (MHz)	Ant. Factor (dB/m)	Cable Loss (dB)	Amp Factor (dB)	Reading (dBuV)	Emission Level (dBuV/m)	Limits (dBuV/m)	Margin (dB)	Remark
1	5785.00	32.84	4.05	34.39	78.45	80.95	68.20	-12.75	Peak
2	9993.00	38.90	5.89	34.20	33.67	44.26	68.20	23.94	Peak
3	11570.00	39.90	6.12	34.67	29.10	40.45	74.00	33.55	Peak
4	15059.00	40.84	6.77	34.58	30.58	43.61	68.20	24.59	Peak
5	17355.00	43.75	7.77	34.36	24.80	41.96	68.20	26.24	Peak
6	17898.00	48.09	8.17	34.31	22.55	44.50	74.00	29.50	Peak

Remarks: 1. Emission Level= Antenna Factor + Cable Loss - Amp Factor + Reading.  
 2. Margin= Limit - Emission Level.  
 3. The emission levels that are 20dB below the official limit are not reported.

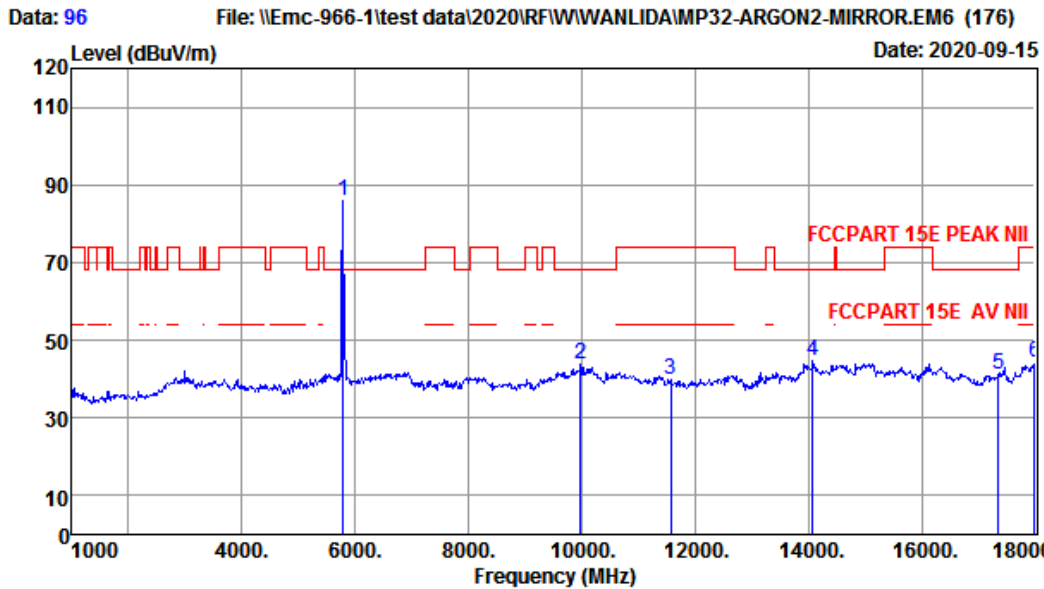

Site no. : 1# 966 Chamber Data no. : 96  
 Dis. / Ant. : 3m ANT9120D 1-18G Ant. pol. : HORIZONTAL  
 Limit : FCCPART 15E PEAK NII  
 Env. / Ins. : Temp:26.4';Humi:54%;Press:101.52kPa  
 Engineer : Pablo  
 EUT : Tablet  
 Power : DC 24V From Adapter Input AC 120V/60Hz  
 M/N : MP32-ARGON2-MIRROR  
 Test Mode : IEEE 802.11n HT20 TX 5785MHz

	Freq. (MHz)	Ant. Factor (dB/m)	Cable Loss (dB)	Amp Factor (dB)	Reading (dBuV)	Emission Level (dBuV/m)	Limits (dBuV/m)	Margin (dB)	Remark
1	5785.00	32.84	4.05	34.39	83.38	85.88	68.20	-17.68	Peak
2	9976.00	38.87	5.88	34.20	33.32	43.87	68.20	24.33	Peak
3	11570.00	39.90	6.12	34.67	28.30	39.65	74.00	34.35	Peak
4	14073.00	41.09	6.58	34.32	31.27	44.62	68.20	23.58	Peak
5	17355.00	43.75	7.77	34.36	23.96	41.12	68.20	27.08	Peak
6	18000.00	48.90	8.24	34.30	21.40	44.24	74.00	29.76	Peak

Remarks: 1. Emission Level= Antenna Factor + Cable Loss - Amp Factor + Reading.  
 2. Margin= Limit - Emission Level.  
 3. The emission levels that are 20dB below the official limit are not reported.

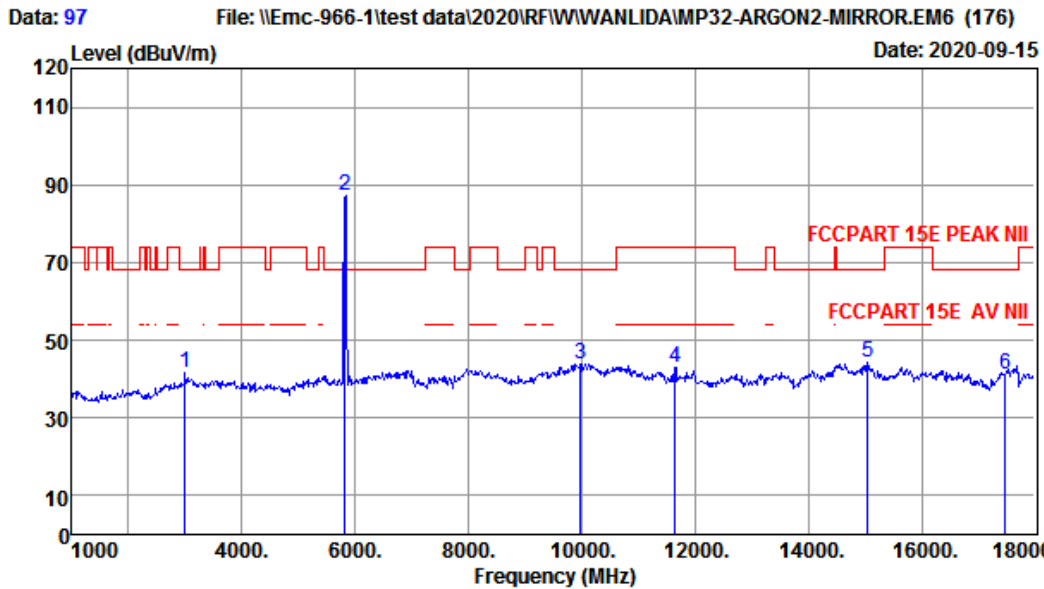

Site no. : 1# 966 Chamber Data no. : 97  
 Dis. / Ant. : 3m ANT9120D 1-18G Ant. pol. : HORIZONTAL  
 Limit : FCCPART 15E PEAK NII  
 Env. / Ins. : Temp:26.4';Humi:54%;Press:101.52kPa  
 Engineer : Pablo  
 EUT : Tablet  
 Power : DC 24V From Adapter Input AC 120V/60Hz  
 M/N : MP32-ARGON2-MIRROR  
 Test Mode : IEEE 802.11n HT20 TX 5825MHz

	Freq. (MHz)	Ant. Factor (dB/m)	Cable Loss (dB)	Amp Factor (dB)	Reading (dBuV)	Emission Level (dBuV/m)	Limits (dBuV/m)	Margin (dB)	Remark
1	2989.00	28.56	2.17	34.41	45.24	41.56	68.20	26.64	Peak
2	5825.00	32.83	4.11	34.37	84.47	87.04	68.20	-18.84	Peak
3	9976.00	38.87	5.88	34.20	33.40	43.95	68.20	24.25	Peak
4	11650.00	39.90	6.08	34.69	31.83	43.12	74.00	30.88	Peak
5	15042.00	40.86	6.78	34.59	31.15	44.20	68.20	24.00	Peak
6	17475.00	44.70	7.89	34.35	23.01	41.25	68.20	26.95	Peak

Remarks: 1. Emission Level= Antenna Factor + Cable Loss - Amp Factor + Reading.  
 2. Margin= Limit - Emission Level.  
 3. The emission levels that are 20dB below the official limit are not reported.

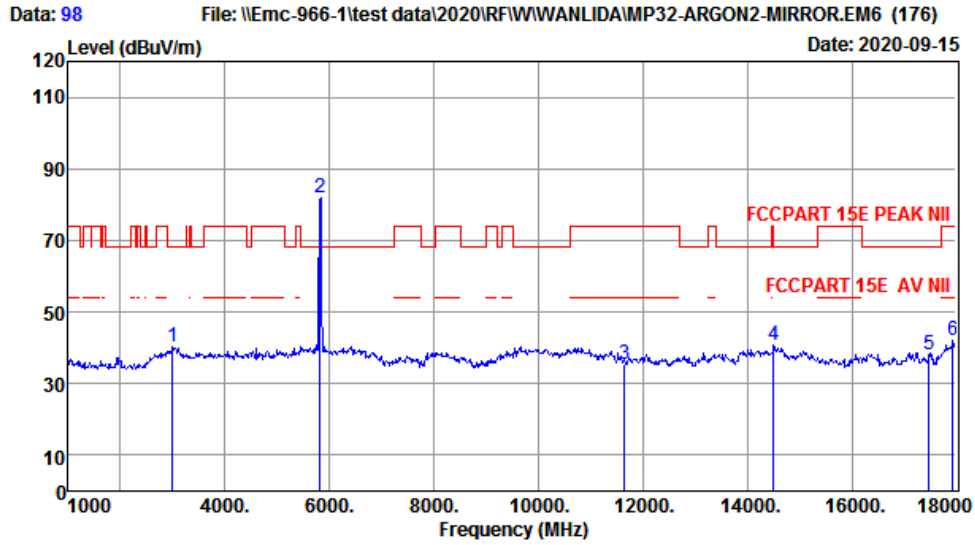

Site no. : 1# 966 Chamber Data no. : 98  
 Dis. / Ant. : 3m ANT9120D 1-18G Ant. pol. : VERTICAL  
 Limit : FCCPART 15E PEAK NII  
 Env. / Ins. : Temp:26.4';Humi:54%;Press:101.52kPa  
 Engineer : Pablo  
 EUT : Tablet  
 Power : DC 24V From Adapter Input AC 120V/60Hz  
 M/N : MP32-ARGON2-MIRROR  
 Test Mode : IEEE 802.11n HT20 TX 5825MHz

	Freq. (MHz)	Ant. Factor (dB/m)	Cable Loss (dB)	Amp Factor (dB)	Reading (dBuV)	Emission Level (dBuV/m)	Limits (dBuV/m)	Margin (dB)	Remark
1	2989.00	28.56	2.17	34.41	44.03	40.35	68.20	27.85	Peak
2	5825.00	32.83	4.11	34.37	79.22	81.79	68.20	-13.59	Peak
3	11650.00	39.90	6.08	34.69	24.19	35.48	74.00	38.52	Peak
4	14498.00	41.00	6.90	34.45	27.20	40.65	74.00	33.35	Peak
5	17475.00	44.70	7.89	34.35	19.64	37.88	68.20	30.32	Peak
6	17932.00	48.36	8.20	34.31	19.71	41.96	74.00	32.04	Peak

Remarks: 1. Emission Level= Antenna Factor + Cable Loss - Amp Factor + Reading.  
 2. Margin= Limit - Emission Level.  
 3. The emission levels that are 20dB below the official limit are not reported.

Note:

1. The amplitude of 18GHz to 40GHz spurious emission that is attenuated by more than 20dB below the permissible limit has no need to be reported.
2. All test mode had been pre-test, only Low/Middle/High Channel of the worst case modulation mode was reported



### Band Edge

EST Technology

Chilingxiang, Qishantou, Santun,  
Houjie, Dongguan, Guangdong, China  
Tel: +86-769-83081888  
Fax: +86-769-83081878

Data: 99 File: \\Emc-966-1\test data\2020\RF\W\WANLIDA\MP32-ARGON2-MIRROR.EM6 (176) Date: 2020-09-15

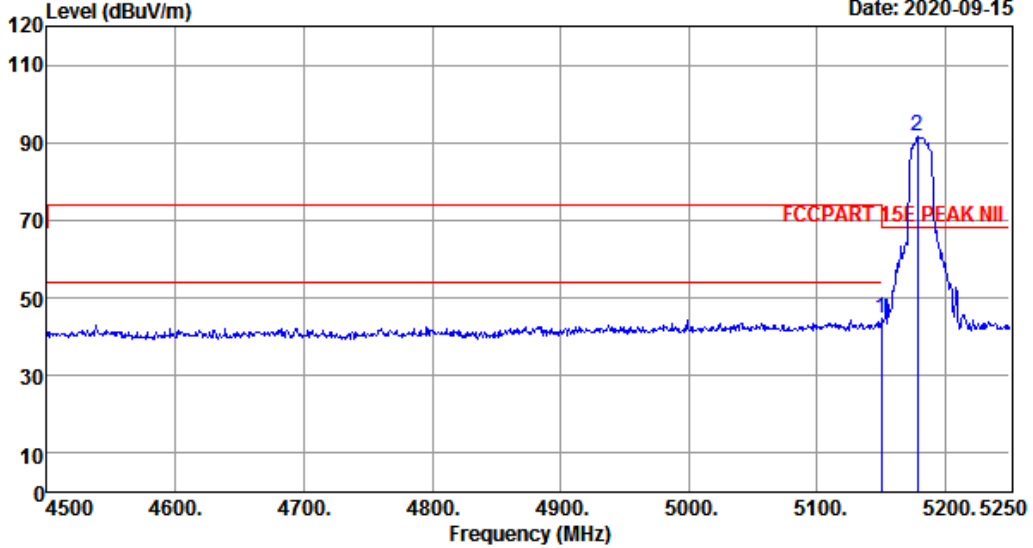

Site no. : 1# 966 Chamber Data no. : 99  
 Dis. / Ant. : 3m ANT9120D 1-18G Ant. pol. : HORIZONTAL  
 Limit : FCCPART 15E PEAK NII  
 Env. / Ins. : Temp:26.4';Humi:54%;Press:101.52kPa  
 Engineer : Pablo  
 EUT : Tablet  
 Power : DC 24V From Adapter Input AC 120V/60Hz  
 M/N : MP32-ARGON2-MIRROR  
 Test Mode : IEEE 802.11n HT20 TX 5180MHz

	Freq. (MHz)	Ant. Factor (dB/m)	Cable Loss (dB)	Amp Factor (dB)	Reading (dBuV)	Emission Level (dBuV/m)	Limits (dBuV/m)	Margin (dB)	Remark
1	5150.00	32.13	3.50	34.64	43.95	44.94	68.20	23.26	Peak
2	5178.00	32.20	3.52	34.63	90.35	91.44	68.20	-23.24	Peak

Remarks: 1. Emission Level= Antenna Factor + Cable Loss - Amp Factor + Reading.  
 2. Margin= Limit - Emission Level.  
 3. The emission levels that are 20dB below the official limit are not reported.

EST Technology

Chilingxiang, Qishantou, Santun,  
Houjie, Dongguan, Guangdong, China  
Tel: +86-769-83081888  
Fax: +86-769-83081878

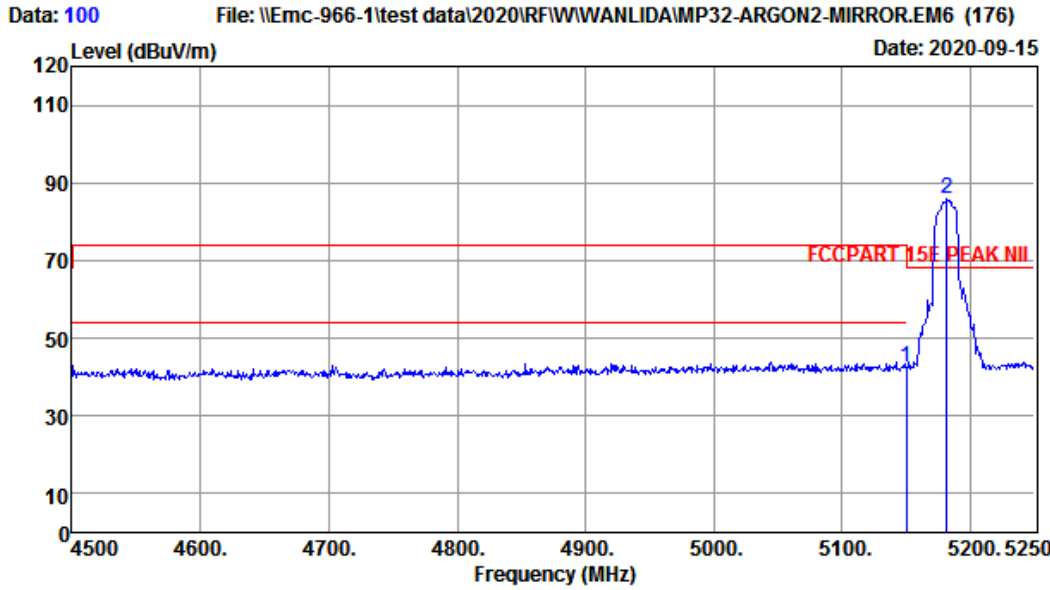

Site no. : 1# 966 Chamber Data no. : 100  
 Dis. / Ant. : 3m ANT9120D 1-18G Ant. pol. : VERTICAL  
 Limit : FCCPART 15E PEAK NII  
 Env. / Ins. : Temp:26.4';Humi:54%;Press:101.52kPa  
 Engineer : Pablo  
 EUT : Tablet  
 Power : DC 24V From Adapter Input AC 120V/60Hz  
 M/N : MP32-ARGON2-MIRROR  
 Test Mode : IEEE 802.11n HT20 TX 5180MHz

	Freq. (MHz)	Ant. Factor (dB/m)	Cable Loss (dB)	Amp Factor (dB)	Reading (dBuV)	Emission Level (dBuV/m)	Limits (dBuV/m)	Margin (dB)	Remark
1	5150.00	32.13	3.50	34.64	41.55	42.54	68.20	25.66	Peak
2	5181.75	32.20	3.52	34.63	84.73	85.82	68.20	-17.62	Peak

Remarks: 1. Emission Level= Antenna Factor + Cable Loss - Amp Factor + Reading.  
 2. Margin= Limit - Emission Level.  
 3. The emission levels that are 20dB below the official limit are not reported.

EST Technology

Chilingxiang, Qishantou, Santun,  
Houjie, Dongguan, Guangdong, China  
Tel: +86-769-83081888  
Fax: +86-769-83081878

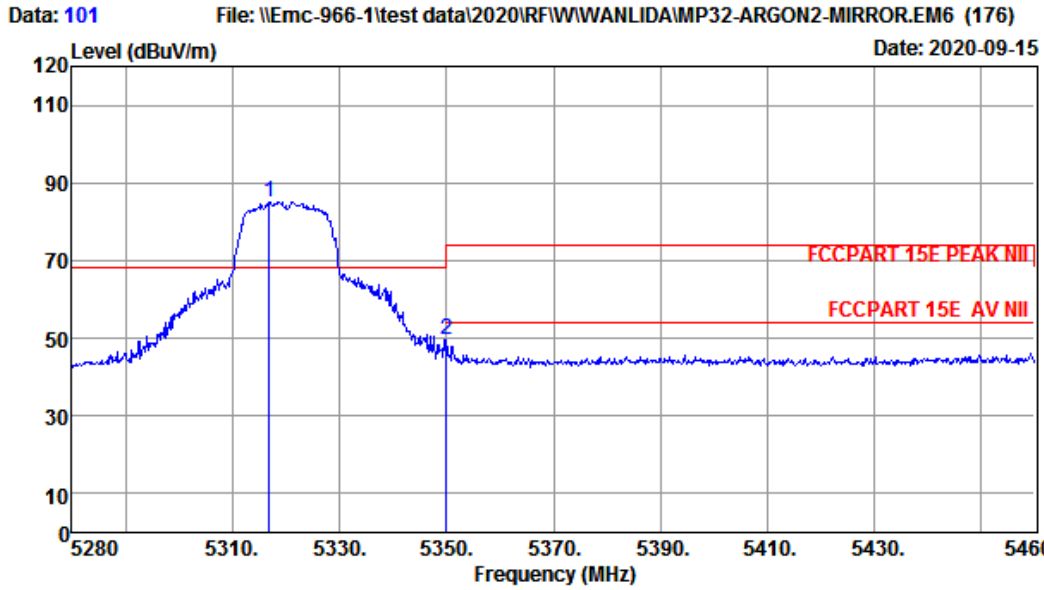

Site no. : 1# 966 Chamber Data no. : 101  
 Dis. / Ant. : 3m ANT9120D 1-18G Ant. pol. : VERTICAL  
 Limit : FCCPART 15E PEAK NII  
 Env. / Ins. : Temp:26.4';Humi:54%;Press:101.52kPa  
 Engineer : Pablo  
 EUT : Tablet  
 Power : DC 24V From Adapter Input AC 120V/60Hz  
 M/N : MP32-ARGON2-MIRROR  
 Test Mode : IEEE 802.11n HT20 TX 5320MHz

	Freq. (MHz)	Ant. Factor (dB/m)	Cable Loss (dB)	Amp Factor (dB)	Reading (dBuV)	Emission Level (dBuV/m)	Limits (dBuV/m)	Margin (dB)	Remark
1	5316.90	32.50	3.60	34.57	83.67	85.20	68.20	-17.00	Peak
2	5350.00	32.57	3.62	34.56	48.05	49.68	68.20	18.52	Peak

Remarks: 1. Emission Level= Antenna Factor + Cable Loss - Amp Factor + Reading.  
 2. Margin= Limit - Emission Level.  
 3. The emission levels that are 20dB below the official limit are not reported.

Data: 102 File: \\Emc-966-1\test data\2020\RF\W\WANLIDA\MP32-ARGON2-MIRROR.EM6 (176) Date: 2020-09-15

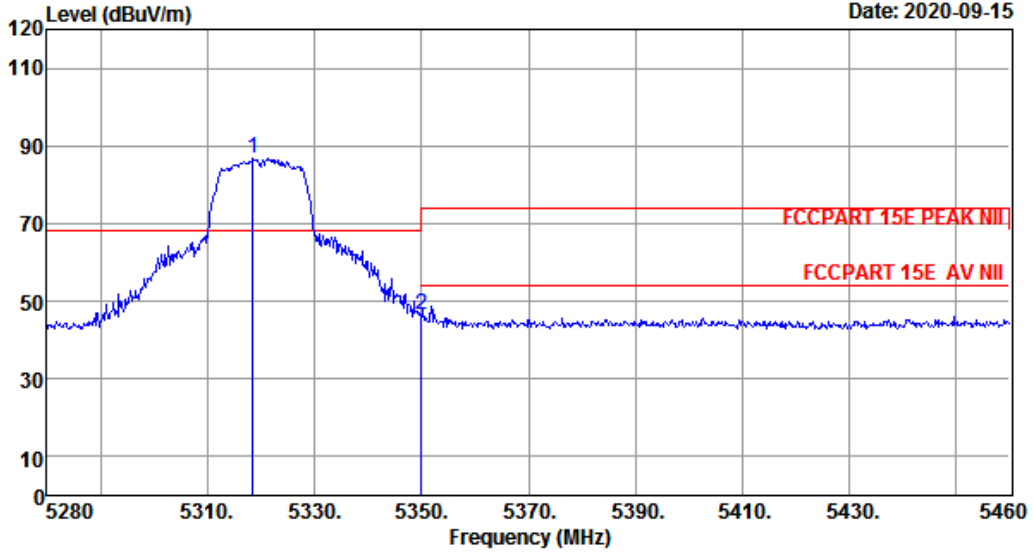

Site no. : 1# 966 Chamber Data no. : 102  
 Dis. / Ant. : 3m ANT9120D 1-18G Ant. pol. : HORIZONTAL  
 Limit : FCCPART 15E PEAK NII  
 Env. / Ins. : Temp:26.4';Humi:54%;Press:101.52kPa  
 Engineer : Pablo  
 EUT : Tablet  
 Power : DC 24V From Adapter Input AC 120V/60Hz  
 M/N : MP32-ARGON2-MIRROR  
 Test Mode : IEEE 802.11n HT20 TX 5320MHz

	Freq. (MHz)	Ant. Factor (dB/m)	Cable Loss (dB)	Amp Factor (dB)	Reading (dBuV)	Emission Level (dBuV/m)	Limits (dBuV/m)	Margin (dB)	Remark
1	5318.46	32.50	3.60	34.57	85.16	86.69	68.20	-18.49	Peak
2	5350.00	32.57	3.62	34.56	45.05	46.68	68.20	21.52	Peak

Remarks: 1. Emission Level= Antenna Factor + Cable Loss - Amp Factor + Reading.  
 2. Margin= Limit - Emission Level.  
 3. The emission levels that are 20dB below the official limit are not reported.

EST Technology

Chilingxiang, Qishantou, Santun,  
Houjie, Dongguan, Guangdong, China  
Tel: +86-769-83081888  
Fax: +86-769-83081878

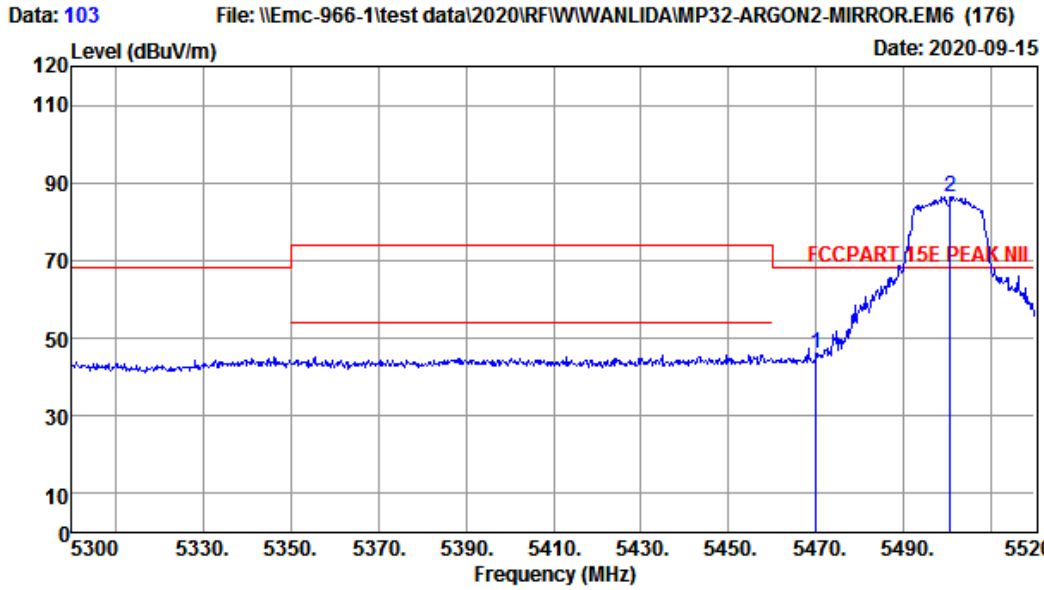

Site no. : 1# 966 Chamber Data no. : 103  
 Dis. / Ant. : 3m ANT9120D 1-18G Ant. pol. : VERTICAL  
 Limit : FCCPART 15E PEAK NII  
 Env. / Ins. : Temp:26.4';Humi:54%;Press:101.52kPa  
 Engineer : Pablo  
 EUT : Tablet  
 Power : DC 24V From Adapter Input AC 120V/60Hz  
 M/N : MP32-ARGON2-MIRROR  
 Test Mode : IEEE 802.11n HT20 TX 5500MHz

	Freq. (MHz)	Ant. Factor (dB/m)	Cable Loss (dB)	Amp Factor (dB)	Reading (dBuV)	Emission Level (dBuV/m)	Limits (dBuV/m)	Margin (dB)	Remark
1	5470.00	32.83	3.69	34.51	44.09	46.10	68.20	22.10	Peak
2	5500.64	32.90	3.71	34.50	84.19	86.30	68.20	-18.10	Peak

Remarks: 1. Emission Level= Antenna Factor + Cable Loss - Amp Factor + Reading.  
 2. Margin= Limit - Emission Level.  
 3. The emission levels that are 20dB below the official limit are not reported.

Data: 104 File: \\Emc-966-1\test data\2020\RF\W\WANLIDA\MP32-ARGON2-MIRROR.EM6 (176) Date: 2020-09-15

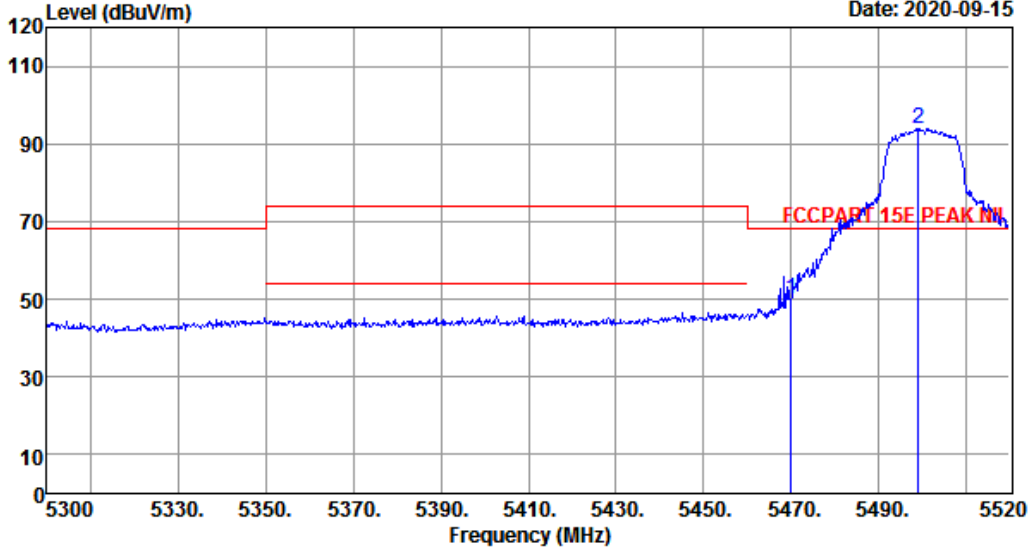

Site no. : 1# 966 Chamber Data no. : 104  
 Dis. / Ant. : 3m ANT9120D 1-18G Ant. pol. : HORIZONTAL  
 Limit : FCCPART 15E PEAK NII  
 Env. / Ins. : Temp:26.4';Humi:54%;Press:101.52kPa  
 Engineer : Pablo  
 EUT : Tablet  
 Power : DC 24V From Adapter Input AC 120V/60Hz  
 M/N : MP32-ARGON2-MIRROR  
 Test Mode : IEEE 802.11n HT20 TX 5500MHz

	Freq. (MHz)	Ant. Factor (dB/m)	Cable Loss (dB)	Amp Factor (dB)	Reading (dBuV)	Emission Level (dBuV/m)	Limits (dBuV/m)	Margin (dB)	Remark
1	5470.00	32.83	3.69	34.51	48.06	50.07	68.20	18.13	Peak
2	5499.10	32.90	3.71	34.50	91.92	94.03	68.20	-25.83	Peak

Remarks: 1. Emission Level= Antenna Factor + Cable Loss - Amp Factor + Reading.  
 2. Margin= Limit - Emission Level.  
 3. The emission levels that are 20dB below the official limit are not reported.

EST Technology

Chilingxiang, Qishantou, Santun,  
Houjie, Dongguan, Guangdong, China  
Tel: +86-769-83081888  
Fax: +86-769-83081878

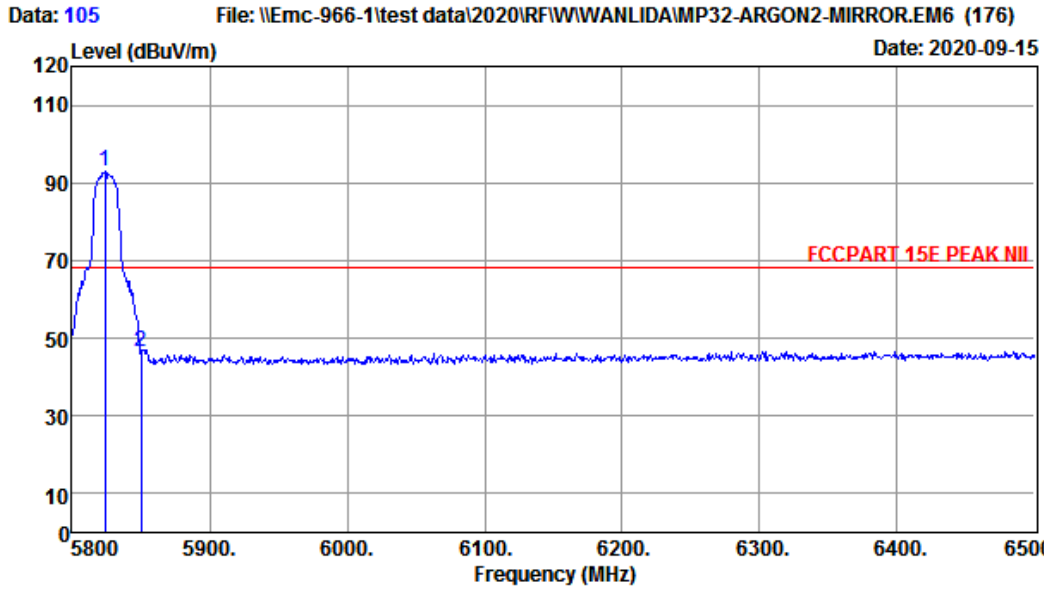

Site no. : 1# 966 Chamber Data no. : 105  
 Dis. / Ant. : 3m ANT9120D 1-18G Ant. pol. : HORIZONTAL  
 Limit : FCCPART 15E PEAK NIL  
 Env. / Ins. : Temp:26.4';Humi:54%;Press:101.52kPa  
 Engineer : Pablo  
 EUT : Tablet  
 Power : DC 24V From Adapter Input AC 120V/60Hz  
 M/N : MP32-ARGON2-MIRROR  
 Test Mode : IEEE 802.11n HT20 TX 5825MHz

	Freq. (MHz)	Ant. Factor (dB/m)	Cable Loss (dB)	Amp Factor (dB)	Reading (dBuV)	Emission Level (dBuV/m)	Limits (dBuV/m)	Margin (dB)	Remark
1	5823.80	32.83	4.11	34.37	90.24	92.81	68.20	-24.61	Peak
2	5850.00	32.83	4.13	34.36	43.97	46.57	68.20	21.63	Peak

Remarks: 1. Emission Level= Antenna Factor + Cable Loss - Amp Factor + Reading.  
 2. Margin= Limit - Emission Level.  
 3. The emission levels that are 20dB below the official limit are not reported.



EST Technology

Chilingxiang, Qishantou, Santun,  
Houjie, Dongguan, Guangdong, China  
Tel: +86-769-83081888  
Fax: +86-769-83081878

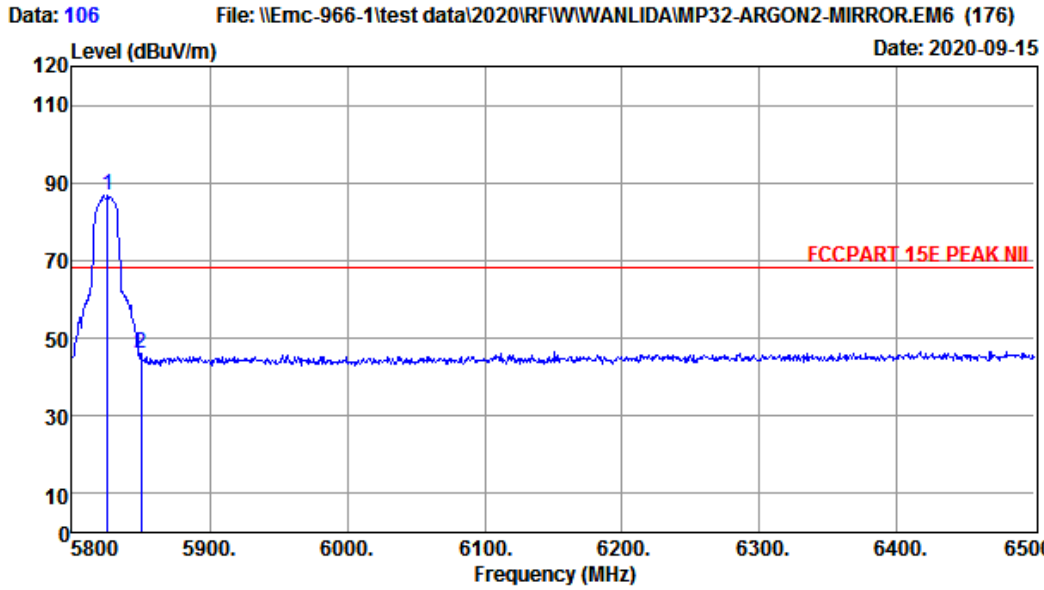

Site no. : 1# 966 Chamber Data no. : 106  
 Dis. / Ant. : 3m ANT9120D 1-18G Ant. pol. : VERTICAL  
 Limit : FCCPART 15E PEAK NIL  
 Env. / Ins. : Temp:26.4';Humi:54%;Press:101.52kPa  
 Engineer : Pablo  
 EUT : Tablet  
 Power : DC 24V From Adapter Input AC 120V/60Hz  
 M/N : MP32-ARGON2-MIRROR  
 Test Mode : IEEE 802.11n HT20 TX 5825MHz

	Freq. (MHz)	Ant. Factor (dB/m)	Cable Loss (dB)	Amp Factor (dB)	Reading (dBuV)	Emission Level (dBuV/m)	Limits (dBuV/m)	Margin (dB)	Remark
1	5825.90	32.83	4.11	34.37	84.43	87.00	68.20	-18.80	Peak
2	5850.00	32.83	4.13	34.36	43.30	45.90	68.20	22.30	Peak

Remarks: 1. Emission Level= Antenna Factor + Cable Loss - Amp Factor + Reading.  
 2. Margin= Limit - Emission Level.  
 3. The emission levels that are 20dB below the official limit are not reported.

### IEEE 802.11a 5745MHz

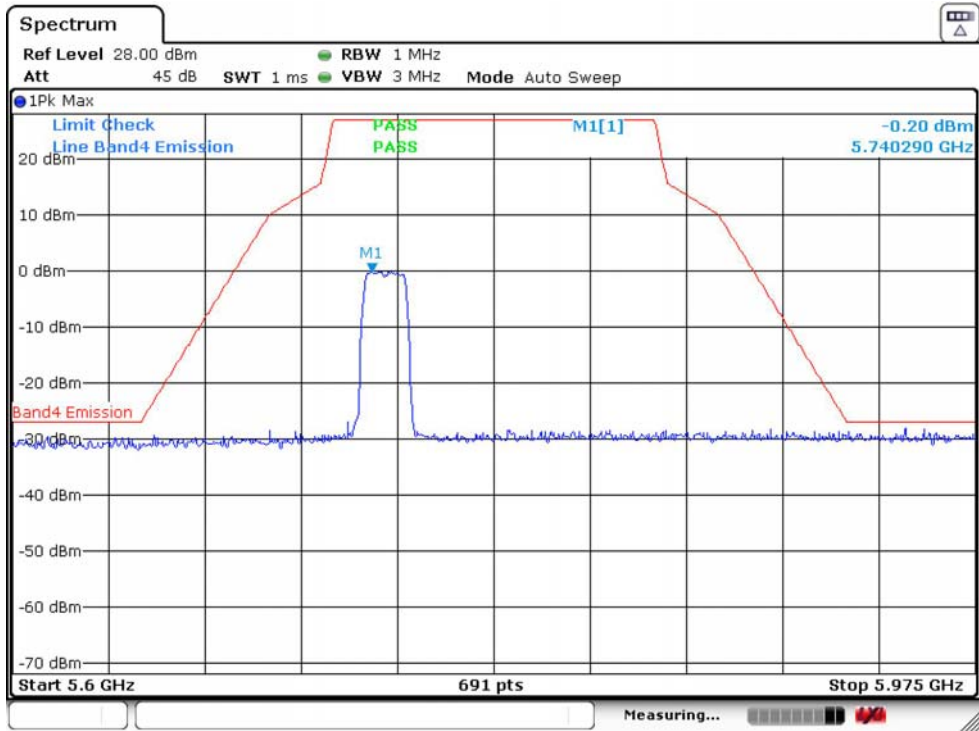

### IEEE 802.11a 5825MHz

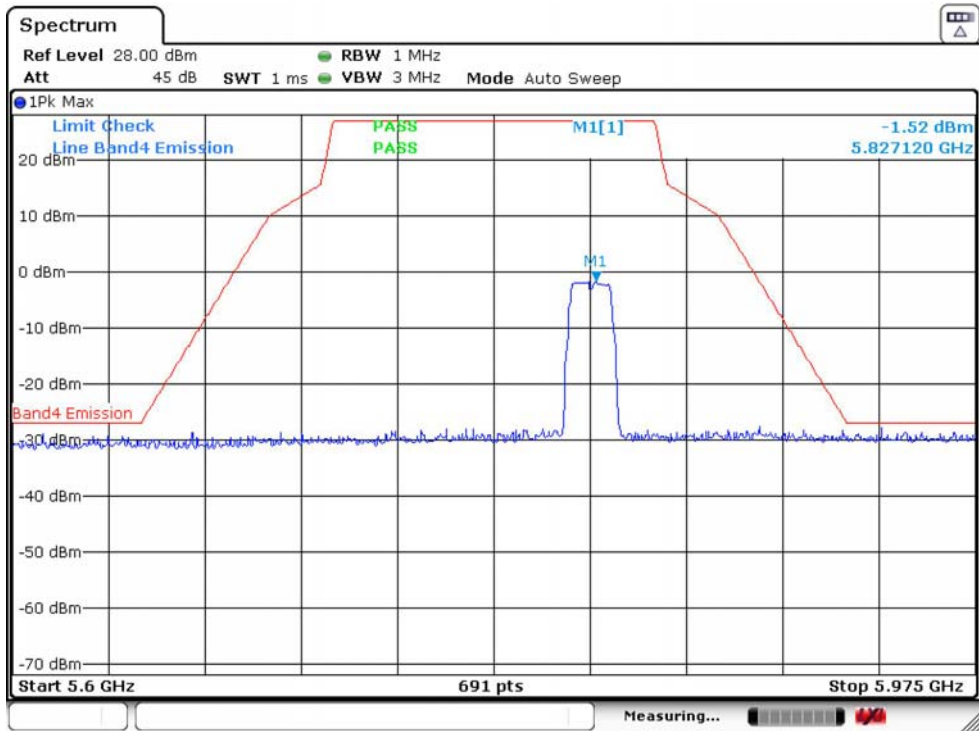

### IEEE 802.11n HT20 5745MHz

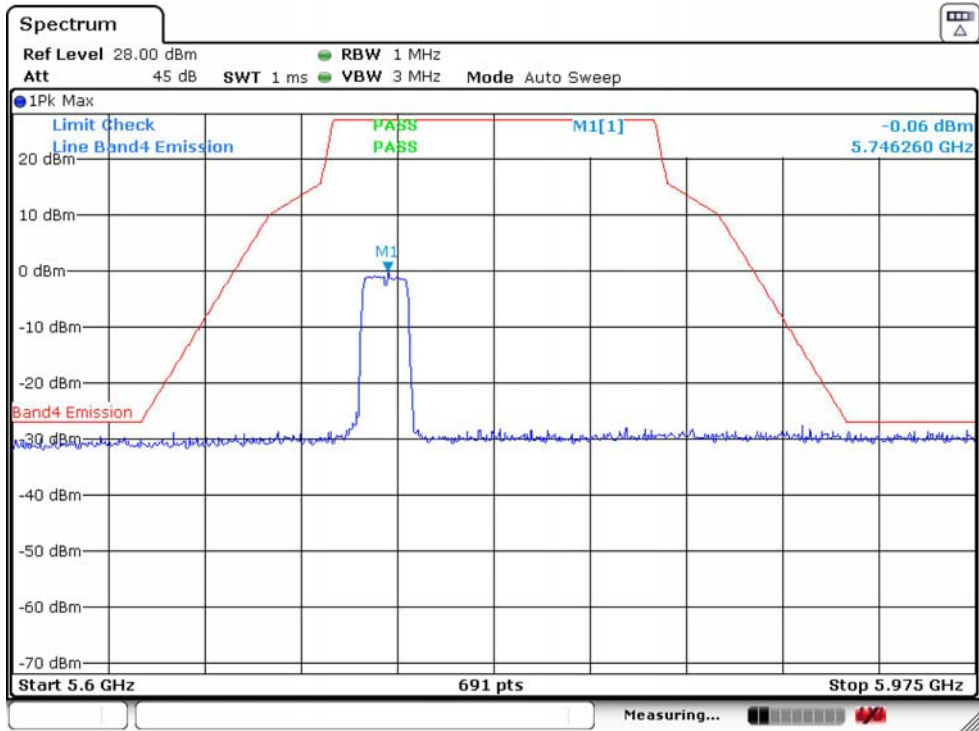

### IEEE 802.11n HT20 5825MHz

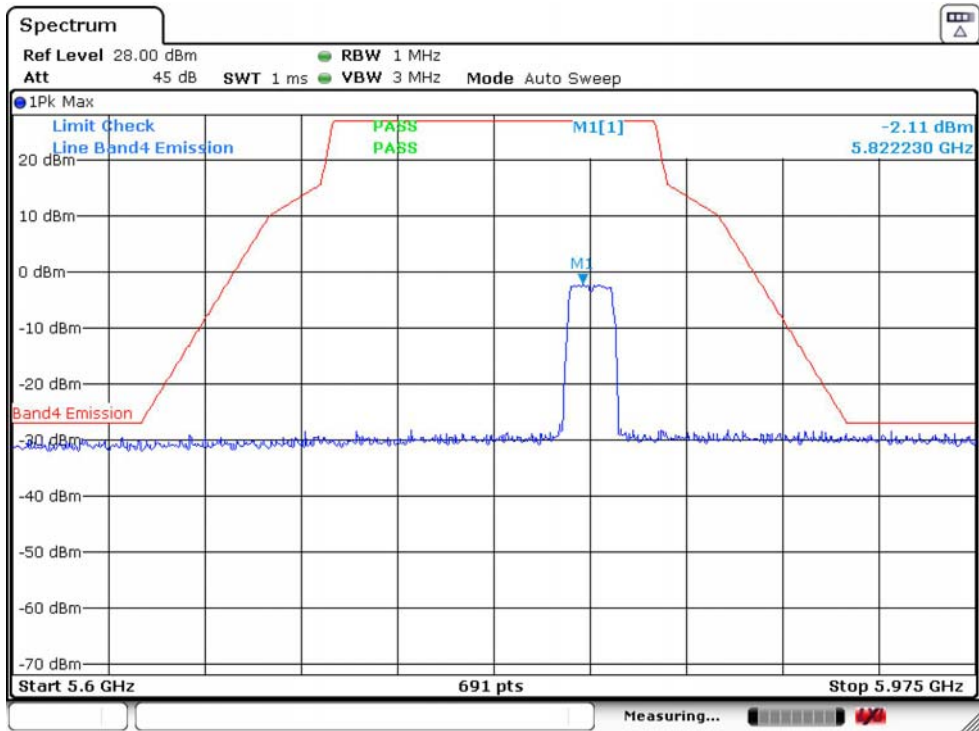

### IEEE 802.11n HT40 5755

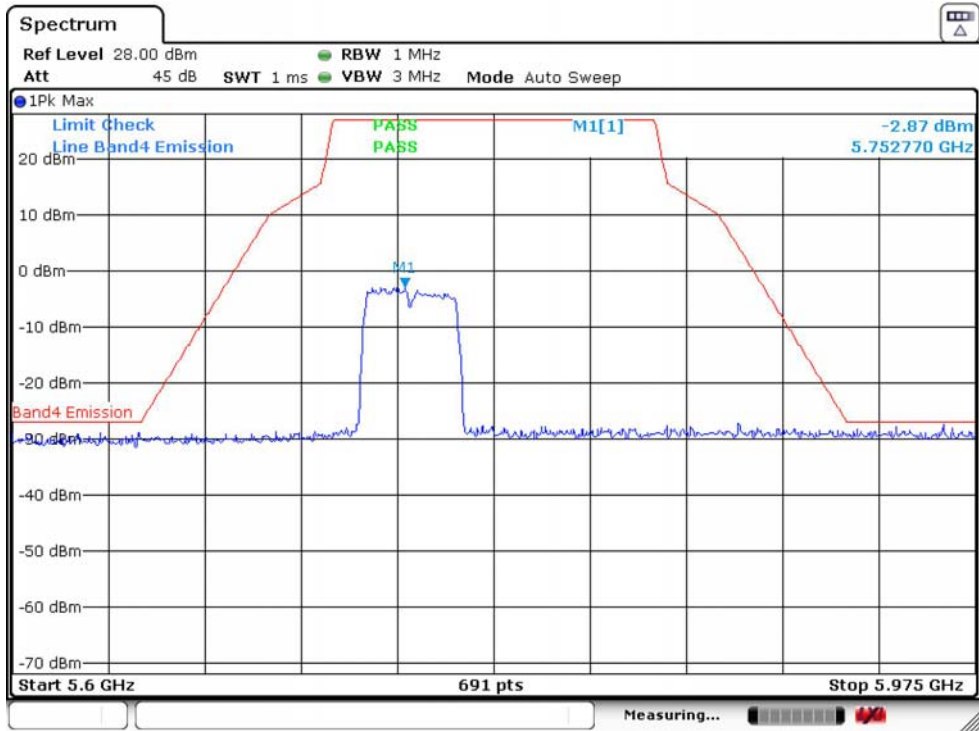

### IEEE 802.11n HT40 5795

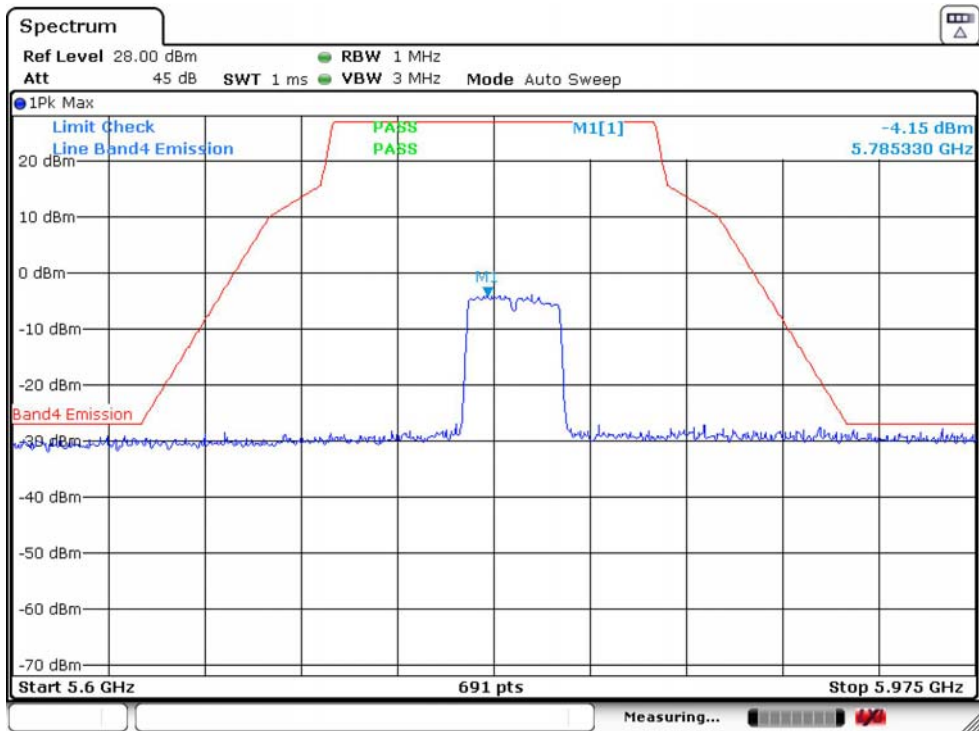

All modulations are all tested ,only worse case is reported

**18000MHz-40000MHz**

Pass

Note: The amplitude of spurious emission that is attenuated by more than 20dB below the permissible limit has no need to be reported.

## 7. FREQUENCY STABILITY

### 7.1. Limit

Manufacturers of U-NII devices are responsible for ensuring frequency stability such that an emission is maintained within the band of operation under all conditions of normal operation as specified in the operational description.

### 7.2. Test Setup

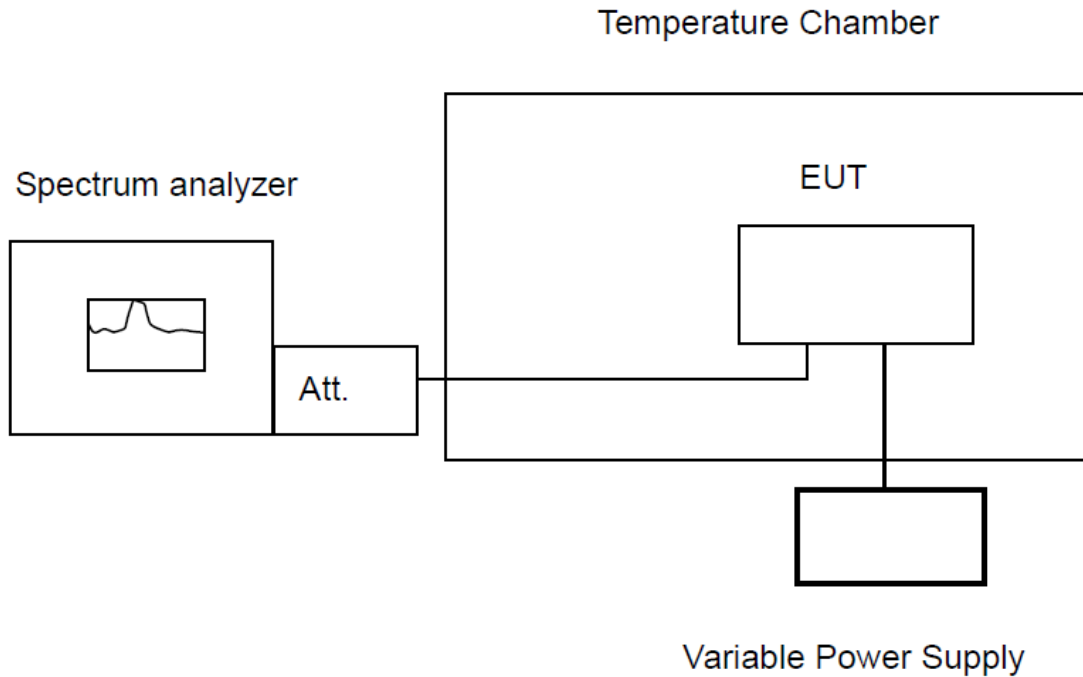

### 7.3. Spectrum Analyzer Setting

Spectrum Parameters	Setting
RBW	10KHz
VBW	10KHz
Span	200KHz
Sweep Time	Auto
Detector	PEAK
Trace Mode	Max Hold

## 7.4. Test Procedure

### **For measurement frequency stability under temperature variation :**

- a. Supply the EUT with a nominal ac voltage or install a new or fully charged battery in the EUT.
- b. Turn the EUT OFF and place it inside the environmental temperature chamber.
- c. Connect EUT antenna terminal to the spectrum analyzer with RF cable.
- d. Spectrum analyzer setting parameters in accordance with section 7.3.
- e. Set the temperature control on the chamber to the Specified temperature and allow the oscillator heater and the chamber temperature to stabilize.
- f. Turn the EUT ON with the rated voltage, and the EUT transmit continuously with maximum output power.
- g. Record the operating frequency at startup, and at 2 minutes, 5 minutes, and 10 minutes after the EUT is energized.
- h. Repeat step d through step f to measured the temperature form  $-20^{\circ}\text{C}$  to  $+50^{\circ}\text{C}$  in  $10^{\circ}\text{C}$  steps.

### **For frequency stability under voltage variation:**

- a. Supply the EUT with a nominal ac voltage or install a new or fully charged battery in the EUT.
- b. Turn the EUT OFF and place it inside the environmental temperature chamber.
- c. Connect EUT antenna terminal to the spectrum analyzer with RF cable.
- d. Spectrum analyzer setting parameters in accordance with section 7.3.
- e. Unless otherwise specified, set the temperature control on the chamber to the ambient room temperature ( $+15^{\circ}\text{C}$  to  $+25^{\circ}\text{C}$ ) and allow the oscillator heater and the chamber temperature to stabilize.
- f. Turn the EUT ON with the rated voltage, and the EUT transmit continuously with maximum output power.
- g. Record the operating frequency.
- h. Repeat step d through step f to measured the varied from 85% to 115% of the rated voltage.



7.5. Test Result

Frequency (MHz)	Voltage (V)	Temperature (°C)	Time (minutes)	Measurement Value (MHz)	Frequency Error (ppm)
5180	120	50	0	5180.0020000	0.39
			2	5180.0060000	1.16
			5	5180.0070000	1.35
			10	5180.0040000	0.77
	120	40	0	5180.0030000	0.58
			2	5180.0060000	1.16
			5	5180.0020000	0.39
			10	5180.0030000	0.58
	120	30	0	5180.0040000	0.77
			2	5180.0010000	0.19
			5	5180.0010000	0.19
			10	5180.0010000	0.19
	120	20	0	5180.0090000	1.74
			2	5180.0060000	1.16
			5	5180.0090000	1.74
			10	5180.0020000	0.39
	120	10	0	5180.0060000	1.16
			2	5180.0090000	1.74
			5	5180.0090000	1.74
			10	5180.0050000	0.97
	120	0	0	5180.0070000	1.35
			2	5180.0050000	0.97
			5	5180.0050000	0.97
			10	5180.0070000	1.35
	120	-10	0	5180.0030000	0.58
			2	5180.0070000	1.35
			5	5180.0030000	0.58
			10	5180.0070000	1.35
	120	-20	0	5180.0060000	1.16
			2	5180.0040000	0.77
			5	5180.0010000	0.19
			10	5180.0020000	0.39
	120	20	/	5180.0070000	1.35
	102	20	/	5180.0020000	0.39
	138	20	/	5180.0050000	0.97
	<b>MAX Frquency Error(ppm)</b>				

Frequency (MHz)	Voltage (V)	Temperature (°C)	Time (minutes)	Measurement Value (MHz)	Frequency Error (ppm)
5320	120	50	0	5320.0030000	0.56
			2	5320.0030000	0.56
			5	5320.0020000	0.38
			10	5320.0020000	0.38
	120	40	0	5320.0040000	0.75
			2	5320.0070000	1.32
			5	5320.0090000	1.69
			10	5320.0090000	1.69
	120	30	0	5320.0050000	0.94
			2	5320.0090000	1.69
			5	5320.0010000	0.19
			10	5320.0070000	1.32
	120	20	0	5320.0050000	0.94
			2	5320.0060000	1.13
			5	5320.0020000	0.38
			10	5320.0060000	1.13
	120	10	0	5320.0070000	1.32
			2	5320.0050000	0.94
			5	5320.0060000	1.13
			10	5320.0050000	0.94
	120	0	0	5320.0020000	0.38
			2	5320.0060000	1.13
			5	5320.0090000	1.69
			10	5320.0080000	1.50
	120	-10	0	5320.0030000	0.56
			2	5320.0030000	0.56
			5	5320.0050000	0.94
			10	5320.0060000	1.13
	120	-20	0	5320.0060000	1.13
			2	5320.0030000	0.56
			5	5320.0050000	0.94
			10	5320.0080000	1.50
120	20	/	5320.0040000	0.75	
102	20	/	5320.0080000	1.50	
138	20	/	5320.0090000	1.69	
<b>MAX Frquency Error(ppm)</b>					<b>1.69</b>

Frequency (MHz)	Voltage (V)	Temperature (°C)	Time (minutes)	Measurement Value (MHz)	Frequency Error (ppm)
5500	120	50	0	5500.0070000	1.27
			2	5500.0080000	1.45
			5	5500.0010000	0.18
			10	5500.0070000	1.27
	120	40	0	5500.0080000	1.45
			2	5500.0060000	1.09
			5	5500.0050000	0.91
			10	5500.0090000	1.64
	120	30	0	5500.0080000	1.45
			2	5500.0040000	0.73
			5	5500.0040000	0.73
			10	5500.0090000	1.64
	120	20	0	5500.0080000	1.45
			2	5500.0090000	1.64
			5	5500.0070000	1.27
			10	5500.0090000	1.64
	120	10	0	5500.0010000	0.18
			2	5500.0070000	1.27
			5	5500.0090000	1.64
			10	5500.0070000	1.27
	120	0	0	5500.0080000	1.45
			2	5500.0020000	0.36
			5	5500.0040000	0.73
			10	5500.0090000	1.64
	120	-10	0	5500.0090000	1.64
			2	5500.0010000	0.18
			5	5500.0020000	0.36
			10	5500.0030000	0.55
	120	-20	0	5500.0040000	0.73
			2	5500.0080000	1.45
			5	5500.0010000	0.18
			10	5500.0090000	1.64
120	20	/	5500.0020000	0.36	
102	20	/	5500.0060000	1.09	
138	20	/	5500.0090000	1.64	
<b>MAX Frquency Error(ppm)</b>					<b>1.64</b>

Frequency (MHz)	Voltage (V)	Temperature (°C)	Time (minutes)	Measurement Value (MHz)	Frequency Error (ppm)
5745	120	50	0	5745.0030000	0.52
			2	5745.0080000	1.39
			5	5745.0020000	0.35
			10	5745.0090000	1.57
	120	40	0	5745.0060000	1.04
			2	5745.0020000	0.35
			5	5745.0030000	0.52
			10	5745.0030000	0.52
	120	30	0	5745.0090000	1.57
			2	5745.0060000	1.04
			5	5745.0080000	1.39
			10	5745.0020000	0.35
	120	20	0	5745.0020000	0.35
			2	5745.0040000	0.70
			5	5745.0070000	1.22
			10	5745.0070000	1.22
	120	10	0	5745.0020000	0.35
			2	5745.0020000	0.35
			5	5745.0070000	1.22
			10	5745.0030000	0.52
	120	0	0	5745.0070000	1.22
			2	5745.0050000	0.87
			5	5745.0030000	0.52
			10	5745.0090000	1.57
	120	-10	0	5745.0060000	1.04
			2	5745.0040000	0.70
			5	5745.0090000	1.57
			10	5745.0010000	0.17
	120	-20	0	5745.0050000	0.87
			2	5745.0010000	0.17
			5	5745.0020000	0.35
			10	5745.0060000	1.04
120	20	/	5745.0030000	0.52	
102	20	/	5745.0060000	1.04	
138	20	/	5745.0060000	1.04	
<b>MAX Frquency Error(ppm)</b>					<b>1.57</b>

## 8. AC POWER LINE CONDUCTED EMISSIONS

### 8.1. Limit

Frequency	Maximum RF Line Voltage	
	Quasi-Peak Level dB(μV)	Average Level dB(μV)
150kHz ~ 500kHz	66 ~ 56*	56 ~ 46*
500kHz ~ 5MHz	56	46
5MHz ~ 30MHz	60	50

Notes:

1. \* Decreasing linearly with logarithm of frequency.
2. The lower limit shall apply at the transition frequencies.

### 8.2. Test Setup

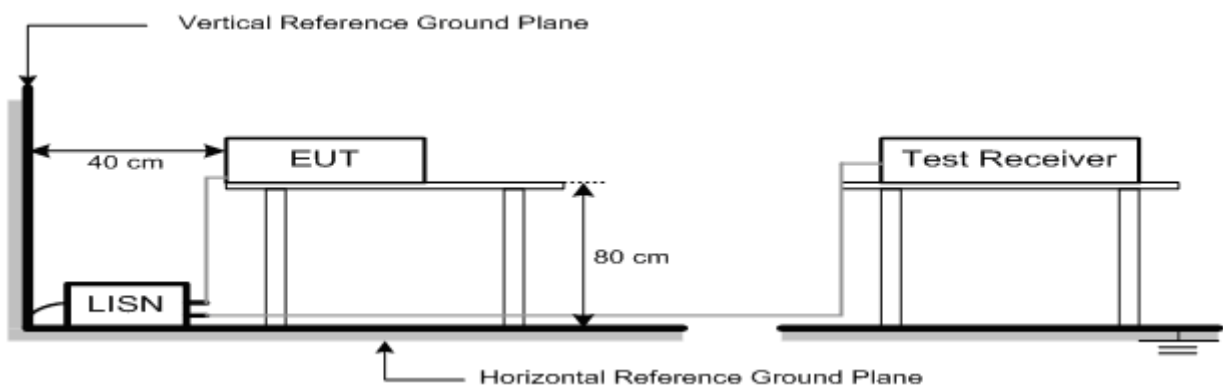

### 8.3. Spectrum Analyzer Setting

Spectrum Parameters	Setting
RBW	9KHz
VBW	9KHz
Start frequency	150KHz
Stop frequency	30MHz
Sweep Time	Auto
Detector	QP/AVG
Trace Mode	Max Hold

### 8.4. Test Procedure

- a. The EUT was placed on a non-metallic table, 80cm above the ground plane.
- b. The EUT Power connected to the power mains through a line impedance stabilization network.
- c. Provides a 50 ohm coupling impedance for the EUT (Please refer the block diagram of the test setup and photographs).
- d. Set the EUT transmit continuously with maximum output power.
- e. Spectrum analyzer setting parameters in accordance with section 8.3.
- f. The AC line are checked to find out the maximum conducted emission. In order to find the maximum emission levels, the relative positions of equipment and all of the interface cables shall be changed according to ANSI C63.10: 2013 on Conducted Emission Test.
- g. Record the results in the test report.

### 8.5. Test Result

EST Technology

Chilingxiang, Qishantou, Santun,  
Houjie, Dongguan, Guangdong, China  
Tel:+86-769-83081888  
Fax:+86-769-83081878

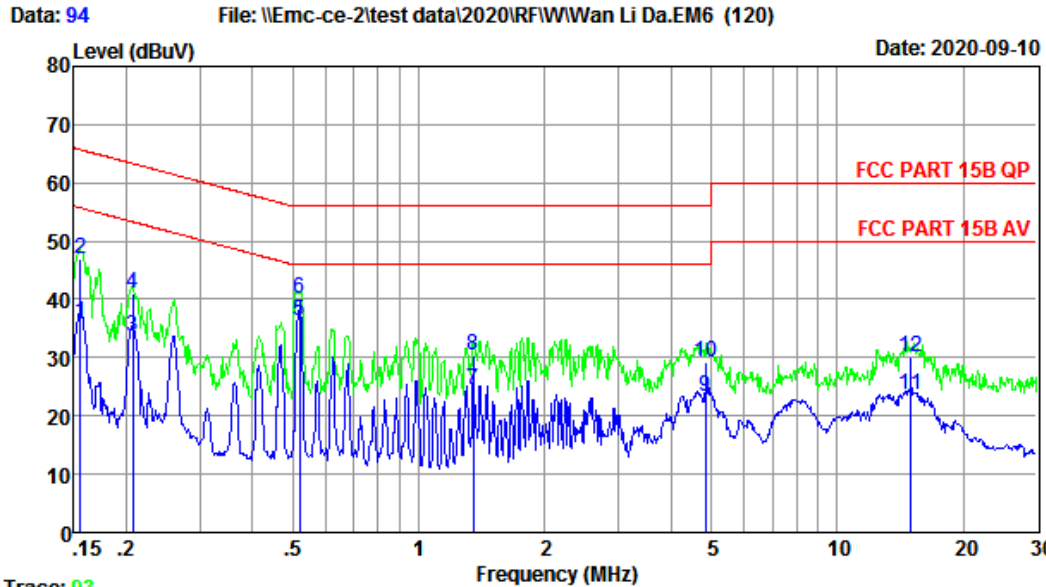

Trace: 93  
 Site no : 844 Shield Room Data no. : 94  
 Env. / Ins. : Temp:23.0°C Humi:49% Press:101.50kPa LINE Phase : LINE  
 Limit : FCC PART 15B QP  
 Engineer : ZSX  
 EUT : Tablet  
 Power : DC 24V From Adapter Input AC 240V/60Hz  
 M/N : MP32-ARGON2-MIRROR  
 Test Mode : TX Mode

	Freq. (MHz)	LISN Factor (dB)	Cable Loss (dB)	Reading (dBuV)	Emission Level (dBuV)	Limits (dBuV)	Margin (dB)	Remark
1	0.1557	9.79	9.69	16.64	36.12	65.69	29.57	Average
2	0.1557	9.79	9.69	27.55	47.03	65.69	18.66	QP
3	0.2072	9.75	9.84	13.96	33.55	63.32	29.77	Average
4	0.2072	9.75	9.84	21.34	40.93	63.32	22.39	QP
5	0.5182	9.93	9.92	16.57	36.42	56.00	19.58	Average
6	0.5182	9.93	9.92	20.18	40.03	56.00	15.97	QP
7	1.3521	9.79	9.95	4.67	24.41	56.00	31.59	Average
8	1.3521	9.79	9.95	10.71	30.45	56.00	25.55	QP
9	4.8480	9.86	10.00	3.60	23.46	56.00	32.54	Average
10	4.8480	9.86	10.00	9.42	29.28	56.00	26.72	QP
11	14.9860	9.87	10.12	3.70	23.69	60.00	36.31	Average
12	14.9860	9.87	10.12	10.19	30.18	60.00	29.82	QP

Remarks: 1. Emission Level= LISN Factor + Cable Loss + Reading.  
 2. Margin=Limit - Emission Level.  
 3. If the average limit is met when using a quasi-peak detector, the EUT shall be deemed to meet both limits and measurement with average detector is unnecessary.

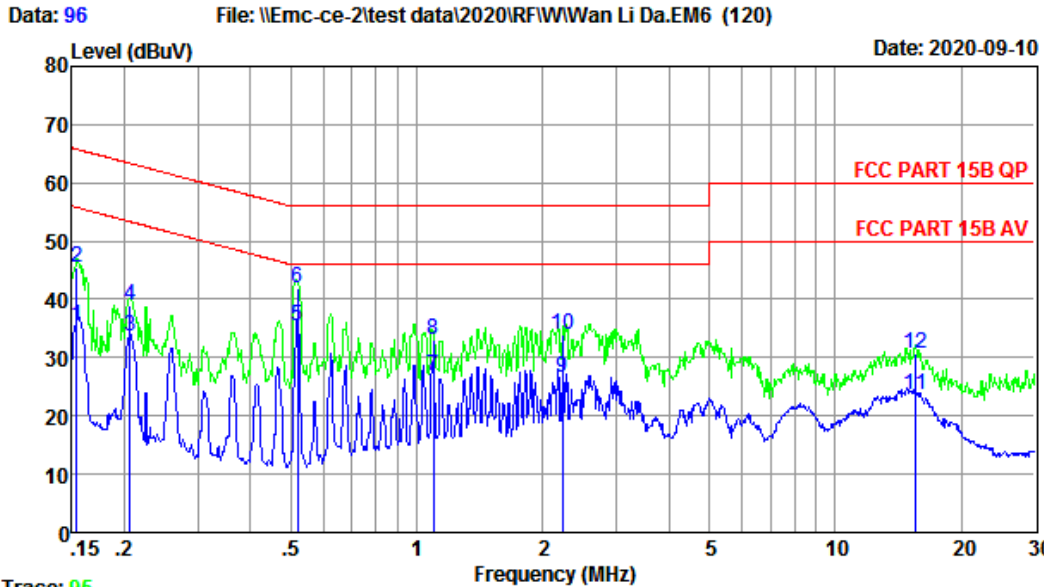

Trace: 95  
 Site no : 844 Shield Room Data no. : 96  
 Env. / Ins. : Temp:23.0'C Humi:49% Press:101.50kPa LINE Phase : NEUTRAL  
 Limit : FCC PART 15B QP  
 Engineer : ZSX  
 EUT : Tablet  
 Power : DC 24V From Adapter Input AC 240V/60Hz  
 M/N : MP32-ARGON2-MIRROR  
 Test Mode : TX Mode

	Freq. (MHz)	LISN Factor (dB)	Cable Loss (dB)	Reading (dBuV)	Emission Level (dBuV)	Limits (dBuV)	Margin (dB)	Remark
1	0.1540	9.62	9.69	16.21	35.52	65.78	30.26	Average
2	0.1540	9.62	9.69	26.18	45.49	65.78	20.29	QP
3	0.2061	9.70	9.84	14.17	33.71	63.36	29.65	Average
4	0.2061	9.70	9.84	19.34	38.88	63.36	24.48	QP
5	0.5182	9.78	9.92	15.75	35.45	56.00	20.55	Average
6	0.5182	9.78	9.92	22.34	42.04	56.00	13.96	QP
7	1.0939	9.67	9.94	7.38	26.99	56.00	29.01	Average
8	1.0939	9.67	9.94	13.44	33.05	56.00	22.95	QP
9	2.2249	9.72	9.96	6.83	26.51	56.00	29.49	Average
10	2.2249	9.72	9.96	14.22	33.90	56.00	22.10	QP
11	15.5523	9.83	10.12	3.80	23.75	60.00	36.25	Average
12	15.5523	9.83	10.12	10.73	30.68	60.00	29.32	QP

Remarks: 1. Emission Level= LISN Factor + Cable Loss + Reading.  
 2. Margin=Limit - Emission Level.  
 3. If the average limit is met when using a quasi-peak detector,  
 the EUT shall be deemed to meet both limits and measurement  
 with average detector is unnecessary.



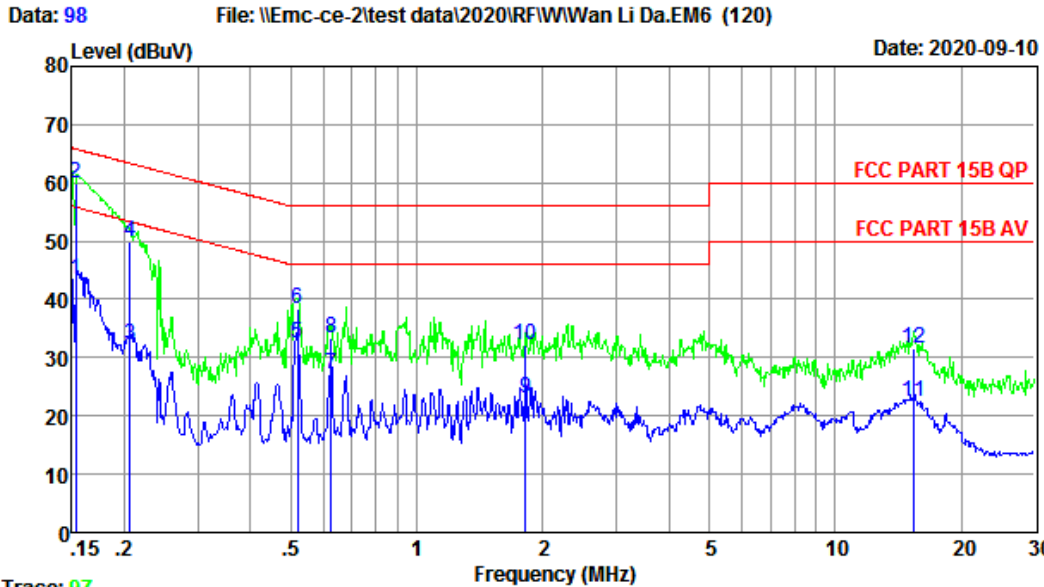

Trace: 97  
 Site no : 844 Shield Room Data no. : 98  
 Env. / Ins. : Temp:23.0'C Humi:49% Press:101.50kPa LINE Phase : LINE  
 Limit : FCC PART 15B QP  
 Engineer : ZSX  
 EUT : Tablet  
 Power : DC 24V From Adapter Input AC 120V/60Hz  
 M/N : MP32-ARGON2-MIRROR  
 Test Mode : TX Mode

	Freq. (MHz)	LISN Factor (dB)	Cable Loss (dB)	Reading (dBuV)	Emission Level (dBuV)	Limits (dBuV)	Margin (dB)	Remark
1	0.1532	9.79	9.69	23.98	43.46	65.82	22.36	Average
2	0.1532	9.79	9.69	40.33	59.81	65.82	6.01	QP
3	0.2061	9.75	9.84	12.62	32.21	63.36	31.15	Average
4	0.2061	9.75	9.84	30.42	50.01	63.36	13.35	QP
5	0.5182	9.93	9.92	12.59	32.44	56.00	23.56	Average
6	0.5182	9.93	9.92	18.59	38.44	56.00	17.56	QP
7	0.6238	9.84	9.92	7.48	27.24	56.00	28.76	Average
8	0.6238	9.84	9.92	13.53	33.29	56.00	22.71	QP
9	1.8192	9.80	9.95	3.41	23.16	56.00	32.84	Average
10	1.8192	9.80	9.95	12.34	32.09	56.00	23.91	QP
11	15.4701	9.87	10.13	2.57	22.57	60.00	37.43	Average
12	15.4701	9.87	10.13	11.65	31.65	60.00	28.35	QP

Remarks: 1. Emission Level= LISN Factor + Cable Loss + Reading.  
 2. Margin=Limit - Emission Level.  
 3. If the average limit is met when using a quasi-peak detector,  
 the EUT shall be deemed to meet both limits and measurement  
 with average detector is unnecessary.

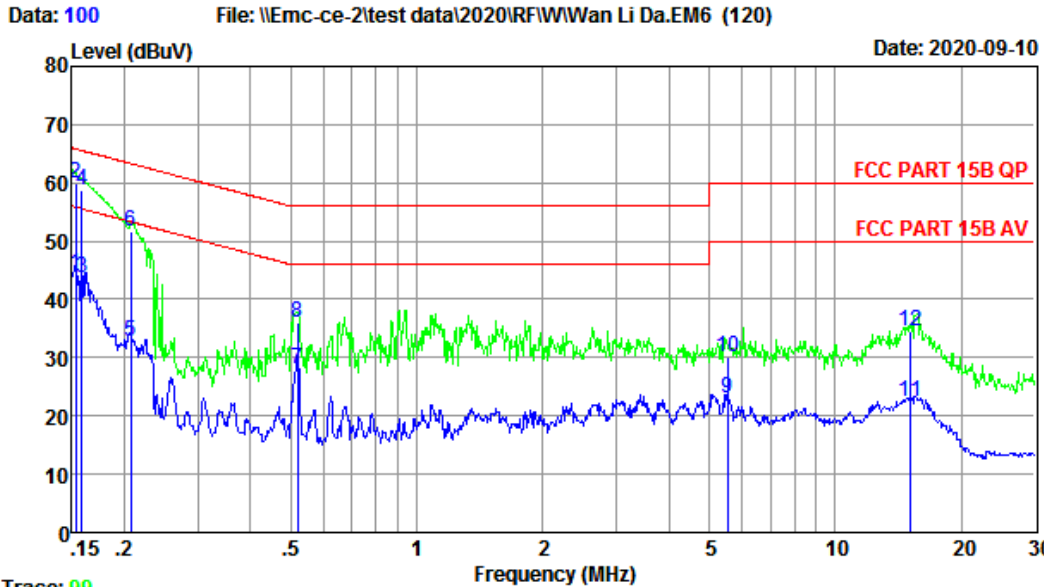

Trace: 99  
 Site no : 844 Shield Room Data no. : 100  
 Env. / Ins. : Temp:23.0'C Humi:49% Press:101.50kPa LINE Phase : NEUTRAL  
 Limit : FCC PART 15B QP  
 Engineer : ZSX  
 EUT : Tablet  
 Power : DC 24V From Adapter Input AC 120V/60Hz  
 M/N : MP32-ARGON2-MIRROR  
 Test Mode : TX Mode

	Freq. (MHz)	LISN Factor (dB)	Cable Loss (dB)	Reading (dBuV)	Emission Level (dBuV)	Limits (dBuV)	Margin (dB)	Remark
1	0.1532	9.62	9.69	24.89	44.20	65.82	21.62	Average
2	0.1532	9.62	9.69	40.65	59.96	65.82	5.86	QP
3	0.1582	9.62	9.69	24.42	43.73	65.56	21.83	Average
4	0.1582	9.62	9.69	39.35	58.66	65.56	6.90	QP
5	0.2072	9.70	9.84	13.08	32.62	63.32	30.70	Average
6	0.2072	9.70	9.84	32.12	51.66	63.32	11.66	QP
7	0.5182	9.78	9.92	8.49	28.19	56.00	27.81	Average
8	0.5182	9.78	9.92	16.35	36.05	56.00	19.95	QP
9	5.5347	9.86	10.01	3.05	22.92	60.00	37.08	Average
10	5.5347	9.86	10.01	10.11	29.98	60.00	30.02	QP
11	15.1457	9.85	10.12	2.50	22.47	60.00	37.53	Average
12	15.1457	9.85	10.12	14.53	34.50	60.00	25.50	QP

Remarks: 1. Emission Level= LISN Factor + Cable Loss + Reading.  
 2. Margin=Limit - Emission Level.  
 3. If the average limit is met when using a quasi-peak detector,  
 the EUT shall be deemed to meet both limits and measurement  
 with average detector is unnecessary.

## 9. ANTENNA REQUIREMENTS

### 9.1. Limit

An intentional radiator shall be designed to ensure that no antenna other than that furnished by the responsible party shall be used with the device. The use of a permanently attached antenna or of an antenna that uses a unique coupling to the intentional radiator shall be considered sufficient to comply with the provisions of this section. The manufacturer may design the unit so that a broken antenna can be replaced by the user, but the use of a standard antenna jack or electrical connector is prohibited. This requirement does not apply to carrier current devices or to devices operated under the provisions of §§15.211, 15.213, 15.217, 15.219, 15.221, or §15.236. Further, this requirement does not apply to intentional radiators that must be professionally installed, such as perimeter protection systems and some field disturbance sensors, or to other intentional radiators which, in accordance with §15.31(d), must be measured at the installation site. However, the installer shall be responsible for ensuring that the proper antenna is employed so that the limits in this part are not exceeded.

### 9.2. Test Result

The antennas used for this product is internal antenna ,so compliance with antenna requirements.  
( Please refer to the EUT photo for details)

# 10. TEST SETUP PHOTO

Conducted Test

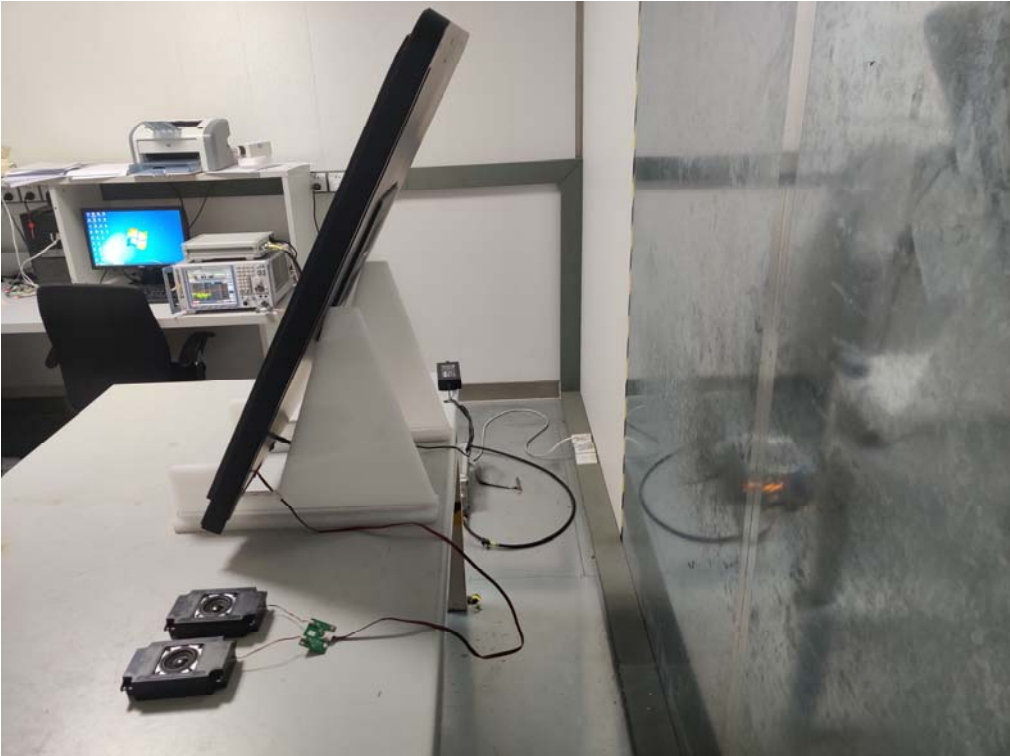

**Radiated Test (Below 1GHz)**

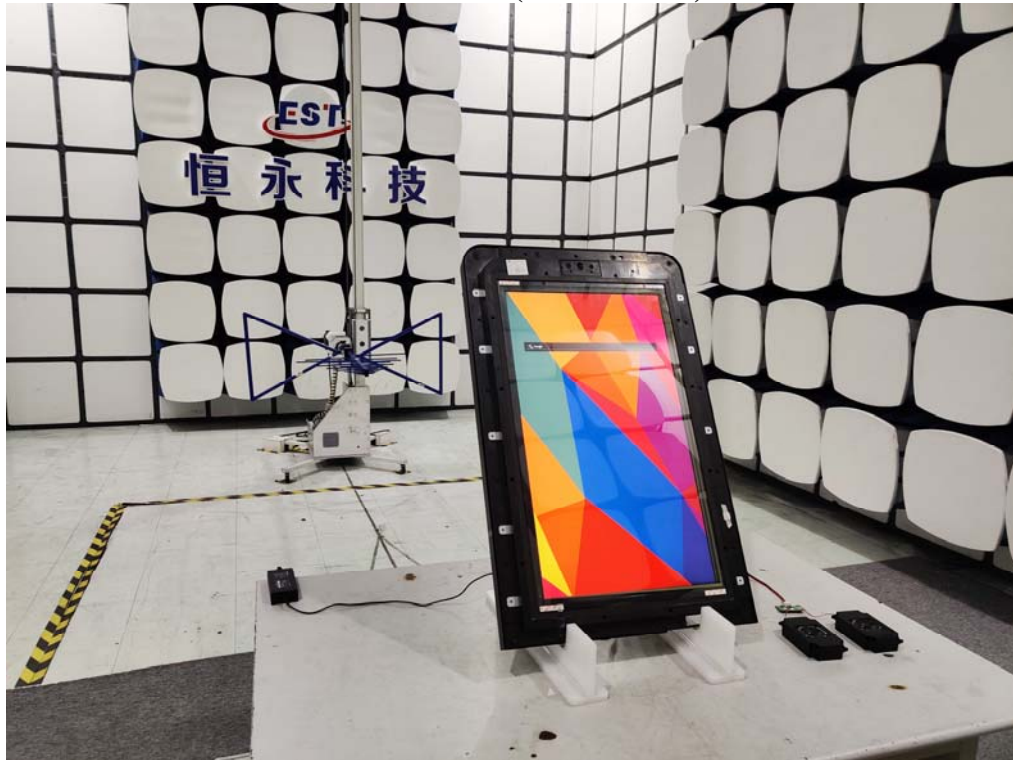

**Radiated Test (Above 1GHz)**

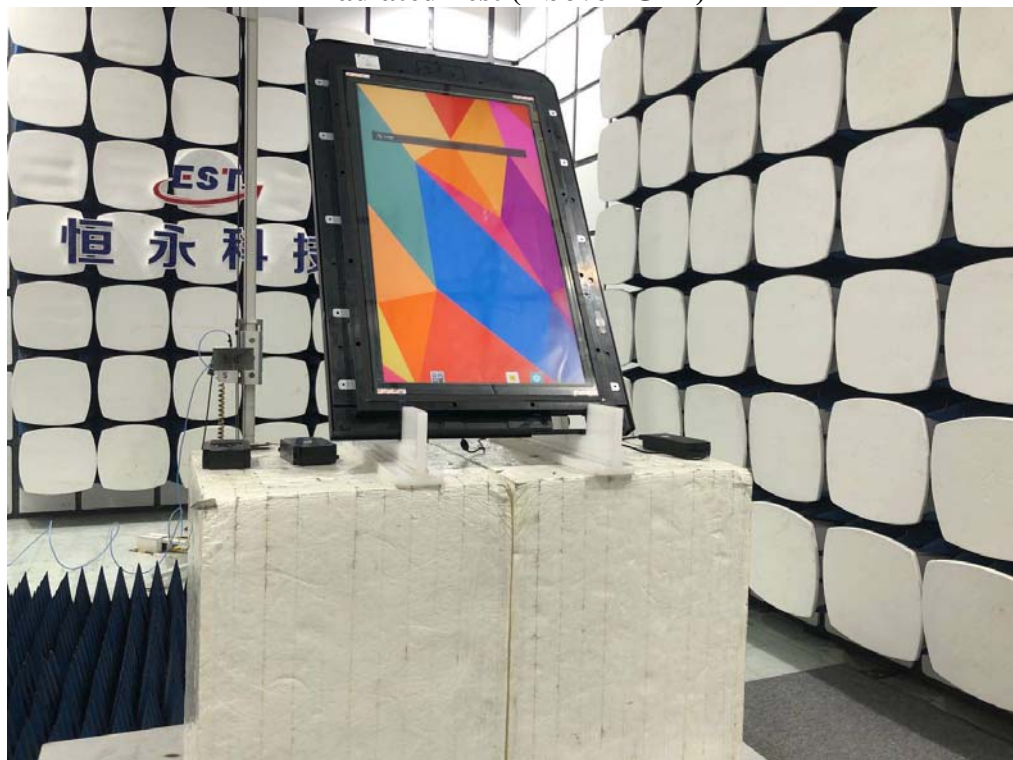

**External Photos, Please see Annex 1**

**Internal Photos, Please see Annex 2**

**End of Test Report**