



FCC TEST REPORT

(Part 15, Subpart E)

Applicant:	Icon Health and Fitness, Inc.
Address:	1500 South 1000 West, Logan Utah United States 84321

Manufacturer or Supplier:	Icon Health and Fitness, Inc.
Address:	1500 South 1000 West, Logan Utah United States 84321
Product:	Tablet
Brand Name:	N/A
Model Name:	MP21-ARGON3-NFC, MP21-ARGON3
FCC ID:	OMC415325
Date of tests:	Sep. 27, 2019 ~ Dec. 06, 2019

The tests have been carried out according to the requirements of the following standard:

FCC Part 15, Subpart E, Section 15.407

CONCLUSION: The submitted sample was found to COMPLY with the test requirement

Prepared by Alex Chen Engineer / Mobile Department	Approved by Luke Lu Manager / Mobile Department
Date: Dec. 10, 2019	Date: Dec. 10, 2019

This report is governed by, and incorporates by reference, CPS Conditions of Service as posted at the date of issuance of this report at <http://www.bureauveritas.com/home/about-us/our-business/cps/about-us/terms-conditions> and is intended for your exclusive use. Any copying or replication of this report to or for any other person or entity, or use of our name or trademark, is permitted only with our prior written permission. This report sets forth our findings solely with respect to the test samples identified herein. The results set forth in this report are not indicative or representative of the quality or characteristics of the lot from which a test sample was taken or any similar or identical product unless specifically and expressly noted. Our report includes all of the tests requested by you and the results thereof based upon the information that you provided to us. Measurement uncertainty is only provided upon request for accredited tests. You have 60 days from date of issuance of this report to notify us of any material error or omission caused by our negligence or if you require measurement uncertainty; provided, however, that such notice shall be in writing and shall specifically address the issue you wish to raise. A failure to raise such issue within the prescribed time shall constitute you unqualified acceptance of the completeness of this report, the tests conducted and the correctness of the report contents.



TABLE OF CONTENTS

RELEASE CONTROL RECORD 4

1 SUMMARY OF TEST RESULTS 5

1.1 MEASUREMENT UNCERTAINTY 5

2 GENERAL INFORMATION..... 6

2.1 GENERAL DESCRIPTION OF EUT 6

2.2 DESCRIPTION OF TEST MODES 8

 2.2.1 TEST MODE APPLICABILITY AND TESTED CHANNEL DETAIL..... 10

2.3 DUTY CYCLE OF TEST SIGNAL 15

2.4 DESCRIPTION OF SUPPORT UNITS 16

 2.4.1 CONFIGURATION OF SYSTEM UNDER TEST 17

2.5 GENERAL DESCRIPTION OF APPLIED STANDARDS 17

3 TEST TYPES AND RESULTS..... 18

3.1 RADIATED EMISSION AND BANDEDGE MEASUREMENT 18

 3.1.1 LIMITS OF RADIATED EMISSION AND BANDEDGE MEASUREMENT..... 18

 3.1.2 LIMITS OF UNWANTED EMISSION..... 18

 3.1.3 TEST INSTRUMENTS..... 19

 3.1.4 TEST PROCEDURES 20

 3.1.5 DEVIATION FROM TEST STANDARD 20

 3.1.6 TEST SETUP 21

 3.1.7 EUT OPERATING CONDITION 22

 3.1.8 TEST RESULTS 23

3.2 CONDUCTED EMISSION MEASUREMENT 66

 3.2.1 LIMITS OF CONDUCTED EMISSION MEASUREMENT 66

 3.2.2 TEST INSTRUMENTS..... 66

 3.2.3 TEST PROCEDURES 66

 3.2.4 DEVIATION FROM TEST STANDARD 67

 3.2.5 TEST SETUP 67

 3.2.6 EUT OPERATING CONDITIONS 67

 3.2.7 TEST RESULTS 68

3.3 MAXIMUM CONDUCTED OUTPUT POWER MEASUREMENT 70

 3.3.1 LIMITS OF MAXIMUM CONDUCTED OUTPUT POWER MEASUREMENT 70

 3.3.2 TEST SETUP 71

 3.3.3 TEST INSTRUMENTS..... 71



3.3.4	TEST PROCEDURE.....	72
3.3.5	DEVIATION FROM TEST STANDARD	74
3.3.6	EUT OPERATING CONDITIONS	74
3.3.7	TEST RESULTS	75
3.4	MAXIMUM POWER SPECTRAL DENSITY MEASUREMENT.....	89
3.4.1	LIMITS OF MAXIMUM POWER SPECTRAL DENSITY MEASUREMENT	89
3.4.2	TEST SETUP	89
3.4.3	TEST INSTRUMENTS.....	89
3.4.4	TEST PROCEDURES	90
3.4.5	DEVIATION FROM TEST STANDARD	90
3.4.6	EUT OPERATING CONDITIONS	90
3.4.7	TEST RESULTS	91
4	PHOTOGRAPHS OF THE TEST CONFIGURATION	98
5	APPENDIX A – MODIFICATIONS RECORDERS FOR ENGINEERING CHANGES TO THE EUT BY THE LAB	99



BUREAU
VERITAS

Test Report No.: RF190926W003-3

RELEASE CONTROL RECORD

ISSUE NO.	REASON FOR CHANGE	DATE ISSUED
RF190926W003-3	Original release	Dec. 10, 2019



1 SUMMARY OF TEST RESULTS

The EUT has been tested according to the following specifications:

APPLIED STANDARD: FCC PART 15, SUBPART E		
STANDARD SECTION	TEST TYPE AND LIMIT	RESULT
15.407(b)(6)	AC Power Conducted Emission	Compliance
15.407(b) (1/2/3/4/5)	Radiated Emission & Band Edge Measurement	Compliance
15.407(a/1/2/3)	Maximum conducted output Power	Compliance
15.407(a/1/2/3)	Peak Power Spectral Density	Compliance
15.403(i)	26 dB Bandwidth	Compliance
15.407(e)	6 dB Bandwidth	Compliance
15.203	Antenna Requirement	Compliance

1.1 MEASUREMENT UNCERTAINTY

Where relevant, the following measurement uncertainty levels have been estimated for tests performed on the EUT as specified in CISPR 16-4-2:

MEASUREMENT	UNCERTAINTY
AC Power Conducted emissions	±2.70dB
Radiated emissions (30MHz~1GMHz)	±4.98dB
Radiated emissions (1GMHz ~6GMHz)	±4.70dB
Radiated emissions (6GMHz ~18GMHz)	±4.60dB
Radiated emissions (18GMHz ~40GMHz)	±4.12dB
Conducted emissions	±4.01dB
Occupied Channel Bandwidth	±43.58KHz
Conducted Output power	±2.06dB
Power Spectral Density	±0.85 dB

This uncertainty represents an expanded uncertainty expressed at approximately the 95% confidence level using a coverage factor of k = 2.



2 GENERAL INFORMATION

2.1 GENERAL DESCRIPTION OF EUT

PRODUCT	Tablet
BRAND NAME	N/A
MODEL NAME	MP21-ARGON3-NFC, MP21-ARGON3
NOMINAL VOLTAGE	DC12V
MODULATION	OFDM
TRANSFER RATE	802.11a: 54.0/ 48.0/ 36.0/ 24.0/ 18.0/ 12.0/ 9.0/ 6.0Mbps 802.11n: up to MCS7
OPERATING FREQUENCY	5180 ~ 5240MHz, 5260 ~ 5320MHz, 5500 ~ 5700MHz, 5745 ~ 5805MHz
NUMBER OF CHANNEL	5180 ~ 5240MHz: 4 for 802.11a, 802.11n (20MHz) 2 for 802.11n (40MHz) 5260 ~ 5320MHz: 4 for 802.11a, 802.11n (20MHz) 2 for 802.11n (40MHz) 5500 ~ 5700MHz: 8 for 802.11a, 802.11n (20MHz) 3 for 802.11n (40MHz) 5745 ~ 5805MHz: 4 for 802.11a, 802.11n (20MHz) 2 for 802.11n (40MHz)
AVERAGE POWER	27.23mW for 5180 ~ 5240MHz 26.61mW for 5260 ~ 5320MHz 28.26mW for 5500 ~ 5700MHz 26.61mW for 5745 ~ 5805MHz
ANTENNA TYPE	5180 ~ 5240MHz: PIFA Antenna with 4.82dBi gain 5260 ~ 5320MHz: PIFA Antenna with 5.27dBi gain 5500 ~ 5700MHz: PIFA Antenna with 4.6dBi gain 5745 ~ 5805MHz: PIFA Antenna with 6.03dBi gain
HW VERSION	A455C
SW VERSION	argon
I/O PORTS	Refer to user's manual



NOTE:

1. For a more detailed features description, please refer to the manufacturer's specifications or the user's manual.
2. The schematic, structure and hardware of each model is same, the only difference is the model name, it will not affect the test result.
3. The EUT incorporates a SISO function. Physically, the EUT provides one completed transmitter and one receiver.

MODULATION MODE	TX FUNCTION
802.11a	1TX/1RX
802.11n (20MHz)	1TX/1RX
802.11n (40MHz)	1TX/1RX

4. For the test results, the EUT had been tested with all conditions. But only the worst case was shown in test report.
5. The device will automatically discontinue transmission in case of either absence of information to transmit or operational failure.



2.2 DESCRIPTION OF TEST MODES

FOR 5150 ~ 5250MHz

4 channels are provided for 802.11a, 802.11n (20MHz):

CHANNEL	FREQUENCY	CHANNEL	FREQUENCY
36	5180 MHz	44	5220 MHz
40	5200 MHz	48	5240 MHz

2 channels are provided for 802.11n (40MHz):

CHANNEL	FREQUENCY	CHANNEL	FREQUENCY
38	5190 MHz	46	5230 MHz

FOR 5250 ~ 5350MHz

4 channels are provided for 802.11a, 802.11n (20MHz):

CHANNEL	FREQUENCY	CHANNEL	FREQUENCY
52	5260 MHz	60	5300 MHz
56	5280 MHz	64	5320 MHz

2 channels are provided for 802.11n (40MHz):

CHANNEL	FREQUENCY	CHANNEL	FREQUENCY
54	5270 MHz	62	5310 MHz

FOR 5470 ~ 5725MHz

8 channels are provided for 802.11a, 802.11n (20MHz):

CHANNEL	FREQUENCY	CHANNEL	FREQUENCY
100	5500 MHz	116	5580 MHz
104	5520 MHz	132	5660 MHz
108	5540 MHz	136	5680 MHz
112	5560 MHz	140	5700 MHz

3 channels are provided for 802.11n (40MHz):

CHANNEL	FREQUENCY	CHANNEL	FREQUENCY
102	5510 MHz	134	5670 MHz
110	5550 MHz		



FOR 5725 ~ 5805MHz

4 channels are provided for 802.11a, 802.11n (20MHz):

CHANNEL	FREQUENCY	CHANNEL	FREQUENCY
149	5745 MHz	157	5785 MHz
153	5765 MHz	161	5805 MHz

2 channels are provided for 802.11n (40MHz):

CHANNEL	FREQUENCY	CHANNEL	FREQUENCY
151	5755 MHz	159	5795 MHz



2.2.1 TEST MODE APPLICABILITY AND TESTED CHANNEL DETAIL

EUT CONFIGURE MODE	APPLICABLE TO				DESCRIPTION
	RE≥1G	RE<1G	PLC	APCM	
A	√	√	√	-	Powered by Adapter with wifi(5G) link
B	-	-	-	√	Powered by Battery with wifi(5G) link
C	-	-	-	-	Powered by USB with wifi(5G) link

Where

RE≥1G: Radiated Emission above 1GHz

RE<1G: Radiated Emission below 1GHz

PLC: Power Line Conducted Emission

APCM: Antenna Port Conducted Measurement

NOTE:

The EUT had been pre-tested on the positioned of each 3 axis. The worst case was found when positioned on **X-plane**.

NOTE: "-" means no effect.



RADIATED EMISSION TEST (ABOVE 1GHz):

- Pre-Scan has been conducted to determine the worst-case mode from all possible combinations between available modulations, data rates and antenna ports (if EUT with antenna diversity architecture).
- Following channel(s) was (were) selected for the final test as listed below.

EUT CONFIGURE MODE	MODE	FREQ. BAND (MHz)	AVAILABLE CHANNEL	TESTED CHANNEL	MODULATION	DATA RATE (Mbps)
A	802.11a	5180-5240	36 to 48	36, 40, 48	OFDM	6.0
A	802.11n (20MHz)		36 to 48	36, 40, 48	OFDM	MCS0
A	802.11n (40MHz)		38 to 46	38, 46	OFDM	MCS0
A	802.11a	5260-5320	52 to 64	52, 60, 64	OFDM	6.0
A	802.11n (20MHz)		52 to 64	52, 60, 64	OFDM	MCS0
A	802.11n (40MHz)		54 to 62	54, 62	OFDM	MCS0
A	802.11a	5500-5700	100 to 140	100, 116, 140	OFDM	6.0
A	802.11n (20MHz)		100 to 140	100, 116, 140	OFDM	MCS0
A	802.11n (40MHz)		102 to 134	102, 110, 134	OFDM	MCS0
A	802.11a	5745-5805	149 to 161	149, 157,161	OFDM	6.0
A	802.11n (20MHz)		149 to 161	149, 157,161	OFDM	MCS0
A	802.11n (40MHz)		151 to 159	151, 159	OFDM	MCS0



RADIATED EMISSION TEST (BELOW 1GHz):

- Pre-Scan has been conducted to determine the worst-case mode from all possible combinations between available modulations, data rates and antenna ports (if EUT with antenna diversity architecture).
- Following channel(s) was (were) selected for the final test as listed below.

EUT CONFIGURE MODE	MODE	FREQ. BAND (MHz)	AVAILABLE CHANNEL	TESTED CHANNEL	MODULATION	DATA RATE (Mbps)
A	802.11n40	5180-5240	38 to 46	38	OFDM	MCS0

POWER LINE CONDUCTED EMISSION TEST:

- Pre-Scan has been conducted to determine the worst-case mode from all possible combinations between available modulations, data rates and antenna ports (if EUT with antenna diversity architecture).
- Following channel(s) was (were) selected for the final test as listed below.

EUT CONFIGURE MODE	MODE	FREQ. BAND (MHz)	AVAILABLE CHANNEL	TESTED CHANNEL	MODULATION	DATA RATE (Mbps)
A	802.11n40	5180-5240	38 to 46	38	OFDM	MCS0



BANDEDGE MEASUREMENT:

- Pre-Scan has been conducted to determine the worst-case mode from all possible combinations between available modulations, data rates and antenna ports (if EUT with antenna diversity architecture).
- Following channel(s) was (were) selected for the final test as listed below.

EUT CONFIGURE MODE	MODE	FREQ. BAND (MHz)	AVAILABLE CHANNEL	TESTED CHANNEL	MODULATION	DATA RATE (Mbps)
A	802.11a	5180-5240	36 to 48	36, 48	OFDM	6.0
A	802.11n (20MHz)		36 to 48	36, 48	OFDM	MCS0
A	802.11n (40MHz)		38 to 46	38, 46	OFDM	MCS0
A	802.11a	5260-5320	52 to 64	52, 64	OFDM	6.0
A	802.11n (20MHz)		52 to 64	52, 64	OFDM	MCS0
A	802.11n (40MHz)		54 to 62	54, 62	OFDM	MCS0
A	802.11a	5500-5700	100 to 140	100, 116, 140	OFDM	6.0
A	802.11n (20MHz)		100 to 140	100, 116, 140	OFDM	MCS0
A	802.11n (40MHz)		102 to 134	102, 110, 134	OFDM	MCS0
A	802.11a	5745-5805	149 to 161	149, 157,161	OFDM	6.0
A	802.11n (20MHz)		149 to 161	149, 157,161	OFDM	MCS0
A	802.11n (40MHz)		151 to 159	151, 159	OFDM	MCS0



ANTENNA PORT CONDUCTED MEASUREMENT:

- This item includes all test value of each mode, but only includes spectrum plot of worst value of each mode.
- Pre-Scan has been conducted to determine the worst-case mode from all possible combinations between available modulations, data rates and antenna ports (if EUT with antenna diversity architecture).
- Following channel(s) was (were) selected for the final test as listed below.

EUT CONFIGURE MODE	MODE	FREQ. BAND (MHz)	AVAILABLE CHANNEL	TESTED CHANNEL	MODULATION TECHNOLOGY	DATA RATE (Mbps)
B	802.11a	5180-5240	36 to 48	36, 40, 48	OFDM	6.0
B	802.11n (20MHz)		36 to 48	36, 40, 48	OFDM	MCS0
B	802.11n (40MHz)		38 to 46	38, 46	OFDM	MCS0
B	802.11a	5260-5320	52 to 64	52, 60, 64	OFDM	6.0
B	802.11n (20MHz)		52 to 64	52, 60, 64	OFDM	MCS0
B	802.11n (40MHz)		54 to 62	54, 62	OFDM	MCS0
B	802.11a	5500-5700	100 to 140	100, 116, 140	OFDM	6.0
B	802.11n (20MHz)		100 to 140	100, 116, 140	OFDM	MCS0
B	802.11n (40MHz)		102 to 134	102, 110, 134	OFDM	MCS0
B	802.11a	5745-5805	149 to 161	149, 157,161	OFDM	6.0
B	802.11n (20MHz)		149 to 161	149, 157,161	OFDM	MCS0
B	802.11n (40MHz)		151 to 159	151, 159	OFDM	MCS0

TEST CONDITION:

APPLICABLE TO	ENVIRONMENTAL CONDITIONS	INPUT POWER	TESTED BY
RE<1G	23deg. C, 70%RH	DC 12V	Jacky Liu
RE≥1G	23deg. C, 70%RH	DC 12V	Jacky Liu
PLC	25deg. C, 52%RH	DC 12V	Tony Xiong
APCM	25deg. C, 60%RH	DC 12V	Kevin Zhang



2.3 DUTY CYCLE OF TEST SIGNAL

Duty cycle of test signal is < 98%, duty factor shall be considered.

802.11a: Duty cycle = 1.692/1.728 = 0.979, Duty factor = 10 * log(1/ 0.979) = 0.09.

802.11n (20MHz): Duty cycle = 1.463/1.498 = 0.977, Duty factor = 10 * log(1/ 0.977) = 0.10.

802.11n (40MHz): Duty cycle = 813.8/849.1 = 0.958, Duty factor = 10 * log(1/ 0.958) = 0.18

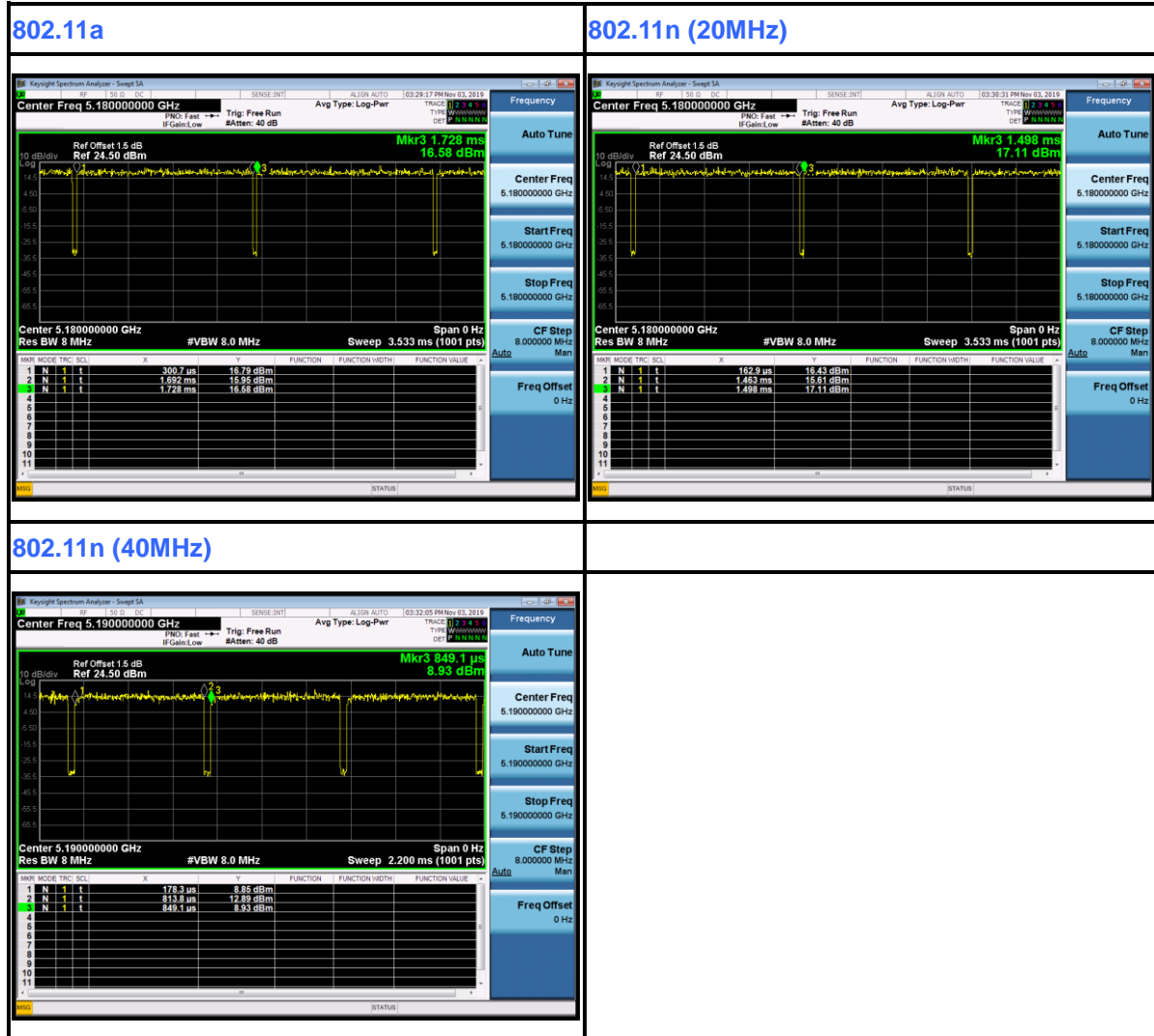



2.4 DESCRIPTION OF SUPPORT UNITS

The EUT has been tested as an independent unit together with other necessary accessories or support units. The following support units or accessories were used to form a representative test configuration during the tests.

NO.	PRODUCT	BRAND	MODEL NO.	SERIAL NO.	FCC ID
1	Desktop	Lenovo	M73 SFF	PC04GRQV	N/A
2	Desktop	Lenovo	M73 SFF	PC06CS27	N/A
3	Laptop	Lenovo	Thnikpad L440	R90FTFKN	N/A
4	Adapter		ICP18-090-1500	N/A	N/A

NO.	SIGNAL CABLE DESCRIPTION OF THE ABOVE SUPPORT UNITS
1	AC Line: Unshielded, Detachable 1.5m
2	AC Line: Unshielded, Detachable 1.5m
3	AC Line: Unshielded, Detachable 1.5m
4	N/A



2.4.1 CONFIGURATION OF SYSTEM UNDER TEST

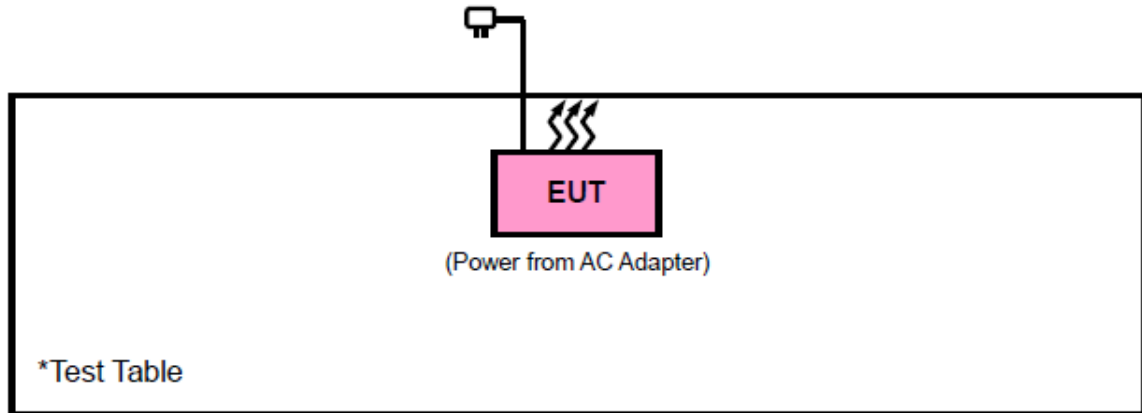

2.5 GENERAL DESCRIPTION OF APPLIED STANDARDS

The EUT is a RF Product. According to the specifications of the manufacturer, it must comply with the requirements of the following standards:

FCC Part 15, Subpart E (15.407)

KDB 789033 D02 General U-NII Test Procedures New Rules v02r01

ANSI C63.10-2013

All test items have been performed and recorded as per the above standards.

NOTE: The EUT is also considered as a kind of computer peripheral, because the connection to computer is necessary for typical use. It has been verified to comply with the requirements of FCC Part 15, Subpart B, Class B (Certification). The test report has been issued separately.



3 TEST TYPES AND RESULTS

3.1 RADIATED EMISSION AND BANDEDGE MEASUREMENT

3.1.1 LIMITS OF RADIATED EMISSION AND BANDEDGE MEASUREMENT

Radiated emissions which fall in the restricted bands must comply with the radiated emission limits specified as below table:

FREQUENCIES (MHz)	FIELD STRENGTH (microvolts/meter)	MEASUREMENT DISTANCE (meters)
0.009 ~ 0.490	2400/F(kHz)	300
0.490 ~ 1.705	24000/F(kHz)	30
1.705 ~ 30.0	30	30
30 ~ 88	100	3
88 ~ 216	150	3
216 ~ 960	200	3
Above 960	500	3

NOTE:

1. The lower limit shall apply at the transition frequencies.
2. Emission level (dBuV/m) = 20 log Emission level (uV/m).
3. For frequencies above 1000MHz, the field strength limits are based on average detector, however, the peak field strength of any emission shall not exceed the maximum permitted average limits, specified above by more than 20dB under any condition of modulation.

3.1.2 LIMITS OF UNWANTED EMISSION

RESTRICTED BANDS	APPLICABLE TO	LIMIT	
	789033 D02 General UNII Test Procedures New Rules v02r01	FIELD STRENGTH AT 3m (dBµV/m)	
		PK : 74	AV : 54
OUT OF THE RESTRICTED BANDS	APPLICABLE TO	EIRP LIMIT (dBm/MHz)	EQUIVALENT FIELD STRENGTH AT 3m (dBµV/m)
	15.407(b)(1)	PK : -27	PK : 68.3
	15.407(b)(2)		
	15.407(b)(3)		
15.407(b)(4)	See note 2 (FCC 16-24)		



NOTE: The following formula is used to convert the equipment isotropic radiated power (eirp) to field strength:

$$E = \frac{1000000\sqrt{30P}}{3} \text{ } \mu\text{V/m, where P is the eirp (Watts).}$$

2. All emissions shall be limited to a level of -27 dBm/MHz at 75 MHz or more above or below the band edge increasing linearly to 10 dBm/MHz at 25 MHz above or below the band edge, and from 25 MHz above or below the band edge increasing linearly to a level of 15.6 dBm/MHz at 5 MHz above or below the band edge, and from 5 MHz above or below the band edge increasing linearly to a level of 27 dBm/MHz at the band edge.

3.1.3 TEST INSTRUMENTS

Equipment	Manufacturer	Model No.	Serial No.	Last Cal.	Next Cal.
3m Semi-anechoic Chamber	ETS-LINDGREN	9m*6m*6m	Euroshieldpn-CT0001143-1216	Feb. 26,19	Feb. 25,20
Bilog Antenna	ETS-LINDGREN	3143B	00161965	Feb. 26,19	Feb. 25,20
Horn Antenna	ETS-LINDGREN	3117	00168728	Mar. 03,19	Mar. 02,20
Horn Antenna (18GHz-40GHz)	N/A	QWH-SL-18-40-K-SG/QMS-00361	15433	Nov. 22, 19	Nov. 21, 20
Test Software	E3	V 9.160323	N/A	N/A	N/A
Test Software	ADT	ADT_Radiated_V7.6.15.9.2	N/A	N/A	N/A
10dB Attenuator	JFW/USA	50HF-010-SMA	1505	Jun. 24,19	Jun. 23,20
MXE EMI Receiver	KEYSIGHT	N9038A-544	MY54450026	Feb. 26,19	Feb. 25,20
Signal Pre-Amplifier	EMSI	EMC 9135	980249	Jun. 24,19	Jun. 23,20
Signal Pre-Amplifier	EMSI	EMC 012645B	980257	Jun. 24,19	Jun. 23,20
Signal Pre-Amplifier	EMSI	EMC 184045B	980259	Jun. 24,19	Jun. 23,20

NOTE:

1. The calibration interval of the above test instruments is 12 months and the calibrations are traceable to CEPREI/CHINA, GRGT/CHINA and NIM/CHINA.
2. The test was performed in 3m Chamber.
3. The FCC Site Registration No. is 525120; The Designation No. is CN1171.



3.1.4 TEST PROCEDURES

- a. The EUT was placed on the top of a rotating table 0.8 meters (for below 1GHz) / 1.5 meters (for above 1GHz) above the ground at 3 meter chamber room for test. The table was rotated 360 degrees to determine the position of the highest radiation.
- b. The EUT was set 3 meters away from the interference-receiving antenna, which was mounted on the top of a variable-height antenna tower.
- c. The antenna is a broadband antenna, and its height is varied from one meter to four meters above the ground to determine the maximum value of the field strength. Both horizontal and vertical polarizations of the antenna are set to make the measurement.
- d. For each suspected emission, the EUT was arranged to its worst case and then the antenna was tuned to heights from 1 meter to 4 meters and the rotatable table was turned from 0 degrees to 360 degrees to find the maximum reading.
- e. The test-receiver system was set to Peak Detect Function and Specified Bandwidth with Maximum Hold Mode.
- f. If the emission level of the EUT in peak mode was 10dB lower than the limit specified, then testing could be stopped and the peak values of the EUT would be reported. Otherwise the emissions that did not have 10dB margin would be re-tested one by one using peak, quasi-peak or average method as specified and then reported in a data sheet.

NOTE:

1. The resolution bandwidth and video bandwidth of test receiver/spectrum analyzer is 120kHz for Peak detection (PK) and Quasi-peak detection (QP) at frequency below 1GHz.
2. The resolution bandwidth of test receiver/spectrum analyzer is 1MHz and video bandwidth is 3MHz for Peak detection at frequency above 1GHz.
3. The resolution bandwidth of test receiver/spectrum analyzer is 1MHz and the video bandwidth is 3MHz for RMS Average (Duty cycle < 98%) for Average detection (AV) at frequency above 1GHz, then the measurement results was added to a correction factor (10 log(1/duty cycle)).
4. The resolution bandwidth of test receiver/spectrum analyzer is 1MHz and the video bandwidth is 10Hz (Duty cycle ≥ 98%) for Average detection (AV) at frequency above 1GHz.
5. All modes of operation were investigated and the worst-case emissions are reported.

3.1.5 DEVIATION FROM TEST STANDARD

No deviation.



3.1.6 TEST SETUP

< Frequency Range 30MHz~1GHz >

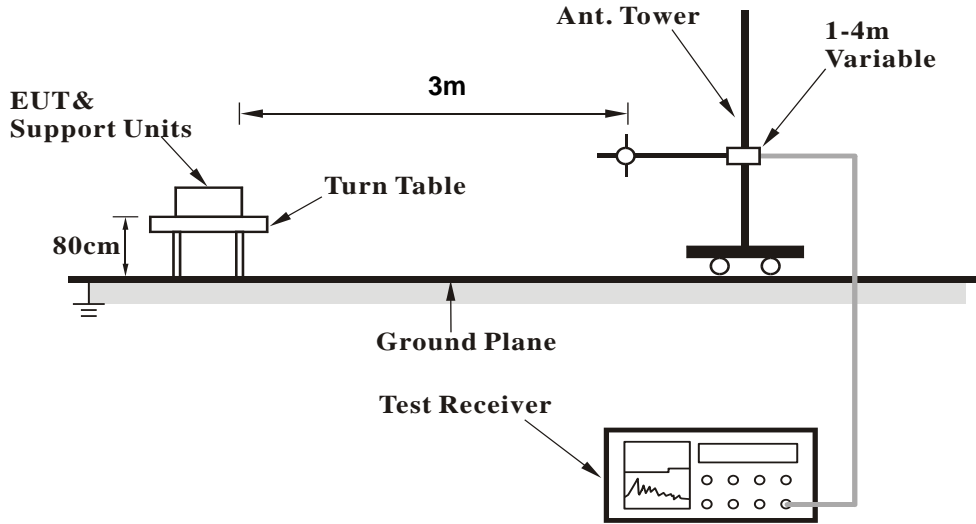

<Frequency Range above 1GHz>

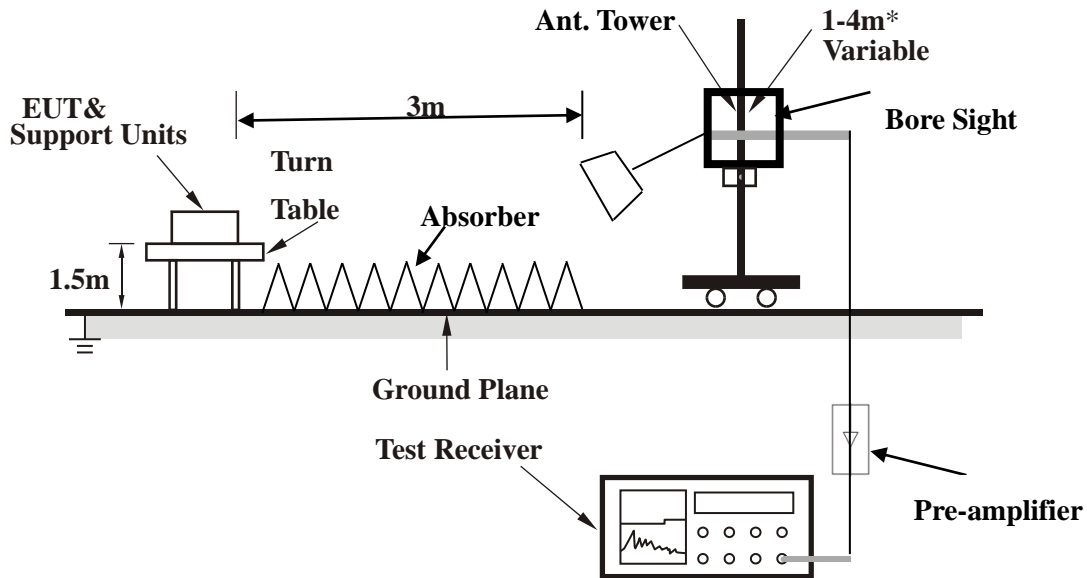

Note: Above 1G is a directional antenna

Depends on the EUT height and the antenna 3dB beamwidth both, refer to section 7.3 of CISPR 16-2-3.

For the actual test configuration, please refer to the attached file (Test Setup Photo).



3.1.7 EUT OPERATING CONDITION

- a. Set the EUT under full load condition and placed them on a testing table.
- b. Set the transmitter part of EUT under transmission condition continuously at specific channel frequency.
- c. The necessary accessories enable the EUT in full functions.



3.1.8 TEST RESULTS

BELOW 1GHz WORST-CASE DATA:

30 MHz – 1GHz data:

802.11a

CHANNEL	TX Channel 36	DETECTOR FUNCTION	Quasi-Peak (QP)
FREQUENCY RANGE	30MHz ~ 1GHz		

ANTENNA POLARITY & TEST DISTANCE: HORIZONTAL AT 3 M										
FREQ. (MHz)	EMISSION LEVEL (dBuV/m)	READ LEVEL (dBuV)	LIMIT (dBuV/m)	MARGIN (dB)	ANTENNA FACTOR (dB /m)	CABLE LOSS (dB)	PREAMP FACTOR (dB)	ANTENNA HEIGHT (cm)	TABLE ANGLE (Degree)	REMARK
39.336	24.1	47.11	40	-15.9	13.61	0.9	37.52	100	0	Peak
93.117	28.17	55.23	43.5	-15.33	8.87	1.29	37.22	100	0	Peak
185.174	38.78	63.25	43.5	-4.72	10.43	1.72	36.62	100	0	Peak
240.186	39.15	61.22	46	-6.85	12.57	1.99	36.63	100	0	Peak
285.126	35.4	56.19	46	-10.6	13.77	2.16	36.72	100	0	Peak
670.142	28.26	40.19	46	-17.74	22.13	3.42	37.48	100	0	Peak

REMARKS:

1. Emission level (dBuV/m) = Read level (dBuV) + Correction Factor (dB/m).
2. Correction Factor (dB/m) = Antenna Factor (dB/m) + Cable Factor (dB).
3. The other emission levels were very low against the limit.
4. Margin value = Emission level – Limit value.

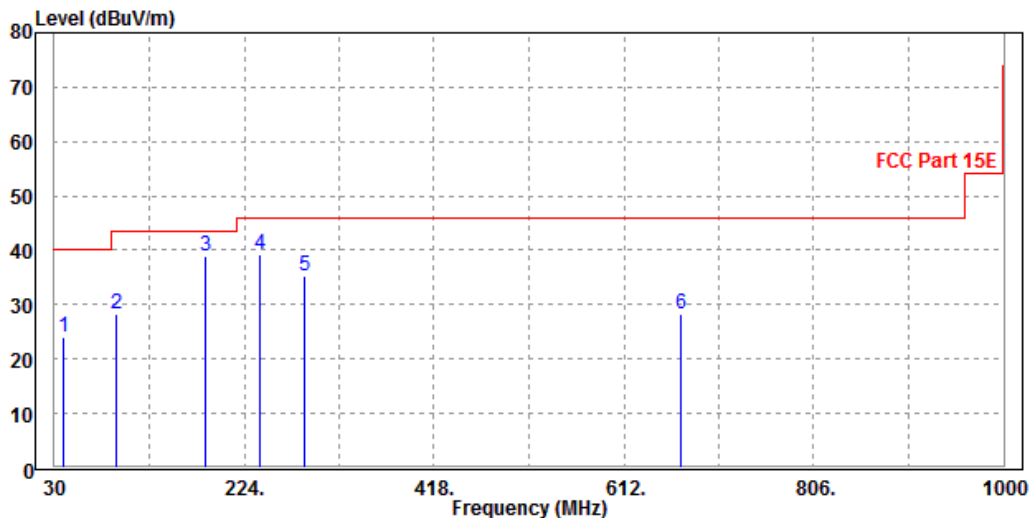



CHANNEL	Channel 36	DETECTOR FUNCTION	Quasi-Peak (QP)
FREQUENCY RANGE	30MHz ~ 1GHz		

ANTENNA POLARITY & TEST DISTANCE: VERTICAL AT 3 M										
FREQ. (MHz)	EMISSION LEVEL (dBuV/m)	READ LEVEL (dBuV)	LIMIT (dBuV/m)	MARGIN (dB)	ANTENNA FACTOR (dB /m)	CABLE LOSS (dB)	PREAMP FACTOR (dB)	ANTENNA HEIGHT (cm)	TABLE ANGLE (Degree)	REMARK
69.236	24.66	53.26	40	-15.34	7.54	1.19	37.33	100	360	Peak
107.226	24.86	51.23	43.5	-18.64	9.4	1.36	37.13	100	360	Peak
261.365	33.95	55.11	46	-12.05	13.43	2.08	36.67	100	360	Peak
413.226	27.52	44.21	46	-18.48	17.49	2.67	36.85	100	360	Peak
550.221	26.92	41.63	46	-19.08	19.4	3.08	37.19	100	360	Peak
660.117	34.02	46.27	46	-11.98	21.84	3.38	37.47	100	360	Peak

REMARKS:

1. Emission level (dBuV/m) = Read level (dBuV) + Correction Factor (dB/m).
2. Correction Factor (dB/m) = Antenna Factor (dB/m) + Cable Factor (dB).
3. The other emission levels were very low against the limit.
4. Margin value = Emission level – Limit value.

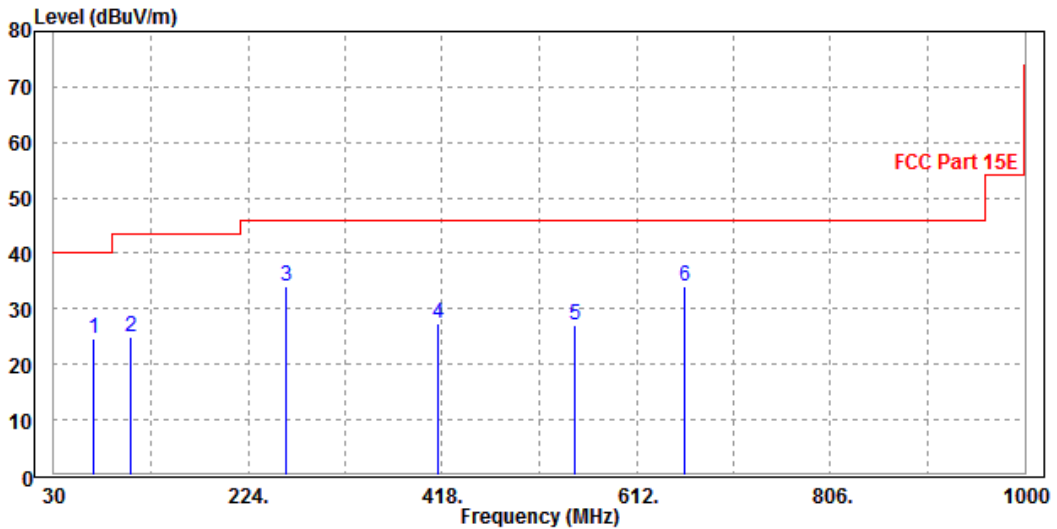



ABOVE 1GHZ WORST-CASE DATA:

Note: For higher frequency, the emission is too low to be detected.

Band 1

802.11a

CHANNEL	TX Channel 36	DETECTOR FUNCTION	Peak (PK)
FREQUENCY RANGE	1GHz ~ 40GHz		Average (AV)

ANTENNA POLARITY & TEST DISTANCE: HORIZONTAL AT 3 M

FREQ. (MHz)	EMISSION LEVEL (dBuV/m)	READ LEVEL (dBuV)	LIMIT (dBuV/m)	MARGIN (dB)	ANTENNA FACTOR (dB /m)	CABLE LOSS (dB)	PREAMP FACTOR (dB)	ANTENNA HEIGHT (cm)	TABLE ANGLE (Degree)	REMARK
5150	58.68	61.66	74	-15.32	35.95	7.42	46.35	100	320	Peak
5150	46.67	49.65	54	-7.33	35.95	7.42	46.35	100	320	Average
5180	107.33	110.27			35.98	7.43	46.35	100	320	Peak
5180	99.66	102.6			35.98	7.43	46.35	100	320	Average
5350	55.57	58.25	74	-18.43	36.15	7.47	46.3	100	320	Peak
5350	44	46.68	54	-10	36.15	7.47	46.3	100	320	Average

ANTENNA POLARITY & TEST DISTANCE: VERTICAL AT 3 M

FREQ. (MHz)	EMISSION LEVEL (dBuV/m)	READ LEVEL (dBuV)	LIMIT (dBuV/m)	MARGIN (dB)	ANTENNA FACTOR (dB /m)	CABLE LOSS (dB)	PREAMP FACTOR (dB)	ANTENNA HEIGHT (cm)	TABLE ANGLE (Degree)	REMARK
5150	59.16	61.8	74	-14.84	36.29	7.42	46.35	100	85	Peak
5150	44.16	46.8	54	-9.84	36.29	7.42	46.35	100	85	Average
5180	97.19	99.8			36.31	7.43	46.35	100	85	Peak
5180	86.77	89.38			36.31	7.43	46.35	100	85	Average
5350	56.36	58.78	74	-17.64	36.41	7.47	46.3	100	85	Peak
5350	43.99	46.41	54	-10.01	36.41	7.47	46.3	100	85	Average

REMARKS:

- Emission Level = Read Level+ Antenna Factor + Cable Loss- Preamp Factor
Margin value = Emission level – Limit value.
- 5180MHz: Fundamental frequency.



CHANNEL	TX Channel 40	DETECTOR FUNCTION	Peak (PK)
FREQUENCY RANGE	1GHz ~ 40GHz		Average (AV)

ANTENNA POLARITY & TEST DISTANCE: HORIZONTAL AT 3 M

FREQ. (MHz)	EMISSION LEVEL (dBuV/m)	READ LEVEL (dBuV)	LIMIT (dBuV/m)	MARGIN (dB)	ANTENNA FACTOR (dB /m)	CABLE LOSS (dB)	PREAMP FACTOR (dB)	ANTENNA HEIGHT (cm)	TABLE ANGLE (Degree)	REMARK
5150	59.04	62.02	74	-14.96	35.95	7.42	46.35	100	60	Peak
5150	45.78	48.76	54	-8.22	35.95	7.42	46.35	100	60	Average
5200	108.31	111.22			36	7.43	46.34	100	60	Peak
5200	96.4	99.31			36	7.43	46.34	100	60	Average
5350	56.71	59.39	74	-17.29	36.15	7.47	46.3	100	60	Peak
5350	44.12	46.8	54	-9.88	36.15	7.47	46.3	100	60	Average

ANTENNA POLARITY & TEST DISTANCE: VERTICAL AT 3 M

FREQ. (MHz)	EMISSION LEVEL (dBuV/m)	READ LEVEL (dBuV)	LIMIT (dBuV/m)	MARGIN (dB)	ANTENNA FACTOR (dB /m)	CABLE LOSS (dB)	PREAMP FACTOR (dB)	ANTENNA HEIGHT (cm)	TABLE ANGLE (Degree)	REMARK
5150	58.8	61.44	74	-15.2	36.29	7.42	46.35	100	50	Peak
5150	44.33	46.97	54	-9.67	36.29	7.42	46.35	100	50	Average
5200	98.63	101.22			36.32	7.43	46.34	100	50	Peak
5200	87.88	90.47			36.32	7.43	46.34	100	50	Average
5350	57.38	59.8	74	-16.62	36.41	7.47	46.3	100	50	Peak
5350	42.73	45.15	54	-11.27	36.41	7.47	46.3	100	50	Average

REMARKS:

- Emission Level = Read Level+ Antenna Factor + Cable Loss- Preamp Factor
Margin value = Emission level – Limit value.
- 5200MHz: Fundamental frequency.



CHANNEL	TX Channel 48	DETECTOR FUNCTION	Peak (PK)
FREQUENCY RANGE	1GHz ~ 40GHz		Average (AV)

ANTENNA POLARITY & TEST DISTANCE: HORIZONTAL AT 3 M

FREQ. (MHz)	EMISSION LEVEL (dBuV/m)	READ LEVEL (dBuV)	LIMIT (dBuV/m)	MARGIN (dB)	ANTENNA FACTOR (dB /m)	CABLE LOSS (dB)	PREAMP FACTOR (dB)	ANTENNA HEIGHT (cm)	TABLE ANGLE (Degree)	REMARK
5150	59.23	62.21	74	-14.77	35.95	7.42	46.35	100	330	Peak
5150	45.17	48.15	54	-8.83	35.95	7.42	46.35	100	330	Average
5240	107.41	110.26			36.04	7.44	46.33	100	330	Peak
5240	98.85	101.7			36.04	7.44	46.33	100	330	Average
5350	57.98	60.66	74	-16.02	36.15	7.47	46.3	100	330	Peak
5350	44.07	46.75	54	-9.93	36.15	7.47	46.3	100	330	Average

ANTENNA POLARITY & TEST DISTANCE: VERTICAL AT 3 M

FREQ. (MHz)	EMISSION LEVEL (dBuV/m)	READ LEVEL (dBuV)	LIMIT (dBuV/m)	MARGIN (dB)	ANTENNA FACTOR (dB /m)	CABLE LOSS (dB)	PREAMP FACTOR (dB)	ANTENNA HEIGHT (cm)	TABLE ANGLE (Degree)	REMARK
5150	58.43	61.07	74	-15.57	36.29	7.42	46.35	110	113	Peak
5150	44.43	47.07	54	-9.57	36.29	7.42	46.35	110	113	Average
5240	98.55	101.1			36.34	7.44	46.33	110	113	Peak
5240	89.52	92.07			36.34	7.44	46.33	110	113	Average
5350	57.55	59.97	74	-16.45	36.41	7.47	46.3	110	113	Peak
5350	44.13	46.55	54	-9.87	36.41	7.47	46.3	110	113	Average

REMARKS:

- Emission Level = Read Level+ Antenna Factor + Cable Loss- Preamp Factor
Margin value = Emission level – Limit value.
- 5240MHz: Fundamental frequency.



802.11n (20MHz)

CHANNEL	TX Channel 36	DETECTOR FUNCTION	Peak (PK)
FREQUENCY RANGE	1GHz ~ 40GHz		Average (AV)

ANTENNA POLARITY & TEST DISTANCE: HORIZONTAL AT 3 M

FREQ. (MHz)	EMISSION LEVEL (dBuV/m)	READ LEVEL (dBuV)	LIMIT (dBuV/m)	MARGIN (dB)	ANTENNA FACTOR (dB /m)	CABLE LOSS (dB)	PREAMP FACTOR (dB)	ANTENNA HEIGHT (cm)	TABLE ANGLE (Degree)	REMARK
5150	58.67	61.65	74	-15.33	35.95	7.42	46.35	100	60	Peak
5150	46.03	49.01	54	-7.97	35.95	7.42	46.35	100	60	Average
5180	107.14	110.08			35.98	7.43	46.35	100	60	Peak
5240	96.1	98.95			36.04	7.44	46.33	100	60	Average
5350	56.84	59.52	74	-17.16	36.15	7.47	46.3	100	60	Peak
5350	43.97	46.65	54	-10.03	36.15	7.47	46.3	100	60	Average

ANTENNA POLARITY & TEST DISTANCE: VERTICAL AT 3 M

FREQ. (MHz)	EMISSION LEVEL (dBuV/m)	READ LEVEL (dBuV)	LIMIT (dBuV/m)	MARGIN (dB)	ANTENNA FACTOR (dB /m)	CABLE LOSS (dB)	PREAMP FACTOR (dB)	ANTENNA HEIGHT (cm)	TABLE ANGLE (Degree)	REMARK
5150	58.66	61.3	74	-15.34	36.29	7.42	46.35	100	60	Peak
5150	44.82	47.46	54	-9.18	36.29	7.42	46.35	100	60	Average
5180	95.05	97.66			36.31	7.43	46.35	100	60	Peak
5180	85.49	88.1			36.31	7.43	46.35	100	60	Average
5350	56.83	59.25	74	-17.17	36.41	7.47	46.3	100	60	Peak
5350	43.9	46.32	54	-10.1	36.41	7.47	46.3	100	60	Average

REMARKS:

- Emission Level = Read Level+ Antenna Factor + Cable Loss- Preamp Factor
Margin value = Emission level – Limit value.
- 5180MHz: Fundamental frequency.



CHANNEL	TX Channel 40	DETECTOR FUNCTION	Peak (PK)
FREQUENCY RANGE	1GHz ~ 40GHz		Average (AV)

ANTENNA POLARITY & TEST DISTANCE: HORIZONTAL AT 3 M										
FREQ. (MHz)	EMISSION LEVEL (dBuV/m)	READ LEVEL (dBuV)	LIMIT (dBuV/m)	MARGIN (dB)	ANTENNA FACTOR (dB /m)	CABLE LOSS (dB)	PREAMP FACTOR (dB)	ANTENNA HEIGHT (cm)	TABLE ANGLE (Degree)	REMARK
5150	57.54	60.52	74	-16.46	35.95	7.42	46.35	100	315	Peak
5150	43.72	46.7	54	-10.28	35.95	7.42	46.35	100	315	Average
5200	106.91	109.82			36	7.43	46.34	100	315	Peak
5200	97.29	100.2			36	7.43	46.34	100	315	Average
5350	55.41	58.09	74	-18.59	36.15	7.47	46.3	100	315	Peak
5350	43.49	46.17	54	-10.51	36.15	7.47	46.3	100	315	Average
ANTENNA POLARITY & TEST DISTANCE: VERTICAL AT 3 M										
FREQ. (MHz)	EMISSION LEVEL (dBuV/m)	READ LEVEL (dBuV)	LIMIT (dBuV/m)	MARGIN (dB)	ANTENNA FACTOR (dB /m)	CABLE LOSS (dB)	PREAMP FACTOR (dB)	ANTENNA HEIGHT (cm)	TABLE ANGLE (Degree)	REMARK
5150	57.11	59.75	74	-16.89	36.29	7.42	46.35	100	60	Peak
5150	46.07	48.71	54	-7.93	36.29	7.42	46.35	100	60	Average
5200	92.03	94.62			36.32	7.43	46.34	100	60	Peak
5200	81.64	84.23			36.32	7.43	46.34	100	60	Average
5350	57.26	59.68	74	-16.74	36.41	7.47	46.3	100	60	Peak
5350	44.43	46.85	54	-9.57	36.41	7.47	46.3	100	60	Average

REMARKS:

- Emission Level = Read Level+ Antenna Factor + Cable Loss- Preamp Factor
Margin value = Emission level – Limit value.
- 5200MHz: Fundamental frequency.



CHANNEL	TX Channel 48	DETECTOR FUNCTION	Peak (PK)
FREQUENCY RANGE	1GHz ~ 40GHz		Average (AV)

ANTENNA POLARITY & TEST DISTANCE: HORIZONTAL AT 3 M

FREQ. (MHz)	EMISSION LEVEL (dBuV/m)	READ LEVEL (dBuV)	LIMIT (dBuV/m)	MARGIN (dB)	ANTENNA FACTOR (dB /m)	CABLE LOSS (dB)	PREAMP FACTOR (dB)	ANTENNA HEIGHT (cm)	TABLE ANGLE (Degree)	REMARK
5150	58.54	61.52	74	-15.46	35.95	7.42	46.35	100	325	Peak
5150	44.77	47.75	54	-9.23	35.95	7.42	46.35	100	325	Average
5240	106.61	109.46			36.04	7.44	46.33	100	325	Peak
5240	98.25	101.1			36.04	7.44	46.33	100	325	Average
5350	57.94	60.62	74	-16.06	36.15	7.47	46.3	100	325	Peak
5350	44.58	47.26	54	-9.42	36.15	7.47	46.3	100	325	Average

ANTENNA POLARITY & TEST DISTANCE: VERTICAL AT 3 M

FREQ. (MHz)	EMISSION LEVEL (dBuV/m)	READ LEVEL (dBuV)	LIMIT (dBuV/m)	MARGIN (dB)	ANTENNA FACTOR (dB /m)	CABLE LOSS (dB)	PREAMP FACTOR (dB)	ANTENNA HEIGHT (cm)	TABLE ANGLE (Degree)	REMARK
5150	57.46	60.1	74	-16.54	36.29	7.42	46.35	160	95	Peak
5150	44.1	46.74	54	-9.9	36.29	7.42	46.35	160	95	Average
5240	97.16	99.71			36.34	7.44	46.33	160	95	Peak
5240	89.21	91.76			36.34	7.44	46.33	160	95	Average
5350	57.01	59.43	74	-16.99	36.41	7.47	46.3	160	95	Peak
5350	43.81	46.23	54	-10.19	36.41	7.47	46.3	160	95	Average

REMARKS:

- Emission Level = Read Level+ Antenna Factor + Cable Loss- Preamp Factor
Margin value = Emission level – Limit value.
- 5240MHz: Fundamental frequency.



802.11n (40MHz)

CHANNEL	TX Channel 38	DETECTOR FUNCTION	Peak (PK)
FREQUENCY RANGE	1GHz ~ 40GHz		Average (AV)

ANTENNA POLARITY & TEST DISTANCE: HORIZONTAL AT 3 M

FREQ. (MHz)	EMISSION LEVEL (dBuV/m)	READ LEVEL (dBuV)	LIMIT (dBuV/m)	MARGIN (dB)	ANTENNA FACTOR (dB /m)	CABLE LOSS (dB)	PREAMP FACTOR (dB)	ANTENNA HEIGHT (cm)	TABLE ANGLE (Degree)	REMARK
5150	57.6	60.58	74	-16.4	35.95	7.42	46.35	120	320	Peak
5150	42.69	45.67	54	-11.31	35.95	7.42	46.35	120	320	Average
5190	103.18	106.1			35.99	7.43	46.34	120	320	Peak
5190	92.91	95.83			35.99	7.43	46.34	120	320	Average
5350	55.83	58.51	74	-18.17	36.15	7.47	46.3	120	320	Peak
5350	42.7	45.38	54	-11.3	36.15	7.47	46.3	120	320	Average

ANTENNA POLARITY & TEST DISTANCE: VERTICAL AT 3 M

FREQ. (MHz)	EMISSION LEVEL (dBuV/m)	READ LEVEL (dBuV)	LIMIT (dBuV/m)	MARGIN (dB)	ANTENNA FACTOR (dB /m)	CABLE LOSS (dB)	PREAMP FACTOR (dB)	ANTENNA HEIGHT (cm)	TABLE ANGLE (Degree)	REMARK
5150	58.37	61.01	74	-15.63	36.29	7.42	46.35	100	85	Peak
5150	43.49	46.13	54	-10.51	36.29	7.42	46.35	100	85	Average
5190	92.63	95.23			36.31	7.43	46.34	100	85	Peak
5190	83.34	85.94			36.31	7.43	46.34	100	85	Average
5350	57.51	59.93	74	-16.49	36.41	7.47	46.3	100	85	Peak
5350	43.36	45.78	54	-10.64	36.41	7.47	46.3	100	85	Average

REMARKS:

- Emission Level = Read Level+ Antenna Factor + Cable Loss- Preamp Factor
Margin value = Emission level – Limit value.
- 5190MHz: Fundamental frequency.



CHANNEL	TX Channel 46	DETECTOR FUNCTION	Peak (PK)
FREQUENCY RANGE	1GHz ~ 40GHz		Average (AV)

ANTENNA POLARITY & TEST DISTANCE: HORIZONTAL AT 3 M

FREQ. (MHz)	EMISSION LEVEL (dBuV/m)	READ LEVEL (dBuV)	LIMIT (dBuV/m)	MARGIN (dB)	ANTENNA FACTOR (dB /m)	CABLE LOSS (dB)	PREAMP FACTOR (dB)	ANTENNA HEIGHT (cm)	TABLE ANGLE (Degree)	REMARK
5150	57.27	60.25	74	-16.73	35.95	7.42	46.35	100	10	Peak
5150	42.24	45.22	54	-11.76	35.95	7.42	46.35	100	10	Average
5230	102.38	105.24			36.03	7.44	46.33	100	10	Peak
5230	91.46	94.32			36.03	7.44	46.33	100	10	Average
5350	57.53	60.21	74	-16.47	36.15	7.47	46.3	100	10	Peak
5350	42.72	45.4	54	-11.28	36.15	7.47	46.3	100	10	Average

ANTENNA POLARITY & TEST DISTANCE: VERTICAL AT 3 M

FREQ. (MHz)	EMISSION LEVEL (dBuV/m)	READ LEVEL (dBuV)	LIMIT (dBuV/m)	MARGIN (dB)	ANTENNA FACTOR (dB /m)	CABLE LOSS (dB)	PREAMP FACTOR (dB)	ANTENNA HEIGHT (cm)	TABLE ANGLE (Degree)	REMARK
5150	58.58	61.22	74	-15.42	36.29	7.42	46.35	100	78	Peak
5150	43.12	45.76	54	-10.88	36.29	7.42	46.35	100	78	Average
5230	93.34	95.89			36.34	7.44	46.33	100	78	Peak
5230	84.84	87.39			36.34	7.44	46.33	100	78	Average
5350	56.35	58.77	74	-17.65	36.41	7.47	46.3	100	78	Peak
5350	43.3	45.72	54	-10.7	36.41	7.47	46.3	100	78	Average

REMARKS:

- Emission Level = Read Level+ Antenna Factor + Cable Loss- Preamp Factor
Margin value = Emission level – Limit value.
- 5230MHz: Fundamental frequency.



Band 2
802.11a

CHANNEL	TX Channel 52	DETECTOR FUNCTION	Peak (PK)
FREQUENCY RANGE	1GHz ~ 40GHz		Average (AV)

ANTENNA POLARITY & TEST DISTANCE: HORIZONTAL AT 3 M										
FREQ. (MHz)	EMISSION LEVEL (dBuV/m)	READ LEVEL (dBuV)	LIMIT (dBuV/m)	MARGIN (dB)	ANTENNA FACTOR (dB /m)	CABLE LOSS (dB)	PREAMP FACTOR (dB)	ANTENNA HEIGHT (cm)	TABLE ANGLE (Degree)	REMARK
5150	59.36	62.34	74	-14.64	35.95	7.42	46.35	100	145	Peak
5150	45.59	48.57	54	-8.41	35.95	7.42	46.35	100	145	Average
5260	105.49	108.3			36.06	7.45	46.32	100	145	Peak
5260	97.49	100.3			36.06	7.45	46.32	100	145	Average
5350	56.58	59.26	74	-17.42	36.15	7.47	46.3	100	145	Peak
5350	44.44	47.12	54	-9.56	36.15	7.47	46.3	100	145	Average
ANTENNA POLARITY & TEST DISTANCE: VERTICAL AT 3 M										
FREQ. (MHz)	EMISSION LEVEL (dBuV/m)	READ LEVEL (dBuV)	LIMIT (dBuV/m)	MARGIN (dB)	ANTENNA FACTOR (dB /m)	CABLE LOSS (dB)	PREAMP FACTOR (dB)	ANTENNA HEIGHT (cm)	TABLE ANGLE (Degree)	REMARK
5150	58.42	61.06	74	-15.58	36.29	7.42	46.35	100	260	Peak
5150	45.74	48.38	54	-8.26	36.29	7.42	46.35	100	260	Average
5260	98.17	100.68			36.36	7.45	46.32	100	260	Peak
5260	90.35	92.86			36.36	7.45	46.32	100	260	Average
5350	56.02	58.44	74	-17.98	36.41	7.47	46.3	100	260	Peak
5350	44.28	46.7	54	-9.72	36.41	7.47	46.3	100	260	Average

REMARKS:

- Emission Level = Read Level+ Antenna Factor + Cable Loss- Preamp Factor
Margin value = Emission level – Limit value.
- 5260MHz: Fundamental frequency.



CHANNEL	TX Channel 60	DETECTOR FUNCTION	Peak (PK)
FREQUENCY RANGE	1GHz ~ 40GHz		Average (AV)

ANTENNA POLARITY & TEST DISTANCE: HORIZONTAL AT 3 M

FREQ. (MHz)	EMISSION LEVEL (dBuV/m)	READ LEVEL (dBuV)	LIMIT (dBuV/m)	MARGIN (dB)	ANTENNA FACTOR (dB /m)	CABLE LOSS (dB)	PREAMP FACTOR (dB)	ANTENNA HEIGHT (cm)	TABLE ANGLE (Degree)	REMARK
5150	58.9	61.88	74	-15.1	35.95	7.42	46.35	100	190	Peak
5150	45.17	48.15	54	-8.83	35.95	7.42	46.35	100	190	Average
5300	104.16	106.91			36.1	7.46	46.31	100	190	Peak
5300	93.86	96.61			36.1	7.46	46.31	100	190	Average
5350	57.17	59.85	74	-16.83	36.15	7.47	46.3	100	190	Peak
5350	44.94	47.62	54	-9.06	36.15	7.47	46.3	100	190	Average

ANTENNA POLARITY & TEST DISTANCE: VERTICAL AT 3 M

FREQ. (MHz)	EMISSION LEVEL (dBuV/m)	READ LEVEL (dBuV)	LIMIT (dBuV/m)	MARGIN (dB)	ANTENNA FACTOR (dB /m)	CABLE LOSS (dB)	PREAMP FACTOR (dB)	ANTENNA HEIGHT (cm)	TABLE ANGLE (Degree)	REMARK
5150	57.65	60.29	74	-16.35	36.29	7.42	46.35	100	290	Peak
5150	45.09	47.73	54	-8.91	36.29	7.42	46.35	100	290	Average
5300	96.57	99.04			36.38	7.46	46.31	100	290	Peak
5300	87.42	89.89			36.38	7.46	46.31	100	290	Average
5350	55.01	57.43	74	-18.99	36.41	7.47	46.3	100	290	Peak
5350	44.1	46.52	54	-9.9	36.41	7.47	46.3	100	290	Average

REMARKS:

- Emission Level = Read Level+ Antenna Factor + Cable Loss- Preamp Factor
Margin value = Emission level – Limit value.
- 5300MHz: Fundamental frequency.



CHANNEL	TX Channel 64	DETECTOR FUNCTION	Peak (PK)
FREQUENCY RANGE	1GHz ~ 40GHz		Average (AV)

ANTENNA POLARITY & TEST DISTANCE: HORIZONTAL AT 3 M

FREQ. (MHz)	EMISSION LEVEL (dBuV/m)	READ LEVEL (dBuV)	LIMIT (dBuV/m)	MARGIN (dB)	ANTENNA FACTOR (dB /m)	CABLE LOSS (dB)	PREAMP FACTOR (dB)	ANTENNA HEIGHT (cm)	TABLE ANGLE (Degree)	REMARK
5150	58.21	61.19	74	-15.79	35.95	7.42	46.35	100	235	Peak
5150	45.27	48.25	54	-8.73	35.95	7.42	46.35	100	235	Average
5320	103.97	106.69			36.12	7.46	46.3	100	235	Peak
5320	95.53	98.25			36.12	7.46	46.3	100	235	Average
5350	61.89	64.57	74	-12.11	36.15	7.47	46.3	100	235	Peak
5350	46.73	49.41	54	-7.27	36.15	7.47	46.3	100	235	Average

ANTENNA POLARITY & TEST DISTANCE: VERTICAL AT 3 M

FREQ. (MHz)	EMISSION LEVEL (dBuV/m)	READ LEVEL (dBuV)	LIMIT (dBuV/m)	MARGIN (dB)	ANTENNA FACTOR (dB /m)	CABLE LOSS (dB)	PREAMP FACTOR (dB)	ANTENNA HEIGHT (cm)	TABLE ANGLE (Degree)	REMARK
5150	57.51	60.15	74	-16.49	36.29	7.42	46.35	100	270	Peak
5150	45.14	47.78	54	-8.86	36.29	7.42	46.35	100	270	Average
5320	95.52	97.97			36.39	7.46	46.3	100	270	Peak
5320	84.3	86.75			36.39	7.46	46.3	100	270	Average
5350	56.35	58.77	74	-17.65	36.41	7.47	46.3	100	270	Peak
5350	44.59	47.01	54	-9.41	36.41	7.47	46.3	100	270	Average

REMARKS:

- Emission Level = Read Level+ Antenna Factor + Cable Loss- Preamp Factor
Margin value = Emission level – Limit value.
- 5320MHz: Fundamental frequency.



802.11n (20MHz)

CHANNEL	TX Channel 52	DETECTOR FUNCTION	Peak (PK)
FREQUENCY RANGE	1GHz ~ 40GHz		Average (AV)

ANTENNA POLARITY & TEST DISTANCE: HORIZONTAL AT 3 M										
FREQ. (MHz)	EMISSION LEVEL (dBuV/m)	READ LEVEL (dBuV)	LIMIT (dBuV/m)	MARGIN (dB)	ANTENNA FACTOR (dB /m)	CABLE LOSS (dB)	PREAMP FACTOR (dB)	ANTENNA HEIGHT (cm)	TABLE ANGLE (Degree)	REMARK
5150	58.04	61.02	74	-15.96	35.95	7.42	46.35	100	150	Peak
5150	46.01	48.99	54	-7.99	35.95	7.42	46.35	100	150	Average
5260	105.84	108.65			36.06	7.45	46.32	100	150	Peak
5260	97.79	100.6			36.06	7.45	46.32	100	150	Average
5350	55.71	58.39	74	-18.29	36.15	7.47	46.3	100	150	Peak
5350	45.07	47.75	54	-8.93	36.15	7.47	46.3	100	150	Average

ANTENNA POLARITY & TEST DISTANCE: VERTICAL AT 3 M										
FREQ. (MHz)	EMISSION LEVEL (dBuV/m)	READ LEVEL (dBuV)	LIMIT (dBuV/m)	MARGIN (dB)	ANTENNA FACTOR (dB /m)	CABLE LOSS (dB)	PREAMP FACTOR (dB)	ANTENNA HEIGHT (cm)	TABLE ANGLE (Degree)	REMARK
5150	58.81	61.45	74	-15.19	36.29	7.42	46.35	100	265	Peak
5150	46.38	49.02	54	-7.62	36.29	7.42	46.35	100	265	Average
5260	96.36	98.87			36.36	7.45	46.32	100	265	Peak
5260	87.44	89.95			36.36	7.45	46.32	100	265	Average
5350	56.28	58.7	74	-17.72	36.41	7.47	46.3	100	265	Peak
5350	45.2	47.62	54	-8.8	36.41	7.47	46.3	100	265	Average

REMARKS:

1. Emission Level = Read Level+ Antenna Factor + Cable Loss- Preamp Factor
Margin value = Emission level – Limit value.
2. 5260MHz: Fundamental frequency.



CHANNEL	TX Channel 60	DETECTOR FUNCTION	Peak (PK)
FREQUENCY RANGE	1GHz ~ 40GHz		Average (AV)

ANTENNA POLARITY & TEST DISTANCE: HORIZONTAL AT 3 M

FREQ. (MHz)	EMISSION LEVEL (dBuV/m)	READ LEVEL (dBuV)	LIMIT (dBuV/m)	MARGIN (dB)	ANTENNA FACTOR (dB /m)	CABLE LOSS (dB)	PREAMP FACTOR (dB)	ANTENNA HEIGHT (cm)	TABLE ANGLE (Degree)	REMARK
5150	57.5	60.48	74	-16.5	35.95	7.42	46.35	100	230	Peak
5150	46.15	49.13	54	-7.85	35.95	7.42	46.35	100	230	Average
5300	104.13	106.88			36.1	7.46	46.31	100	230	Peak
5300	94.78	97.53			36.1	7.46	46.31	100	230	Average
5350	56.39	59.07	74	-17.61	36.15	7.47	46.3	100	230	Peak
5350	45.71	48.39	54	-8.29	36.15	7.47	46.3	100	230	Average

ANTENNA POLARITY & TEST DISTANCE: VERTICAL AT 3 M

FREQ. (MHz)	EMISSION LEVEL (dBuV/m)	READ LEVEL (dBuV)	LIMIT (dBuV/m)	MARGIN (dB)	ANTENNA FACTOR (dB /m)	CABLE LOSS (dB)	PREAMP FACTOR (dB)	ANTENNA HEIGHT (cm)	TABLE ANGLE (Degree)	REMARK
5150	59.18	61.82	74	-14.82	36.29	7.42	46.35	110	260	Peak
5150	46.41	49.05	54	-7.59	36.29	7.42	46.35	110	260	Average
5300	96.56	99.03			36.38	7.46	46.31	110	260	Peak
5300	85.79	88.26			36.38	7.46	46.31	110	260	Average
5350	57.25	59.67	74	-16.75	36.41	7.47	46.3	110	260	Peak
5350	45.29	47.71	54	-8.71	36.41	7.47	46.3	110	260	Average

REMARKS:

- Emission Level = Read Level+ Antenna Factor + Cable Loss- Preamp Factor
Margin value = Emission level – Limit value.
- 5300MHz: Fundamental frequency.



CHANNEL	TX Channel 64	DETECTOR FUNCTION	Peak (PK)
FREQUENCY RANGE	1GHz ~ 40GHz		Average (AV)

ANTENNA POLARITY & TEST DISTANCE: HORIZONTAL AT 3 M

FREQ. (MHz)	EMISSION LEVEL (dBuV/m)	READ LEVEL (dBuV)	LIMIT (dBuV/m)	MARGIN (dB)	ANTENNA FACTOR (dB /m)	CABLE LOSS (dB)	PREAMP FACTOR (dB)	ANTENNA HEIGHT (cm)	TABLE ANGLE (Degree)	REMARK
5150	57.7	60.68	74	-16.3	35.95	7.42	46.35	100	230	Peak
5150	46.18	49.16	54	-7.82	35.95	7.42	46.35	100	230	Average
5320	103.97	106.69			36.12	7.46	46.3	100	230	Peak
5320	93.43	96.15			36.12	7.46	46.3	100	230	Average
5350	57.57	60.25	74	-16.43	36.15	7.47	46.3	100	230	Peak
5350	46.88	49.56	54	-7.12	36.15	7.47	46.3	100	230	Average

ANTENNA POLARITY & TEST DISTANCE: VERTICAL AT 3 M

FREQ. (MHz)	EMISSION LEVEL (dBuV/m)	READ LEVEL (dBuV)	LIMIT (dBuV/m)	MARGIN (dB)	ANTENNA FACTOR (dB /m)	CABLE LOSS (dB)	PREAMP FACTOR (dB)	ANTENNA HEIGHT (cm)	TABLE ANGLE (Degree)	REMARK
5150	58.16	60.8	74	-15.84	36.29	7.42	46.35	160	290	Peak
5150	46.51	49.15	54	-7.49	36.29	7.42	46.35	160	290	Average
5320	96.18	98.63			36.39	7.46	46.3	160	290	Peak
5320	85.91	88.36			36.39	7.46	46.3	160	290	Average
5350	57.01	59.43	74	-16.99	36.41	7.47	46.3	160	290	Peak
5350	45.73	48.15	54	-8.27	36.41	7.47	46.3	160	290	Average

REMARKS:

- Emission Level = Read Level+ Antenna Factor + Cable Loss- Preamp Factor
Margin value = Emission level – Limit value.
- 5320MHz: Fundamental frequency.



802.11n (40MHz)

CHANNEL	TX Channel 54	DETECTOR FUNCTION	Peak (PK)
FREQUENCY RANGE	1GHz ~ 40GHz		Average (AV)

ANTENNA POLARITY & TEST DISTANCE: HORIZONTAL AT 3 M

FREQ. (MHz)	EMISSION LEVEL (dBuV/m)	READ LEVEL (dBuV)	LIMIT (dBuV/m)	MARGIN (dB)	ANTENNA FACTOR (dB /m)	CABLE LOSS (dB)	PREAMP FACTOR (dB)	ANTENNA HEIGHT (cm)	TABLE ANGLE (Degree)	REMARK
5150	57.26	60.24	74	-16.74	35.95	7.42	46.35	100	230	Peak
5150	46	48.98	54	-8	35.95	7.42	46.35	100	230	Average
5270	99.62	102.42			36.07	7.45	46.32	100	230	Peak
5270	90.86	93.66			36.07	7.45	46.32	100	230	Average
5350	55.04	57.72	74	-18.96	36.15	7.47	46.3	100	230	Peak
5350	45.21	47.89	54	-8.79	36.15	7.47	46.3	100	230	Average

ANTENNA POLARITY & TEST DISTANCE: VERTICAL AT 3 M

FREQ. (MHz)	EMISSION LEVEL (dBuV/m)	READ LEVEL (dBuV)	LIMIT (dBuV/m)	MARGIN (dB)	ANTENNA FACTOR (dB /m)	CABLE LOSS (dB)	PREAMP FACTOR (dB)	ANTENNA HEIGHT (cm)	TABLE ANGLE (Degree)	REMARK
5150	58.7	61.34	74	-15.3	36.29	7.42	46.35	100	260	Peak
5150	46.51	49.15	54	-7.49	36.29	7.42	46.35	100	260	Average
5270	92.51	95.02			36.36	7.45	46.32	100	260	Peak
5270	82.61	85.12			36.36	7.45	46.32	100	260	Average
5350	56.19	58.61	74	-17.81	36.41	7.47	46.3	100	260	Peak
5350	45.3	47.72	54	-8.7	36.41	7.47	46.3	100	260	Average

REMARKS:

- Emission Level = Read Level+ Antenna Factor + Cable Loss- Preamp Factor
Margin value = Emission level – Limit value.
- 5270MHz: Fundamental frequency.



CHANNEL	TX Channel 62	DETECTOR FUNCTION	Peak (PK)
FREQUENCY RANGE	1GHz ~ 40GHz		Average (AV)

ANTENNA POLARITY & TEST DISTANCE: HORIZONTAL AT 3 M

FREQ. (MHz)	EMISSION LEVEL (dBuV/m)	READ LEVEL (dBuV)	LIMIT (dBuV/m)	MARGIN (dB)	ANTENNA FACTOR (dB /m)	CABLE LOSS (dB)	PREAMP FACTOR (dB)	ANTENNA HEIGHT (cm)	TABLE ANGLE (Degree)	REMARK
5150	55.18	58.16	74	-18.82	35.95	7.42	46.35	100	310	Peak
5150	42.63	45.61	54	-11.37	35.95	7.42	46.35	100	310	Average
5310	98.89	101.63			36.11	7.46	46.31	100	310	Peak
5310	90.7	93.44			36.11	7.46	46.31	100	310	Average
5350	62.14	64.82	74	-11.86	36.15	7.47	46.3	100	310	Peak
5350	50.83	53.51	54	-3.17	36.15	7.47	46.3	100	310	Average

ANTENNA POLARITY & TEST DISTANCE: VERTICAL AT 3 M

FREQ. (MHz)	EMISSION LEVEL (dBuV/m)	READ LEVEL (dBuV)	LIMIT (dBuV/m)	MARGIN (dB)	ANTENNA FACTOR (dB /m)	CABLE LOSS (dB)	PREAMP FACTOR (dB)	ANTENNA HEIGHT (cm)	TABLE ANGLE (Degree)	REMARK
5150	57.69	60.33	74	-16.31	36.29	7.42	46.35	100	290	Peak
5150	45.01	47.65	54	-8.99	36.29	7.42	46.35	100	290	Average
5310	91.39	93.85			36.39	7.46	46.31	100	290	Peak
5310	81.19	83.65			36.39	7.46	46.31	100	290	Average
5350	57.69	60.11	74	-16.31	36.41	7.47	46.3	100	290	Peak
5350	46.71	49.13	54	-7.29	36.41	7.47	46.3	100	290	Average

REMARKS:

- Emission Level = Read Level+ Antenna Factor + Cable Loss- Preamp Factor
Margin value = Emission level – Limit value.
- 5310MHz: Fundamental frequency.



Band 3

802.11a

CHANNEL	TX Channel 100	DETECTOR FUNCTION	Peak (PK)
FREQUENCY RANGE	1GHz ~ 40GHz		Average (AV)

ANTENNA POLARITY & TEST DISTANCE: HORIZONTAL AT 3 M

FREQ. (MHz)	EMISSION LEVEL (dBuV/m)	READ LEVEL (dBuV)	LIMIT (dBuV/m)	MARGIN (dB)	ANTENNA FACTOR (dB /m)	CABLE LOSS (dB)	PREAMP FACTOR (dB)	ANTENNA HEIGHT (cm)	TABLE ANGLE (Degree)	REMARK
5460	63.61	66.12	74	-10.39	36.26	7.49	46.26	180	150	Peak
5460	48.45	50.96	54	-5.55	36.26	7.49	46.26	180	150	Average
#5470	66.24	68.74	68.3	-2.06	36.27	7.49	46.26	180	150	Peak
5500	108.36	110.81			36.3	7.5	46.25	180	150	Peak
5500	100.55	103			36.3	7.5	46.25	180	150	Average

ANTENNA POLARITY & TEST DISTANCE: VERTICAL AT 3 M

FREQ. (MHz)	EMISSION LEVEL (dBuV/m)	READ LEVEL (dBuV)	LIMIT (dBuV/m)	MARGIN (dB)	ANTENNA FACTOR (dB /m)	CABLE LOSS (dB)	PREAMP FACTOR (dB)	ANTENNA HEIGHT (cm)	TABLE ANGLE (Degree)	REMARK
5460	56.5	58.79	74	-17.5	36.48	7.49	46.26	100	270	Peak
5460	43.84	46.13	54	-10.16	36.48	7.49	46.26	100	270	Average
#5470	55.75	58.04	68.3	-12.55	36.48	7.49	46.26	100	270	Peak
5500	97.89	100.14			36.5	7.5	46.25	100	270	Peak
5500	87	89.25			36.5	7.5	46.25	100	270	Average

REMARKS:

- Emission Level = Read Level+ Antenna Factor + Cable Loss- Preamp Factor
Margin value = Emission level – Limit value.
- 5500MHz: Fundamental frequency.
- #: Out of restricted band.



CHANNEL	TX Channel 116	DETECTOR FUNCTION	Peak (PK)
FREQUENCY RANGE	1GHz ~ 40GHz		Average (AV)

ANTENNA POLARITY & TEST DISTANCE: HORIZONTAL AT 3 M

FREQ. (MHz)	EMISSION LEVEL (dBuV/m)	READ LEVEL (dBuV)	LIMIT (dBuV/m)	MARGIN (dB)	ANTENNA FACTOR (dB /m)	CABLE LOSS (dB)	PREAMP FACTOR (dB)	ANTENNA HEIGHT (cm)	TABLE ANGLE (Degree)	REMARK
5460	55.77	58.28	74	-18.23	36.26	7.49	46.26	100	150	Peak
5460	43.78	46.29	54	-10.22	36.26	7.49	46.26	100	150	Average
#5470	55.66	58.16	68.3	-12.64	36.27	7.49	46.26	100	150	Peak
5580	104.93	107.25			36.33	7.58	46.23	100	150	Peak
5580	96.28	98.6			36.33	7.58	46.23	100	150	Average

ANTENNA POLARITY & TEST DISTANCE: VERTICAL AT 3 M

FREQ. (MHz)	EMISSION LEVEL (dBuV/m)	READ LEVEL (dBuV)	LIMIT (dBuV/m)	MARGIN (dB)	ANTENNA FACTOR (dB /m)	CABLE LOSS (dB)	PREAMP FACTOR (dB)	ANTENNA HEIGHT (cm)	TABLE ANGLE (Degree)	REMARK
5460	55.18	57.47	74	-18.82	36.48	7.49	46.26	100	270	Peak
5460	43.83	46.12	54	-10.17	36.48	7.49	46.26	100	270	Average
#5470	55.56	57.85	68.3	-12.74	36.48	7.49	46.26	100	270	Peak
5580	94.74	96.84			36.55	7.58	46.23	100	270	Peak
5580	85.05	87.15			36.55	7.58	46.23	100	270	Average

REMARKS:

1. Emission Level = Read Level+ Antenna Factor + Cable Loss- Preamp Factor
Margin value = Emission level – Limit value.
2. 5580MHz: Fundamental frequency.
3. #: Out of restricted band.



CHANNEL	TX Channel 140	DETECTOR FUNCTION	Peak (PK)
FREQUENCY RANGE	1GHz ~ 40GHz		Average (AV)

ANTENNA POLARITY & TEST DISTANCE: HORIZONTAL AT 3 M										
FREQ. (MHz)	EMISSION LEVEL (dBuV/m)	READ LEVEL (dBuV)	LIMIT (dBuV/m)	MARGIN (dB)	ANTENNA FACTOR (dB /m)	CABLE LOSS (dB)	PREAMP FACTOR (dB)	ANTENNA HEIGHT (cm)	TABLE ANGLE (Degree)	REMARK
5700	104.27	106.38			36.38	7.7	46.19	100	140	Peak
5700	95.74	97.85			36.38	7.7	46.19	100	140	Average
#5725	64.15	66.22	68.3	-4.15	36.39	7.73	46.19	100	140	Peak
ANTENNA POLARITY & TEST DISTANCE: VERTICAL AT 3 M										
FREQ. (MHz)	EMISSION LEVEL (dBuV/m)	READ LEVEL (dBuV)	LIMIT (dBuV/m)	MARGIN (dB)	ANTENNA FACTOR (dB /m)	CABLE LOSS (dB)	PREAMP FACTOR (dB)	ANTENNA HEIGHT (cm)	TABLE ANGLE (Degree)	REMARK
5700	95.47	97.34			36.62	7.7	46.19	100	255	Peak
5700	86.25	88.12			36.62	7.7	46.19	100	255	Average
#5725	63.51	65.34	68.3	-4.79	36.63	7.73	46.19	100	255	Peak

REMARKS:

- Emission Level = Read Level+ Antenna Factor + Cable Loss- Preamp Factor
Margin value = Emission level – Limit value.
- 5700MHz: Fundamental frequency.
- #: Out of restricted band.



802.11n (20MHz)

CHANNEL	TX Channel 100	DETECTOR FUNCTION	Peak (PK)
FREQUENCY RANGE	1GHz ~ 40GHz		Average (AV)

ANTENNA POLARITY & TEST DISTANCE: HORIZONTAL AT 3 M										
FREQ. (MHz)	EMISSION LEVEL (dBuV/m)	READ LEVEL (dBuV)	LIMIT (dBuV/m)	MARGIN (dB)	ANTENNA FACTOR (dB /m)	CABLE LOSS (dB)	PREAMP FACTOR (dB)	ANTENNA HEIGHT (cm)	TABLE ANGLE (Degree)	REMARK
5460	58.31	60.82	74	-15.69	36.26	7.49	46.26	130	150	Peak
5460	45.2	47.71	54	-8.8	36.26	7.49	46.26	130	150	Average
#5470	63.68	66.18	68.3	-4.62	36.27	7.49	46.26	130	150	Peak
5500	104.89	107.34			36.3	7.5	46.25	130	150	Peak
5500	96.86	99.31			36.3	7.5	46.25	130	150	Average
ANTENNA POLARITY & TEST DISTANCE: VERTICAL AT 3 M										
FREQ. (MHz)	EMISSION LEVEL (dBuV/m)	READ LEVEL (dBuV)	LIMIT (dBuV/m)	MARGIN (dB)	ANTENNA FACTOR (dB /m)	CABLE LOSS (dB)	PREAMP FACTOR (dB)	ANTENNA HEIGHT (cm)	TABLE ANGLE (Degree)	REMARK
5460	57.34	59.63	74	-16.66	36.48	7.49	46.26	100	250	Peak
5460	44.14	46.43	54	-9.86	36.48	7.49	46.26	100	250	Average
#5470	56.33	58.62	68.3	-11.97	36.48	7.49	46.26	100	250	Peak
5500	94.73	96.98			36.5	7.5	46.25	100	250	Peak
5500	85.03	87.28			36.5	7.5	46.25	100	250	Average

REMARKS:

1. Emission Level = Read Level+ Antenna Factor + Cable Loss- Preamp Factor
Margin value = Emission level – Limit value.
2. 5500MHz: Fundamental frequency.
3. #: Out of restricted band.



CHANNEL	TX Channel 116	DETECTOR FUNCTION	Peak (PK)
FREQUENCY RANGE	1GHz ~ 40GHz		Average (AV)

ANTENNA POLARITY & TEST DISTANCE: HORIZONTAL AT 3 M

FREQ. (MHz)	EMISSION LEVEL (dBuV/m)	READ LEVEL (dBuV)	LIMIT (dBuV/m)	MARGIN (dB)	ANTENNA FACTOR (dB /m)	CABLE LOSS (dB)	PREAMP FACTOR (dB)	ANTENNA HEIGHT (cm)	TABLE ANGLE (Degree)	REMARK
5460	55.99	58.5	74	-18.01	36.26	7.49	46.26	100	150	Peak
5460	44.74	47.25	54	-9.26	36.26	7.49	46.26	100	150	Average
#5470	56.25	58.75	68.3	-12.05	36.27	7.49	46.26	100	150	Peak
5580	102.82	105.14			36.33	7.58	46.23	100	150	Peak
5580	95.07	97.39			36.33	7.58	46.23	100	150	Average

ANTENNA POLARITY & TEST DISTANCE: VERTICAL AT 3 M

FREQ. (MHz)	EMISSION LEVEL (dBuV/m)	READ LEVEL (dBuV)	LIMIT (dBuV/m)	MARGIN (dB)	ANTENNA FACTOR (dB /m)	CABLE LOSS (dB)	PREAMP FACTOR (dB)	ANTENNA HEIGHT (cm)	TABLE ANGLE (Degree)	REMARK
5460	55.08	57.37	74	-18.92	36.48	7.49	46.26	100	105	Peak
5460	43.17	45.46	54	-10.83	36.48	7.49	46.26	100	105	Average
#5470	54.27	56.56	68.3	-14.03	36.48	7.49	46.26	100	105	Peak
5580	94.44	96.54			36.55	7.58	46.23	100	105	Peak
5580	85.36	87.46			36.55	7.58	46.23	100	105	Average

REMARKS:

- Emission Level = Read Level+ Antenna Factor + Cable Loss- Preamp Factor
Margin value = Emission level – Limit value.
- 5580MHz: Fundamental frequency.
- #: Out of restricted band.



CHANNEL	TX Channel 140	DETECTOR FUNCTION	Peak (PK)
FREQUENCY RANGE	1GHz ~ 40GHz		Average (AV)

ANTENNA POLARITY & TEST DISTANCE: HORIZONTAL AT 3 M										
FREQ. (MHz)	EMISSION LEVEL (dBuV/m)	READ LEVEL (dBuV)	LIMIT (dBuV/m)	MARGIN (dB)	ANTENNA FACTOR (dB /m)	CABLE LOSS (dB)	PREAMP FACTOR (dB)	ANTENNA HEIGHT (cm)	TABLE ANGLE (Degree)	REMARK
5700	103.55	105.66			36.38	7.7	46.19	100	160	Peak
5700	95.04	97.15			36.38	7.7	46.19	100	160	Average
#5725	65.06	67.13	68.3	-3.24	36.39	7.73	46.19	100	160	Peak
ANTENNA POLARITY & TEST DISTANCE: VERTICAL AT 3 M										
FREQ. (MHz)	EMISSION LEVEL (dBuV/m)	READ LEVEL (dBuV)	LIMIT (dBuV/m)	MARGIN (dB)	ANTENNA FACTOR (dB /m)	CABLE LOSS (dB)	PREAMP FACTOR (dB)	ANTENNA HEIGHT (cm)	TABLE ANGLE (Degree)	REMARK
5700	93.15	95.02			36.62	7.7	46.19	100	260	Peak
5700	84.09	85.96			36.62	7.7	46.19	100	260	Average
#5725	64.39	66.22	68.3	-3.91	36.63	7.73	46.19	100	260	Peak

REMARKS:

1. Emission Level = Read Level+ Antenna Factor + Cable Loss- Preamp Factor
Margin value = Emission level – Limit value.
2. 5700MHz: Fundamental frequency.
3. #: Out of restricted band.



802.11n (40MHz)

CHANNEL	TX Channel 102	DETECTOR FUNCTION	Peak (PK)
FREQUENCY RANGE	1GHz ~ 40GHz		Average (AV)

ANTENNA POLARITY & TEST DISTANCE: HORIZONTAL AT 3 M

FREQ. (MHz)	EMISSION LEVEL (dBuV/m)	READ LEVEL (dBuV)	LIMIT (dBuV/m)	MARGIN (dB)	ANTENNA FACTOR (dB /m)	CABLE LOSS (dB)	PREAMP FACTOR (dB)	ANTENNA HEIGHT (cm)	TABLE ANGLE (Degree)	REMARK
5460	62.45	64.96	74	-11.55	36.26	7.49	46.26	100	0	Peak
5460	49.15	51.66	54	-4.85	36.26	7.49	46.26	100	0	Average
#5470	64.25	66.75	68.3	-4.05	36.27	7.49	46.26	100	0	Peak
5510	97.39	99.83			36.3	7.51	46.25	100	0	Peak
5510	89.24	91.68			36.3	7.51	46.25	100	0	Average

ANTENNA POLARITY & TEST DISTANCE: VERTICAL AT 3 M

FREQ. (MHz)	EMISSION LEVEL (dBuV/m)	READ LEVEL (dBuV)	LIMIT (dBuV/m)	MARGIN (dB)	ANTENNA FACTOR (dB /m)	CABLE LOSS (dB)	PREAMP FACTOR (dB)	ANTENNA HEIGHT (cm)	TABLE ANGLE (Degree)	REMARK
5460	62.83	65.12	74	-11.17	36.48	7.49	46.26	100	0	Peak
5460	48.04	50.33	54	-5.96	36.48	7.49	46.26	100	0	Average
#5470	60.93	63.22	68.3	-7.37	36.48	7.49	46.26	100	0	Peak
5510	95.89	98.12			36.51	7.51	46.25	100	0	Peak
5510	87.89	90.12			36.51	7.51	46.25	100	0	Average

REMARKS:

- Emission Level = Read Level+ Antenna Factor + Cable Loss- Preamp Factor
Margin value = Emission level – Limit value.
- 5510MHz: Fundamental frequency.
- #: Out of restricted band.



CHANNEL	TX Channel 110	DETECTOR FUNCTION	Peak (PK)
FREQUENCY RANGE	1GHz ~ 40GHz		Average (AV)

ANTENNA POLARITY & TEST DISTANCE: HORIZONTAL AT 3 M

FREQ. (MHz)	EMISSION LEVEL (dBuV/m)	READ LEVEL (dBuV)	LIMIT (dBuV/m)	MARGIN (dB)	ANTENNA FACTOR (dB /m)	CABLE LOSS (dB)	PREAMP FACTOR (dB)	ANTENNA HEIGHT (cm)	TABLE ANGLE (Degree)	REMARK
5460	55.51	58.02	74	-18.49	36.26	7.49	46.26	100	160	Peak
5460	43.68	46.19	54	-10.32	36.26	7.49	46.26	100	160	Average
#5470	56.13	58.63	68.3	-12.17	36.27	7.49	46.26	100	160	Peak
5550	98.52	100.89			36.32	7.55	46.24	100	160	Peak
5550	90.68	93.05			36.32	7.55	46.24	100	160	Average

ANTENNA POLARITY & TEST DISTANCE: VERTICAL AT 3 M

FREQ. (MHz)	EMISSION LEVEL (dBuV/m)	READ LEVEL (dBuV)	LIMIT (dBuV/m)	MARGIN (dB)	ANTENNA FACTOR (dB /m)	CABLE LOSS (dB)	PREAMP FACTOR (dB)	ANTENNA HEIGHT (cm)	TABLE ANGLE (Degree)	REMARK
5460	54.88	57.17	74	-19.12	36.48	7.49	46.26	100	270	Peak
5460	43.83	46.12	54	-10.17	36.48	7.49	46.26	100	270	Average
#5470	55.36	57.65	68.3	-12.94	36.48	7.49	46.26	100	270	Peak
5550	88.83	90.99			36.53	7.55	46.24	100	270	Peak
5550	82.71	84.87			36.53	7.55	46.24	100	270	Average

REMARKS:

- Emission Level = Read Level+ Antenna Factor + Cable Loss- Preamp Factor
Margin value = Emission level – Limit value.
- 5550MHz: Fundamental frequency.
- #: Out of restricted band.



CHANNEL	TX Channel 134	DETECTOR FUNCTION	Peak (PK)
FREQUENCY RANGE	1GHz ~ 40GHz		Average (AV)

ANTENNA POLARITY & TEST DISTANCE: HORIZONTAL AT 3 M

FREQ. (MHz)	EMISSION LEVEL (dBuV/m)	READ LEVEL (dBuV)	LIMIT (dBuV/m)	MARGIN (dB)	ANTENNA FACTOR (dB /m)	CABLE LOSS (dB)	PREAMP FACTOR (dB)	ANTENNA HEIGHT (cm)	TABLE ANGLE (Degree)	REMARK
5670	97.05	99.21			36.37	7.67	46.2	100	190	Peak
5670	88.46	90.62			36.37	7.67	46.2	100	190	Average
#5725	62.66	64.73	68.3	-5.64	36.39	7.73	46.19	100	190	Peak

ANTENNA POLARITY & TEST DISTANCE: VERTICAL AT 3 M

FREQ. (MHz)	EMISSION LEVEL (dBuV/m)	READ LEVEL (dBuV)	LIMIT (dBuV/m)	MARGIN (dB)	ANTENNA FACTOR (dB /m)	CABLE LOSS (dB)	PREAMP FACTOR (dB)	ANTENNA HEIGHT (cm)	TABLE ANGLE (Degree)	REMARK
5670	87.85	89.78			36.6	7.67	46.2	100	100	Peak
5670	77.97	79.9			36.6	7.67	46.2	100	100	Average
#5725	58.79	60.62	68.3	-9.51	36.63	7.73	46.19	100	100	Peak

REMARKS:

- Emission Level = Read Level+ Antenna Factor + Cable Loss- Preamp Factor
Margin value = Emission level – Limit value.
- 5670MHz: Fundamental frequency.
- #: Out of restricted band.



Band 4:

802.11a

CHANNEL	TX Channel 149	DETECTOR FUNCTION	Peak (PK)
FREQUENCY RANGE	1GHz ~ 40GHz		Average (AV)

ANTENNA POLARITY & TEST DISTANCE: HORIZONTAL AT 3 M										
FREQ. (MHz)	EMISSION LEVEL (dBuV/m)	READ LEVEL (dBuV)	LIMIT (dBuV/m)	MARGIN (dB)	ANTENNA FACTOR (dB /m)	CABLE LOSS (dB)	PREAMP FACTOR (dB)	ANTENNA HEIGHT (cm)	TABLE ANGLE (Degree)	REMARK
5745	105.5	107.53			36.4	7.75	46.18	100	360	Peak
5745	97.13	99.16			36.4	7.75	46.18	100	360	Average
ANTENNA POLARITY & TEST DISTANCE: VERTICAL AT 3 M										
FREQ. (MHz)	EMISSION LEVEL (dBuV/m)	READ LEVEL (dBuV)	LIMIT (dBuV/m)	MARGIN (dB)	ANTENNA FACTOR (dB /m)	CABLE LOSS (dB)	PREAMP FACTOR (dB)	ANTENNA HEIGHT (cm)	TABLE ANGLE (Degree)	REMARK
5745	100.07	101.85			36.65	7.75	46.18	100	305	Peak
5745	89.05	90.83			36.65	7.75	46.18	100	305	Average

REMARKS:

- Emission Level = Read Level+ Antenna Factor + Cable Loss- Preamp Factor
Margin value = Emission level – Limit value.
- 5745MHz: Fundamental frequency.



Oobe Data

802.11a

ANTENNA POLARITY & TEST DISTANCE: HORIZONTAL AT 3 M										
FREQ. (MHz)	EMISSION LEVEL (dBuV/m)	READ LEVEL (dBuV)	LIMIT (dBuV/m)	MARGIN (dB)	ANTENNA FACTOR (dB /m)	CABLE LOSS (dB)	PREAMP FACTOR (dB)	ANTENNA HEIGHT (cm)	TABLE ANGLE (Degree)	REMARK
5641.2	59.9	62.11	68.3	-8.4	36.36	7.64	46.21	100	360	Peak
6004.575	60.11	61.72	68.3	-8.19	36.5	8	46.11	100	360	Peak
ANTENNA POLARITY & TEST DISTANCE: VERTICAL AT 3 M										
FREQ. (MHz)	EMISSION LEVEL (dBuV/m)	READ LEVEL (dBuV)	LIMIT (dBuV/m)	MARGIN (dB)	ANTENNA FACTOR (dB /m)	CABLE LOSS (dB)	PREAMP FACTOR (dB)	ANTENNA HEIGHT (cm)	TABLE ANGLE (Degree)	REMARK
5623.15	60.11	62.13	68.3	-8.19	36.57	7.63	46.22	200	360	Peak
5988.425	60.04	61.36	68.3	-8.26	36.79	8	46.11	200	360	Peak

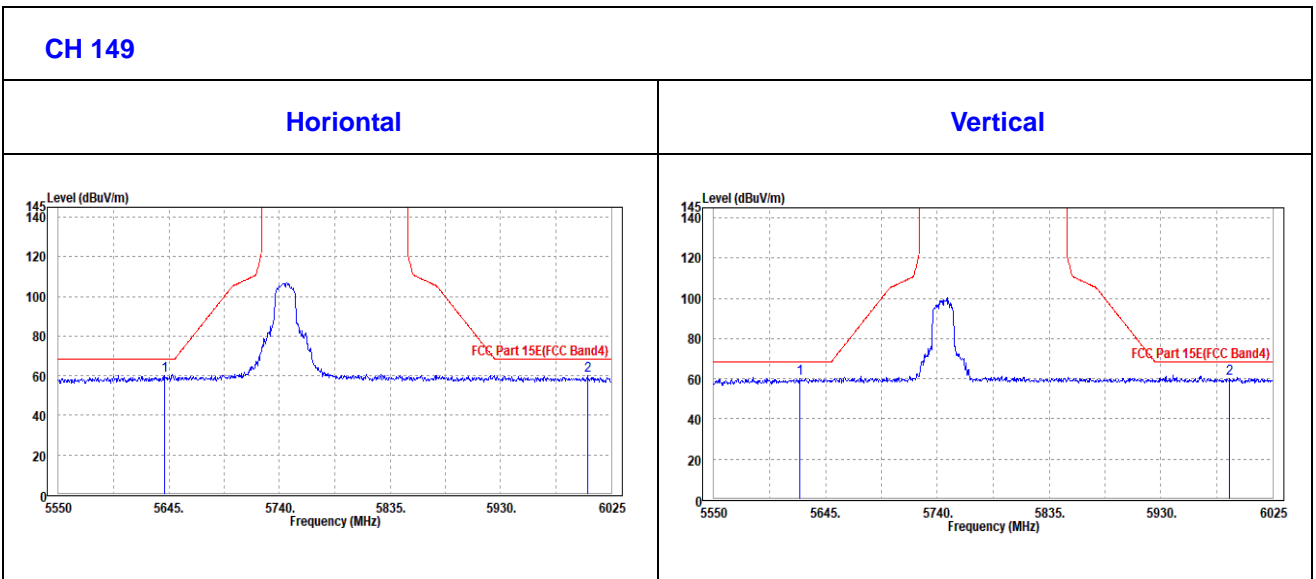



CHANNEL	TX Channel 157	DETECTOR FUNCTION	Peak (PK)
FREQUENCY RANGE	1GHz ~ 40GHz		Average (AV)

ANTENNA POLARITY & TEST DISTANCE: HORIZONTAL AT 3 M

FREQ. (MHz)	EMISSION LEVEL (dBuV/m)	READ LEVEL (dBuV)	LIMIT (dBuV/m)	MARGIN (dB)	ANTENNA FACTOR (dB /m)	CABLE LOSS (dB)	PREAMP FACTOR (dB)	ANTENNA HEIGHT (cm)	TABLE ANGLE (Degree)	REMARK
5785	108.4	110.37			36.41	7.79	46.17	100	330	Peak
5785	97.53	99.5			36.41	7.79	46.17	100	330	Average

ANTENNA POLARITY & TEST DISTANCE: VERTICAL AT 3 M

FREQ. (MHz)	EMISSION LEVEL (dBuV/m)	READ LEVEL (dBuV)	LIMIT (dBuV/m)	MARGIN (dB)	ANTENNA FACTOR (dB /m)	CABLE LOSS (dB)	PREAMP FACTOR (dB)	ANTENNA HEIGHT (cm)	TABLE ANGLE (Degree)	REMARK
5785	101.77	103.48			36.67	7.79	46.17	100	300	Peak
5785	91.67	93.38			36.67	7.79	46.17	100	300	Average

REMARKS:

- Emission Level = Read Level+ Antenna Factor + Cable Loss- Preamp Factor
Margin value = Emission level – Limit value.
- 5785MHz: Fundamental frequency.



OUBE DATA

802.11a

ANTENNA POLARITY & TEST DISTANCE: HORIZONTAL AT 3 M										
FREQ. (MHz)	EMISSION LEVEL (dBuV/m)	READ LEVEL (dBuV)	LIMIT (dBuV/m)	MARGIN (dB)	ANTENNA FACTOR (dB /m)	CABLE LOSS (dB)	PREAMP FACTOR (dB)	ANTENNA HEIGHT (cm)	TABLE ANGLE (Degree)	REMARK
5617.925	60.18	62.43	68.3	-8.12	36.35	7.62	46.22	100	360	Peak
6008.375	58.69	60.29	68.3	-9.61	36.51	8	46.11	100	360	Peak
ANTENNA POLARITY & TEST DISTANCE: VERTICAL AT 3 M										
FREQ. (MHz)	EMISSION LEVEL (dBuV/m)	READ LEVEL (dBuV)	LIMIT (dBuV/m)	MARGIN (dB)	ANTENNA FACTOR (dB /m)	CABLE LOSS (dB)	PREAMP FACTOR (dB)	ANTENNA HEIGHT (cm)	TABLE ANGLE (Degree)	REMARK
5641.675	59.58	61.56	68.3	-8.72	36.59	7.64	46.21	200	360	Peak
6019.775	58.15	59.45	68.3	-10.15	36.82	7.98	46.1	200	360	Peak

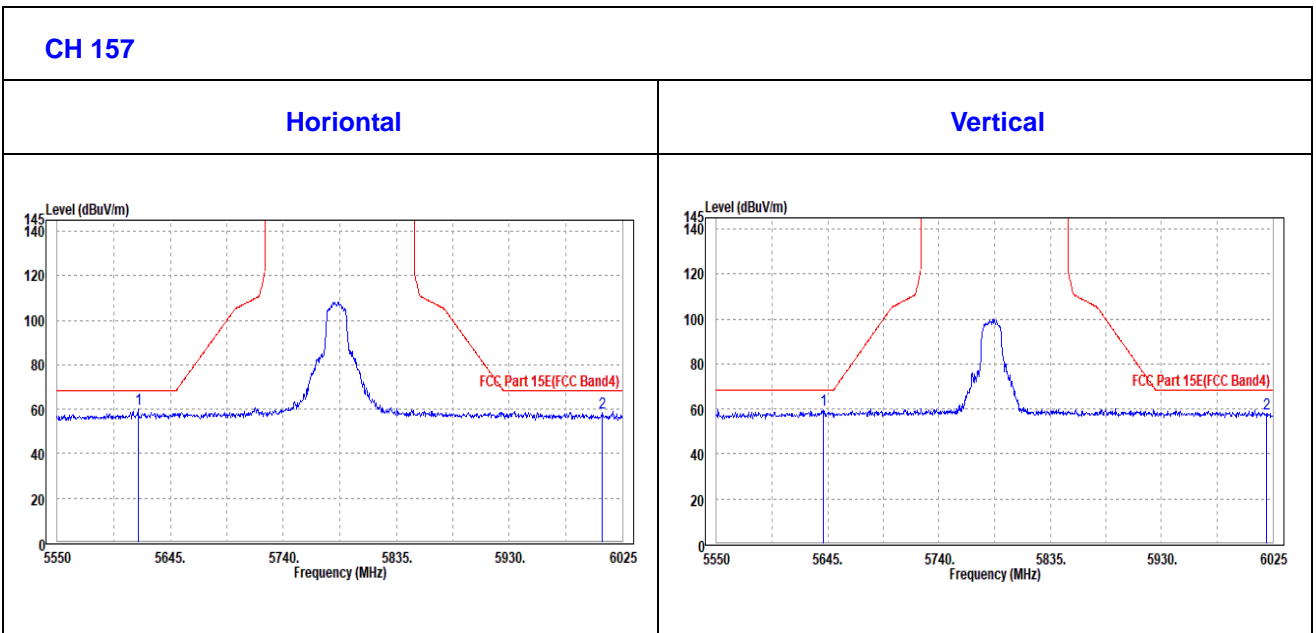



CHANNEL	TX Channel 161	DETECTOR FUNCTION	Peak (PK)
FREQUENCY RANGE	1GHz ~ 40GHz		Average (AV)

ANTENNA POLARITY & TEST DISTANCE: HORIZONTAL AT 3 M

FREQ. (MHz)	EMISSION LEVEL (dBuV/m)	READ LEVEL (dBuV)	LIMIT (dBuV/m)	MARGIN (dB)	ANTENNA FACTOR (dB /m)	CABLE LOSS (dB)	PREAMP FACTOR (dB)	ANTENNA HEIGHT (cm)	TABLE ANGLE (Degree)	REMARK
5805	108.03	109.96			36.42	7.81	46.16	100	55	Peak
5805	96.81	98.74			36.42	7.81	46.16	100	55	Average

ANTENNA POLARITY & TEST DISTANCE: VERTICAL AT 3 M

FREQ. (MHz)	EMISSION LEVEL (dBuV/m)	READ LEVEL (dBuV)	LIMIT (dBuV/m)	MARGIN (dB)	ANTENNA FACTOR (dB /m)	CABLE LOSS (dB)	PREAMP FACTOR (dB)	ANTENNA HEIGHT (cm)	TABLE ANGLE (Degree)	REMARK
5805	102.13	103.8			36.68	7.81	46.16	100	75	Peak
5805	94.53	96.2			36.68	7.81	46.16	100	75	Average

REMARKS:

- Emission Level = Read Level+ Antenna Factor + Cable Loss- Preamp Factor
Margin value = Emission level – Limit value.
- 5805MHz: Fundamental frequency.



Oobe Data

802.11a

ANTENNA POLARITY & TEST DISTANCE: HORIZONTAL AT 3 M										
FREQ. (MHz)	EMISSION LEVEL (dBuV/m)	READ LEVEL (dBuV)	LIMIT (dBuV/m)	MARGIN (dB)	ANTENNA FACTOR (dB /m)	CABLE LOSS (dB)	PREAMP FACTOR (dB)	ANTENNA HEIGHT (cm)	TABLE ANGLE (Degree)	REMARK
5597.5	58.58	60.86	68.3	-9.72	36.34	7.6	46.22	200	360	Peak
5974.175	59.31	60.96	68.3	-8.99	36.49	7.98	46.12	200	360	Peak
ANTENNA POLARITY & TEST DISTANCE: VERTICAL AT 3 M										
FREQ. (MHz)	EMISSION LEVEL (dBuV/m)	READ LEVEL (dBuV)	LIMIT (dBuV/m)	MARGIN (dB)	ANTENNA FACTOR (dB /m)	CABLE LOSS (dB)	PREAMP FACTOR (dB)	ANTENNA HEIGHT (cm)	TABLE ANGLE (Degree)	REMARK
5615.55	59.17	61.2	68.3	-9.13	36.57	7.62	46.22	100	360	Peak
5971.8	60.35	61.71	68.3	-7.95	36.78	7.98	46.12	100	360	Peak

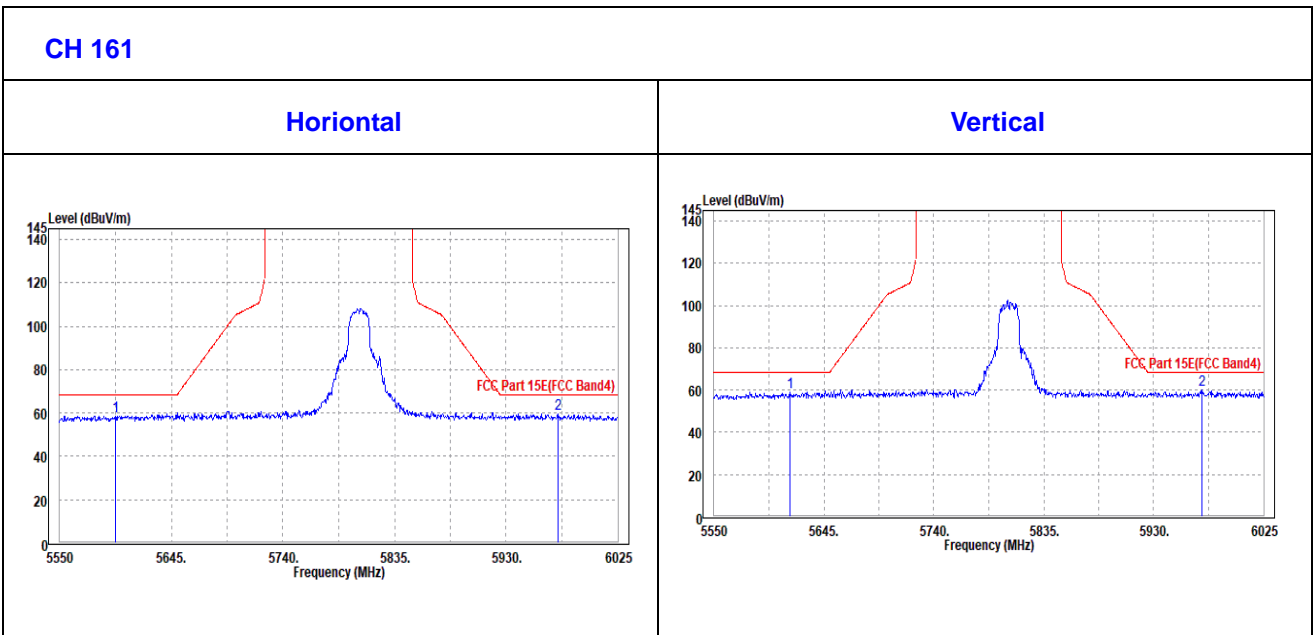



802.11n (20MHz)

CHANNEL	TX Channel 149	DETECTOR FUNCTION	Peak (PK)
FREQUENCY RANGE	1GHz ~ 40GHz		Average (AV)

ANTENNA POLARITY & TEST DISTANCE: HORIZONTAL AT 3 M										
FREQ. (MHz)	EMISSION LEVEL (dBuV/m)	READ LEVEL (dBuV)	LIMIT (dBuV/m)	MARGIN (dB)	ANTENNA FACTOR (dB /m)	CABLE LOSS (dB)	PREAMP FACTOR (dB)	ANTENNA HEIGHT (cm)	TABLE ANGLE (Degree)	REMARK
5745	105.94	107.97			36.4	7.75	46.18	100	45	Peak
5745	95.48	97.51			36.4	7.75	46.18	100	45	Average
ANTENNA POLARITY & TEST DISTANCE: VERTICAL AT 3 M										
FREQ. (MHz)	EMISSION LEVEL (dBuV/m)	READ LEVEL (dBuV)	LIMIT (dBuV/m)	MARGIN (dB)	ANTENNA FACTOR (dB /m)	CABLE LOSS (dB)	PREAMP FACTOR (dB)	ANTENNA HEIGHT (cm)	TABLE ANGLE (Degree)	REMARK
5745	97.98	99.76			36.65	7.75	46.18	100	310	Peak
5745	88.1	89.88			36.65	7.75	46.18	100	310	Average

REMARKS:

- Emission Level = Read Level+ Antenna Factor + Cable Loss- Preamp Factor
Margin value = Emission level – Limit value.
- 5745MHz: Fundamental frequency.



Oobe Data

802.11n (20MHz)

ANTENNA POLARITY & TEST DISTANCE: HORIZONTAL AT 3 M										
FREQ. (MHz)	EMISSION LEVEL (dBuV/m)	READ LEVEL (dBuV)	LIMIT (dBuV/m)	MARGIN (dB)	ANTENNA FACTOR (dB /m)	CABLE LOSS (dB)	PREAMP FACTOR (dB)	ANTENNA HEIGHT (cm)	TABLE ANGLE (Degree)	REMARK
5611.275	59.61	61.88	68.3	-8.69	36.34	7.61	46.22	200	0	Peak
5938.55	60.84	62.54	68.3	-7.46	36.48	7.95	46.13	200	0	Peak
ANTENNA POLARITY & TEST DISTANCE: VERTICAL AT 3 M										
FREQ. (MHz)	EMISSION LEVEL (dBuV/m)	READ LEVEL (dBuV)	LIMIT (dBuV/m)	MARGIN (dB)	ANTENNA FACTOR (dB /m)	CABLE LOSS (dB)	PREAMP FACTOR (dB)	ANTENNA HEIGHT (cm)	TABLE ANGLE (Degree)	REMARK
5636.45	60.43	62.42	68.3	-7.87	36.58	7.64	46.21	100	0	Peak
5949.475	59.99	61.38	68.3	-8.31	36.77	7.96	46.12	100	0	Peak

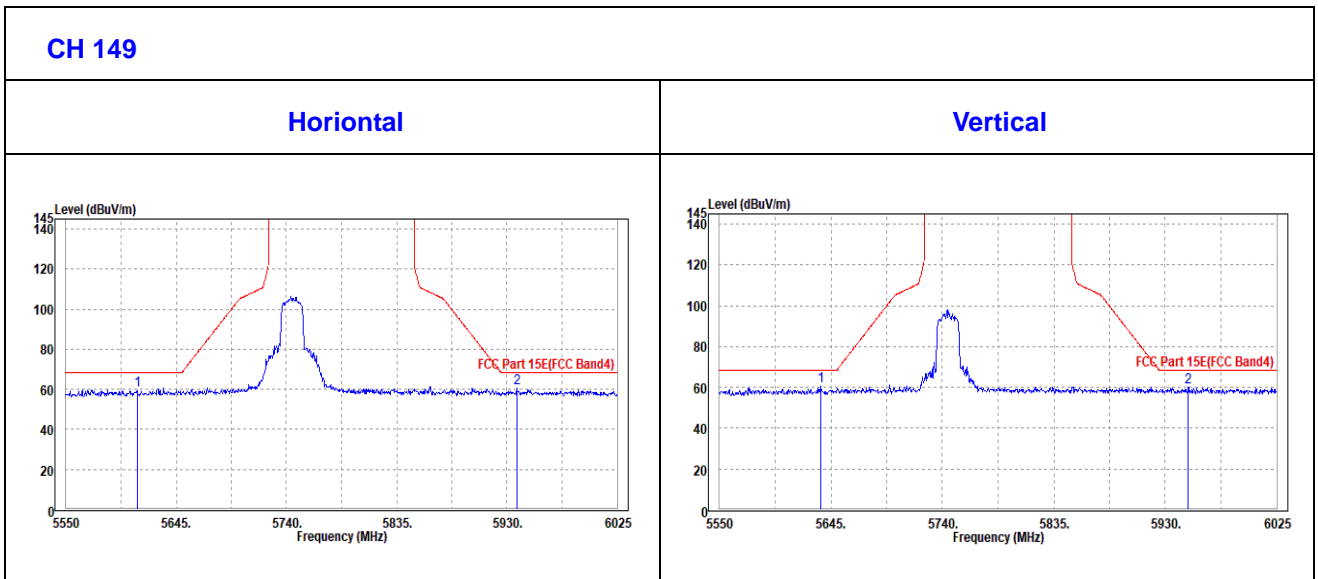



CHANNEL	TX Channel 157	DETECTOR FUNCTION	Peak (PK)
FREQUENCY RANGE	1GHz ~ 40GHz		Average (AV)

ANTENNA POLARITY & TEST DISTANCE: HORIZONTAL AT 3 M

FREQ. (MHz)	EMISSION LEVEL (dBuV/m)	READ LEVEL (dBuV)	LIMIT (dBuV/m)	MARGIN (dB)	ANTENNA FACTOR (dB /m)	CABLE LOSS (dB)	PREAMP FACTOR (dB)	ANTENNA HEIGHT (cm)	TABLE ANGLE (Degree)	REMARK
5785	107.86	109.83			36.41	7.79	46.17	100	330	Peak
5785	99.33	101.3			36.41	7.79	46.17	100	330	Average

ANTENNA POLARITY & TEST DISTANCE: VERTICAL AT 3 M

FREQ. (MHz)	EMISSION LEVEL (dBuV/m)	READ LEVEL (dBuV)	LIMIT (dBuV/m)	MARGIN (dB)	ANTENNA FACTOR (dB /m)	CABLE LOSS (dB)	PREAMP FACTOR (dB)	ANTENNA HEIGHT (cm)	TABLE ANGLE (Degree)	REMARK
5785	101.27	102.98			36.67	7.79	46.17	100	75	Peak
5785	91.39	93.1			36.67	7.79	46.17	100	75	Average

REMARKS:

- Emission Level = Read Level+ Antenna Factor + Cable Loss- Preamp Factor
Margin value = Emission level – Limit value.
- 5785MHz: Fundamental frequency.



Oobe Data

802.11n (20MHz)

ANTENNA POLARITY & TEST DISTANCE: HORIZONTAL AT 3 M										
FREQ. (MHz)	EMISSION LEVEL (dBuV/m)	READ LEVEL (dBuV)	LIMIT (dBuV /m)	MARGIN (dB)	ANTENNA FACTOR (dB /m)	CABLE LOSS (dB)	PREAMP FACTOR (dB)	ANTENNA HEIGHT (cm)	TABLE ANGLE (Degree)	REMARK
5627.9	58.94	61.17	68.3	-9.36	36.35	7.63	46.21	100	0	Peak
5974.175	60.11	61.76	68.3	-8.19	36.49	7.98	46.12	100	0	Peak
ANTENNA POLARITY & TEST DISTANCE: VERTICAL AT 3 M										
FREQ. (MHz)	EMISSION LEVEL (dBuV/m)	READ LEVEL (dBuV)	LIMIT (dBuV /m)	MARGIN (dB)	ANTENNA FACTOR (dB /m)	CABLE LOSS (dB)	PREAMP FACTOR (dB)	ANTENNA HEIGHT (cm)	TABLE ANGLE (Degree)	REMARK
5631.225	60.35	62.35	68.3	-7.95	36.58	7.63	46.21	200	0	Peak
5969.425	60.27	61.63	68.3	-8.03	36.78	7.98	46.12	200	0	Peak

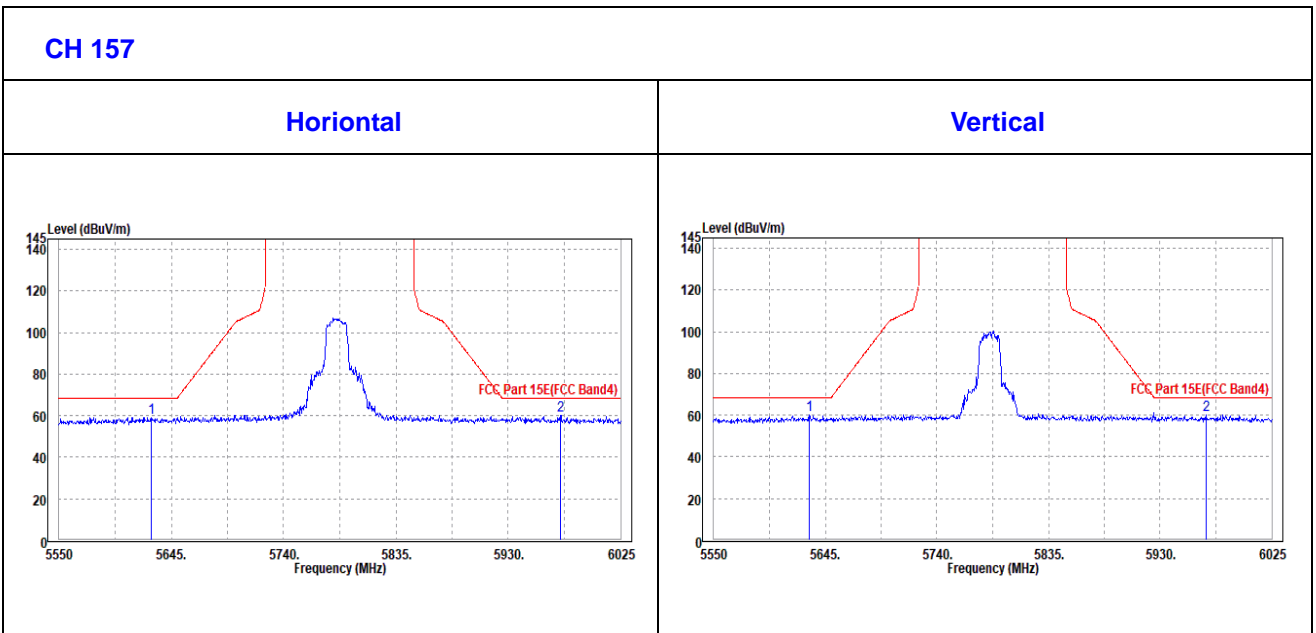



CHANNEL	TX Channel 161	DETECTOR FUNCTION	Peak (PK)
FREQUENCY RANGE	1GHz ~ 40GHz		Average (AV)

ANTENNA POLARITY & TEST DISTANCE: HORIZONTAL AT 3 M

FREQ. (MHz)	EMISSION LEVEL (dBuV/m)	READ LEVEL (dBuV)	LIMIT (dBuV/m)	MARGIN (dB)	ANTENNA FACTOR (dB /m)	CABLE LOSS (dB)	PREAMP FACTOR (dB)	ANTENNA HEIGHT (cm)	TABLE ANGLE (Degree)	REMARK
5805	106.79	108.72			36.42	7.81	46.16	100	0	Peak
5805	98.37	100.3			36.42	7.81	46.16	100	0	Average

ANTENNA POLARITY & TEST DISTANCE: VERTICAL AT 3 M

FREQ. (MHz)	EMISSION LEVEL (dBuV/m)	READ LEVEL (dBuV)	LIMIT (dBuV/m)	MARGIN (dB)	ANTENNA FACTOR (dB /m)	CABLE LOSS (dB)	PREAMP FACTOR (dB)	ANTENNA HEIGHT (cm)	TABLE ANGLE (Degree)	REMARK
5805	102.71	104.38			36.68	7.81	46.16	100	310	Peak
5805	75.12	76.79			36.68	7.81	46.16	100	310	Average

REMARKS:

- Emission Level = Read Level+ Antenna Factor + Cable Loss- Preamp Factor
Margin value = Emission level – Limit value.
- 5805MHz: Fundamental frequency.



OBE DATA

802.11n (20MHZ)

ANTENNA POLARITY & TEST DISTANCE: HORIZONTAL AT 3 M										
FREQ. (MHz)	EMISSION LEVEL (dBuV/m)	READ LEVEL (dBuV)	LIMIT (dBuV/m)	MARGIN (dB)	ANTENNA FACTOR (dB /m)	CABLE LOSS (dB)	PREAMP FACTOR (dB)	ANTENNA HEIGHT (cm)	TABLE ANGLE (Degree)	REMARK
5642.625	57.2	59.4	68.3	-11.1	36.36	7.65	46.21	200	0	Peak
5964.2	58.07	59.73	68.3	-10.23	36.49	7.97	46.12	200	0	Peak
ANTENNA POLARITY & TEST DISTANCE: VERTICAL AT 3 M										
FREQ. (MHz)	EMISSION LEVEL (dBuV/m)	READ LEVEL (dBuV)	LIMIT (dBuV/m)	MARGIN (dB)	ANTENNA FACTOR (dB /m)	CABLE LOSS (dB)	PREAMP FACTOR (dB)	ANTENNA HEIGHT (cm)	TABLE ANGLE (Degree)	REMARK
5612.7	58.14	60.18	68.3	-10.16	36.57	7.61	46.22	100	0	Peak
5961.825	59.2	60.57	68.3	-9.1	36.78	7.97	46.12	100	0	Peak

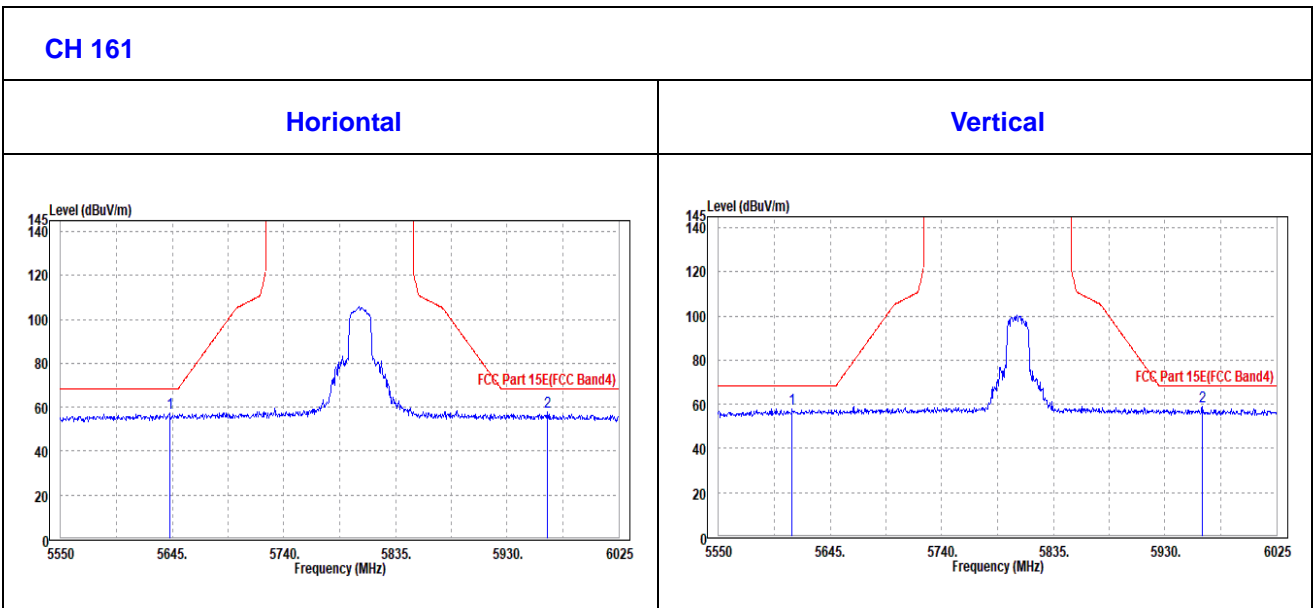



802.11n (40MHz)

CHANNEL	TX Channel 151	DETECTOR FUNCTION	Peak (PK)
FREQUENCY RANGE	1GHz ~ 40GHz		Average (AV)

ANTENNA POLARITY & TEST DISTANCE: HORIZONTAL AT 3 M

FREQ. (MHz)	EMISSION LEVEL (dBuV/m)	READ LEVEL (dBuV)	LIMIT (dBuV/m)	MARGIN (dB)	ANTENNA FACTOR (dB /m)	CABLE LOSS (dB)	PREAMP FACTOR (dB)	ANTENNA HEIGHT (cm)	TABLE ANGLE (Degree)	REMARK
5755	100.06	102.08			36.4	7.76	46.18	100	0	Peak
5755	93.6	95.62			36.4	7.76	46.18	100	0	Average

ANTENNA POLARITY & TEST DISTANCE: VERTICAL AT 3 M

FREQ. (MHz)	EMISSION LEVEL (dBuV/m)	READ LEVEL (dBuV)	LIMIT (dBuV/m)	MARGIN (dB)	ANTENNA FACTOR (dB /m)	CABLE LOSS (dB)	PREAMP FACTOR (dB)	ANTENNA HEIGHT (cm)	TABLE ANGLE (Degree)	REMARK
5755	94.23	96			36.65	7.76	46.18	100	315	Peak
5755	86	87.77			36.65	7.76	46.18	100	315	Average

REMARKS:

- Emission Level = Read Level+ Antenna Factor + Cable Loss- Preamp Factor
Margin value = Emission level – Limit value.
- 5755MHz: Fundamental frequency.



Oobe Data

802.11n (40MHz)

ANTENNA POLARITY & TEST DISTANCE: HORIZONTAL AT 3 M										
FREQ. (MHz)	EMISSION LEVEL (dBuV/m)	READ LEVEL (dBuV)	LIMIT (dBuV/m)	MARGIN (dB)	ANTENNA FACTOR (dB /m)	CABLE LOSS (dB)	PREAMP FACTOR (dB)	ANTENNA HEIGHT (cm)	TABLE ANGLE (Degree)	REMARK
5616.975	58.52	60.77	68.3	-9.78	36.35	7.62	46.22	200	360	Peak
5990.325	58.84	60.45	68.3	-9.46	36.5	8	46.11	200	360	Peak
ANTENNA POLARITY & TEST DISTANCE: VERTICAL AT 3 M										
FREQ. (MHz)	EMISSION LEVEL (dBuV/m)	READ LEVEL (dBuV)	LIMIT (dBuV/m)	MARGIN (dB)	ANTENNA FACTOR (dB /m)	CABLE LOSS (dB)	PREAMP FACTOR (dB)	ANTENNA HEIGHT (cm)	TABLE ANGLE (Degree)	REMARK
5595.6	58.3	60.36	68.3	-10	36.56	7.6	46.22	100	360	Peak
5968	58.69	60.05	68.3	-9.61	36.78	7.98	46.12	100	360	Peak

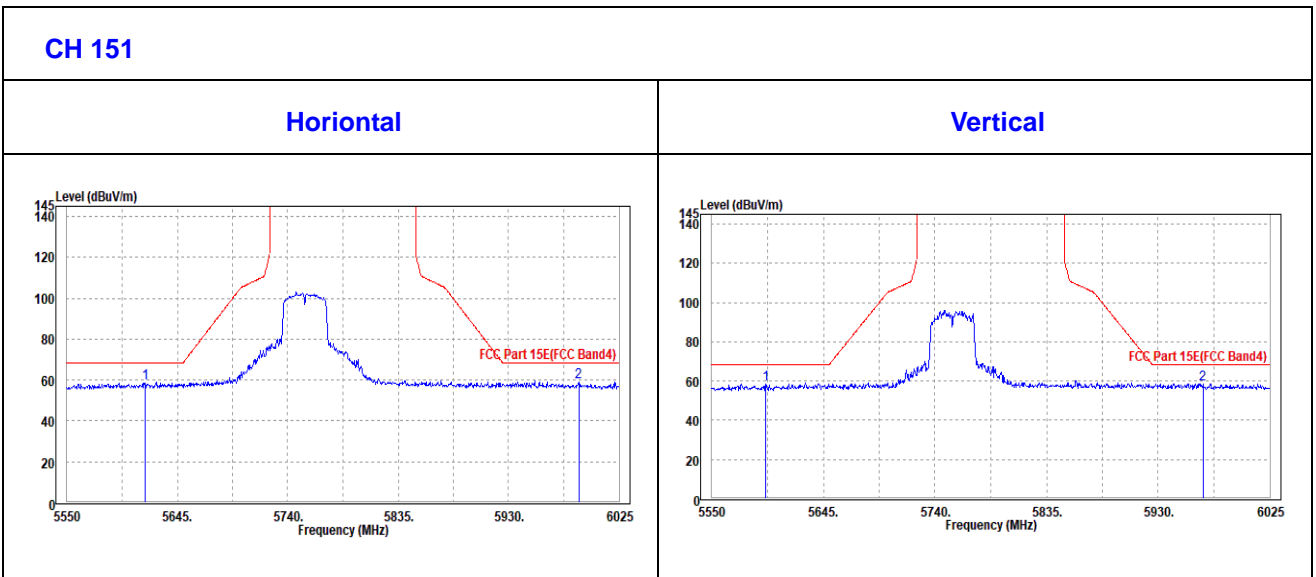



CHANNEL	TX Channel 159	DETECTOR FUNCTION	Peak (PK)
FREQUENCY RANGE	1GHz ~ 40GHz		Average (AV)

ANTENNA POLARITY & TEST DISTANCE: HORIZONTAL AT 3 M

FREQ. (MHz)	EMISSION LEVEL (dBuV/m)	READ LEVEL (dBuV)	LIMIT (dBuV/m)	MARGIN (dB)	ANTENNA FACTOR (dB /m)	CABLE LOSS (dB)	PREAMP FACTOR (dB)	ANTENNA HEIGHT (cm)	TABLE ANGLE (Degree)	REMARK
5795	101.24	103.19			36.42	7.8	46.17	100	330	Peak
5795	93.38	95.33			36.42	7.8	46.17	100	330	Average

ANTENNA POLARITY & TEST DISTANCE: VERTICAL AT 3 M

FREQ. (MHz)	EMISSION LEVEL (dBuV/m)	READ LEVEL (dBuV)	LIMIT (dBuV/m)	MARGIN (dB)	ANTENNA FACTOR (dB /m)	CABLE LOSS (dB)	PREAMP FACTOR (dB)	ANTENNA HEIGHT (cm)	TABLE ANGLE (Degree)	REMARK
5795	110.87	105.27			35.25	16.63	46.28	100	81	Peak
5795	101.29	95.69			35.25	16.63	46.28	100	81	Average

REMARKS:

- Emission Level = Read Level+ Antenna Factor + Cable Loss- Preamp Factor
Margin value = Emission level – Limit value.
- 5795MHz: Fundamental frequency.



Oobe Data

802.11n (40MHz)

ANTENNA POLARITY & TEST DISTANCE: HORIZONTAL AT 3 M										
FREQ. (MHz)	EMISSION LEVEL (dBuV/m)	READ LEVEL (dBuV)	LIMIT (dBuV/m)	MARGIN (dB)	ANTENNA FACTOR (dB /m)	CABLE LOSS (dB)	PREAMP FACTOR (dB)	ANTENNA HEIGHT (cm)	TABLE ANGLE (Degree)	REMARK
5597.975	57.39	59.67	68.3	-10.91	36.34	7.6	46.22	200	360	Peak
5995.55	57.15	58.75	68.3	-11.15	36.5	8.01	46.11	200	360	Peak
ANTENNA POLARITY & TEST DISTANCE: VERTICAL AT 3 M										
FREQ. (MHz)	EMISSION LEVEL (dBuV/m)	READ LEVEL (dBuV)	LIMIT (dBuV/m)	MARGIN (dB)	ANTENNA FACTOR (dB /m)	CABLE LOSS (dB)	PREAMP FACTOR (dB)	ANTENNA HEIGHT (cm)	TABLE ANGLE (Degree)	REMARK
5589.425	58.17	60.25	68.3	-10.13	36.55	7.59	46.22	100	360	Peak
5973.7	59.11	60.47	68.3	-9.19	36.78	7.98	46.12	100	360	Peak

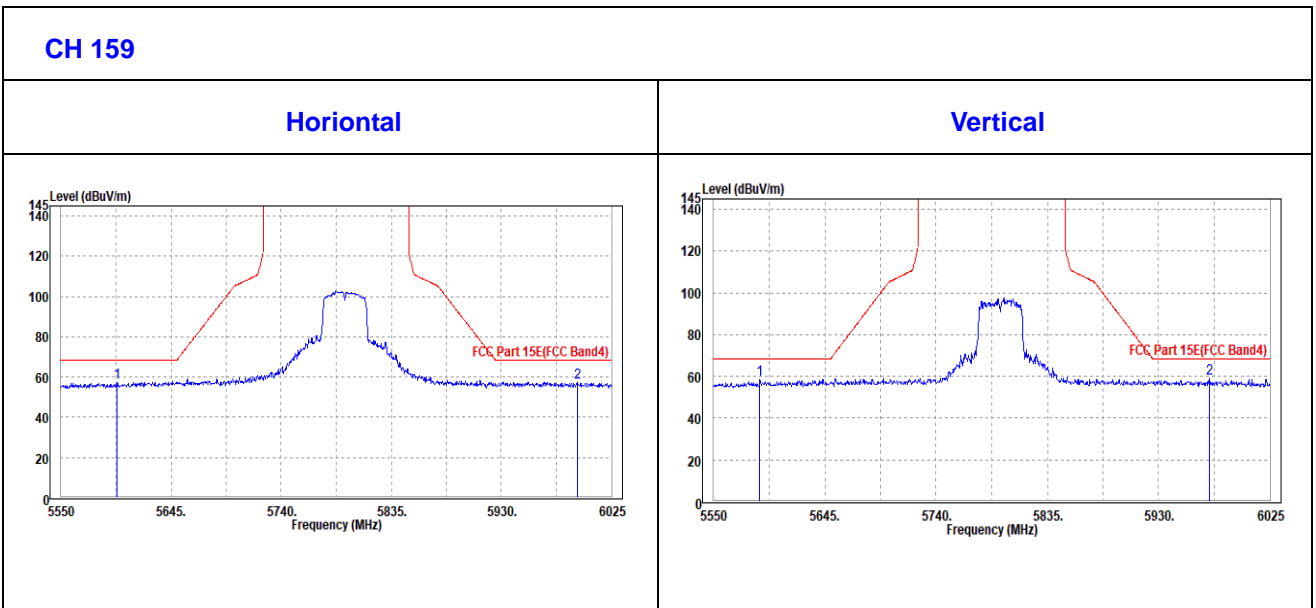



3.2 CONDUCTED EMISSION MEASUREMENT

3.2.1 LIMITS OF CONDUCTED EMISSION MEASUREMENT

FREQUENCY OF EMISSION (MHz)	CONDUCTED LIMIT (dBµV)	
	Quasi-peak	Average
0.15 ~ 0.5	66 to 56	56 to 46
0.5 ~ 5	56	46
5 ~ 30	60	50

- NOTE:**
1. The lower limit shall apply at the transition frequencies.
 2. The limit decreases in line with the logarithm of the frequency in the range of 0.15 to 0.50MHz.
 3. All emanations from a class A/B digital device or system, including any network of conductors and apparatus connected thereto, shall not exceed the level of field strengths specified above.

3.2.2 TEST INSTRUMENTS

Equipment	Manufacturer	Model No.	Serial No.	Last Cal.	Next Cal.
EMI Test Receiver	Rohde&Schwarz	ESR3	101900	Feb. 26,19	Feb. 25,20
EMC32 test software	Rohde&Schwarz	EMC32	NA	NA	NA
LISN network	Rohde&Schwarz	ENV216	101922	Feb. 26,19	Feb. 25,20

NOTE:

1. The test was performed in CE shielded room.
2. The calibration interval of the above test instruments is 12 months. And the calibrations are traceable to CEPREI/CHINA, GRGT/CHINA and NIM/CHINA.

3.2.3 TEST PROCEDURES

- a. The EUT was placed 0.4 meters from the conducting wall of the shielded room with EUT being connected to the power mains through a line impedance stabilization network (LISN). Other support units were connected to the power mains through another LISN. The two LISNs provide 50 ohm/ 50uH of coupling impedance for the measuring instrument.
- b. Both lines of the power mains connected to the EUT were checked for maximum conducted interference.
- c. The frequency range from 150kHz to 30MHz was searched. Emission levels under (Limit - 20dB) was not recorded.

NOTE: All modes of operation were investigated and the worst-case emissions are reported.



3.2.4 DEVIATION FROM TEST STANDARD

No deviation.

3.2.5 TEST SETUP

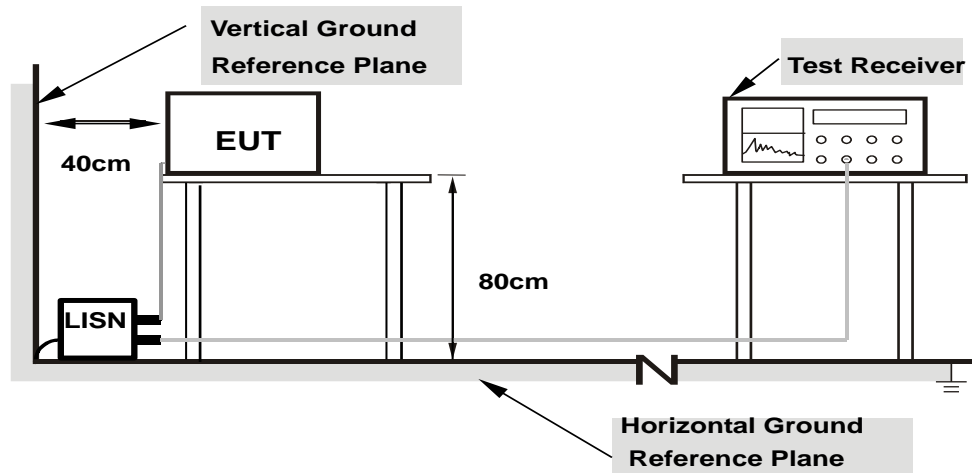

- Note: 1.Support units were connected to second LISN.
2.Both of LISNs (AMN) are 80 cm from EUT and at least 80 from other units and other metal planes**

For the actual test configuration, please refer to the attached file (Test Setup Photo).

3.2.6 EUT OPERATING CONDITIONS

Same as 3.1.7.



3.2.7 TEST RESULTS

CONDUCTED WORST-CASE DATA :

Frequency Range	150KHz ~ 30MHz	Detector Function & Resolution Bandwidth	Quasi-Peak (QP) / Average (AV), 9 kHz
Input Power	120Vac, 60Hz	Environmental Conditions	25deg. C, 52RH
Tested By	Tony		

Frequency (MHz)	QuasiPeak (dBµV)	CAverage (dBµV)	Limit (dBµV)	Margin (dB)	Line	Filter	Corr. (dB)
0.150000	---	21.17	56.00	-34.83	L	ON	9.9
0.150000	46.44	---	66.00	-19.56	L	ON	9.9
0.180000	---	28.80	54.49	-25.69	L	ON	9.9
0.180000	42.73	---	64.49	-21.76	L	ON	9.9
0.524000	---	31.13	46.00	-14.87	L	ON	10.0
0.524000	43.25	---	56.00	-12.75	L	ON	10.0
0.880000	---	28.08	46.00	-17.92	L	ON	10.1
0.880000	40.63	---	56.00	-15.37	L	ON	10.1
1.472000	---	25.65	46.00	-20.35	L	ON	10.1
1.472000	37.14	---	56.00	-18.86	L	ON	10.1
13.560000	---	40.71	50.00	-9.29	L	ON	10.5
13.560000	52.05	---	60.00	-7.95	L	ON	10.5

- REMARKS:**
1. Q.P. and AV. are abbreviations of quasi-peak and average individually.
 2. "-": The Quasi-peak reading value also meets average limit and measurement with the average detector is unnecessary.
 3. The emission levels of other frequencies were very low against the limit.
 4. Margin value = Emission level - Limit value
 5. Correction factor = Insertion loss + Cable loss
 6. Emission Level = Correction Factor + Reading Value.

Full Spectrum

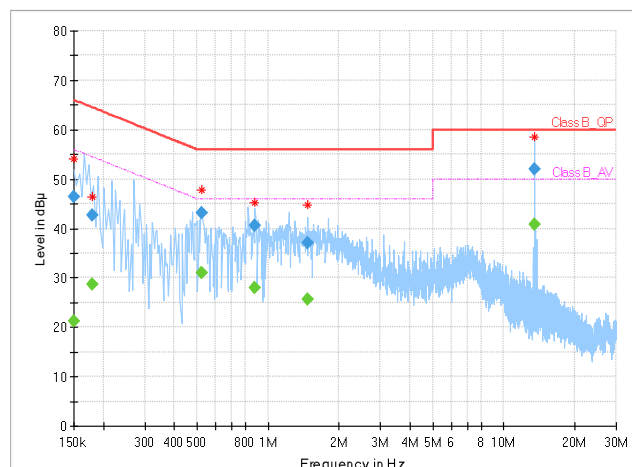



Frequency Range	150KHz ~ 30MHz	Detector Function & Resolution Bandwidth	Quasi-Peak (QP) / Average (AV), 9 kHz
Input Power	120Vac, 60Hz	Environmental Conditions	25deg. C, 52RH
Tested By	Jimmy Liu		

Frequency (MHz)	QuasiPeak (dB μ V)	CAverage (dB μ V)	Limit (dB μ V)	Margin (dB)	Line	Filter	Corr. (dB)
0.170000	---	34.18	54.96	-20.78	N	ON	9.9
0.170000	47.07	---	64.96	-17.89	N	ON	9.9
0.304000	---	18.30	50.13	-31.84	N	ON	9.9
0.304000	35.07	---	60.13	-25.06	N	ON	9.9
0.524000	---	33.19	46.00	-12.81	N	ON	9.9
0.524000	47.08	---	56.00	-8.92	N	ON	9.9
0.876000	---	30.59	46.00	-15.41	N	ON	10.0
0.876000	44.67	---	56.00	-11.33	N	ON	10.0
1.472000	---	27.16	46.00	-18.84	N	ON	10.0
1.472000	41.19	---	56.00	-14.81	N	ON	10.0
2.284000	---	25.18	46.00	-20.82	N	ON	10.0
2.284000	37.39	---	56.00	-18.61	N	ON	10.0

- REMARKS:**
1. Q.P. and AV. are abbreviations of quasi-peak and average individually.
 2. "-": The Quasi-peak reading value also meets average limit and measurement with the average detector is unnecessary.
 3. The emission levels of other frequencies were very low against the limit.
 4. Margin value = Emission level - Limit value
 5. Correction factor = Insertion loss + Cable loss
 6. Emission Level = Correction Factor + Reading Value.

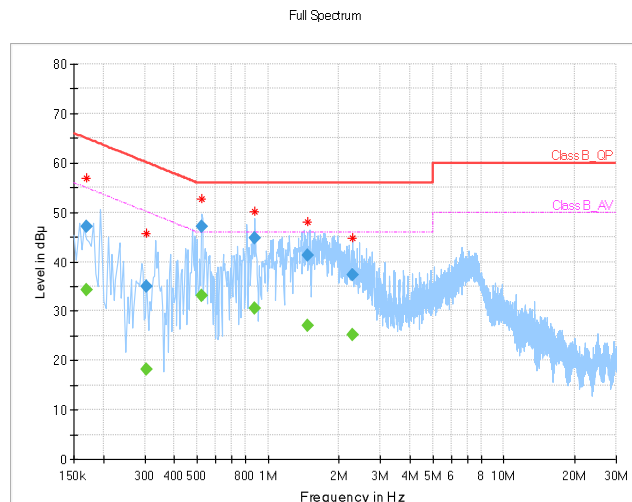



3.3 MAXIMUM CONDUCTED OUTPUT POWER MEASUREMENT

3.3.1 LIMITS OF MAXIMUM CONDUCTED OUTPUT POWER MEASUREMENT

Operation Band	EUT Category		LIMIT
U-NII-1		Outdoor Access Point	1 Watt (30 dBm) (Max. e.i.r.p ≤ 125mW(21 dBm) at any elevation angle above 30 degrees as measured from the horizon)
		Fixed point-to-point Access Point	1 Watt (30 dBm)
		Indoor Access Point	1 Watt (30 dBm)
	√	Client devices	250mW (24 dBm)
U-NII-2A	√		250mW (24 dBm) or 11 dBm+10 log B*
U-NII-2C	√		250mW (24 dBm) or 11 dBm+10 log B*
U-NII-3	√		1 Watt (30 dBm)

NOTE: Where B is the 26dB emission bandwidth in MHz.



3.3.2 TEST SETUP

FOR POWER OUTPUT MEASUREMENT

802.11a, 802.11n (20MHz), 802.11n (40MHz) TEST CONFIGURATION

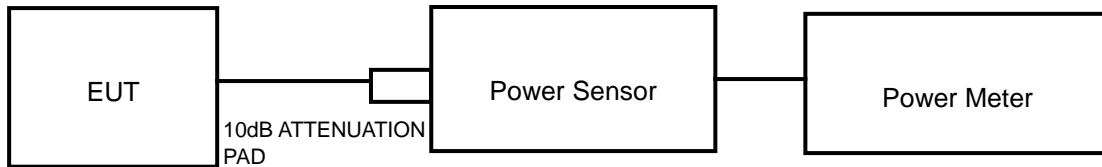

11ac TEST CONFIGURATION

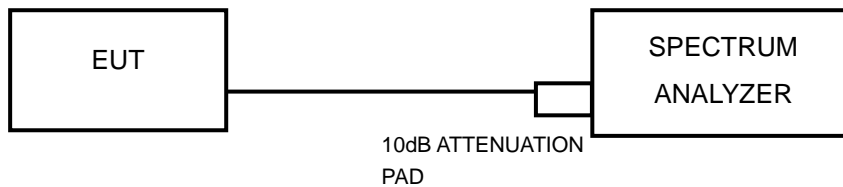

FOR 26dB BANDWIDTH



3.3.3 TEST INSTRUMENTS

Equipment	Manufacturer	Model No.	Serial No.	Last Cal.	Next Cal.
Power Meter	ANRITSU	ML2495A	1506002	Feb. 26,19	Feb. 25,20
EXA Signal Analyzer	KEYSIGHT	N9010A-526	MY54510322	Feb. 26,19	Feb. 25,20
EXA Signal Analyzer	KEYSIGHT	N9010A-544	MY54510355	Feb. 26,19	Feb. 25,20
Power Sensor	ANRITSU	MA2411B	1339352	Feb. 26,19	Feb. 25,20

NOTE:

1. The calibration interval of the above test instruments is 12 months and the calibrations are traceable to CEPREI/CHINA, GRGT/CHINA and NIM/CHINA.
2. The test was performed in RF Oven room.



3.3.4 TEST PROCEDURE

FOR POWER MEASUREMENT

For 802.11a, 802.11n (20MHz), 802.11n (40MHz)

Method PM is used to perform output power measurement, trigger and gating function of wide band power meter is enabled to measure max output power of TX on burst. Duty factor is not added to measured value.



FOR 99 PERCENT OCCUPIED BANDWIDTH

The following procedure shall be used for measuring (99 %) power bandwidth:

1. Set center frequency to the nominal EUT channel center frequency.
2. Set span = 1.5 times to 5.0 times the OBW.
3. Set RBW = 1 % to 5 % of the OBW
4. Set VBW $\geq 3 \cdot$ RBW
5. Video averaging is not permitted. Where practical, a sample detection and single sweep mode shall be used. Otherwise, peak detection and max hold mode (until the trace stabilizes) shall be used.
6. Use the 99 % power bandwidth function of the instrument (if available).
7. If the instrument does not have a 99 % power bandwidth function, the trace data points are recovered and directly summed in power units. The recovered amplitude data points, beginning at the lowest frequency, are placed in a running sum until 0.5 % of the total is reached; that frequency is recorded as the lower frequency. The process is repeated until 99.5 % of the total is reached; that frequency is recorded as the upper frequency. The 99% occupied bandwidth is the difference between these two frequencies.

FOR 26dB BANDWIDTH

- 1) Set RBW = approximately 1% of the emission bandwidth.
- 2) Set the VBW > RBW.
- 3) Detector = Peak.
- 4) Trace mode = max hold.
- 5) Measure the maximum width of the emission that is 26 dB down from the peak of the emission. Compare this with the RBW setting of the analyzer. Readjust RBW and repeat measurement as needed until the RBW/EBW ratio is approximately 1%.

FOR 6dB BANDWIDTH

1. Set RBW = 100 kHz.
2. Set the video bandwidth (VBW) ≥ 3 RBW.
3. Detector = Peak.
4. Trace mode = max hold.
5. Sweep = auto couple.
6. Allow the trace to stabilize.
7. Measure the maximum width of the emission that is constrained by the frequencies associated with the two outermost amplitude points (upper and lower frequencies) that are attenuated by 6 dB relative to the maximum level measured in the fundamental emission.



Test Report No.: RF190926W003-3

3.3.5 DEVIATION FROM TEST STANDARD

No deviation.

3.3.6 EUT OPERATING CONDITIONS

The software provided by client to enable the EUT under transmission condition continuously at specific channel frequencies individually.



3.3.7 TEST RESULTS

OUTPUT POWER:

802.11a

CHANNEL	CHANNEL FREQUENCY (MHz)	AVERAGE POWER (dBm)	Duty Factor	FINAL AVERAGE POWER (dBm)	FINAL AVERAGE POWER (mW)	POWER LIMIT (dBm)	PASS/FAIL
36	5180	14.06	0.09	14.15	26.01	24	PASS
40	5200	14.02	0.09	14.11	25.77	24	PASS
48	5240	14.26	0.09	14.35	27.23	24	PASS
52	5260	14.13	0.09	14.22	26.43	24	PASS
60	5300	14.16	0.09	14.25	26.61	24	PASS
64	5320	14.09	0.09	14.18	26.19	24	PASS
100	5500	14.42	0.09	14.51	28.26	24	PASS
116	5580	14.18	0.09	14.27	26.74	24	PASS
140	5700	14.34	0.09	14.43	27.74	24	PASS
149	5745	14.14	0.09	14.23	26.49	30	PASS
157	5785	13.91	0.09	14.00	25.12	30	PASS
161	5805	14.16	0.09	14.25	26.61	30	PASS



802.11n (20MHz)

CHANNEL	CHANNEL FREQUENCY (MHz)	AVERAGE POWER (dBm)	Duty Factor	FINAL AVERAGE POWER (dBm)	FINAL AVERAGE POWER (mW)	POWER LIMIT (dBm)	PASS/FAIL
36	5180	13.10	0.10	13.20	20.91	24	PASS
40	5200	13.05	0.10	13.15	20.67	24	PASS
48	5240	13.23	0.10	13.33	21.54	24	PASS
52	5260	13.26	0.10	13.36	21.69	24	PASS
60	5300	13.29	0.10	13.39	21.84	24	PASS
64	5320	13.23	0.10	13.33	21.54	24	PASS
100	5500	13.07	0.10	13.17	20.76	24	PASS
116	5580	13.12	0.10	13.22	21.00	24	PASS
140	5700	13.42	0.10	13.52	22.51	24	PASS
149	5745	13.07	0.10	13.17	20.76	30	PASS
157	5785	13.26	0.10	13.36	21.69	30	PASS
161	5805	13.06	0.10	13.16	20.72	30	PASS



802.11n (40MHz)

CHANNEL	CHANNEL FREQUENCY (MHz)	AVERAGE POWER (dBm)	Duty Factor	FINAL AVERAGE POWER (dBm)	FINAL AVERAGE POWER (mW)	POWER LIMIT (dBm)	PASS/FAIL
38	5190	13.13	0.18	13.31	21.45	24	PASS
46	5230	13.27	0.18	13.45	22.15	24	PASS
54	5270	13.19	0.18	13.37	21.75	24	PASS
62	5310	12.94	0.18	13.12	20.53	24	PASS
102	5510	11.53	0.18	11.71	14.84	24	PASS
110	5550	13.11	0.18	13.29	21.35	24	PASS
134	5670	13.00	0.18	13.18	20.82	24	PASS
151	5755	13.28	0.18	13.46	22.20	30	PASS
159	5798	13.06	0.18	13.24	21.11	30	PASS



99% OCCUPIED BANDWIDTH & 26dB BANDWIDTH/6dB BANDWIDTH DATA FROM:

802.11a

CHANNEL	CHANNEL FREQUENCY (MHz)	99% OCCUPIED BANDWIDTH	26dB BANDWIDTH (MHz)	PASS/FAIL
36	5180	16.74	22.82	PASS
40	5200	16.68	22.76	PASS
48	5240	17.10	25.70	PASS
52	5260	16.92	27.91	PASS
60	5300	17.34	30.50	PASS
64	5320	18.18	32.11	PASS
100	5500	19.98	36.68	PASS
116	5580	17.52	32.96	PASS
140	5700	17.88	33.66	PASS
CHANNEL	CHANNEL FREQUENCY	99% OCCUPIED BANDWIDTH	6dB BANDWIDTH	PASS/FAIL
149	5745	18.48	15.52	PASS
157	5785	20.04	15.15	PASS
161	5805	19.38	16.66	PASS



802.11n (20MHz)

CHANNEL	CHANNEL FREQUENCY (MHz)	99% OCCUPIED BANDWIDTH	26dB BANDWIDTH (MHz)	PASS/FAIL
36	5180	17.70	20.09	PASS
40	5200	17.64	22.22	PASS
48	5240	17.76	22.18	PASS
52	5260	17.76	25.28	PASS
60	5300	17.94	29.24	PASS
64	5320	17.94	31.43	PASS
100	5500	19.32	34.39	PASS
116	5580	17.88	30.07	PASS
140	5700	18.00	31.90	PASS
CHANNEL	CHANNEL FREQUENCY	99% OCCUPIED BANDWIDTH	6dB BANDWIDTH	PASS/FAIL
149	5745	18.18	15.34	PASS
157	5785	21.72	16.15	PASS
161	5805	19.02	16.30	PASS



802.11n (40MHz)

CHANNEL	CHANNEL FREQUENCY (MHz)	99% OCCUPIED BANDWIDTH	26dB BANDWIDTH (MHz)	PASS/FAIL
38	5190	36.30	56.01	PASS
46	5230	36.36	55.73	PASS
54	5270	36.30	65.67	PASS
62	5310	36.24	71.32	PASS
102	5510	36.24	66.63	PASS
110	5550	36.66	68.06	PASS
134	5670	36.36	68.22	PASS
CHANNEL	CHANNEL FREQUENCY	99% OCCUPIED BANDWIDTH	6dB BANDWIDTH	PASS/FAIL
151	5755	36.72	34.72	PASS
159	5795	36.84	35.33	PASS



BUREAU VERITAS

Test Report No.: RF190926W003-3

For U-NII-1:

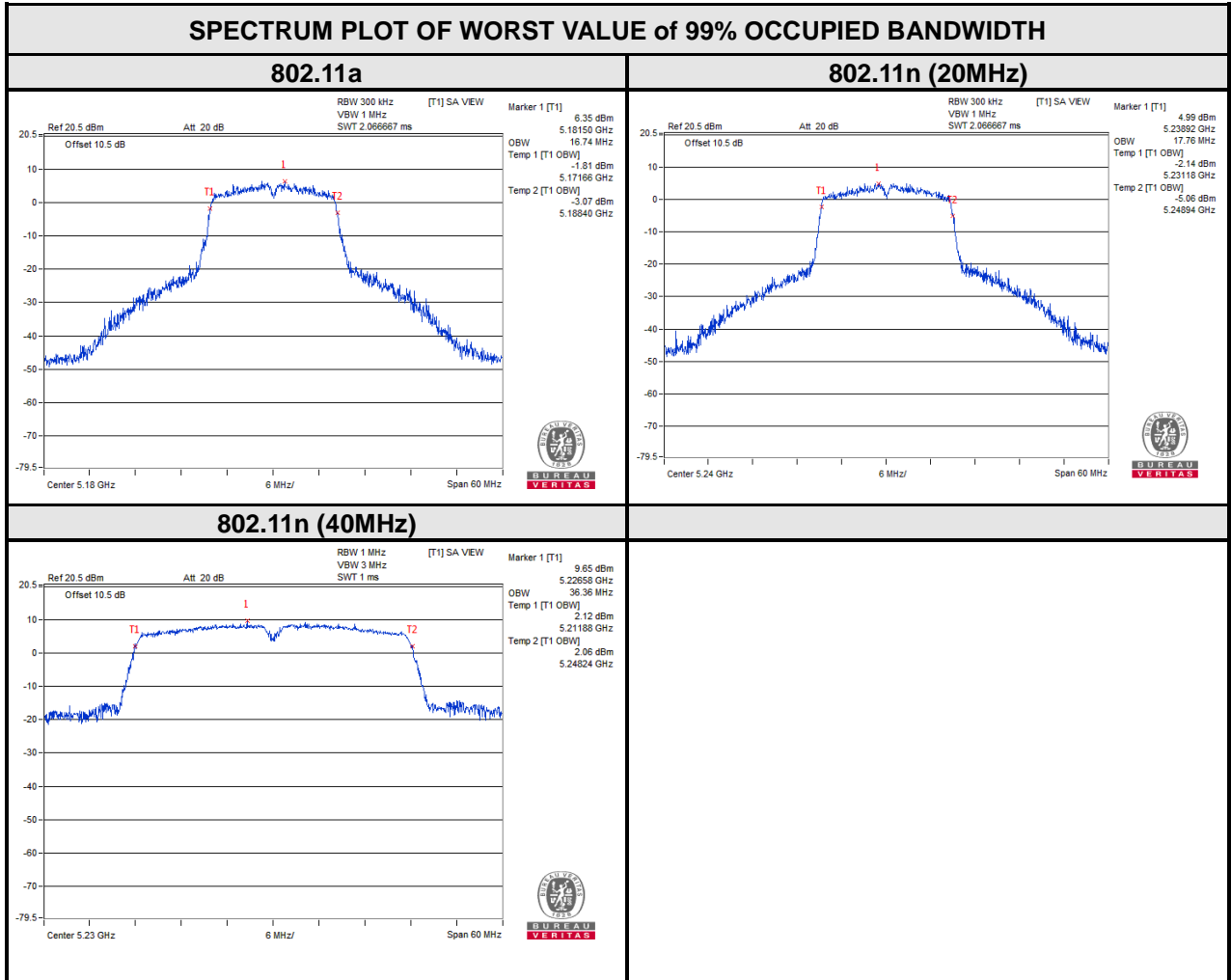

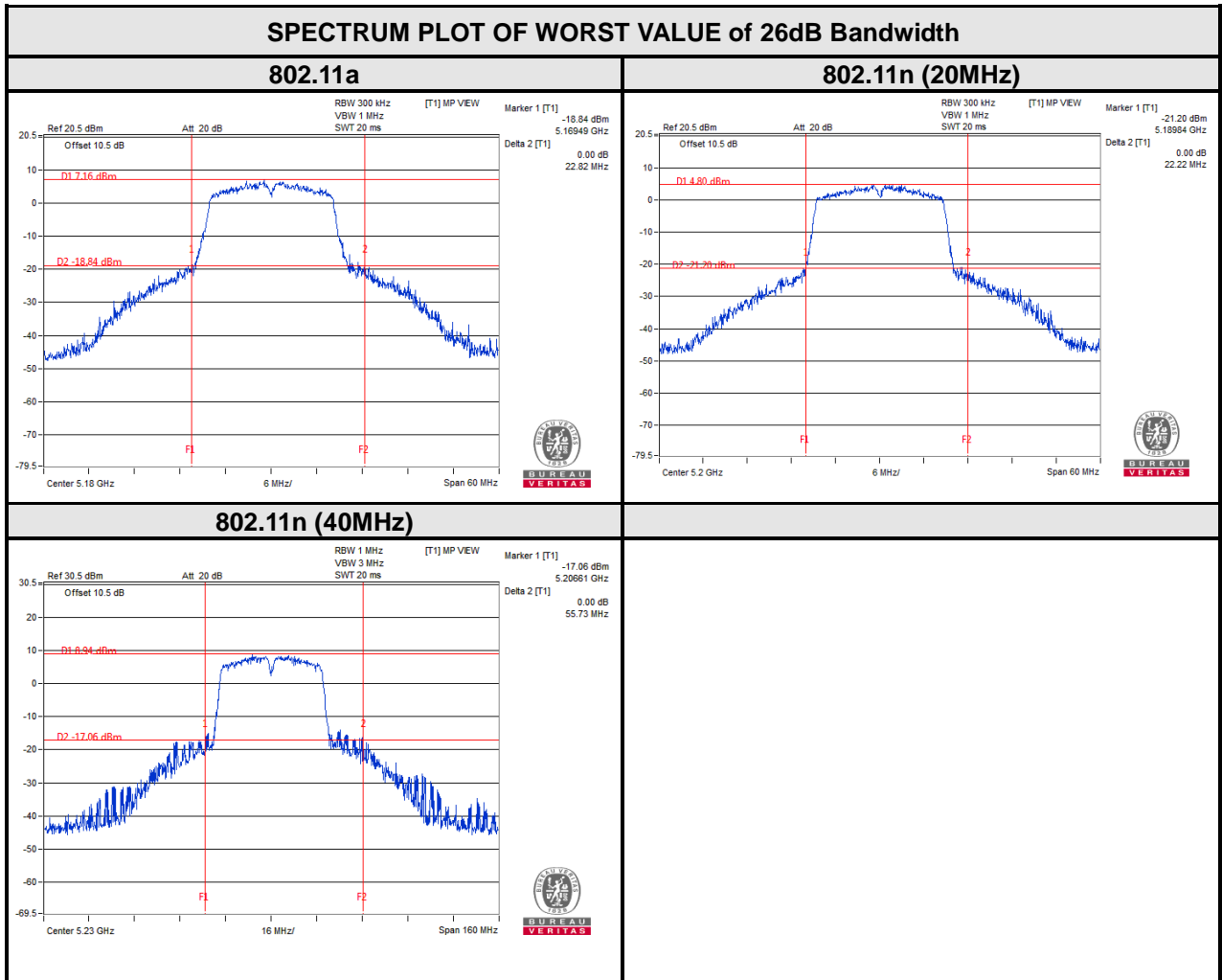



BUREAU VERITAS

Test Report No.: RF190926W003-3

For U-NII-2A:

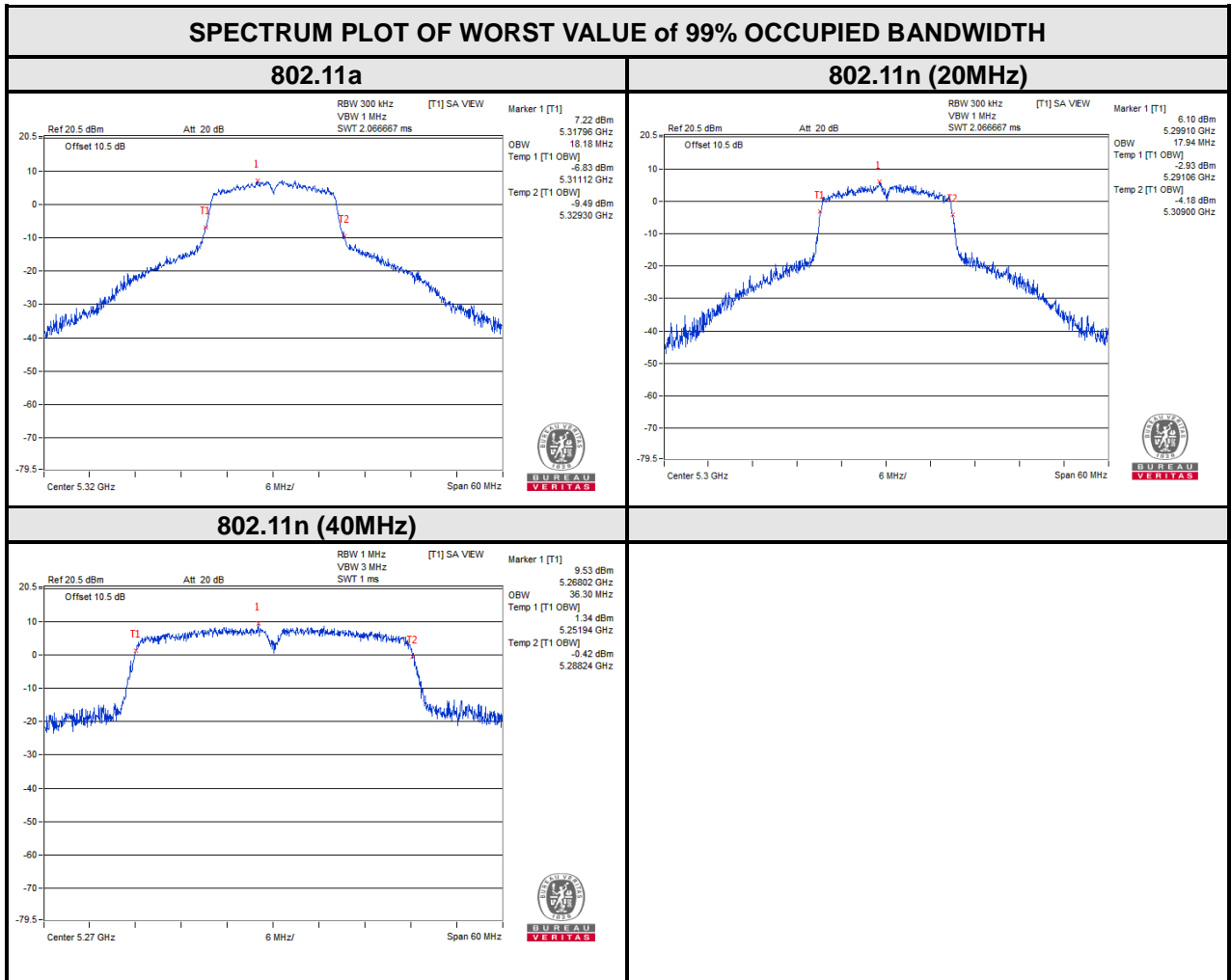



BUREAU VERITAS

Test Report No.: RF190926W003-3

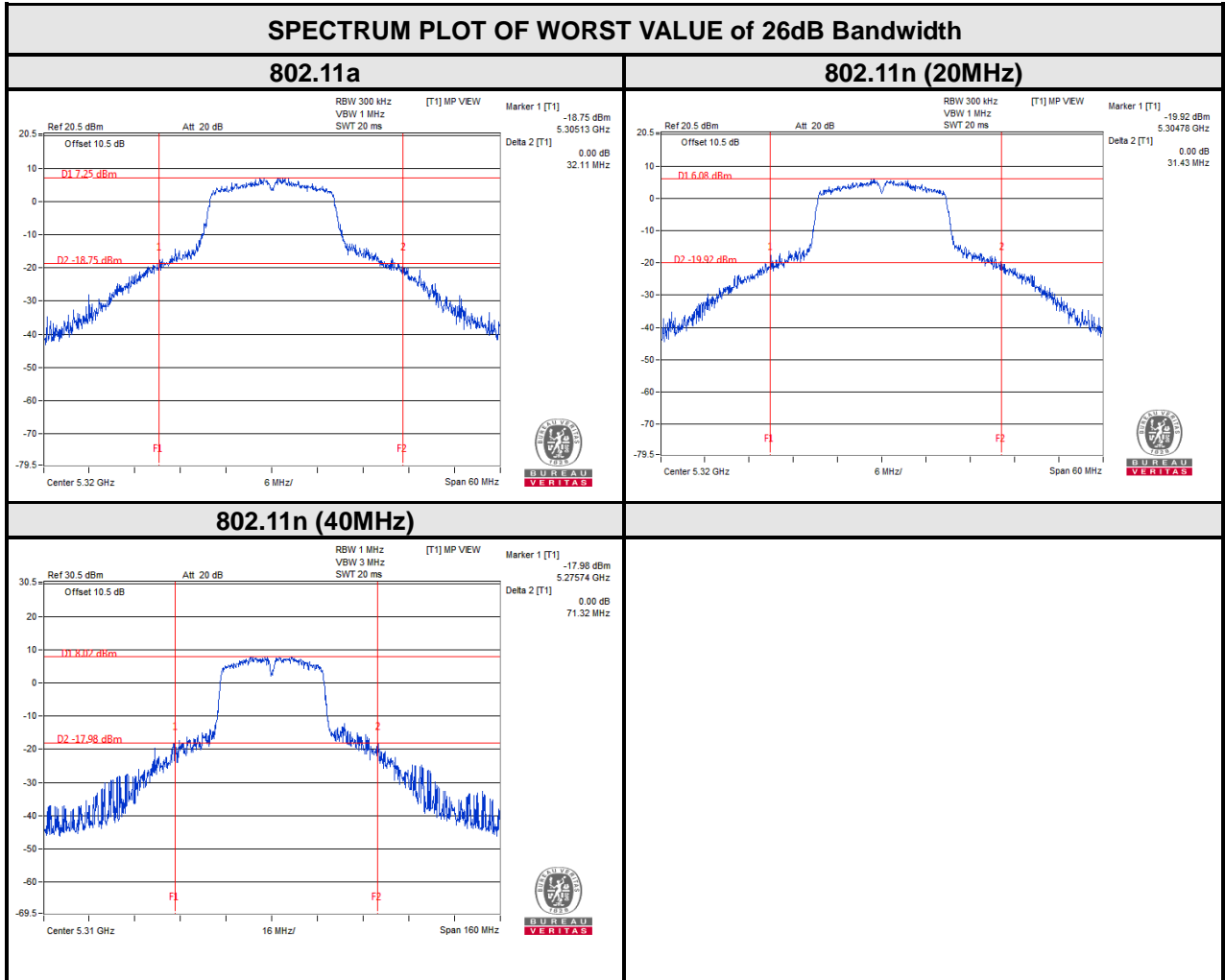



**BUREAU
VERITAS**

Test Report No.: RF190926W003-3

For U-NII-2C:

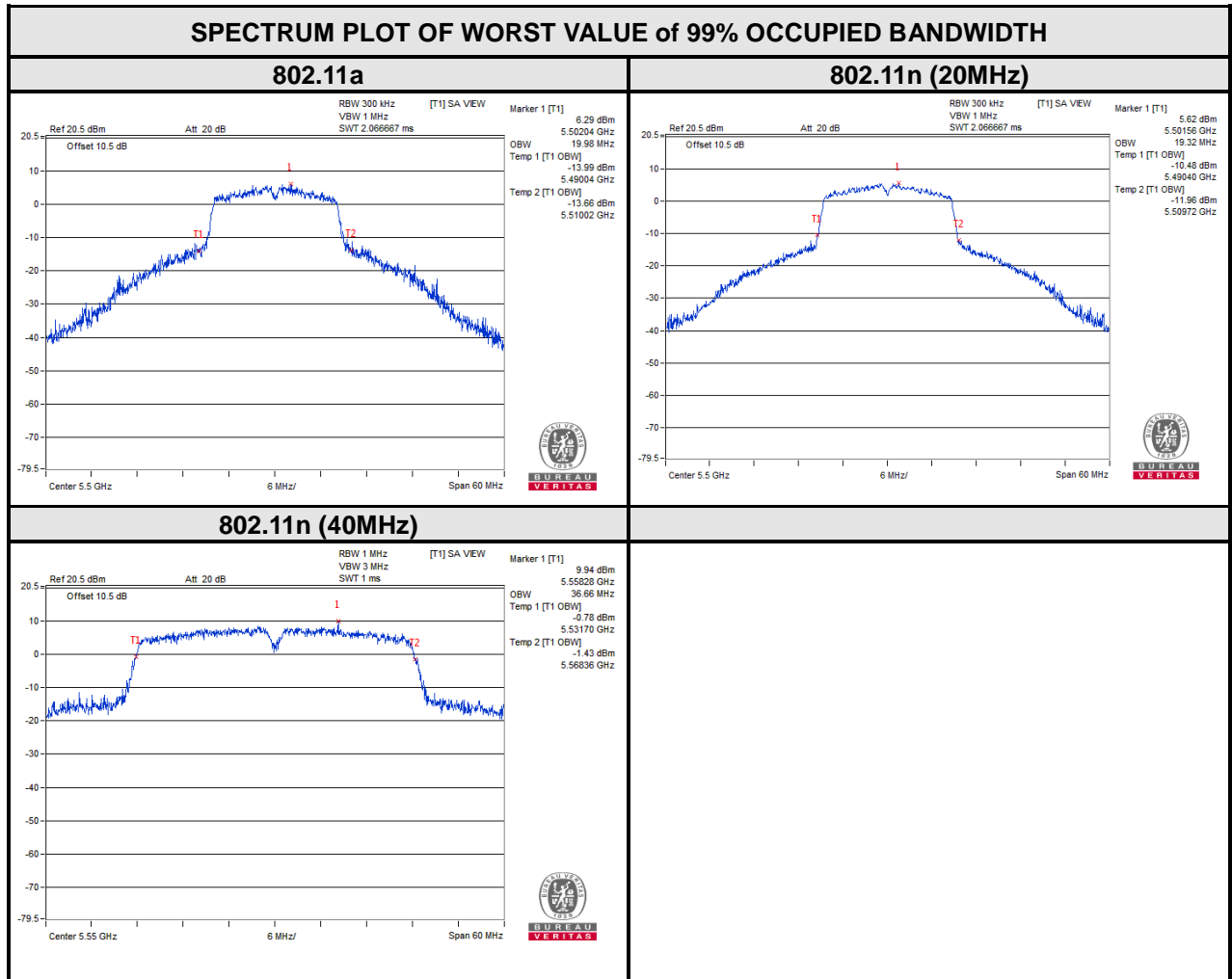

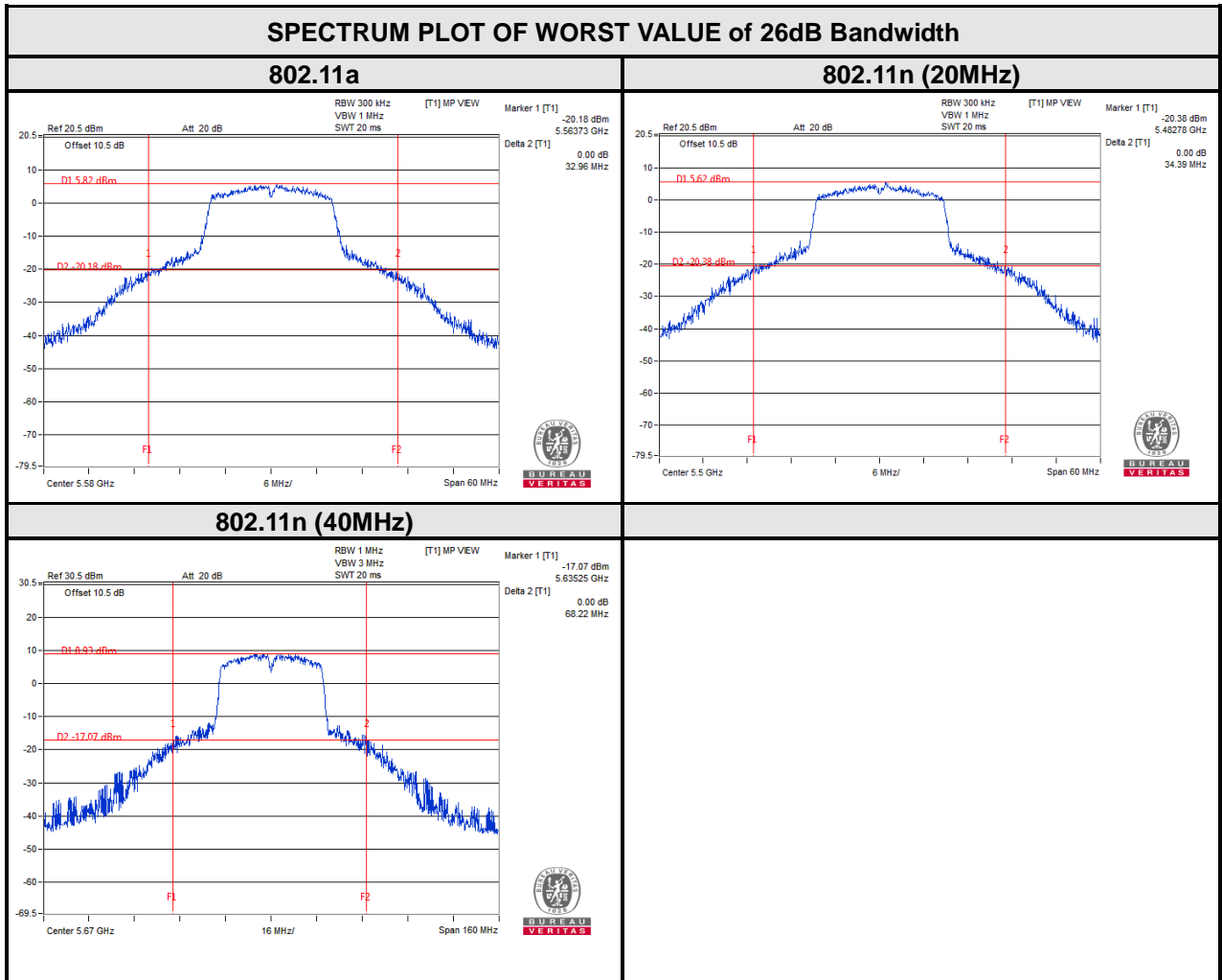



**BUREAU
VERITAS**

Test Report No.: RF190926W003-3

For U-NII-3:

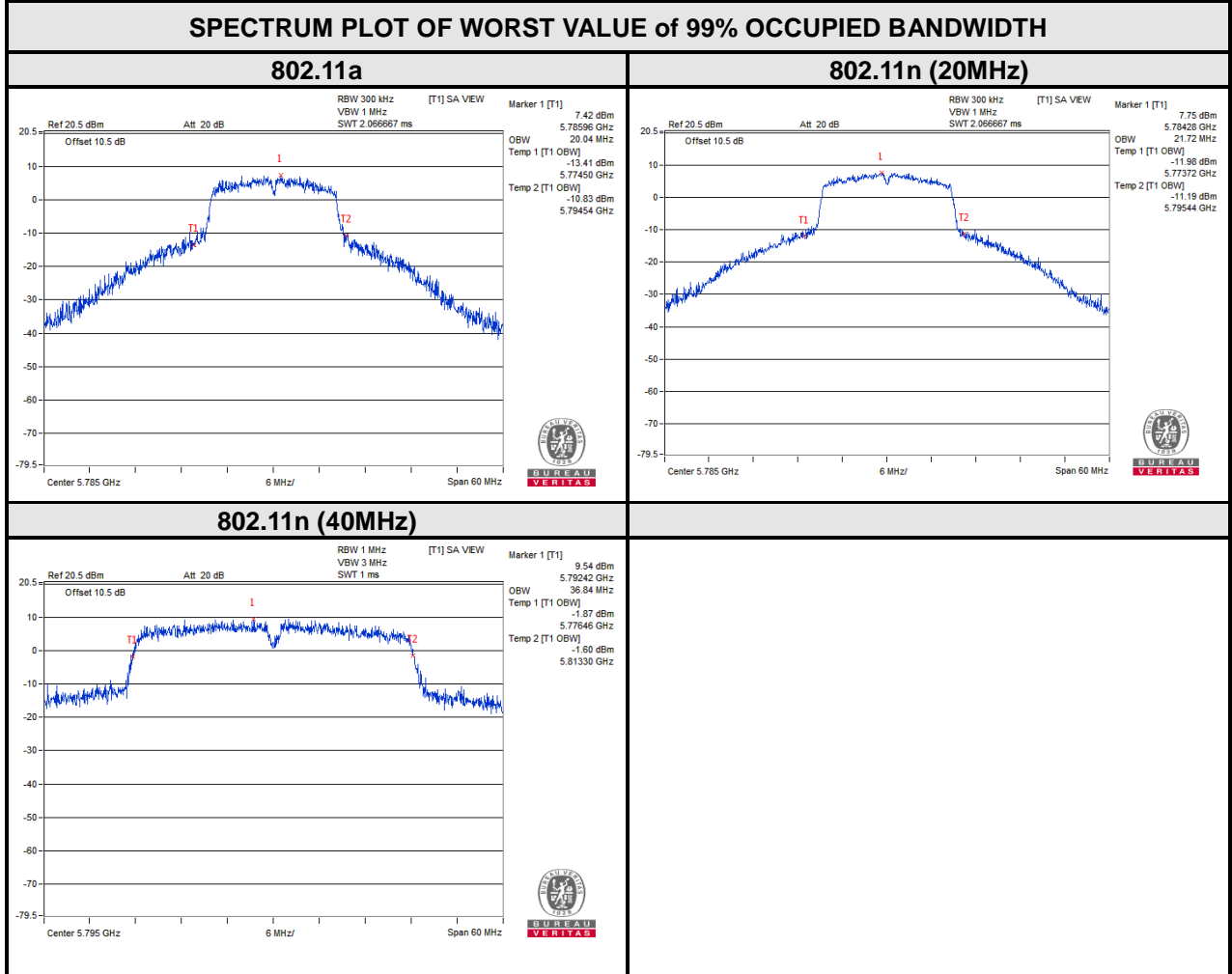



BUREAU VERITAS

Test Report No.: RF190926W003-3

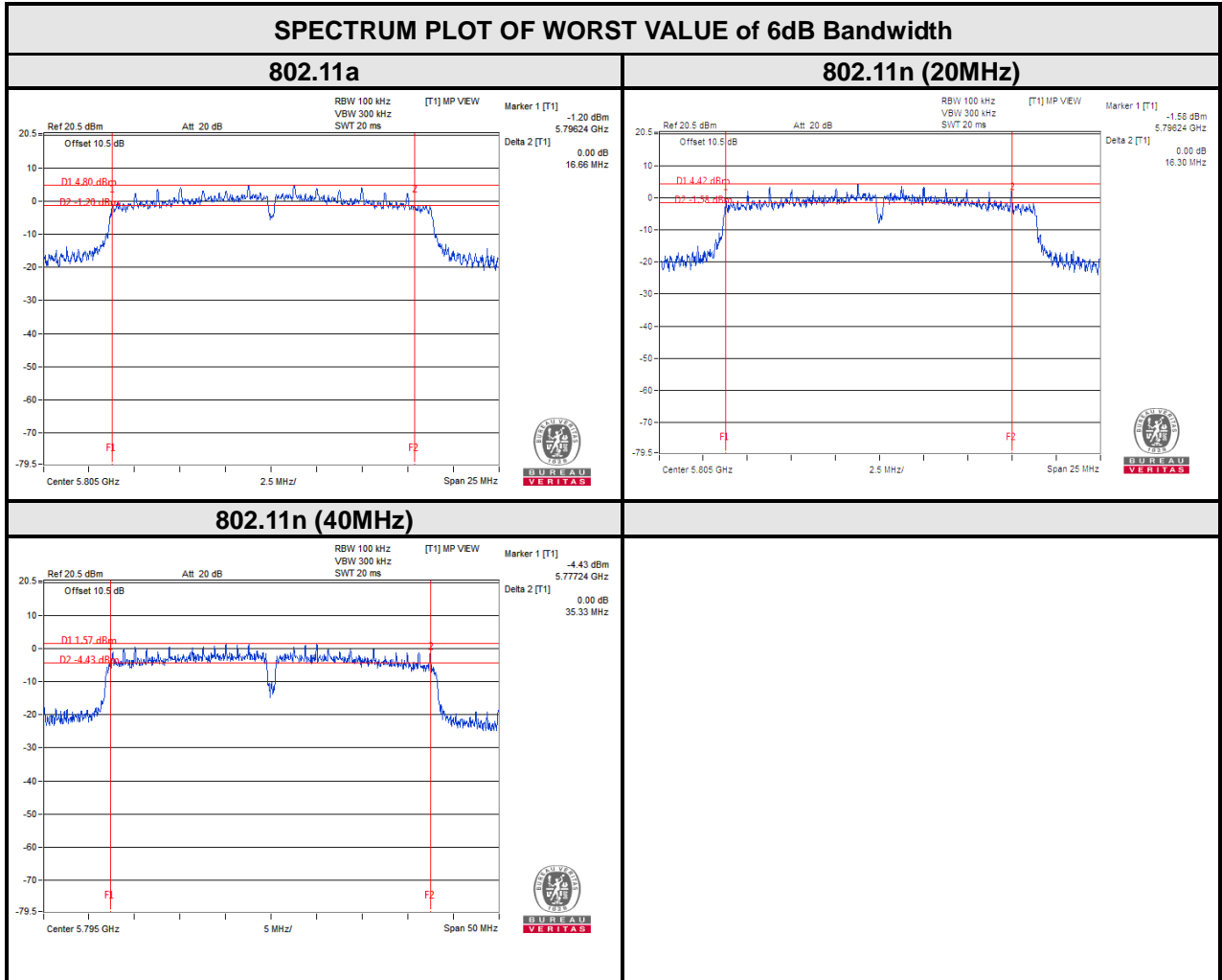



3.4 MAXIMUM POWER SPECTRAL DENSITY MEASUREMENT

3.4.1 LIMITS OF MAXIMUM POWER SPECTRAL DENSITY MEASUREMENT

Operation Band	EUT Category		LIMIT
U-NII-1		Outdoor Access Point	17dBm/ MHz
		Fixed point-to-point Access Point	
		Indoor Access Point	
	√	Client devices	11dBm/ MHz
U-NII-2A		√	11dBm/ MHz
U-NII-2C		√	11dBm/ MHz
U-NII-3		√	30dBm/ 500kHz

3.4.2 TEST SETUP

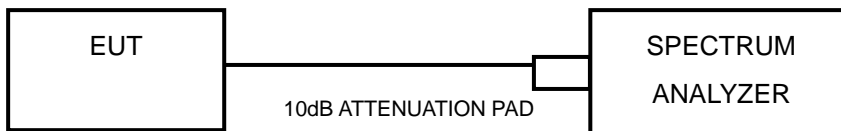

3.4.3 TEST INSTRUMENTS

Refer to section 3.3.3 to get information of above instrument.



3.4.4 TEST PROCEDURES

Using method SA-2

- 1) Set span to encompass the entire emission bandwidth (EBW) of the signal.
- 2) Set RBW = 1 MHz, Set VBW \geq 3 MHz, Detector = RMS
- 3) Set Channel power measure = 1MHz
- 4) Sweep time = auto, trigger set to "free run".
- 5) Trace average at least 100 traces in power averaging mode.
- 6) Add $10 \log(1/x)$, where x is the duty cycle, to the measured power in order to compute the average power during the actual transmission times (because the measurement represents an average over both the on and off times of the transmission).
- 7) Record the max value

3.4.5 DEVIATION FROM TEST STANDARD

No deviation.

3.4.6 EUT OPERATING CONDITIONS

Same as 3.1.6.



3.4.7 TEST RESULTS

For U-NII-1 & U-NII-2A& U-NII-2C:

802.11a

CHANNEL	FREQUENCY (MHz)	PSD w/o Duty Factor (dBm/MHz)	Duty Factor	PSD with Duty Factor (dBm/MHz)	MAXIMUM LIMIT (dBm/MHz)	PASS/FAIL
36	5180	8.33	0.09	8.42	11	PASS
40	5200	8.32	0.09	8.41	11	PASS
48	5240	8.92	0.09	9.01	11	PASS
52	5260	8.72	0.09	8.81	11	PASS
60	5300	9.47	0.09	9.56	11	PASS
64	5320	9.15	0.09	9.24	11	PASS
100	5500	8.83	0.09	8.92	11	PASS
116	5580	8.03	0.09	8.12	11	PASS
140	5700	8.85	0.09	8.94	11	PASS

802.11n (20MHz)

CHANNEL	FREQUENCY (MHz)	PSD w/o Duty Factor (dBm/MHz)	Duty Factor	PSD with Duty Factor (dBm/MHz)	MAXIMUM LIMIT (dBm/MHz)	PASS/FAIL
36	5180	6.94	0.10	7.04	11	PASS
40	5200	7.45	0.10	7.55	11	PASS
48	5240	8.05	0.10	8.15	11	PASS
52	5260	7.68	0.10	7.78	11	PASS
60	5300	8.80	0.10	8.9	11	PASS
64	5320	7.63	0.10	7.73	11	PASS
100	5500	7.50	0.10	7.6	11	PASS
116	5580	6.67	0.10	6.77	11	PASS
140	5700	7.23	0.10	7.33	11	PASS



802.11n (40MHz)

CHANNEL	FREQUENCY (MHz)	PSD w/o Duty Factor (dBm/MHz)	Duty Factor	PSD with Duty Factor (dBm/MHz)	MAXIMUM LIMIT (dBm/MHz)	PASS/FAIL
38	5190	-0.98	0.18	-0.8	11	PASS
46	5230	-0.42	0.18	-0.24	11	PASS
54	5270	-0.45	0.18	-0.27	11	PASS
62	5310	-0.94	0.18	-0.76	11	PASS
102	5510	-2.58	0.18	-2.4	11	PASS
110	5550	-0.41	0.18	-0.23	11	PASS
134	5670	-0.14	0.18	0.04	11	PASS



For U-NII-3:

802.11a

CHANNEL	FREQUENCY (MHz)	PSD w/o Duty Factor (dBm/500kHz)	Duty Factor	PSD with Duty Factor (dBm/500kHz)	LIMIT (dBm/500kHz)	PASS /FAIL
149	5745	1.83	0.09	1.92	30	PASS
157	5785	2.46	0.09	2.55	30	PASS
161	5805	2.65	0.09	2.74	30	PASS

802.11n (20MHz)

CHANNEL	FREQUENCY (MHz)	PSD w/o Duty Factor (dBm/500kHz)	Duty Factor	PSD with Duty Factor (dBm/500kHz)	LIMIT (dBm/500kHz)	PASS /FAIL
149	5745	0.70	0.10	0.8	30	PASS
157	5785	1.82	0.10	1.92	30	PASS
161	5805	1.47	0.10	1.57	30	PASS

802.11n (40MHz)

CHANNEL	FREQUENCY (MHz)	PSD w/o Duty Factor (dBm/500kHz)	Duty Factor	PSD with Duty Factor (dBm/500kHz)	LIMIT (dBm/500kHz)	PASS /FAIL
151	5755	-3.10	0.18	-2.92	30	PASS
159	5795	-3.84	0.18	-3.66	30	PASS



BUREAU VERITAS

Test Report No.: RF190926W003-3

For 5180~5240MHz

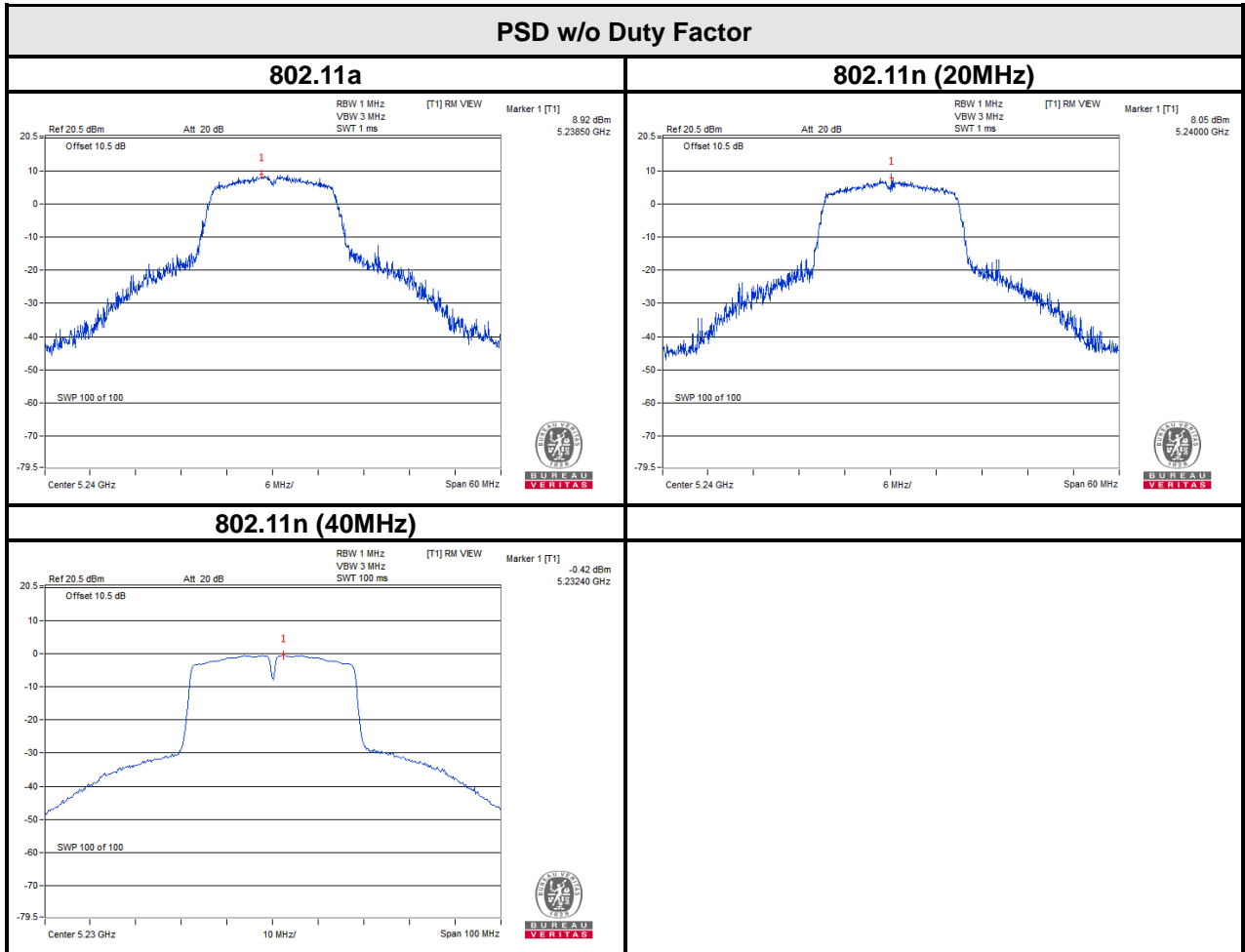



BUREAU VERITAS

Test Report No.: RF190926W003-3

For 5260~5320MHz

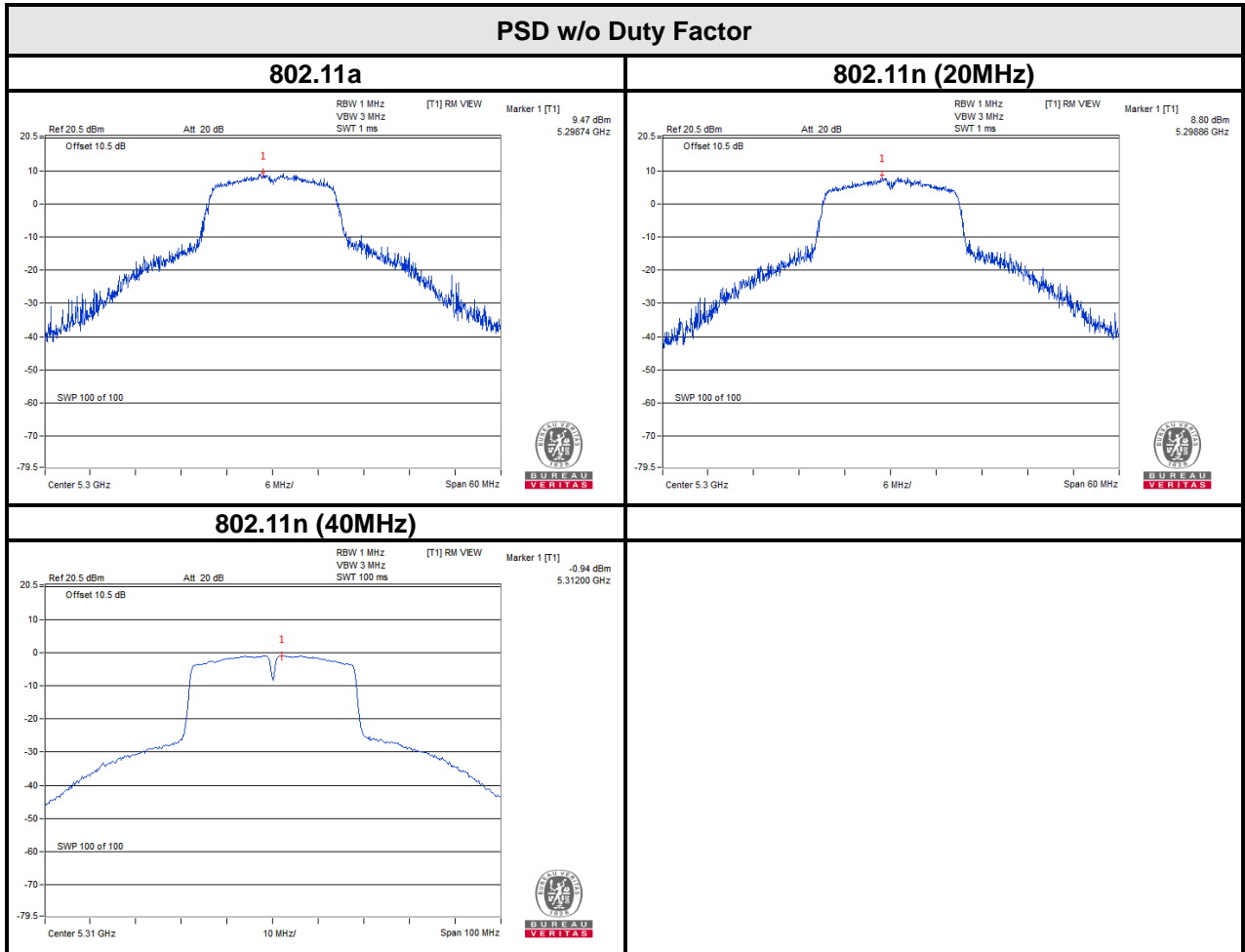



BUREAU VERITAS

Test Report No.: RF190926W003-3

For 5470 ~ 5725MHz

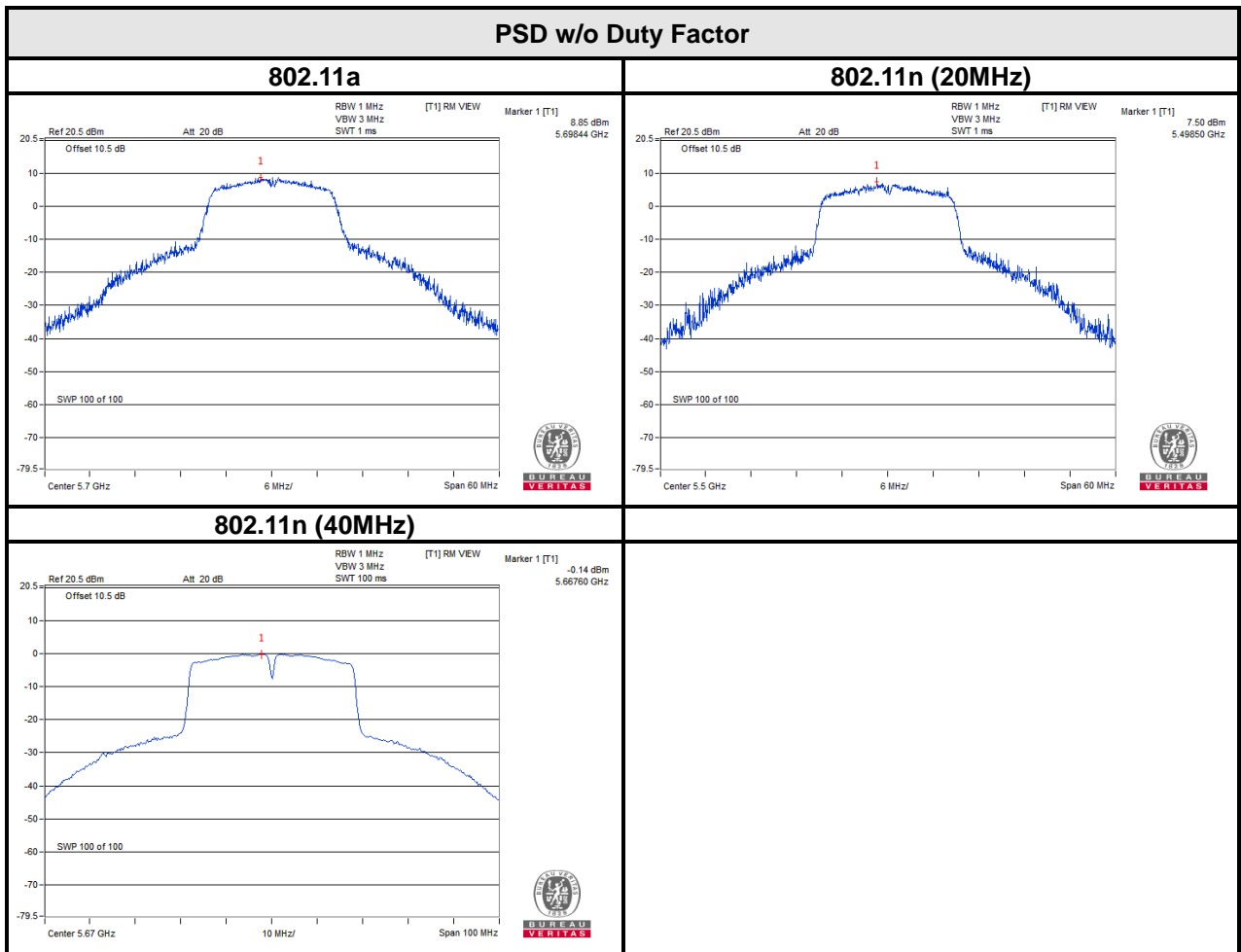



BUREAU VERITAS

Test Report No.: RF190926W003-3

For 5745~5805MHz

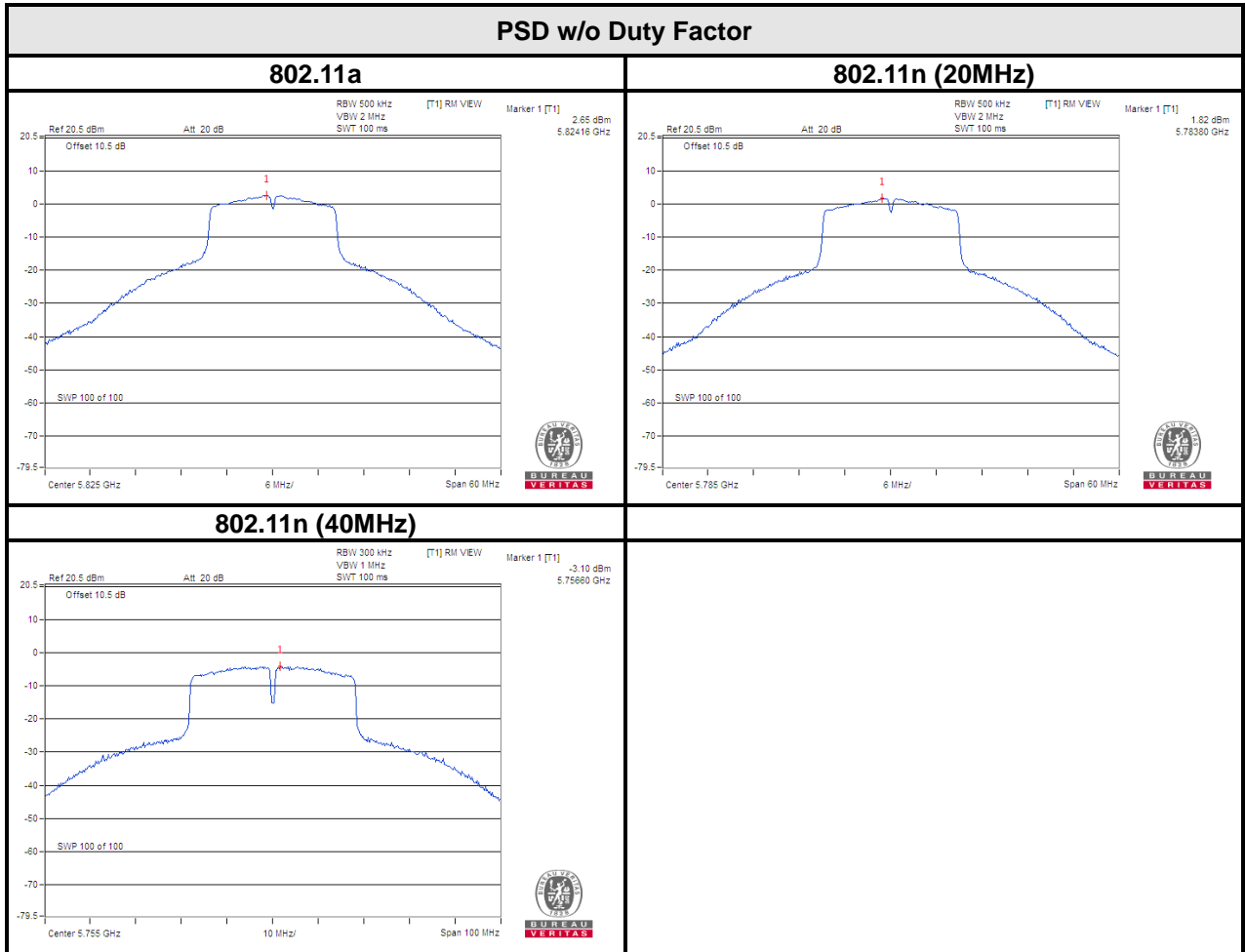



Test Report No.: RF190926W003-3

4 PHOTOGRAPHS OF THE TEST CONFIGURATION

Please refer to the attached file (Test Setup Photo).



Test Report No.: RF190926W003-3

5 APPENDIX A – MODIFICATIONS RECORDERS FOR ENGINEERING CHANGES TO THE EUT BY THE LAB

No modifications were made to the EUT by the lab during the test.

---END---