



BUREAU
VERITAS

Test Report No.: RF180822N038



TEST REPORT

| | |
|-----------|--|
| Applicant | Icon Health & Fitness |
| Address | 1500 South 1000 West 435-786-5915 Logan, UT 84321, United States |

| | |
|-------------------------------------|--|
| Manufacturer or Supplier | Icon Health & Fitness |
| Address | 1500 South 1000 West 435-786-5915 Logan, UT 84321, United States |
| Product Name | 402546 module |
| Brand Name | N/A |
| Model | MP7-ARGON |
| Additional Model & Model Difference | N/A |
| FCC ID | OMC402546 |
| Date of tests | Aug. 22, 2018 ~ Sep. 04, 2018 |

the tests have been carried out according to the requirements of the following standard:

- FCC Part 15, Subpart E, Section 15.407**
FCC 06-96
KDB 905462 D03 UNII Clients Without Radar Detection New Rules v01r02

CONCLUSION: The submitted sample was found to COMPLY with the test requirement



| | |
|--|--|
| Tested by Robert Cheng Project Engineer / EMC Department | Approved by Chris Chen Manager / EMC Department |
|  |  |
| Date: Sep. 21, 2018 | |
| <p>This report is governed by, and incorporates by reference, CPS Conditions of Service as posted at the date of issuance of this report at http://www.bureauveritas.com/home/about-us/our-business/cps/about-us/terms-conditions/ and is intended for your exclusive use. Any copying or replication of this report to or for any other person or entity, or use of our name or trademark, is permitted only with our prior written permission. This report sets forth our findings solely with respect to the test samples identified herein. The results set forth in this report are not indicative or representative of the quality or characteristics of the lot from which a test sample was taken or any similar or identical product unless specifically and expressly noted. Our report includes all of the tests requested by you and the results thereof based upon the information that you provided to us. Measurement uncertainty is only provided upon request for accredited tests. You have 60 days from date of issuance of this report to notify us of any material error or omission caused by our negligence or if you require measurement uncertainty; provided, however, that such notice shall be in writing and shall specifically address the issue you wish to raise. A failure to raise such issue within the prescribed time shall constitute your unqualified acceptance of the completeness of this report, the tests conducted and the correctness of the report contents.</p> | |



TABLE OF CONTENTS

RELEASE CONTROL RECORD 4

1 EUT INFORMATION..... 5

1.1 OPERATING FREQUENCY BANDS AND MODE OF EUT 5

1.2 EUT SOFTWARE AND FIRMWARE VERSION 5

1.3 DESCRIPTION OF AVAILABLE ANTENNAS TO THE EUT 5

1.4 TRANSMIT POWER CONTROL (TPC) 6

1.5 STATEMENT OF MAUNFACTURER 6

2 U-NII DFS RULE REQUIREMENTS 7

2.1 WORKING MODES AND REQUIRED TEST ITEMS 7

2.2 TEST LIMITS AND RADAR SIGNAL PARAMETERS 8

3 TEST & SUPPORT EQUIPMENT LIST11

3.1 TEST INSTRUMENTS11

3.2 DESCRIPTION OF SUPPORT UNITS.....11

4 TEST PROCEDURE..... 12

4.1 BVADT DFS MEASUREMENT SYSTEM:..... 12

4.2 CALIBRATION OF DFS DETECTION THRESHOLD LEVEL: 13

4.3 DEVIATION FROM TEST STANDARD 14

4.4 CONDUCTED TEST SETUP CONFIGURATION 14

4.4.1 CLIENT WITHOUT RADAR DETECTION MODE 14

5 TEST RESULTS 15

5.1 SUMMARY OF TEST RESULTS..... 15

5.2 DETAILED TEST RESULTS 15

5.2.1 TEST MODE: DEVICE OPERATING IN CLIENT WITHOUT RADAR DETECTION MODE15

5.2.2 DFS DETECTION THRESHOLD..... 16

5.2.3 CHANNEL LOADING..... 17

5.2.4 CHANNEL CLOSING TRANSMISSION AND CHANNEL MOVE TIME 18

5.2.5 NON- OCCUPANCY PERIOD 19

5.2.6 NON-ASSOCIATED TEST 21

5.2.7 NON- CO-CHANNEL TEST 21



**BUREAU
VERITAS**

Test Report No.: RF180822N038

**6 APPENDIX A - MODIFICATIONS RECORDERS FOR ENGINEERING CHANGES TO THE
EUT BY THE LAB..... 22**



**BUREAU
VERITAS**

Test Report No.: RF180822N038

RELEASE CONTROL RECORD

| ISSUE NO. | REASON FOR CHANGE | DATE ISSUED |
|--------------|-------------------|---------------|
| RF180822N038 | Original release. | Sep. 21, 2018 |



1 EUT INFORMATION

1.1 OPERATING FREQUENCY BANDS AND MODE OF EUT

TABLE 1: OPERATING FREQUENCY BANDS AND MODE OF EUT

| OPERATIONAL MODE | OPERATING FREQUENCY RANGE | |
|--|---------------------------|--------------|
| | 5250~5350MHz | 5470~5725MHz |
| Client without radar detection and ad hoc function | V | V |

1.2 EUT SOFTWARE AND FIRMWARE VERSION

TABLE 2: THE EUT SOFTWARE/FIRMWARE VERSION

| NO. | PRODUCT | MODEL NO. | SOFTWARE/FIRMWARE VERSION |
|-----|---------------|-----------|-------------------------------|
| 1 | 402546 module | MP7-ARGON | Model number J1002/A184C V2.0 |

1.3 DESCRIPTION OF AVAILABLE ANTENNAS TO THE EUT

TABLE 3: ANTENNA LIST

| ANT. | BRAND | MODEL | CONNECTOR TYPE | ANT TYPE | FREQUENCY RANGE (MHZ TO MHZ) | NET GAIN(dBi) | CABLE LOSS(dBi) |
|------|-------|-------|----------------|----------|------------------------------|---------------|-----------------|
| 1 | N/A | N/A | N/A | PIFA | 5250 - 5350 | 3.3 | 0 |
| | | | | | 5470 - 5725 | 4.05 | 0 |



1.4 TRANSMIT POWER CONTROL (TPC)

U-NII devices operating in the 5.25-5.35 GHz band and the 5.47-5.725 GHz band shall employ a TPC mechanism. The U-NII device is required to have the capability to operate at least 6 dB below the mean EIRP value of 30 dBm. A TPC mechanism is not required for systems with an EIRP of less than 500 mW.

Maximum EIRP of this device is less than 500mW which less than 500mW, therefore it's not require TPC function.

1.5 STATEMENT OF MAUNFACTURER

This device (Client) is without radar detection, then the manufacturer statement confirming that information regarding the parameters of the detected Radar Waveforms is not available to the end user. And the device doesn't have Ad Hoc mode on DFS frequency band.



2 U-NII DFS RULE REQUIREMENTS

2.1 WORKING MODES AND REQUIRED TEST ITEMS

The manufacturer shall state whether the UUT is capable of operating as a Master and/or a Client. If the UUT is capable of operating in more than one operating mode then each operating mode shall be tested separately. See tables 1 and 2 for the applicability of DFS requirements for each of the operational modes.

TABLE 6: APPLICABILITY OF DFS REQUIREMENTS PRIOR TO USE A CHANNEL

| REQUIREMENT | OPERATIONAL MODE | | |
|---------------------------------|------------------|--------------------------------|-----------------------------|
| | MASTER | CLIENT WITHOUT RADAR DETECTION | CLIENT WITH RADAR DETECTION |
| Non-Occupancy Period | ✓ | ✓ | ✓ |
| DFS Detection Threshold | ✓ | Not required | ✓ |
| Channel Availability Check Time | ✓ | Not required | Not required |
| Uniform Spreading | ✓ | Not required | Not required |
| U-NII Detection Bandwidth | ✓ | Not required | ✓ |

TABLE 7: APPLICABILITY OF DFS REQUIREMENTS DURING NORMAL OPERATION

| REQUIREMENT | OPERATIONAL MODE | | |
|-----------------------------------|------------------|--------------------------------|-----------------------------|
| | MASTER | CLIENT WITHOUT RADAR DETECTION | CLIENT WITH RADAR DETECTION |
| DFS Detection Threshold | ✓ | Not required | ✓ |
| Channel Closing Transmission Time | ✓ | ✓ | ✓ |
| Channel Move Time | ✓ | ✓ | ✓ |
| U-NII Detection Bandwidth | ✓ | Not required | ✓ |



2.2 TEST LIMITS AND RADAR SIGNAL PARAMETERS

DETECTION THRESHOLD VALUES

TABLE 8: DFS DETECTION THRESHOLDS FOR MASTER DEVICES AND CLIENT DEVICES WITH RADAR DETECTION

| MAXIMUM TRANSMIT POWER | VALUE (SEE Note 1 and 2) |
|------------------------|--------------------------|
| ≥ 200 milliwatt | -64 dBm |
| < 200 milliwatt | -62 dBm |

Note 1: This is the level at the input of the receiver assuming a 0 dBi receive antenna.

Note 2: Throughout these test procedures an additional 1 dB has been added to the amplitude of the test transmission waveforms to account for variations in measurement equipment. This will ensure that the test signal is at or above the detection threshold level to trigger a DFS response.

TABLE 9: DFS RESPONSE REQUIREMENT VALUES

| PARAMETER | VALUE |
|-----------------------------------|---|
| Non-occupancy period | Minimum 30 minutes |
| Channel Availability Check Time | 60 seconds |
| Channel Move Time | 10 seconds See Note 1. |
| Channel Closing Transmission Time | 200 milliseconds + an aggregate of 60 milliseconds over remaining 10 second period. See Notes 1 and 2. |
| U-NII Detection Bandwidth | 100% of the UNII transmission power bandwidth. See Note 3. |

Note 1: The instant that the Channel Move Time and the Channel Closing Transmission Time begins is as follows:

- For the Short Pulse Radar Test Signals this instant is the end of the Burst.
- For the Frequency Hopping radar Test Signal, this instant is the end of the last radar Burst generated.
- For the Long Pulse Radar Test Signal this instant is the end of the 12 second period defining the Radar Waveform.

Note 2: The Channel Closing Transmission Time is comprised of 200 milliseconds starting at the beginning of the Channel Move Time plus any additional intermittent control signals required to facilitate a Channel move (an aggregate of 60 milliseconds) during the remainder of the 10 second period. The aggregate duration of control signals will not count quiet periods in between transmissions.

Note 3: During the U-NII Detection Bandwidth detection test, radar type 1 is used and for each frequency step the minimum percentage of detection is 90 percent. Measurements are performed with no data traffic.



PARAMETERS OF DFS TEST SIGNALS

Step intervals of 0.1 microsecond for Pulse Width, 1 microsecond for PRI, 1 MHz for chirp width and 1 for the number of pulses will be utilized for the random determination of specific test waveforms.

Table 10: Short Pulse Radar Test Waveforms

| Radar Type | Pulse Width (μsec) | PRI (μsec) | Number of Pulses | Minimum Percentage of Successful Detection | Minimum Number of Trials |
|--|---------------------------|---|--|---|---------------------------------|
| 0 | 1 | 1428 | 18 | See Note 1 | See Note 1 |
| 1 | 1 | Test A: 15 unique PRI values randomly selected from the list of 23 PRI values in Table 5a ----- Test B: 15 unique PRI values randomly selected within the range of 518-3066 μsec, with a minimum increment of 1 μsec, excluding PRI values selected in Test A | $\text{Roundup} \left\{ \begin{array}{l} \left(\frac{1}{360} \right) \cdot \\ \left(\frac{19 \cdot 10^6}{\text{PRI}_{\mu\text{sec}}} \right) \end{array} \right\}$ | 60% | 30 |
| 2 | 1-5 | 150-230 | 23-29 | 60% | 30 |
| 3 | 6-10 | 200-500 | 16-18 | 60% | 30 |
| 4 | 11-20 | 200-500 | 12-16 | 60% | 30 |
| Aggregate (Radar Types 1-4) | | | | 80% | 120 |
| Note 1: Short Pulse Radar Type 0 should be used for the detection bandwidth test, channel move time, and channel closing time tests. | | | | | |



TABLE 11: LONG PULSE RADAR TEST WAVEFORM

| RADAR TYPE | PULSE WIDTH (μsec) | CHIRP WIDTH (MHz) | PRI (μsec) | NUMBER OF PULSES PER BURST | NUMBER OF BURSTS | MINIMUM PERCENTAGE OF SUCCESSFUL DETECTION | MINIMUM NUMBER OF TRIALS |
|------------|--------------------|-------------------|------------|----------------------------|------------------|--|--------------------------|
| 5 | 50-100 | 5-20 | 1000-2000 | 1-3 | 8-20 | 80% | 30 |

TABLE 12: FREQUENCY HOPPING RADAR TEST WAVEFORM

| RADAR TYPE | PULSE WIDTH (μsec) | PRI (μsec) | PULSES PER HOP | HOPPING RATE (kHz) | HOPPING SEQUENCE LENGTH (msec) | MINIMUM PERCENTAGE OF SUCCESSFUL DETECTION | MINIMUM NUMBER OF TRIALS |
|------------|--------------------|------------|----------------|--------------------|--------------------------------|--|--------------------------|
| 6 | 1 | 333 | 9 | 0.333 | 300 | 70% | 30 |



3 TEST & SUPPORT EQUIPMENT LIST

3.1 TEST INSTRUMENTS

TABLE 1: TEST INSTRUMENTS LIST.

| DESCRIPTION & MANUFACTURER | MODEL NO. | BRAND | CALIBRATED DATE | CALIBRATED UNTIL |
|----------------------------------|-----------|------------|-----------------|------------------|
| Spectrum Analyzer | N9020A | MY55400499 | Mar. 21,18 | Mar. 20,19 |
| R&S Spectrum | FSV7 | R&S | Nov 25, 17 | Nov. 24, 18 |
| MXG-B RF Vector Signal Generator | N5182B | MY56200288 | Jan. 02,18 | Jan. 01,19 |
| Signal generator | 8645A | Agilent | Sep.01, 18 | Aug. 31, 19 |

3.2 DESCRIPTION OF SUPPORT UNITS

TABLE 2: SUPPORT UNIT INFORMATION.

| NO. | PRODUCT | BRAND | MODEL NO. | ID | SOFTWARE/FIRMMWARE VERSION |
|-----|-----------------|-------|------------|-----|----------------------------|
| 1 | wireless router | ASUS | RT-AC1200G | N/A | 3.0.0.1.380_5001 |

NOTE: This device was functioned as a Master Slave device during the DFS test.



4 TEST PROCEDURE

4.1 BVADT DFS MEASUREMENT SYSTEM:

A complete DFS Measurement System consists of Radar signal generate system to generating the radar waveforms in Table 10, 11 and 12. The traffic monitoring system is specified to the type of unit under test (UUT).

Conducted setup configuration of DFS Measurement System

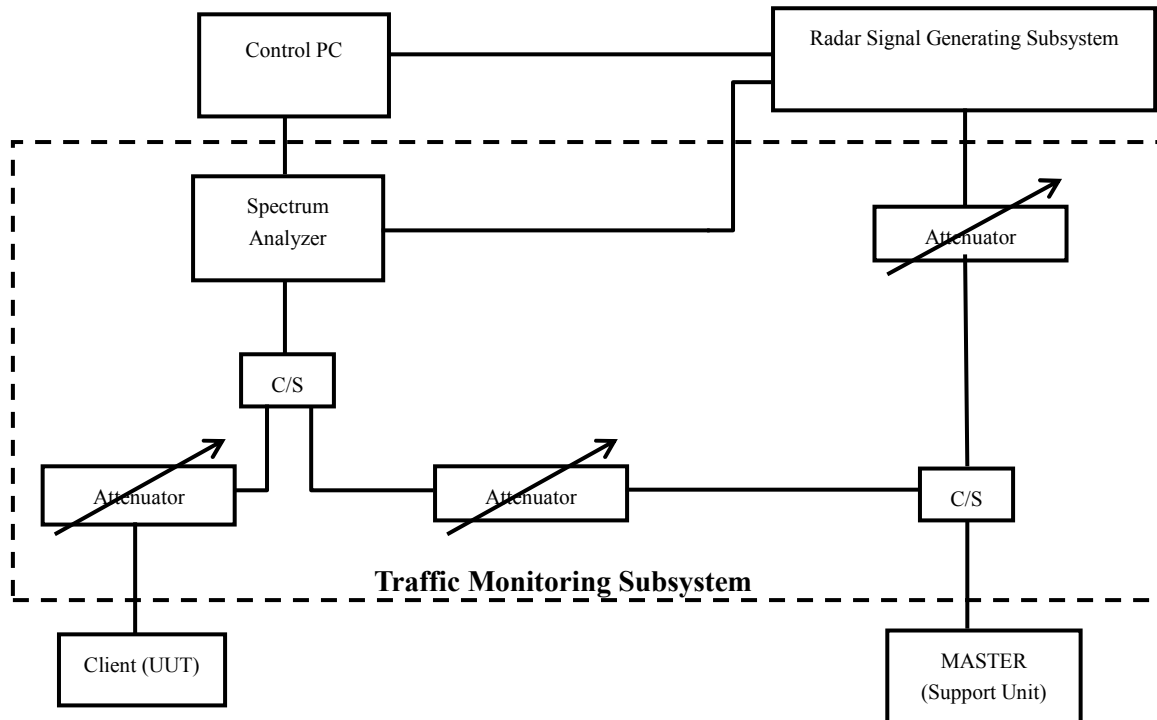

Channel Loading

System testing will be performed with channel-loading using means appropriate to the data types that are used by the unlicensed device. The following requirements apply:

| | | |
|----|---|---|
| a) | The data file must be of a type that is typical for the device (i.e., MPEG-2, MPEG-4, WAV, MP3, MP4, AVI, etc.) and must generally be transmitting in a streaming mode. | |
| b) | Software to ping the client is permitted to simulate data transfer but must have random ping intervals. | |
| c) | Timing plots are required with calculations demonstrating a minimum channel loading of approximately 17% or greater. | ✓ |
| d) | Unicast or Multicast protocols are preferable but other protocols may be used. The appropriate protocol used must be described in the test procedures. | |



4.2 CALIBRATION OF DFS DETECTION THRESHOLD LEVEL:

The measured channel is 5300MHz and 5500 MHz in 20MHz Bandwidth, 5310MHz and 5510MHz in 40MHz Bandwidth. The radar signal was the same as transmitted channels, and injected into the antenna port of AP (master) or Client Device with Radar Detection, measured the channel closing transmission time and channel move time. The Master maximum transmit power was more than 200mW. The Master antenna gain is 3dBi and required detection threshold is -61dBm ($=-64+3$)dBm.

Conducted setup configuration of calibration of DFS detection threshold level:

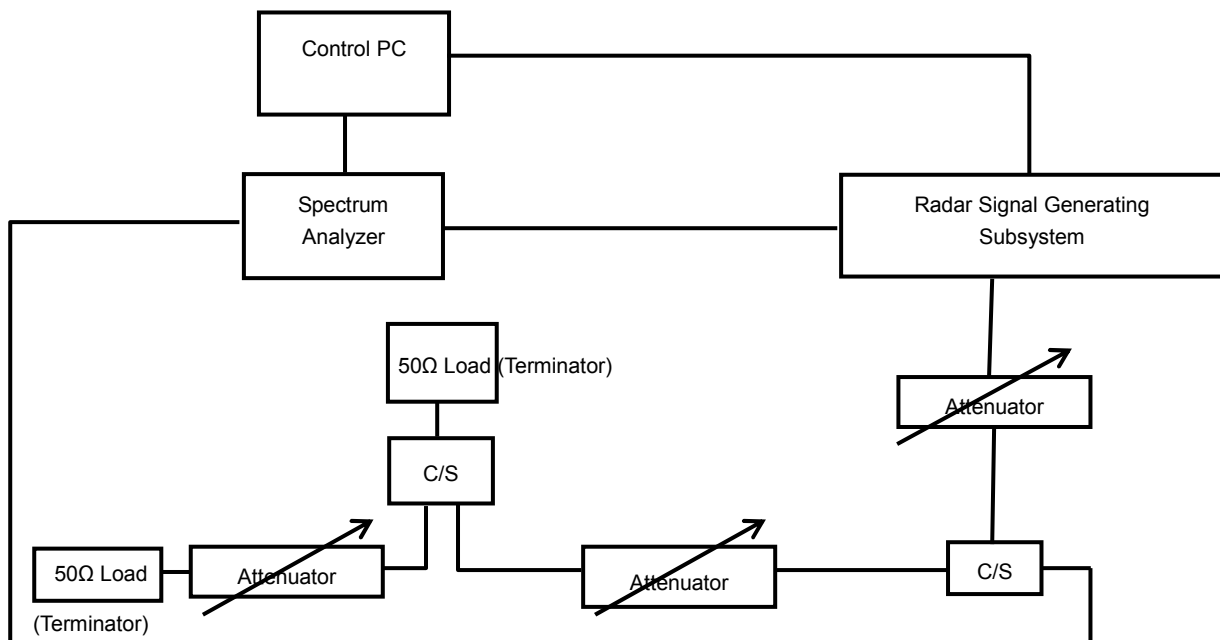



4.3 DEVIATION FROM TEST STANDARD

No deviation.

4.4 CONDUCTED TEST SETUP CONFIGURATION

4.4.1 CLIENT WITHOUT RADAR DETECTION MODE

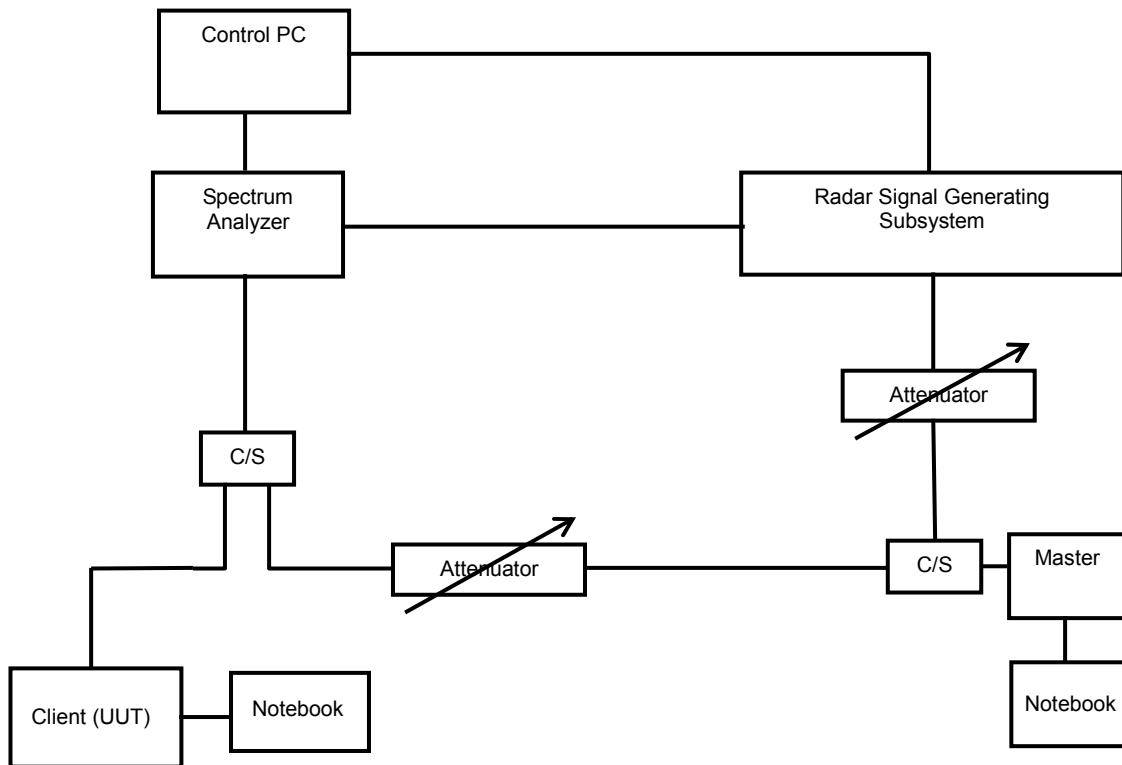

The UUT is a U-NII Device operating in Client mode without radar detection. The radar test signals are injected into the Master Device.



5 TEST RESULTS

5.1 SUMMARY OF TEST RESULTS

| CLAUSE | TEST PARAMETER | REMARKS | PASS/FAIL |
|--------|-----------------------------------|----------------|-----------|
| 15.407 | DFS Detection Threshold | Not Applicable | N/A |
| 15.407 | Channel Availability Check Time | Not Applicable | N/A |
| 15.407 | Channel Move Time | Applicable | Pass |
| 15.407 | Channel Closing Transmission Time | Applicable | Pass |
| 15.407 | Non- Occupancy Period | Applicable | Pass |
| 15.407 | Uniform Spreading | Not Applicable | N/A |
| 15.407 | U-NII Detection Bandwidth | Not Applicable | N/A |
| 15.407 | Non-associated test | Applicable | Pass |
| 15.407 | Non-Co-Channel test | Applicable | Pass |

Note: Test procedure from KDB 905462 D02 UNII DFS Compliance Procedures New Rules v01r02.

5.2 DETAILED TEST RESULTS

5.2.1 TEST MODE: DEVICE OPERATING IN CLIENT WITHOUT RADAR DETECTION MODE

The radar test signals are injected into the Master Device.

This test was investigated for different bandwidth (20MHz and 40MHz). The following plots was done on 40MHz as a representative



5.2.2 DFS DETECTION THRESHOLD

The Required detection threshold is $-61.00\text{dBm} = -64 + 3\text{dBi}$. The conducted radar burst level is set to -61.21dBm .

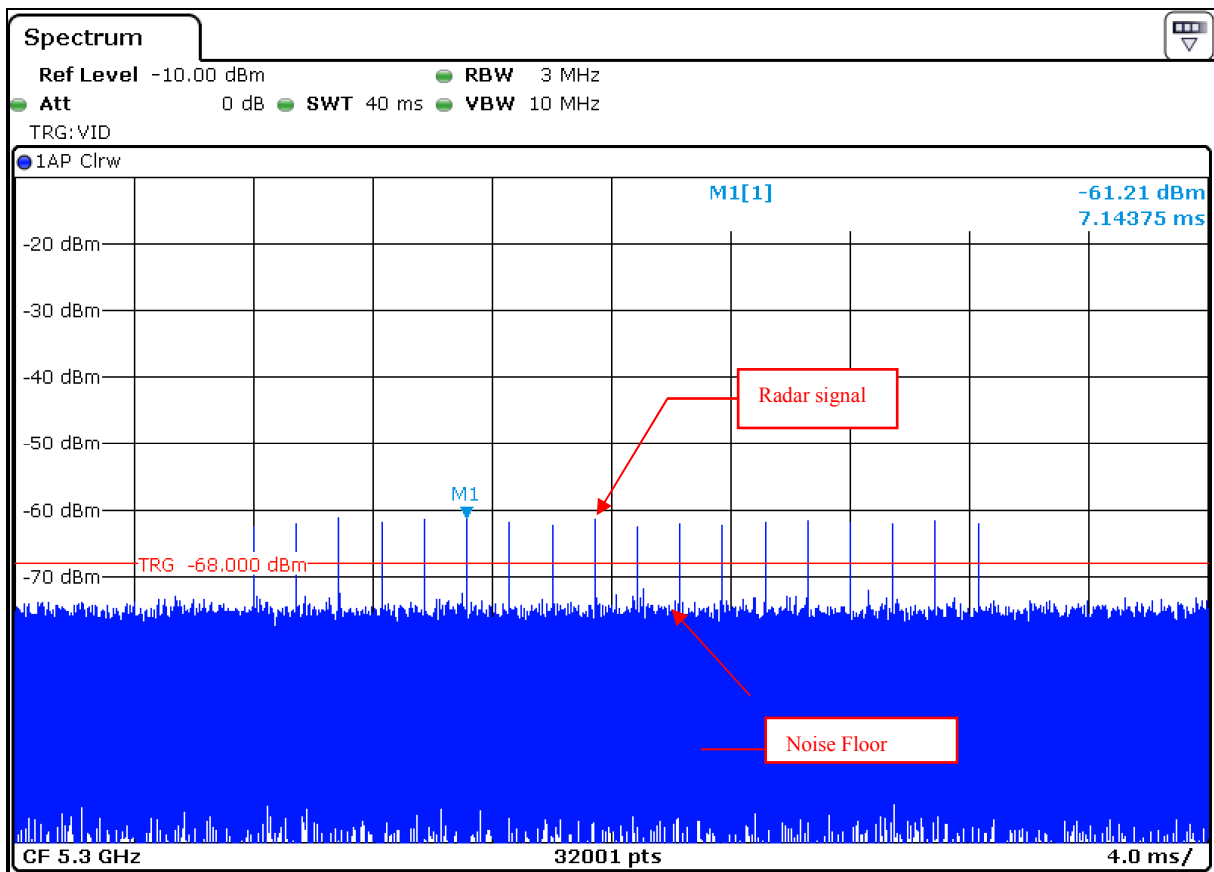

Radar Signal (Type 0)



5.2.3 CHANNEL LOADING

The measured channel is 5300MHz and 5500MHz in 20MHz Bandwidth and 5310MHz and 5510MHz in 40MHz Bandwidth. The radar signal was the same as transmitted channels, and injected into the antenna port of AP (master) with radar signal, measured the channel shutdown. The slave transmitted the test data to master, the transmitted duty cycle is 18.211%.

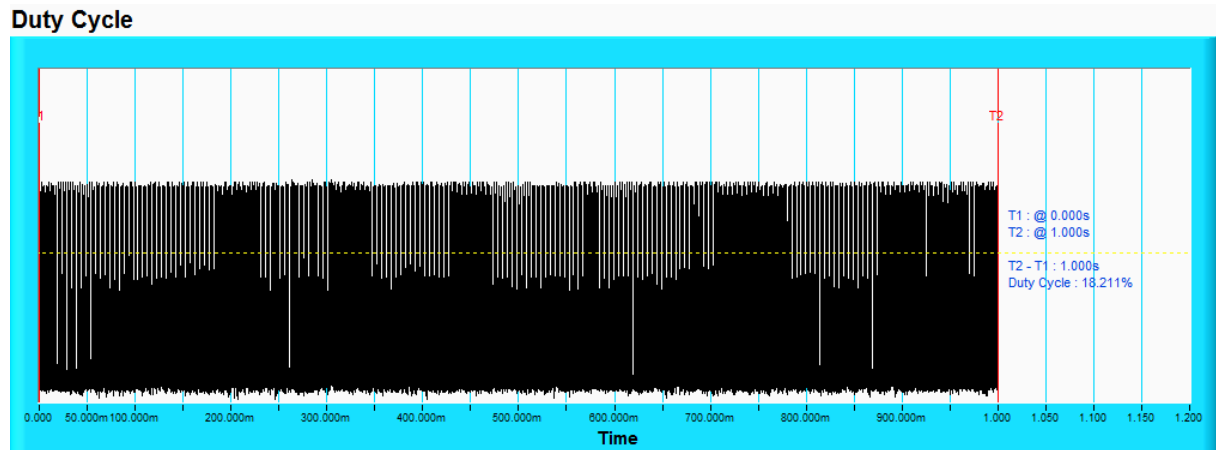

NOTE: T1 denotes the start of duty cycle period is 0th second. T2 denotes the end of duty cycle period is 1th second. T2 – T1= 1 seconds. Duty Cycle = 18.211%.

Note: Traffic signal: from slave transmit to master.



5.2.4 CHANNEL CLOSING TRANSMISSION AND CHANNEL MOVE TIME

Radar Signal 0

Channel Closing Transmission Time & Channel Move Time

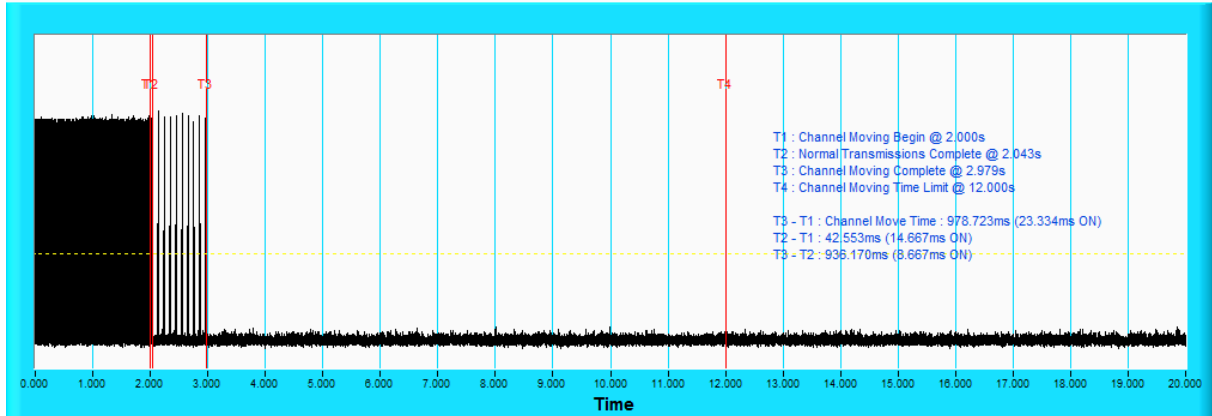

NOTE: T1 denotes the start of Channel Move Time upon the end of the last Radar burst. T2 denotes the data transmission time of 200ms from T1. T3 denotes the end of Channel Move Time. T4 denotes the 10 second from T1 to observe the aggregate duration of transmissions.

Channel Closing Transmission Time & Channel Move Time

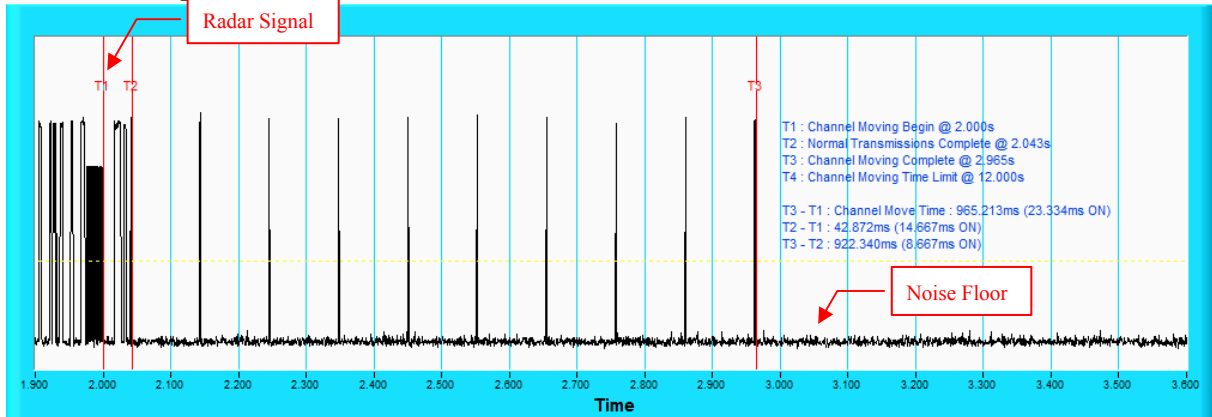

NOTE: Zoom in of the first 1600ms after radar signal applied.



5.2.5 NON- OCCUPANCY PERIOD

ASSOCIATED TEST

1) Test results demonstrating an associated client link is established with the master on a test frequency.

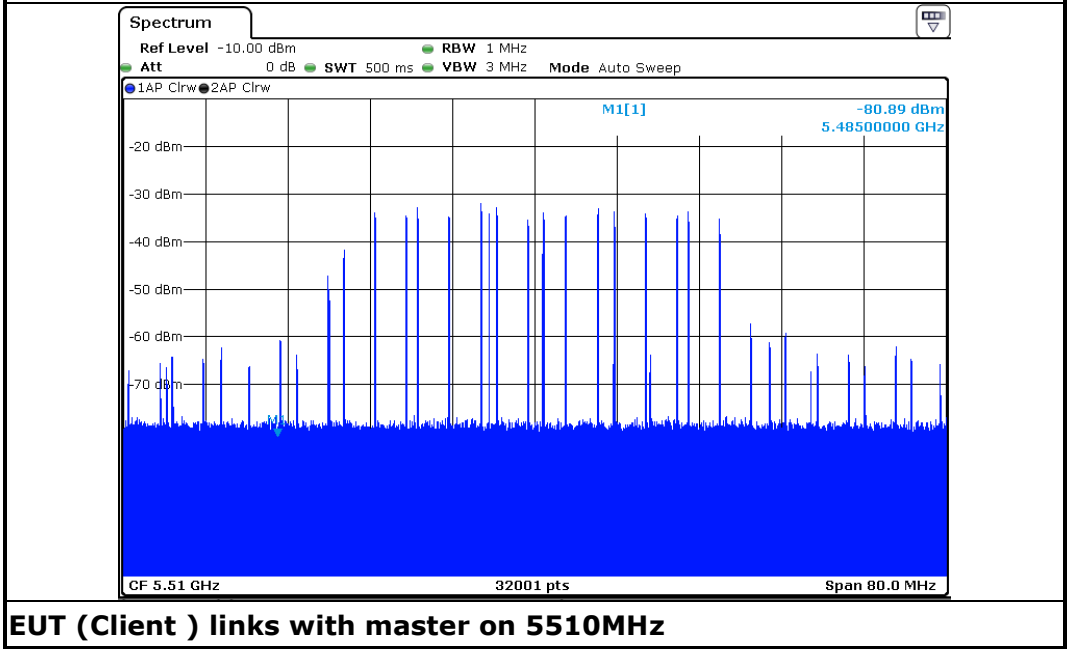

2) The client and DFS-certified master device are associated, and system testing will be performed with channel-loading for a non-occupancy period test.

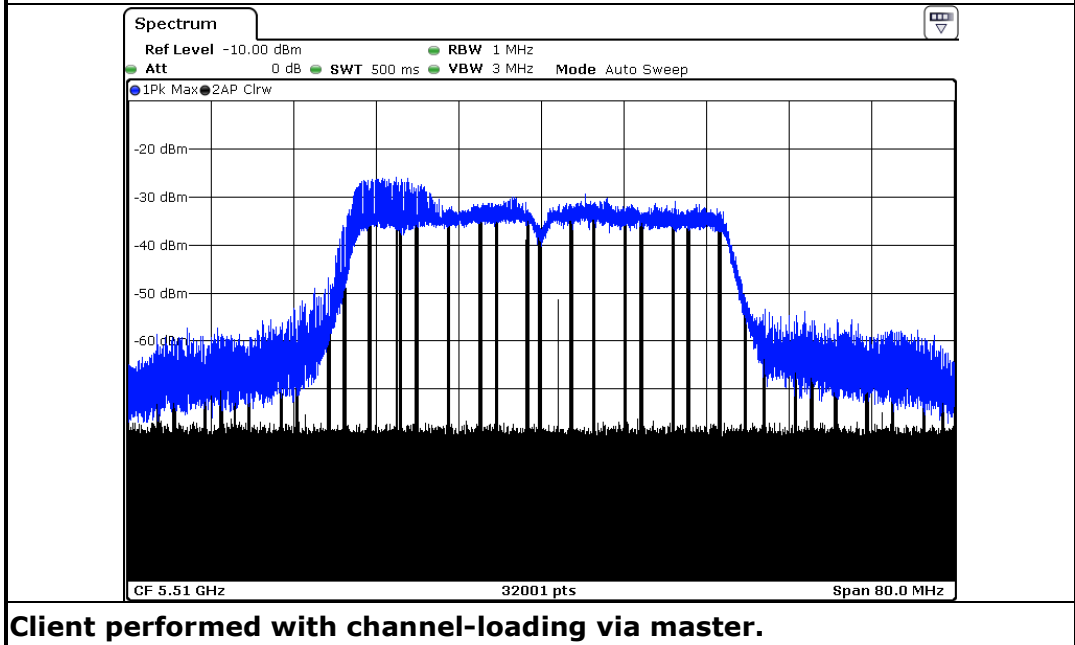



3). The device transmits one type of radar as specified in the DFS Order.

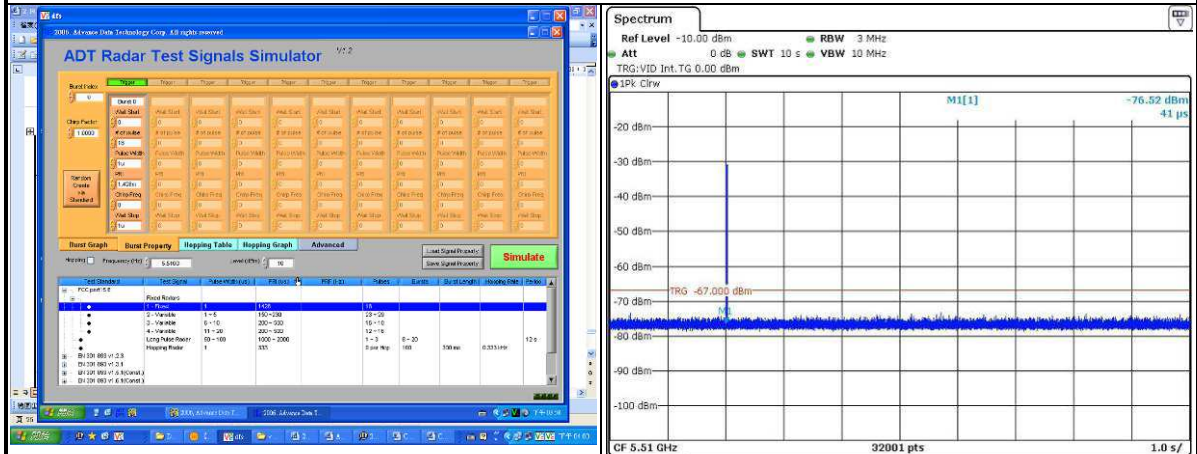

Radar Signal (Type 0) is used to test during DFS testing.

4) The test frequency has been monitored to ensure no transmission of any type has occurred for 30 minutes;

Note: If the client moves with the master, the device is considered compliant if nothing appears in the client non-occupancy period test. For devices that shut down (rather than moving channels), no beacons should appear;

5)An analyzer plot that contains a single 30-minute sweep on the original test frequency.

Non - Occupancy Period

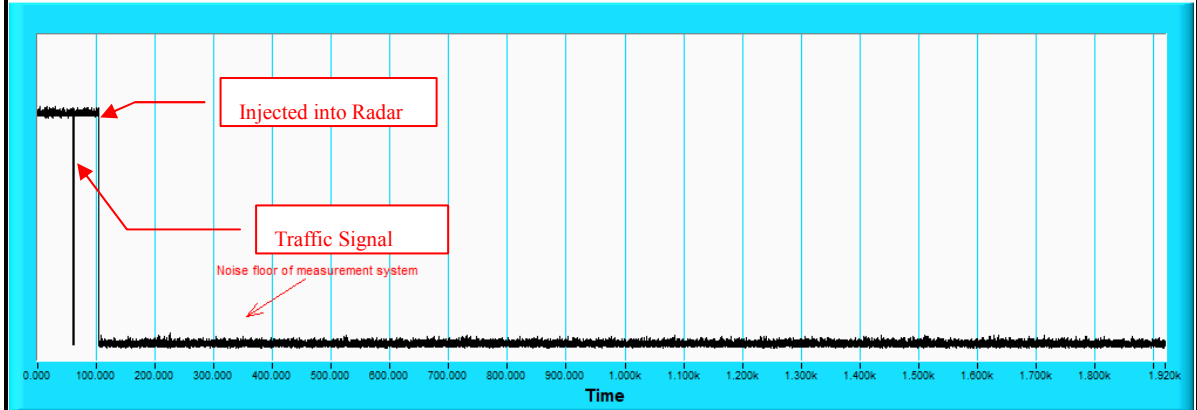



5.2.6 NON-ASSOCIATED TEST

Master was off.

During the 30 minutes observation time, The UUT did not make any transmissions in the DFS band after UUT power up.

Non - Occupancy Period

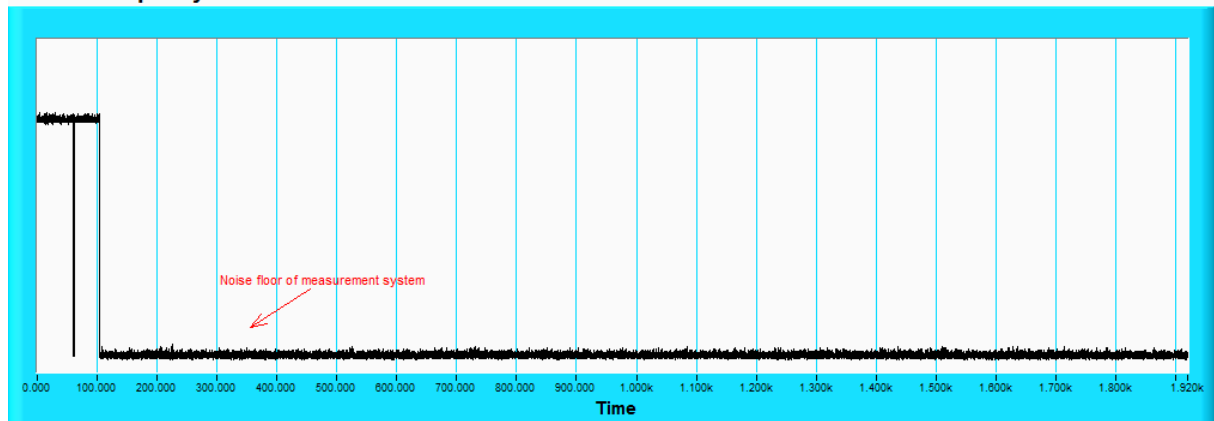

5.2.7 NON- CO-CHANNEL TEST

The UUT was investigated after radar was detected the channel and made sure no co-channel operation with radars.



**BUREAU
VERITAS**

Test Report No.: RF180822N038

6 APPENDIX A - Modifications recorders for engineering changes to the EUT BY THE LAB

No any modifications are made to the EUT by the lab during the test.

---END---