



FCC 47 CFR PART 15 SUBPART C

for

VUE

Model: IFACT

Brand: iFIT VUE

Test Report Number:

C150520Z05-RP1

Issued for

Icon Health and Fitness, Inc.

1500 South 1000 West Logan, UT 84321, USA

Issued by:

Compliance Certification Services (Shenzhen) Inc.

No.10-1, Mingkeda Logistics Park, No.18 Huanguan South Rd.,

Guan Lan Town, Baoan District, Shenzhen, China

TEL: 86-755-28055000

FAX: 86-755-28055221

Issued Date: July 16, 2015



Note: This report shall not be reproduced except in full, without the written approval of Compliance Certification Services (Shenzhen) Inc. This document may be altered or revised by Compliance Certification Services (Shenzhen) Inc. personnel only, and shall be noted in the revision section of the document. The client should not use it to claim product endorsement by TAF, A2LA, NVLAP, NIST, CNAS or any government agencies. The test results in the report only apply to the tested sample.



Revision History

Rev.	Issue Data	Revisions	Effect Page	Revised By
00	July 16, 2015	Initial Issue	ALL	Sinphy Xie



TABLE OF CONTENTS

1	TEST CERTIFICATION	4
2	TEST RESULT SUMMARY	5
3	EUT DESCRIPTION	6
4	TEST METHODOLOGY	7
4.1.	DESCRIPTION OF TEST MODES.....	7
5	SETUP OF EQUIPMENT UNDER TEST	8
5.1.	DESCRIPTION OF SUPPORT UNITS.....	8
5.2.	CONFIGURATION OF SYSTEM UNDER TEST.....	8
6	FACILITIES AND ACCREDITATIONS	9
6.1.	FACILITIES.....	9
6.2.	ACCREDITATIONS.....	9
6.3.	MEASUREMENT UNCERTAINTY.....	9
7	FCC PART 15.247 REQUIREMENTS	10
7.1.	POWER LINE CONDUCTED EMISSIONS MEASUREMENT.....	10
7.2.	SPURIOUS EMISSIONS MEASUREMENT.....	15
7.3.	6dB BANDWIDTH MEASUREMENT.....	28
7.4.	PEAK OUTPUT POWER.....	31
7.5.	BAND EDGES MEASUREMENT.....	34
7.6.	PEAK POWER SPECTRAL DENSITY MEASUREMENT.....	40
7.7.	ANTENNA GAIN.....	44



1 TEST CERTIFICATION

Product	VUE
Model	IFACT
Brand	iFIT VUE
Tested	May 20~July 16, 2015
Applicant	Icon Health and Fitness, Inc. 1500 South 1000 West Logan, UT 84321, USA
Manufacturer	GOLDTEK TECHNOLOGY CO., Ltd. 3F, No. 10, JianKang Rd., Zhonghe Dist., New Taipei City 23586, Taiwan, R.O.C.

APPLICABLE STANDARDS			
Standard	Test Type	Standard	Test Type
15.207(a)	Power Line Conducted Emissions	15.247(d) 15.209(a)	<ul style="list-style-type: none"> ● Spurious Emissions ● Conducted Measurement ● Radiated Emissions
15.247(a)(2)	6dB Bandwidth Measurement	15.247(b)(3) 15.247(b)(4)	Peak Power Measurement
15.247(d)	Band Edges Measurement	15.247(e)	Peak Power Spectral Density

We hereby certify that:

The above equipment was tested by Compliance Certification Services Inc. The test data, data evaluation, test procedures, and equipment configurations shown in this report were made in accordance with the procedures given in **ANSI C63.4: 2009** and the energy emitted by the sample EUT tested as described in this report is in compliance with the requirements of FCC Rules Part 15.207, 15.209, 15.247.

The test results of this report relate only to the tested sample EUT identified in this report.

Approved by:

Reviewed by:

Sunday Hu
Supervisor of EMC Dept.
Compliance Certification Service (Shenzhen) Inc.

Ruby Zhang
Supervisor of Report Dept.
Compliance Certification Service (Shenzhen) Inc.



2 TEST RESULT SUMMARY

APPLICABLE STANDARDS			
Standard	Test Type	Result	Remark
15.247(a)(2)	6dB Bandwidth Measurement	Pass	Meet the requirement of limit.
15.247(b)(3) 15.247(b)(4)	Peak Power Measurement	Pass	Meet the requirement of limit.
15.247(d)	Band Edges Measurement	Pass	Meet the requirement of limit.
15.247(e)	Peak Power Spectral Density	Pass	Meet the requirement of limit.
15.247(d) 15.209(a)	● Spurious Emissions ● Conducted Measurement ● Radiated Emissions	Pass	Meet the requirement of limit.
15.207(a)	Power line Conducted Emissions	Pass	Meet the requirement of limit.

Note: 1. The statements of test result on the above are decided by the request of test standard only; the measurement uncertainties are not factored into this compliance determination.
2. The information of measurement uncertainty is available upon the customer's request.



3 EUT DESCRIPTION

Product	VUE
Model	IFACT
Brand	iFIT VUE
Model Discrepancy	N/A
Identify Number	C150520Z05-RP1
Received Date	May 20, 2015
Power Supply	DC5V supplied by the notebook or DC3.8V supply by the battery
Frequency Range	2402-2480 MHz
Transmit Power	-15.05dBm
Modulation Technique	GFSK for 1Mbps
Number of Channels	40 Channels
Antenna Specification	Chip antenna with 1.72dBi gain (Max)
Temperature Range	0°C ~ +48°C
Hardware Version	ICON_ACT2_V03
Software Version	ACT2_V1.06

Note: 1. The sample selected for test was engineering sample that approximated to production product and was provided by manufacturer.

2. This submittal(s) (test report) is intended for FCC ID:OMC-IFACT2VUE filing to comply with Section 15.207, 15.209 and 15.247 of the FCC Part 15, Subpart C Rules.



4 TEST METHODOLOGY

4.1. DESCRIPTION OF TEST MODES

The EUT has been tested under operating condition.

Software used to control the EUT for staying in continuous transmitting and receiving mode is programmed.

Test Item	Test mode	Worse mode
Conducted Emission	Mode 1: Charge	<input checked="" type="checkbox"/>
Radiated Emission	Mode 1: TX	<input checked="" type="checkbox"/>

After verification, all tests were carried out with the worst case test modes as shown below except radiated spurious emission below 1GHz, which worst case was in normal link mode only.



5 SETUP OF EQUIPMENT UNDER TEST

5.1. DESCRIPTION OF SUPPORT UNITS

The EUT has been tested as an independent unit together with other necessary accessories or support units. The following support units or accessories were used to form a representative test configuration during the tests.

No.	Equipment	Model No.	Serial No.	FCC	Brand	Data Cable	Power Cord
1	Mobile phone	N/A	N/A	N/A	N/A	N/A	N/A
2	Notebook	E335	R9-WN1EF	N/A	Thinkpad	N/A	AC Cable: Unshielded 1.45m DC Cable: Unshielded 1.75m

Note:

Grounding was established in accordance with the manufacturer's requirements and conditions for the intended use.

5.2. CONFIGURATION OF SYSTEM UNDER TEST

See test photographs attached in Appendix II for the actual connections between EUT and support equipment.



6 FACILITIES AND ACCREDITATIONS

6.1. FACILITIES

All measurement facilities used to collect the measurement data are located at **No. 10-1, Mingkeda Logistics Park, No.18 Huanguan South RD. Guan Lan Town, Baoan District, Shenzhen China**

The sites are constructed in conformance with the requirements of ANSI C63.4, ANSI C63.7 and CISPR Publication 22. All receiving equipment conforms to CISPR Publication 16-1, "Radio Interference Measuring Apparatus and Measurement Methods."

6.2. ACCREDITATIONS

Our laboratories are accredited and approved by the following accreditation body according to ISO/IEC 17025.

USA	A2LA
China	CNAS

The measuring facility of laboratories has been authorized or registered by the following approval agencies.

USA	FCC
Japan	VCCI(C-3478, R-3135, T-652, G-624)
Canada	INDUSTRY CANADA
Taiwan	BSMI

Copies of granted accreditation certificates are available for downloading from our web site, <http://www.ccssz.com>

6.3. MEASUREMENT UNCERTAINTY

Where relevant, the following measurement uncertainty levels have been estimated for tests performed on the EUT as specified in CISPR 16-4-2:

Parameter	Uncertainty
Radiated Emission, 30 to 200 MHz Test Site : 966(2)	+/-3.6880dB
Radiated Emission, 200 to 1000 MHz Test Site : 966(2)	+/-3.6695dB
Radiated Emission, 1 to 8 GHz	+/-5.1782dB
Radiated Emission, 8 to 18 GHz	+/-5.2173dB
Conducted Emissions	+/-3.6836dB
Band Width	178kHz
Peak Output Power MU	+/-1.906dB
Band Edge MU	+/-0.182dB
Channel Separation MU	416.178Hz
Duty Cycle MU	0.054ms
Frequency Stability MU	226Hz

This uncertainty represents an expanded uncertainty expressed at approximately the 95% confidence level using a coverage factor of k=2.

The measured result is above (below) the specification limit by a margin less than the measurement uncertainty; it is therefore not possible to state compliance based on the 95% level of confidence. However, the result indicates that compliance (non-compliance) is more probable than non-compliance) with the specification limit.



7 FCC PART 15.247 REQUIREMENTS

7.1. POWER LINE CONDUCTED EMISSIONS MEASUREMENT

7.1.1. LIMITS OF CONDUCTED EMISSIONS MEASUREMENT

According to §15.207(a), except as shown in paragraphs (b) and (c) of this section, for an intentional radiator that is designed to be connected to the public utility (AC) power line, the radio frequency voltage that is conducted back onto the AC power line on any frequency or frequencies within the band 150 kHz to 30 MHz shall not exceed the limits in the following table, as measured using a 50 μ H/50 ohms line impedance stabilization network (LISN). Compliance with the provisions of this paragraph shall be based on the measurement of the radio frequency voltage between each power line and ground at the power terminal. The lower limit applies at the boundary between the frequency ranges.

Frequency Range (MHz)	Limits (dB μ V)	
	Quasi-peak	Average
0.15 to 0.50	66 to 56*	56 to 46*
0.50 to 5	56	46
5 to 30	60	50

NOTE:

- (1) The lower limit shall apply at the transition frequencies.
- (2) The limit decreases in line with the logarithm of the frequency in the range of 0.15 to 0.50 MHz.
- (3) All emanations from a class A/B digital device or system, including any network of conductors and apparatus connected thereto, shall not exceed the level of field strengths specified above.

7.1.2. TEST INSTRUMENTS

Conducted Emission Test Site					
Name of Equipment	Manufacturer	Model Number	Serial Number	Last Calibration	Due Calibration
EMI TEST RECEIVER	ROHDE&SCHWARZ	ESCI	100783	02/28/2015	02/27/2016
LISN(EUT)	ROHDE&SCHWARZ	ENV216	101543-WX	02/28/2015	02/27/2016
LISN	EMCO	3825/2	8901-1459	02/28/2015	02/27/2016
Temp. / Humidity Meter	VICTOR	HTC-1	N/A	02/28/2015	02/27/2016
Test S/W	FARAD	EZ-EMC/ CCS-3A1-CE			

- NOTE:** 1. The calibration interval of the above test instruments is 12 months and the calibrations are traceable to NML/ROC and NIST/USA.
 2. N.C.R = No Calibration Request.



7.1.3. TEST PROCEDURES (please refer to measurement standard)

- The EUT and Support equipment, if needed, was placed on a non-conducted table, which is 0.8m above the ground plane and 0.4m away from the conducted wall.
- The test equipment EUT installed received AC main power, through a Line Impedance Stabilization Network (LISN), which supplied power source and was grounded to the ground plane. All support equipment power received from a second LISN. The two LISNs provide 50 ohm/ 50uH of coupling impedance for the measuring instrument.
- The EUT test program was started. Emissions were measured on each current carrying line of the EUT using an EMI Test Receiver connected to the LISN powering the EUT.
- The frequency range from 150 kHz to 30 MHz was searched. The test data of the worst-case condition(s) was recorded. Emission levels under limit 20dB were not recorded.



7.1.4. TEST SETUP

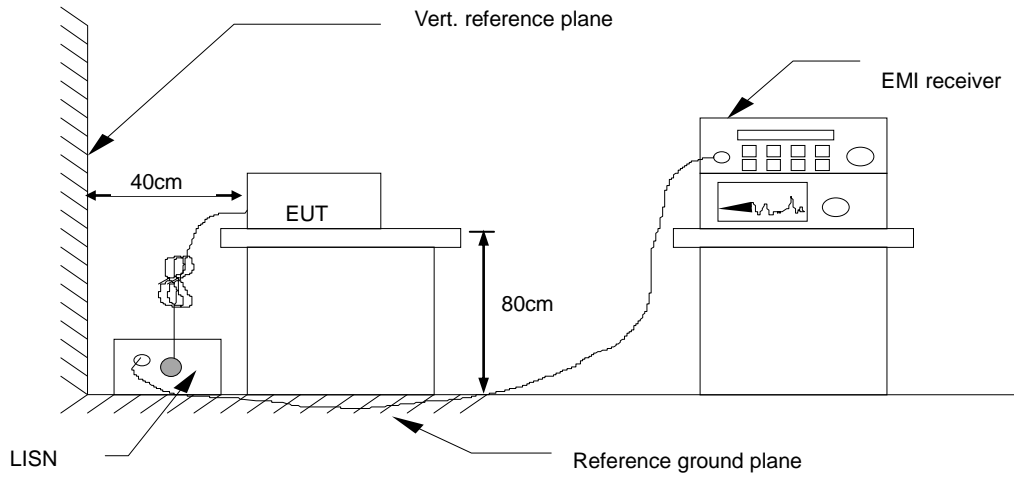

For the actual test configuration, please refer to the related item - Photographs of the Test Configuration.

7.1.5. DATA SAMPLE

Frequency (MHz)	QuasiPeak Reading (dBuV)	Average Reading (dBuV)	Correction Factor (dB)	QuasiPeak Result (dBuV)	Average Result (dBuV)	QuasiPeak Limit (dBuV)	Average Limit (dBuV)	QuasiPeak Margin (dB)	Average Margin (dB)	Remark (Pass/Fail)
X.XXXX	34.99	19.33	10.15	45.14	29.48	65.99	56.00	-20.85	-26.52	Pass

Factor = Insertion loss of LISN + Cable Loss
 Result = Quasi-peak Reading/ Average Reading + Factor
 Limit = Limit stated in standard
 Margin = Result (dBuV) – Limit (dBuV)



7.1.6. TEST RESULTS

Test Data

Model No.	IFACT	RBW,VBW	9 kHz
Environmental Conditions	26°C, 60% RH	Test Mode	Mode 1
Tested by	Eve Wang	Line	L1
Test Date	May 22, 2015		

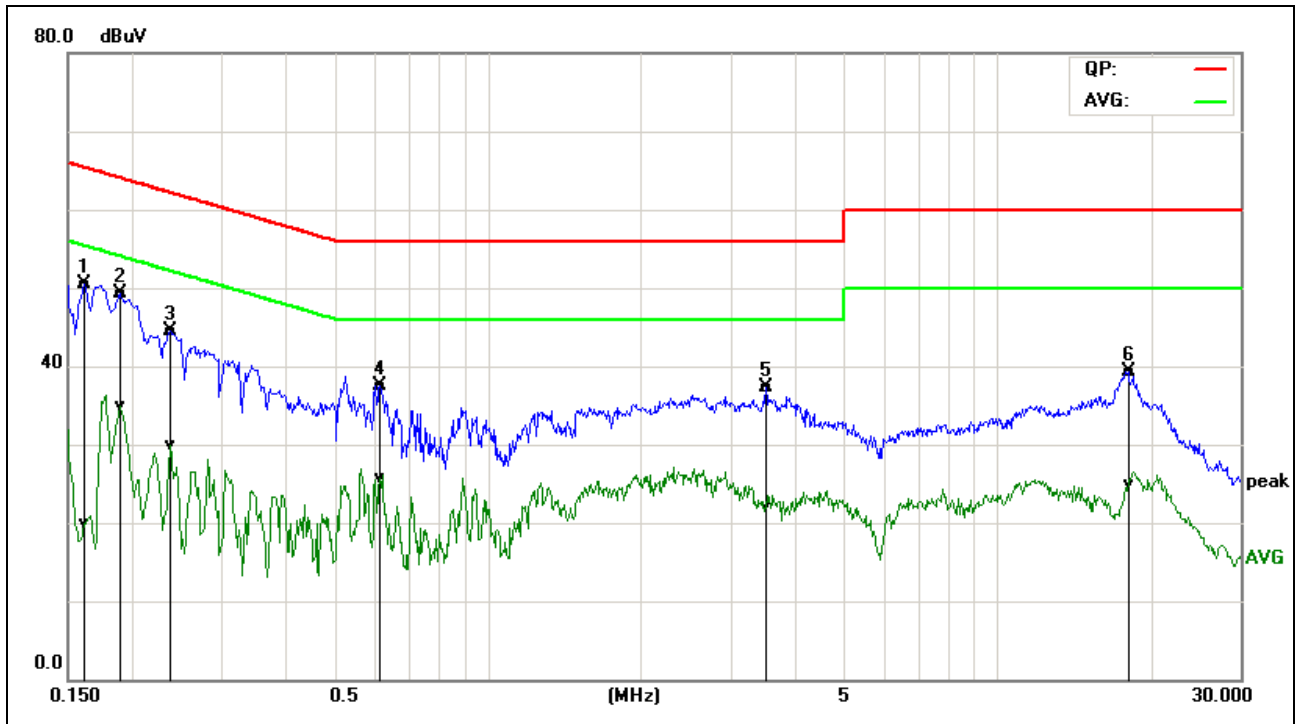

Frequency (MHz)	QuasiPeak Reading (dBuV)	Average Reading (dBuV)	Correction Factor (dB)	QuasiPeak Result (dBuV)	Average Result (dBuV)	QuasiPeak Limit (dBuV)	Average Limit (dBuV)	QuasiPeak Margin (dB)	Average Margin (dB)	Remark (Pass/Fail)
0.1620	40.93	10.24	9.60	50.53	19.84	65.36	55.36	-14.83	-35.52	Pass
0.1900	39.68	25.19	9.67	49.35	34.86	64.03	54.04	-14.68	-19.18	Pass
0.2380	34.81	20.12	9.69	44.50	29.81	62.16	52.17	-17.66	-22.36	Pass
0.6140	27.77	16.01	9.75	37.52	25.76	56.00	46.00	-18.48	-20.24	Pass
3.5220	27.59	12.35	9.71	37.30	22.06	56.00	46.00	-18.70	-23.94	Pass
18.0940	29.44	14.97	9.86	39.30	24.83	60.00	50.00	-20.70	-25.17	Pass

Note:

1. Measuring frequencies from 0.15 MHz to 30MHz.
2. The emissions measured in frequency range from 0.15 MHz to 30MHz were made with an instrument using Peak detector, Quasi-peak detector and average detector.
3. "---" denotes the emission level was or more than 2dB below the Average limit.
4. The IF bandwidth of SPA between 0.15MHz to 30MHz was 10kHz; the IF bandwidth of Test Receiver between 0.15MHz to 30MHz was 9kHz;
5. L1= Line One (Live Line)



Model No.	IFACT	RBW,VBW	9 kHz
Environmental Conditions	26°C, 60% RH	Test Mode	Mode 1
Tested by	Eve Wang	Line	L2
Test Date	May 22, 2015		

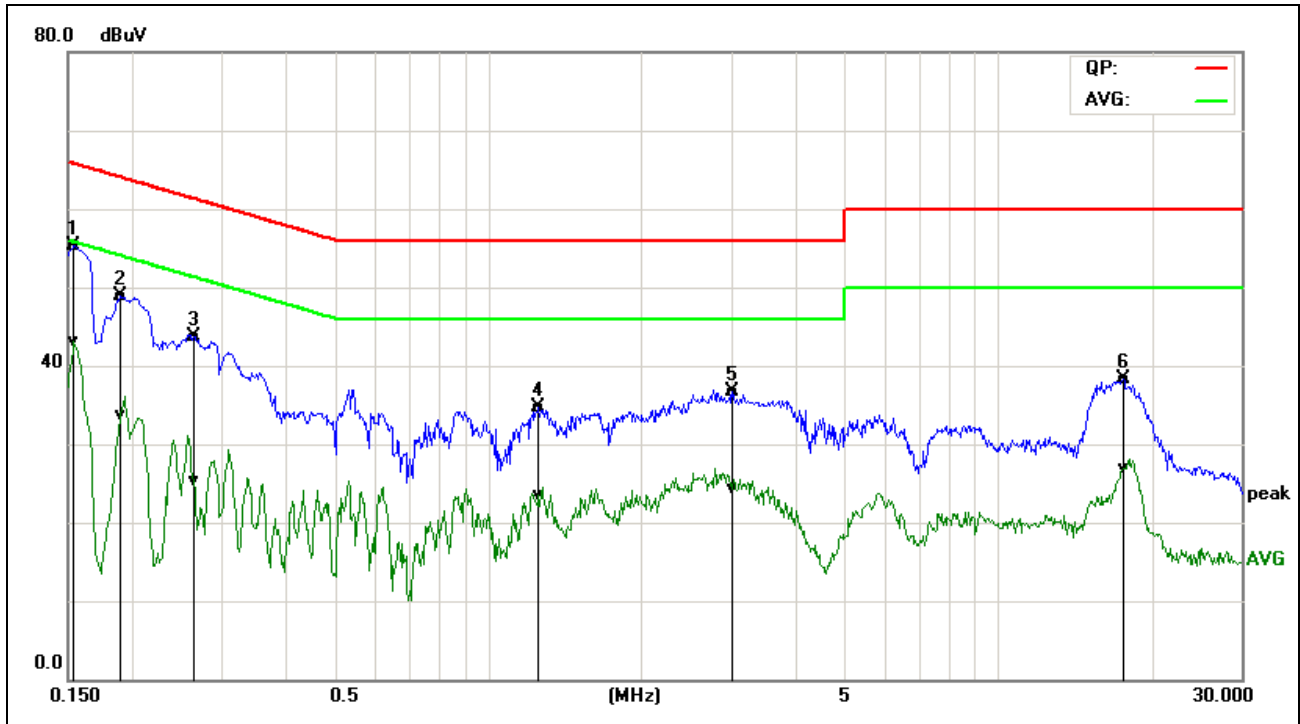

Frequency (MHz)	QuasiPeak Reading (dBuV)	Average Reading (dBuV)	Correction Factor (dB)	QuasiPeak Result (dBuV)	Average Result (dBuV)	QuasiPeak Limit (dBuV)	Average Limit (dBuV)	QuasiPeak Margin (dB)	Average Margin (dB)	Remark (Pass/Fail)
0.1539	45.55	33.27	9.78	55.33	43.05	65.78	55.79	-10.45	-12.74	Pass
0.1900	39.11	23.87	9.79	48.90	33.66	64.03	54.04	-15.13	-20.38	Pass
0.2644	34.03	15.60	9.77	43.80	25.37	61.29	51.29	-17.49	-25.92	Pass
1.2620	24.96	13.71	9.79	34.75	23.50	56.00	46.00	-21.25	-22.50	Pass
3.0180	26.97	14.52	9.75	36.72	24.27	56.00	46.00	-19.28	-21.73	Pass
17.5820	28.64	17.19	9.72	38.36	26.91	60.00	50.00	-21.64	-23.09	Pass

Note:

1. Measuring frequencies from 0.15 MHz to 30MHz.
2. The emissions measured in frequency range from 0.15 MHz to 30MHz were made with an instrument using Peak detector, Quasi-peak detector and average detector.
3. "---" denotes the emission level was or more than 2dB below the Average limit.
4. The IF bandwidth of SPA between 0.15MHz to 30MHz was 10kHz; the IF bandwidth of Test Receiver between 0.15MHz to 30MHz was 9kHz;
5. L2= Line Two (Neutral Line)



7.2. SPURIOUS EMISSIONS MEASUREMENT

7.2.1. LIMITS OF CONDUCTED EMISSIONS MEASUREMENT

According to §15.247(d), in any 100 kHz bandwidth outside the frequency bands in which the spread spectrum intentional radiator is operating, the radio frequency power that is produced by the intentional radiator shall be at least 20 dB below that in the 100 kHz bandwidth within the band that contains the highest level of the desired power, based on either an RF conducted or a radiated measurement, provided the transmitter demonstrates compliance with the peak conducted power limits. In addition, radiated emissions which fall in the restricted bands, as defined in §15.205(a), must also comply with the radiated emission limits specified in 15.209(a) (see Section 15.205(c)).

7.2.2. TEST INSTRUMENTS

Name of Equipment	Manufacturer	Model	Serial Number	Last Calibration	Due Calibration
Spectrum Analyzer	Agilent	N9010A	MY52221469	10/25/2014	10/24/2015

7.2.3. TEST PROCEDURE (please refer to measurement standard)

Conducted RF measurements of the transmitter output were made to confirm that the EUT antenna port conducted emissions meet the specified limit and to identify any spurious signals that require further investigation or measurements on the radiated emissions site.

The transmitter output is connected to the spectrum analyzer. The resolution bandwidth is set to 100 kHz. The video bandwidth is set to 300 kHz.

Measurements are made over the 9kHz to 26.5GHz range with the transmitter set to the lowest, middle, and highest channels. Recorded frequency range from 10MHz to 26.5GHz as values from 9kHz to 10MHz lower than limits.



7.2.4. TEST RESULTS

Test Plot

CH Low (10MHz ~26.5GHz)

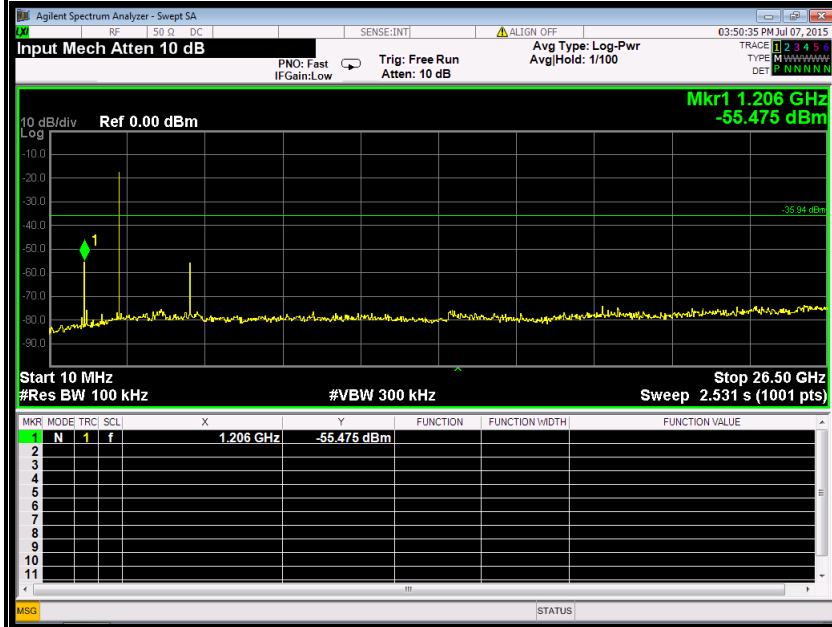

CH Low (2.31GHz ~2.41GHz)

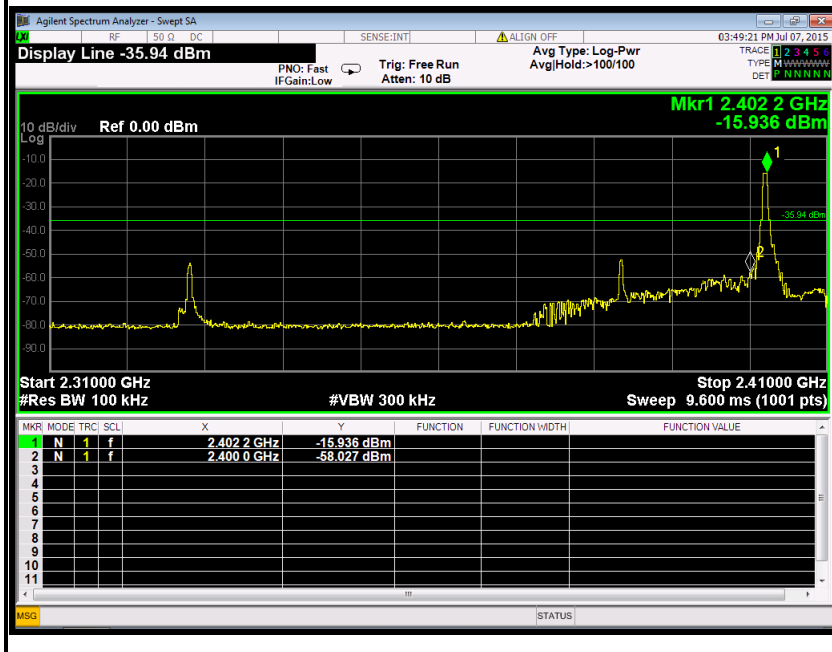

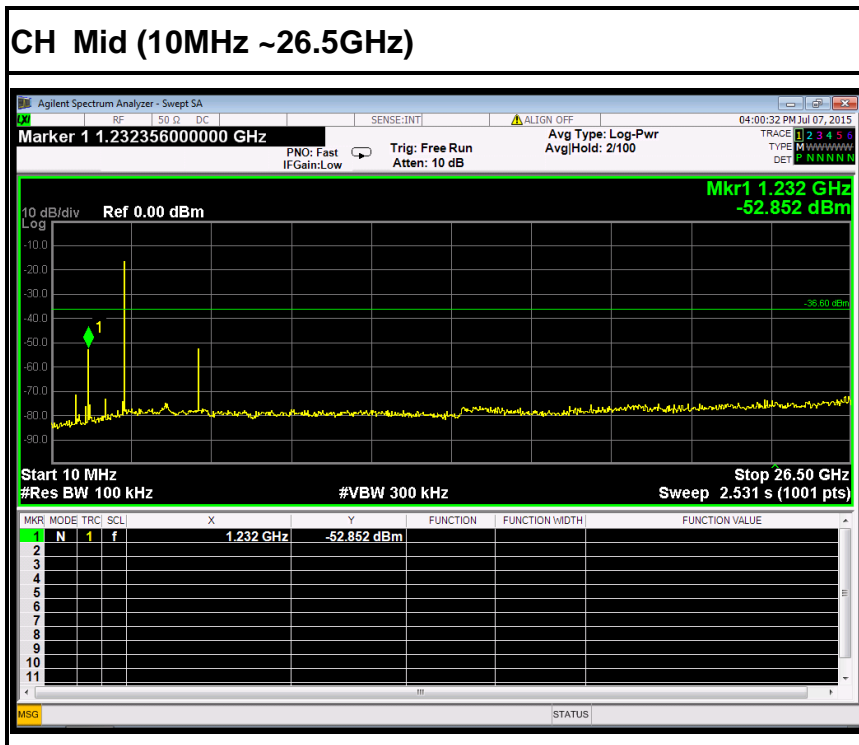



CH High (10MHz ~26.5GHz)

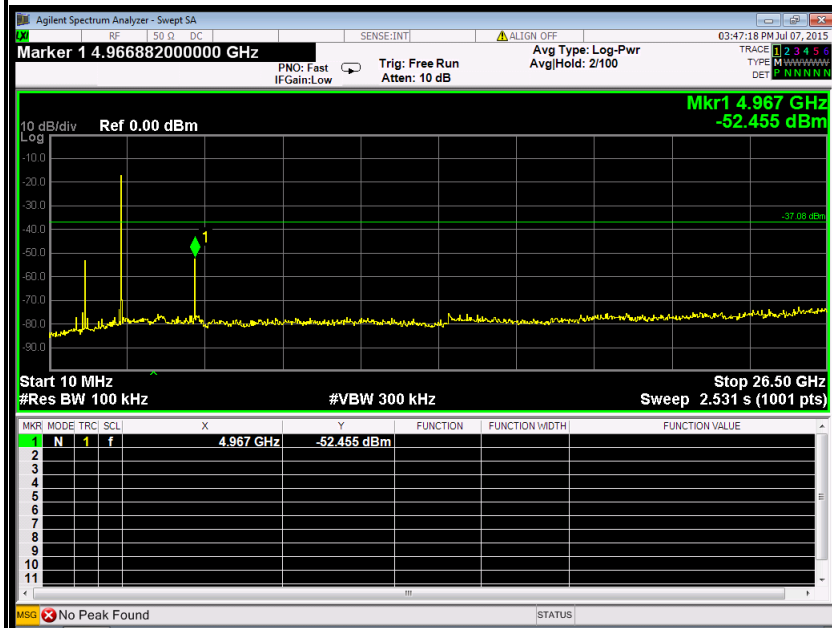

CH High(2.475GHz ~2.5GHz)

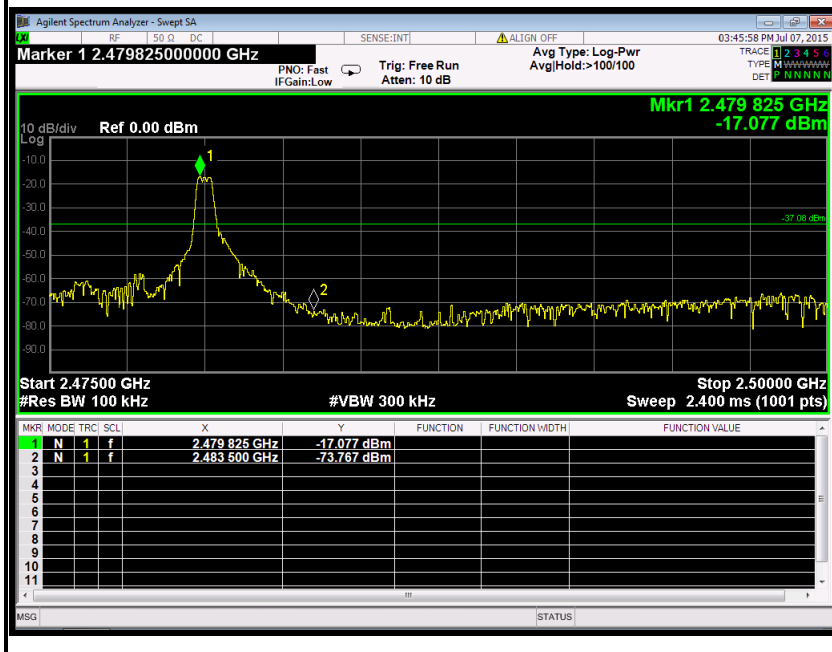



7.2.4.1. LIMITS OF RADIATED EMISSIONS MEASUREMENT

According to §15.209(a), except as provided elsewhere in this Subpart, the emissions from an intentional radiator shall not exceed the field strength levels specified in the following table:

Frequency (MHz)	Field Strength (mV/m)	Measurement Distance (m)
0.009-0.490	2400/F(kHz)	300
0.490-1.705	24000/F(kHz)	30
1.705-30.0	30	30
30-88	100*	3
88-216	150*	3
216-960	200*	3
Above 960	500	3

Remark: Except as provided in paragraph (g), fundamental emissions from intentional radiators operating under this Section shall not be located in the frequency bands 54-72 MHz, 76-88 MHz, 174-216 MHz or 470-806 MHz. However, operation within these frequency bands is permitted under other sections of this Part, e.g., Sections 15.231 and 15.241.

1. In the emission table above, the tighter limit applies at the band edges.

Frequency (MHz)	Field Strength (µV/m at 3-meter)	Field Strength (dBµV/m at 3-meter)
30-88	100	40
88-216	150	43.5
216-960	200	46
Above 960	500	54

NOTE: (1) The lower limit shall apply at the transition frequencies.

(2) Emission level (dBuV/m) = 20 log Emission level (uV/m).



7.2.4.2. TEST INSTRUMENTS

Radiated Emission Test Site 966 (2)					
Name of Equipment	Manufacturer	Model Number	Serial Number	Last Calibration	Due Calibration
PSA Series Spectrum Analyzer	Agilent	N9010A	MY52221469	10/25/2014	10/24/2015
EMI TEST RECEIVER	ROHDE&SCHWARZ	ESCI	100783	02/28/2015	02/27/2016
Amplifier	MITEQ	AM-1604-3000	1123808	03/18/2015	03/18/2016
High Noise Amplifier	Agilent	8449B	3008A01838	02/28/2015	02/27/2016
Board-Band Horn Antenna	Schwarzbeck	BBHA 9170	9170-497	02/28/2015	02/27/2016
Bilog Antenna	SCHAFFNER	CBL6143	5082	02/28/2015	02/27/2016
Horn Antenna	SCHWARZBECK	BBHA9120	D286	02/28/2015	02/27/2016
Loop Antenna	COM-POWER	AL-130	121044	09/25/2014	09/24/2015
Turn Table	N/A	N/A	N/A	N.C.R	N.C.R
Controller	Sunol Sciences	SC104V	022310-1	N.C.R	N.C.R
Controller	CT	N/A	N/A	N.C.R	N.C.R
Temp. / Humidity Meter	Anymetre	JR913	N/A	02/28/2015	02/27/2016
Antenna Tower	SUNOL	TLT2	N/A	N.C.R	N.C.R
Test S/W	FARAD	LZ-RF / CCS-SZ-3A2			

- NOTE:** 1. The calibration interval of the above test instruments is 12 months and the calibrations are traceable to NML/ROC and NIST/USA.
 2. The FCC Site Registration number is 101879.
 3. N.C.R = No Calibration Required.



7.2.4.3. TEST PROCEDURE (please refer to measurement standard)

1. The EUT is placed on a turntable, which is 0.8m above ground plane.
2. The turntable shall be rotated for 360 degrees to determine the position of maximum emission level.
3. EUT is set 3m away from the receiving antenna, which is varied from 1m to 4m to find out the highest emissions.
4. Maximum procedure was performed on the six highest emissions to ensure EUT compliance.
5. And also, each emission was to be maximized by changing the polarization of receiving antenna both horizontal and vertical.
6. Set the spectrum analyzer in the following setting as:

Below 1GHz:

RBW=100kHz / VBW=300kHz / Sweep=AUTO

Above 1GHz:

(a) PEAK: RBW=VBW=1MHz / 3MHz / Sweep=AUTO

(b) AVERAGE: RBW=1MHz / VBW=3MHz / Sweep=AUTO / Detector = RMS

7. Repeat above procedures until the measurements for all frequencies are complete.

7.2.4.4. TEST SETUP

Below 30MHz

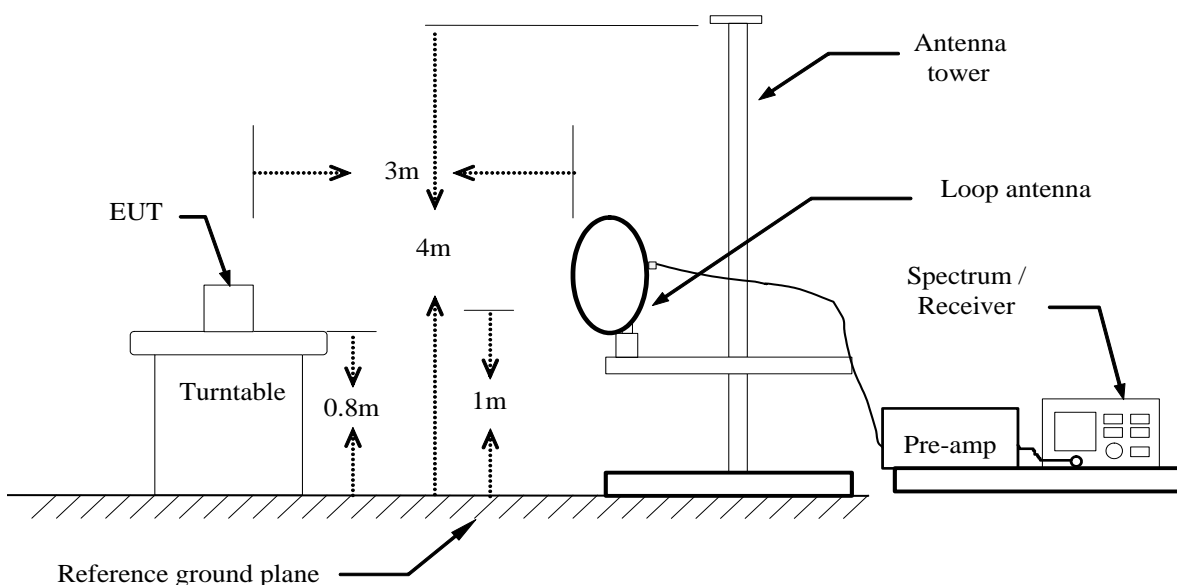



Below 1 GHz

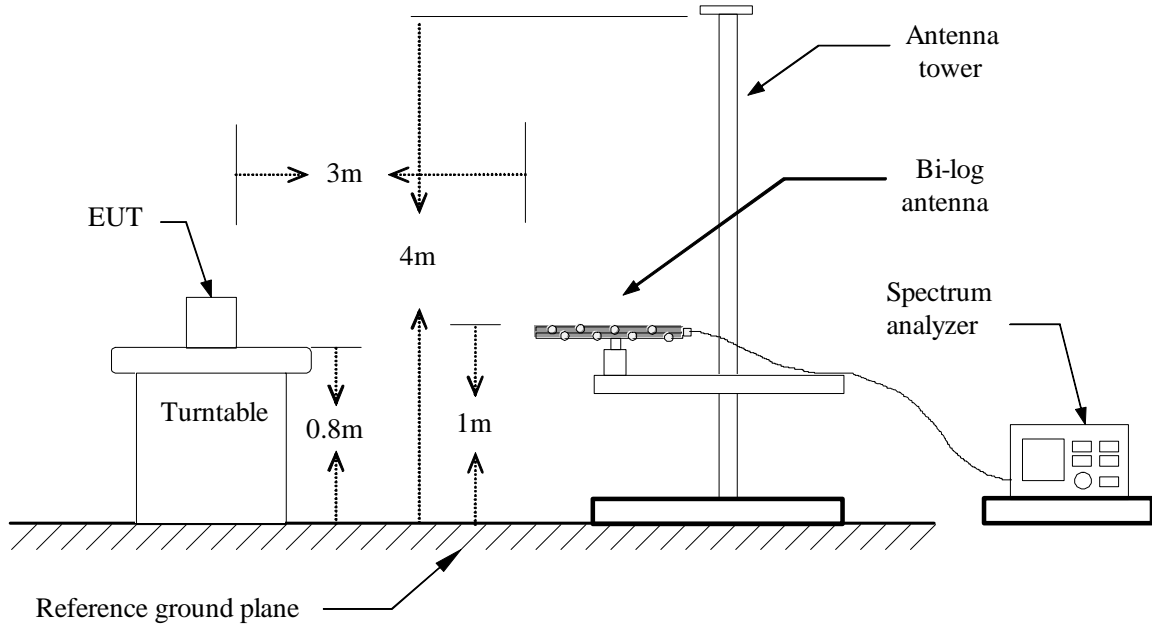

Above 1 GHz

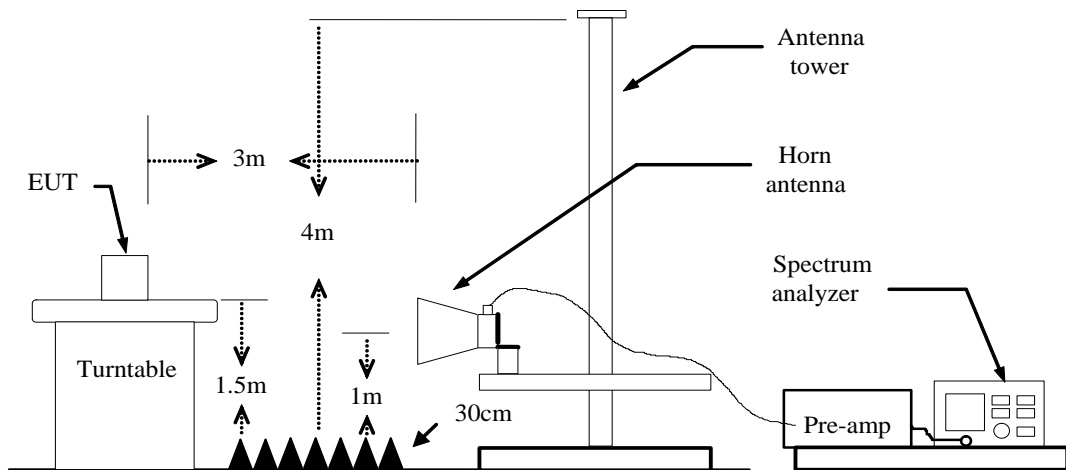

For the actual test configuration, please refer to the related item – Photographs of the Test Configuration.



7.2.4.5. DATA SAMPLE

Below 1GHz

Frequency (MHz)	Reading (dBuV)	Correct Factor (dB/m)	Result (dBuV/m)	Limit (dBuV/m)	Margin (dB)	Antenna Pole (V/H)	Remark
XXX.XXXX	53.41	-18.63	34.78	43.50	-8.72	V	QP

Frequency (MHz) = Emission frequency in MHz
 Reading (dBuV) = Uncorrected Analyzer / Receiver reading
 Correct Factor (dB/m) = Antenna factor + Cable loss – Amplifier gain
 Result (dBuV/m) = Reading (dBuV) + Corr. Factor (dB/m)
 Limit (dBuV/m) = Limit stated in standard
 Margin (dB) = Result (dBuV/m) – Limit (dBuV/m)
 Q.P. = Quasi-peak Reading

Above 1GHz

Frequency (MHz)	Reading (dBuV)	Correction Factor (dB/m)	Result (dBuV/m)	Limit (dBuV/m)	Margin (dB)	Antenna Pole (V/H)	Remark
XXXX.XXXX	62.09	-11.42	50.67	74.00	-23.33	V	Peak
XXXX.XXXX	49.78	-11.42	38.36	54.00	-15.64	V	AVG

Frequency (MHz) = Emission frequency in MHz
 Reading (dBuV) = Uncorrected Analyzer / Receiver reading
 Correction Factor (dB/m) = Antenna factor + Cable loss – Amplifier gain
 Result (dBuV/m) = Reading (dBuV) + Corr. Factor (dB/m)
 Limit (dBuV/m) = Limit stated in standard
 Margin (dB) = Result (dBuV/m) – Limit (dBuV/m)
 Peak = Peak Reading
 AVG = Average Reading

Calculation Formula

Margin (dB) = Result (dBuV/m) – Limits (dBuV/m)
 Result (dBuV/m) = Reading (dBuV) + Correction Factor



7.2.4.6. TEST RESULTS

Below 1 GHz

Test Mode: TX

Tested by: Eve Wang

Ambient temperature: 24°C **Relative humidity:** 52% RH

Date: June 26, 2015

Frequency (MHz)	Reading (dBuV)	Correction Factor (dB/m)	Result (dBuV/m)	Limit (dBuV/m)	Margin (dB)	Antenna Pole (V/H)	Remark
286.0800	44.61	-20.44	24.17	46.00	-21.83	V	QP
503.3600	39.97	-14.32	25.65	46.00	-20.35	V	QP
576.1100	35.59	-13.07	22.52	46.00	-23.48	V	QP
672.1400	34.93	-12.19	22.74	46.00	-23.26	V	QP
730.3400	34.33	-11.60	22.73	46.00	-23.27	V	QP
999.0300	37.89	-9.35	28.54	54.00	-25.46	V	QP
191.0200	51.83	-22.85	28.98	43.50	-14.52	H	QP
286.0800	43.97	-20.44	23.53	46.00	-22.47	H	QP
459.7100	38.33	-15.19	23.14	46.00	-22.86	H	QP
579.9900	38.68	-13.11	25.57	46.00	-20.43	H	QP
697.3600	36.06	-12.01	24.05	46.00	-21.95	H	QP
844.8000	34.25	-10.72	23.53	46.00	-22.47	H	QP

****Remark:** No emission found between lowest internal used/generated frequency to 30MHz.

Notes:

1. Radiated emissions measured in frequency range from 9kHz to 1GHz were made with an instrument using Quasi-peak detector mode.
2. Data of measurement within this frequency range shown " --- " in the table above means the reading of emissions are attenuated more than 20dB below the permissible limits or the field strength is too small to be measured.
3. The IF bandwidth of Receiver between 30MHz to 1GHz was 120kHz.
4. Frequency (MHz). = Emission frequency in MHz
 Reading (dBuV/m) = Receiver reading
 Correction Factor (dB) = Antenna factor + Cable loss – Amplifier gain
 Limit (dBuV/m) = Limit stated in standard
 Margin (dB) = Measured (dBuV/m) – Limits (dBuV/m)
 Antenna Pole (H/V) = Current carrying line of reading



Above 1 GHz

Test Mode: GFSK (CH Low)

Tested by: Eve Wang

Ambient temperature: 24°C **Relative humidity:** 52% RH

Date: June 25, 2015

Frequency (MHz)	Reading (dBµV)	Correction Factor (dB/m)	Result (dBµV/m)	Limit (dBµV/m)	Margin (dB)	Antenna Pole (V/H)	Remark
1333.000	46.14	-7.30	38.84	74.00	-35.16	V	peak
3367.000	42.31	-0.74	41.57	74.00	-32.43	V	peak
4168.000	41.65	2.18	43.83	74.00	-30.17	V	peak
4807.000	45.90	4.35	50.25	74.00	-23.75	V	peak
6148.000	39.43	6.32	45.75	74.00	-28.25	V	peak
6706.000	40.18	7.22	47.40	74.00	-26.60	V	peak

1198.000	50.88	-7.80	43.08	74.00	-30.92	H	peak
3358.000	42.39	-0.76	41.63	74.00	-32.37	H	peak
3898.000	41.51	1.16	42.67	74.00	-31.33	H	peak
4807.000	49.79	4.35	54.14	74.00	-19.86	H	peak
4807.000	48.52	4.35	52.87	54.00	-1.13	H	AVG
5392.000	40.13	5.68	45.81	74.00	-28.19	H	peak
6292.000	39.45	6.55	46.00	74.00	-28.00	H	peak

REMARKS:

1. Measuring frequencies from 1 GHz to the 10th harmonic of highest fundamental frequency.
2. Radiated emissions measured in frequency above 1000MHz were made with an instrument using peak/average detector mode.
3. Average test would be performed if the peak result were greater than the average limit or as required by the applicant.
4. Data of measurement within this frequency range shown " --- " in the table above means the reading of emissions are attenuated more than 20dB below the permissible limits or the field strength is too small to be measured.
5. Measurements above show only up to 6 maximum emissions noted, or would be lesser, with " N/A " remark, if no specific emissions from the EUT are recorded (ie: margin>20dB from the applicable limit) and considered that's already beyond the background noise floor.
6. Margin (dB) = Remark result (dBuV/m) – Average limit (dBuV/m).



Test Mode: GFSK (CH Mid)

Tested by: Eve Wang

Ambient temperature: 24°C Relative humidity: 52% RH

Date: June 25, 2015

Frequency (MHz)	Reading (dBμV)	Correction Factor (dB/m)	Result (dBμV/m)	Limit (dBμV/m)	Margin (dB)	Antenna Pole (V/H)	Remark
2908.000	42.91	-1.53	41.38	74.00	-32.62	V	peak
3898.000	41.65	1.16	42.81	74.00	-31.19	V	peak
4879.000	46.22	4.59	50.81	74.00	-23.19	V	peak
5554.000	40.20	5.89	46.09	74.00	-27.91	V	peak
6715.000	39.42	7.24	46.66	74.00	-27.34	V	peak
6958.000	40.23	7.63	47.86	74.00	-26.14	V	peak
1711.000	46.16	-6.46	39.70	74.00	-34.30	H	peak
2773.000	43.24	-1.77	41.47	74.00	-32.53	H	peak
4159.000	41.49	2.15	43.64	74.00	-30.36	H	peak
4879.000	50.22	4.59	54.81	74.00	-19.19	H	peak
4879.000	48.57	4.59	53.16	54.00	-0.84	H	AVG
5626.000	40.90	5.92	46.82	74.00	-27.18	H	peak
6265.000	39.70	6.51	46.21	74.00	-27.79	H	peak

REMARKS:

1. Measuring frequencies from 1 GHz to the 10th harmonic of highest fundamental frequency.
2. Radiated emissions measured in frequency above 1000MHz were made with an instrument using peak/average detector mode.
3. Average test would be performed if the peak result were greater than the average limit or as required by the applicant.
4. Data of measurement within this frequency range shown “ --- ” in the table above means the reading of emissions are attenuated more than 20dB below the permissible limits or the field strength is too small to be measured.
5. Measurements above show only up to 6 maximum emissions noted, or would be lesser, with “ N/A ” remark, if no specific emissions from the EUT are recorded (ie: margin>20dB from the applicable limit) and considered that's already beyond the background noise floor.
6. Margin (dB) = Remark result (dBuV/m) – Average limit (dBuV/m).



Test Mode: GFSK (CH High)

Tested by: Eve Wang

Ambient temperature: 24°C **Relative humidity:** 52% RH

Date: June 25, 2015

Frequency (MHz)	Reading (dBμV)	Correction Factor (dB/m)	Result (dBμV/m)	Limit (dBμV/m)	Margin (dB)	Antenna Pole (V/H)	Remark
2989.000	43.02	-1.38	41.64	74.00	-32.36	V	peak
4384.000	41.41	2.94	44.35	74.00	-29.65	V	peak
4960.000	45.90	4.85	50.75	74.00	-23.25	V	peak
6049.000	40.17	6.16	46.33	74.00	-27.67	V	peak
7156.000	39.72	8.00	47.72	74.00	-26.28	V	peak
7687.000	39.74	9.04	48.78	74.00	-25.22	V	peak
3232.000	42.41	-0.97	41.44	74.00	-32.56	H	peak
4150.000	42.28	2.12	44.40	74.00	-29.60	H	peak
4960.000	50.23	4.85	55.08	74.00	-18.92	H	peak
4960.000	48.04	4.85	52.89	54.00	-1.11	H	AVG
5329.000	41.51	5.57	47.08	74.00	-26.92	H	peak
5986.000	40.41	6.07	46.48	74.00	-27.52	H	peak
6859.000	39.82	7.47	47.29	74.00	-26.71	H	peak

REMARKS:

1. Measuring frequencies from 1 GHz to the 10th harmonic of highest fundamental frequency.
2. Radiated emissions measured in frequency above 1000MHz were made with an instrument using peak/average detector mode.
3. Average test would be performed if the peak result were greater than the average limit or as required by the applicant.
4. Data of measurement within this frequency range shown " --- " in the table above means the reading of emissions are attenuated more than 20dB below the permissible limits or the field strength is too small to be measured.
5. Measurements above show only up to 6 maximum emissions noted, or would be lesser, with " N/A " remark, if no specific emissions from the EUT are recorded (ie: margin>20dB from the applicable limit) and considered that's already beyond the background noise floor.
6. Margin (dB) = Remark result (dBuV/m) – Average limit (dBuV/m).



7.3. 6dB BANDWIDTH MEASUREMENT

7.3.1. LIMITS

According to §15.247(a)(2), systems using digital modulation techniques may operate in the 902 - 928 MHz, 2400 - 2483.5 MHz, and 5725 - 5850 MHz bands. The minimum 6 dB bandwidth shall be at least 500 kHz.

7.3.2. TEST INSTRUMENTS

Name of Equipment	Manufacturer	Model	Serial Number	Last Calibration	Calibration Due
Spectrum Analyzer	Agilent	N9010A	MY52221469	10/25/2014	10/24/2015

7.3.3. TEST PROCEDURES (please refer to measurement standard)

1. Place the EUT on the table and set it in the transmitting mode.
2. Remove the antenna from the EUT and then connect a low loss RF cable from the antenna port to the spectrum analyzer.
3. Set the spectrum analyzer as RBW = 100kHz, VBW = 300kHz, Span = 3MHz, Sweep = auto.
4. Mark the peak frequency and -6dB (upper and lower) frequency.
5. Repeat until all the rest channels are investigated.

7.3.4. TEST SETUP

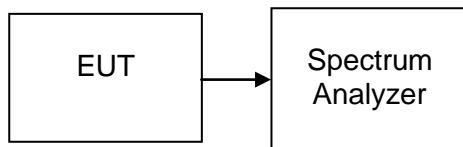

7.3.5. TEST RESULTS

No non-compliance noted

Test Data

Channel	Frequency (MHz)	Bandwidth (kHz)	Limit (kHz)	Margin (kHz)
Low	2402	506.6	>500	PASS
Mid	2440	509.7		PASS
High	2480	511.0		PASS



Test Plot

6dB Bandwidth (CH Low)

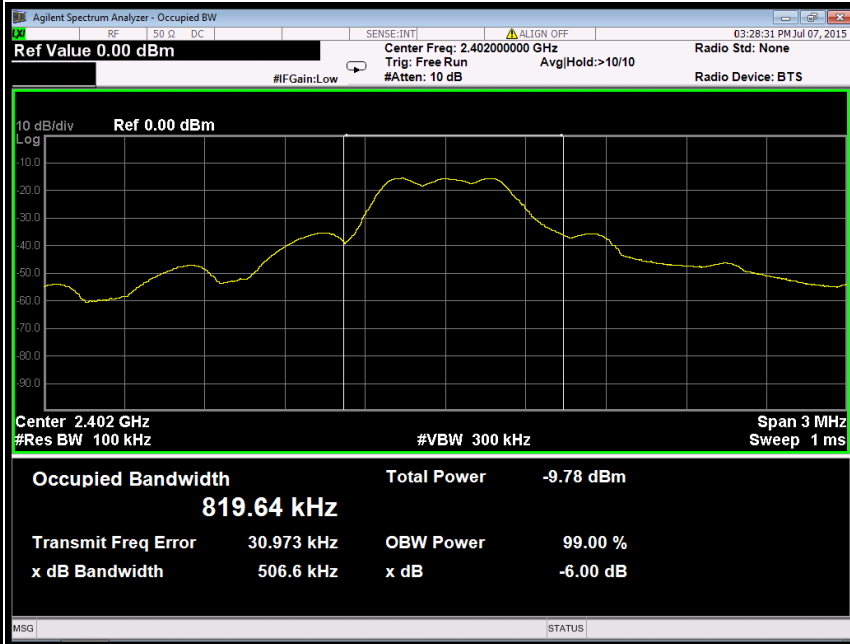

6dB Bandwidth (CH Mid)

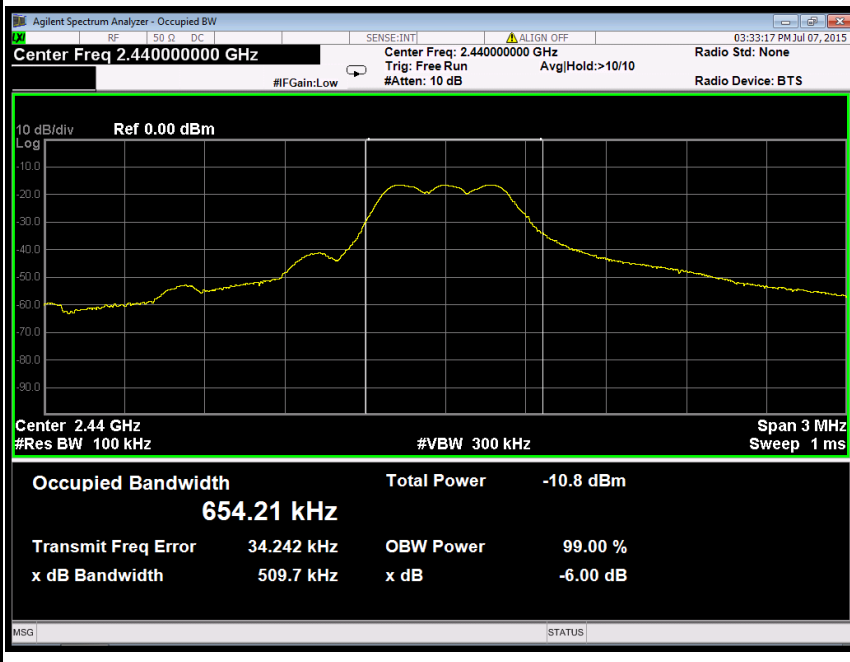

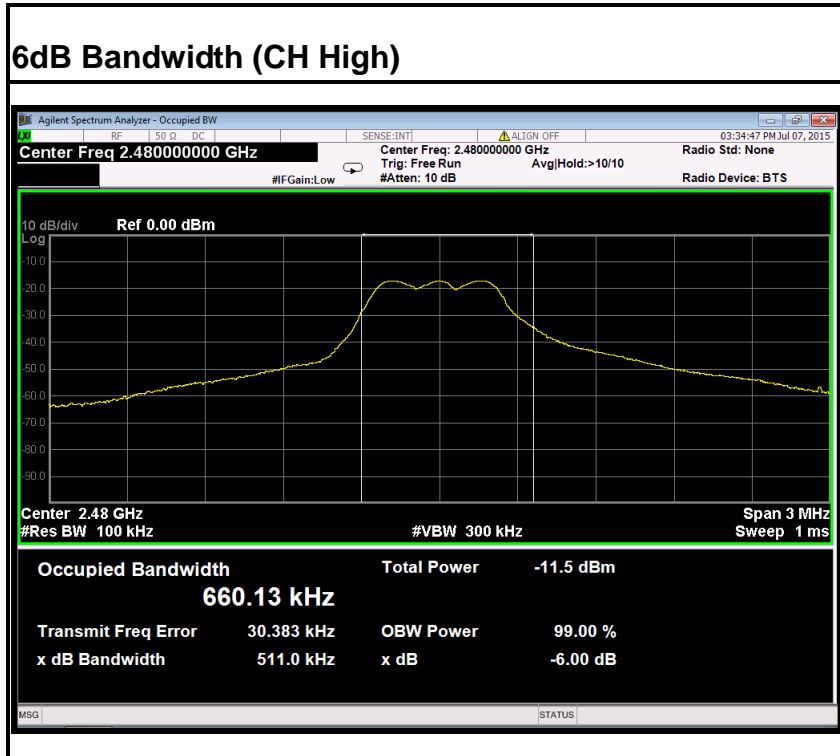



7.4. PEAK OUTPUT POWER

7.4.1. LIMITS

The maximum peak output power of the intentional radiator shall not exceed the following:

1. According to §15.247(b)(3), for systems using digital modulation in the bands of 902-928 MHz, 2400-2483.5 MHz: 1 Watt.
2. According to §15.247(b)(4), the conducted output power limit specified in paragraph (b) of this section is based on the use of antennas with directional gains that do not exceed 6 dBi. Except as shown in paragraph (c) of this section, if transmitting antennas of directional gain greater than 6 dBi are used, the conducted output power from the intentional radiator shall be reduced below the stated values in paragraphs (b)(1), (b)(2), and (b)(3) of this section, as appropriate, by the amount in dB that the directional gain of the antenna exceeds 6 dBi.

7.4.2. TEST INSTRUMENTS

Name of Equipment	Manufacturer	Model	Serial Number	Last Calibration	Calibration Due
Power Meter	Anritsu	ML2495A	1204003	02/28/2015	02/27/2016
Power Sensor	Anritsu	MA2411B	1126150	02/28/2015	02/27/2016

7.4.3. TEST PROCEDURES (please refer to measurement standard)

9.1.1 RBW \geq DTS bandwidth

This procedure shall be used when the measurement instrument has available a resolution bandwidth that is greater than the *DTS bandwidth*.

- a) Set the RBW \geq DTS bandwidth.
- b) Set VBW \geq 3 RBW.
- c) Set span \geq 3 x RBW
- d) Sweep time = auto couple.
- e) Detector = peak.
- f) Trace mode = max hold.
- g) Allow trace to fully stabilize.
- h) Use peak marker function to determine the peak amplitude level.



9.1.2 Integrated band power method

This procedure may be used when the maximum available RBW of the measurement instrument is less than the *DTS bandwidth*.

- a) Set the RBW = 1 MHz.
- b) Set the VBW \geq 3 RBW
- c) Set the span \geq 1.5 x DTS bandwidth.
- d) Detector = peak.
- e) Sweep time = auto couple.
- f) Trace mode = max hold.
- g) Allow trace to fully stabilize.
- h) Use the instrument's band/channel power measurement function with the band limits set equal to the DTS bandwidth edges (for some instruments, this may require a manual override to select peak detector). If the instrument does not have a band power function, sum the spectrum levels (in linear power units) at intervals equal to the RBW extending across the DTS bandwidth.

9.1.3 PKPM1 Peak power meter method

The maximum peak conducted output power may be measured using a broadband peak RF power meter. The power meter shall have a video bandwidth that is greater than or equal to the DTS bandwidth and shall utilize a fast-responding diode detector.



7.4.4. TEST SETUP

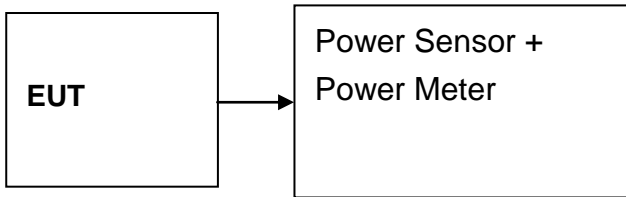

7.4.5. TEST RESULTS

No non-compliance noted

Test Data

Channel	Frequency (MHz)	Output Power (dBm)	Output Power (W)	Limit (W)	Result
Low	2402	-15.05	0.00003	1	PASS
Mid	2440	-15.51	0.00003		PASS
High	2480	-15.83	0.00003		PASS



7.5. BAND EDGES MEASUREMENT

7.5.1. LIMITS

According to §15.247(d), in any 100 kHz bandwidth outside the frequency bands in which the spread spectrum intentional radiator is operating, the radio frequency power that is produced by the intentional radiator shall be at least 20 dB below that in the 100 kHz bandwidth within the band that contains the highest level of the desired power, based on either an RF conducted or a radiated measurement, provided the transmitter demonstrates compliance with the peak conducted power limits. In addition, radiated emissions which fall in the restricted bands, as defined in §15.205(a), must also comply with the radiated emission limits specified in 15.209(a) (see Section 15.205(c)).

7.5.2. TEST INSTRUMENTS

Radiated Emission Test Site 966 (2)					
Name of Equipment	Manufacturer	Model Number	Serial Number	Last Calibration	Due Calibration
PSA Series Spectrum Analyzer	Agilent	E4446A	US44300399	02/28/2015	02/27/2016
EMI TEST RECEIVER	ROHDE&SCHWARZ	ESCI	100783	02/28/2015	02/27/2016
Amplifier	MITEQ	AM-1604-3000	1123808	03/18/2015	03/18/2016
High Noise Amplifier	Agilent	8449B	3008A01838	02/28/2015	02/27/2016
Board-Band Horn Antenna	Schwarzbeck	BBHA 9170	9170-497	02/28/2015	02/27/2016
Bilog Antenna	SCHAFFNER	CBL6143	5082	02/28/2015	02/27/2016
Horn Antenna	SCHWARZBECK	BBHA9120	D286	02/28/2015	02/27/2016
Loop Antenna	COM-POWER	AL-130	121044	09/25/2014	09/24/2015
Turn Table	N/A	N/A	N/A	N.C.R	N.C.R
Controller	Sunol Sciences	SC104V	022310-1	N.C.R	N.C.R
Controller	CT	N/A	N/A	N.C.R	N.C.R
Temp. / Humidity Meter	Anymetre	JR913	N/A	02/28/2015	02/27/2016
Antenna Tower	SUNOL	TLT2	N/A	N.C.R	N.C.R
Test S/W	FARAD	LZ-RF / CCS-SZ-3A2			

- NOTE:**
1. The calibration interval of the above test instruments is 12 months and the calibrations are traceable to NML/ROC and NIST/USA.
 2. The FCC Site Registration number is 101879.
 3. N.C.R = No Calibration Required.



7.5.3. TEST PROCEDURES (please refer to measurement standard)

1. The EUT is placed on a turntable, which is 0.8m above the ground plane.
2. The turntable shall be rotated for 360 degrees to determine the position of maximum emission level.
3. EUT is set 3m away from the receiving antenna, which is varied from 1m to 4m to find out the highest emission.
4. Set the spectrum analyzer in the following setting in order to capture the lower and upper band-edges of the emission:
 - (a) PEAK: RBW=1MHz / VBW=3MHz / Sweep=AUTO
 - (b) AVERAGE: RBW=1MHz / VBW=3MHz / Sweep=AUTO / Detector = RMS
5. Repeat the procedures until all the PEAK and AVERAGE versus POLARIZATION are

7.5.4. TEST SETUP

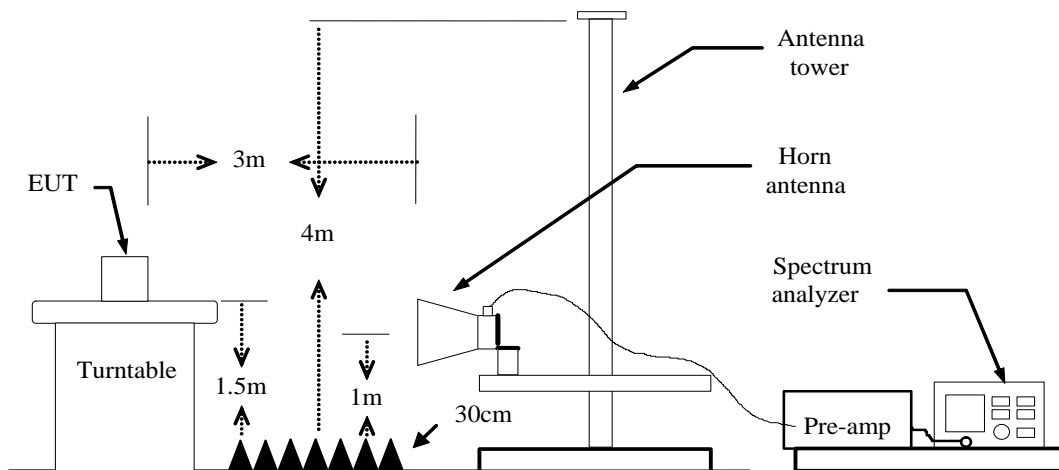



7.5.5. TEST RESULTS

Test Plot

Band Edges (CH Low)

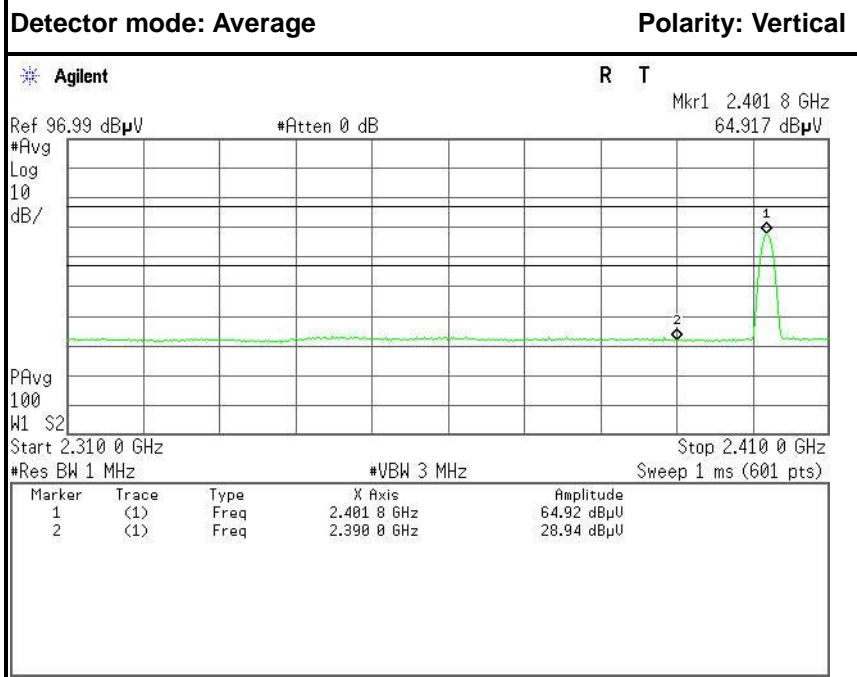
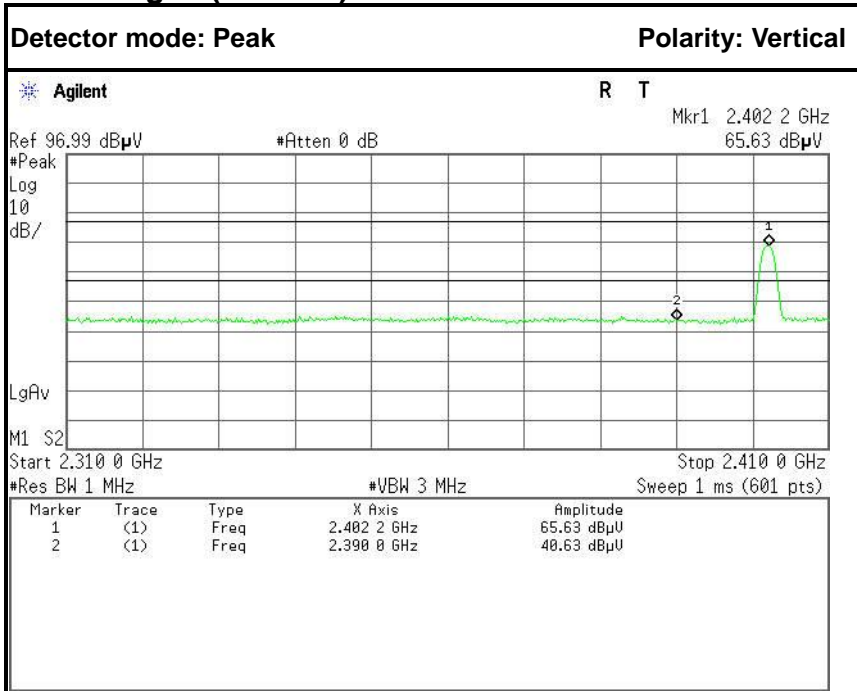

No.	Frequency (MHz)	Reading (dBuV)	Corrected (dB)	Result (dBuV)	Limit (dBuV)	Margin (dB)	Detector	Antenna Pole
1	2390.0000	34.03	-6.60	40.63	74.00	-33.37	Peak	Vertical
2	2390.0000	22.34	-6.60	28.94	54.00	-25.06	Average	Vertical

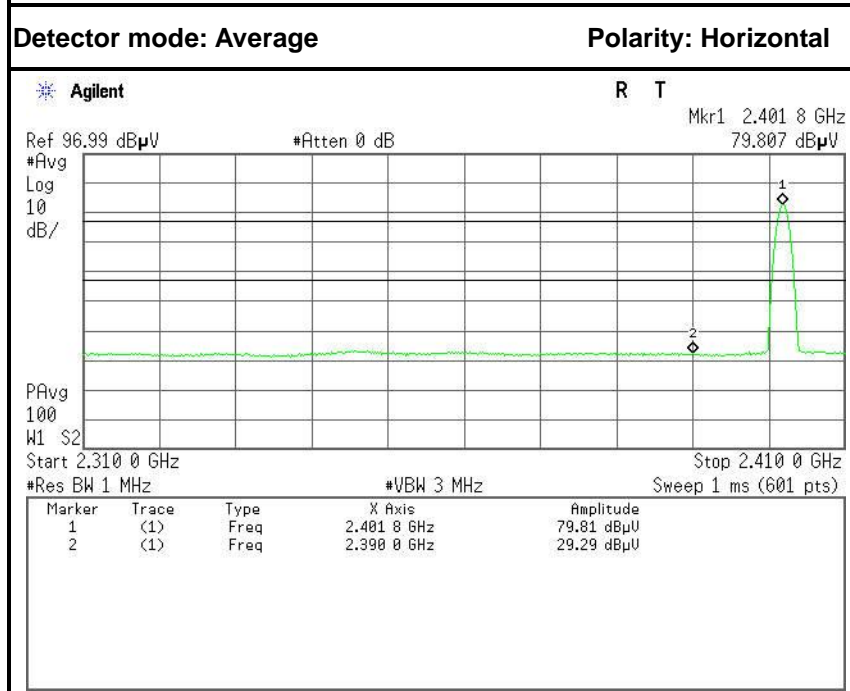
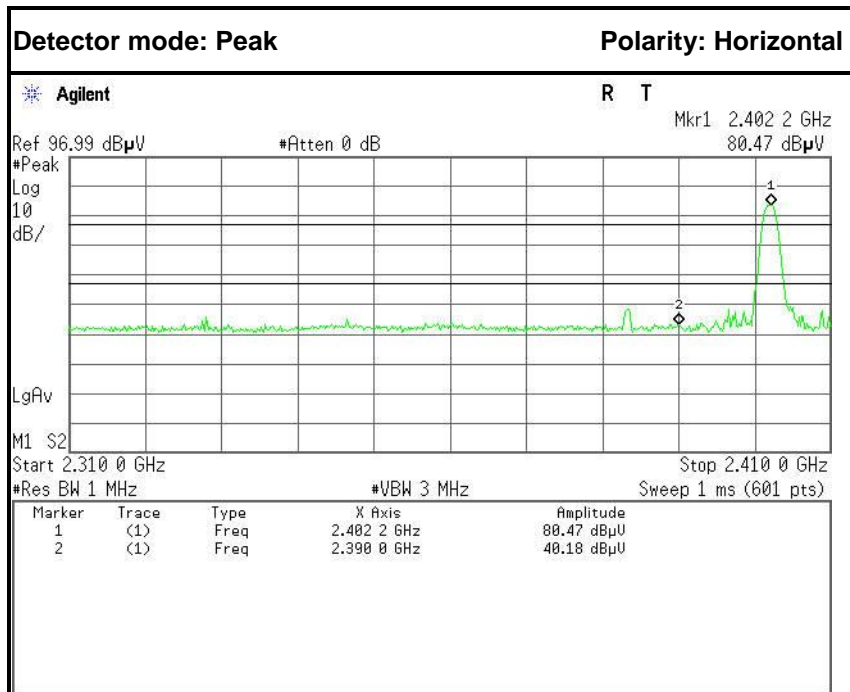

No.	Frequency (MHz)	Reading (dBuV)	Corrected (dB)	Result (dBuV)	Limit (dBuV)	Margin (dB)	Detector	Antenna Pole
1	2390.0000	33.58	-6.60	40.18	74.00	-33.82	Peak	Horizontal
2	2390.0000	22.69	-6.60	29.29	54.00	-24.71	Average	Horizontal



Band Edges (CH-High)

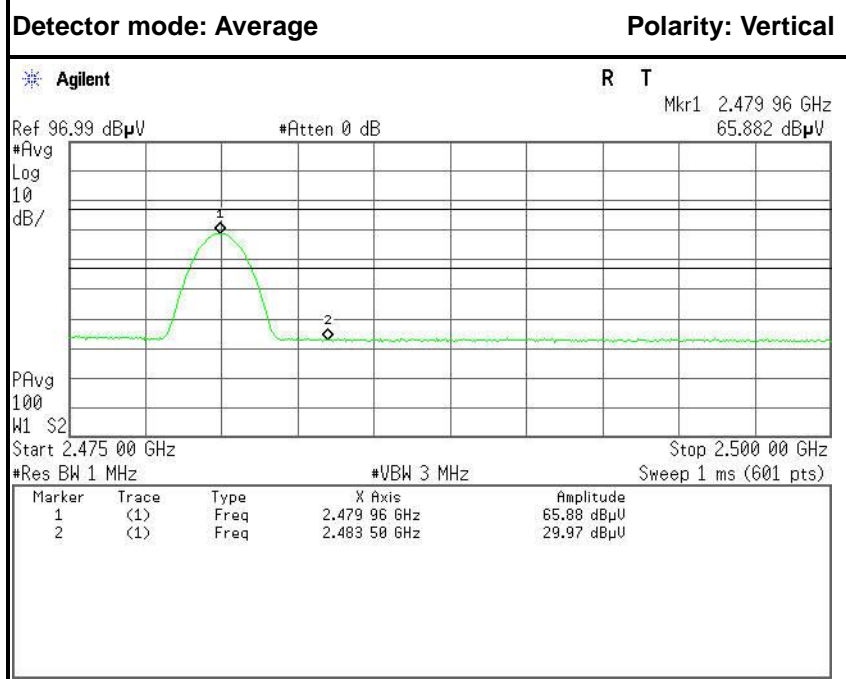
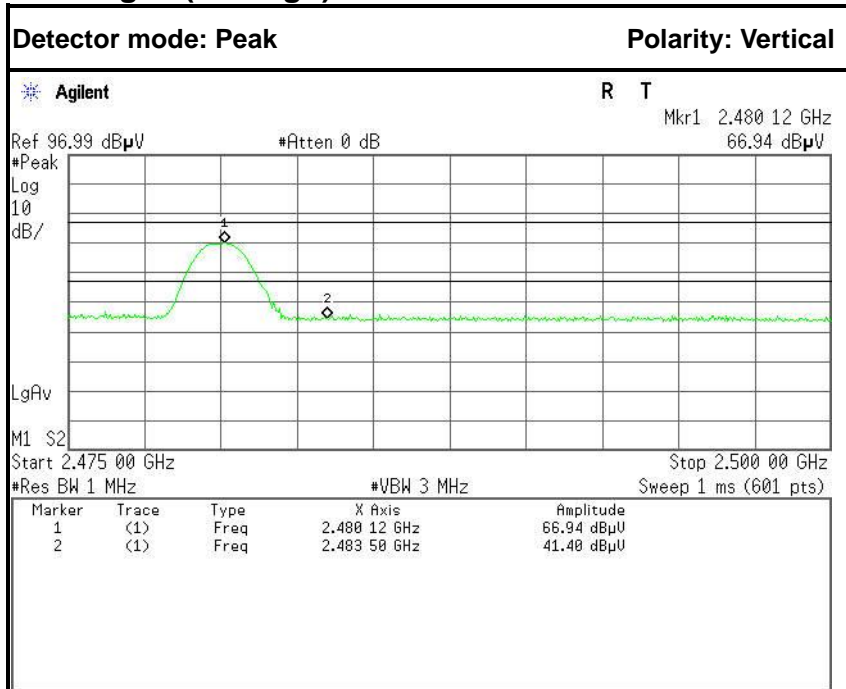

No.	Frequency (MHz)	Reading (dB μ V)	Corrected (dB)	Result (dB μ V)	Limit (dB μ V)	Margin (dB)	Detector	Antenna Pole
1	2483.5000	35.16	-6.24	41.40	74.00	-32.60	Peak	Vertical
2	2483.5000	23.73	-6.24	29.97	54.00	-24.03	Average	Vertical

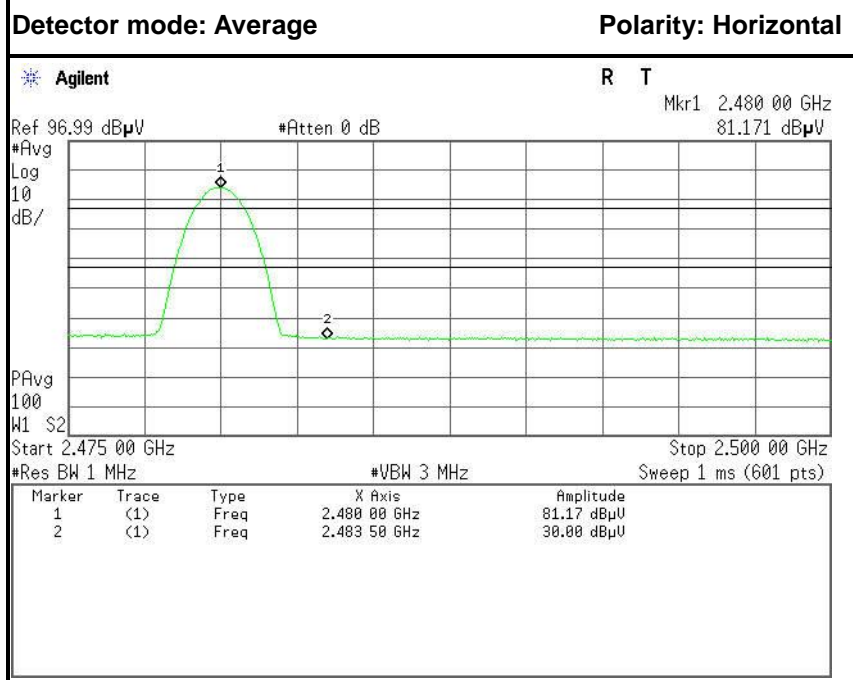
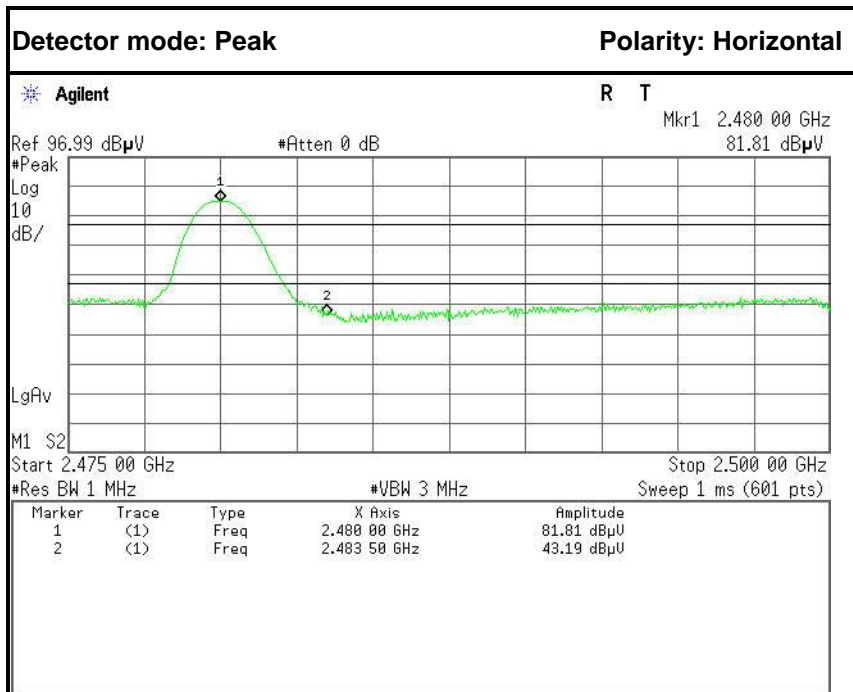

No.	Frequency (MHz)	Reading (dBuV)	Corrected (dB)	Result (dBuV)	Limit (dBuV)	Margin (dB)	Detector	Antenna Pole
1	2483.5000	36.95	-6.24	43.19	74.00	-30.81	Peak	Horizontal
2	2483.5000	23.76	-6.24	30.00	54.00	-24.00	Average	Horizontal



7.6. PEAK POWER SPECTRAL DENSITY MEASUREMENT

7.6.1. LIMITS

According to §15.247(e), for digitally modulated systems, the power spectral density conducted from the intentional radiator to the antenna shall not be greater than 8 dBm in any 3 kHz band during any time interval of continuous transmission.

According to §15.247(f), the digital modulation operation of the hybrid system, with the frequency hopping turned off, shall comply with the power density requirements of paragraph (d) of this section.

7.6.2. TEST INSTRUMENTS

Name of Equipment	Manufacturer	Model	Serial Number	Last Calibration	Calibration Due
Spectrum Analyzer	Agilent	N9010A	MY52221469	10/25/2014	10/24/2015

7.6.3. TEST PROCEDURES (please refer to measurement standard)

1. Set analyzer center frequency to DTS channel center frequency.
2. Set the span to 1.5 times the DTS bandwidth.
3. Set the RBW to: $3 \text{ kHz} \leq \text{RBW} \leq 100 \text{ kHz}$.
4. Set the VBW $\geq 3 \text{ RBW}$.
5. Detector = peak.
6. Sweep time = auto couple.
7. Trace mode = max hold.
8. Allow trace to fully stabilize.
9. Use the peak marker function to determine the maximum amplitude level within the RBW.
10. If measured value exceeds limit, reduce RBW (no less than 3 kHz) and repeat.

7.6.4. TEST SETUP

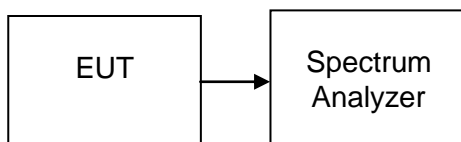



7.6.5. TEST RESULTS

No non-compliance noted

Test Data

Channel	Frequency (MHz)	PPSD (dBm)	Limit (dBm)	Test Result
Low	2402	-25.544	8.00	PASS
Mid	2440	-24.508		PASS
High	2480	-26.020		PASS



Test Plot

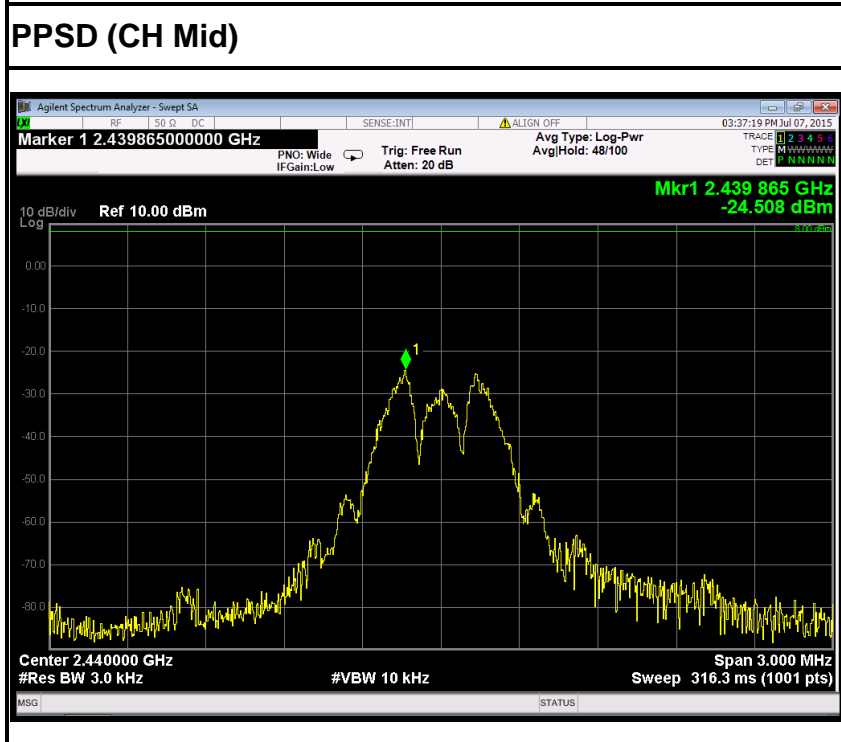
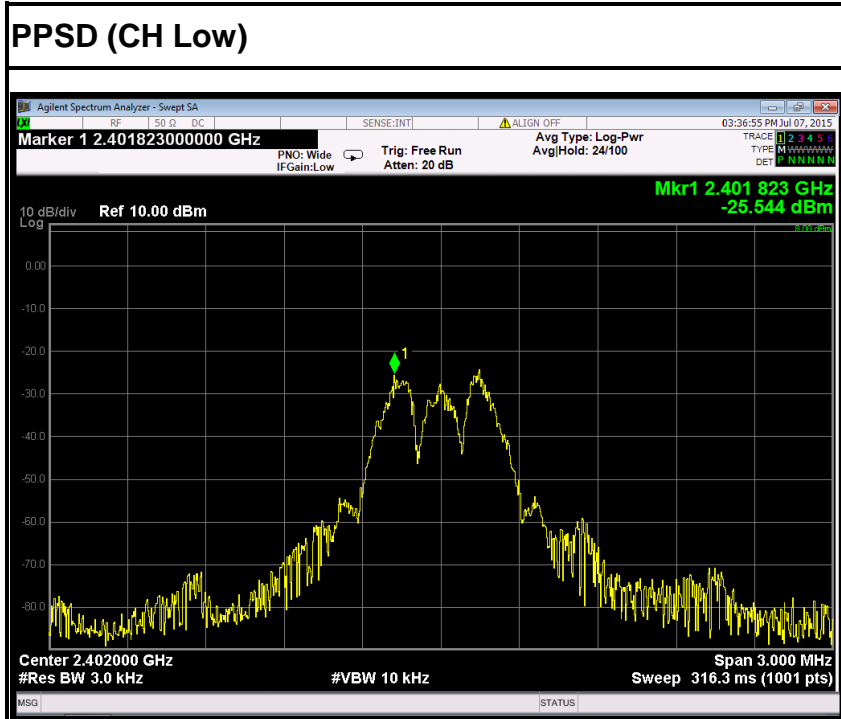

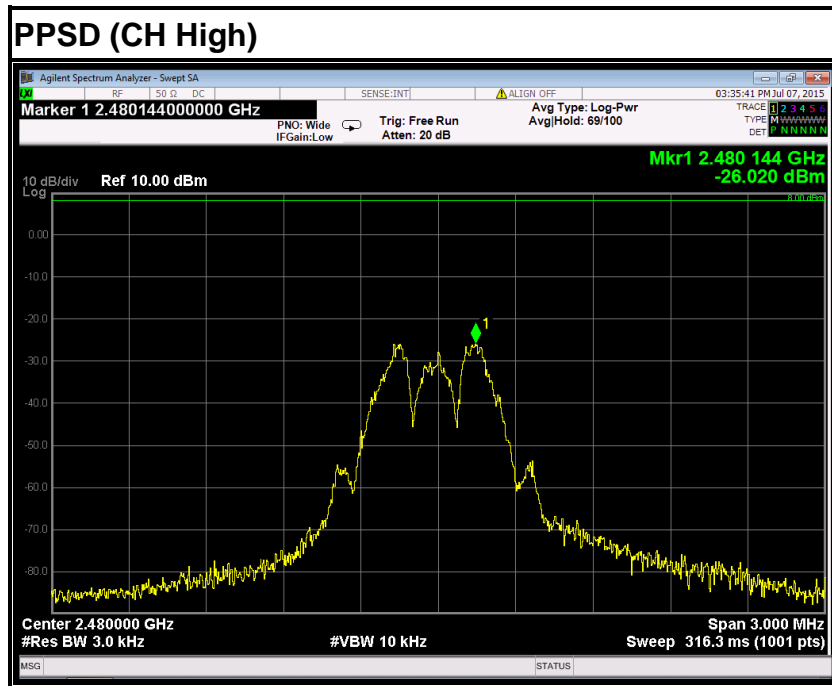



7.7. ANTENNA GAIN

MEASUREMENT

The antenna gain of the complete system is calculated by the difference of radiated power in EIRP and the conducted power of the module. For normal BT devices, the GFSK mode is used.

MEASUREMENT PARAMETERS

Measurement parameter	
Detector	Peak
Sweep time	Auto
Resolution bandwidth	3 MHz
Video bandwidth	3 MHz
Trace-Mode	Max hold

LIMITS

FCC	IC
Antenna Gain	
6 dBi	

TEST RESULTS

GFSK

T_{nom}	V_{nom}	Lowest channel	Middle channel	Highest channel
		2402MHz	2440MHz	2480MHz
Conducted power [dBm] Measured with GFSK modulation		-15.05	-15.51	-15.83
Radiated power [dBm] Measured with GFSK modulation		-14.83	-14.16	-14.49
Gain [dBi] Calculated		0.22	1.35	1.34
Measurement uncertainty		± 1.5 dB (cond.) / ± 3 dB (rad.)		