

SECURITY CAMERA SYSTEM

M9310 TRANSMITTER

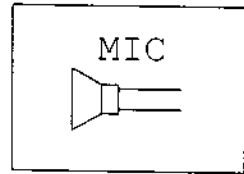

DIRECTIONAL ANTENNA

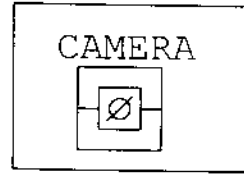
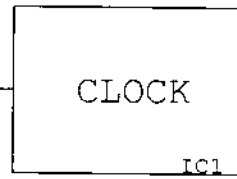
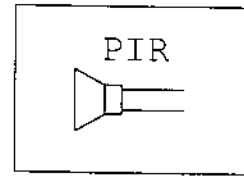
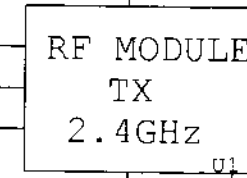

SDA

SCL

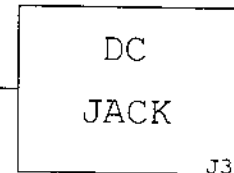
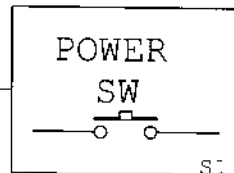
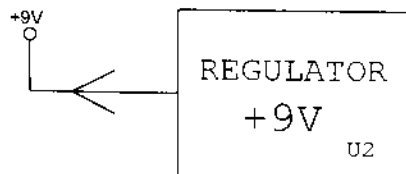
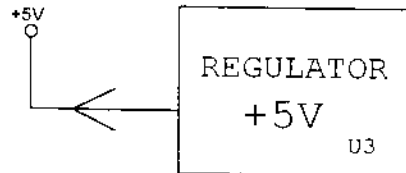
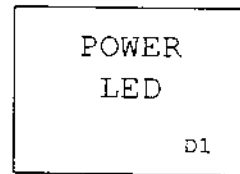
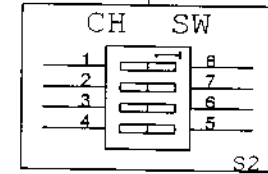
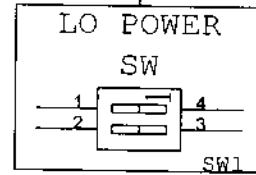

DC12V

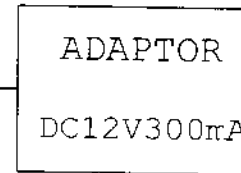

Title		
(Title)		
MINGJONG		
Size	Document Number	Rev
A	{Doc}	
M9310 BLOCK		
Date:	Friday, October 27, 2000	Sheet 1 of 1

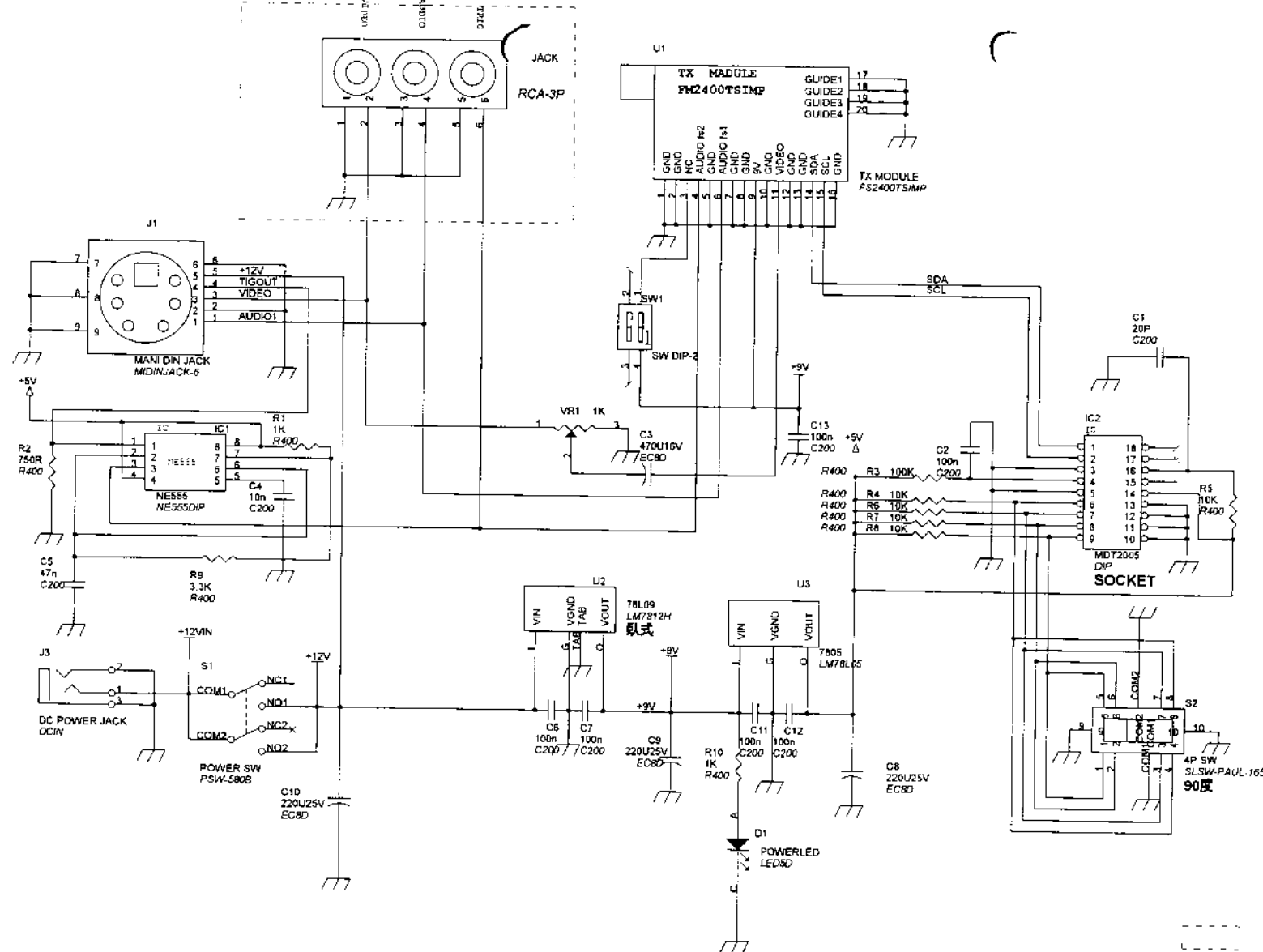

虛線部份不焊即為M9310

Title			JIMMY/R&D/MINGJONG		
Size	Document Number		Rev		
B	M9310mainboard		A		
Date:	Friday, October 23, 2000	Sheet	1	of	1

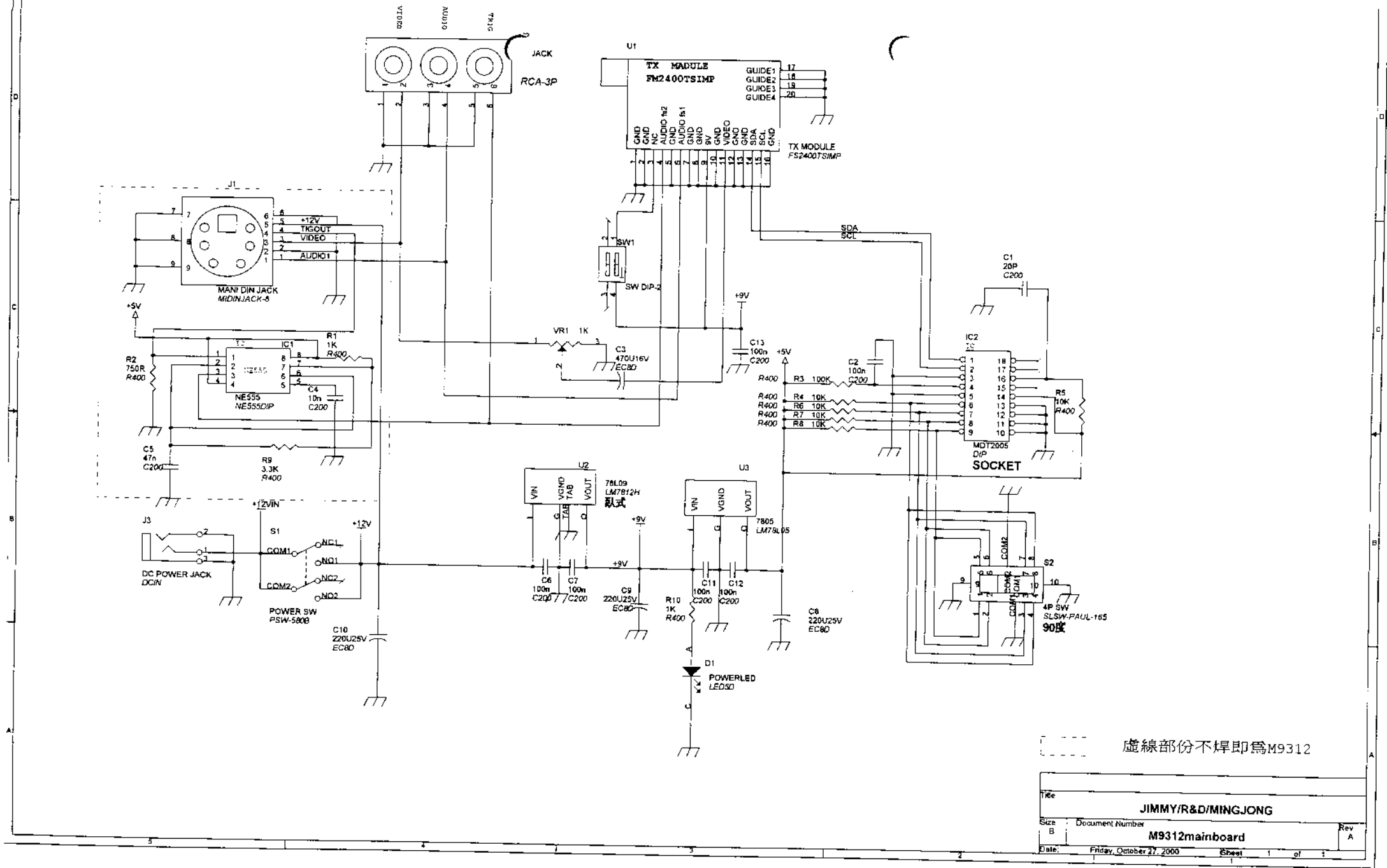

Title			JIMMY/R&D/MINGJONG		
Size	Document Number				Rev
B	M9312mainboard				A
Date:	Friday, October 27, 2000	Sheet	1	of	1

M9312 TRANSMITTER

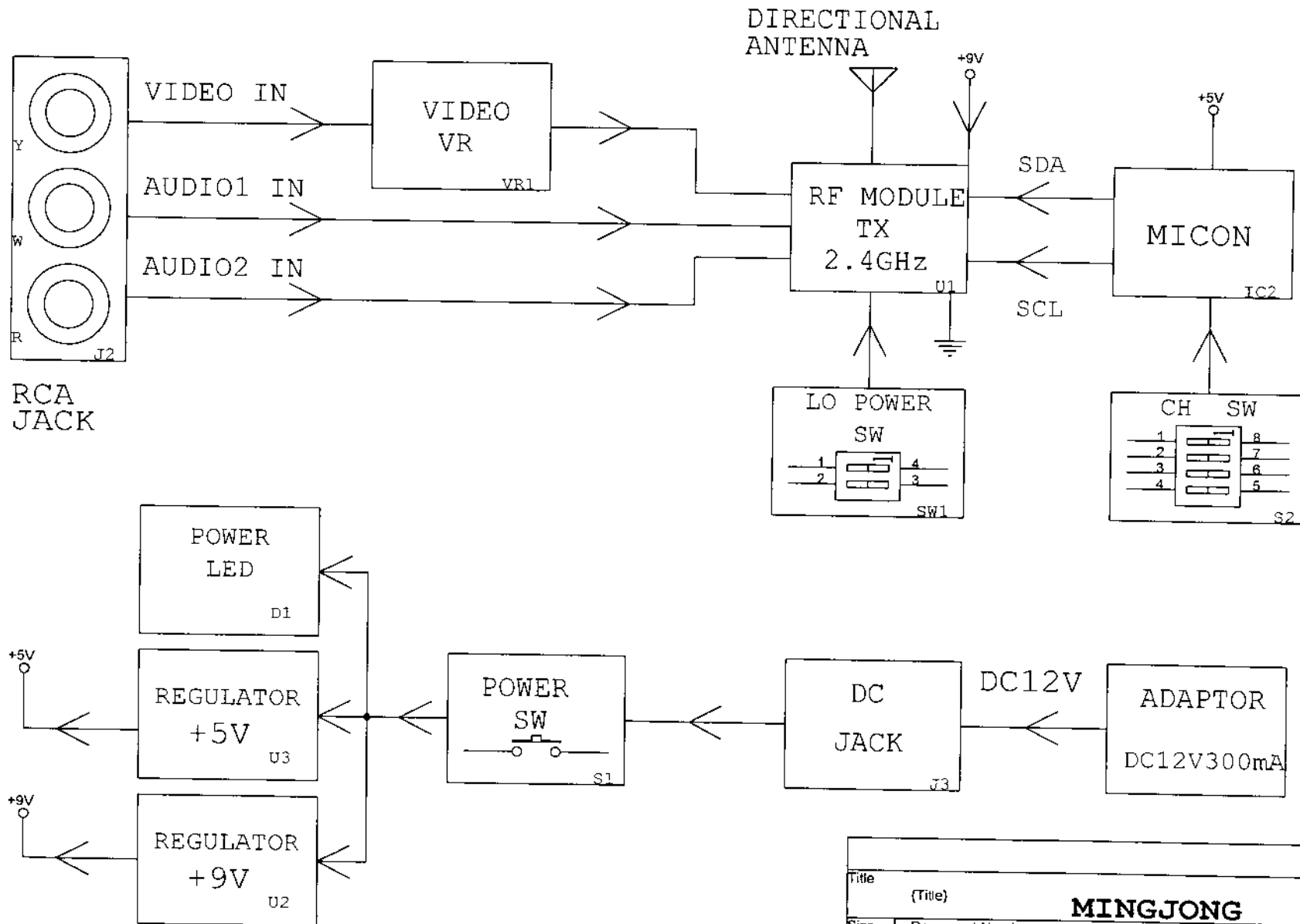

Title		
(Title)		
MINGJONG		
Size	Document Number	Rev
A	{Doc}	
M9312 BLOCK		
Date:	Saturday, November 04, 2000	Sheet 1 of 1