

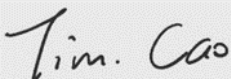
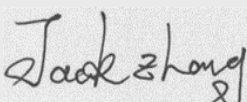

Test report No:
22A0151R-RF-US-P03V02

SAR TEST REPORT

| | |
|---|--|
| Product Name | AH80 Bluetooth Headset Dongle |
| Trademark | Alcatel-Lucent Enterprise |
| Model and /or type reference | AH80 |
| FCC ID | OL3AH80DONGLE |
| IC | 1737D-AH80DONGLE |
| Applicant's name / address | ALE International 32, Avenue Kléber – 92700 Colombes – FRANCE |
| Test method requested, standard | FCC KDB Publication 248227 D01v02r02 FCC KDB Publication 447498 D04v01 FCC KDB Publication 447498 D02v01 FCC KDB Publication 865664 D01v01r04 BS IEC/IEEE 62209-1528-2020 FCC 47CFR §2.1093 ANSI C95.1-2005 RSS - 102 Issue 5: 2015 |
| Test Result | MAX Body SAR 1g SAR Bluetooth: 0.429W/kg |
| Verdict Summary | IN COMPLIANCE |
| Documented by (name / position & signature) | Tim Cao /Project Engineer  |
| Approved by (name / position & signature) | Jack Zhang/Manager  |
| Date of issue | 2022-11-11 |

| | |
|--------------------|--------------------------|
| Report Version | V1.1 |
| Report template No | Template_FCC SAR-RF-V1.0 |

INDEX

Page

COMPETENCES AND GUARANTEES 5

GENERAL CONDITIONS..... 5

ENVIRONMENTAL CONDITIONS 6

POSSIBLE TEST CASE VERDICTS 6

DOCUMENT HISTORY 7

REMARKS AND COMMENTS 7

1 GENERAL INFORMATION 8

1.1 GENERAL DESCRIPTION OF THE ITEM(S) 8

1.2 ANTENNA INFORMATION 10

1.3 CHANNEL LIST 11

2 SAR MEASUREMENT SYSTEM..... 14

2.1 DASY5 SYSTEM DESCRIPTION 14

2.1.1 Applications 15

2.1.2 Area Scans 15

2.1.3 Zoom Scan (Cube Scan Averaging)..... 15

2.1.4 Uncertainty of Inter-/Extrapolation and Averaging..... 16

2.2 DASY5 E-FIELD PROBE 17

2.3 BOUNDARY DETECTION UNIT AND PROBE MOUNTING DEVICE..... 18

2.4 DATA ACQUISITION ELECTRONICS (DAE) AND MEASUREMENT SERVER 18

2.5 ROBOT 19

2.6 LIGHT BEAM UNIT 19

2.7 DEVICE HOLDER..... 20

2.8 SAM TWIN PHANTOM..... 20

3 TISSUE SIMULATING LIQUID..... 21

3.1 THE COMPOSITION OF THE TISSUE SIMULATING LIQUID 21

3.2 TISSUE CALIBRATION RESULT 22

3.3 TISSUE DIELECTRIC PARAMETERS FOR HEAD AND BODY PHANTOMS 25

4 SAR MEASUREMENT PROCEDURE 26

4.1 SAR SYSTEM VALIDATION 26

4.1.1 Validation Dipoles..... 26

4.1.2 Validation Result 27

| | | |
|--------|---|----|
| 4.2 | SAR MEASUREMENT PROCEDURE | 28 |
| 4.3 | SAR MEASUREMENT PROCEDURE | 29 |
| 4.3.1. | <i>Duty Factor Control</i> | 29 |
| 4.3.2. | <i>Initial Test Position SAR Test Reduction Procedure</i> | 29 |
| 5 | SAR EXPOSURE LIMITS | 30 |
| 6 | TEST EQUIPMENT LIST | 31 |
| 7 | MEASUREMENT UNCERTAINTY | 32 |
| 8 | CONDUCTED POWER MEASUREMENT | 35 |
| 9 | TEST PROCEDURES | 37 |
| 9.1 | SAR TEST RESULTS SUMMARY | 37 |
| 9.2 | TEST POSITION AND CONFIGURATION | 38 |
| | APPENDIX A. SAR SYSTEM VALIDATION DATA | 39 |
| | APPENDIX B. SAR MEASUREMENT DATA | 40 |
| | APPENDIX C. PROBE CALIBRATION DATA | 47 |
| | APPENDIX D. DIPOLE CALIBRATION DATA | 56 |
| | APPENDIX E. DAE CALIBRATION DATA | 62 |

COMPETENCES AND GUARANTEES

DEKRA is a testing laboratory competent to carry out the tests described in this report.

In order to assure the traceability to other national and international laboratories, DEKRA has a calibration and Maintenance program for its measurement equipment.

DEKRA guarantees the reliability of the data presented in this report, which is the result of the measurements and the tests performed to the item under test on the date and under the conditions stated in the report and it is based on the knowlEdge and technical facilities available at DEKRA at the time of performance of the test.

DEKRA is liable to the client for the Maintenance of the confidentiality of all information related to the item under test and the results of the test.

The results presented in this Test Report apply only to the particular item under test established in this document.

IMPORTANT: No parts of this report may be reproduced or quoted out of context, in any form or by any means, except in full, without the previous written permission of DEKRA.

GENERAL CONDITIONS

| | |
|----------------------|--|
| Test Location | No. 99, Hongye Road, Suzhou Industrial Park Suzhou, 215006, P.R. China |
| Date(receive sample) | Jun. 22, 2022 |
| Date (start test) | Oct. 18, 2022 |
| Date (finish test) | Nov 05, 2022 |

1. This report is only referred to the item that has undergone the test.
2. This report does not constitute or imply on its own an approval of the product by the Certification Bodies or Competent Authorities.
3. This document is only valid if complete; no partial reproduction can be made without previous written permission of DEKRA.
4. This test report cannot be used partially or in full for publicity and/or promotional purposes without previous written permission of DEKRA.

ENVIRONMENTAL CONDITIONS

The climatic conditions during the tests are within the limits specified by the manufacturer for the operation of the EUT and the test equipment. The climatic conditions during the tests were within the following limits:

| | |
|-----------------------|---------------|
| Ambient temperature | 18 °C – 25 °C |
| Relative Humidity air | 30% - 60% |

If explicitly required in the basic standard or applied product / product family standard the climatic values are recorded and documented separately in this test report.

POSSIBLE TEST CASE VERDICTS

| | |
|---|-----------------|
| Test case does not apply to test object | N/A |
| Test object does meet requirement | P (Pass) / PASS |
| Test object does not meet requirement | F (Fail) / FAIL |
| Not measured | N/M |



DOCUMENT HISTORY

| Report No. | Version | Description | Issued Date |
|-----------------------|---------|---|-------------|
| 22A0151R-RF-US-P03V02 | V1.0 | Initial issue of report. | 2022-11-08 |
| 22A0151R-RF-US-P03V02 | V1.1 | Page11 Added FCC Designation Number, ISED CAB identifier. | 2022-11-11 |
| | | | |
| | | | |
| | | | |
| | | | |

REMARKS AND COMMENTS

1. The equipment under test (EUT) does meet the essential requirements of the stated standard(s)/test(s).
2. These test results on a sample of the device are for the purpose of demonstrating Compliance with FCC KDB Publication 248227 D01v02r02, FCC KDB Publication 447498 D04v01, FCC KDB Publication 447498 D02v01, FCC KDB Publication 865664 D01v01r04, BS IEC/IEEE 62209-1528-2020, FCC 47CFR §2.1093, ANSI C95.1-2005, RSS 102: Issue 5.
3. The measurement result is considered in conformance with the requirement if it is within the prescribed limit, It is not necessary to account the uncertainty associated with the measurement result.
4. The test results presented in this report relate only to the object tested.
5. The test report shall not be reproduced without the written approval of DEKRA Testing and Certification (Suzhou) Co., Ltd.
6. This report will not be used for social proof function in China market.
7. DEKRA declines any responsibility with the following test data provided by customer that may affect the validity of result:
 - Chapter 1.1 General Description of the Item(s);
 - Chapter 1.2 Antenna Informaion;
 - Chapter 1.3 Channel List.



1 General Information

1.1 General Description of the Item(s)

| | |
|----------------------------|---|
| Product Name | AH80 Bluetooth Headset Dongle |
| Model No. | AH80 |
| FCC ID | OL3AH80DONGLE |
| IC | 1737D-AH80DONGLE |
| Hardware version..... | V1.0 |
| Software version | V1.10.8 |
| Firmware version | N/A |
| HVIN | AH80DONGLE |
| Manufacturer..... | ALE International |
| Manufacturer Address | 32, Avenue Kléber – 92700 Colombes – FRANCE |
| SAR Tests..... | #1 Sample |
| Model differences | NA |

| | | | | | | |
|-----------------------------------|-------------------------------------|---------|-------------------------------------|------------|-------------------------------------|---------|
| Wireless specification | Bluetooth | | | | | |
| Bluetooth Specification | V3.0 | | | | | |
| Operating frequency range(s)..... | 2400~2483.5MHz | | | | | |
| Type of Modulation | GFSK | | | | | |
| PHYS..... | <input checked="" type="checkbox"/> | GFSK | <input checked="" type="checkbox"/> | Pi/4 DQPSK | <input checked="" type="checkbox"/> | 8DPSK |
| Data Rate..... | <input checked="" type="checkbox"/> | 1Mbit/s | <input checked="" type="checkbox"/> | 2Mbit/s | <input checked="" type="checkbox"/> | 3Mbit/s |
| Number of channel | 79 | | | | | |

| | | | | | | |
|-----------------------------------|-------------------------------------|---------|-------------------------------------|---------|--------------------------|----------------|
| Wireless specification | Bluetooth 5.0 | | | | | |
| Operating frequency range(s)..... | 2400~2483.5MHz | | | | | |
| Type of Modulation | GFSK | | | | | |
| PHYS..... | <input checked="" type="checkbox"/> | LE 1M | <input checked="" type="checkbox"/> | LE 2M | <input type="checkbox"/> | LE Coded S=2/8 |
| Data Rate..... | <input checked="" type="checkbox"/> | 1Mbit/s | <input checked="" type="checkbox"/> | 2Mbit/s | <input type="checkbox"/> | 500/125 Kbit/s |
| Number of channel | 40 | | | | | |

| | | |
|--------------------------|-------------------------------------|--------------------------------|
| Rated power supply | Voltage and Frequency | |
| | <input type="checkbox"/> | AC: 220 – 240 V, 50/60 Hz |
| | <input type="checkbox"/> | AC: 100 – 240 V, 50/60 Hz |
| | <input type="checkbox"/> | Battery:3.7V |
| | <input checked="" type="checkbox"/> | DC:5V |
| Mounting position..... | <input type="checkbox"/> | Table top equipment |
| | <input type="checkbox"/> | Wall/Ceiling mounted equipment |
| | <input type="checkbox"/> | Floor standing equipment |
| | <input type="checkbox"/> | Head-mounted equipment |
| | <input checked="" type="checkbox"/> | Other:Bluetooth Headset Dongle |



1.2 Antenna Information

| | | | |
|----------------------------------|-------------------------------------|---|---------------------------------------|
| Antenna model / type number..... | N/A | | |
| Antenna serial number..... | N/A | | |
| Antenna Delivery | <input checked="" type="checkbox"/> | 1TX + 1RX | |
| | <input type="checkbox"/> | 2TX + 2RX | |
| | <input type="checkbox"/> | Others:..... | |
| Antenna technology | <input checked="" type="checkbox"/> | SISO | |
| | <input type="checkbox"/> | MIMO | <input type="checkbox"/> CDD |
| | | | <input type="checkbox"/> Beam-forming |
| Antenna Type | <input type="checkbox"/> | External | <input type="checkbox"/> Dipole |
| | | | <input type="checkbox"/> Sectorized |
| | | | <input checked="" type="checkbox"/> |
| | <input checked="" type="checkbox"/> | <input checked="" type="checkbox"/> PCB | |
| | <input type="checkbox"/> | <input type="checkbox"/> Dipole | |
| | <input type="checkbox"/> | <input type="checkbox"/> Others..... | |
| Antenna Gain | 3.2 dBi | | |

1.3 Channel List

For Bluetooth

| Bluetooth Working Frequency of Each Channel: (FHSS) | | | | | | | |
|---|-----------|---------|-----------|---------|-----------|---------|-----------|
| Channel | Frequency | Channel | Frequency | Channel | Frequency | Channel | Frequency |
| 00 | 2402 MHz | 01 | 2403 MHz | 02 | 2404 MHz | 03 | 2405 MHz |
| 04 | 2406 MHz | 05 | 2407 MHz | 06 | 2408 MHz | 07 | 2409 MHz |
| 08 | 2410 MHz | 09 | 2411 MHz | 10 | 2412 MHz | 11 | 2413 MHz |
| 12 | 2414 MHz | 13 | 2415 MHz | 14 | 2416 MHz | 15 | 2417 MHz |
| 16 | 2418 MHz | 17 | 2419 MHz | 18 | 2420 MHz | 19 | 2421 MHz |
| 20 | 2422 MHz | 21 | 2423 MHz | 22 | 2424 MHz | 23 | 2425 MHz |
| 24 | 2426 MHz | 25 | 2427 MHz | 26 | 2428 MHz | 27 | 2429 MHz |
| 28 | 2430 MHz | 29 | 2431 MHz | 30 | 2432 MHz | 31 | 2433 MHz |
| 32 | 2434 MHz | 33 | 2435 MHz | 34 | 2436 MHz | 35 | 2437 MHz |
| 36 | 2438 MHz | 37 | 2439 MHz | 38 | 2440 MHz | 39 | 2441 MHz |
| 40 | 2442 MHz | 41 | 2443 MHz | 42 | 2444 MHz | 43 | 2445 MHz |
| 44 | 2446 MHz | 45 | 2447 MHz | 46 | 2448 MHz | 47 | 2449 MHz |
| 48 | 2450 MHz | 49 | 2451 MHz | 50 | 2452 MHz | 51 | 2453 MHz |
| 52 | 2454 MHz | 53 | 2455 MHz | 54 | 2456 MHz | 55 | 2457 MHz |
| 56 | 2458 MHz | 57 | 2459 MHz | 58 | 2460 MHz | 59 | 2461 MHz |
| 60 | 2462 MHz | 61 | 2463 MHz | 62 | 2464 MHz | 63 | 2465 MHz |
| 64 | 2466 MHz | 65 | 2467 MHz | 66 | 2468 MHz | 67 | 2469 MHz |
| 68 | 2470 MHz | 69 | 2471 MHz | 70 | 2472 MHz | 71 | 2473 MHz |
| 72 | 2474 MHz | 73 | 2475 MHz | 74 | 2476 MHz | 75 | 2477 MHz |
| 76 | 2478 MHz | 77 | 2479 MHz | 78 | 2480 MHz | N/A | N/A |

| Bluetooth Working Frequency of Each Channel: (BT 5.0) | | | | | | | |
|---|-----------|---------|-----------|---------|-----------|---------|-----------|
| Channel | Frequency | Channel | Frequency | Channel | Frequency | Channel | Frequency |
| 00 | 2402 MHz | 01 | 2404 MHz | 02 | 2406 MHz | 03 | 2408 MHz |
| 04 | 2410 MHz | 05 | 2412 MHz | 06 | 2414 MHz | 07 | 2416 MHz |
| 08 | 2418 MHz | 09 | 2420 MHz | 10 | 2422 MHz | 11 | 2424 MHz |
| 12 | 2426 MHz | 13 | 2428 MHz | 14 | 2430 MHz | 15 | 2432 MHz |
| 16 | 2434 MHz | 17 | 2436 MHz | 18 | 2438 MHz | 19 | 2440 MHz |
| 20 | 2442 MHz | 21 | 2444 MHz | 22 | 2446 MHz | 23 | 2448 MHz |
| 24 | 2450 MHz | 25 | 2452 MHz | 26 | 2454 MHz | 27 | 2456 MHz |
| 28 | 2458 MHz | 29 | 2460 MHz | 30 | 2462 MHz | 31 | 2464 MHz |
| 32 | 2466 MHz | 33 | 2468 MHz | 34 | 2470 MHz | 35 | 2472 MHz |
| 36 | 2474 MHz | 37 | 2476 MHz | 38 | 2478 MHz | 39 | 2480 MHz |

Note: The General Description of the Item, antenna information and Channel List in clause 1 are provided and confirmed by the client.

1.4 Test Facility

| | | |
|------------|----------|---------------------------------------|
| USA | : | FCC Designation Number: CN1199 |
| CA | : | ISED CAB identifier: CN0040 |

2 SAR MEASUREMENT SYSTEM

2.1 DASY5 System Description

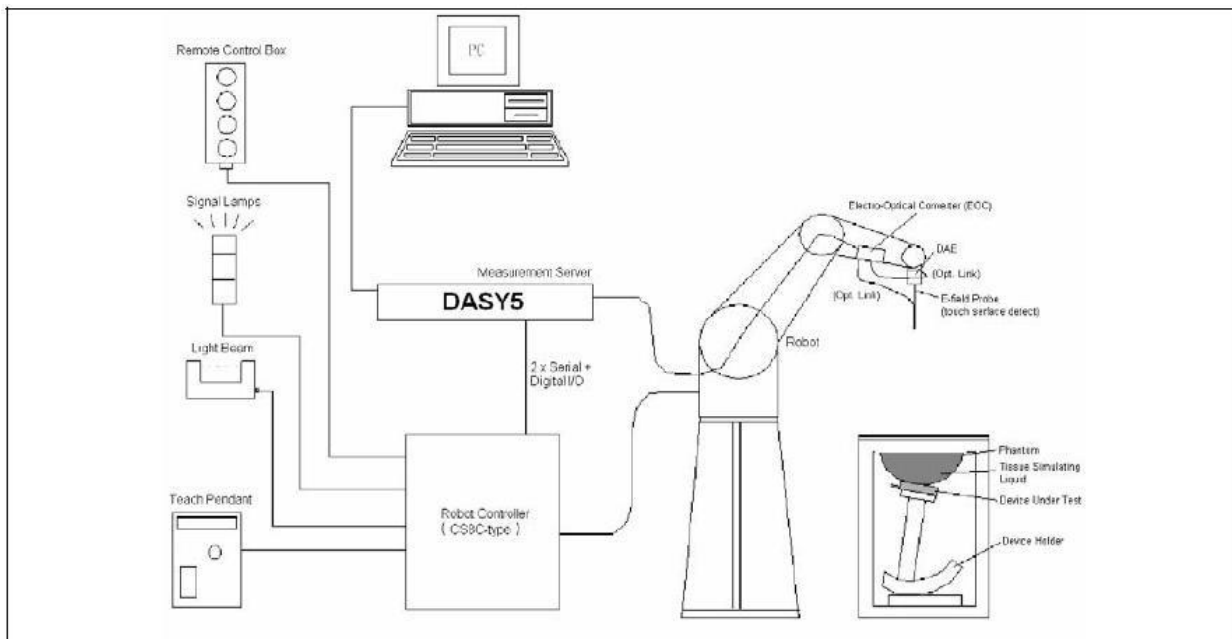

The DASY5 system for performing compliance tests consists of the following items:

1. A standard high precision 6-axis robot with controller, teach pendant and software. An arm extension for accommodating the data acquisition electronics (DAE).
2. A data acquisition electronics (DAE) which performs the signal amplification, signal multiplexing, AD-conversion, offset measurements, mechanical surface detection, collision detection, etc. The unit is battery powered with standard or rechargeable batteries. The signal is optically transmitted to the EOC.
3. The Electro-optical converter (EOC) performs the conversion from optical to electrical signals for the digital communication to the DAE. To use optical surface detection, a special version of the EOC is required. The EOC signal is transmitted to the measurement server.
4. The Light Beam used is for probe alignment. This improves the (absolute) accuracy of the probe positioning.
5. A computer running WinXP and the DASY5 software.
6. Remote control and teach pendant as well as additional circuitry for robot safety such as warning lamps, etc.
7. The phantom, the device holder and other accessories according to the targeted measurement.

2.1.1. Applications

Predefined procedures and evaluations for automated compliance testing with all worldwide standards, e.g., IEEE 1528, OET 65, IEC 62209-1, IEC 62209-2, EN 50360, EN 50383, EN62311 and others.

2.1.2. Area Scans

Area scans are defined prior to the measurement process being executed with a user defined variable spacing between each measurement point (integral) allowing low uncertainty measurements to be conducted. Scans defined for FCC applications utilize a 10mm² step integral, with 1mm interpolation used to locate the peak SAR area used for zoom scan assessments.

When an Area Scan has measured all reachable points, it computes the field maxima found in the scanned area, within a range of the global maximum. The range (in dB) is specified in the standards for compliance testing. For example, a 2 dB range is required in IEEE 1528-2003 and IEC 62209 standards, whereby 3 dB is a requirement when compliance is assessed in accordance with the ARIB standard (Japan).

2.1.3. Zoom Scan (Cube Scan Averaging)

Zoom Scans are used to assess the peak spatial SAR values within a cubic averaging volume containing 1 g and 10 g of simulated tissue. A density of 1000 kg/m³ is used to represent the head and Body tissue density and not the phantom liquid density, in order to be consistent with the definition of the liquid dielectric properties, i.e. the side length of the 1 g cube is 10mm, with the side length of the 10 g cube 21,5mm.

The zoom scan integer steps can be user defined so as to reduce uncertainty, but normal practice for typical test applications utilize a physical step of 7x7x7 (5mmx5mmx5mm) providing a volume of 30mm in the X & Y axis, and 30mm in the Z axis.

2.1.4. Uncertainty of Inter-/Extrapolation and Averaging

In order to evaluate the uncertainty of the interpolation, extrapolation and averaged SAR calculation algorithms of the Postprocessor, DASY5 allows the generation of measurement grids which are artificially predefined by analytically based test functions. Therefore, the grids of area scans and zoom scans can be filled with uncertainty test data, according to the SAR benchmark functions of IEEE 1528. The three analytical functions shown in equations as below are used to describe the possible range of the expected SAR distributions for the tested handsets. The field gradients are covered by the spatially flat distribution f1, the spatially steep distribution f3 and f2 accounts for H-field cancellation on the phantom/tissue surface.

$$f_1(x, y, z) = Ae^{-\frac{z}{2a}} \cos^2 \left(\frac{\pi \sqrt{x'^2 + y'^2}}{2 \cdot 5a} \right)$$

$$f_2(x, y, z) = Ae^{-\frac{z}{a}} \frac{a^2}{a^2 + x'^2} \left(3 - e^{-\frac{2z}{a}} \right) \cos^2 \left(\frac{\pi y'}{2 \cdot 3a} \right)$$

$$f_3(x, y, z) = A \frac{a^2}{\frac{a^2}{4} + x'^2 + y'^2} \left(e^{-\frac{2z}{a}} + \frac{a^2}{2(a + 2z)^2} \right)$$

2.2 DASY5 E-Field Probe

The SAR measurement is conducted with the dosimetric probe manufactured by SPEAG. The probe is specially designed and calibrated for use in liquid with high permittivity. The dosimetric probe has special calibration in liquid at different frequency.

SPEAG conducts the probe calibration in compliance with international and national standards (e.g. IEEE 1528, EN 62209-1, IEC 62209, etc.) under ISO 17025. The calibration data are in Appendix D.

| | | |
|----------------------|--|--|
| Model | EX3DV4 | |
| Construction | Symmetrical design with triangular core Built-in shielding against static charges PEEK enclosure material (resistant to organic solvents, e.g., DGBE) | |
| Frequency | 10 MHz to 6 GHz Linearity: ± 0.2 dB (30 MHz to 6 GHz) |  |
| Directivity | ± 0.3 dB in HSL (rotation around probe axis) ± 0.5 dB in tissue material (rotation normal to probe axis) | |
| Dynamic Range | 10 μ W/g to 100 mW/g Linearity: ± 0.2 dB (noise: typically < 1 μ W/g) | |
| Dimensions | Overall length: 330 mm (Tip: 20 mm) Tip diameter: 2.5 mm (Body: 12 mm) Typical distance from probe tip to dipole centers: 1 mm | |
| Application | High precision dosimetric measurements in any exposure scenario (e.g., very strong gradient fields). Only probe which enables compliance testing for frequencies up to 6 GHz with precision of better 30%. | |

2.3 Boundary Detection Unit and Probe Mounting Device

The DASY probes use a precise connector and an additional holder for the probe, consisting of a plastic tube and a flexible silicon ring to center the probe. The connector at the DAE is flexibly mounted and held in the default position with magnets and springs. Two switching systems in the connector mount detect Frontal and lateral probe collisions and trigger the necessary software response.



2.4 DATA Acquisition Electronics (DAE) and Measurement Server

The data acquisition electronics (DAE) consists of a highly sensitive electrometer-grade preamplifier with auto-zeroing, a channel and gain-switching multiplexer, a fast 16 bit AD-converter and a command decoder and control logic unit.

Transmission to the measurement server is accomplished through an optical downlink for data and status information as well as an optical uplink for commands and the clock.

The input impedance of the DAE4 is 200M Ohm; the inputs are symmetrical and floating. Common mode rejection is above 80dB.



The DASY5 measurement server is based on a PC/104 CPU board with a 400MHz intel ULV Celeron, 128MB chipdisk and 128MB RAM. The necessary circuits for communication with the DAE electronics box, as well as the 16 bit AD converter system for optical detection and digital I/O interface are contained on the DASY5 I/O board, which is directly connected to the PC/104 bus of the CPU board.



2.5 Robot

The DASY5 system uses the high precision robots TX90 XL type out of the newer series from Stäubli SA (France). For the 6-axis controller DASY5 system, the CS8C robot controller version from Stäubli is used. The XL robot series have many features that are important for our application:

- High precision (repeatability 0.02 mm)
- High reliability (industrial design)
- Jerk-free straight movements
- Low ELF interference (the closed metallic construction shields against motor control fields)
- 6-axis controller



2.6 Light Beam Unit

The light beam switch allows automatic "tooling" of the probe. During the process, the actual position of the probe tip with respect to the robot arm is measured, as well as the probe length and the horizontal probe offset. The software then corrects all movements, such that the robot coordinates are valid for the probe tip.

The repeatability of this process is better than 0.1 mm. If a position has been taught with an aligned probe, the same position will be reached with another aligned probe within 0.1 mm, even if the other probe has different dimensions. During probe rotations, the probe tip will keep its actual position.



2.7 Device Holder

The DASY5 device holder is designed to cope with different positions given in the standard. It has two scales for the device rotation (with respect to the Body axis) and the device inclination (with respect to the line between the ear reference points). The rotation center for both scales is the ear reference point (EPR).

Thus the device needs no repositioning when changing the angles.

The DASY5 device holder has been made out of low-loss POM material having the following dielectric parameters: relative permittivity $\epsilon_r = 3$ and loss tangent $\delta = 0.02$. The amount of dielectric material has been reduced in the closest vicinity of the device, since measurements have suggested that the influence of the clamp on the test results could thus be lowered.



2.8 SAM Twin Phantom

The SAM twin phantom is a fiberglass shell phantom with 2mm shell thickness (except the ear region where shell thickness increases to 6mm). It has three measurement areas:

- Left head
- Right head
- Flat phantom



The bottom plate contains three pair of bolts for locking the device holder. The device holder positions are adjusted to the standard measurement positions in the three sections. A white cover is provided to tap the phantom during off-periods to prevent water evaporation and changes in the liquid parameters. On the phantom top, three reference markers are provided to identify the phantom position with respect to the robot.

3 TISSUE SIMULATING LIQUID

3.1 The composition of the tissue simulating liquid

| INGREDIENT (% Weight) | 2450MHz Head |
|--------------------------|-----------------|
| Water | 73.2 |
| Salt | 0.01 |
| Sugar | 0.00 |
| HEC | 0.00 |
| Preventol | 0.00 |
| DGBE | 26.7 |
| Triton X-100 | 0.00 |

3.2 Tissue Calibration Result

The dielectric parameters of the liquids were verified prior to the SAR evaluation using DASY5 Dielectric Probe Kit and Agilent Vector Network Analyzer E5071C

| Head Tissue Simulant Measurement | | | | |
|----------------------------------|------------------|-----------------------|----------------|-------------------|
| Frequency [MHz] | Description | Dielectric Parameters | | Tissue Temp. [°C] |
| | | ϵ_r | σ [s/m] | |
| 2450MHz | Reference result | 39.2 | 1.80 | N/A |
| | ± 5% window | 37.24 to 41.16 | 1.71 to 1.89 | |
| | 11-05-2022 | 39.176 | 1.857 | 21.0 |

| Head Tissue Simulant Measurement | | | | | | | | |
|----------------------------------|---------|---------------------------|-----------------------|----------------------------------|------------------------------|--------------------------|----------------------|-------------------|
| Frequency [MHz] | Channel | Dielectric Parameters | | | | | | Tissue Temp. [°C] |
| | | Permittivity ϵ_r | Conductivity σ | Permittivity Target ϵ_r | Conductivity Target σ | Delta (ϵ_r) % | Delta (σ) % | |
| 2402 | Low | 39.26 | 1.82 | 39.29 | 1.76 | -0.11 | 3.18 | 21.0 |
| 2441 | Mid | 39.16 | 1.85 | 39.22 | 1.79 | -0.11 | 3.07 | 21.0 |
| 2480 | High | 39.23 | 1.87 | 39.15 | 1.83 | 0.08 | 1.97 | 21.0 |

Date: 11-05-2022

Note:

- The delta (ϵ_r) and (σ) are within $\pm 5\%$, delta SAR value was not calculated in this report.
- As per IEC 62209-2 Annex F, the SAR correction factor is given by:

$$\Delta SAR = c_\epsilon \Delta \epsilon_r + c_\sigma \Delta \sigma$$

For the 1g average SAR C_ϵ and C_σ are given by:

$$C_\epsilon = -7.854 \times 10^{-4} f^3 + 9.402 \times 10^{-3} f^2 - 2.742 \times 10^{-2} f - 0.2026$$

$$C_\sigma = 9.804 \times 10^{-3} f^3 - 8.661 \times 10^{-2} f^2 + 2.981 \times 10^{-2} f + 0.7829$$

Where f is the frequency in GHz.



| Haed Tissue Simulant Measurement | | | | | | | |
|----------------------------------|---------|--------------------------|----------------------|--------------|------------|------------|-------------------|
| Frequency [MHz] | Channel | Dielectric Parameters | | | | | Tissue Temp. [°C] |
| | | Delta (ϵ_r) % | Delta (σ) % | C ϵ | C σ | Delta SAR% | |
| 2402 | Low | -0.11 | 3.18 | -0.23 | 0.49 | 1.58 | 21.0 |
| 2441 | Mid | -0.11 | 3.07 | -0.22 | 0.48 | 1.50 | 21.0 |
| 2480 | High | 0.08 | 1.97 | -0.22 | 0.47 | 0.91 | 21.0 |

Date: 11-05-2022

Note: The Δ SAR refers to the percent change in SAR relative to the percent change in dielectric properties versus the target values. A negative Δ SAR would translate to a lower measured SAR value than what would be measured if using dielectric properties equal to the target values. A positive Δ SAR would translate to a higher measured SAR value than what would be measured if using dielectric properties equal to the target values. SAR correction shall not be made when the Δ SAR has a positive sign to provide a conservative SAR value. The SAR is only corrected when Δ SAR has a negative sign.

3.3 Tissue Dielectric Parameters for Head and Body Phantoms

The head tissue dielectric parameters recommended by the IEEE SCC-34/SC-2 in P1528 have been incorporated in the following table. These head parameters are derived from planar layer models simulating the highest expected SAR for the dielectric properties and tissue thickness variations in a human head. Other head and Body tissue parameters that have not been specified in P1528 are derived from the tissue dielectric parameters computed from the 4-Cole-Cole equations described in Reference [12] and extrapolated according to the head parameters specified in P1528.

| Target Frequency (MHz) | Head | |
|---------------------------|--------------|----------------|
| | ϵ_r | σ (S/m) |
| 150 | 52.3 | 0.76 |
| 300 | 45.3 | 0.87 |
| 450 | 43.5 | 0.87 |
| 835 | 41.5 | 0.90 |
| 900 | 41.5 | 0.97 |
| 915 | 41.5 | 0.98 |
| 1450 | 40.5 | 1.20 |
| 1610 | 40.3 | 1.29 |
| 1800 – 2000 | 40.0 | 1.40 |
| 2450 | 39.2 | 1.80 |
| 3000 | 38.5 | 2.40 |
| 5800 | 35.3 | 5.07 |

(ϵ_r = relative permittivity, σ = conductivity and $\rho = 1000 \text{ kg/m}^3$)

4 SAR MEASUREMENT PROCEDURE

4.1 SAR System Validation

4.1.1. Validation Dipoles

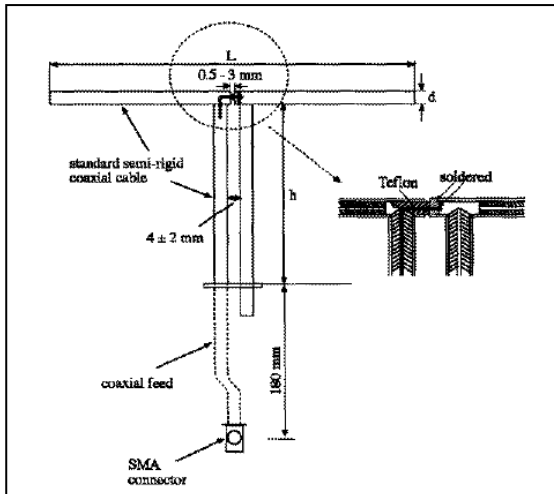

The dipoles used is based on the IEEE-1528 standard, and is complied with mechanical and electrical specifications in line with the requirements of both IEEE and FCC Supplement C. the table below provides details for the mechanical and electrical specifications for the dipoles.

| Frequency | L (mm) | h (mm) | d (mm) |
|-----------|--------|--------|--------|
| 2450MHz | 53.5 | 30.4 | 3.6 |

4.1.2. Validation Result

| System Performance Check Head at 2450MHz | | | | |
|---|----------------------------------|------------------------|------------------------|-------------------|
| Validation Dipole: D2450V2, SN: 839 | | | | |
| Frequency [MHz] | Description | SAR [w/kg] 1g | SAR [w/kg] 10g | Tissue Temp. [°C] |
| 2450 MHz | Reference result ± 10% window | 52.6 47.34 to 57.86 | 24.3 21.87 to 26.73 | N/A |
| | 11-05-2022 | 52.8 | 24.48 | 21.0 |

Note: All SAR values are normalized to 1W forward power.

4.2 SAR Measurement Procedure

The DAS5 calculates SAR using the following equation,

$$SAR = \frac{\sigma |E|^2}{\rho}$$

σ : represents the simulated tissue conductivity

ρ : represents the tissue density

The EUT is set to transmit at the required power in line with product specification, at each frequency relating to the LOW, MID, and HIGH channel settings.

Pre-scans are made on the device to establish the location for the transmitting antenna, using a large area scan in either air or tissue simulation fluid.

The EUT is placed against the Universal Phantom where the maximum area scan dimensions are larger than the physical size of the resonating antenna. When the scan size is not large enough to cover the peak SAR distribution, it is modified by either extending the area scan size in both the X and Y directions, or the device is shifted within the predefined area.

The area scan is then run to establish the peak SAR location (interpolated resolution set at 1mm²) which is then used to orient the center of the zoom scan. The zoom scan is then executed and the 1g and 10g averages are derived from the zoom scan volume (interpolated resolution set at 1mm³).

4.3 SAR Measurement Procedure

4.3.1. Duty Factor Control

Unless it is permitted by specific KDB procedures or continuous transmission is specifically restricted by the device, the reported SAR must be scaled to 100% transmission duty factor to determine compliance at the maximum tune-up tolerance limit.

4.3.2. Initial Test Position SAR Test Reduction Procedure

DSSS and OFDM configurations are considered separately according to the required SAR procedures. SAR is measured in the initial test position using the 802.11 transmission mode configuration required by the DSSS procedure or initial test configuration and subsequent test configuration(s) according to the OFDM procedures.¹⁶ The initial test position procedure is described in the following:

When the reported SAR of the initial test position is ≤ 0.4 W/kg, further SAR measurement is not required for the other (reMaining) test positions in that exposure configuration and 802.11 transmission mode combinations within the frequency band or aggregated band. SAR is also not required for that exposure configuration in the subsequent test configuration(s).

a) When the reported SAR of the initial test position is > 0.4 W/kg, SAR is repeated for the 802.11 transmission mode configuration tested in the initial test position using subsequent highest extrapolated or estimated 1-g SAR conditions determined by area scans or next closest/smallest test separation distance and maximum RF coupling test positions based on manufacturer justification, on the highest maximum output power channel, until the reported SAR is ≤ 0.8 W/kg or all required test positions (left, right, touch, tilt or subsequent surfaces and Edges) are tested.

b) For all positions/configurations tested using the initial test position and subsequent test positions, when the reported SAR is > 0.8 W/kg, SAR is measured for these test positions/configurations on the subsequent next highest measured output power channel(s) until the reported SAR is ≤ 1.2 W/kg or all required channels are tested.

Additional power measurements may be required for this step, which should be limited to those necessary for identifying the subsequent highest output power channels.

5 SAR EXPOSURE LIMITS

SAR assessments have been made in line with the requirements of IEEE-1528, FCC Supplement C, and comply with ANSI/IEEE C95.1-1992 “Uncontrolled Environments” limits. These limits apply to a location which is deemed as “Uncontrolled Environment” which can be described as a situation where the general public may be exposed to an RF source with no prior knowledge or control over their exposure.

Limits for General Population/Uncontrolled Exposure (W/kg)

| Type Exposure | Uncontrolled Environment Limit |
|--|--------------------------------|
| Spatial Peak SAR (1g cube tissue for brain or Body) | 1.6 W/kg |
| Spatial Average SAR (whole Body) | 0.08 W/kg |
| Spatial Peak SAR (10g for hands, feet, ankles and wrist) | 4.00 W/kg |

6 TEST EQUIPMENT LIST

| Instrument | Manufacturer | Model No. | Serial No. | Cali. Due Date |
|-----------------------------|--------------|----------------|-----------------|----------------|
| Stäubli Robot TX60L | Stäubli | TX60L | F10/5C90A1/A/01 | N/A |
| Controller | Stäubli | SP1 | S-0034 | N/A |
| Dipole Validation Kits | Speag | D2450V2 | 839 | 2025.03.31 |
| SAM Twin Phantom | Speag | SAM | TP-1561/1562 | N/A |
| ELI1 Phantom | Speag | QDOVA002AA | TP:2106 | N/A |
| Device Holder | Speag | SD 000 H01 HA | N/A | N/A |
| Data Acquisition Electronic | Speag | DAE4 | 1220 | 2023.03.23 |
| E-Field Probe | Speag | EX3DV4 | 3710 | 2023.04.17 |
| Tissue fluid test probe | Speag | DAK 3.5 | 1308 | N/A |
| SAR Software | Speag | DASY5 | V5.2 Build 162 | N/A |
| Power Amplifier | Mini-Circuit | ZVA-183-S+ | N657400950 | N/A |
| Directional Coupler | woken | 0110A05A82Z-20 | CMLC66W1A1 | 2023.08.18 |
| Vector Network | Agilent | E5071C | MY46103316 | 2023.09.16 |
| Signal Generator | Agilent | E4438C | MY49070163 | 2023.06.30 |
| Spectrum Analyzer | Agilent | N9010A | MY48030494 | 2022.12.14 |
| USB Power Sensor | Keysight | U2021XA | MY60330005 | 2023.09.16 |
| Temperature/Humidity Meter | Zhichen | ZC1-2 | N/A | 2023.07.06 |
| Temperature Meter | Dretec | O-274 | RF-001 | 2022.11.23 |

7 MEASUREMENT UNCERTAINTY

| DASY5 Uncertainty | | | | | | | | |
|--|---------------|-------------|------------|---------|----------|----------------|-----------------|-----------------------|
| Measurement uncertainty for 300 MHz to 3 GHz averaged over 1 gram / 10 gram. | | | | | | | | |
| Error Description | Uncert. value | Prob. Dist. | Div. | (ci) 1g | (ci) 10g | Std. Unc. (1g) | Std. Unc. (10g) | (vi) v _{eff} |
| Measurement System | | | | | | | | |
| Probe Calibration | ±5.5% | N | 1 | 1 | 1 | ±5.5% | ±5.5% | ∞ |
| Axial Isotropy | ±4.7% | R | $\sqrt{3}$ | 0.7 | 0.7 | ±1.9% | ±1.9% | ∞ |
| Hemispherical Isotropy | ±9.6% | R | $\sqrt{3}$ | 0.7 | 0.7 | ±3.9% | ±3.9% | ∞ |
| Boundary Effects | ±1.0% | R | $\sqrt{3}$ | 1 | 1 | ±0.6% | ±0.6% | ∞ |
| Linearity | ±4.7% | R | $\sqrt{3}$ | 1 | 1 | ±2.7% | ±2.7% | ∞ |
| System Detection Limits | ±1.0% | R | $\sqrt{3}$ | 1 | 1 | ±0.6% | ±0.6% | ∞ |
| Readout Electronics | ±0.3% | N | 1 | 1 | 1 | ±0.3% | ±0.3% | ∞ |
| Response Time | ±0.8% | R | $\sqrt{3}$ | 1 | 1 | ±0.5% | ±0.5% | ∞ |
| Integration Time | ±2.6% | R | $\sqrt{3}$ | 1 | 1 | ±1.5% | ±1.5% | ∞ |
| RF Ambient Noise | ±3.0% | R | $\sqrt{3}$ | 1 | 1 | ±1.7% | ±1.7% | ∞ |
| RF Ambient Reflections | ±3.0% | R | $\sqrt{3}$ | 1 | 1 | ±1.7% | ±1.7% | ∞ |
| Probe Positioner | ±0.4% | R | $\sqrt{3}$ | 1 | 1 | ±0.2% | ±0.2% | ∞ |
| Probe Positioning | ±2.9% | R | $\sqrt{3}$ | 1 | 1 | ±1.7% | ±1.7% | ∞ |
| Max. SAR Eval. | ±1.0% | R | $\sqrt{3}$ | 1 | 1 | ±0.6% | ±0.6% | ∞ |
| Test Sample Related | | | | | | | | |
| Device Positioning | ±2.9% | N | 1 | 1 | 1 | ±2.9% | ±2.9% | 145 |
| Device Holder | ±3.6% | N | 1 | 1 | 1 | ±3.6% | ±3.6% | 5 |
| Power Drift | ±5.0% | R | $\sqrt{3}$ | 1 | 1 | ±2.9% | ±2.9% | ∞ |
| Phantom and Setup | | | | | | | | |
| Phantom Uncertainty | ±4.0% | R | $\sqrt{3}$ | 1 | 1 | ±2.3% | ±2.3% | ∞ |
| Liquid Conductivity (meas.) | ±2.5% | N | 1 | 0.78 | 0.71 | ±2.0% | ±1.8% | ∞ |
| Liquid Permittivity (meas.) | ±2.5% | N | 1 | 0.26 | 0.26 | ±0.6% | ±0.7% | ∞ |
| Combined Std. Uncertainty | | | | | | ±10.6% | ±10.5% | 361 |
| Expanded STD Uncertainty | | | | | | ±21.2% | ±21.1% | |

| DASY5 Uncertainty | | | | | | | | |
|--|---------------|-------------|------------|---------|----------|----------------|-----------------|-----------------------|
| Measurement uncertainty for 3 GHz to 6 GHz averaged over 1 gram / 10 gram. | | | | | | | | |
| Error Description | Uncert. value | Prob. Dist. | Div. | (ci) 1g | (ci) 10g | Std. Unc. (1g) | Std. Unc. (10g) | (vi) V _{eff} |
| Measurement System | | | | | | | | |
| Probe Calibration | ±6.65% | N | 1 | 1 | 1 | ±6.65% | ±6.65% | ∞ |
| Axial Isotropy | ±4.7% | R | $\sqrt{3}$ | 0.7 | 0.7 | ±1.9% | ±1.9% | ∞ |
| Hemispherical Isotropy | ±9.6% | R | $\sqrt{3}$ | 0.7 | 0.7 | ±3.9% | ±3.9% | ∞ |
| Boundary Effects | ±2.0% | R | $\sqrt{3}$ | 1 | 1 | ±1.2% | ±1.2% | ∞ |
| Linearity | ±4.7% | R | $\sqrt{3}$ | 1 | 1 | ±2.7% | ±2.7% | ∞ |
| System Detection Limits | ±1.0% | R | $\sqrt{3}$ | 1 | 1 | ±0.6% | ±0.6% | ∞ |
| Readout Electronics | ±0.3% | N | 1 | 1 | 1 | ±0.3% | ±0.3% | ∞ |
| Response Time | ±0.8% | R | $\sqrt{3}$ | 1 | 1 | ±0.5% | ±0.5% | ∞ |
| Integration Time | ±2.6% | R | $\sqrt{3}$ | 1 | 1 | ±1.5% | ±1.5% | ∞ |
| RF Ambient Noise | ±3.0% | R | $\sqrt{3}$ | 1 | 1 | ±1.7% | ±1.7% | ∞ |
| RF Ambient Reflections | ±3.0% | R | $\sqrt{3}$ | 1 | 1 | ±1.7% | ±1.7% | ∞ |
| Probe Positioner | ±0.8% | R | $\sqrt{3}$ | 1 | 1 | ±0.5% | ±0.5% | ∞ |
| Probe Positioning | ±6.7% | R | $\sqrt{3}$ | 1 | 1 | ±3.9% | ±3.9% | ∞ |
| Max. SAR Eval. | ±4.0% | R | $\sqrt{3}$ | 1 | 1 | ±2.3% | ±2.3% | ∞ |
| Test Sample Related | | | | | | | | |
| Device Positioning | ±2.9% | N | 1 | 1 | 1 | ±2.9% | ±2.9% | 145 |
| Device Holder | ±3.6% | N | 1 | 1 | 1 | ±3.6% | ±3.6% | 5 |
| Power Drift | ±5.0% | R | $\sqrt{3}$ | 1 | 1 | ±2.9% | ±2.9% | ∞ |
| Phantom and Setup | | | | | | | | |
| Phantom Uncertainty | ±4.0% | R | $\sqrt{3}$ | 1 | 1 | ±2.3% | ±2.3% | ∞ |
| Liquid Conductivity (meas.) | ±2.5% | N | 1 | 0.78 | 0.71 | ±2.0% | ±1.8% | ∞ |
| Liquid Permittivity (meas.) | ±2.5% | N | 1 | 0.26 | 0.26 | ±0.6% | ±0.7% | ∞ |
| Combined Std. Uncertainty | | | | | | ±12.0% | ±12.0% | 784 |
| Expanded STD Uncertainty | | | | | | ±24.0% | ±23.9% | |

| Measurement uncertainty evaluation template for system repeatability | | | | | | | | |
|---|---------------|-------------|------------|---------|----------|----------------|-----------------|-----------------------|
| Measurement uncertainty for 30 MHz to 6 GHz averaged over 1 gram / 10 gram. | | | | | | | | |
| Error Description | Uncert. Value | Prob. Dist. | Div. | (ci) 1g | (ci) 10g | Std. Unc. (1g) | Std. Unc. (10g) | (vi) v _{eff} |
| Measurement System | | | | | | | | |
| Probe Calibration | ±6.65% | N | 1 | 1 | 1 | ±6.65% | ±6.65% | ∞ |
| Axial Isotropy | ±4.7% | R | $\sqrt{3}$ | 0.7 | 0.7 | ±1.9% | ±1.9% | ∞ |
| Hemispherical Isotropy | ±9.6% | R | $\sqrt{3}$ | 0.7 | 0.7 | ±3.9% | ±3.9% | ∞ |
| Boundary Effects | ±2.0% | R | $\sqrt{3}$ | 0 | 0 | ±1.2% | ±1.2% | ∞ |
| Linearity | ±4.7% | R | $\sqrt{3}$ | 1 | 1 | ±2.7% | ±2.7% | ∞ |
| Modulation Response | ±2.4% | R | $\sqrt{3}$ | 0 | 0 | ±1.4% | ±1.4% | ∞ |
| System Detection Limits | ±1.0% | R | $\sqrt{3}$ | 0 | 0 | ±0.6% | ±0.6% | ∞ |
| Readout Electronics | ±0.3% | N | 1 | 0 | 0 | ±0.3% | ±0.3% | ∞ |
| Response Time | ±0.8% | R | $\sqrt{3}$ | 0 | 0 | ±0.5% | ±0.5% | ∞ |
| Integration Time | ±2.6% | R | $\sqrt{3}$ | 0 | 0 | ±1.5% | ±1.5% | ∞ |
| RF Ambient Noise | ±3.0% | R | $\sqrt{3}$ | 0 | 0 | ±1.7% | ±1.7% | ∞ |
| RF Ambient Reflections | ±3.0% | R | $\sqrt{3}$ | 0 | 0 | ±1.7% | ±1.7% | ∞ |
| Probe Positioner | ±0.8% | R | $\sqrt{3}$ | 1 | 1 | ±0.5% | ±0.5% | ∞ |
| Probe Positioning | ±6.7% | R | $\sqrt{3}$ | 1 | 1 | ±3.9% | ±3.9% | ∞ |
| Post-processing | ±4.0% | R | $\sqrt{3}$ | 0 | 0 | ±2.3% | ±2.3% | ∞ |
| Test Sample Related | | | | | | | | |
| Test Sample Positioning | ±2.9% | N | 1 | 1 | 1 | ±2.9% | ±2.9% | 145 |
| Device Holder | ±3.6% | N | 1 | 1 | 1 | ±3.6% | ±3.6% | 5 |
| Power Drift | ±0.0% | R | $\sqrt{3}$ | 1 | 1 | ±0.0% | ±0.0% | ∞ |
| Power Scaling | ±5.0% | R | $\sqrt{3}$ | 1 | 1 | ±2.9% | ±2.9% | ∞ |
| Phantom and Setup | | | | | | | | |
| Phantom Uncertainty | ±7.9% | R | $\sqrt{3}$ | 1 | 1 | ±4.6% | ±4.6% | ∞ |
| SAR correction | ±1.9% | R | $\sqrt{3}$ | 1 | 1 | ±1.1% | ±0.9% | ∞ |
| Liquid Conductivity (meas.) | ±2.5% | N | 1 | 0.78 | 0.71 | ±2.0% | ±1.8% | ∞ |
| Liquid Permittivity (meas.) | ±2.5% | N | 1 | 0.26 | 0.26 | ±0.6% | ±0.7% | ∞ |
| Temp. unc. - Conductivity | ±5.2% | R | $\sqrt{3}$ | 0.78 | 0.71 | ±2.3% | ±2.1% | ∞ |
| Temp. unc. - Permittivity | ±0.8% | R | $\sqrt{3}$ | 0.23 | 0.26 | ±0.1% | ±0.1% | ∞ |
| Combined Std. Uncertainty | | | | | | ±12.8% | ±12.7% | 748 |
| Expanded STD Uncertainty | | | | | | ±25.6% | ±25.4% | |

8 CONDUCTED POWER MEASUREMENT

Bluetooth Duty Cycle

| Test Mode | Tx On (ms) | Tx Off (ms) | Tx On + Tx Off (ms) | Duty Cycle (%) |
|-----------|------------|-------------|---------------------|----------------|
| DH5 | N/A | N/A | N/A | 100 |
| 2DH5 | N/A | N/A | N/A | 100 |
| 3DH5 | N/A | N/A | N/A | 100 |
| LE_1M | N/A | N/A | N/A | 100 |
| LE_2M | N/A | N/A | N/A | 100 |

DH5_2440MHz:

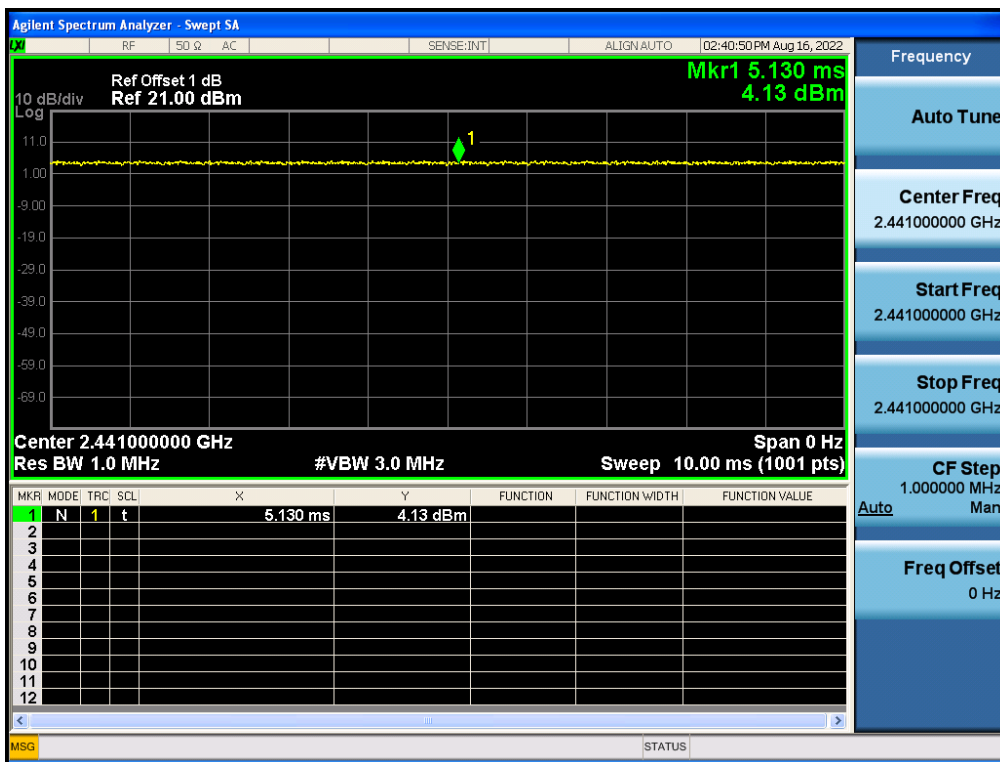

For Bluetooth Power

| Test Mode | Frequency (MHz) | Avg. Power (dBm) | Tune-up Power (dBm) | Duty cycle (%) | Tune-up Scaling Factor | Duty Cycle Scaling Factor |
|------------|-----------------|------------------|---------------------|----------------|------------------------|---------------------------|
| GFSK | 2402 | 7.25 | 7.80 | 100 | 1.135 | 1.000 |
| | 2441 | 6.21 | 7.80 | 100 | 1.442 | 1.000 |
| | 2480 | 5.56 | 7.80 | 100 | 1.675 | 1.000 |
| Pi/4 DQPSK | 2402 | 7.06 | 7.80 | 100 | 1.186 | 1.000 |
| | 2441 | 5.92 | 7.80 | 100 | 1.542 | 1.000 |
| | 2480 | 5.25 | 7.80 | 100 | 1.799 | 1.000 |
| 8DPSK | 2402 | 7.51 | 7.80 | 100 | 1.069 | 1.000 |
| | 2441 | 6.48 | 7.80 | 100 | 1.355 | 1.000 |
| | 2480 | 5.83 | 7.80 | 100 | 1.574 | 1.000 |
| LE 1M | 2402 | 7.24 | 7.80 | 100 | 1.138 | 1.000 |
| | 2440 | 6.17 | 7.80 | 100 | 1.455 | 1.000 |
| | 2480 | 5.55 | 7.80 | 100 | 1.679 | 1.000 |
| LE 2M | 2402 | 7.35 | 7.80 | 100 | 1.109 | 1.000 |
| | 2440 | 6.26 | 7.80 | 100 | 1.426 | 1.000 |
| | 2480 | 5.65 | 7.80 | 100 | 1.641 | 1.000 |

9 TEST PROCEDURES

9.1 SAR Test Results Summary

| SAR Measurement | | | | | | | | | |
|-------------------------------------|------------------|-----------------|-----------------|---------------------|---------------------------|----------------|-------------|----------------------|--------------|
| Ambient Temperature (°C) : 21.5 ± 2 | | | | | Relative Humidity (%): 55 | | | | |
| Liquid Temperature (°C) : 21.0 ± 2 | | | | | Depth of Liquid (cm):>15 | | | | |
| AH80 Bluetooth Headset | | | | | | | | | |
| Body SAR: Spacing 5mm | | | | | | | | | |
| Test Mode | Test Position | Frequency (MHz) | Max Power (dBm) | Power Drift (<±0.2) | SAR 1g (W/kg) | Scaling Factor | Duty factor | Scaled SAR 1g (W/kg) | Limit (W/kg) |
| Bluetooth 3DH5 | Horizontal-Up | 2402 | 7.51 | -0.11 | 0.401 | 1.069 | 1.000 | 0.429 | 1.6 |
| Bluetooth 3DH5 | Horizontal-Down | 2402 | 7.51 | -0.02 | 0.315 | 1.069 | 1.000 | 0.337 | 1.6 |
| Bluetooth 3DH5 | Horizontal-Front | 2402 | 7.51 | 0.01 | 0.231 | 1.069 | 1.000 | 0.247 | 1.6 |
| Bluetooth 3DH5 | Horizontal-Back | 2402 | 7.51 | -0.15 | 0.259 | 1.069 | 1.000 | 0.277 | 1.6 |
| Bluetooth 3DH5 | Horizontal-Top | 2402 | 7.51 | 0.06 | 0.030 | 1.069 | 1.000 | 0.032 | 1.6 |
| Bluetooth 3DH5 | Horizontal-Up | 2441 | 6.48 | -0.09 | 0.315 | 1.355 | 1.000 | 0.427 | 1.6 |
| Bluetooth 3DH5 | Horizontal-Up | 2480 | 5.83 | -0.01 | 0.258 | 1.574 | 1.000 | 0.406 | 1.6 |



(A)

Horizontal-Up



(B)

Horizontal-Down



(C)

Vertical-Front



(D)

Vertical-Back

9.2 Test position and configuration

1. Liquid tissue depth was at least 15.0 cm for all frequencies.
2. The manufacturer has confirmed that the device(s) tested have the same physical, mechanical and thermal characteristics and are within operational tolerances expected for production units.
3. SAR results were scaled to the maximum allowed power to demonstrate compliance per FCC KDB Publication 447498 D04v01.
4. Reported SAR were scaled to the maximum duty factor to demonstrate compliance per FCC KDB 248227 D01 802.11 Wi-Fi SAR v02r02.
5. SAR was performed with the device configured in the positions according to KDB 447498 D02 SAR Procedures for general, Body SAR was performed with the device to phantom separation distance of 5mm.

Appendix A. SAR System Validation Data

Date: 11/5/2022

Test Laboratory: DEKRA Lab

System Check Head 2450MHz

DUT: Dipole 2450 MHz D2450V2

Communication System: UID 0, CW; Communication System Band: D2450; Duty Cycle: 1:1; Frequency: 2450 MHz; Medium parameters used: $f = 2450$ MHz; $\sigma = 1.857$ S/m; $\epsilon_r = 39.176$; $\rho = 1000$ kg/m³; Phantom section: Flat Section; Input Power=250mW

Ambient temperature (°C): 21.5, Liquid temperature (°C): 21.0

DASY5 Configuration:

- Probe: EX3DV4 - SN3710; ConvF(7.39, 7.39, 7.39); Calibrated: 4/18/2022
- Sensor-Surface: 4mm (Mechanical Surface Detection)
- Electronics: DAE4 Sn1220; Calibrated: 3/24/2022
- Phantom: SAM2; Type: SAM; Serial: TP1562
- Measurement SW: DASY52, Version 52.10 (4); SEMCAD X Version 14.6.14 (7483)

System Check Head 2450MHz/Area Scan (7x11x1): Measurement grid: dx=10mm, dy=10mm

Maximum value of SAR (measured) = 12.6 W/kg

System Check Head 2450MHz/Zoom Scan (7x7x7)/Cube 0: Measurement grid: dx=5mm, dy=5mm, dz=5mm

Reference Value = 79.49 V/m; Power Drift = 0.05 dB

Peak SAR (extrapolated) = 28.9 W/kg

SAR(1 g) = 13.2 W/kg; SAR(10 g) = 6.12 W/kg

Maximum value of SAR (measured) = 15.1 W/kg

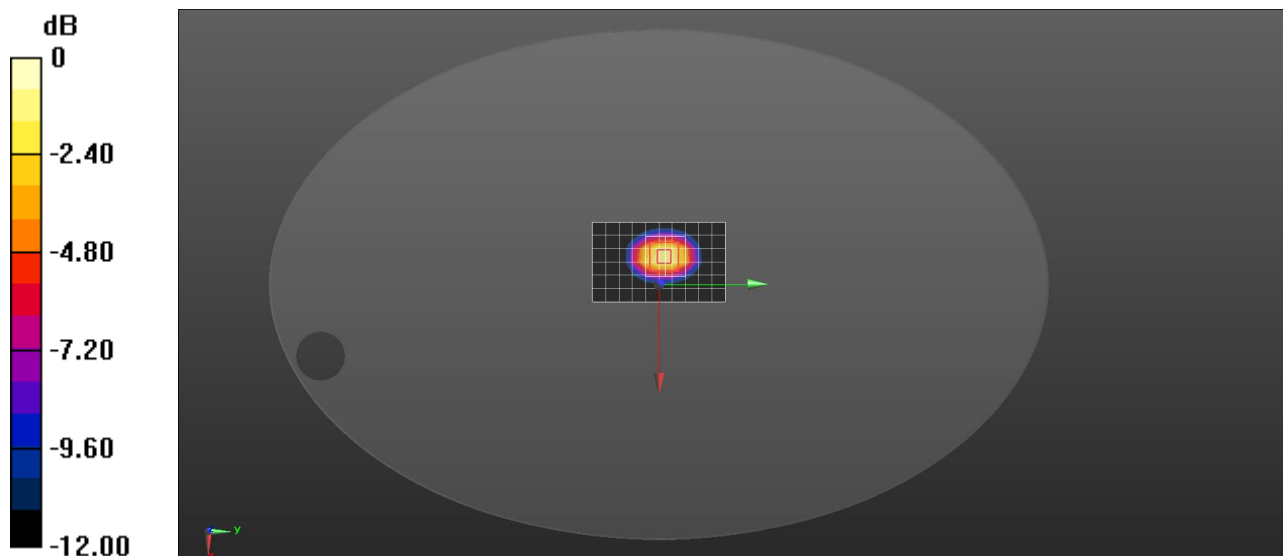

0 dB = 15.1 W/kg = 11.79 dBW/kg

Appendix B. SAR measurement Data

Date: 11/5/2022

Test Laboratory: DEKRA Lab

Bluetooth_3Mbps(8 DPSK_DH5)_CH0 2402MHz_Horizontal-Up_5mm

DUT: Dongle

Communication System: UID 0, Bluetooth (0); Communication System Band: BDR+EDR; Duty Cycle: 1:1.0;

Frequency: 2402 MHz; Medium parameters used: $f = 2402$ MHz; $\sigma = 1.816$ S/m; $\epsilon_r = 39.258$; $\rho = 1000$ kg/m³ ;

Phantom section: Flat Section

Ambient temperature (°C): 21.5, Liquid temperature (°C): 21.0

DASY5 Configuration:

- Probe: EX3DV4 - SN3710; ConvF(7.39, 7.39, 7.39); Calibrated: 18/4/2022
- Sensor-Surface: 4mm (Mechanical Surface Detection)
- Electronics: DAE4 Sn1220; Calibrated: 24/3/2022
- Phantom: Twin-SAM V5.0 (20deg probe tilt); Type: QD 000 P40 CD; Serial: TP1562
- Measurement SW: DASY52, Version 52.10 (3); SEMCAD X Version 14.6.13 (7474)

CH00/Area Scan (9x9x1): Measurement grid: dx=12mm, dy=12mm

Maximum value of SAR (measured) = 0.491 W/kg

CH00/Zoom Scan (7x7x4)/Cube 0: Measurement grid: dx=5mm, dy=5mm, dz=5mm

Reference Value = 10.15 V/m; Power Drift = -0.11 dB

Peak SAR (extrapolated) = 0.935 W/kg

SAR(1 g) = 0.402 W/kg; SAR(10 g) = 0.201 W/kg

Maximum value of SAR (measured) = 0.497 W/kg

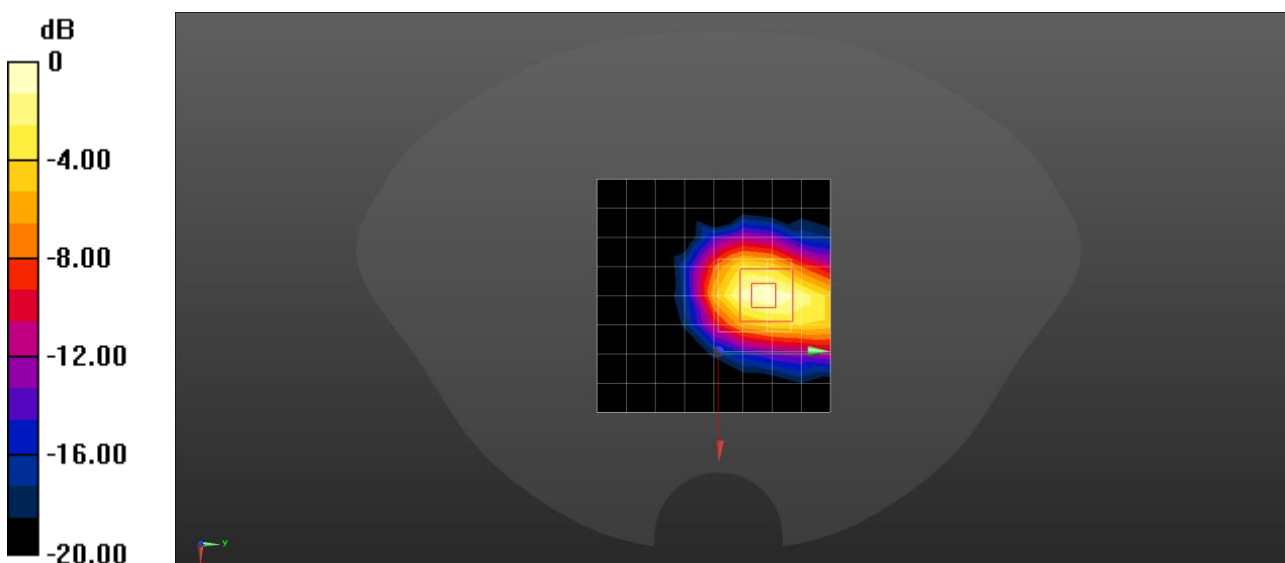

0 dB = 0.497 W/kg = -3.04 dBW/kg

Date: 11/5/2022

Test Laboratory: DEKRA Lab

Bluetooth_3Mbps(8 DPSK_DH5)_CH0 2402MHz_Horizontal-Down_5mm

DUT: Dongle

Communication System: UID 0, Bluetooth (0); Communication System Band: BDR+EDR; Duty Cycle: 1:1.0; Frequency: 2402 MHz; Medium parameters used: $f = 2402$ MHz; $\sigma = 1.816$ S/m; $\epsilon_r = 39.258$; $\rho = 1000$ kg/m³; Phantom section: Flat Section

Ambient temperature (°C): 21.5, Liquid temperature (°C): 21.0

DASY5 Configuration:

- Probe: EX3DV4 - SN3710; ConvF(7.39, 7.39, 7.39); Calibrated: 18/4/2022
- Sensor-Surface: 4mm (Mechanical Surface Detection)
- Electronics: DAE4 Sn1220; Calibrated: 24/3/2022
- Phantom: Twin-SAM V5.0 (20deg probe tilt); Type: QD 000 P40 CD; Serial: TP1562
- Measurement SW: DASY52, Version 52.10 (3); SEMCAD X Version 14.6.13 (7474)

CH00/Area Scan (9x9x1): Measurement grid: dx=12mm, dy=12mm

Maximum value of SAR (measured) = 0.464 W/kg

CH00/Zoom Scan (7x7x4)/Cube 0: Measurement grid: dx=5mm, dy=5mm, dz=5mm

Reference Value = 6.641 V/m; Power Drift = -0.02 dB

Peak SAR (extrapolated) = 0.878 W/kg

SAR(1 g) = 0.315 W/kg; SAR(10 g) = 0.147 W/kg

Maximum value of SAR (measured) = 0.469 W/kg

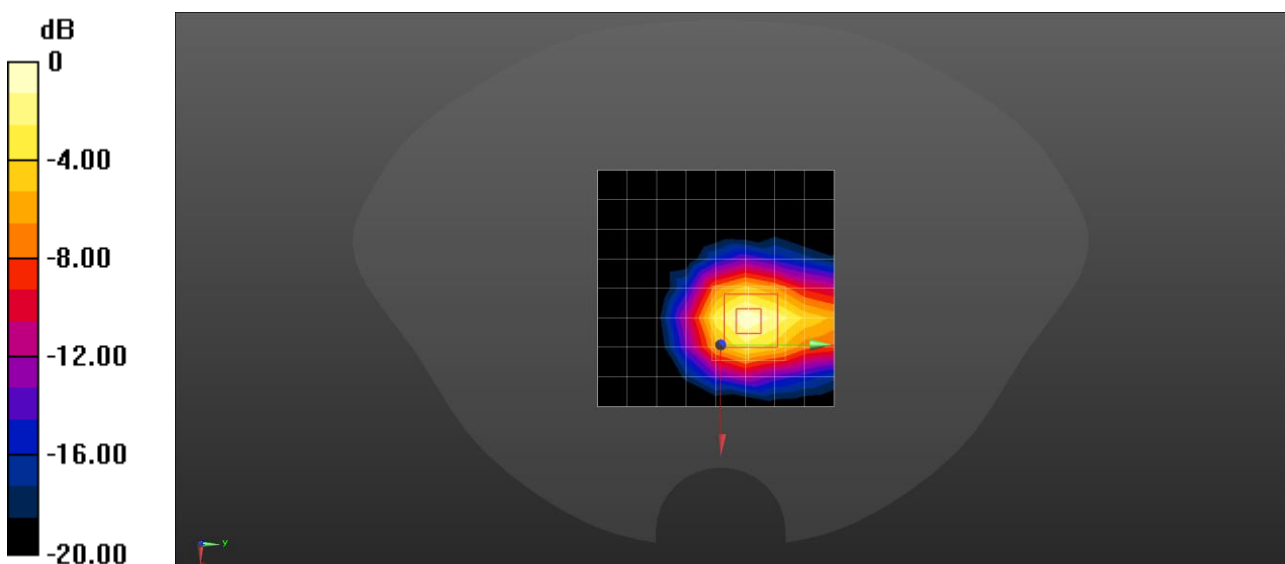

0 dB = 0.469 W/kg = -3.29 dBW/kg

Date: 11/5/2022

Test Laboratory: DEKRA Lab

Bluetooth_3Mbps(8 DPSK_DH5)_CH0 2402MHz_Horizontal-Front_5mm

DUT: Dongle

Communication System: UID 0, Bluetooth (0); Communication System Band: BDR+EDR; Duty Cycle: 1:1.0; Frequency: 2402 MHz; Medium parameters used: $f = 2402$ MHz; $\sigma = 1.816$ S/m; $\epsilon_r = 39.258$; $\rho = 1000$ kg/m³; Phantom section: Flat Section

Ambient temperature (°C): 21.5, Liquid temperature (°C): 21.0

DASY5 Configuration:

- Probe: EX3DV4 - SN3710; ConvF(7.39, 7.39, 7.39); Calibrated: 18/4/2022
- Sensor-Surface: 4mm (Mechanical Surface Detection)
- Electronics: DAE4 Sn1220; Calibrated: 24/3/2022
- Phantom: Twin-SAM V5.0 (20deg probe tilt); Type: QD 000 P40 CD; Serial: TP1562
- Measurement SW: DASY52, Version 52.10 (3); SEMCAD X Version 14.6.13 (7474)

CH00/Area Scan (9x9x1): Measurement grid: dx=12mm, dy=12mm

Maximum value of SAR (measured) = 0.245 W/kg

CH00/Zoom Scan (7x7x4)/Cube 0: Measurement grid: dx=5mm, dy=5mm, dz=5mm

Reference Value = 4.110 V/m; Power Drift = 0.01 dB

Peak SAR (extrapolated) = 0.508 W/kg

SAR(1 g) = 0.231 W/kg; SAR(10 g) = 0.107 W/kg

Maximum value of SAR (measured) = 0.258 W/kg

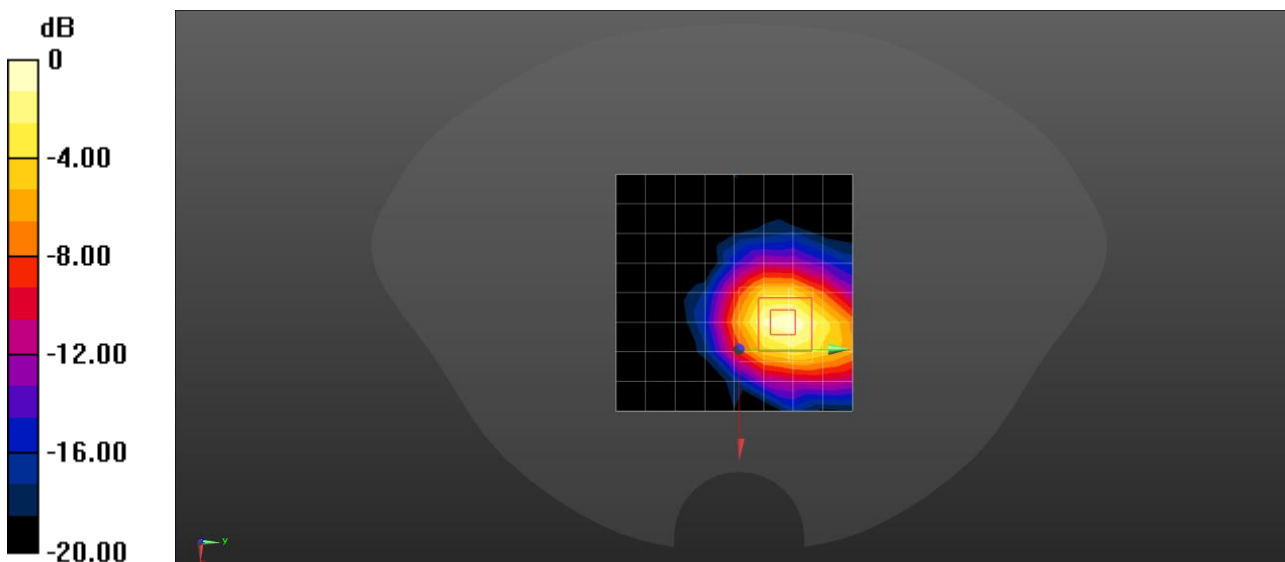

0 dB = 0.258 W/kg = -5.88 dBW/kg

Date: 11/5/2022

Test Laboratory: DEKRA Lab

Bluetooth_3Mbps(8 DPSK_DH5)_CH0 2402MHz_ Horizontal-Back_5mm

DUT: Dongle

Communication System: UID 0, Bluetooth (0); Communication System Band: BDR+EDR; Duty Cycle: 1:1.0; Frequency: 2402 MHz; Medium parameters used (interpolated): $f = 2402$ MHz; $\sigma = 1.816$ S/m; $\epsilon_r = 39.258$; $\rho = 1000$ kg/m³ ; Phantom section: Flat Section

Ambient temperature (°C): 21.5, Liquid temperature (°C): 21.0

DASY5 Configuration:

- Probe: EX3DV4 - SN3710; ConvF(7.39, 7.39, 7.39); Calibrated: 18/4/2022
- Sensor-Surface: 4mm (Mechanical Surface Detection)
- Electronics: DAE4 Sn1220; Calibrated: 24/3/2022
- Phantom: Twin-SAM V5.0 (20deg probe tilt); Type: QD 000 P40 CD; Serial: TP1562
- Measurement SW: DASY52, Version 52.10 (3); SEMCAD X Version 14.6.13 (7474)

CH00/Area Scan (9x9x1): Measurement grid: dx=12mm, dy=12mm

Maximum value of SAR (measured) = 0.269 W/kg

CH00/Zoom Scan (7x7x4)/Cube 0: Measurement grid: dx=5mm, dy=5mm, dz=5mm

Reference Value = 6.006 V/m; Power Drift = -0.15 dB

Peak SAR (extrapolated) = 0.544 W/kg

SAR(1 g) = 0.259 W/kg; SAR(10 g) = 0.119 W/kg

Maximum value of SAR (measured) = 0.289 W/kg

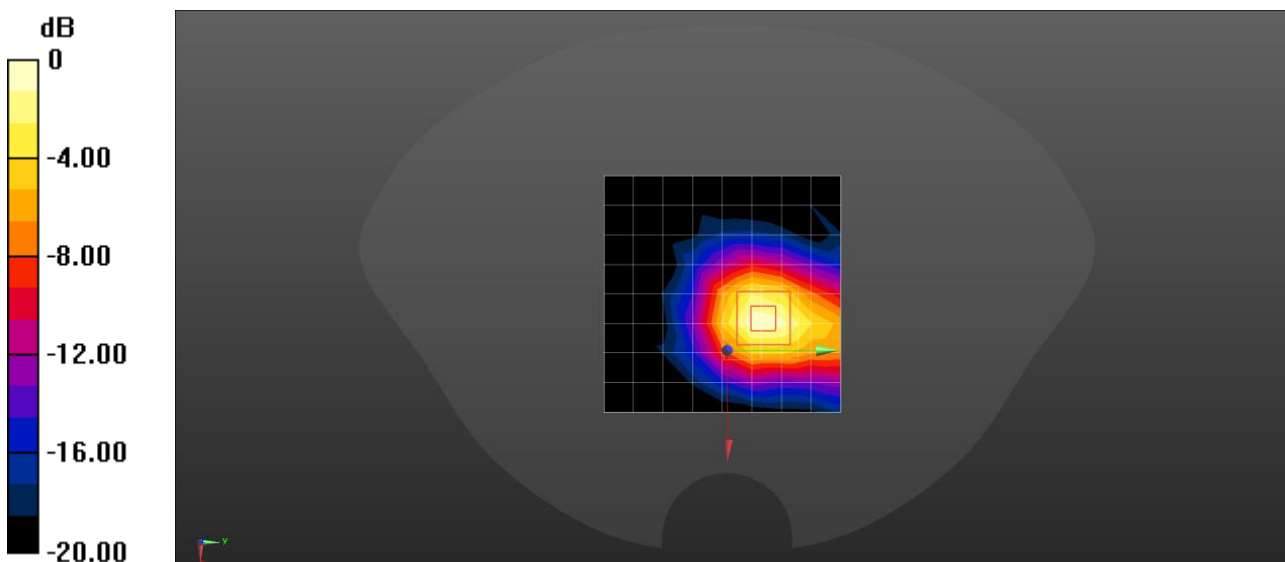

0 dB = 0.289 W/kg = -5.39 dBW/kg

Date: 11/5/2022

Test Laboratory: DEKRA Lab

Bluetooth_3Mbps(8 DPSK_DH5)_CH0 2402MHz_Horizontal-Top_5mm

DUT: Dongle

Communication System: UID 0, Bluetooth (0); Communication System Band: BDR+EDR; Duty Cycle: 1:1.0; Frequency: 2402 MHz; Medium parameters used: $f = 2402$ MHz; $\sigma = 1.816$ S/m; $\epsilon_r = 39.258$; $\rho = 1000$ kg/m³; Phantom section: Flat Section

Ambient temperature (°C): 21.5, Liquid temperature (°C): 21.0

DASY5 Configuration:

- Probe: EX3DV4 - SN3710; ConvF(7.39, 7.39, 7.39); Calibrated: 18/4/2022
- Sensor-Surface: 4mm (Mechanical Surface Detection)
- Electronics: DAE4 Sn1220; Calibrated: 24/3/2022
- Phantom: Twin-SAM V5.0 (20deg probe tilt); Type: QD 000 P40 CD; Serial: TP1562
- Measurement SW: DASY52, Version 52.10 (3); SEMCAD X Version 14.6.13 (7474)

CH00/Area Scan (9x9x1): Measurement grid: dx=12mm, dy=12mm

Maximum value of SAR (measured) = 0.0296 W/kg

CH00/Zoom Scan (7x7x4)/Cube 0: Measurement grid: dx=5mm, dy=5mm, dz=5mm

Reference Value = 3.978 V/m; Power Drift = 0.06 dB

SAR(1 g) = 0.0295 W/kg; SAR(10 g) = 0.0169 W/kg

Peak SAR (extrapolated) = 0.0710 W/kg

Maximum value of SAR (measured) = 0.0319 W/kg

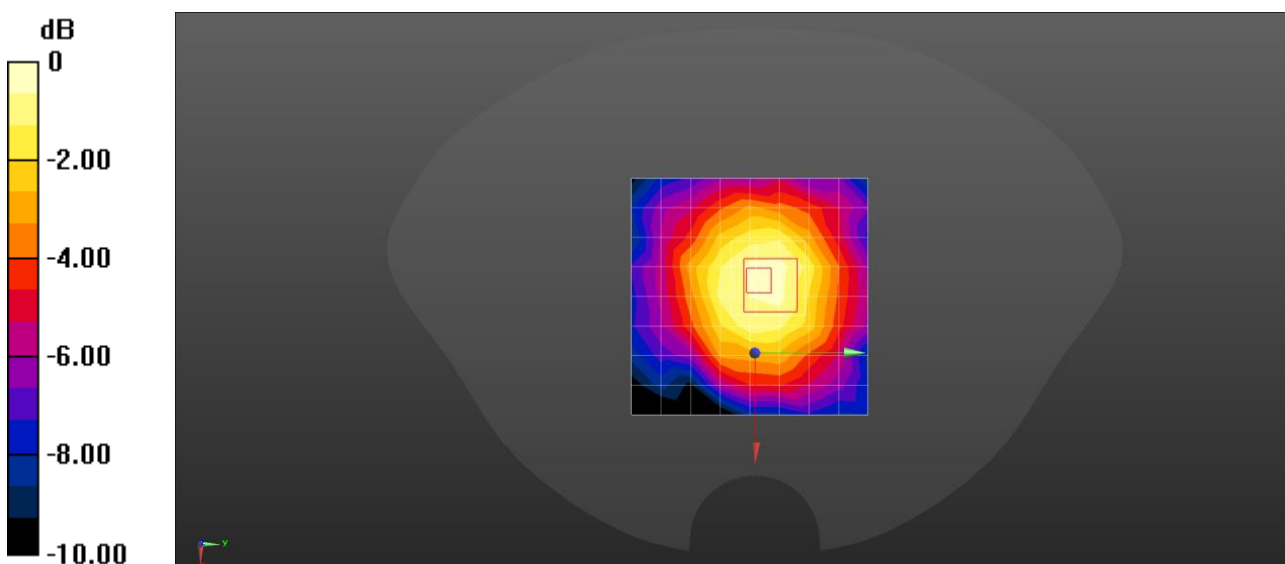

0 dB = 0.0319 W/kg = -14.96 dBW/kg

Date: 11/5/2022

Test Laboratory: DEKRA Lab

Bluetooth_3Mbps(8 DPSK_DH5)_CH39 2441MHz_Horizontal-Up_5mm

DUT: Dongle

Communication System: UID 0, Bluetooth (0); Communication System Band: BDR+EDR; Duty Cycle: 1:1.0; Frequency: 2441 MHz; Medium parameters used: $f = 2441$ MHz; $\sigma = 1.845$ S/m; $\epsilon_r = 39.158$; $\rho = 1000$ kg/m³; Phantom section: Flat Section

Ambient temperature (°C): 21.5, Liquid temperature (°C): 21.0

DASY5 Configuration:

- Probe: EX3DV4 - SN3710; ConvF(7.39, 7.39, 7.39); Calibrated: 18/4/2022
- Sensor-Surface: 4mm (Mechanical Surface Detection)
- Electronics: DAE4 Sn1220; Calibrated: 24/3/2022
- Phantom: Twin-SAM V5.0 (20deg probe tilt); Type: QD 000 P40 CD; Serial: TP1562
- Measurement SW: DASY52, Version 52.10 (3); SEMCAD X Version 14.6.13 (7474)

CH39/Area Scan (9x9x1): Measurement grid: dx=12mm, dy=12mm

Maximum value of SAR (measured) = 0.422 W/kg

CH39/Zoom Scan (7x7x4)/Cube 0: Measurement grid: dx=5mm, dy=5mm, dz=5mm

Reference Value = 12.05 V/m; Power Drift = -0.09 dB

Peak SAR (extrapolated) = 0.812 W/kg

SAR(1 g) = 0.315 W/kg; SAR(10 g) = 0.167 W/kg

Maximum value of SAR (measured) = 0.433 W/kg

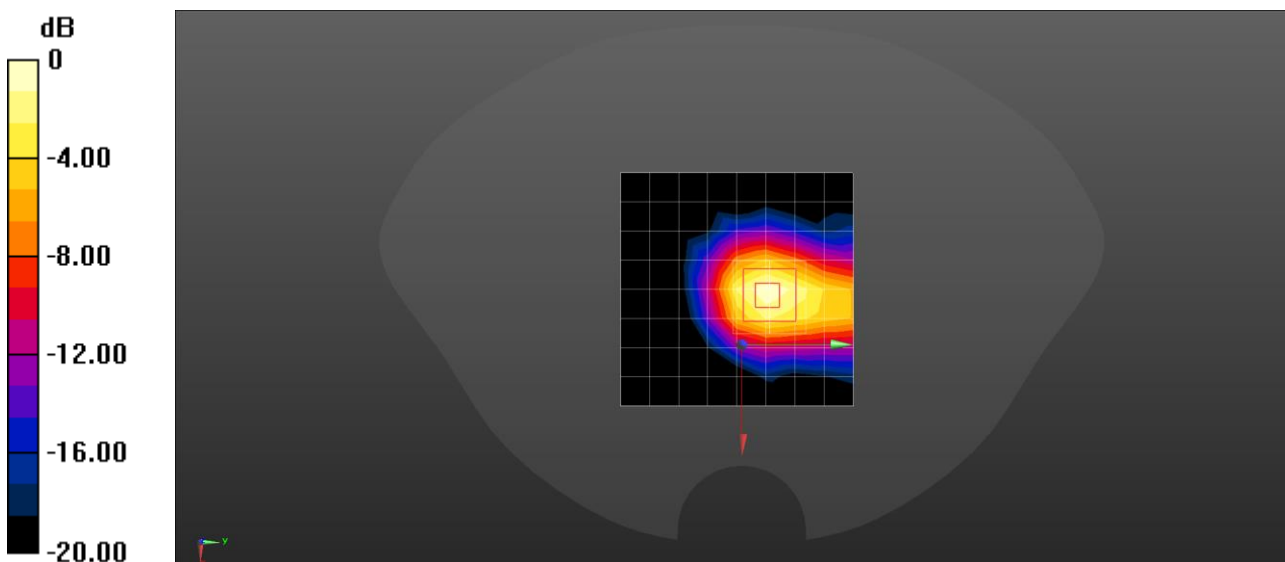

0 dB = 0.433 W/kg = -3.64 dBW/kg

Date: 11/5/2022

Test Laboratory: DEKRA Lab

Bluetooth_3Mbps(8 DPSK_DH5)_CH78 2480MHz_Horizontal-Up_5mm

DUT: Dongle

Communication System: UID 0, Bluetooth (0); Communication System Band: BDR+EDR; Duty Cycle: 1:1.0; Frequency: 2480 MHz; Medium parameters used: $f = 2480$ MHz; $\sigma = 1.866$ S/m; $\epsilon_r = 39.231$; $\rho = 1000$ kg/m³; Phantom section: Flat Section

Ambient temperature (°C): 21.5, Liquid temperature (°C): 21.0

DASY5 Configuration:

- Probe: EX3DV4 - SN3710; ConvF(7.39, 7.39, 7.39); Calibrated: 18/4/2022
- Sensor-Surface: 4mm (Mechanical Surface Detection)
- Electronics: DAE4 Sn1220; Calibrated: 24/3/2022
- Phantom: Twin-SAM V5.0 (20deg probe tilt); Type: QD 000 P40 CD; Serial: TP1562
- Measurement SW: DASY52, Version 52.10 (3); SEMCAD X Version 14.6.13 (7474)

CH78/Area Scan (9x9x1): Measurement grid: dx=12mm, dy=12mm

Maximum value of SAR (measured) = 0.389 W/kg

CH78/Zoom Scan (7x7x4)/Cube 0: Measurement grid: dx=5mm, dy=5mm, dz=5mm

Reference Value = 11.19 V/m; Power Drift = -0.01 dB

Peak SAR (extrapolated) = 0.762 W/kg

SAR(1 g) = 0.258 W/kg; SAR(10 g) = 0.121 W/kg

Maximum value of SAR (measured) = 0.412 W/kg

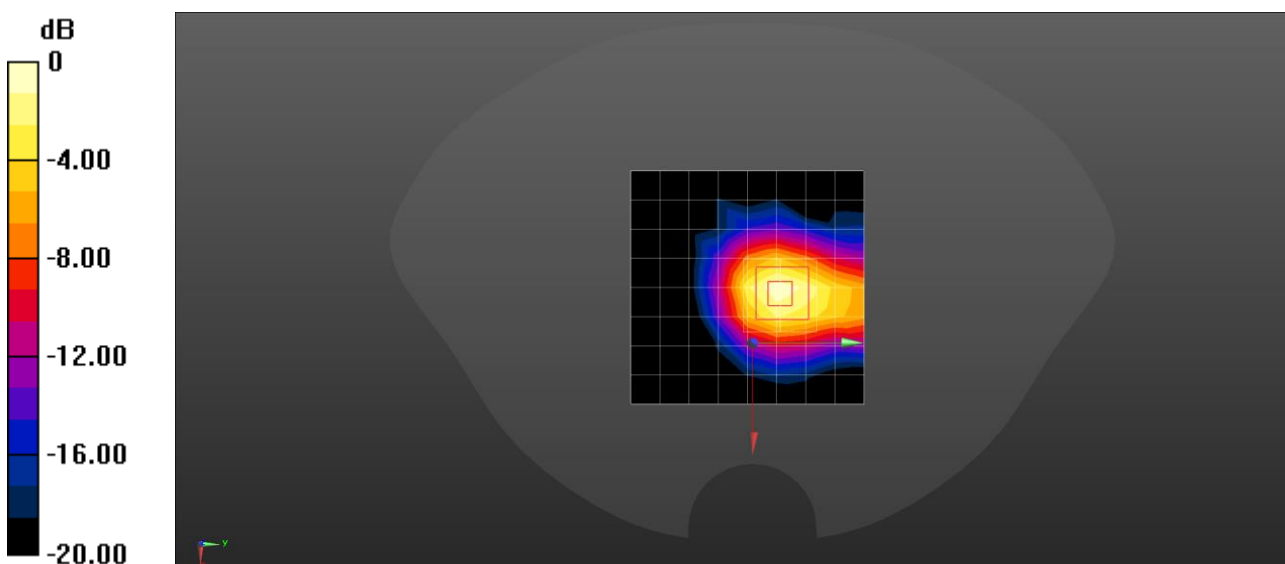

0 dB = 0.412 W/kg = -3.85 dBW/kg



Appendix C. Probe Calibration Data



Add: No.52 HuaYuanBei Road, Haidian District, Beijing, 100191, China
 Tel: +86-10-62304633-2512 Fax: +86-10-62304633-2504
 E-mail: cttl@chinattl.com Http://www.chinattl.cn



中国认可
 国际互认
 校准
 CALIBRATION
 CNAS L0570

Client **Dekra-CN**

Certificate No: **Z22-60083**

CALIBRATION CERTIFICATE

Object: EX3DV4 - SN : 3710

Calibration Procedure(s): FF-Z11-004-02
 Calibration Procedures for Dosimetric E-field Probes

Calibration date: April 18, 2022

This calibration Certificate documents the traceability to national standards, which realize the physical units of measurements(SI). The measurements and the uncertainties with confidence probability are given on the following pages and are part of the certificate.

All calibrations have been conducted in the closed laboratory facility: environment temperature(22±3)°C and humidity<70%.

Calibration Equipment used (M&TE critical for calibration)

| Primary Standards | ID # | Cal Date(Calibrated by, Certificate No.) | Scheduled Calibration |
|--------------------------|-------------|--|-----------------------|
| Power Meter NRP2 | 101919 | 15-Jun-21(CTTL, No.J21X04466) | Jun-22 |
| Power sensor NRP-Z91 | 101547 | 15-Jun-21(CTTL, No.J21X04466) | Jun-22 |
| Power sensor NRP-Z91 | 101548 | 15-Jun-21(CTTL, No.J21X04466) | Jun-22 |
| Reference 10dBAttenuator | 18N50W-10dB | 20-Jan-21(CTTL, No.J21X00486) | Jan-23 |
| Reference 20dBAttenuator | 18N50W-20dB | 20-Jan-21(CTTL, No.J21X00485) | Jan-23 |
| Reference Probe EX3DV4 | SN 7307 | 26-May-21(SPEAG, No.EX3-7307_May21) | May-22 |
| Reference Probe EX3DV4 | SN 7464 | 26-Jan-22(SPEAG, No.EX3-7464_Jan22) | Jan-23 |
| DAE4 | SN 1555 | 20-Aug-21(SPEAG, No.DAE4-1555_Aug21/2) | Aug-22 |
| Secondary Standards | ID # | Cal Date(Calibrated by, Certificate No.) | Scheduled Calibration |
| SignalGenerator MG3700A | 6201052605 | 16-Jun-21(CTTL, No.J21X04467) | Jun-22 |
| Network Analyzer E5071C | MY46110673 | 14-Jan-22(CTTL, No.J22X00406) | Jan-23 |

| | Name | Function | Signature |
|----------------|-------------|--------------------|-----------|
| Calibrated by: | Yu Zongying | SAR Test Engineer | |
| Reviewed by: | Lin Hao | SAR Test Engineer | |
| Approved by: | Qi Dianyuan | SAR Project Leader | |

Issued: April 19, 2022

This calibration certificate shall not be reproduced except in full without written approval of the laboratory.



Add: No.52 HuaYuanBei Road, Haidian District, Beijing, 100191, China
 Tel: +86-10-62304633-2512 Fax: +86-10-62304633-2504
 E-mail: cttl@chinattl.com [Http://www.chinattl.cn](http://www.chinattl.cn)



Glossary:

| | |
|-----------------------|---|
| TSL | tissue simulating liquid |
| NORM _{x,y,z} | sensitivity in free space |
| ConvF | sensitivity in TSL / NORM _{x,y,z} |
| DCP | diode compression point |
| CF | crest factor (1/duty_cycle) of the RF signal |
| A,B,C,D | modulation dependent linearization parameters |
| Polarization Φ | Φ rotation around probe axis |
| Polarization θ | θ rotation around an axis that is in the plane normal to probe axis (at measurement center), i θ=0 is normal to probe axis |

Connector Angle information used in DASY system to align probe sensor X to the robot coordinate system

Calibration is Performed According to the Following Standards:

- a) IEEE Std 1528-2013, "IEEE Recommended Practice for Determining the Peak Spatial-Averaged Specific Absorption Rate (SAR) in the Human Head from Wireless Communications Devices: Measurement Techniques", June 2013
- b) IEC 62209-1, "Measurement procedure for the assessment of Specific Absorption Rate (SAR) from hand-held and body-mounted devices used next to the ear (frequency range of 300 MHz to 6 GHz)", July 2016
- c) IEC 62209-2, "Procedure to determine the Specific Absorption Rate (SAR) for wireless communication devices used in close proximity to the human body (frequency range of 30 MHz to 6 GHz)", March 2010
- d) KDB 865664, "SAR Measurement Requirements for 100 MHz to 6 GHz"

Methods Applied and Interpretation of Parameters:

- NORM_{x,y,z}: Assessed for E-field polarization θ=0 (f≤900MHz in TEM-cell; f>1800MHz: waveguide). NORM_{x,y,z} are only intermediate values, i.e., the uncertainties of NORM_{x,y,z} does not effect the E²-field uncertainty inside TSL (see below ConvF).
- NORM(f)_{x,y,z} = NORM_{x,y,z}* frequency_response (see Frequency Response Chart). This linearization is implemented in DASY4 software versions later than 4.2. The uncertainty of the frequency response is included in the stated uncertainty of ConvF.
- DCP_{x,y,z}: DCP are numerical linearization parameters assessed based on the data of power sweep (no uncertainty required). DCP does not depend on frequency nor media.
- PAR: PAR is the Peak to Average Ratio that is not calibrated but determined based on the signal characteristics.
- Ax,y,z; Bx,y,z; Cx,y,z; VRx,y,z; A,B,C are numerical linearization parameters assessed based on the data of power sweep for specific modulation signal. The parameters do not depend on frequency nor media. VR is the maximum calibration range expressed in RMS voltage across the diode.
- ConvF and Boundary Effect Parameters: Assessed in flat phantom using E-field (or Temperature Transfer Standard for f≤800MHz) and inside waveguide using analytical field distributions based on power measurements for f >800MHz. The same setups are used for assessment of the parameters applied for boundary compensation (alpha, depth) of which typical uncertainty valued are given. These parameters are used in DASY4 software to improve probe accuracy close to the boundary. The sensitivity in TSL corresponds to NORM_{x,y,z}* ConvF whereby the uncertainty corresponds to that given for ConvF. A frequency dependent ConvF is used in DASY version 4.4 and higher which allows extending the validity from ±50MHz to ±100MHz.
- Spherical isotropy (3D deviation from isotropy): in a field of low gradients realized using a flat phantom exposed by a patch antenna.
- Sensor Offset: The sensor offset corresponds to the offset of virtual measurement center from the probe tip (on probe axis). No tolerance required.
- Connector Angle: The angle is assessed using the information gained by determining the NORM_x (no uncertainty required).



In Collaboration with
s p e a g
CALIBRATION LABORATORY



Add: No.52 HuaYuanBei Road, Haidian District, Beijing, 100191, China
Tel: +86-10-62304633-2512 Fax: +86-10-62304633-2504
E-mail: cttl@chinattl.com [Http://www.chinattl.cn](http://www.chinattl.cn)

DASY/EASY – Parameters of Probe: EX3DV4 – SN:3710

Basic Calibration Parameters

| | Sensor X | Sensor Y | Sensor Z | Unc (k=2) |
|--|----------|----------|----------|--------------|
| Norm($\mu\text{V}/(\text{V}/\text{m})^2$) ^A | 0.37 | 0.41 | 0.49 | $\pm 10.0\%$ |
| DCP(mV) ^B | 101.9 | 102.3 | 102.5 | |

Modulation Calibration Parameters

| UID | Communication System Name | | A dB | B dB $\sqrt{\mu\text{V}}$ | C | D dB | VR mV | Unc ^E (k=2) |
|-----|---------------------------|---|------|---------------------------|-----|------|-------|------------------------|
| 0 | CW | X | 0.0 | 0.0 | 1.0 | 0.00 | 140.6 | $\pm 2.1\%$ |
| | | Y | 0.0 | 0.0 | 1.0 | | 148.8 | |
| | | Z | 0.0 | 0.0 | 1.0 | | 170.6 | |

The reported uncertainty of measurement is stated as the standard uncertainty of Measurement multiplied by the coverage factor $k=2$, which for a normal distribution Corresponds to a coverage probability of approximately 95%.

^A The uncertainties of Norm X, Y, Z do not affect the E²-field uncertainty inside TSL (see Page 4).

^B Numerical linearization parameter: uncertainty not required.

^E Uncertainty is determined using the max. deviation from linear response applying rectangular distribution and is expressed for the square of the field value.



Add: No.52 HuaYuanBei Road, Haidian District, Beijing, 100191, China
 Tel: +86-10-62304633-2512 Fax: +86-10-62304633-2504
 E-mail: cttl@chinattl.com [Http://www.chinattl.cn](http://www.chinattl.cn)



DASY/EASY – Parameters of Probe: EX3DV4 – SN:3710

Calibration Parameter Determined in Head Tissue Simulating Media

| f [MHz] ^C | Relative Permittivity ^F | Conductivity (S/m) ^F | ConvF X | ConvF Y | ConvF Z | Alpha ^G | Depth ^G (mm) | Unct. (k=2) |
|----------------------|------------------------------------|---------------------------------|---------|---------|---------|--------------------|-------------------------|-------------|
| 750 | 41.9 | 0.89 | 9.60 | 9.60 | 9.60 | 0.17 | 1.28 | ±12.1% |
| 835 | 41.5 | 0.90 | 9.31 | 9.31 | 9.31 | 0.15 | 1.41 | ±12.1% |
| 900 | 41.5 | 0.97 | 9.30 | 9.30 | 9.30 | 0.17 | 1.27 | ±12.1% |
| 1810 | 40.0 | 1.40 | 7.90 | 7.90 | 7.90 | 0.30 | 0.93 | ±12.1% |
| 1900 | 40.0 | 1.40 | 7.80 | 7.80 | 7.80 | 0.32 | 0.94 | ±12.1% |
| 2300 | 39.5 | 1.67 | 7.66 | 7.66 | 7.66 | 0.57 | 0.71 | ±12.1% |
| 2450 | 39.2 | 1.80 | 7.39 | 7.39 | 7.39 | 0.61 | 0.69 | ±12.1% |
| 2600 | 39.0 | 1.96 | 7.18 | 7.18 | 7.18 | 0.53 | 0.76 | ±12.1% |
| 3300 | 38.2 | 2.71 | 7.00 | 7.00 | 7.00 | 0.43 | 0.93 | ±13.3% |
| 3500 | 37.9 | 2.91 | 6.78 | 6.78 | 6.78 | 0.45 | 0.98 | ±13.3% |
| 3700 | 37.7 | 3.12 | 6.49 | 6.49 | 6.49 | 0.42 | 1.02 | ±13.3% |
| 3900 | 37.5 | 3.32 | 6.55 | 6.55 | 6.55 | 0.35 | 1.35 | ±13.3% |
| 4100 | 37.2 | 3.53 | 6.53 | 6.53 | 6.53 | 0.40 | 1.15 | ±13.3% |
| 4200 | 37.1 | 3.63 | 6.44 | 6.44 | 6.44 | 0.40 | 1.25 | ±13.3% |
| 4400 | 36.9 | 3.84 | 6.34 | 6.34 | 6.34 | 0.40 | 1.25 | ±13.3% |
| 4600 | 36.7 | 4.04 | 6.23 | 6.23 | 6.23 | 0.45 | 1.25 | ±13.3% |
| 4800 | 36.4 | 4.25 | 6.18 | 6.18 | 6.18 | 0.45 | 1.30 | ±13.3% |
| 4950 | 36.3 | 4.40 | 5.87 | 5.87 | 5.87 | 0.45 | 1.30 | ±13.3% |
| 5250 | 35.9 | 4.71 | 5.40 | 5.40 | 5.40 | 0.45 | 1.30 | ±13.3% |
| 5600 | 35.5 | 5.07 | 4.85 | 4.85 | 4.85 | 0.55 | 1.20 | ±13.3% |
| 5750 | 35.4 | 5.22 | 4.88 | 4.88 | 4.88 | 0.55 | 1.20 | ±13.3% |

^C Frequency validity above 300 MHz of ±100MHz only applies for DASY v4.4 and higher (Page 2), else it is restricted to ±50MHz. The uncertainty is the RSS of ConvF uncertainty at calibration frequency and the uncertainty for the indicated frequency band. Frequency validity below 300 MHz is ± 10, 25, 40, 50 and 70 MHz for ConvF assessments at 30, 64, 128, 150 and 220 MHz respectively. Above 5 GHz frequency validity can be extended to ± 110 MHz.

^F At frequency below 3 GHz, the validity of tissue parameters (ϵ and σ) can be relaxed to ±10% if liquid compensation formula is applied to measured SAR values. At frequencies above 3 GHz, the validity of tissue parameters (ϵ and σ) is restricted to ±5%. The uncertainty is the RSS of the ConvF uncertainty for indicated target tissue parameters.

^G Alpha/Depth are determined during calibration. SPEAG warrants that the remaining deviation due to the boundary effect after compensation is always less than ± 1% for frequencies below 3 GHz and below ± 2% for the frequencies between 3-6 GHz at any distance larger than half the probe tip diameter from the boundary.



In Collaboration with
s p e a g
CALIBRATION LABORATORY

Add: No.52 HuaYuanBei Road, Haidian District, Beijing, 100191, China
Tel: +86-10-62304633-2512 Fax: +86-10-62304633-2504
E-mail: cttl@chinattl.com [Http://www.chinattl.cn](http://www.chinattl.cn)



Frequency Response of E-Field (TEM-Cell: ifi110 EXX, Waveguide: R22)

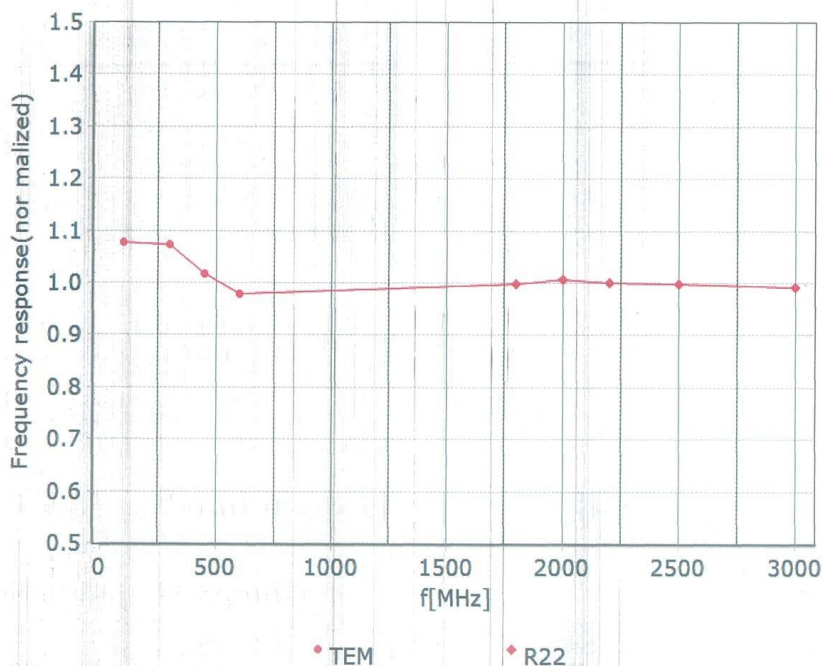

Uncertainty of Frequency Response of E-field: $\pm 7.4\%$ ($k=2$)



Add: No.52 HuaYuanBei Road, Haidian District, Beijing, 100191, China
 Tel: +86-10-62304633-2512 Fax: +86-10-62304633-2504
 E-mail: cttl@chinattl.com [Http://www.chinattl.cn](http://www.chinattl.cn)

Receiving Pattern (Φ), $\theta=0^\circ$

f=600 MHz, TEM

f=1800 MHz, R22

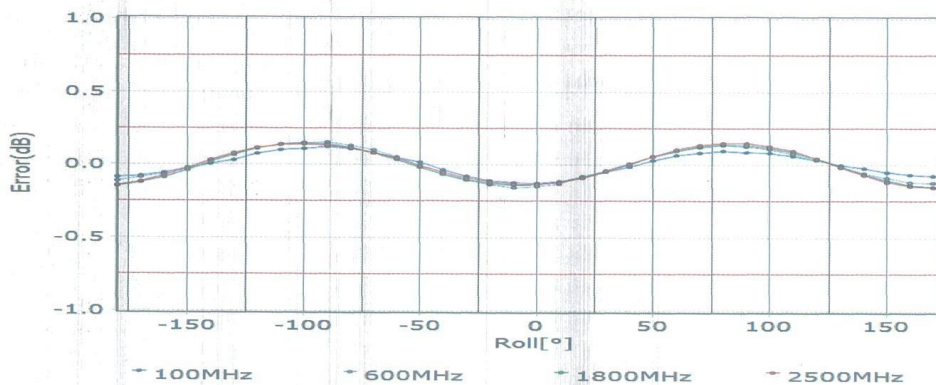
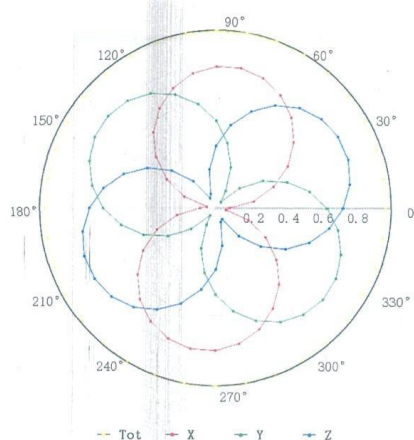
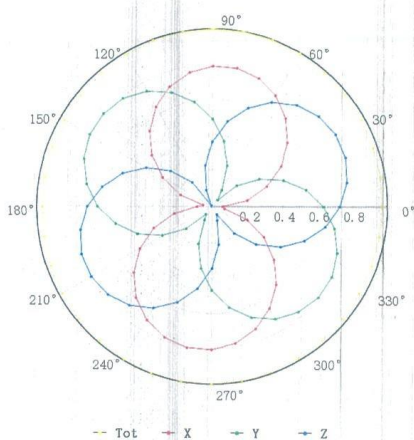

Uncertainty of Axial Isotropy Assessment: $\pm 1.2\%$ ($k=2$)

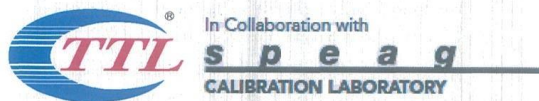

Add: No.52 HuaYuanBei Road, Haidian District, Beijing, 100191, China
 Tel: +86-10-62304633-2512 Fax: +86-10-62304633-2504
 E-mail: cttl@chinattl.com [Http://www.chinattl.cn](http://www.chinattl.cn)



Dynamic Range f(SAR_{head}) (TEM cell, f = 900 MHz)

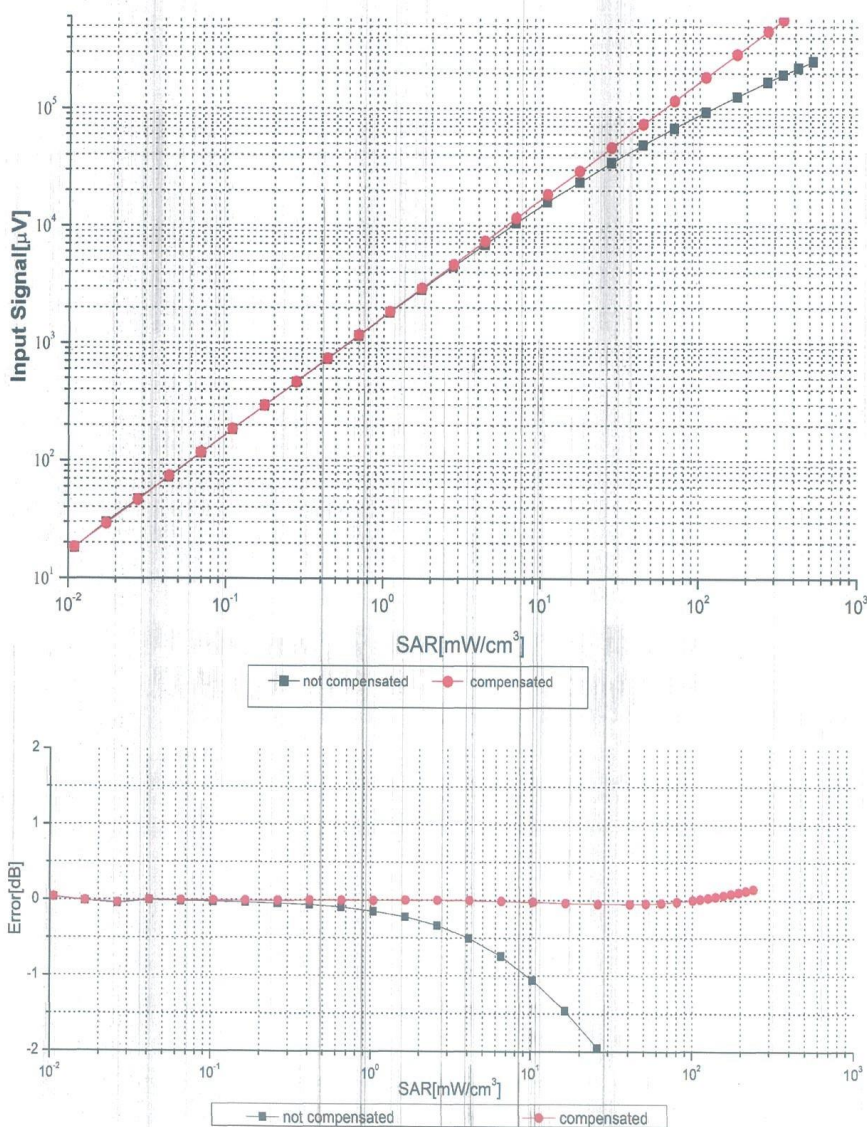

Uncertainty of Linearity Assessment: ±0.9% (k=2)

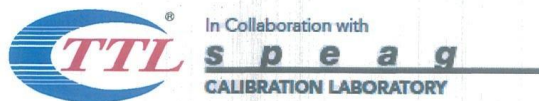

In Collaboration with
 Add: No.52 HuaYuanBei Road, Haidian District, Beijing, 100191, China
 Tel: +86-10-62304633-2512 Fax: +86-10-62304633-2504
 E-mail: cttl@chinattl.com [Http://www.chinattl.cn](http://www.chinattl.cn)



Conversion Factor Assessment

f=750 MHz,WGLS R9(H_convF)

f=1810 MHz,WGLS R22(H_convF)

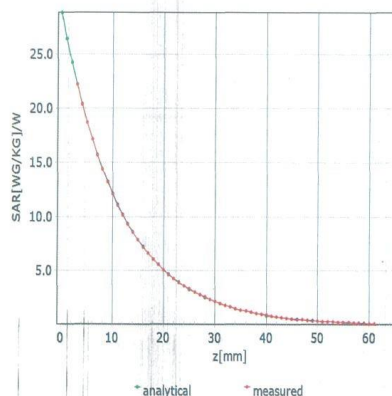
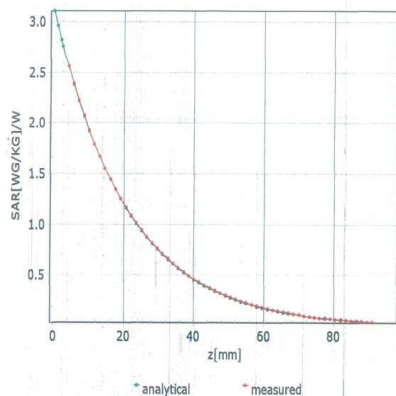

Deviation from Isotropy in Liquid

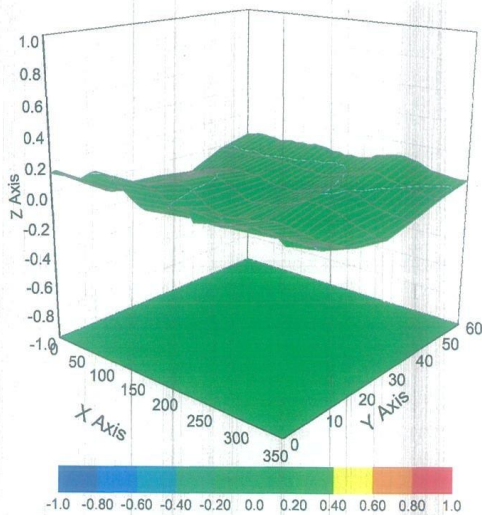

Uncertainty of Spherical Isotropy Assessment: $\pm 3.2\%$ ($k=2$)

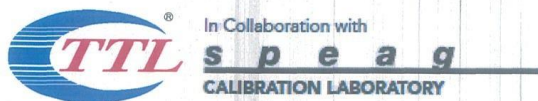

Add: No.52 HuaYuanBei Road, Haidian District, Beijing, 100191, China
 Tel: +86-10-62304633-2512 Fax: +86-10-62304633-2504
 E-mail: cttl@chinattl.com [Http://www.chinattl.cn](http://www.chinattl.cn)

DASY/EASY – Parameters of Probe: EX3DV4 – SN:3710

Other Probe Parameters

| | |
|---|------------|
| Sensor Arrangement | Triangular |
| Connector Angle (°) | 81.3 |
| Mechanical Surface Detection Mode | enabled |
| Optical Surface Detection Mode | disable |
| Probe Overall Length | 337mm |
| Probe Body Diameter | 10mm |
| Tip Length | 9mm |
| Tip Diameter | 2.5mm |
| Probe Tip to Sensor X Calibration Point | 1mm |
| Probe Tip to Sensor Y Calibration Point | 1mm |
| Probe Tip to Sensor Z Calibration Point | 1mm |
| Recommended Measurement Distance from Surface | 1.4mm |



Appendix D. Dipole Calibration Data



Add: No.52 HuaYuanBei Road, Haidian District, Beijing, 100191
 Tel: +86-10-62304633-2512 Fax: +86-10-62304633-2504
 E-mail: cttl@chinattl.com Http://www.chinattl.cn



中国认可
 国际互认
 校准
 CALIBRATION
 CNAS L0570



Client **Dekra-CN**

Certificate No: **Z22-60089**

CALIBRATION CERTIFICATE

Object: **D2450V2 - SN: 839**

Calibration Procedure(s): **FF-Z11-003-01**
 Calibration Procedures for dipole validation kits

Calibration date: **April 1, 2022**

This calibration Certificate documents the traceability to national standards, which realize the physical units of measurements (SI). The measurements and the uncertainties with confidence probability are given on the following pages and are part of the certificate.

All calibrations have been conducted in the closed laboratory facility: environment temperature (22±3)°C and humidity<70%.

Calibration Equipment used (M&TE critical for calibration)

| Primary Standards | ID # | Cal Date (Calibrated by, Certificate No.) | Scheduled Calibration |
|-------------------------|------------|---|-----------------------|
| Power Meter NRP2 | 106277 | 24-Sep-21 (CTTL, No.J21X08326) | Sep-22 |
| Power sensor NRP8S | 104291 | 24-Sep-21 (CTTL, No.J21X08326) | Sep-22 |
| Reference Probe EX3DV4 | SN 7307 | 26-May-21(SPEAG,No.EX3-7307_May21) | May-22 |
| DAE4 | SN 1556 | 12-Jan-22(CTTL-SPEAG,No.Z22-60007) | Jan-23 |
| Secondary Standards | ID # | Cal Date (Calibrated by, Certificate No.) | Scheduled Calibration |
| Signal Generator E4438C | MY49071430 | 13-Jan-22 (CTTL, No. J22X00409) | Jan-23 |
| Network Analyzer E5071C | MY46110673 | 14-Jan-22 (CTTL, No.J22X00406) | Jan-23 |

| | Name | Function | Signature |
|----------------|-------------|--------------------|-----------|
| Calibrated by: | Zhao Jing | SAR Test Engineer | |
| Reviewed by: | Lin Hao | SAR Test Engineer | |
| Approved by: | Qi Dianyuan | SAR Project Leader | |

Issued: April 6, 2022

This calibration certificate shall not be reproduced except in full without written approval of the laboratory.



Add: No.52 HuaYuanBei Road, Haidian District, Beijing, 100191, China
Tel: +86-10-62304633-2079 Fax: +86-10-62304633-2504
E-mail: cttl@chinattl.com http://www.chinattl.cn

Glossary:

| | |
|-------|--|
| TSL | tissue simulating liquid |
| ConvF | sensitivity in TSL / NORM _{x,y,z} |
| N/A | not applicable or not measured |

Calibration is Performed According to the Following Standards:

- a) IEC/IEEE 62209-1528, "Measurement Procedure for The Assessment of Specific Absorption Rate of Human Exposure to Radio Frequency Fields from Hand-held and Body-mounted Wireless Communication Devices- Part 1528: Human Models, Instrumentation and Procedures (Frequency range of 4 MHz to 10 GHz)", October 2020
- b) KDB 865664, "SAR Measurement Requirements for 100 MHz to 6 GHz"

Additional Documentation:

- c) DASY4/5 System Handbook

Methods Applied and Interpretation of Parameters:

- *Measurement Conditions:* Further details are available from the Validation Report at the end of the certificate. All figures stated in the certificate are valid at the frequency indicated.
- *Antenna Parameters with TSL:* The dipole is mounted with the spacer to position its feed point exactly below the center marking of the flat phantom section, with the arms oriented parallel to the body axis.
- *Feed Point Impedance and Return Loss:* These parameters are measured with the dipole positioned under the liquid filled phantom. The impedance stated is transformed from the measurement at the SMA connector to the feed point. The Return Loss ensures low reflected power. No uncertainty required.
- *Electrical Delay:* One-way delay between the SMA connector and the antenna feed point. No uncertainty required.
- *SAR measured:* SAR measured at the stated antenna input power.
- *SAR normalized:* SAR as measured, normalized to an input power of 1 W at the antenna connector.
- *SAR for nominal TSL parameters:* The measured TSL parameters are used to calculate the nominal SAR result.

The reported uncertainty of measurement is stated as the standard uncertainty of Measurement multiplied by the coverage factor $k=2$, which for a normal distribution corresponds to a coverage probability of approximately 95%.



Add: No.52 HuaYuanBei Road, Haidian District, Beijing, 100191, China
 Tel: +86-10-62304633-2079 Fax: +86-10-62304633-2504
 E-mail: cttl@chinattl.com http://www.chinattl.cn

Measurement Conditions

DASY system configuration, as far as not given on page 1.

| | | |
|------------------------------|--------------------------|-------------|
| DASY Version | DASY52 | 52.10.4 |
| Extrapolation | Advanced Extrapolation | |
| Phantom | Triple Flat Phantom 5.1C | |
| Distance Dipole Center - TSL | 10 mm | with Spacer |
| Zoom Scan Resolution | dx, dy, dz = 5 mm | |
| Frequency | 2450 MHz ± 1 MHz | |

Head TSL parameters

The following parameters and calculations were applied.

| | Temperature | Permittivity | Conductivity |
|---|-----------------|--------------|------------------|
| Nominal Head TSL parameters | 22.0 °C | 39.2 | 1.80 mho/m |
| Measured Head TSL parameters | (22.0 ± 0.2) °C | 39.5 ± 6 % | 1.79 mho/m ± 6 % |
| Head TSL temperature change during test | <1.0 °C | ---- | ---- |

SAR result with Head TSL

| | | |
|---|--------------------|--------------------------|
| SAR averaged over 1 cm ³ (1 g) of Head TSL | Condition | |
| SAR measured | 250 mW input power | 13.1 W/kg |
| SAR for nominal Head TSL parameters | normalized to 1W | 52.6 W/kg ± 18.8 % (k=2) |
| SAR averaged over 10 cm ³ (10 g) of Head TSL | Condition | |
| SAR measured | 250 mW input power | 6.05 W/kg |
| SAR for nominal Head TSL parameters | normalized to 1W | 24.3 W/kg ± 18.7 % (k=2) |



Add: No.52 HuaYuanBei Road, Haidian District, Beijing, 100191, China
 Tel: +86-10-62304633-2079 Fax: +86-10-62304633-2504
 E-mail: cttl@chinattl.com http://www.chinattl.cn

Appendix (Additional assessments outside the scope of CNAS L0570)

Antenna Parameters with Head TSL

| | |
|--------------------------------------|---------------|
| Impedance, transformed to feed point | 54.0Ω+ 3.60jΩ |
| Return Loss | - 25.7dB |

General Antenna Parameters and Design

| | |
|----------------------------------|----------|
| Electrical Delay (one direction) | 1.067 ns |
|----------------------------------|----------|

After long term use with 100W radiated power, only a slight warming of the dipole near the feed-point can be measured.

The dipole is made of standard semirigid coaxial cable. The center conductor of the feeding line is directly connected to the second arm of the dipole. The antenna is therefore short-circuited for DC-signals. On some of the dipoles, small end caps are added to the dipole arms in order to improve matching when loaded according to the position as explained in the "Measurement Conditions" paragraph. The SAR data are not affected by this change. The overall dipole length is still according to the Standard. No excessive force must be applied to the dipole arms, because they might bend or the soldered connections near the feed-point may be damaged.

Additional EUT Data

| | |
|-----------------|-------|
| Manufactured by | SPEAG |
|-----------------|-------|



Add: No.52 HuaYuanBei Road, Haidian District, Beijing, 100191, China
 Tel: +86-10-62304633-2079 Fax: +86-10-62304633-2504
 E-mail: cttl@chinattl.com http://www.chinattl.cn

DASY5 Validation Report for Head TSL

Date: 2022-04-01

Test Laboratory: CTTL, Beijing, China

DUT: Dipole 2450 MHz; Type: D2450V2; Serial: D2450V2 - SN: 839

Communication System: UID 0, CW; Frequency: 2450 MHz; Duty Cycle: 1:1

Medium parameters used: $f = 2450$ MHz; $\sigma = 1.79$ S/m; $\epsilon_r = 39.52$; $\rho = 1000$ kg/m³

Phantom section: Right Section

Measurement Standard: DASY5 (IEEE/IEC/ANSI C63.19-2007)

DASY5 Configuration:

- Probe: EX3DV4 - SN7307; ConvF(7.75, 7.75, 7.75) @ 2450 MHz; Calibrated: 2021-05-26
- Sensor-Surface: 1.4mm (Mechanical Surface Detection)
- Electronics: DAE4 Sn1556; Calibrated: 2022-01-12
- Phantom: MFP_V5.1C (20deg probe tilt); Type: QD 000 P51 Cx; Serial: 1062
- DASY52 52.10.4(1535); SEMCAD X 14.6.14(7501)

Dipole Calibration/Zoom Scan (7x7x7) (7x7x7)/Cube 0: Measurement grid: dx=5mm, dy=5mm, dz=5mm

Reference Value = 106.0 V/m; Power Drift = -0.03 dB

Peak SAR (extrapolated) = 26.6 W/kg

SAR(1 g) = 13.1 W/kg; SAR(10 g) = 6.05 W/kg

Smallest distance from peaks to all points 3 dB below = 9 mm

Ratio of SAR at M2 to SAR at M1 = 49.3%

Maximum value of SAR (measured) = 21.7 W/kg

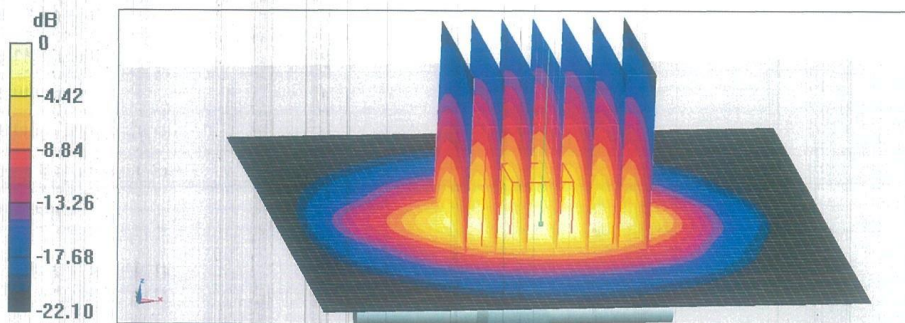

0 dB = 21.7 W/kg = 13.36 dBW/kg