

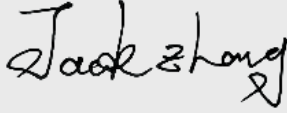

Test report No:
22A0151R-RF-US-P06V01

FCC TEST REPORT

Product Name	AH80 Bluetooth Headset Dongle
Trademark	Alcatel-Lucent Enterprise
Model and /or type reference	AH80
FCC ID	OL3AH80DONGLE
Applicant's name / address	ALE International 32, Avenue Kléber – 92700 Colombes – FRANCE
Test method requested, standard	FCC CFR Title 47 Part 15 Subpart C Section 15.247 ANSI C63.10: 2013 KD558074 D01 15.247 Meas Guidance v05r02
Verdict Summary	IN COMPLIANCE
Tested by (name / position & signature)	Jun Xu/ Project Engineer 
Approved by (name / position & signature)	Jack Zhang/ Manager 
Date of issue	2022-10-26
Report Version	V1.0
Report template No	Template_FCC 15.247-RF-V1.0

INDEX

	page
General conditions	5
Environmental conditions	5
Possible test case verdicts	6
Abbreviations.....	6
Document History.....	7
Remarks and Comments	7
Used Equipment.....	8
Uncertainty	10
1 General Information	11
1.1 General Description of the Item(s).....	11
1.2 Antenna Information	12
1.3 Channel List.....	13
2 Description of Test Setup.....	14
2.1 Operating mode(s) used for tests	14
2.2 Auxiliary equipment / Test software for the EUT	14
2.3 Test Configuration / Block diagram used for tests.....	15
2.4 Testing process	16
3 Verdict summary section.....	17
3.1 Standards	17
3.2 Deviation(s) from the Standard(s) / Test Specification(s).....	17
3.3 Overview of results	18
3.4 Test Facility.....	19
4 Test Results	20
4.1 Conducted Emission.....	20
4.1.1 Limit	20
4.1.2 Test Setup	20
4.1.3 Test Procedure	20
4.1.4 Test Data	21
4.2 Emissions in restricted frequency bands	22
4.2.1 Limit	22
4.2.2 Test Setup	24
4.2.3 Test Procedure	25
4.2.4 Test Data	26
4.3 20dB Bandwidth.....	46

4.3.1	Limit	46
4.3.2	Test Setup	46
4.3.3	Test Procedure	46
4.3.4	Test Data	47
4.4	CarrierFrequencySeparation	48
4.4.1	Limit	48
4.4.2	Test Setup	48
4.4.3	Test Procedure	48
4.4.4	Test Data	49
4.5	Number of hopping Frequencies	50
4.5.1	Limit	50
4.5.2	Test Setup	50
4.5.3	Test Procedure	50
4.5.4	Test Data	51
4.6	Time of Occupancy(Dwell Time)	52
4.6.1	Limit	52
4.6.2	Test Setup	52
4.6.3	Test Procedure	52
4.6.4	Test Data	53
4.7	Peak Output Power.....	56
4.7.1	Limit	56
4.7.2	Test Setup	56
4.7.3	Test Procedure	57
4.7.4	Test Data	58
4.8	Emissions in non-restricted frequency band	59
4.8.1	Limit	59
4.8.2	Test Setup	59
4.8.3	Test Procedure	59
4.8.4	Test Data	60
4.9	Duty cycle	64
4.9.1	Limit	64
4.9.2	Test Setup	64
4.9.3	Test Procedure	64
4.9.4	Test Data	65
4.10	Band Edge	66
4.10.1	Limit	66
4.10.2	Test Setup	66

4.10.3	Test Procedure	66
4.10.4	Test Data	67
4.11	Antenna Requirement.....	91
4.11.1	Limit:	91
4.11.2	Antenna Connector Construction:	91
5	Test setup photo and EUT Photo	92

COMPETENCES AND GUARANTEES

DEKRA is a testing laboratory competent to carry out the tests described in this report.

In order to assure the traceability to other national and international laboratories, DEKRA has a calibration and maintenance program for its measurement equipment.

DEKRA guarantees the reliability of the data presented in this report, which is the result of the measurements and the tests performed to the item under test on the date and under the conditions stated in the report and it is based on the knowledge and technical facilities available at DEKRA at the time of performance of the test.

DEKRA is liable to the client for the maintenance of the confidentiality of all information related to the item under test and the results of the test.

The results presented in this Test Report apply only to the particular item under test established in this document.

IMPORTANT: No parts of this report may be reproduced or quoted out of context, in any form or by any means, except in full, without the previous written permission of DEKRA.

GENERAL CONDITIONS

Test Location	No. 99, Hongye Road, Suzhou Industrial Park Suzhou, 215006, P.R. China
Date(receive sample)	Jun. 22, 2022
Date (start test)	Jul. 29, 2022
Date (finish test)	Aug. 22, 2022

1. This report is only referred to the item that has undergone the test.
2. This report does not constitute or imply on its own an approval of the product by the Certification Bodies or Competent Authorities.
3. This document is only valid if complete; no partial reproduction can be made without previous written permission of DEKRA.
4. This test report cannot be used partially or in full for publicity and/or promotional purposes without previous written permission of DEKRA.

ENVIRONMENTAL CONDITIONS

The climatic conditions during the tests are within the limits specified by the manufacturer for the operation of the EUT and the test equipment. The climatic conditions during the tests were within the following limits:

Ambient temperature	15 °C – 35 °C
Relative Humidity air	30% - 60%

If explicitly required in the basic standard or applied product / product family standard the climatic values are recorded and documented separately in this test report.

POSSIBLE TEST CASE VERDICTS

Test case does not apply to test object	N/A
Test object does meet requirement	P (Pass) / PASS
Test object does not meet requirement	F (Fail) / FAIL
Not measured	N/M

ABBREVIATIONS

For the purposes of the present document, the following abbreviations apply:

EUT	: Equipment Under Test
QP	: Quasi-Peak
CAV	: CISPR Average
AV	: Average
CDN	: Coupling Decoupling Network
SAC	: Semi-Anechoic Chamber
OATS	: Open Area Test Site
BW	: Bandwidth
AM	: Amplitude Modulation
PM	: Pulse Modulation
HCP	: Horizontal Coupling Plane
VCP	: Vertical Coupling Plane
U_N	: Nominal voltage
T_x	: Transmitter
R_x	: Receiver
N/A	: Not Applicable
N/M	: Not Measured

DOCUMENT HISTORY

Report No.	Version	Description	Issued Date
22A0151R-RF-US-P06V01	V1.0	Initial issue of report.	2022-10-26

REMARKS AND COMMENTS

1. The equipment under test (EUT) does meet the essential requirements of the stated standard(s)/test(s).
2. These test results on a sample of the device are for the purpose of demonstrating Compliance with Part 15 Subpart C Paragraph 15.247.
3. The measurement result is considered in conformance with the requirement if it is within the prescribed limit, It is not necessary to account the uncertainty associated with the measurement result.
4. The test results presented in this report relate only to the object tested.
5. The test report shall not be reproduced without the written approval of DEKRA Testing and Certification (Suzhou) Co., Ltd.
6. This report will not be used for social proof function in China market.
7. DEKRA declines any responsibility with the following test data provided by customer that may affect the validity of result:
 - Chapter 1.1 General Description of the Item(s);
 - Chapter 1.2 Antenna Information;
 - Chapter 1.3Channel List.

USED EQUIPMENT

AC Power Line Conducted Emission / TR1

Instrument	Manufacturer	Model No.	Serial No.	Cal. Date	Next Cal. Date
EMI Test Receiver	R&S	ESCI	101668	2021.10.30	2022.10.29
Two-Line V-Network	R&S	ENV216	101044	2022.07.01	2023.06.30
Two-Line V-Network	R&S	ENV 216	101189	2022.03.12	2023.03.11
50ohm Coaxial Switch	Anritsu	MP59B	6200464462	N/A	N/A
Temperature/Humidity Meter	RTS	RTS-8S	TR1-TH	2022.07.07	2023.07.06
Dekra test software	Dekra	-	-	-	-

Emissions in non-restricted frequency bands/ Occupied Bandwidth/ Fundamental emission output power/ Power Spectral Density/Band Edge/ TR8

Instrument	Manufacturer	Model No.	Serial No.	Cal. Date	Next Cal. Date
Spectrum Analyzer	Agilent	N9010A	MY48030494	2021.12.15	2022.12.14
MXA Signal Analyzer	Keysight	N9020A	MY56060147	2022.07.14	2023.07.13
4TX MIMO Power Sensor	Keysight	X8750A	MY59400102	2022.03.16	2023.03.15
Coaxial Cable	N/A	N/A	No.2007	2022.06.07	2023.06.06
Temperature/Humidity Meter	RTS	RTS-8S	RF08	2022.07.07	2023.07.06

Radiated Emission(30MHz-1GHz) / AC2

Instrument	Manufacturer	Model No.	Serial No.	Cal. Date	Next Cal. Date
EMI Test Receiver	R&S	ESCI	100573	2021.10.30	2022.10.29
Loop Antenna	R&S	HFH2-Z2	833799/003	2022.04.15	2023.04.14
Bilog Antenna	Teseq GmbH	CBL6112D	27613	2022.08.28	2023.08.27
Coaxial Cable	Huber+Suhner	RG 214	AC3-C	2022.03.30	2023.03.29
Temperature/Humidity Meter	RTS	RTS-8S	AC3-TH	2021.11.23	2022.11.22
Dekra test software	Dekra	-	-	-	-

Radiated Emission(1GHz-40GHz) / AC5

Instrument	Manufacturer	Model No.	Serial No.	Cal. Date	Next Cal. Date
EXA Spectrum Analyzer	Keysight	N9020B	MY59050482	2021.11.18	2022.11.17
Preamplifier	EMCI	EMC184045SE	980263	2022.05.21	2023.05.20
DRG Horn Antenna	ETS-Lindgren	3117	00167055	2022.08.29	2023.08.28
Broad-Band Horn Antenna	Schwarzbeck	BBHA9170	294	2022.05.19	2023.05.18
Coaxial Cable	Huber+Suhner	SUCOFLEX 106	AC5-C2	2022.03.30	2023.03.29
Coaxial Cable	ROSENBERGER	LA1-C011- 2000/3000	AC5-40G	2022.03.21	2023.03.20
High-Pass Filter	Wainwright	WHKX3.0/18G- 12SS	AC5/AC6	2022.06.07	2023.06.06
Temperature/Humidity Meter	RTS	RTS-8S	AC5-TH	2022.07.07	2023.07.06
Dekra test software	Dekra	-	-	-	-

UNCERTAINTY

Uncertainties have been calculated according to the DEKRA internal document. The reported expanded uncertainties are based on a standard uncertainty multiplied by a coverage factor of $k=2$, providing a level of confidence of approximately 95%. The Uncertainties is comply with standard required as below.

Test item	Uncertainty
Conducted Emission	± 2.02 dB
Emissions in restricted frequency bands	above 1G : ± 3.9 dB below 1G is : ± 3.8 dB
20dB Bandwidth	± 1 kHz
Carrier Frequency Separation	± 1 kHz
Number of Hopping Frequencies	± 1 kHz
Time of Occupancy (Dwell Time)	± 0.1 us
Peak Output Power	± 1.0 dB
Emissions in non-restricted frequency bands	± 1.0 dB
Radiated Emission Band Edge	above 1G : ± 3.9 dB below 1G : ± 3.8 dB

1 GENERAL INFORMATION

1.1 General Description of the Item(s)

Product Name	AH80 Bluetooth Headset Dongle
Model No.	AH80
FCC ID	OL3AH80DONGLE
Manufacturer	ALE International
Manufacturer Address.....	32, Avenue Kléber – 92700 Colombes – FRANCE

Wireless specification.....	Bluetooth			
Bluetooth Specification.....	V3.0			
Operating frequency range(s)	2400~2483.5MHz			
Type of Modulation.....	GFSK			
PHYs	<input checked="" type="checkbox"/> GFSK	<input checked="" type="checkbox"/> Pi/4 DQPSK	<input checked="" type="checkbox"/> 8DPSK	
Data Rate	<input checked="" type="checkbox"/> 1Mbit/s	<input checked="" type="checkbox"/> 2Mbit/s	<input checked="" type="checkbox"/> 3Mbit/s	
Number of channel.....	79			

Rated power supply	Voltage and Frequency			
	<input type="checkbox"/>	AC: 220 – 240 V, 50/60 Hz		
	<input type="checkbox"/>	AC: 100 – 240 V, 50/60 Hz		
	<input type="checkbox"/>	Battery:3.7V		
	<input checked="" type="checkbox"/>	DC:5V		
Mounting position	<input type="checkbox"/>	Table top equipment		
	<input type="checkbox"/>	Wall/Ceiling mounted equipment		
	<input type="checkbox"/>	Floor standing equipment		
	<input type="checkbox"/>	Head-mounted equipment		
	<input checked="" type="checkbox"/>	Other: Bluetooth Headset Dongle		

1.2 Antenna Information

Antenna model / type number	N/A		
Antenna serial number	N/A		
Antenna Delivery	<input checked="" type="checkbox"/>	1TX + 1RX	
	<input type="checkbox"/>	2TX + 2RX	
	<input type="checkbox"/>	Others:.....	
Antenna technology	<input checked="" type="checkbox"/>	SISO	
	<input type="checkbox"/>	MIMO	<input type="checkbox"/> CDD
			<input type="checkbox"/> Beam-forming
Antenna Type	<input type="checkbox"/>	External	<input type="checkbox"/> Dipole
			<input type="checkbox"/> Sectorized
	<input checked="" type="checkbox"/>	Internal	<input type="checkbox"/> PIFA
			<input checked="" type="checkbox"/> PCB
			<input type="checkbox"/> Dipole
			<input type="checkbox"/> Others.....
Antenna Gain	3.2 dBi		

1.3 Channel List

Bluetooth Working Frequency of Each Channel:							
Channel	Frequency	Channel	Frequency	Channel	Frequency	Channel	Frequency
00	2402 MHz	01	2403 MHz	02	2404 MHz	03	2405 MHz
04	2406 MHz	05	2407 MHz	06	2408 MHz	07	2409 MHz
08	2410 MHz	09	2411 MHz	10	2412 MHz	11	2413 MHz
12	2414 MHz	13	2415 MHz	14	2416 MHz	15	2417 MHz
16	2418 MHz	17	2419 MHz	18	2420 MHz	19	2421 MHz
20	2422 MHz	21	2423 MHz	22	2424 MHz	23	2425 MHz
24	2426 MHz	25	2427 MHz	26	2428 MHz	27	2429 MHz
28	2430 MHz	29	2431 MHz	30	2432 MHz	31	2433 MHz
32	2434 MHz	33	2435 MHz	34	2436 MHz	35	2437 MHz
36	2438 MHz	37	2439 MHz	38	2440 MHz	39	2441 MHz
40	2442 MHz	41	2443 MHz	42	2444 MHz	43	2445 MHz
44	2446 MHz	45	2447 MHz	46	2448 MHz	47	2449 MHz
48	2450 MHz	49	2451 MHz	50	2452 MHz	51	2453 MHz
52	2454 MHz	53	2455 MHz	54	2456 MHz	55	2457 MHz
56	2458 MHz	57	2459 MHz	58	2460 MHz	59	2461 MHz
60	2462 MHz	61	2463 MHz	62	2464 MHz	63	2465 MHz
64	2466 MHz	65	2467 MHz	66	2468 MHz	67	2469 MHz
68	2470 MHz	69	2471 MHz	70	2472 MHz	71	2473 MHz
72	2474 MHz	73	2475 MHz	74	2476 MHz	75	2477 MHz
76	2478 MHz	77	2479 MHz	78	2480 MHz	N/A	N/A

Note: The general description of the Item(s), antenna information and channel list in clause 1 are provided and confirmed by the client.

2 DESCRIPTION OF TEST SETUP

2.1 Operating mode(s) used for tests

During the tests the following operating mode(s) has(have) been used.

Test Mode For Bluetooth	Mode 1: Transmitter-1Mbps(GFSK_DH5)
	Mode 2: Transmitter-2Mbps(Pi/4 DQPSK_DH5)
	Mode 3: Transmitter-3Mbps(8DPSK_DH5)
	Mode 4: Transmitter-Hopping-1Mbps(GFSK_DH5)
	Mode 5: Transmitter-Hopping-2Mbps(Pi/4 DQPSK_DH5)
	Mode 6: Transmitter-Hopping-3Mbps(8DPSK_DH5)

2.2 Accessories Information

Accessories Information	Brand/model name	Cable		
		Length used during test [m]	Attached during test	Shielded
USB Cable	N/A	10	<input checked="" type="checkbox"/>	<input checked="" type="checkbox"/>
USB Cable	N/A	0.5	<input checked="" type="checkbox"/>	<input checked="" type="checkbox"/>

2.3 Auxiliary equipment / Test software for the EUT

Auxiliary equipment	Type / Version	Manufacturer	Supplied by
Notebook	2526	Think Pad	N/A
Software	Type / Version	Manufacturer	Supplied by
InstallBlueSuiteCda	N/A	N/A	N/A

2.4 Test Configuration / Block diagram used for tests

Test setup Diagram- AC Line Conducted Emission Test

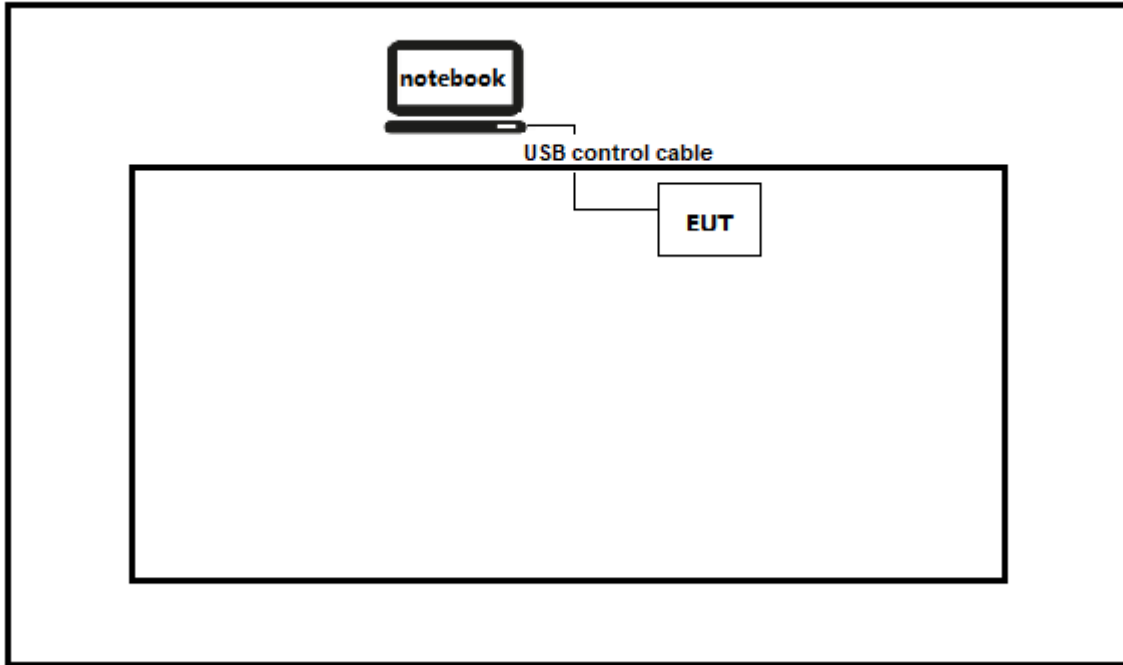

Test setup Diagram- Radiated Emission

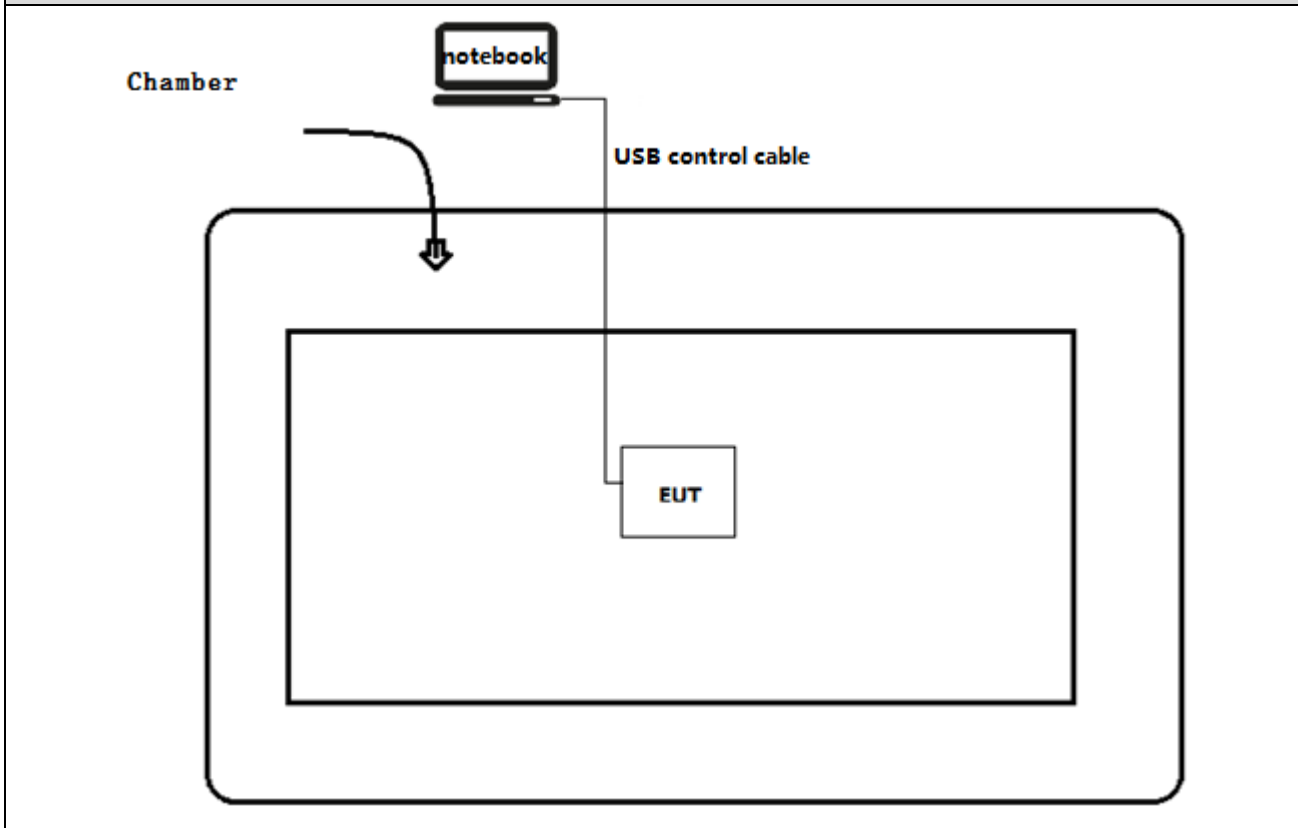

2.5 Testing process

1	Setup the EUT as shown in Section 2.3
2	Run the software "InstallBlueSuiteCda" on the notebook computer.
3	Open the serial port and enter the corresponding commands to configure the test mode, test channel, test power and data rate.
4	Verify that the EUT works properly.

3 VERDICT SUMMARY SECTION

This chapter presents an overview of standards and results. Refer to the next chapters for details of measured test results and applied test levels.

3.1 Standards

Standard	Year	Description
FCC CFR Title 47 Part 15 Subpart C Section 15.247	2021	Operation within the bands 902–928 MHz, 2400–2483.5 MHz, and 5725–5850 MHz.
ANSI C63.10	2013	American National Standard of Procedures for Compliance Testing of Unlicensed Wireless Devices
KDB558074 D01 v05r02	2019	Guidance for performing compliance measurements on Digital Transmission System (DTS) operating under section 15.247

3.2 Deviation(s) from the Standard(s) / Test Specification(s)

The following deviation(s) was / were made from the published requirements of the listed standards: N/A.

(Please define the deviations from the standard(s) if applicable)

3.3 Overview of results

For FCC

Performed Test Item	Normative References	Test Performed	Deviation
Conducted Emission	FCC CFR Title 47 Part 15 Subpart C: 2015Section 15.207	N/A	No
Emissions in restricted frequency bands	FCC CFR Title 47 Part 15 Subpart C: 2015Section 15.209	Yes	No
20dB Bandwidth	FCC CFR Title 47 Part 15 Subpart C: 2015 Section 15.247(a)(1)	Yes	No
Carrier Frequency Separation	FCC CFR Title 47 Part 15 Subpart C: 2015 Section 15.247(a)(1)	Yes	No
Number of Hopping Frequencies	FCC CFR Title 47 Part 15 Subpart C: 2015 Section 15.247(a)(1)(iii)	Yes	No
Time of Occupancy (Dwell Time)	FCC CFR Title 47 Part 15 Subpart C: 2015 Section 15.247(a)(1)(iii)	Yes	No
Peak OutputPower	FCC CFR Title 47 Part 15 Subpart C: 2015 Section 15.247(b)(1)	Yes	No
Emissions in non-restricted frequency bands	FCC CFR Title 47 Part 15 Subpart C: 2015 Section 15.215(c), 15.247(d)	Yes	No
Band Edge	FCC CFR Title 47 Part 15 Subpart C: 2015 15.247(d)	Yes	No
Antenna Requirement	FCC CFR Title 47 Part 15 Subpart C: 2015 Section 15.203	Yes	No

3.4 Test Facility

USA : FCC Designation Number: CN1199

4 TEST RESULTS

4.1 Conducted Emission

VERDICT: N/A

4.1.1 Limit

Standard		
FCC Part 15 Subpart C Paragraph 15.207		
Frequency range [MHz]	Limit: QP [dB(μV) ¹⁾]	Limit: AV [dB(μV) ¹⁾]
0,15 - 0,50	66 - 56 ²⁾	56 - 46 ²⁾
0,50 - 5,0	56	46
5,0 - 30	60	50

¹⁾ At the transition frequency, the lower limit applies.

²⁾ The limit decreases linearly with the logarithm of the frequency.

NOTE 1: The exclusion band for transmitters shall be considered for transmitters operating at frequencies below 30 MHz.

NOTE 2: Where the AC output port is directly connected (or via a circuit breaker) to the AC power input port of the EUT the AC power output port need not to be tested.

4.1.2 Test Setup

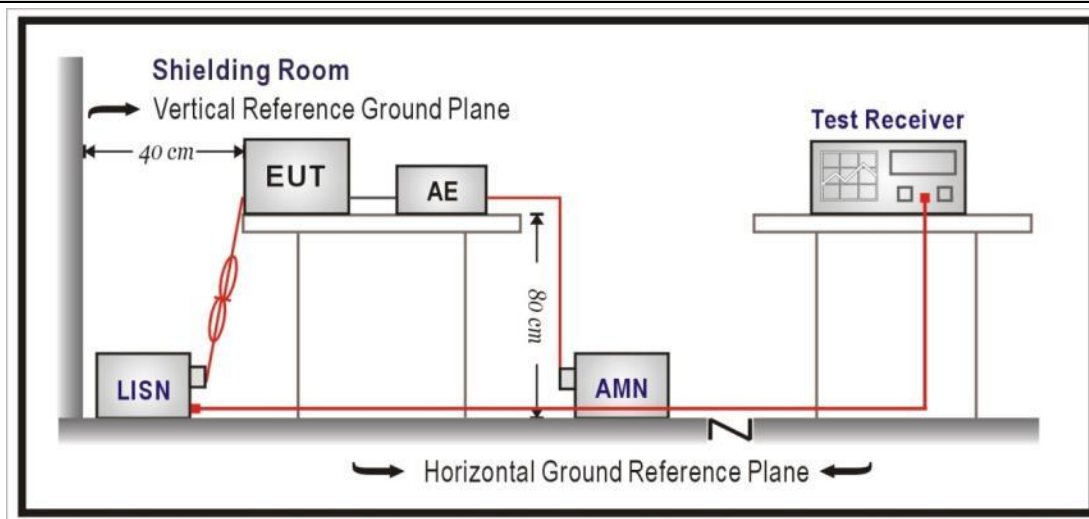

4.1.3 Test Procedure

	References Rule	Chapter	Item
<input checked="" type="checkbox"/>	ANSI C63.10-2013	6.2	Standard test method for ac power-line conducted emissions from unlicensed wireless devices

4.1.4 Test Data

Note: EUT is DC powered.

4.2 Emissions in restricted frequency bands**VERDICT: PASS****4.2.1 Limit****Standard** FCC Part 15 Subpart C Paragraph 15.209

Restricted Bands of operation for FCC

Frequency (MHz)	Frequency (MHz)	Frequency (MHz)	Frequency (GHz)
0.090 – 0.110	16.42 – 16.423	399.9 – 410	4.5 – 5.15
0.495 – 0.505	16.69475 – 16.69525	608 – 614	5.35 – 5.46
2.1735 – 2.1905	16.80425 – 16.80475	960 – 1240	7.25 – 7.75
4.125 – 4.128	25.5 – 25.67	1300 – 1427	8.025 – 8.5
4.17725 – 4.17775	37.5 – 38.25	1435 – 1626.5	9.0 – 9.2
4.20725 – 4.20775	73 – 74.6	1645.5 – 1646.5	9.3 – 9.5
6.215 – 6.218	74.8 – 75.2	1660 – 1710	10.6 – 12.7
6.26775 – 6.26825	108 – 121.94	1718.8 – 1722.2	13.25 – 13.4
6.31175 – 6.31225	123 – 138	2200 – 2300	14.47 – 14.5
8.291 – 8.294	149.9 – 150.05	2310 – 2390	15.35 – 16.2
8.362 – 8.366	156.52475 – 156.52525	2483.5 – 2500	17.7 – 21.4
8.37625 – 8.38675	156.7 – 156.9	2690 – 2900	22.01 – 23.12
8.81425 – 8.81475	162.0125 – 167.17	3260 – 3267	23.6 – 24.0
12.29 – 12.293	167.72 – 173.2	3332 – 3339	31.2 – 31.8
12.51975 – 12.52025	240 – 285	3345.8 – 3358	36.43 – 36.5
12.57675 – 12.57725	322 – 335.4	3600 – 4400	
13.36 – 13.41			

Restricted Band Emissions Limit			
Frequency (MHz)	Field strength (μ V/m)	Field strength (dB μ V/m)	Measurement distance (m)
0.009 - 0.49	2400/F(kHz)	48.5 – 13.8	300 _(Note 1)
0.49 - 1.705	24000/F(kHz)	33.8 - 23	30 _(Note 1)
1.705 - 30	30	29.5	30 _(Note 1)
30 -88	100	40	3 _(Note 2)
88-216	150	43.5	3 _(Note 2)
216 - 960	200	46	3 _(Note 2)
Above 960	500	54	3 _(Note 2)

Note 1: At frequencies below 30 MHz, measurements may be performed at a distance closer than that specified in the regulations; however, an attempt should be made to avoid making measurements in the near field. Pending the development of an appropriate measurement procedure for measurements performed below 30 MHz, when performing measurements at a closer distance than specified, the results shall be extrapolated to the specified distance by either making measurements at a minimum of two distances on at least one radial to determine the proper extrapolation factor or by using the square of an inverse linear distance extrapolation factor (40 dB/decade).

Note 2: At frequencies at or above 30 MHz, measurements may be performed at a distance other than what is specified provided: measurements are not made in the near field except where it can be shown that near field measurements are appropriate due to the characteristics of the device; and it can be demonstrated that the signal levels needed to be measured at the distance employed can be detected by the measurement equipment.

Measurements shall not be performed at a distance greater than 30 meters unless it can be further demonstrated that measurements at a distance of 30 meters or less are impractical. When performing measurements at a distance other than that specified, the results shall be extrapolated to the specified distance using an extrapolation factor of 20 dB/decade (inverse linear-distance for field strength measurements; inverse-linear-distance-squared for power density measurements).

4.2.2 Test Setup

Below 30MHz Test Setup:

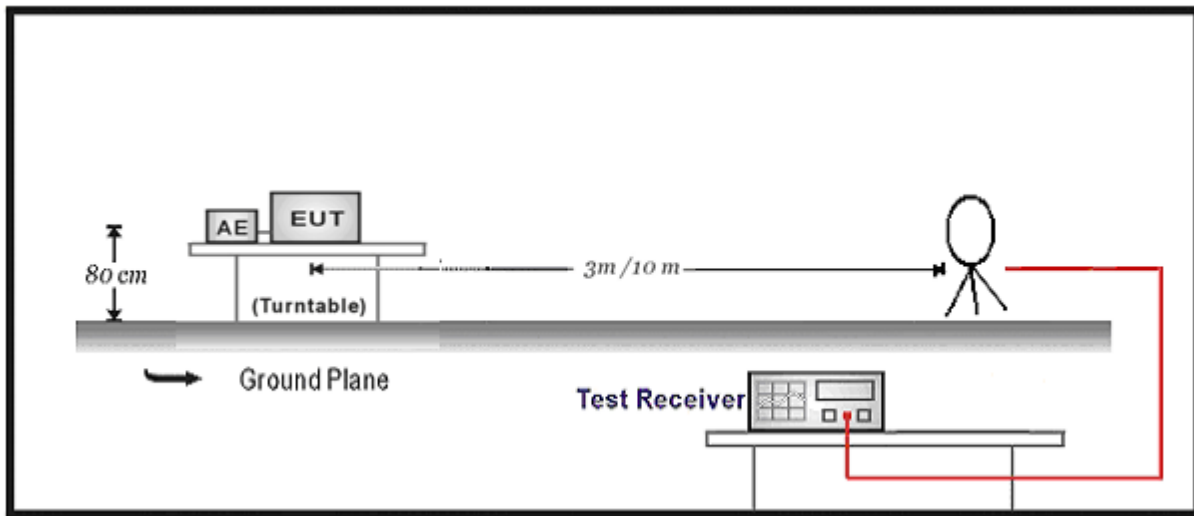

30MHz-1GHz Test Setup:

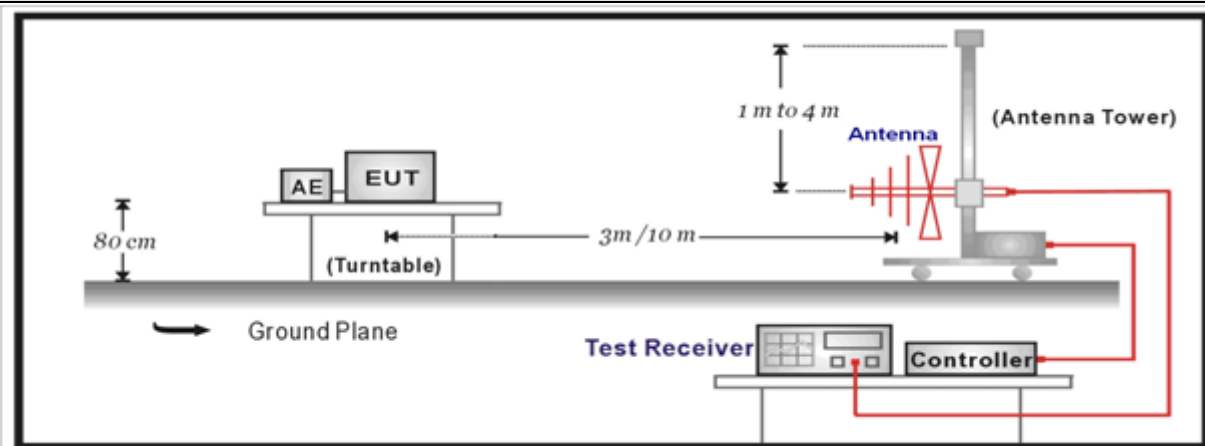

Above 1GHz Test Setup:

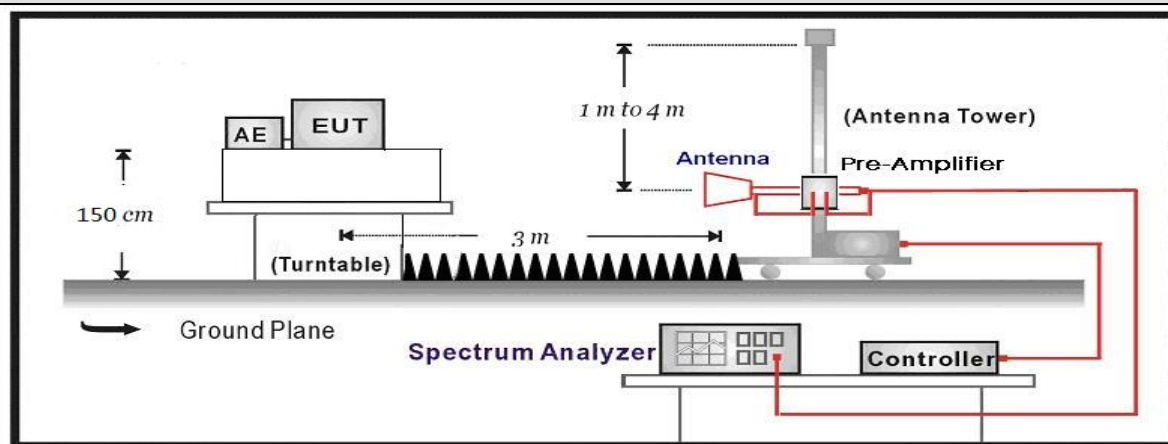

4.2.3 Test Procedure			
	References Rule	Chapter	Description
<input checked="" type="checkbox"/>	ANSI C63.10	11.12	Emissions in restricted frequency bands
<input checked="" type="checkbox"/>	<input checked="" type="checkbox"/> ANSI C63.10	11.12.1	Radiated emission measurements
<input checked="" type="checkbox"/>	<input checked="" type="checkbox"/> ANSI C63.10	11.12.2.7	Radiated spurious emission test
<input checked="" type="checkbox"/>	<input checked="" type="checkbox"/> ANSI C63.10	6.4	Radiated emissions from unlicensed wireless devices below 30 MHz
<input checked="" type="checkbox"/>	<input checked="" type="checkbox"/> ANSI C63.10	6.5	Radiated emissions from unlicensed wireless devices in the frequency range of 30 MHz to 1000 MHz
<input checked="" type="checkbox"/>	<input checked="" type="checkbox"/> ANSI C63.10	6.6	Radiated emissions from unlicensed wireless devices above 1 GHz

4.2.4 Test Data

Profile: 22A0151R	Page No.: 71
Engineer: YuLiu	
Site: AC5	Time: 2022/08/16 - 00:20
Limit: FCC_Part15.209_RE(3m)	Margin: 0
Probe: Horn_3117_00167055(1-18GHz)	Polarity: Vertical
EUT: AH80 BLUETOOTH HEADSET DONGLE	Power: DC 5V
Note: Mode1:Transmit at 2402MHz by DH5	

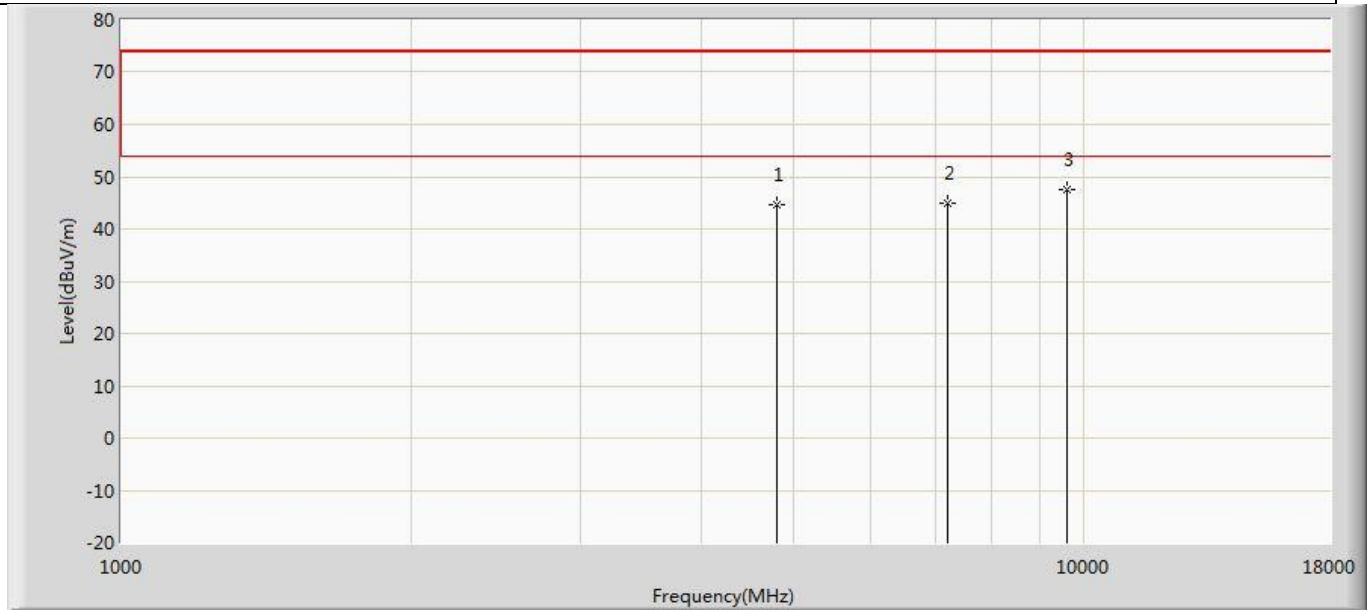

No	Mark	Frequency (MHz)	Measure Level (dBuV/m)	Reading Level (dBuV)	Over Limit (dB)	Limit (dBuV/m)	Factor (dB)	Type
1		4799.500	44.609	47.252	-29.391	74.000	-2.643	PK
2		7206.000	44.858	43.784	-29.142	74.000	1.074	PK
3	*	9610.500	47.567	45.232	-26.433	74.000	2.335	PK

Profile: 22A0151R	Page No.: 72
Engineer: YuLiu	
Site: AC5	Time: 2022/08/16 - 00:20
Limit: FCC_Part15.209_RE(3m)	Margin: 0
Probe: Horn_3117_00167055(1-18GHz)	Polarity: Horizontal
EUT: AH80 BLUETOOTH HEADSET DONGLE	Power: DC 5V
Note: Mode1:Transmit at 2402MHz by DH5	

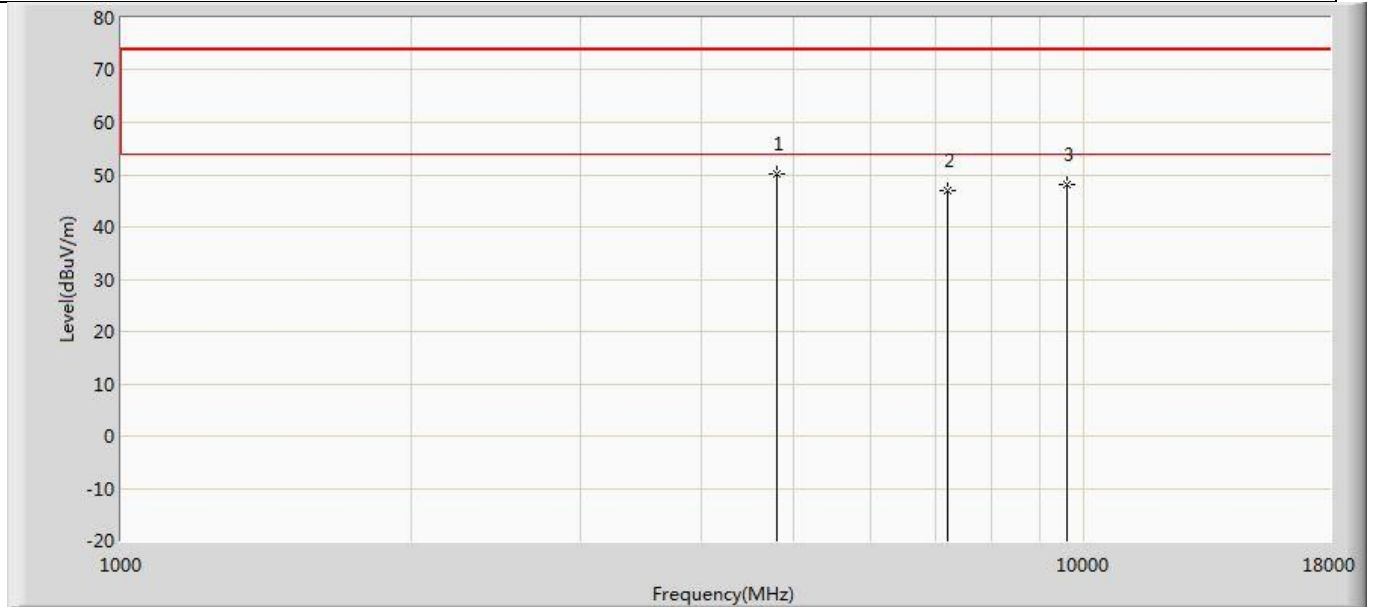

No	Mark	Frequency (MHz)	Measure Level (dBuV/m)	Reading Level (dBuV)	Over Limit (dB)	Limit (dBuV/m)	Factor (dB)	Type
1	*	4799.500	50.150	52.793	-23.850	74.000	-2.643	PK
2		7205.000	46.946	45.884	-27.054	74.000	1.062	PK
3		9610.500	48.254	45.919	-25.746	74.000	2.335	PK

Profile: 22A0151R	Page No.: 73
Engineer: YuLiu	
Site: AC5	Time: 2022/08/16 - 00:20
Limit: FCC_Part15.209_RE(3m)	Margin: 0
Probe: Horn_3117_00167055(1-18GHz)	Polarity: Vertical
EUT: AH80 BLUETOOTH HEADSET DONGLE	Power: DC 5V
Note: Mode1:Transmit at 2441MHz by DH5	

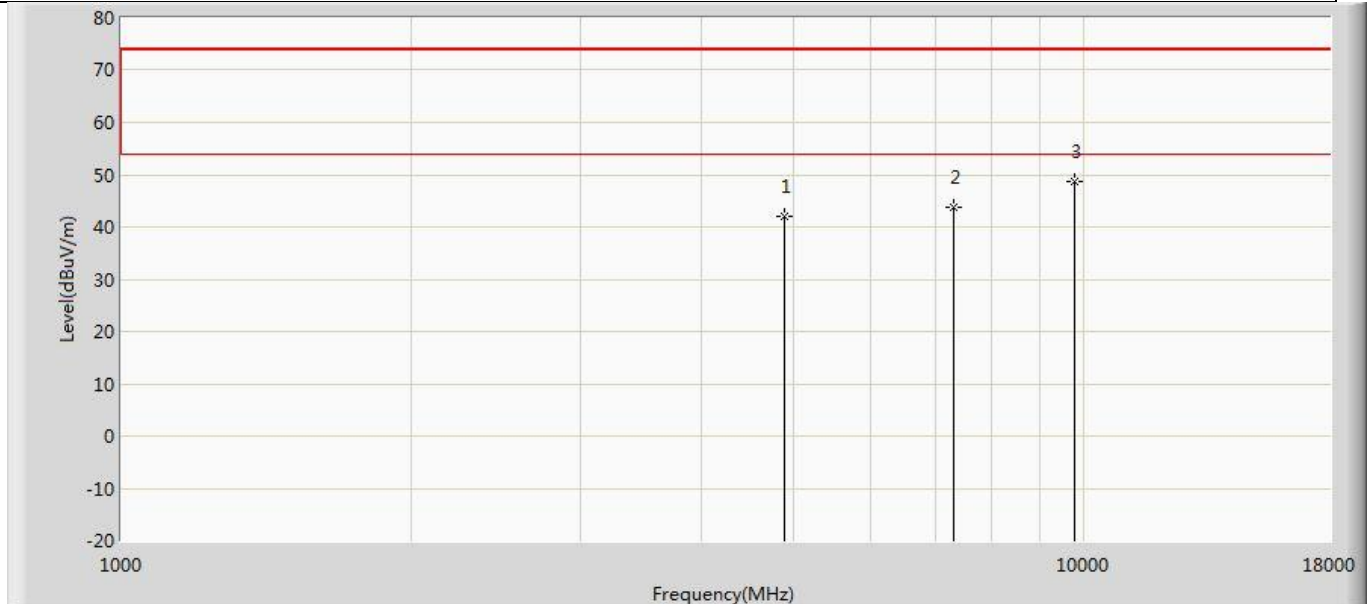

No	Mark	Frequency (MHz)	Measure Level (dBuV/m)	Reading Level (dBuV)	Over Limit (dB)	Limit (dBuV/m)	Factor (dB)	Type
1		4882.000	42.112	44.447	-31.888	74.000	-2.335	PK
2		7323.000	43.665	42.642	-30.335	74.000	1.023	PK
3	*	9764.000	48.765	45.897	-25.235	74.000	2.868	PK

Profile: 22A0151R	Page No.: 74
Engineer: YuLiu	
Site: AC5	Time: 2022/08/16 - 00:20
Limit: FCC_Part15.209_RE(3m)	Margin: 0
Probe: Horn_3117_00167055(1-18GHz)	Polarity: Horizontal
EUT: AH80 BLUETOOTH HEADSET DONGLE	Power: DC 5V
Note: Mode1:Transmit at 2441MHz by DH5	

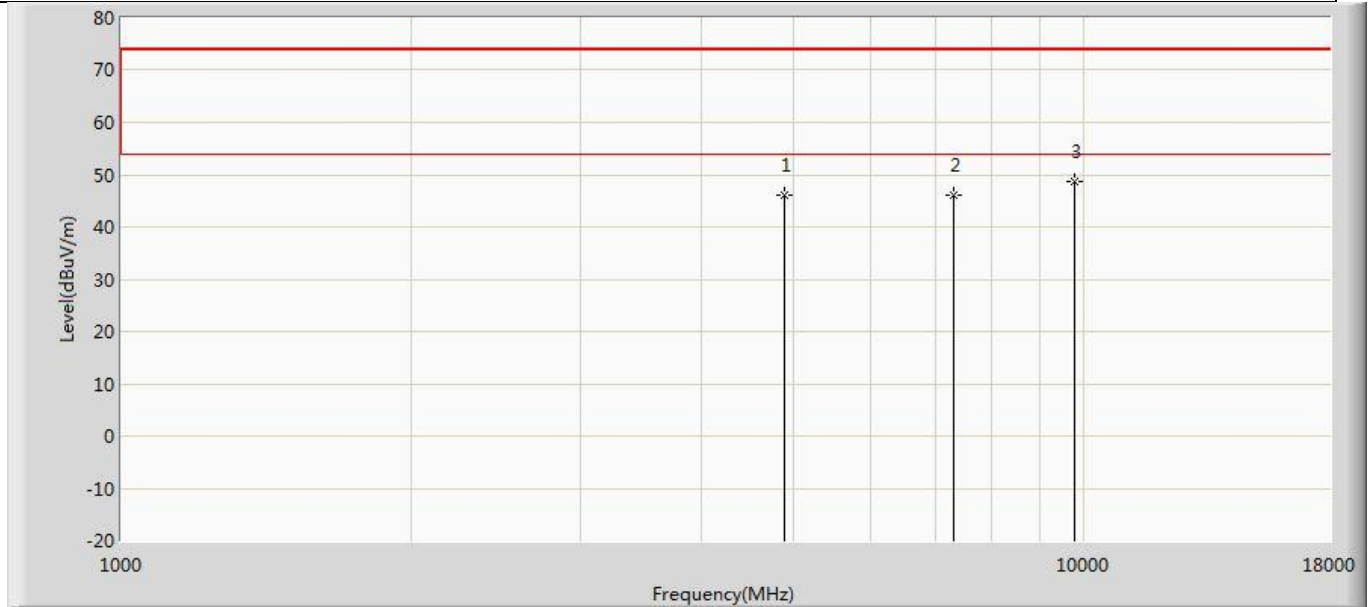

No	Mark	Frequency (MHz)	Measure Level (dBuV/m)	Reading Level (dBuV)	Over Limit (dB)	Limit (dBuV/m)	Factor (dB)	Type
1		4884.500	45.999	48.390	-28.001	74.000	-2.391	PK
2		7324.000	46.138	45.140	-27.862	74.000	0.998	PK
3	*	9763.500	48.573	45.694	-25.427	74.000	2.879	PK

Profile: 22A0151R	Page No.: 75
Engineer: YuLiu	
Site: AC5	Time: 2022/08/16 - 00:20
Limit: FCC_Part15.209_RE(3m)	Margin: 0
Probe: Horn_3117_00167055(1-18GHz)	Polarity: Vertical
EUT: AH80 BLUETOOTH HEADSET DONGLE	Power: DC 5V
Note: Mode1:Transmit at 2480MHz by DH5	

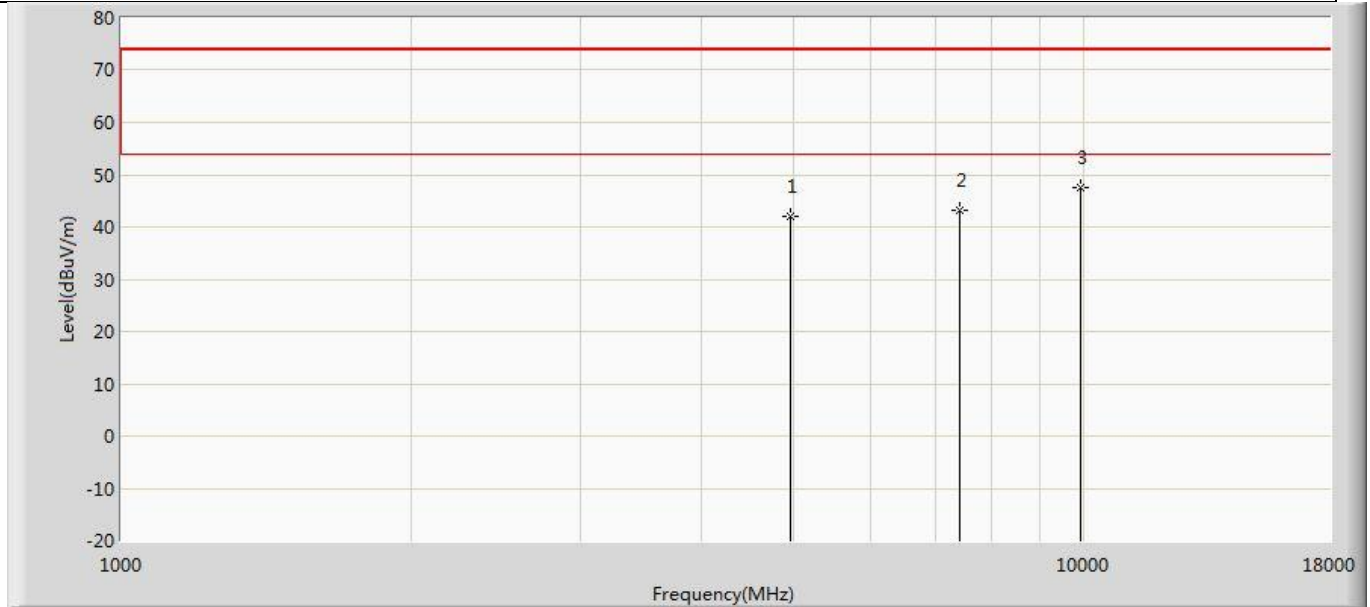

No	Mark	Frequency (MHz)	Measure Level (dBuV/m)	Reading Level (dBuV)	Over Limit (dB)	Limit (dBuV/m)	Factor (dB)	Type
1		4960.000	41.920	44.377	-32.080	74.000	-2.457	PK
2		7440.000	43.116	42.174	-30.884	74.000	0.943	PK
3	*	9920.000	47.459	44.700	-26.541	74.000	2.760	PK

Profile: 22A0151R	Page No.: 76
Engineer: YuLiu	
Site: AC5	Time: 2022/08/16 - 00:21
Limit: FCC_Part15.209_RE(3m)	Margin: 0
Probe: Horn_3117_00167055(1-18GHz)	Polarity: Horizontal
EUT: AH80 BLUETOOTH HEADSET DONGLE	Power: DC 5V
Note: Mode1:Transmit at 2480MHz by DH5	

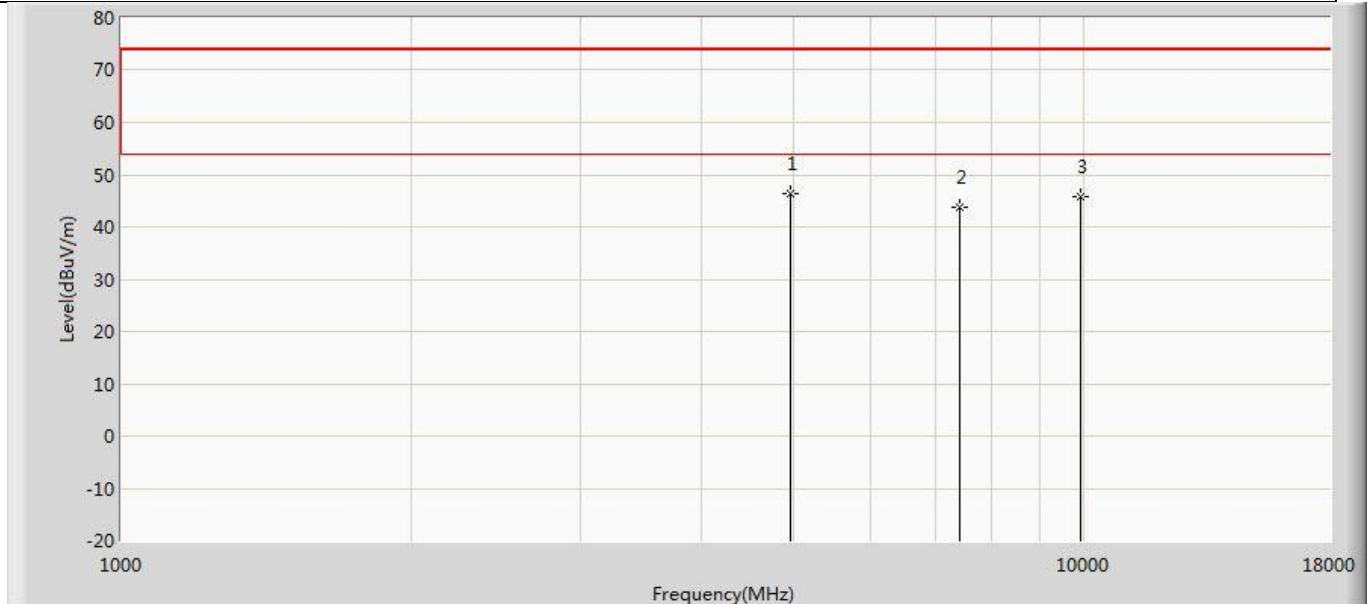

No	Mark	Frequency (MHz)	Measure Level (dBuV/m)	Reading Level (dBuV)	Over Limit (dB)	Limit (dBuV/m)	Factor (dB)	Type
1	*	4961.000	46.350	48.809	-27.650	74.000	-2.459	PK
2		7440.000	43.741	42.799	-30.259	74.000	0.943	PK
3		9920.000	45.713	42.954	-28.287	74.000	2.760	PK

Profile: 22A0151R	Page No.: 77
Engineer: YuLiu	
Site: AC5	Time: 2022/08/16 - 00:21
Limit: FCC_Part15.209_RE(3m)	Margin: 0
Probe: Horn_3117_00167055(1-18GHz)	Polarity: Vertical
EUT: AH80 BLUETOOTH HEADSET DONGLE	Power: DC 5V
Note: Mode2:Transmit at 2402MHz by 2DH5	

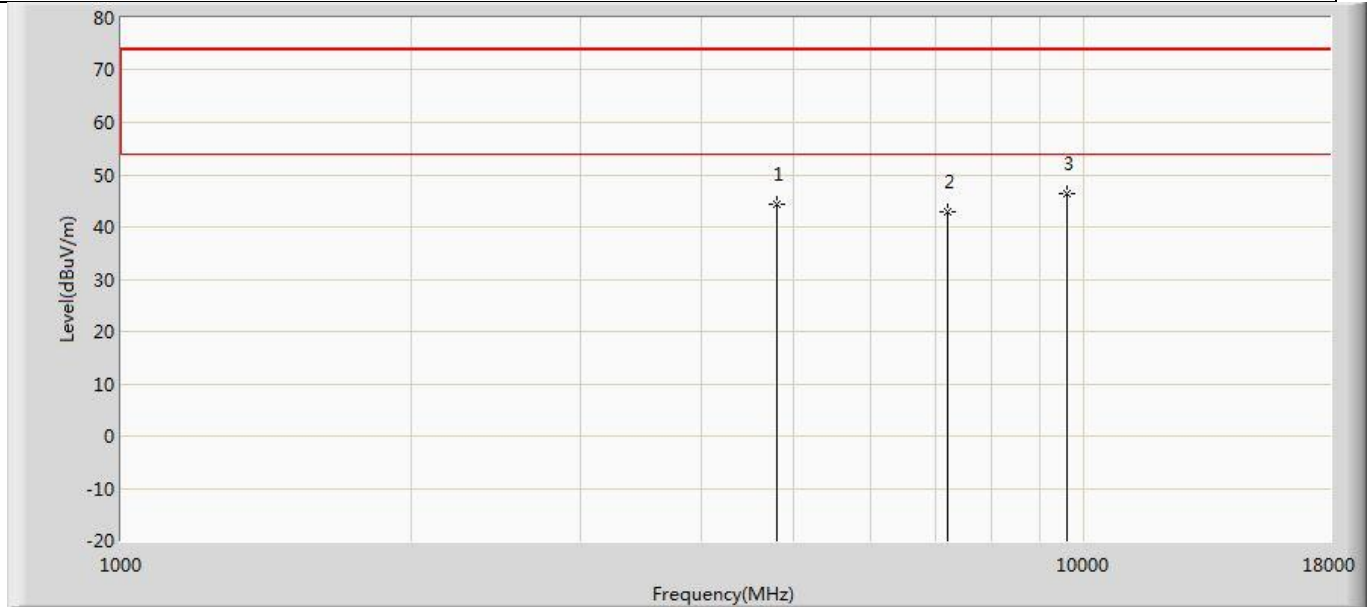

No	Mark	Frequency (MHz)	Measure Level (dBuV/m)	Reading Level (dBuV)	Over Limit (dB)	Limit (dBuV/m)	Factor (dB)	Type
1		4804.000	44.294	46.929	-29.706	74.000	-2.635	PK
2		7206.000	42.857	41.783	-31.143	74.000	1.074	PK
3	*	9608.000	46.242	44.000	-27.758	74.000	2.243	PK

Profile: 22A0151R	Page No.: 78
Engineer: YuLiu	
Site: AC5	Time: 2022/08/16 - 00:21
Limit: FCC_Part15.209_RE(3m)	Margin: 0
Probe: Horn_3117_00167055(1-18GHz)	Polarity: Horizontal
EUT: AH80 BLUETOOTH HEADSET DONGLE	Power: DC 5V
Note: Mode2:Transmit at 2402MHz by 2DH5	

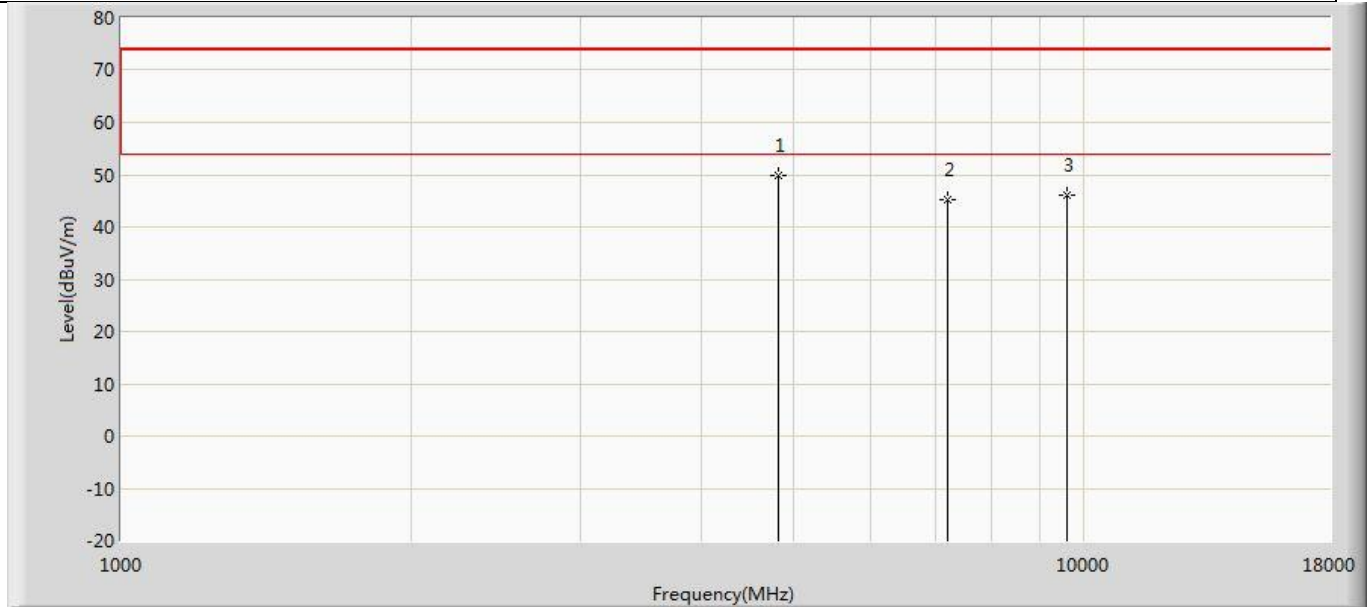

No	Mark	Frequency (MHz)	Measure Level (dBuV/m)	Reading Level (dBuV)	Over Limit (dB)	Limit (dBuV/m)	Factor (dB)	Type
1	*	4808.000	49.765	52.393	-24.235	74.000	-2.628	PK
2		7205.000	45.311	44.249	-28.689	74.000	1.062	PK
3		9610.500	46.046	43.711	-27.954	74.000	2.335	PK

Profile: 22A0151R	Page No.: 79
Engineer: YuLiu	
Site: AC5	Time: 2022/08/16 - 00:21
Limit: FCC_Part15.209_RE(3m)	Margin: 0
Probe: Horn_3117_00167055(1-18GHz)	Polarity: Vertical
EUT: AH80 BLUETOOTH HEADSET DONGLE	Power: DC 5V
Note: Mode2:Transmit at 2441MHz by 2DH5	

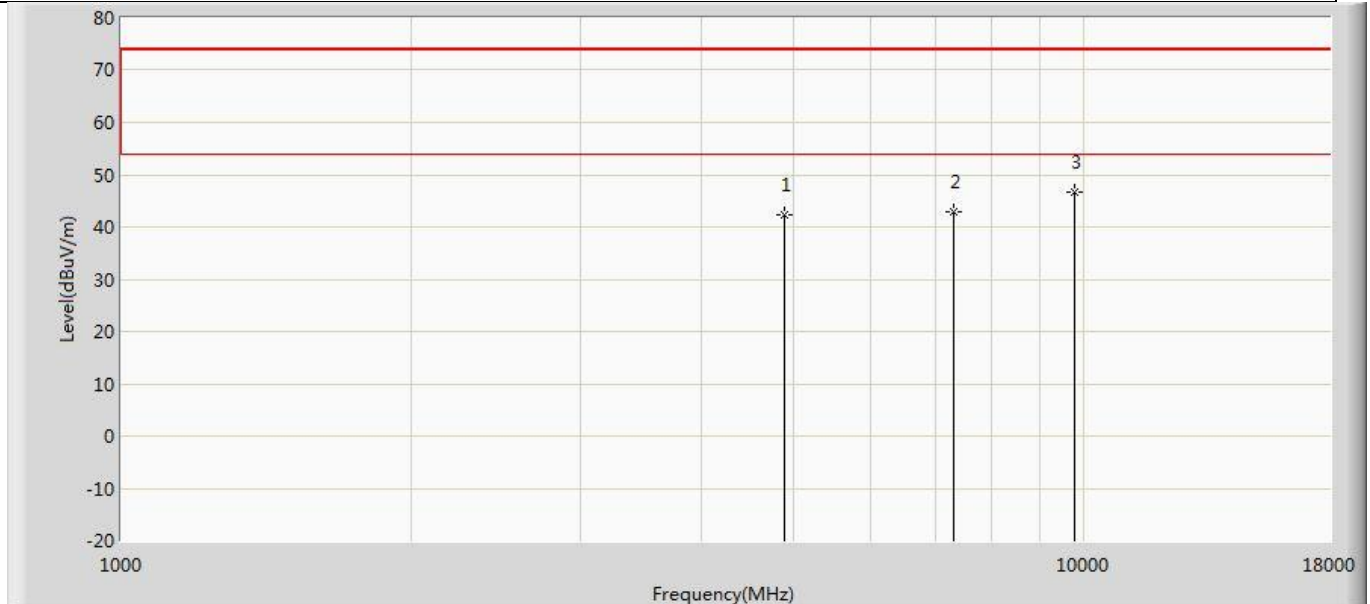

No	Mark	Frequency (MHz)	Measure Level (dBuV/m)	Reading Level (dBuV)	Over Limit (dB)	Limit (dBuV/m)	Factor (dB)	Type
1		4882.000	42.204	44.539	-31.796	74.000	-2.335	PK
2		7323.000	42.793	41.770	-31.207	74.000	1.023	PK
3	*	9764.000	46.712	43.844	-27.288	74.000	2.868	PK

Profile: 22A0151R	Page No.: 80
Engineer: YuLiu	
Site: AC5	Time: 2022/08/16 - 00:21
Limit: FCC_Part15.209_RE(3m)	Margin: 0
Probe: Horn_3117_00167055(1-18GHz)	Polarity: Horizontal
EUT: AH80 BLUETOOTH HEADSET DONGLE	Power: DC 5V
Note: Mode2:Transmit at 2441MHz by 2DH5	

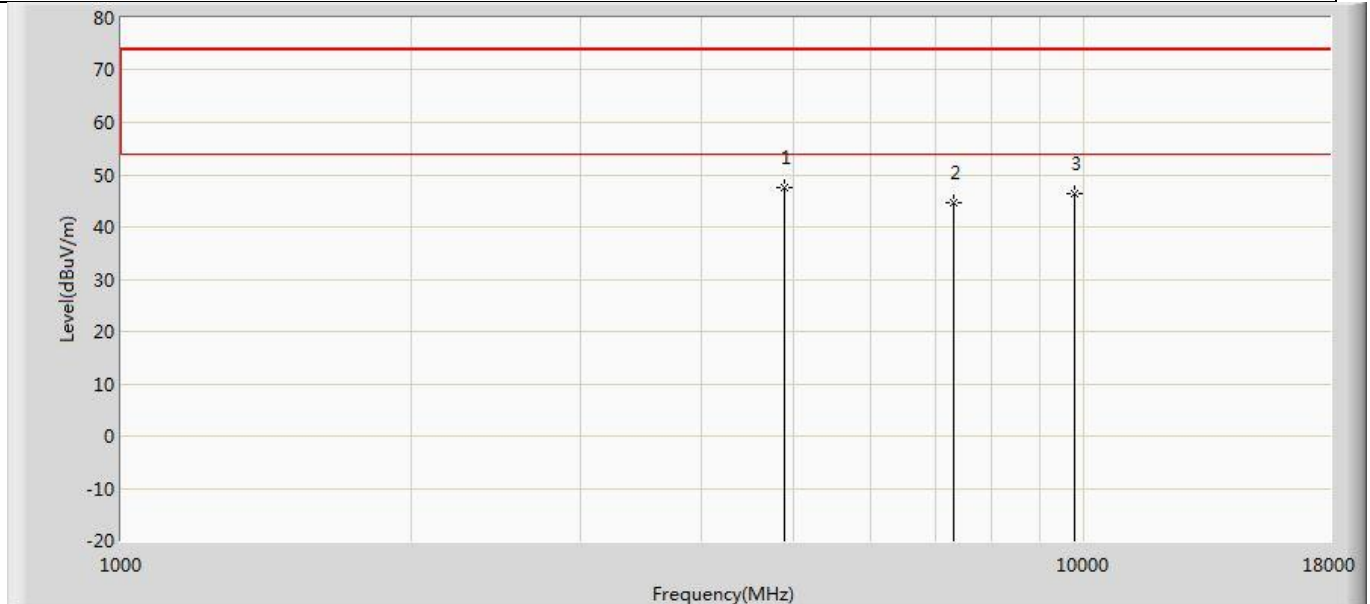

No	Mark	Frequency (MHz)	Measure Level (dBuV/m)	Reading Level (dBuV)	Over Limit (dB)	Limit (dBuV/m)	Factor (dB)	Type
1	*	4884.500	47.677	50.068	-26.323	74.000	-2.391	PK
2		7323.000	44.559	43.536	-29.441	74.000	1.023	PK
3		9764.000	46.350	43.482	-27.650	74.000	2.868	PK

Profile: 22A0151R	Page No.: 81
Engineer: YuLiu	
Site: AC5	Time: 2022/08/16 - 00:21
Limit: FCC_Part15.209_RE(3m)	Margin: 0
Probe: Horn_3117_00167055(1-18GHz)	Polarity: Vertical
EUT: AH80 BLUETOOTH HEADSET DONGLE	Power: DC 5V
Note: Mode2:Transmit at 2480MHz by 2DH5	

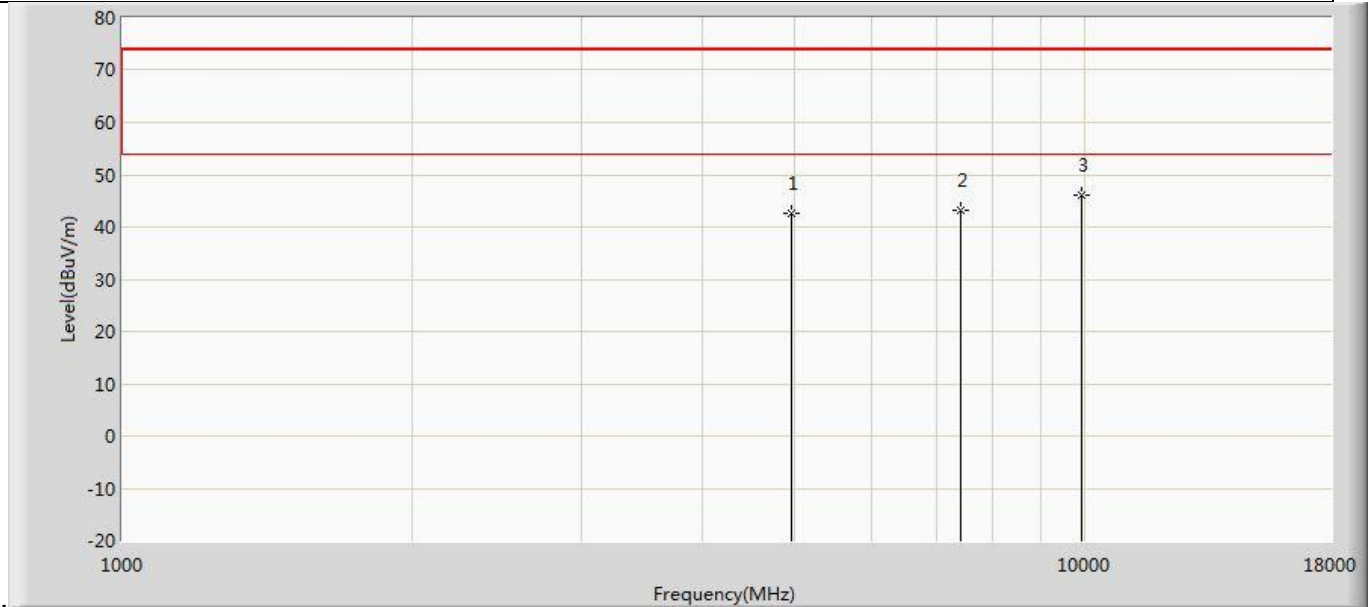

No	Mark	Frequency (MHz)	Measure Level (dBuV/m)	Reading Level (dBuV)	Over Limit (dB)	Limit (dBuV/m)	Factor (dB)	Type
1		4960.000	42.747	45.204	-31.253	74.000	-2.457	PK
2		7440.000	43.110	42.168	-30.890	74.000	0.943	PK
3	*	9920.000	46.034	43.275	-27.966	74.000	2.760	PK

Profile: 22A0151R	Page No.: 82
Engineer: YuLiu	
Site: AC5	Time: 2022/08/16 - 00:21
Limit: FCC_Part15.209_RE(3m)	Margin: 0
Probe: Horn_3117_00167055(1-18GHz)	Polarity: Horizontal
EUT: AH80 BLUETOOTH HEADSET DONGLE	Power: DC 5V
Note: Mode2:Transmit at 2480MHz by 2DH5	

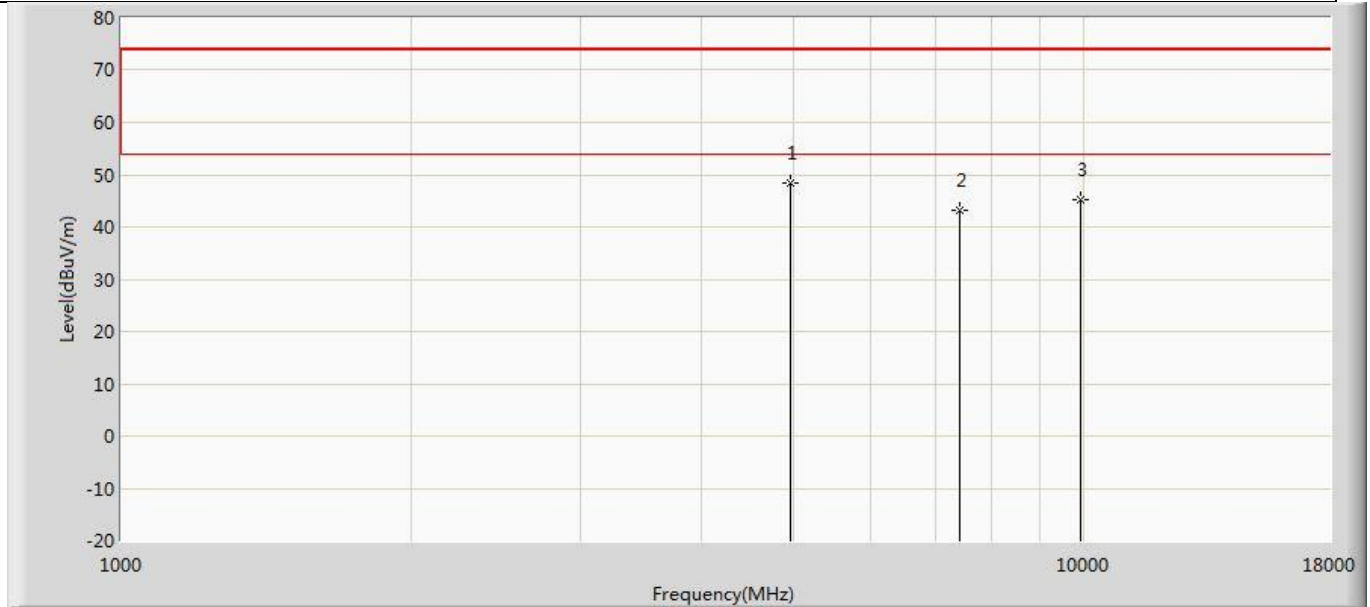

No	Mark	Frequency (MHz)	Measure Level (dBuV/m)	Reading Level (dBuV)	Over Limit (dB)	Limit (dBuV/m)	Factor (dB)	Type
1	*	4961.000	48.478	50.937	-25.522	74.000	-2.459	PK
2		7440.000	43.135	42.193	-30.865	74.000	0.943	PK
3		9920.000	45.342	42.583	-28.658	74.000	2.760	PK

Profile: 22A0151R	Page No.: 83
Engineer: YuLiu	
Site: AC5	Time: 2022/08/16 - 00:21
Limit: FCC_Part15.209_RE(3m)	Margin: 0
Probe: Horn_3117_00167055(1-18GHz)	Polarity: Vertical
EUT: AH80 BLUETOOTH HEADSET DONGLE	Power: DC 5V
Note: Mode3:Transmit at 2402MHz by 3DH5	

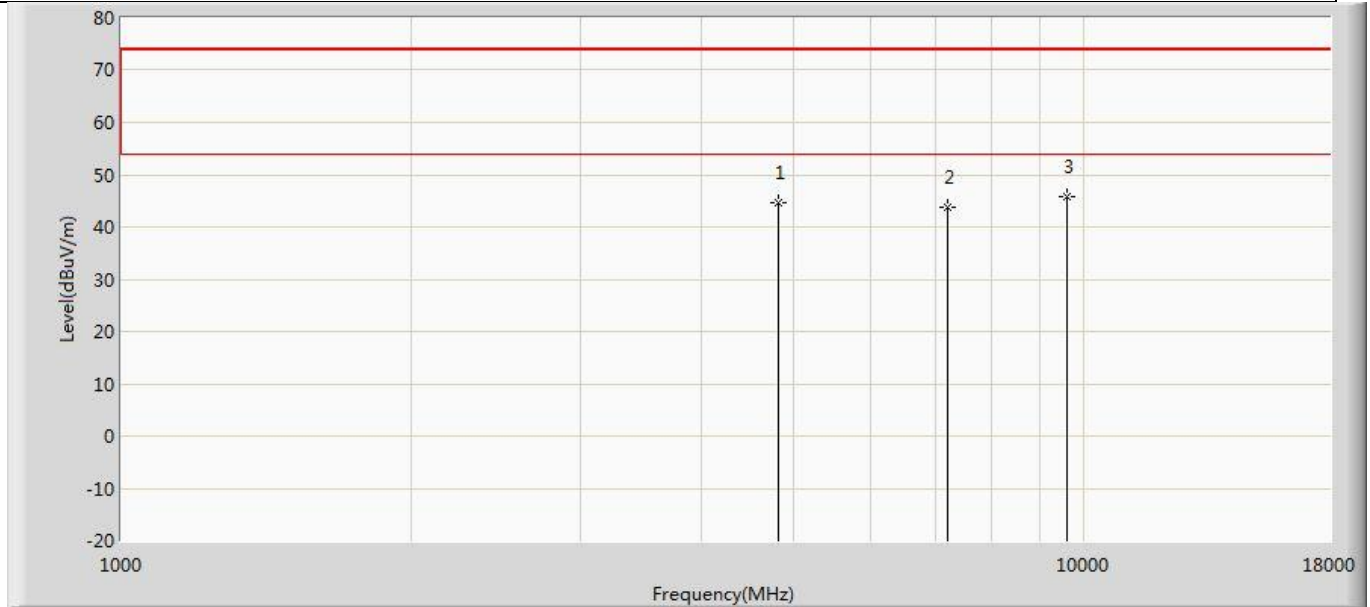

No	Mark	Frequency (MHz)	Measure Level (dBuV/m)	Reading Level (dBuV)	Over Limit (dB)	Limit (dBuV/m)	Factor (dB)	Type
1		4808.000	44.681	47.309	-29.319	74.000	-2.628	PK
2		7206.000	43.662	42.588	-30.338	74.000	1.074	PK
3	*	9608.000	45.676	43.434	-28.324	74.000	2.243	PK

Profile: 22A0151R	Page No.: 84
Engineer: YuLiu	
Site: AC5	Time: 2022/08/16 - 00:21
Limit: FCC_Part15.209_RE(3m)	Margin: 0
Probe: Horn_3117_00167055(1-18GHz)	Polarity: Horizontal
EUT: AH80 BLUETOOTH HEADSET DONGLE	Power: DC 5V
Note: Mode3:Transmit at 2402MHz by 3DH5	

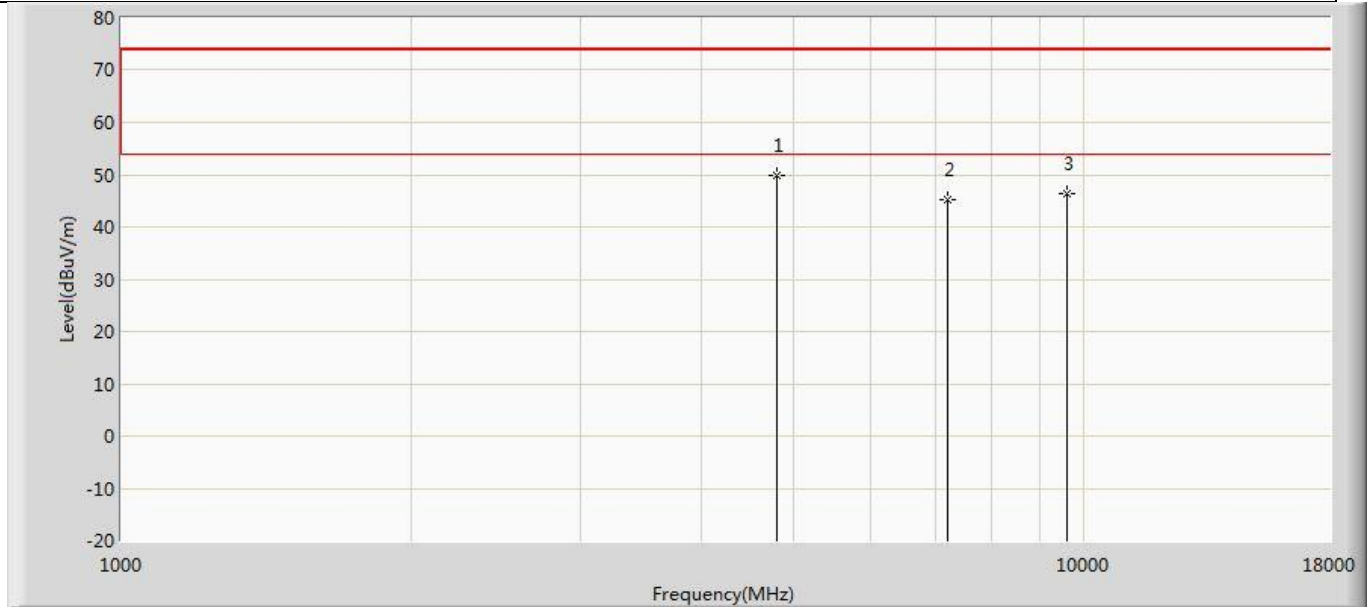

No	Mark	Frequency (MHz)	Measure Level (dBuV/m)	Reading Level (dBuV)	Over Limit (dB)	Limit (dBuV/m)	Factor (dB)	Type
1	*	4799.500	49.766	52.408	-24.234	74.000	-2.643	PK
2		7205.000	45.302	44.240	-28.698	74.000	1.062	PK
3		9610.500	46.350	44.016	-27.650	74.000	2.335	PK

Profile: 22A0151R	Page No.: 85
Engineer: YuLiu	
Site: AC5	Time: 2022/08/16 - 00:21
Limit: FCC_Part15.209_RE(3m)	Margin: 0
Probe: Horn_3117_00167055(1-18GHz)	Polarity: Vertical
EUT: AH80 BLUETOOTH HEADSET DONGLE	Power: DC 5V
Note: Mode3:Transmit at 2441MHz by 3DH5	

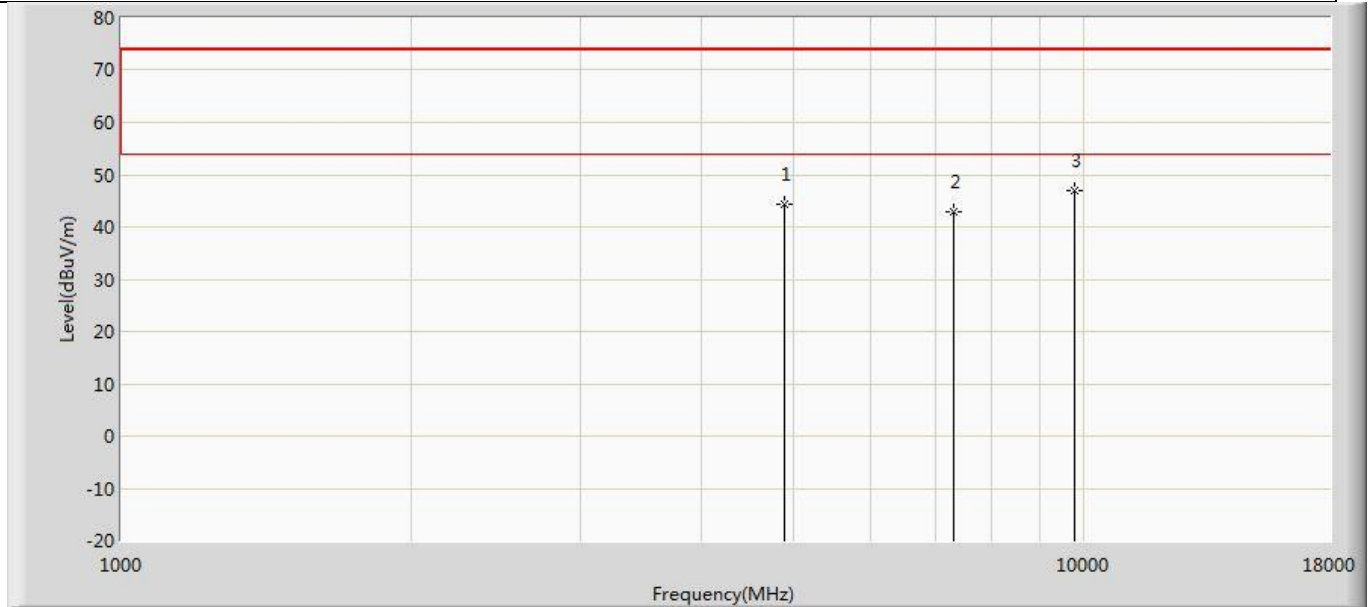

No	Mark	Frequency (MHz)	Measure Level (dBuV/m)	Reading Level (dBuV)	Over Limit (dB)	Limit (dBuV/m)	Factor (dB)	Type
1		4884.500	44.261	46.652	-29.739	74.000	-2.391	PK
2		7323.000	42.955	41.932	-31.045	74.000	1.023	PK
3	*	9764.000	46.860	43.992	-27.140	74.000	2.868	PK

Profile: 22A0151R	Page No.: 86
Engineer: YuLiu	
Site: AC5	Time: 2022/08/16 - 00:22
Limit: FCC_Part15.209_RE(3m)	Margin: 0
Probe: Horn_3117_00167055(1-18GHz)	Polarity: Horizontal
EUT: AH80 BLUETOOTH HEADSET DONGLE	Power: DC 5V
Note: Mode3:Transmit at 2441MHz by 3DH5	

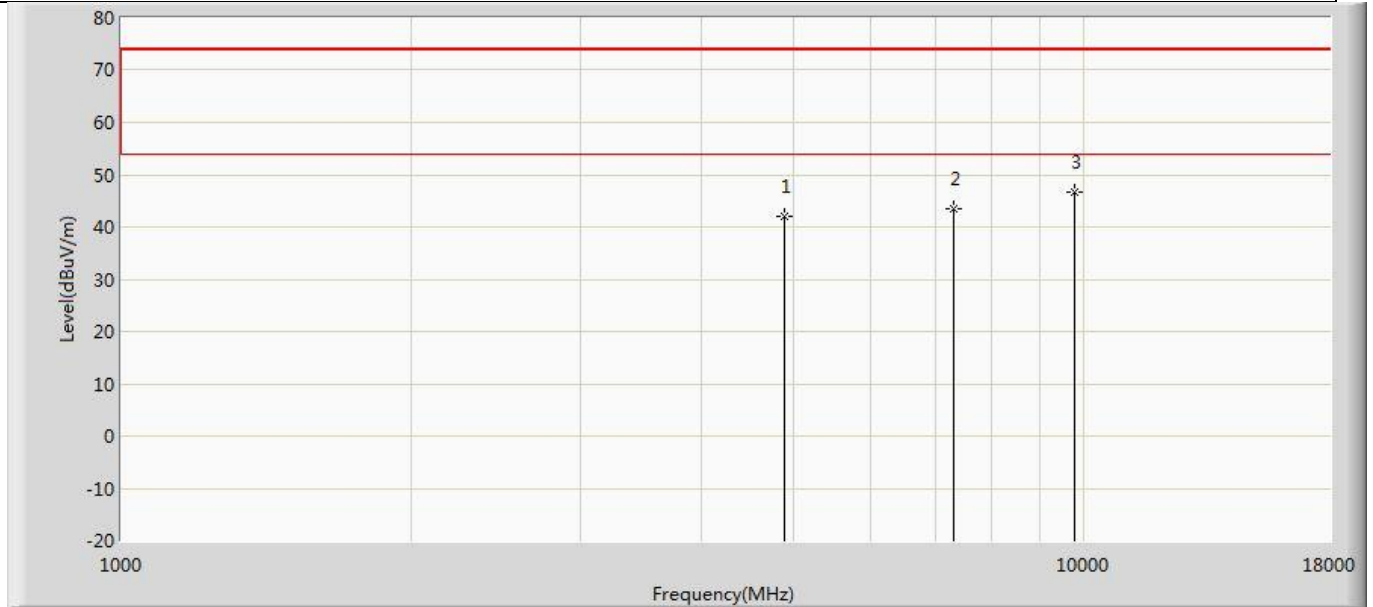

No	Mark	Frequency (MHz)	Measure Level (dBuV/m)	Reading Level (dBuV)	Over Limit (dB)	Limit (dBuV/m)	Factor (dB)	Type
1		4882.000	42.118	44.453	-31.882	74.000	-2.335	PK
2		7323.000	43.531	42.508	-30.469	74.000	1.023	PK
3	*	9764.000	46.547	43.679	-27.453	74.000	2.868	PK

Profile: 22A0151R	Page No.: 87
Engineer: YuLiu	
Site: AC5	Time: 2022/08/16 - 00:22
Limit: FCC_Part15.209_RE(3m)	Margin: 0
Probe: Horn_3117_00167055(1-18GHz)	Polarity: Vertical
EUT: AH80 BLUETOOTH HEADSET DONGLE	Power: DC 5V
Note: Mode3:Transmit at 2480MHz by 3DH5	

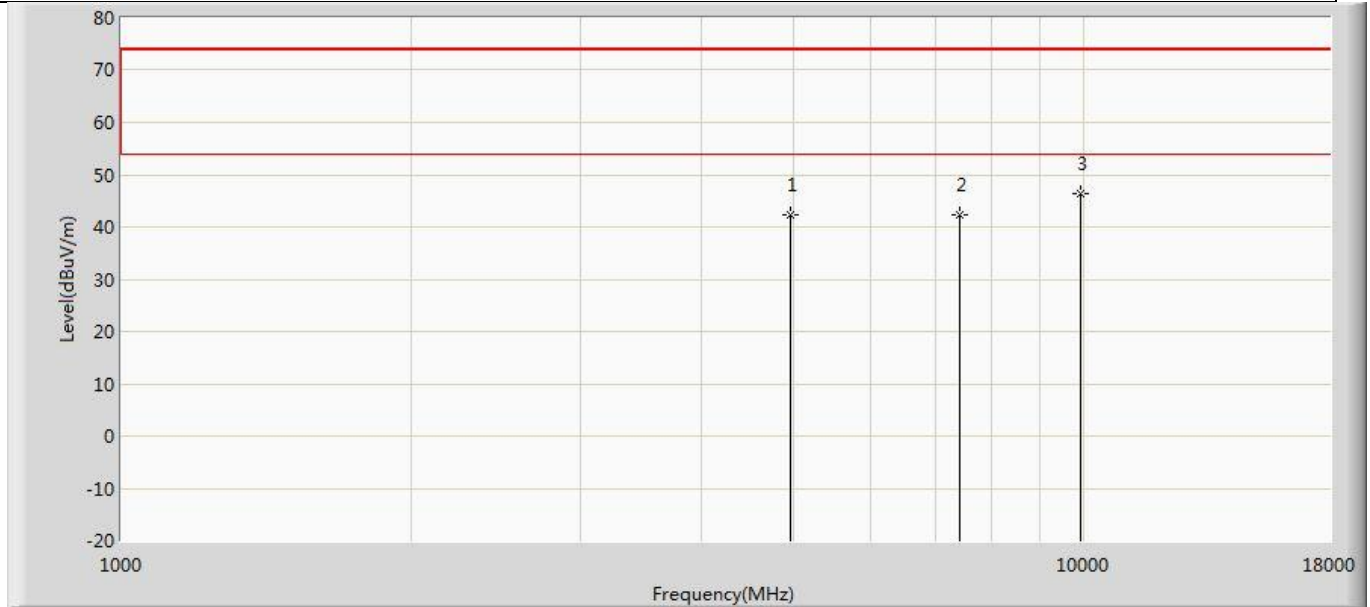

No	Mark	Frequency (MHz)	Measure Level (dBuV/m)	Reading Level (dBuV)	Over Limit (dB)	Limit (dBuV/m)	Factor (dB)	Type
1		4960.000	42.381	44.838	-31.619	74.000	-2.457	PK
2		7440.000	42.347	41.405	-31.653	74.000	0.943	PK
3	*	9920.000	46.406	43.647	-27.594	74.000	2.760	PK

Profile: 22A0151R	Page No.: 88
Engineer: YuLiu	
Site: AC5	Time: 2022/08/16 - 00:22
Limit: FCC_Part15.209_RE(3m)	Margin: 0
Probe: Horn_3117_00167055(1-18GHz)	Polarity: Horizontal
EUT: AH80 BLUETOOTH HEADSET DONGLE	Power: DC 5V
Note: Mode3:Transmit at 2480MHz by 3DH5	

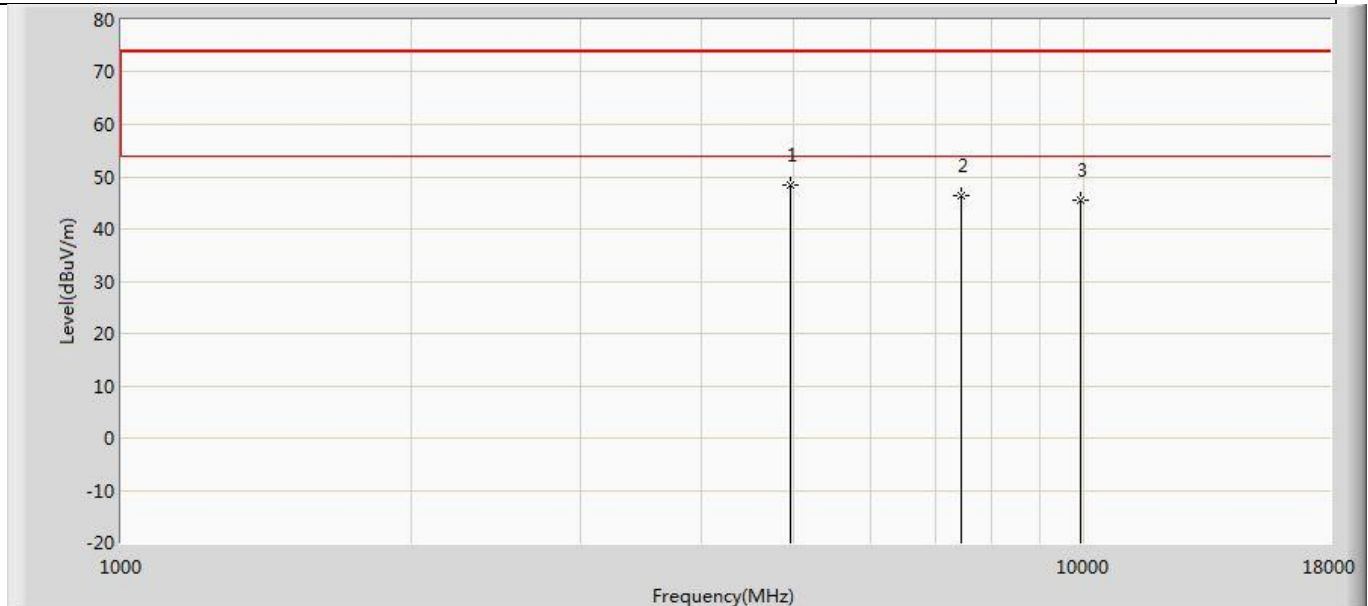

No	Mark	Frequency (MHz)	Measure Level (dBuV/m)	Reading Level (dBuV)	Over Limit (dB)	Limit (dBuV/m)	Factor (dB)	Type
1	*	4961.000	48.277	50.736	-25.723	74.000	-2.459	PK
2		7443.000	46.297	45.362	-27.703	74.000	0.935	PK
3		9920.000	45.546	42.787	-28.454	74.000	2.760	PK

Note:

1. Measured Level = Reading Level + Factor.
2. The test frequency range, 9kHz~30MHz, worst case are at least 20dB below the limits, therefore no data appear in the report.
3. The test frequency range, 18GHz~26GHz test result on peak is lower than average limit, all is the noise base, therefore no data appear in the report.
4. This limit applies for using average detector, if the test result on peak is lower than average limit, then average measurement needn't be performed.
5. As the radiated emission was performed, so conducted emission was not tested.

The worst case of Radiated Emission below 1GHz:

Profile: 22A0151R	Page No.: 1
Engineer: YuLiu	
Site: AC2	Time: 2022/09/06 - 20:34
Limit: FCC_Part15.209_RE(3m)	Margin: 0
Probe: AC2_3M(30-1000M)	Polarity: Vertical
EUT: AH80 BLUETOOTH HEADSET DONGLE	Power: DC5V
Note: Mode1	

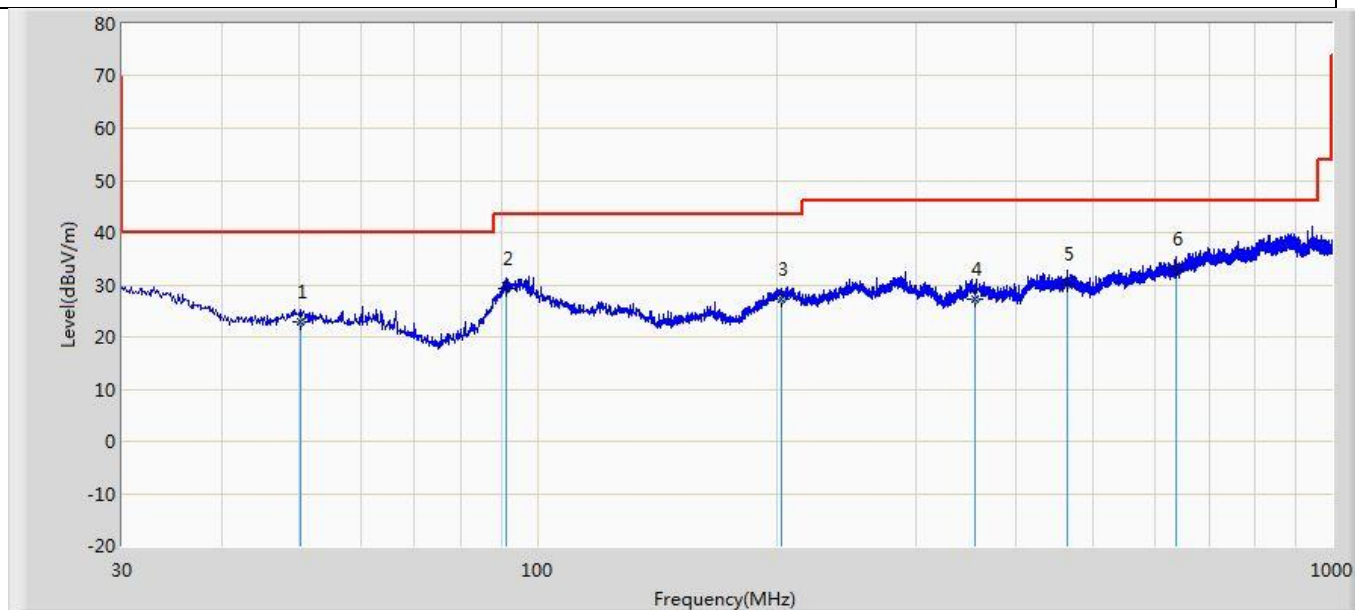

No	Mark	Frequency (MHz)	Measure Level (dBuV/m)	Reading Level (dBuV)	Over Limit (dB)	Limit (dBuV/m)	Factor (dB)	Type
1		50.249	23.012	3.558	-16.988	40.000	19.454	QP
2		91.231	29.155	11.618	-14.345	43.500	17.536	QP
3		202.660	27.185	3.703	-16.315	43.500	23.482	QP
4		355.556	27.172	2.046	-18.828	46.000	25.126	QP
5		463.832	30.124	3.401	-15.876	46.000	26.723	QP
6	*	637.220	33.124	5.386	-12.876	46.000	27.738	QP

Note:

1. All Readings below 1GHz are Quasi-Peak, above are performed with peak and/or average measurements as necessary.
2. " * ", means this data is the worst emission level.
3. Measurement Level = Reading Level + Factor(Probe+Cable-Amp)

Profile: 22A0151R	Page No.: 2
Engineer: YuLiu	
Site: AC2	Time: 2022/09/06 - 22:41
Limit: FCC_Part15.209_RE(3m)	Margin: 0
Probe: AC2_3M(30-1000M)	Polarity: Horizontal
EUT: AH80 BLUETOOTH HEADSET DONGLE	Power: DC5V
Note: Mode1	

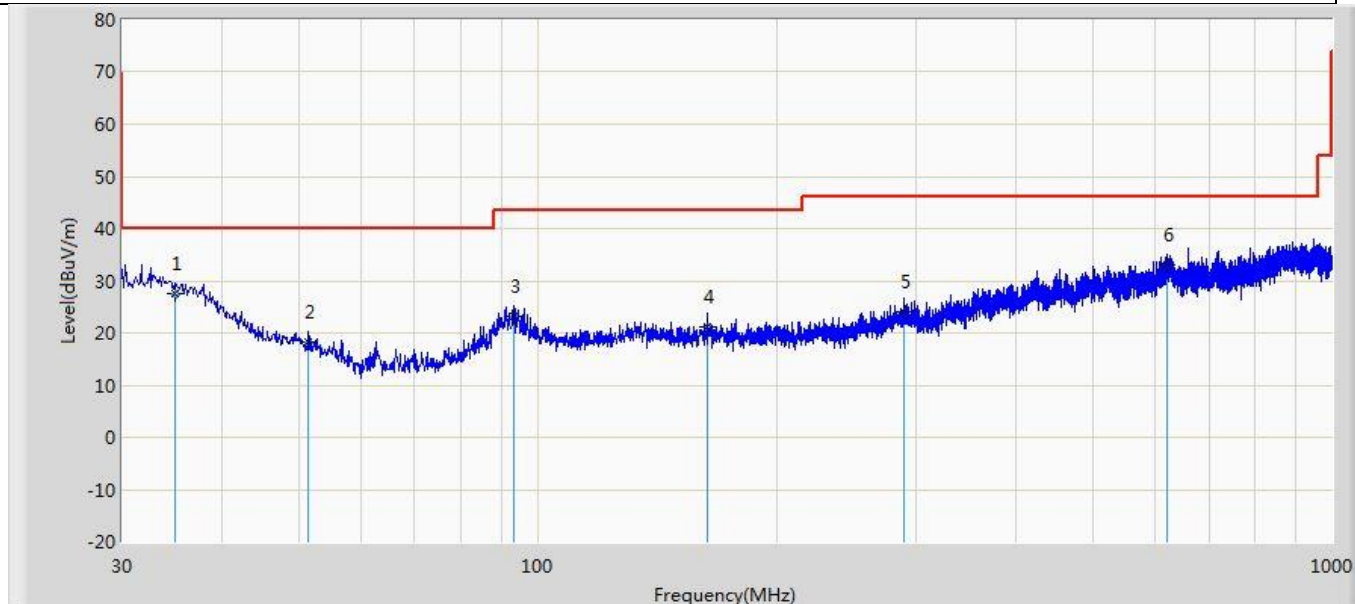

No	Mark	Frequency (MHz)	Measure Level (dBuV/m)	Reading Level (dBuV)	Over Limit (dB)	Limit (dBuV/m)	Factor (dB)	Type
1	*	34.971	27.452	0.505	-12.548	40.000	26.947	QP
2		51.461	18.187	3.031	-21.813	40.000	15.155	QP
3		93.535	23.147	8.554	-20.353	43.500	14.593	QP
4		163.617	21.156	3.828	-22.344	43.500	17.328	QP
5		288.869	23.984	3.372	-22.016	46.000	20.612	QP
6		619.881	33.125	2.353	-12.875	46.000	30.772	QP

Note:

1. All Readings below 1GHz are Quasi-Peak, above are performed with peak and/or average measurements as necessary.
2. " * ", means this data is the worst emission level.
3. Measurement Level = Reading Level + Factor(Probe+Cable-Amp)

4.3 20dB Bandwidth	VERDICT: PASS
---------------------------	----------------------

4.3.1 Limit	
Standard	FCC Part 15 Subpart C Paragraph 15.247(a)
<input checked="" type="checkbox"/>	For frequency hopping systems operating in 2400-2483.5 MHz band, within frequency range.
<input type="checkbox"/>	For frequency hopping systems operating in 902-928 MHz band, the maximum allowed 20 dB bandwidth of the hopping channel is 500 kHz.
<input type="checkbox"/>	For frequency hopping systems operating in 5725-5850 MHz band, the maximum 20 dB bandwidth of the hopping channel is 1 MHz.

4.3.2 Test Setup

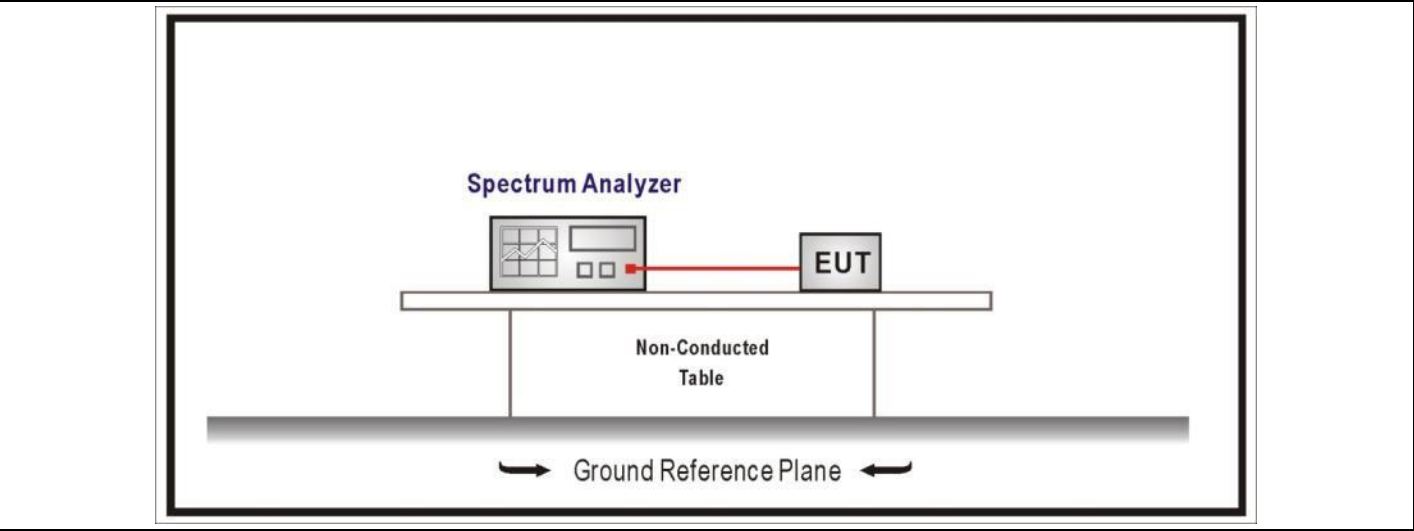

4.3.3 Test Procedure			
----------------------	--	--	--

	References Rule	Chapter	Description
<input checked="" type="checkbox"/>	ANSI C63.10	6.9	Occupied bandwidth tests
<input checked="" type="checkbox"/>	ANSI C63.10	6.9.2	Occupied bandwidth—relative measurement procedure

4.3.4 Test Data

Mode	Channel	Frequency (MHz)	20dB Bandwidth (kHz)	99% Bandwidth (kHz)
1	00	2402	928.5	875.12
	39	2441	924.3	874.23
	79	2480	926.6	872.06
2	00	2402	1358	1208.0
	39	2441	1357	1203.3
	79	2480	1356	1203.6
3	00	2402	1351	1211.3
	39	2441	1351	1208.9
	79	2480	1349	1204.8

Note 1: The worst data plot as below:

Mode3/CH00/2402MHz

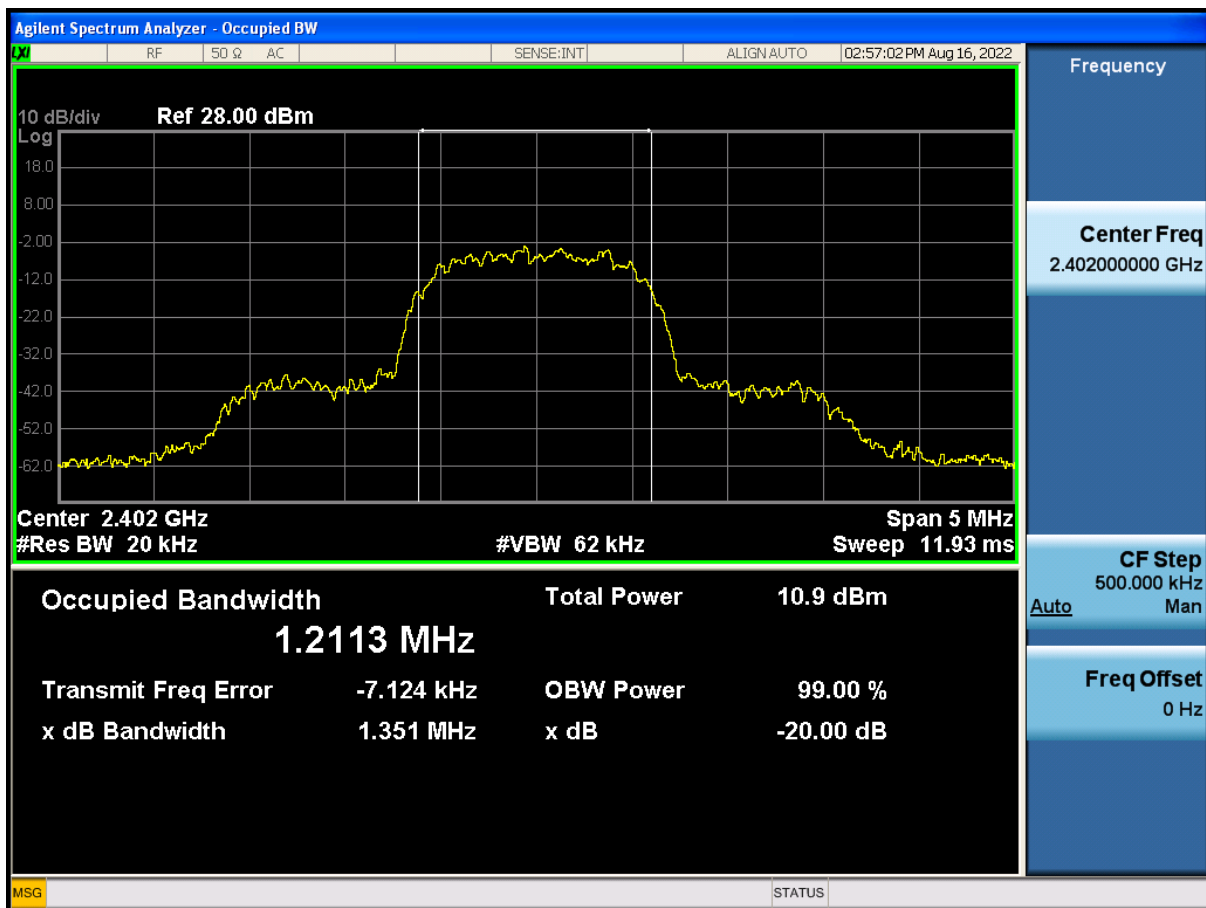

4.4 Carrier Frequency Separation	VERDICT: PASS
---	----------------------

4.4.1 Limit	
Standard	FCC Part 15 Subpart C Paragraph 15.247(a)
<input type="checkbox"/>	Frequency hopping systems shall have hopping channel carrier frequencies separated by a minimum of 25 kHz or the 20 dB bandwidth of the hopping channel, whichever is greater.
<input checked="" type="checkbox"/>	Frequency hopping systems operating in the 2400-2483.5 MHz band may have hopping channel carrier frequencies that are separated by 25 kHz or two-thirds of the 20 dB bandwidth of the hopping channel.
<input type="checkbox"/>	The 20 dB bandwidth of the hopping channel is less than 250 kHz, the system shall use at least 50 hopping frequencies and the average time of occupancy on any frequency shall not be greater than 0.4
<input type="checkbox"/>	The 20 dB bandwidth of the hopping channel is 250 kHz or greater, the system shall use at least 25 hopping frequencies and the average time of occupancy on any frequency shall not be greater than 0.4
<input type="checkbox"/>	Frequency hopping systems operating in the 5725-5850 MHz band shall use at least 75 hopping frequencies. The maximum 20 dB bandwidth of the hopping channel is 1 MHz.

4.4.2 Test Setup

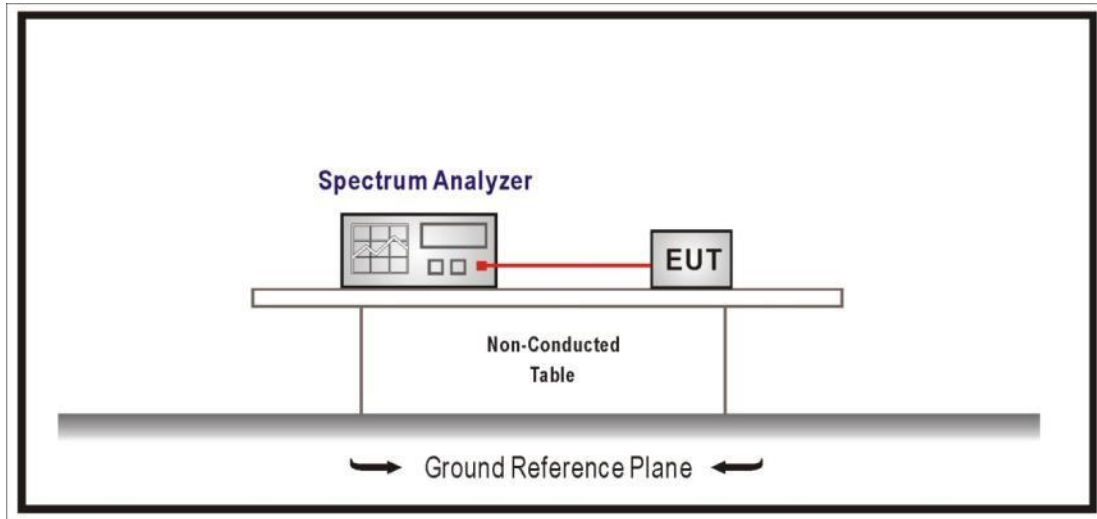

4.4.3 Test Procedure			
----------------------	--	--	--

	References Rule	Chapter	Description
<input checked="" type="checkbox"/>	ANSI C63.10	7.8	Evaluation of frequency-hopping device parameters
<input checked="" type="checkbox"/>	ANSI C63.10	7.8.2	Carrier frequency separation

4.4.4 Test Data

Mode	Channel	Frequency (MHz)	Carrier Frequency Separation (kHz)	Limit (kHz)	Result
1	00	2402	1000	928.5	Pass
	39	2441	1000	924.3	Pass
	78	2480	1000	926.6	Pass
2	00	2402	1000	905.3	Pass
	39	2441	1000	904.7	Pass
	78	2480	1000	904.0	Pass
3	00	2402	1000	900.7	Pass
	39	2441	1000	900.7	Pass
	78	2480	1000	899.3	Pass

Note 1: Model 1 Limit= Model1 20dB Bandwidth

Note 2: Model 2 Limit= Model2 20dB Bandwidth*2/3

Note 3: Model 3 Limit= Model3 20dB Bandwidth*2/3

Note 4: The worst data plot as below:

Mode1/CH00/2402MHz

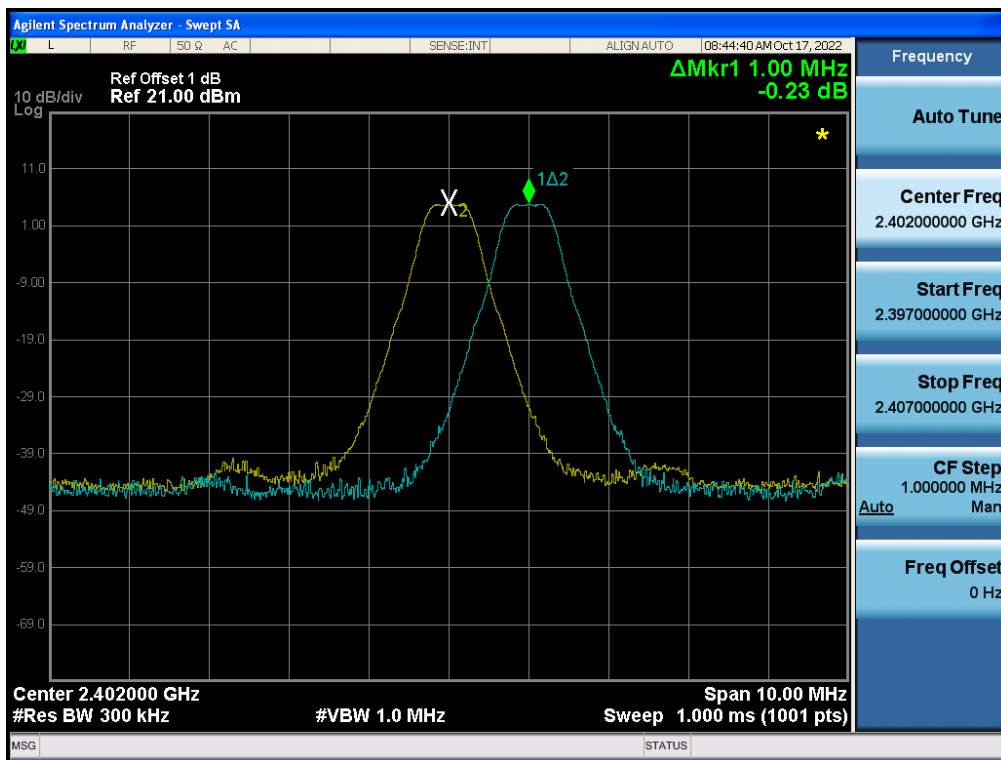

4.5 Number of hopping Frequencies	VERDICT: PASS
--	----------------------

4.5.1 Limit	
Standard	FCC Part 15 Subpart C Paragraph 15.247(a)
<input checked="" type="checkbox"/>	For frequency hopping systems operating in the 2400-2483.5 MHz band shall use at least 15 hopping frequencies.
<input type="checkbox"/>	For frequency hopping systems operating in 902-928 MHz band, if the 20 dB bandwidth of the hopping channel is less than 250 kHz, shall use at least 50 hopping frequencies.
<input type="checkbox"/>	For frequency hopping systems operating in 902-928 MHz band, if the 20 dB bandwidth of the hopping channel is higher than 250 kHz, shall use at least 25 hopping frequencies.
<input type="checkbox"/>	For frequency hopping systems operating in the 5725-5850 MHz band shall use at least 75 hopping frequencies.

4.5.2 Test Setup

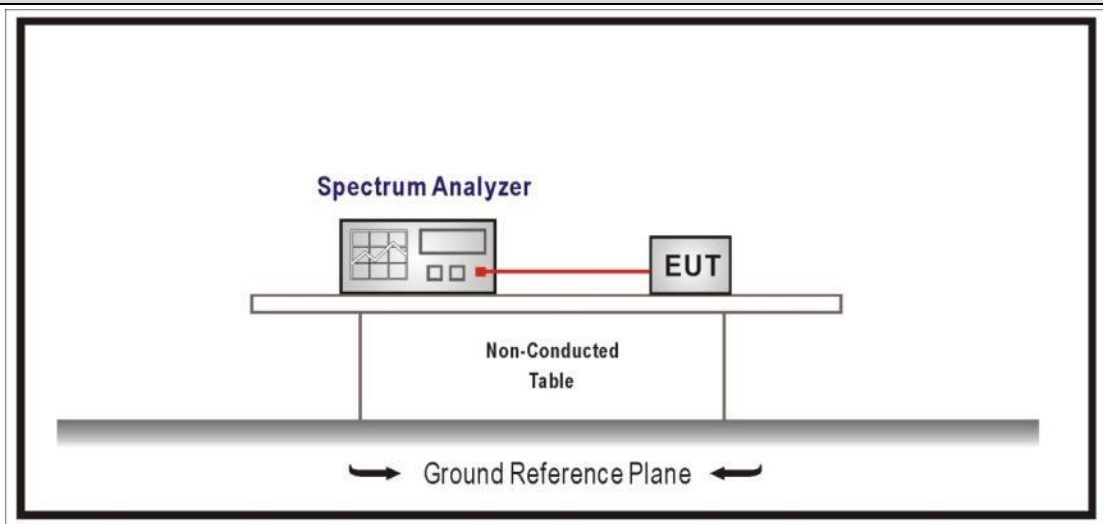

4.5.3 Test Procedure			
----------------------	--	--	--

References Rule	Chapter	Description
<input checked="" type="checkbox"/> ANSI C63.10	7.8.	Evaluation of frequency-hopping device parameters
<input checked="" type="checkbox"/> ANSI C63.10	7.8.3	Number of Hopping Frequencies

4.5.4 Test Data

Mode	Number of Hopping Frequencies	Limit	Result
1	79	>15	Pass
2	79	>15	Pass
3	79	>15	Pass

Mode 1

Mode2

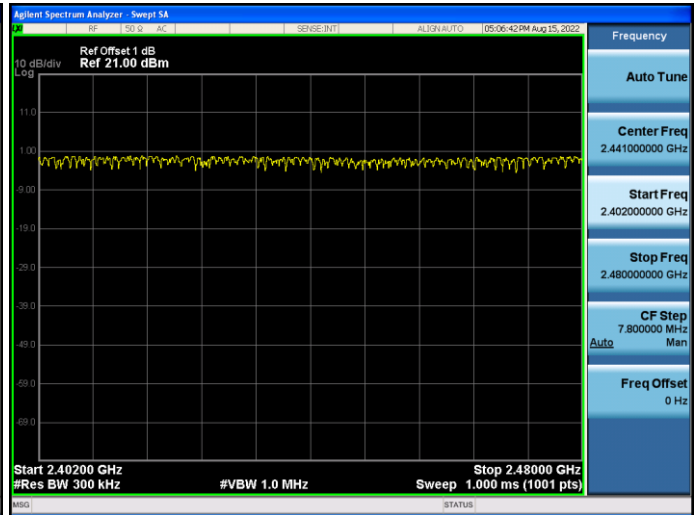
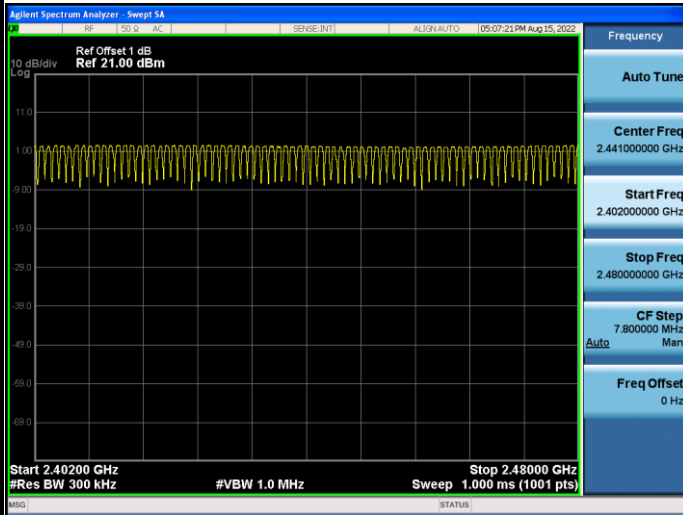

Mode 3

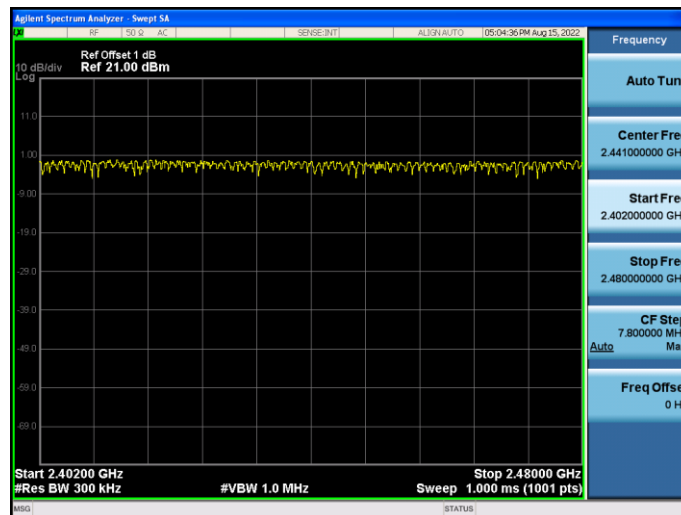

4.6 Time of Occupancy(Dwell Time)	VERDICT: PASS
--	----------------------

4.6.1 Limit	
Standard	FCC Part 15 Subpart C Paragraph 15.247(a)
<input checked="" type="checkbox"/>	Frequency hopping systems in the 2400-2483.5 MHz band shall use at least 15 channels. The average time of occupancy on any channel shall not be greater than 0.4 seconds within a period of 0.4 seconds multiplied by the number of hopping channels employed.
<input type="checkbox"/>	For frequency hopping systems operating in the 902-928 MHz band: if the 20 dB bandwidth of the hopping channel is less than 250 kHz, the system shall use at least 50 hopping frequencies and the average time of occupancy on any frequency shall not be greater than 0.4 seconds within a 20 second period
<input type="checkbox"/>	For frequency hopping systems operating in the 902-928 MHz band: if the 20 dB bandwidth of the hopping channel is 250 kHz or greater, the system shall use at least 25 hopping frequencies and the average time of occupancy on any frequency shall not be greater than 0.4 seconds within a 10 second period.
<input type="checkbox"/>	Frequency hopping systems operating in the 5725-5850 MHz band shall use at least 75 hopping frequencies. The maximum 20 dB bandwidth of the hopping channel is 1 MHz. The average time of occupancy on any frequency shall not be greater than 0.4 seconds within a 30 second period.

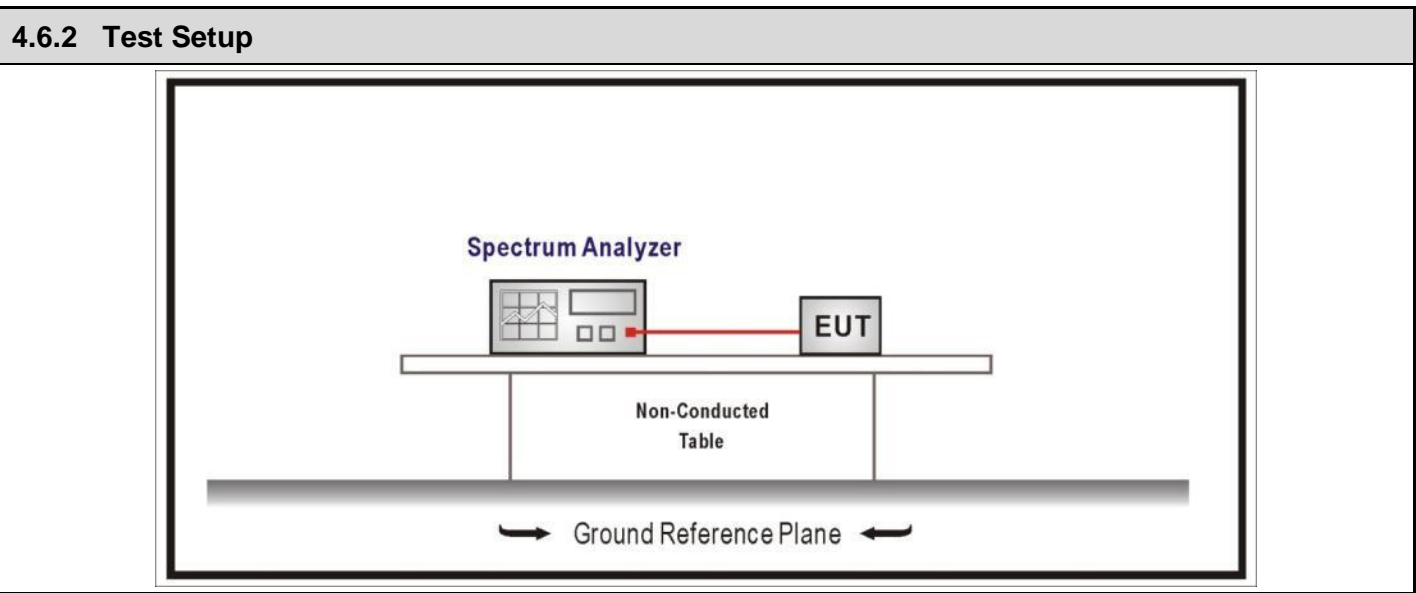

4.6.3 Test Procedure			
	References Rule	Chapter	Description
<input checked="" type="checkbox"/>	ANSI C63.10	7.8	Evaluation of frequency-hopping device parameters
<input checked="" type="checkbox"/>	ANSI C63.10	7.8.4	Time of occupancy (dwell time)

4.6.4 Test Data

Mode	Channel	Frequency (MHz)	Time of Occupancy (ms)	Limit (ms)	Result
1	39	2441	119.68	< 400	Pass

Note1: Test Time Period: $0.4 \times 79 = 31.6 \text{ sec}$

Note2: Time of Occupancy = $0.374 \times 32 \times 31.6 / 3.16 = 119.68 \text{ ms}$

Note3: We have evaluated different packet type, shown in the report is the worst data.

Channel 39 (2441MHz) - (DH1)

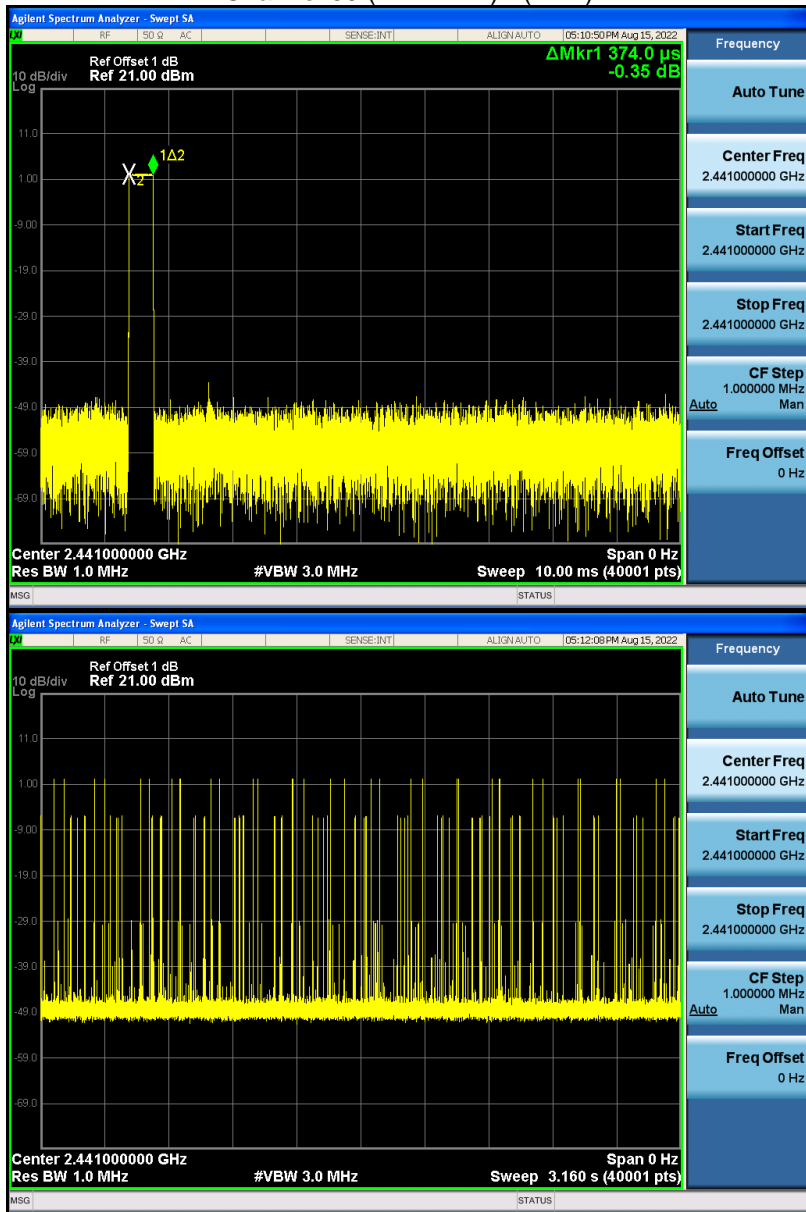

Mode	Channel	Frequency (MHz)	Time of Occupancy (ms)	Limit (ms)	Result
1	39	2441	114.03	< 400	Pass

Note1: Test Time Period: $0.4 \times 79 = 31.6 \text{sec}$

Note2: Time of Occupancy = $1.629 \times 7 \times 31.6 / 3.16 = 114.03 \text{ms}$

Note3: We have evaluated different packet type, shown in the report is the worst data.

Channel 39 (2441MHz) - (DH3)

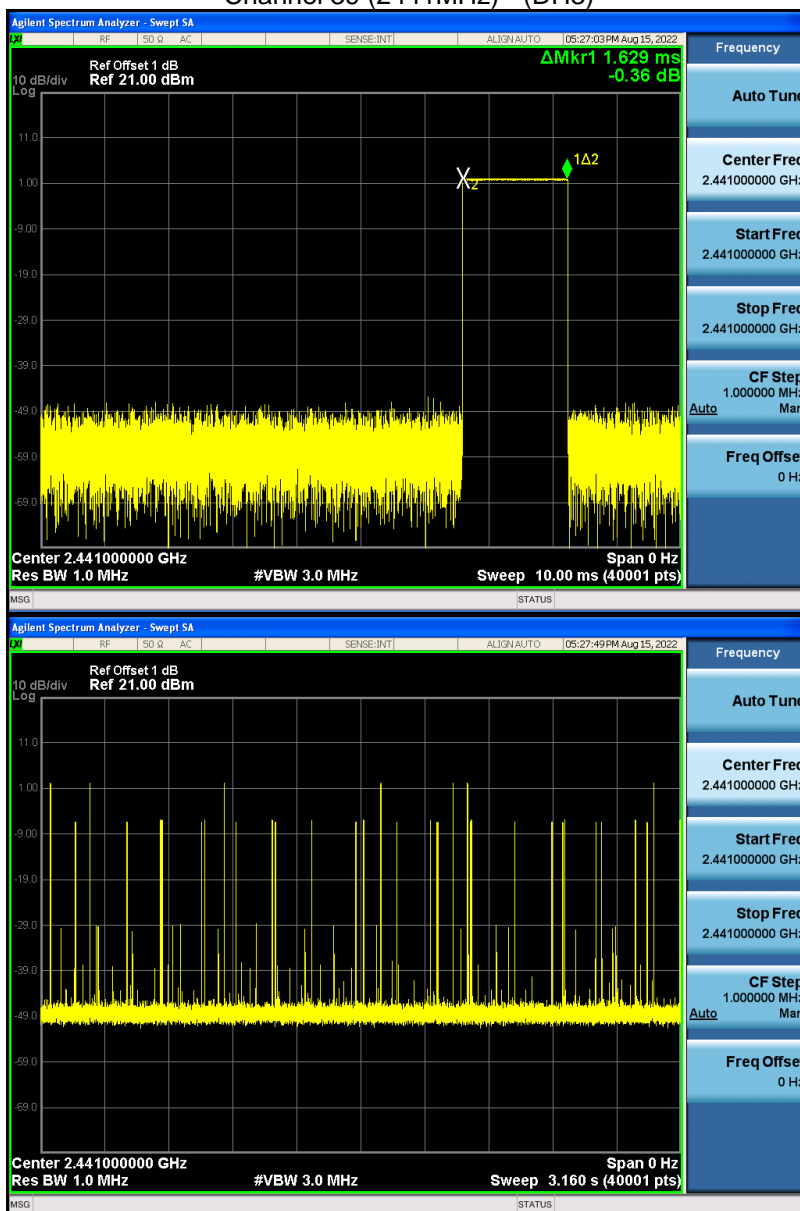

Mode	Channel	Frequency (MHz)	Time of Occupancy (ms)	Limit (ms)	Result
1	39	2441	230.4	< 400	Pass

Note1: Test Time Period: $0.4 \times 79 = 31.6 \text{sec}$

Note2: Time of Occupancy = $2.880 \times 8 \times 31.6 / 3.16 = 230.4 \text{ms}$

Note3: We have evaluated different packet type, shown in the report is the worst data.

Channel 39 (2441MHz) - (DH5)

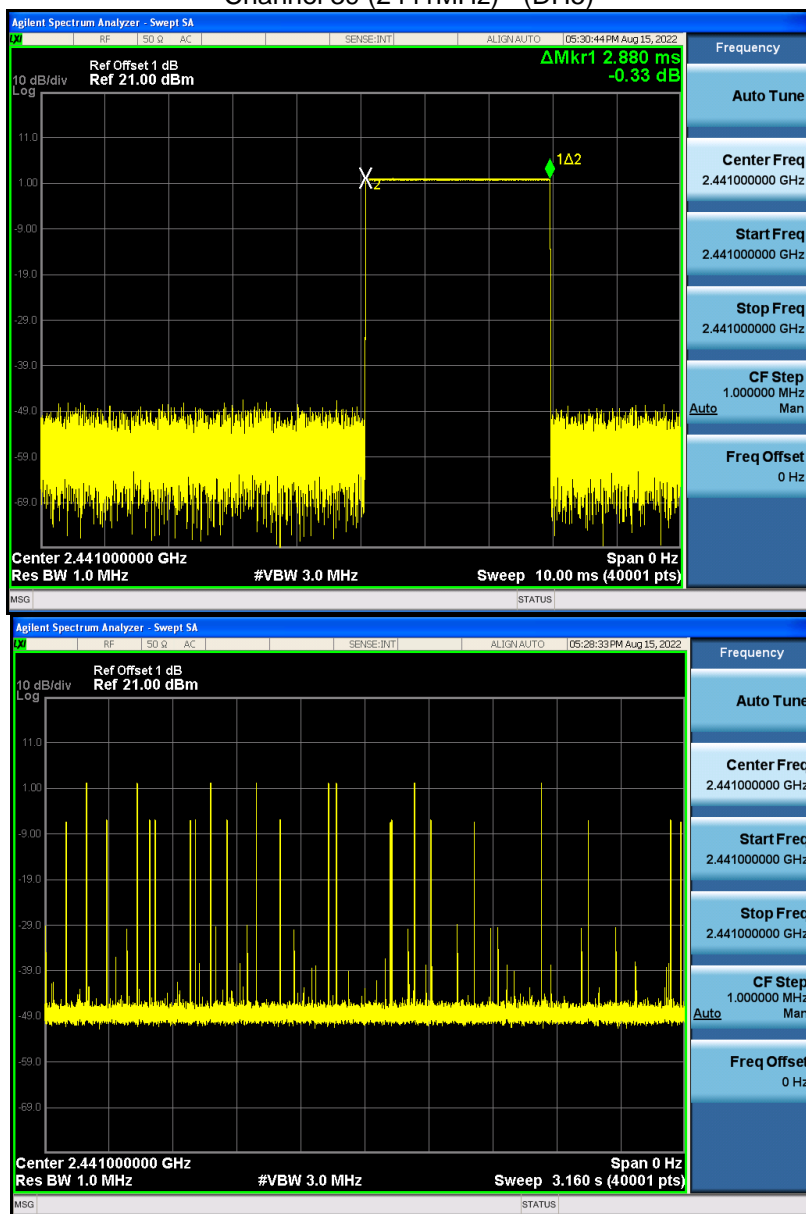

Note: The packet time of AFH mode is same as normal mode, due to the packet time of AFH mode multiply with lesser factor is dwell time of $0.4 \times 20 = 8 \text{S}$, the dwell time of AFH mode comply with the limit.

4.7 Peak Output Power	VERDICT: PASS
------------------------------	----------------------

4.7.1 Limit

Standard	FCC Part 15 Subpart C Paragraph 15.247 (a)(1)
<input checked="" type="checkbox"/>	Frequency hopping systems operating in the 2400-2483.5 MHz band employing at least 75 non-overlapping hopping channels, and all frequency hopping systems in the 5725-5850 MHz band: 1 watt. For all other frequency hopping systems in the 2400-2483.5 MHz band: 0.125 watts.
<input checked="" type="checkbox"/>	Frequency hopping systems operating in the 2400-2483.5 MHz band may have hopping channel carrier frequencies that are separated by 25 kHz or two-thirds of the 20 dB bandwidth of the hopping channel, whichever is greater, provided the systems operate with an output power no greater than 125 mW.
<input type="checkbox"/>	For frequency hopping systems operating in the 902-928 MHz band: 1 watt for systems employing at least 50 hopping channels; and, 0.25 watts for systems employing less than 50 hopping channels, but at least 25 hopping channels

4.7.2 Test Setup

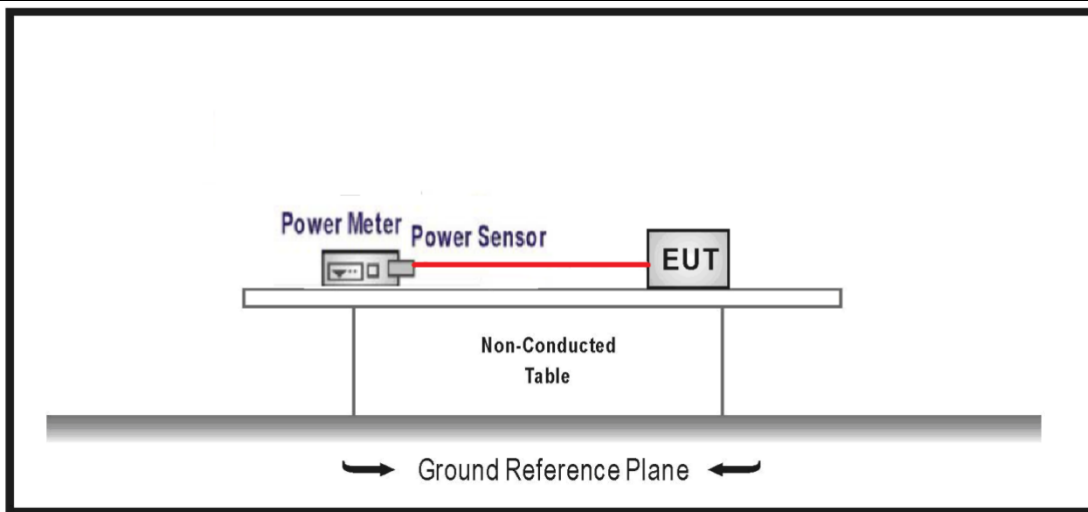

4.7.3 Test Procedure				
	References Rule		Chapter	Description
<input checked="" type="checkbox"/>	ANSI C63.10		7.8	Evaluation of frequency-hopping device parameters
	<input checked="" type="checkbox"/>	ANSI C63.10	7.8.5	Output power test procedure for frequency-hopping spread-spectrum (FHSS) devices

4.7.4 Test Data

Mode	Channel	Test Frequency (MHz)	Conducted Power (dBm)	Conducted Power Limit (dBm)	Result
Mode 1	00	2402	7.25	≤30	Pass
	39	2441	6.21	≤30	Pass
	78	2480	5.56	≤30	Pass
Mode 2	00	2402	7.06	≤21	Pass
	39	2441	5.92	≤21	Pass
	78	2480	5.25	≤21	Pass
Mode 3	00	2402	7.51	≤21	Pass
	39	2441	6.48	≤21	Pass
	78	2480	5.83	≤21	Pass

Power setting parameter: EUT default.

4.8 Emissions in non-restricted frequency band	VERDICT: PASS
---	----------------------

4.8.1 Limit	
Standard	FCC Part 15 Subpart C Paragraph 15.247(d)
RF Output power (Detection methods)	Limit(dB)
RF Output power(Average detector)	30dBc(Note1)
RF Output power(PK detector)	20dBc(Note2)
<p>Note 1: If maximum conducted (average) output power was used to demonstrate compliance as described in 9.2, then the peak power in any 100 kHz bandwidth outside of the authorized frequency band shall be attenuated by at least 30 dB relative to the maximum in-band peak PSD level in 100 kHz (i.e., 30 dBc).</p> <p>Note 2: If the maximum peak conducted output power procedure was used, then the peak output power measured in any 100 kHz bandwidth outside of the authorized frequency band shall be attenuated by at least 20 dB relative to the maximum in-band peak PSD level in 100 kHz (i.e., 20 dBc).</p>	

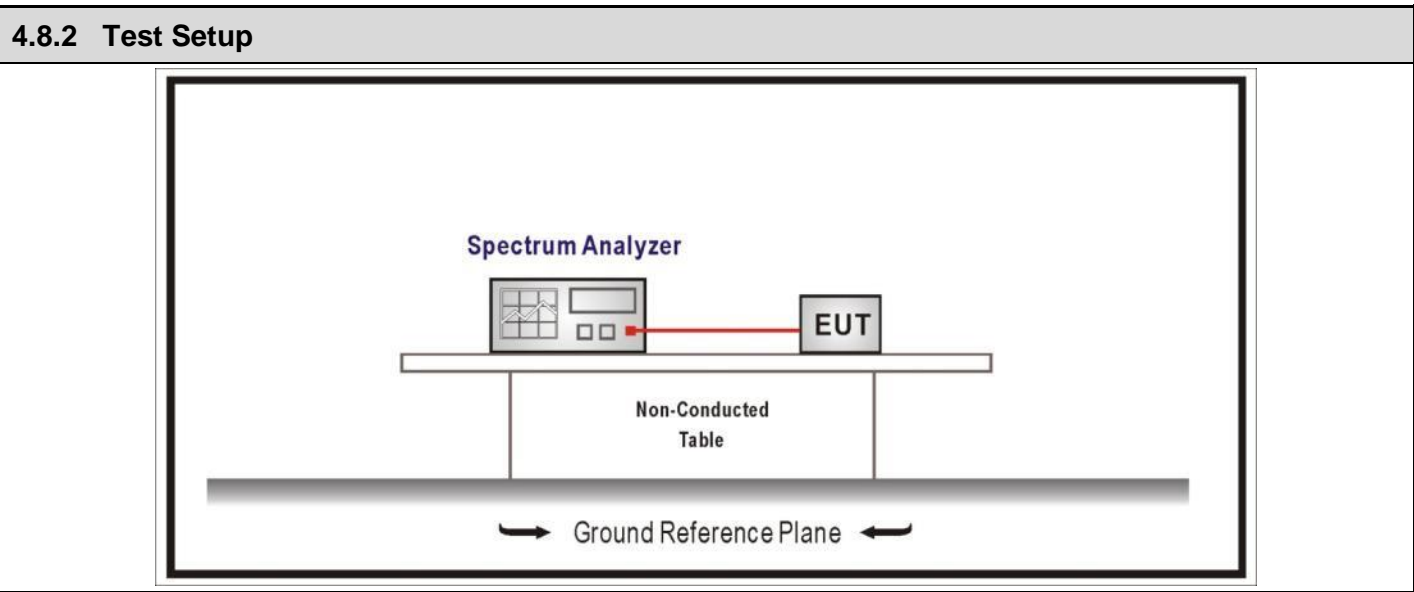

4.8.3 Test Procedure			
References Rule	Chapter	Description	
<input checked="" type="checkbox"/> ANSI C63.10	7.8	Evaluation of frequency-hopping device parameters	
<input checked="" type="checkbox"/> ANSI C63.10	7.8.6	Band-edge measurements for RF conducted emissions	

4.8.4 Test Data

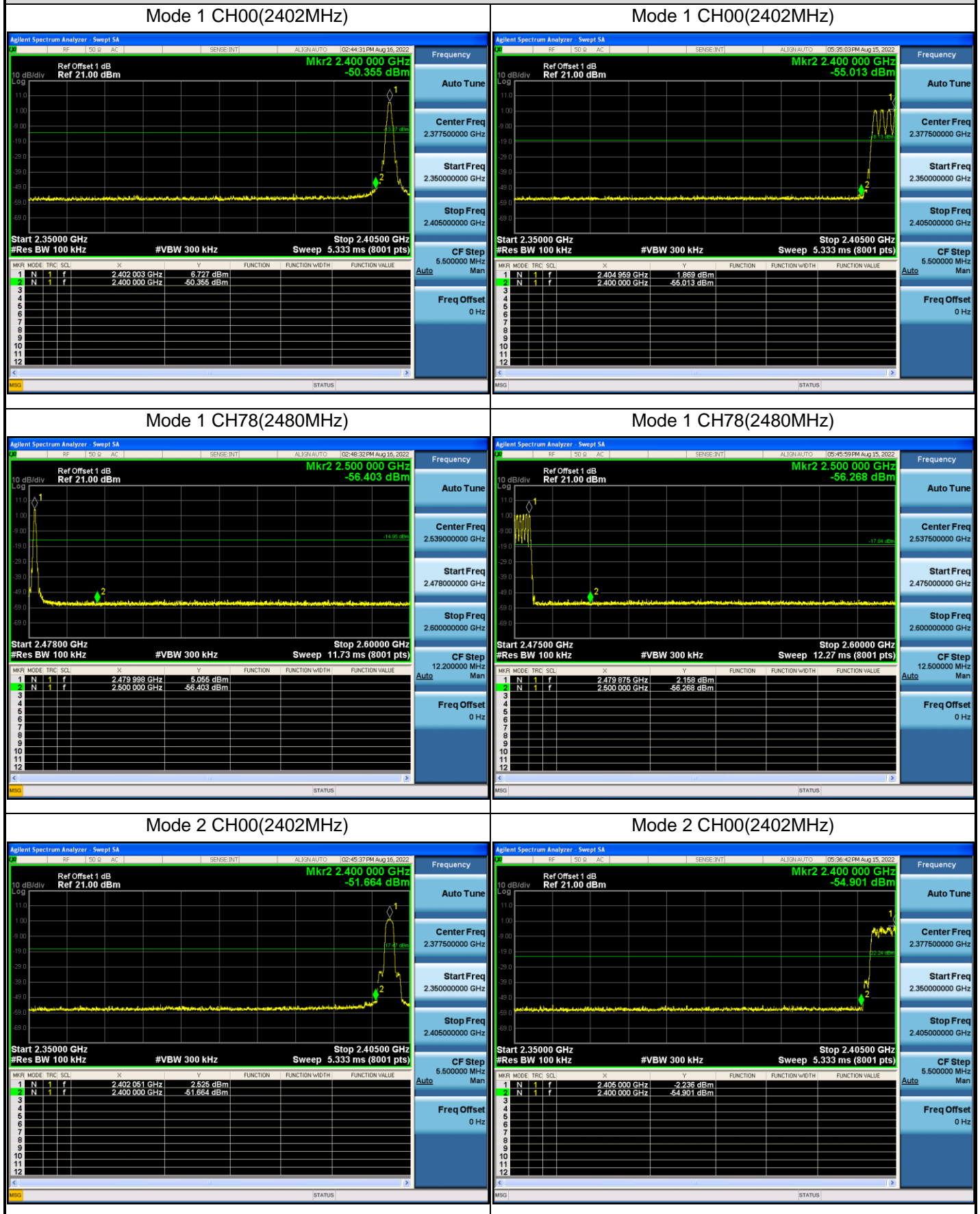

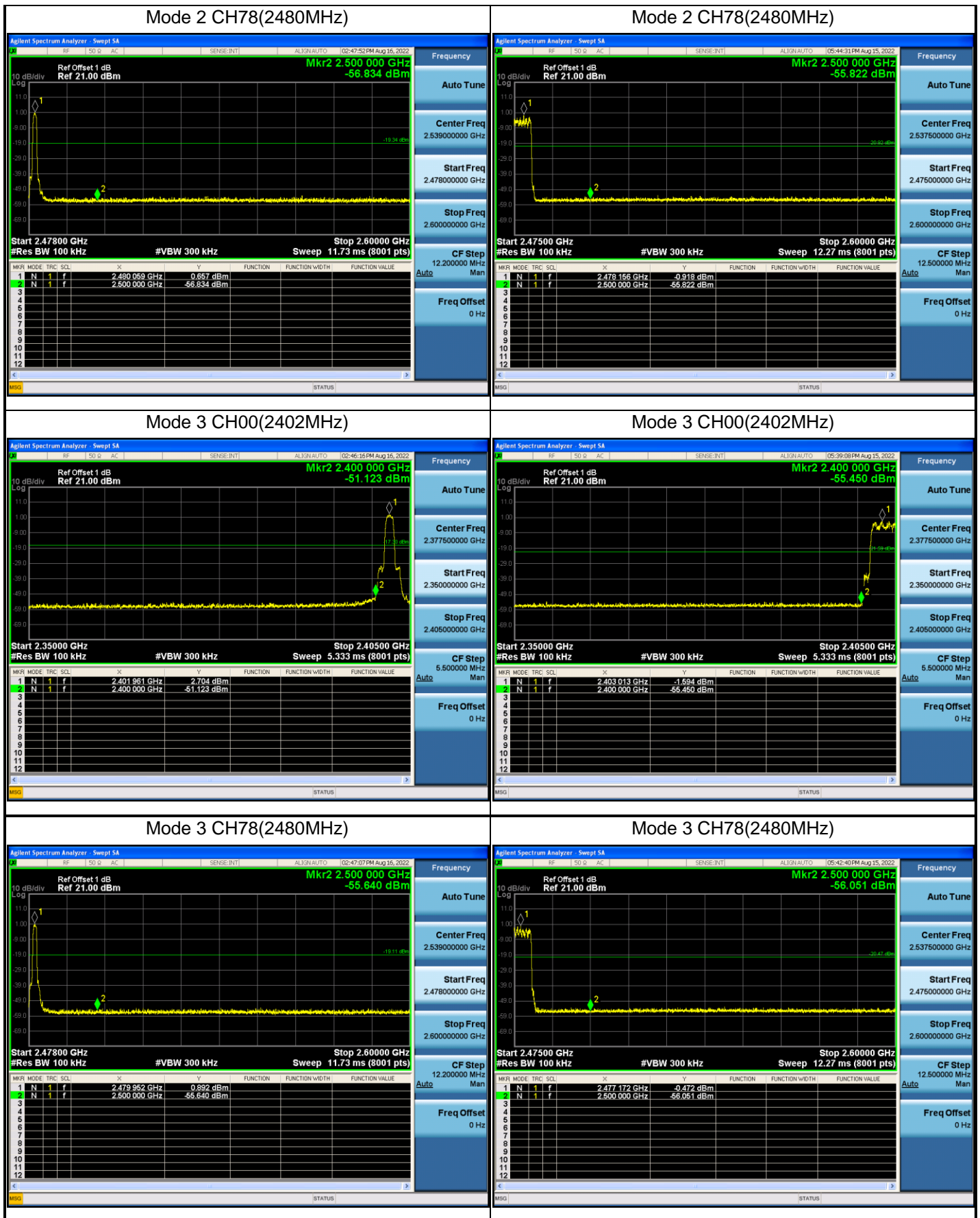

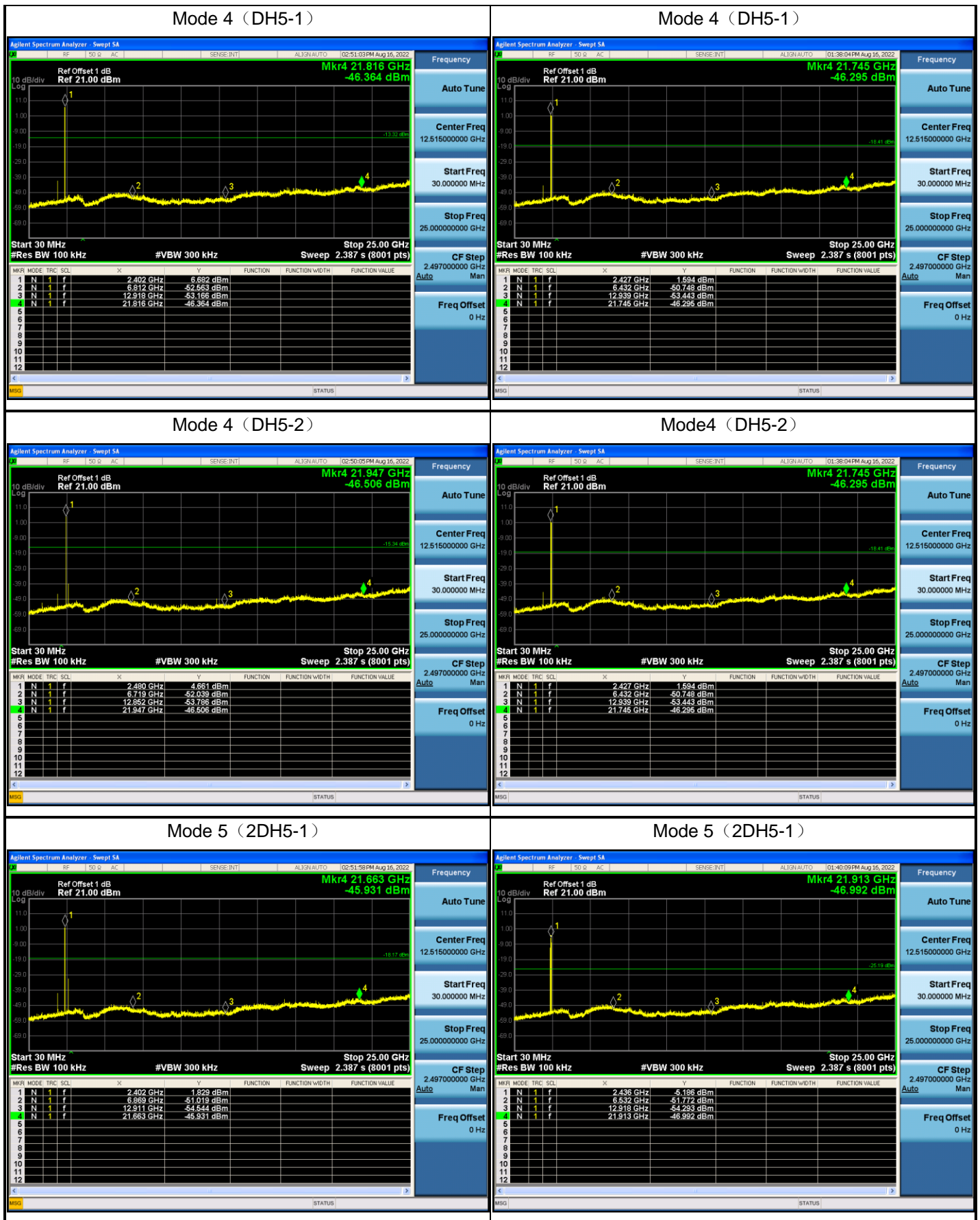

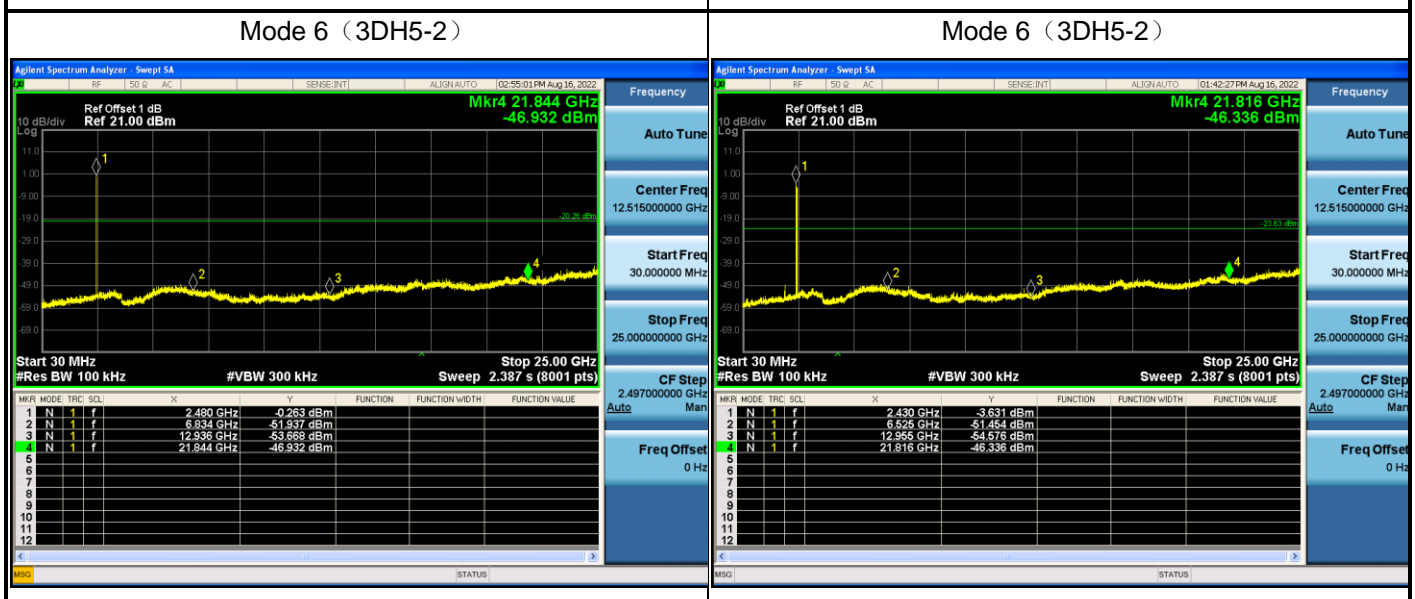
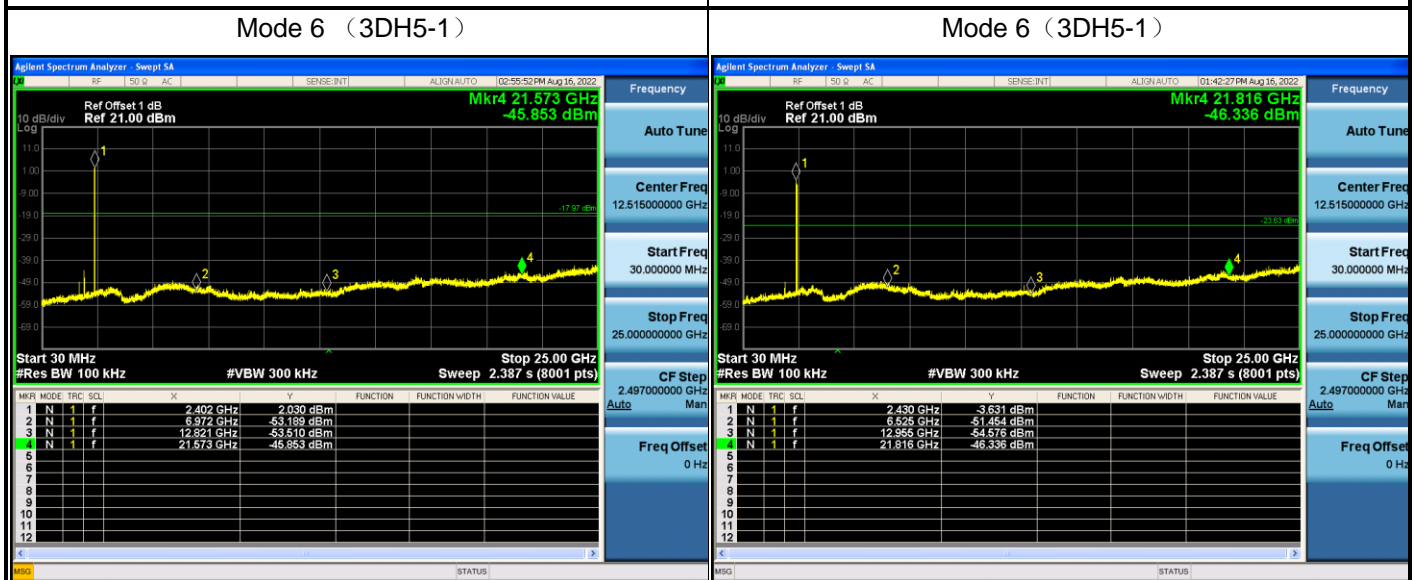
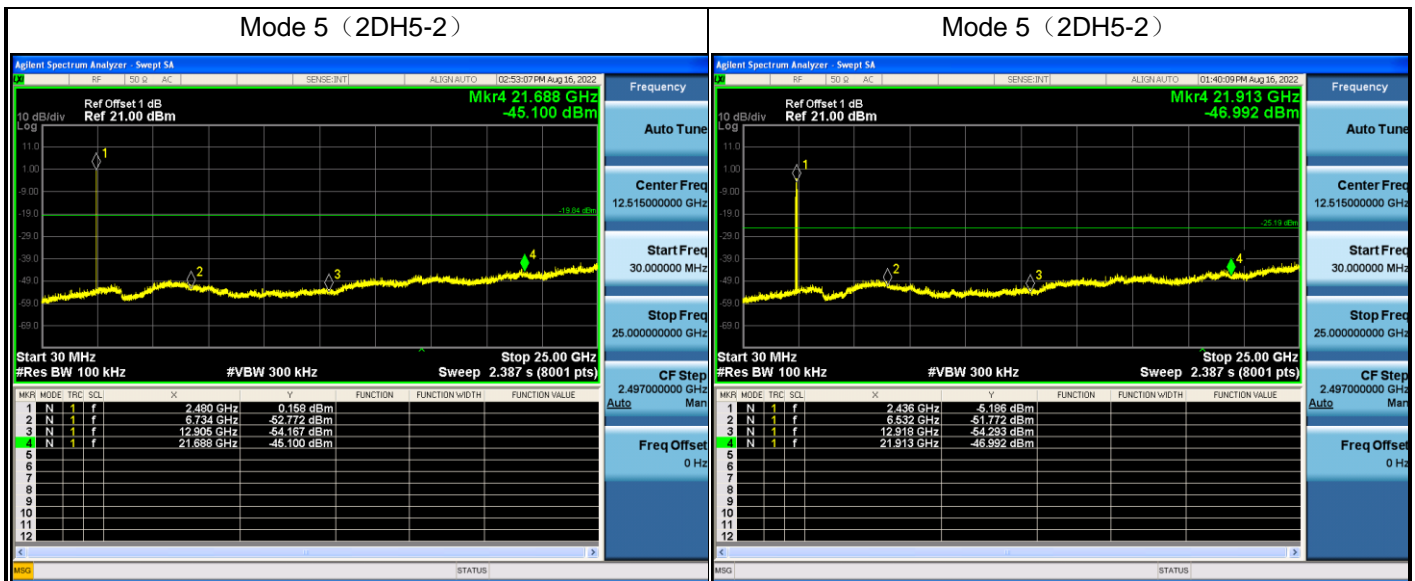

4.9 Duty cycle	VERDICT: PASS
-----------------------	----------------------

4.9.1 Limit
N/A

4.9.2 Test Setup

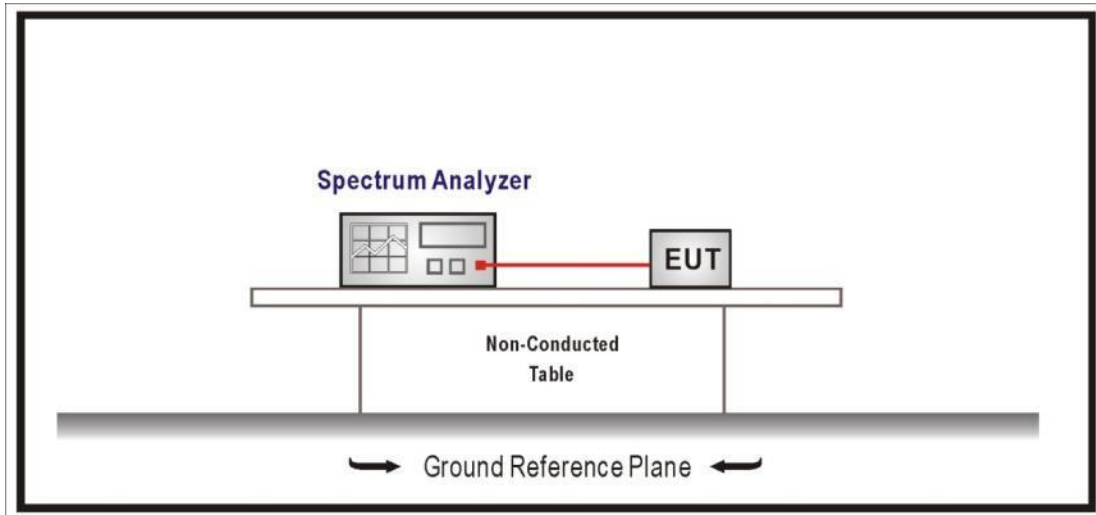

4.9.3 Test Procedure

	References Rule	Chapter	Description
<input checked="" type="checkbox"/>	ANSI C63.10	11.6	Duty cycle (D), transmission duration (T), and maximum power control level

4.9.4 Test Data

Test Mode	Tx On (ms)	Tx Off (ms)	VBW (kHz)	Tx On + Tx Off (ms)	Duty Cycle (%)
Mode 1	N/A	N/A	10Hz	N/A	100
Mode 2	N/A	N/A	10Hz	N/A	100
Mode 3	N/A	N/A	10Hz	N/A	100

Note 1: T means the minimum transmission duration over which the transmitter is on and is transmitting at its maximum power control level for the tested mode of operation.

Note 2: According to KDB 558074, when test for Radiated Emission Band Edge and Radiated Emission, for average detector set: $VBW \geq 1/T$ will be used.

Mode 1 CH39 2441MHz

Mode 2 CH39 2441MHz

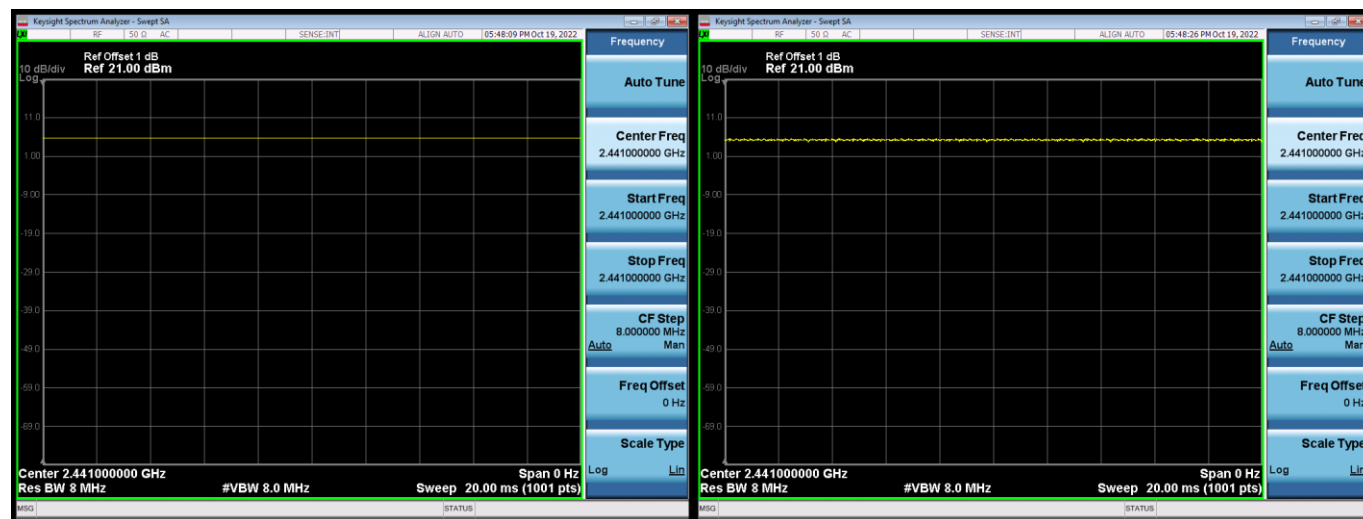

Mode 3 CH39 2441MHz

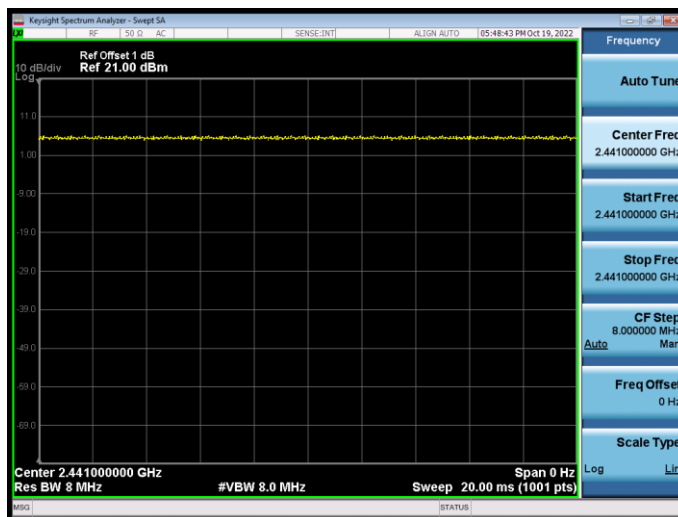

4.10 Band Edge	VERDICT: PASS
-----------------------	----------------------

4.10.1 Limit

Standard		FCC Part 15 Subpart C Paragraph 15.247(d) ,15.209		
Frequency bands (MHz)	Detector	Limit (dB μ V/m)	RBW (MHz)	Distance (m)
2310-2390	PK	74	1	3
2483.5-2500	AV	54	1	3

Note: The field strength of emissions appearing within these frequency bands shall not exceed the limits.

4.10.2 Test Setup

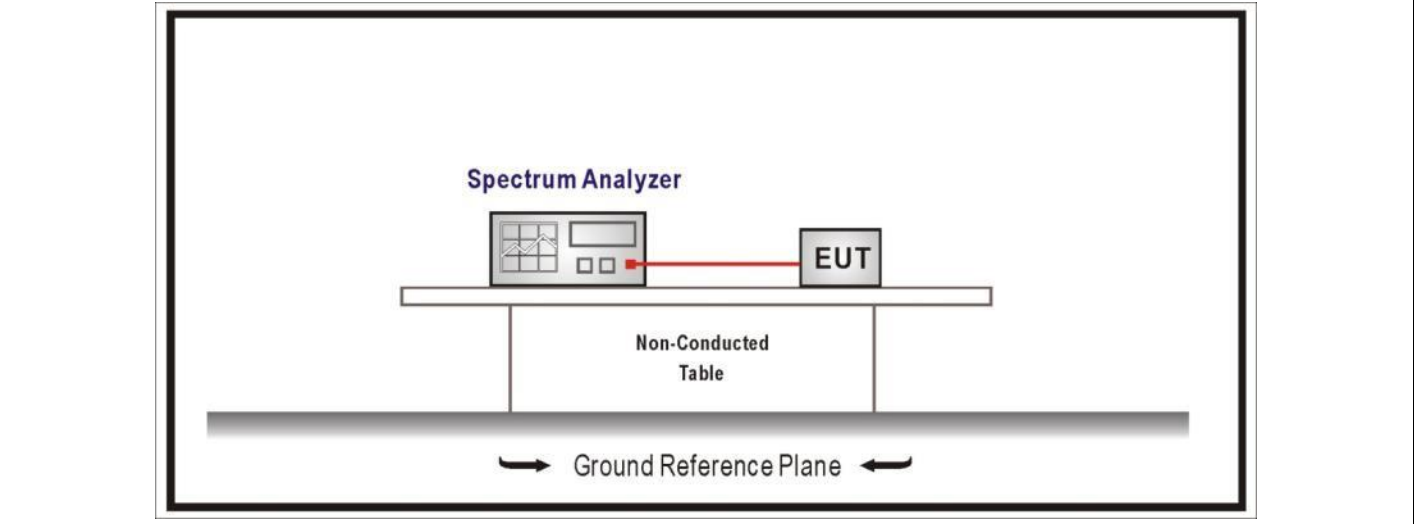

4.10.3 Test Procedure

Test Method			
	References Rule	Chapter	Description
<input type="checkbox"/>	DA 00-705	N/A	duty cycle correction factor
<input checked="" type="checkbox"/>	ANSI C63.10	6.10	Band-edge testing
	<input checked="" type="checkbox"/> ANSI C63.10	6.10.5	Restricted-band band-edge measurements
	<input type="checkbox"/> ANSI C63.10	6.10.6	Marker-delta method
<input type="checkbox"/>	ANSI C63.10	6.4	Radiated emissions from unlicensed wireless devices below 30 MHz
<input type="checkbox"/>	ANSI C63.10	6.5	Radiated emissions from unlicensed wireless devices in the frequency range of 30 MHz to 1000 MHz
<input type="checkbox"/>	ANSI C63.10	6.6	Radiated emissions from unlicensed wireless devices above 1 GHz

4.10.4 Test Data

Profile: 22A0151R	Page No.: 1
Engineer: YuLiu	
Site: AC5	Time: 2022/08/15 - 21:32
Limit: FCC_Part15.209_RE(3m)	Margin: 0
Probe: Horn_3117_00167055(1-18GHz)	Polarity: Vertical
EUT: AH80 BLUETOOTH HEADSET DONGLE	Power: DC 5V
Note: Mode1:Transmit at 2402MHz by DH5	

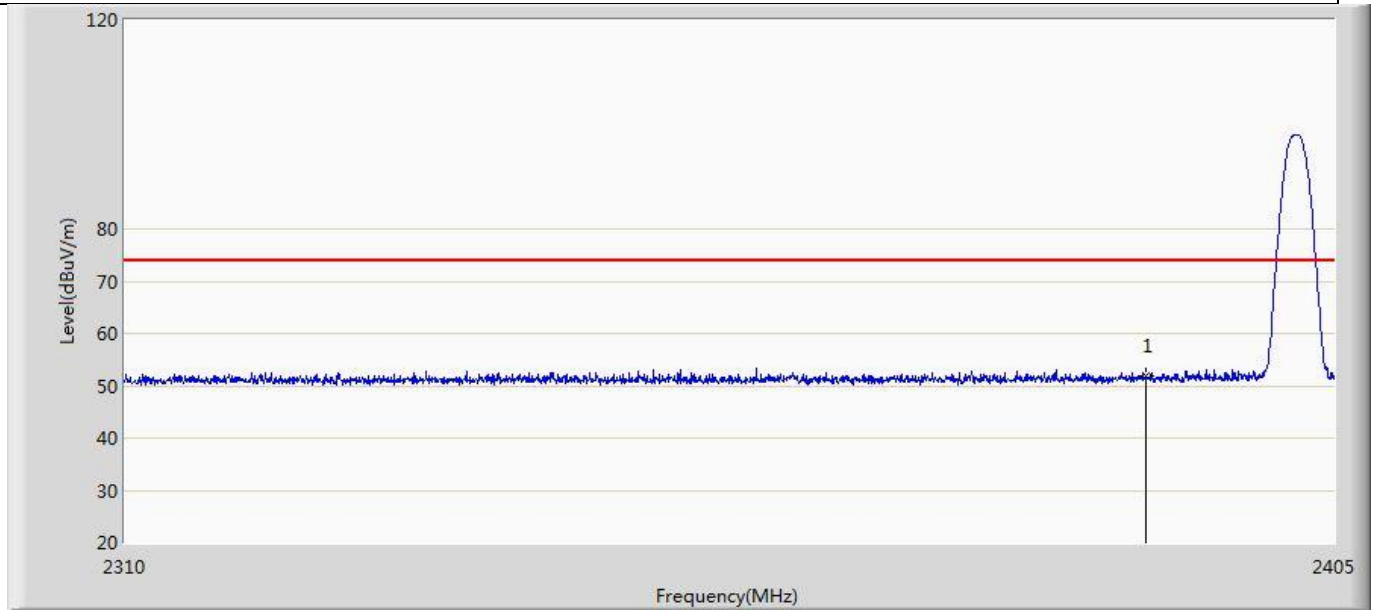

No	Mark	Frequency (MHz)	Measure Level (dBuV/m)	Reading Level (dBuV)	Over Limit (dB)	Limit (dBuV/m)	Factor (dB)	Type
1	*	2390.000	51.750	15.554	-22.250	74.000	36.196	PK

Profile: 22A0151R	Page No.: 2
Engineer: YuLiu	
Site: AC5	Time: 2022/08/15 - 21:42
Limit: FCC_Part15.209_RE(3m)	Margin: 0
Probe: Horn_3117_00167055(1-18GHz)	Polarity: Vertical
EUT: AH80 BLUETOOTH HEADSET DONGLE	Power: DC 5V
Note: Mode1:Transmit at 2402MHz by DH5	

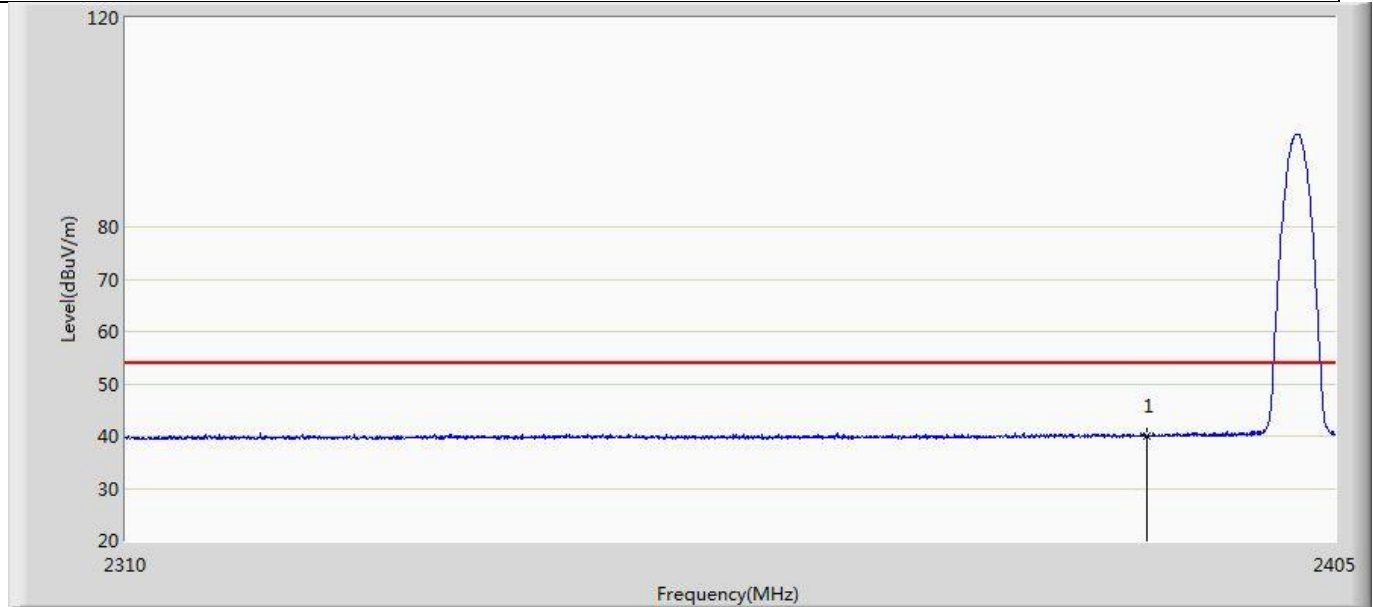

No	Mark	Frequency (MHz)	Measure Level (dBuV/m)	Reading Level (dBuV)	Over Limit (dB)	Limit (dBuV/m)	Factor (dB)	Type
1	*	2390.000	40.042	3.846	-13.958	54.000	36.196	AV

Profile: 22A0151R	Page No.: 3
Engineer: YuLiu	
Site: AC5	Time: 2022/08/15 - 21:51
Limit: FCC_Part15.209_RE(3m)	Margin: 0
Probe: Horn_3117_00167055(1-18GHz)	Polarity: Horizontal
EUT: AH80 BLUETOOTH HEADSET DONGLE	Power: DC 5V
Note: Mode1:Transmit at 2402MHz by DH5	

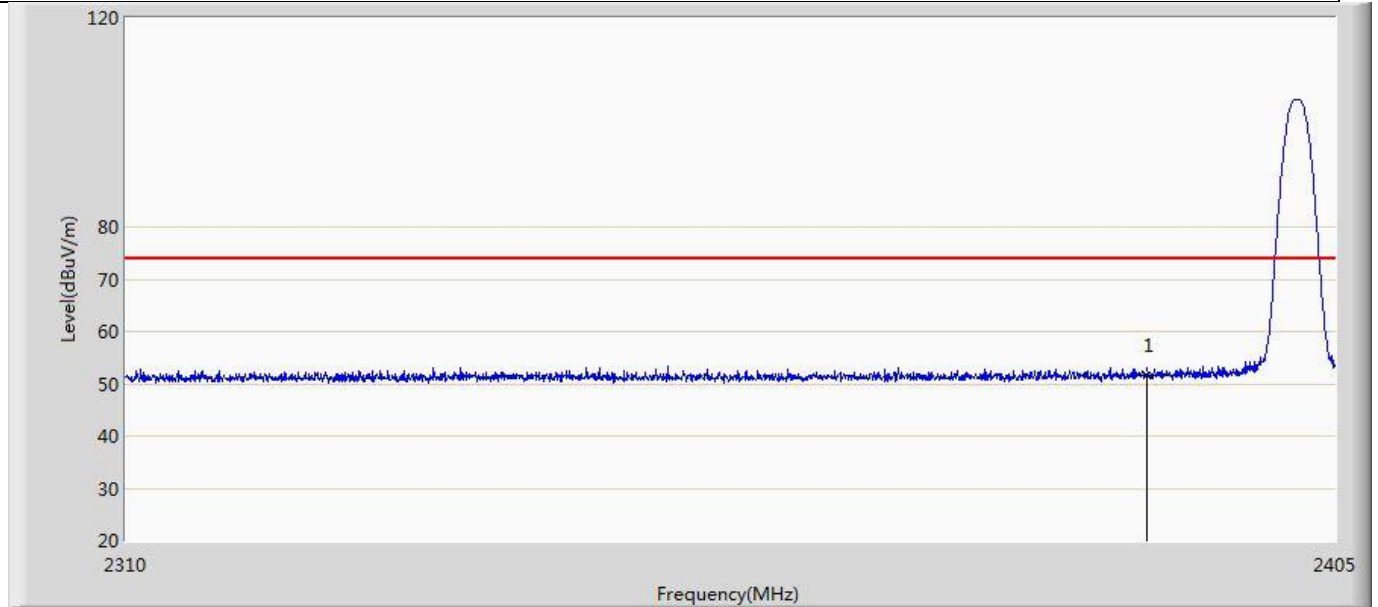

No	Mark	Frequency (MHz)	Measure Level (dBuV/m)	Reading Level (dBuV)	Over Limit (dB)	Limit (dBuV/m)	Factor (dB)	Type
1	*	2390.000	51.708	15.512	-22.292	74.000	36.196	PK

Profile: 22A0151R	Page No.: 4
Engineer: YuLiu	
Site: AC5	Time: 2022/08/15 - 21:52
Limit: FCC_Part15.209_RE(3m)	Margin: 0
Probe: Horn_3117_00167055(1-18GHz)	Polarity: Horizontal
EUT: AH80 BLUETOOTH HEADSET DONGLE	Power: DC 5V
Note: Mode1:Transmit at 2402MHz by DH5	

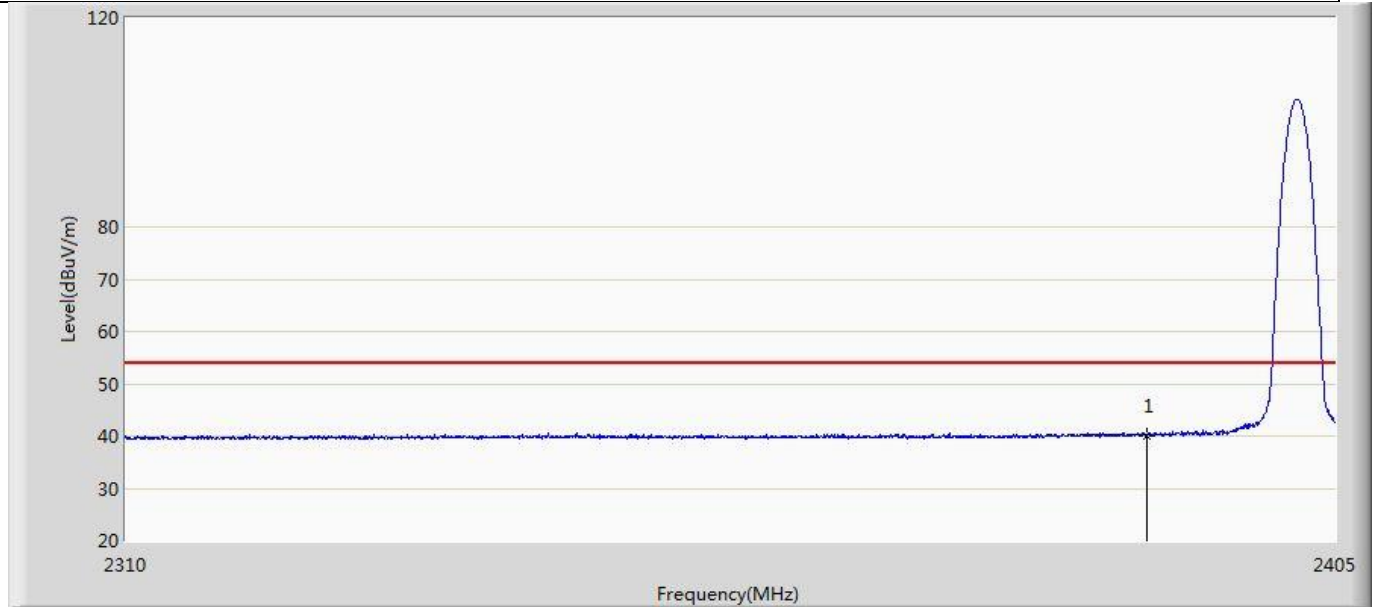

No	Mark	Frequency (MHz)	Measure Level (dBuV/m)	Reading Level (dBuV)	Over Limit (dB)	Limit (dBuV/m)	Factor (dB)	Type
1	*	2390.000	40.021	3.825	-13.979	54.000	36.196	AV

Profile: 22A0151R	Page No.: 5
Engineer: YuLiu	
Site: AC5	Time: 2022/08/15 - 21:53
Limit: FCC_Part15.209_RE(3m)	Margin: 0
Probe: Horn_3117_00167055(1-18GHz)	Polarity: Vertical
EUT: AH80 BLUETOOTH HEADSET DONGLE	Power: DC 5V
Note: Mode1:Transmit at 2480MHz by DH5	

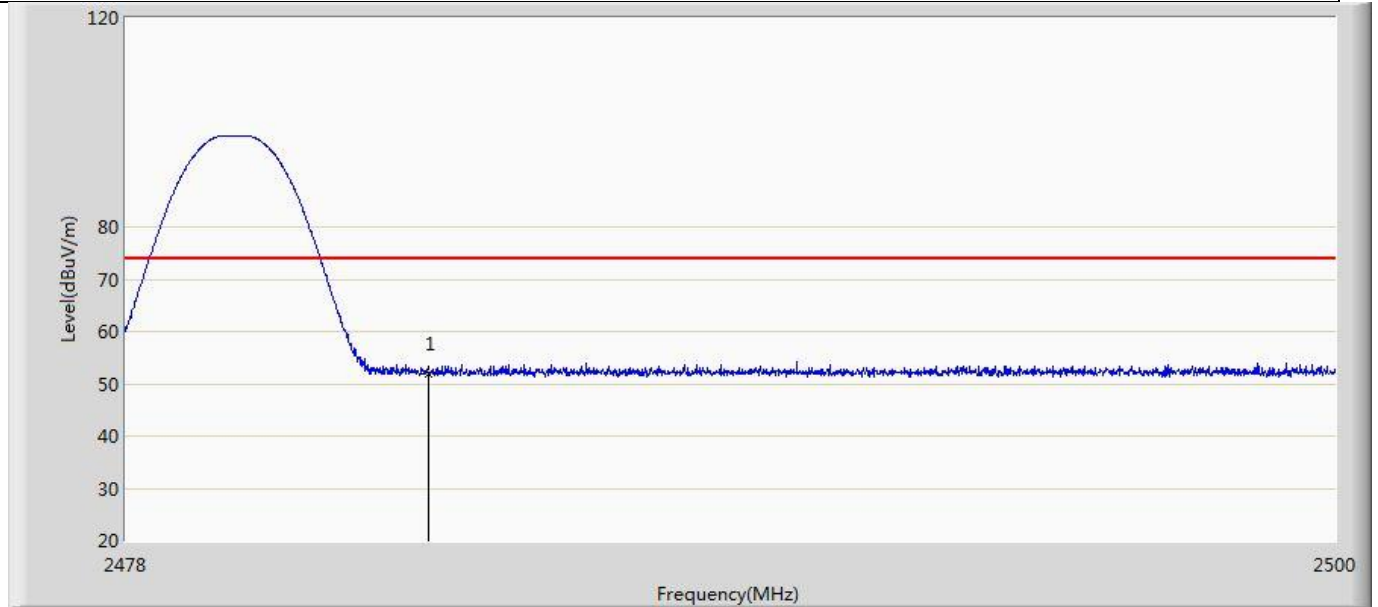

No	Mark	Frequency (MHz)	Measure Level (dBuV/m)	Reading Level (dBuV)	Over Limit (dB)	Limit (dBuV/m)	Factor (dB)	Type
1	*	2483.500	51.975	15.390	-22.025	74.000	36.585	PK

Profile: 22A0151R	Page No.: 6
Engineer: YuLiu	
Site: AC5	Time: 2022/08/15 - 21:56
Limit: FCC_Part15.209_RE(3m)	Margin: 0
Probe: Horn_3117_00167055(1-18GHz)	Polarity: Vertical
EUT: AH80 BLUETOOTH HEADSET DONGLE	Power: DC 5V
Note: Mode1:Transmit at 2480MHz by DH5	

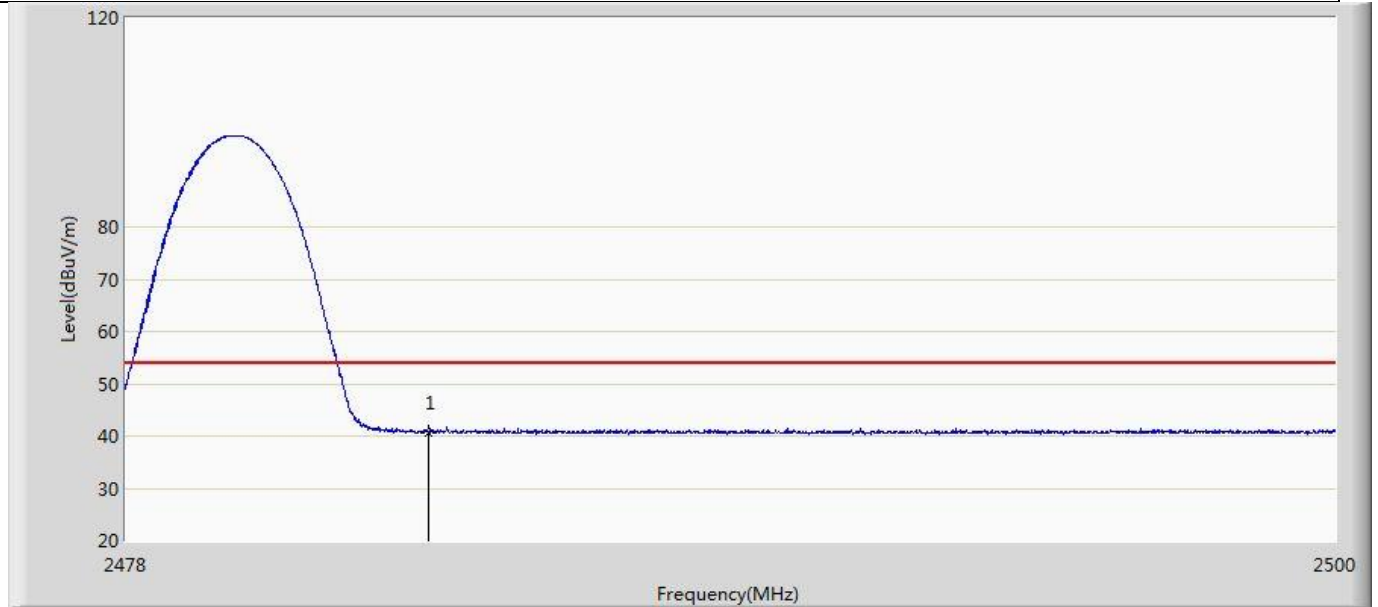

No	Mark	Frequency (MHz)	Measure Level (dBuV/m)	Reading Level (dBuV)	Over Limit (dB)	Limit (dBuV/m)	Factor (dB)	Type
1	*	2483.500	40.680	4.095	-13.320	54.000	36.585	AV

Profile: 22A0151R	Page No.: 7
Engineer: YuLiu	
Site: AC5	Time: 2022/08/15 - 21:58
Limit: FCC_Part15.209_RE(3m)	Margin: 0
Probe: Horn_3117_00167055(1-18GHz)	Polarity: Horizontal
EUT: AH80 BLUETOOTH HEADSET DONGLE	Power: DC 5V
Note: Mode1:Transmit at 2480MHz by DH5	

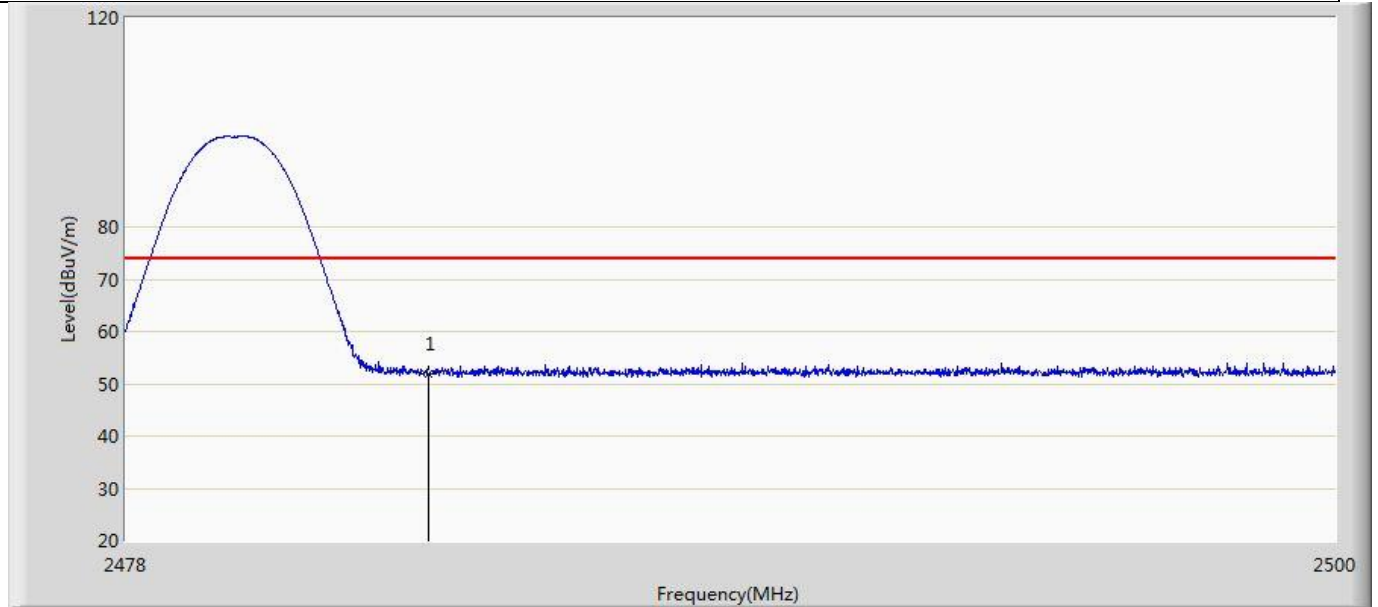

No	Mark	Frequency (MHz)	Measure Level (dBuV/m)	Reading Level (dBuV)	Over Limit (dB)	Limit (dBuV/m)	Factor (dB)	Type
1	*	2483.500	51.938	15.353	-22.062	74.000	36.585	PK

Profile: 22A0151R	Page No.: 8
Engineer: YuLiu	
Site: AC5	Time: 2022/08/15 - 21:59
Limit: FCC_Part15.209_RE(3m)	Margin: 0
Probe: Horn_3117_00167055(1-18GHz)	Polarity: Horizontal
EUT: AH80 BLUETOOTH HEADSET DONGLE	Power: DC 5V
Note: Mode1:Transmit at 2480MHz by DH5	

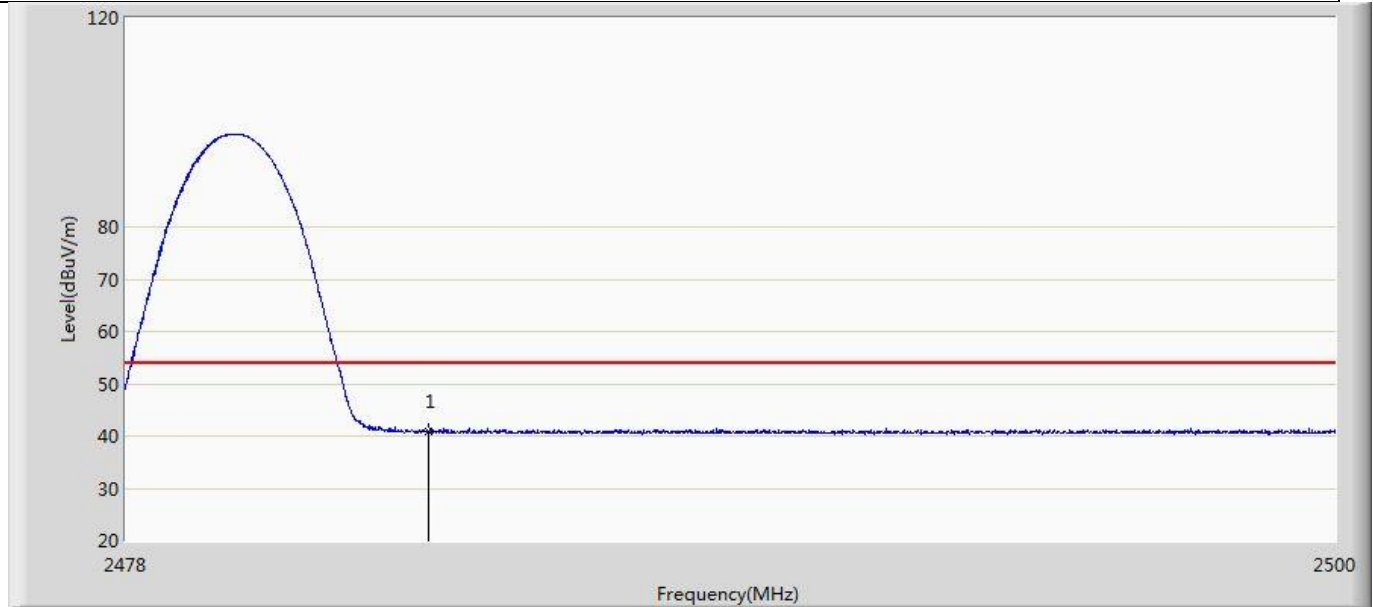

No	Mark	Frequency (MHz)	Measure Level (dBuV/m)	Reading Level (dBuV)	Over Limit (dB)	Limit (dBuV/m)	Factor (dB)	Type
1	*	2483.500	40.930	4.345	-13.070	54.000	36.585	AV

Profile: 22A0151R	Page No.: 9
Engineer: YuLiu	
Site: AC5	Time: 2022/08/15 - 22:01
Limit: FCC_Part15.209_RE(3m)	Margin: 0
Probe: Horn_3117_00167055(1-18GHz)	Polarity: Vertical
EUT: AH80 BLUETOOTH HEADSET DONGLE	Power: DC 5V
Note: Mode1:Transmit at 2402MHz by 2DH5	

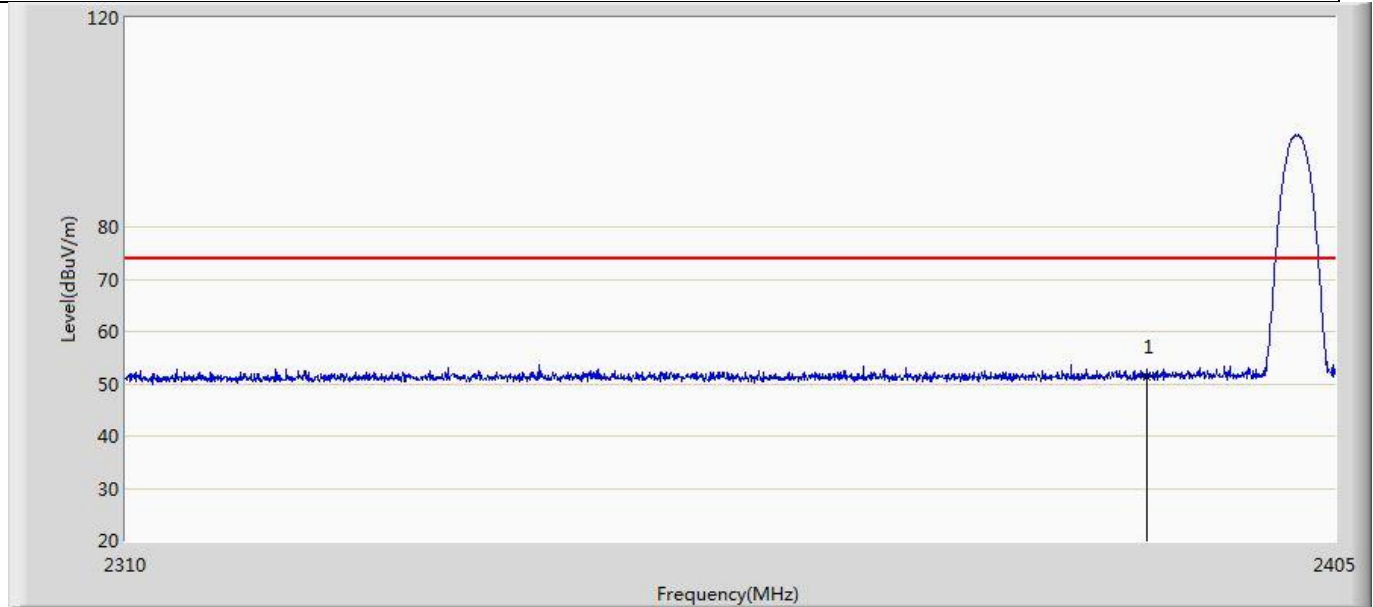

No	Mark	Frequency (MHz)	Measure Level (dBuV/m)	Reading Level (dBuV)	Over Limit (dB)	Limit (dBuV/m)	Factor (dB)	Type
1	*	2390.000	51.436	15.240	-22.564	74.000	36.196	PK

Profile: 22A0151R	Page No.: 10
Engineer: YuLiu	
Site: AC5	Time: 2022/08/15 - 22:02
Limit: FCC_Part15.209_RE(3m)	Margin: 0
Probe: Horn_3117_00167055(1-18GHz)	Polarity: Vertical
EUT: AH80 BLUETOOTH HEADSET DONGLE	Power: DC 5V
Note: Mode2:Transmit at 2402MHz by 2DH5	

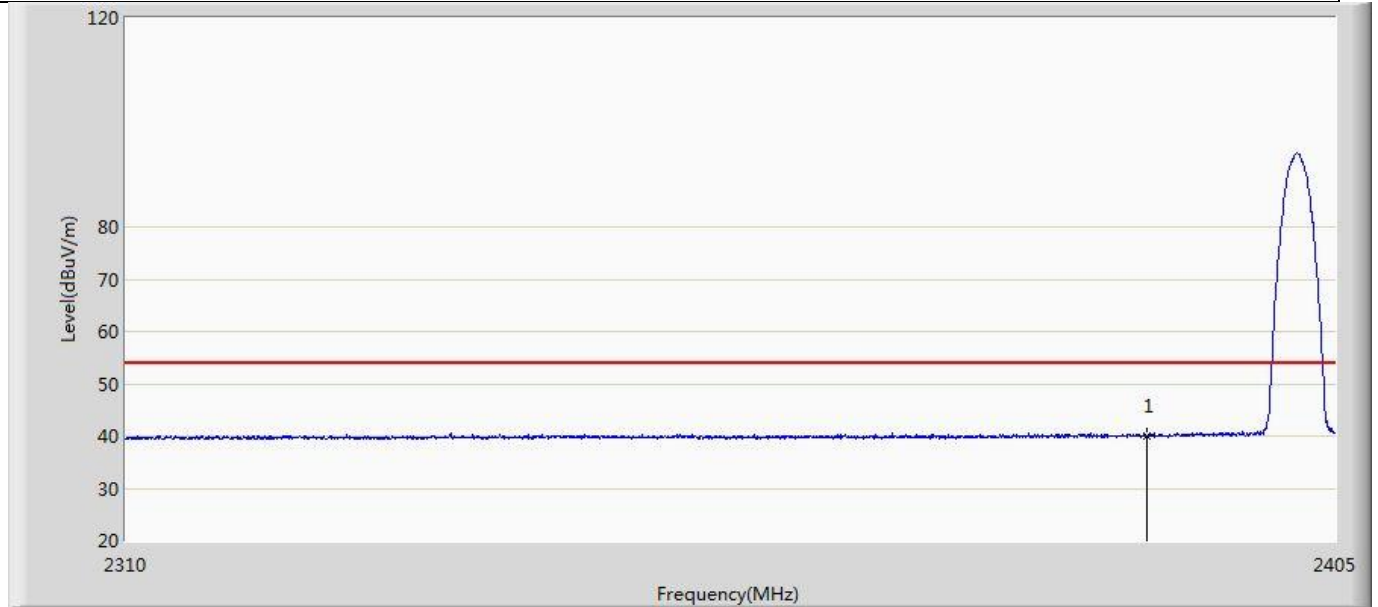

No	Mark	Frequency (MHz)	Measure Level (dBuV/m)	Reading Level (dBuV)	Over Limit (dB)	Limit (dBuV/m)	Factor (dB)	Type
1	*	2390.000	40.067	3.871	-13.933	54.000	36.196	AV

Profile: 22A0151R	Page No.: 11
Engineer: YuLiu	
Site: AC5	Time: 2022/08/15 - 22:04
Limit: FCC_Part15.209_RE(3m)	Margin: 0
Probe: Horn_3117_00167055(1-18GHz)	Polarity: Horizontal
EUT: AH80 BLUETOOTH HEADSET DONGLE	Power: DC 5V
Note: Mode2:Transmit at 2402MHz by 2DH5	

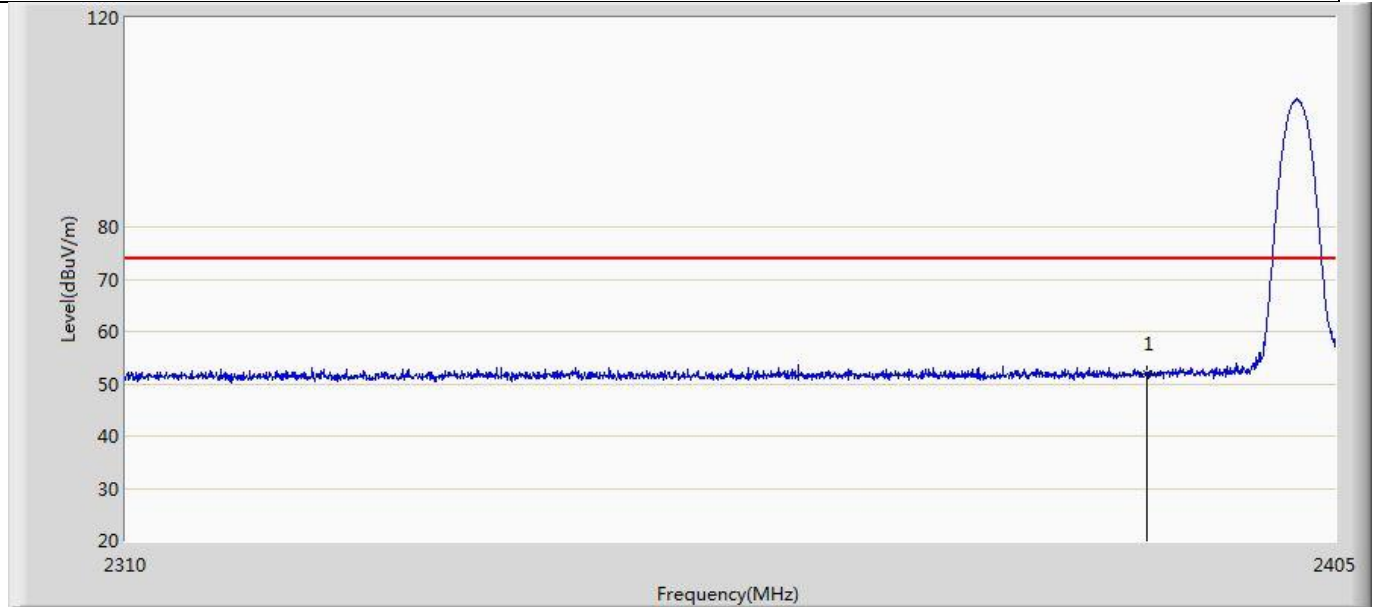

No	Mark	Frequency (MHz)	Measure Level (dBuV/m)	Reading Level (dBuV)	Over Limit (dB)	Limit (dBuV/m)	Factor (dB)	Type
1	*	2390.000	51.838	15.642	-22.162	74.000	36.196	PK

Profile: 22A0151R	Page No.: 12
Engineer: YuLiu	
Site: AC5	Time: 2022/08/15 - 22:05
Limit: FCC_Part15.209_RE(3m)	Margin: 0
Probe: Horn_3117_00167055(1-18GHz)	Polarity: Horizontal
EUT: AH80 BLUETOOTH HEADSET DONGLE	Power: DC 5V
Note: Mode2:Transmit at 2402MHz by 2DH5	

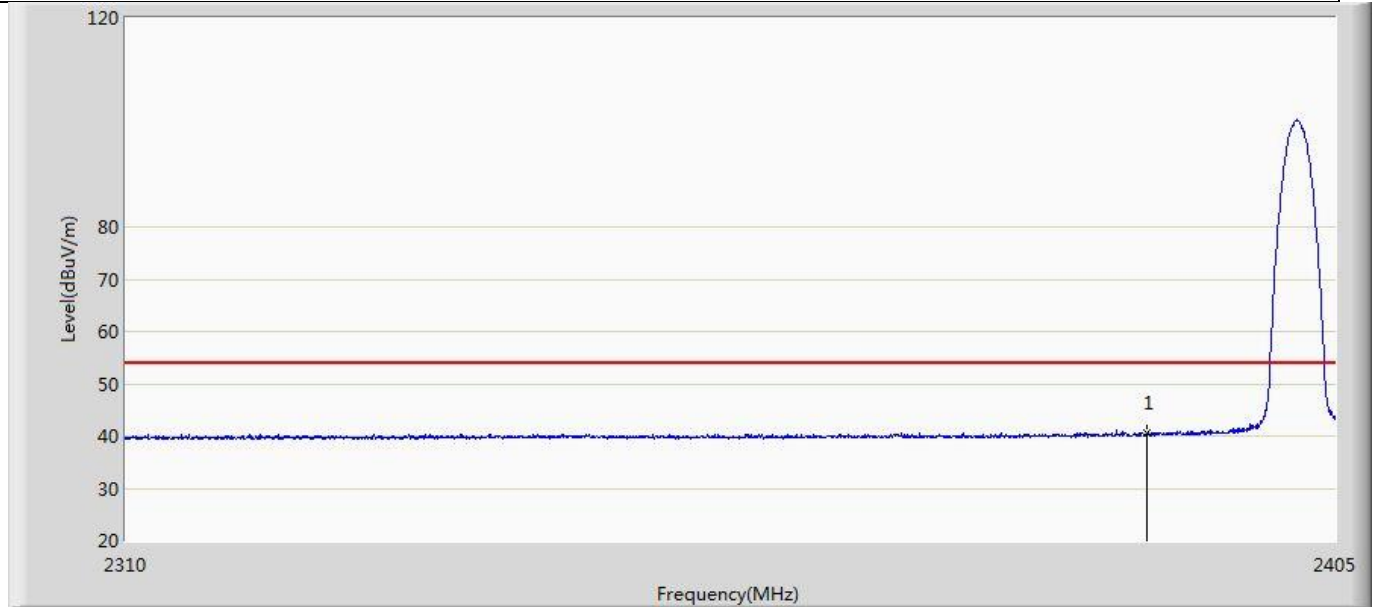

No	Mark	Frequency (MHz)	Measure Level (dBuV/m)	Reading Level (dBuV)	Over Limit (dB)	Limit (dBuV/m)	Factor (dB)	Type
1	*	2390.000	40.454	4.258	-13.546	54.000	36.196	AV

Profile: 22A0151R	Page No.: 13
Engineer: YuLiu	
Site: AC5	Time: 2022/08/15 - 22:07
Limit: FCC_Part15.209_RE(3m)	Margin: 0
Probe: Horn_3117_00167055(1-18GHz)	Polarity: Vertical
EUT: AH80 BLUETOOTH HEADSET DONGLE	Power: DC 5V
Note: Mode2:Transmit at 2480MHz by 2DH5	

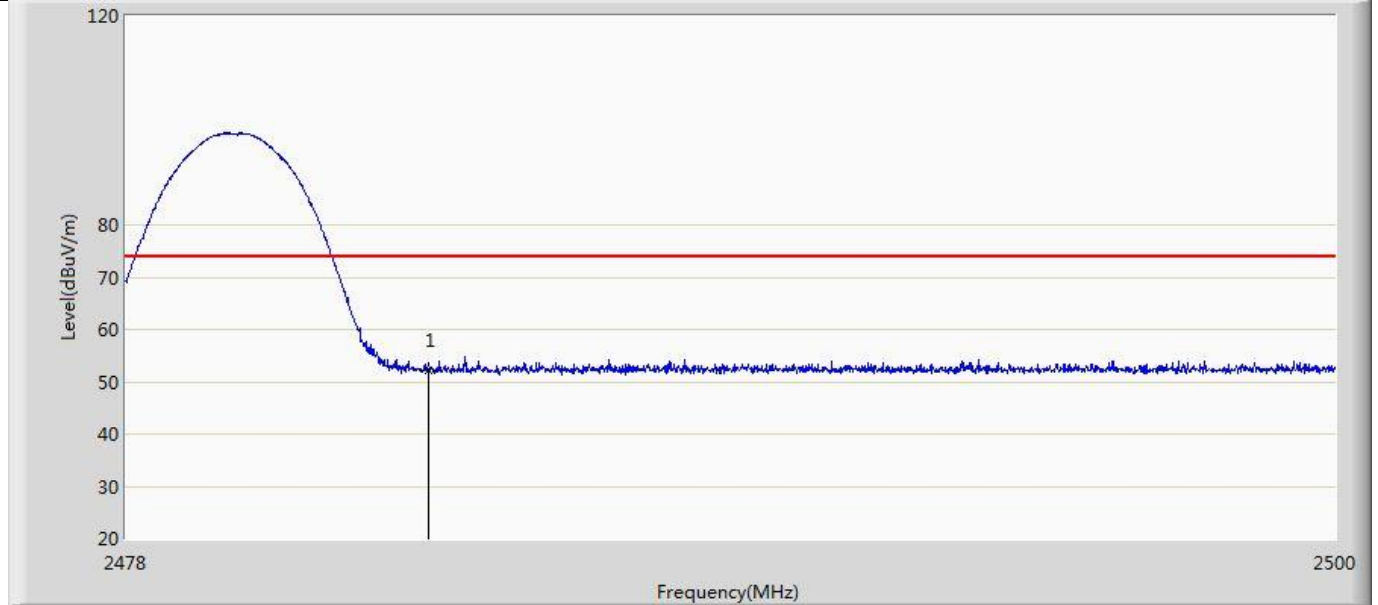

No	Mark	Frequency (MHz)	Measure Level (dBuV/m)	Reading Level (dBuV)	Over Limit (dB)	Limit (dBuV/m)	Factor (dB)	Type
1	*	2483.500	52.176	15.591	-21.824	74.000	36.585	PK

Profile: 22A0151R	Page No.: 14
Engineer: YuLiu	
Site: AC5	Time: 2022/08/15 - 22:08
Limit: FCC_Part15.209_RE(3m)	Margin: 0
Probe: Horn_3117_00167055(1-18GHz)	Polarity: Vertical
EUT: AH80 BLUETOOTH HEADSET DONGLE	Power: DC 5V
Note: Mode2:Transmit at 2480MHz by 2DH5	

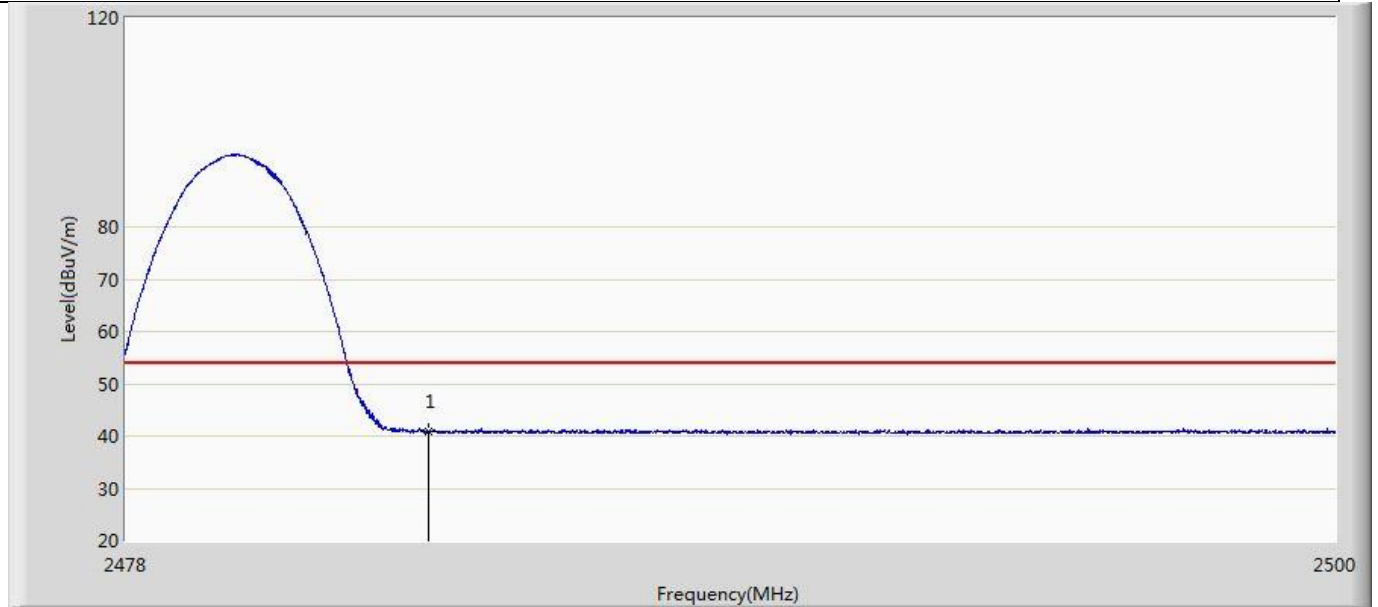

No	Mark	Frequency (MHz)	Measure Level (dBuV/m)	Reading Level (dBuV)	Over Limit (dB)	Limit (dBuV/m)	Factor (dB)	Type
1	*	2483.500	40.970	4.385	-13.030	54.000	36.585	AV

Profile: 22A0151R	Page No.: 15
Engineer: YuLiu	
Site: AC5	Time: 2022/08/15 - 22:10
Limit: FCC_Part15.209_RE(3m)	Margin: 0
Probe: Horn_3117_00167055(1-18GHz)	Polarity: Horizontal
EUT: AH80 BLUETOOTH HEADSET DONGLE	Power: DC 5V
Note: Mode2:Transmit at 2480MHz by 2DH5	

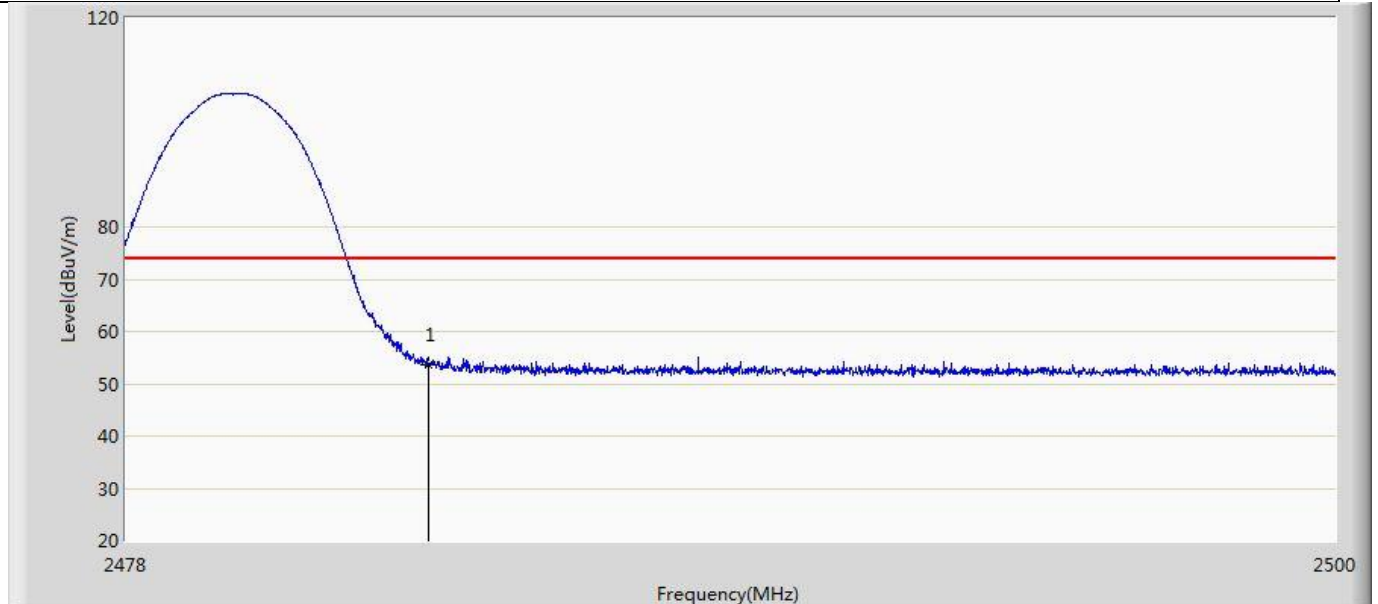

No	Mark	Frequency (MHz)	Measure Level (dBuV/m)	Reading Level (dBuV)	Over Limit (dB)	Limit (dBuV/m)	Factor (dB)	Type
1	*	2483.500	53.501	16.916	-20.499	74.000	36.585	PK

Profile: 22A0151R	Page No.: 16
Engineer: YuLiu	
Site: AC5	Time: 2022/08/15 - 22:11
Limit: FCC_Part15.209_RE(3m)	Margin: 0
Probe: Horn_3117_00167055(1-18GHz)	Polarity: Horizontal
EUT: AH80 BLUETOOTH HEADSET DONGLE	Power: DC 5V
Note: Mode2:Transmit at 2480MHz by 2DH5	

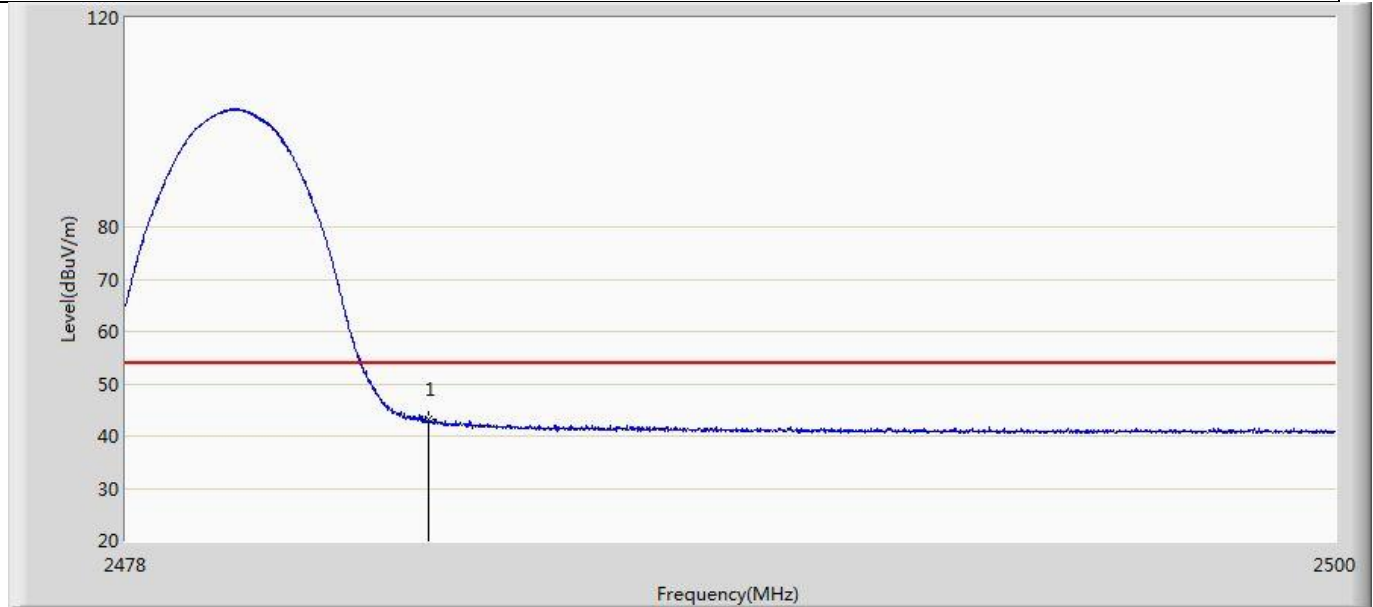

No	Mark	Frequency (MHz)	Measure Level (dBuV/m)	Reading Level (dBuV)	Over Limit (dB)	Limit (dBuV/m)	Factor (dB)	Type
1	*	2483.500	43.099	6.514	-10.901	54.000	36.585	AV

Profile: 22A0151R	Page No.: 17
Engineer: YuLiu	
Site: AC5	Time: 2022/08/15 - 22:15
Limit: FCC_Part15.209_RE(3m)	Margin: 0
Probe: Horn_3117_00167055(1-18GHz)	Polarity: Vertical
EUT: AH80 BLUETOOTH HEADSET DONGLE	Power: DC 5V
Note: Mode3:Transmit at 2402MHz by 3DH5	

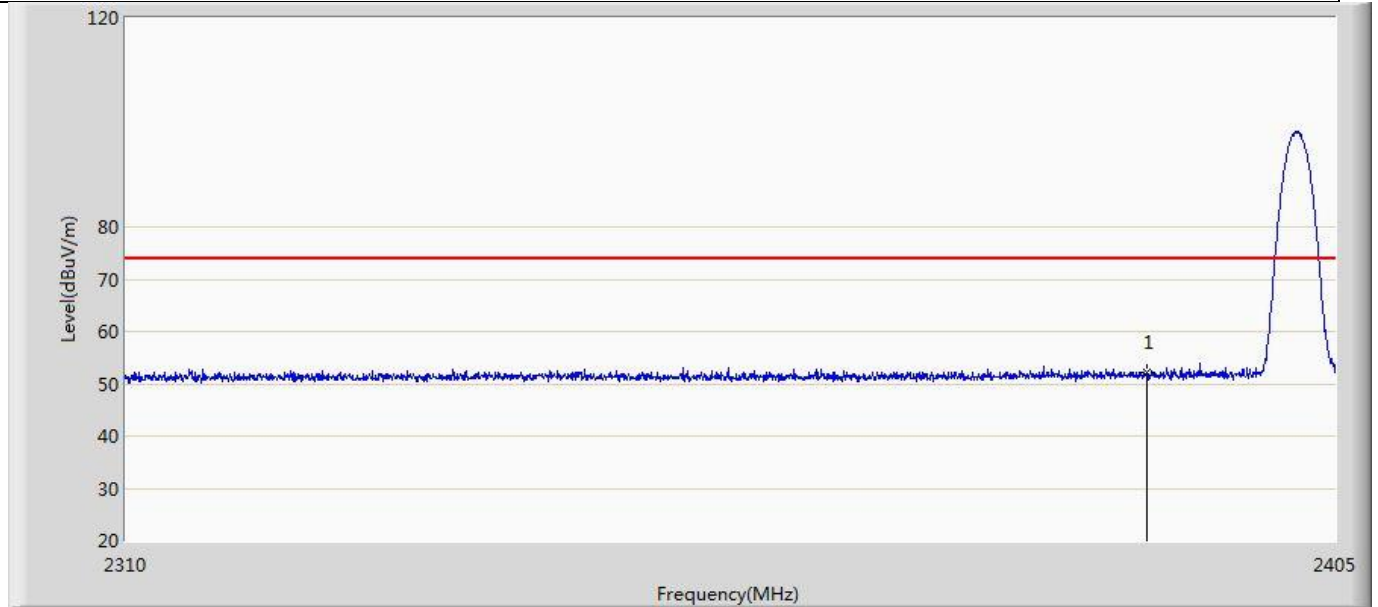

No	Mark	Frequency (MHz)	Measure Level (dBuV/m)	Reading Level (dBuV)	Over Limit (dB)	Limit (dBuV/m)	Factor (dB)	Type
1	*	2390.000	52.180	15.984	-21.820	74.000	36.196	PK

Profile: 22A0151R	Page No.: 18
Engineer: YuLiu	
Site: AC5	Time: 2022/08/15 - 22:17
Limit: FCC_Part15.209_RE(3m)	Margin: 0
Probe: Horn_3117_00167055(1-18GHz)	Polarity: Vertical
EUT: AH80 BLUETOOTH HEADSET DONGLE	Power: DC 5V
Note: Mode3:Transmit at 2402MHz by 3DH5	

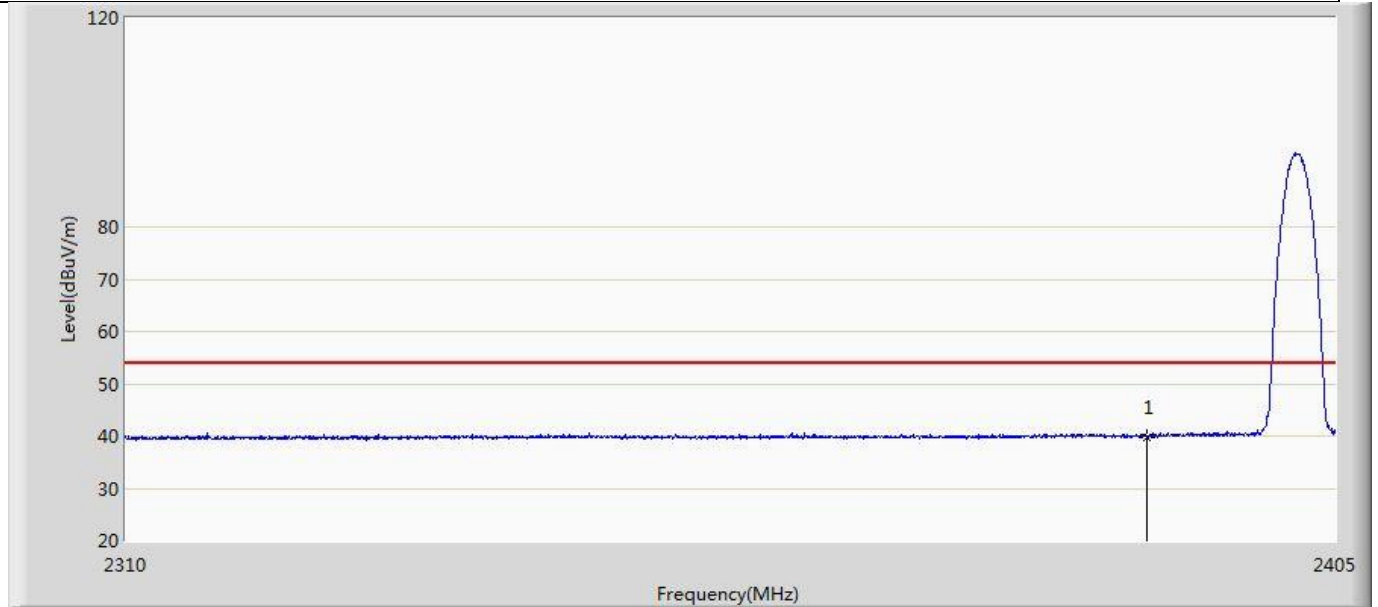

No	Mark	Frequency (MHz)	Measure Level (dBuV/m)	Reading Level (dBuV)	Over Limit (dB)	Limit (dBuV/m)	Factor (dB)	Type
1	*	2390.000	39.843	3.647	-14.157	54.000	36.196	AV

Profile: 22A0151R	Page No.: 19
Engineer: YuLiu	
Site: AC5	Time: 2022/08/15 - 22:17
Limit: FCC_Part15.209_RE(3m)	Margin: 0
Probe: Horn_3117_00167055(1-18GHz)	Polarity: Horizontal
EUT: AH80 BLUETOOTH HEADSET DONGLE	Power: DC 5V
Note: Mode3:Transmit at 2402MHz by 3DH5	

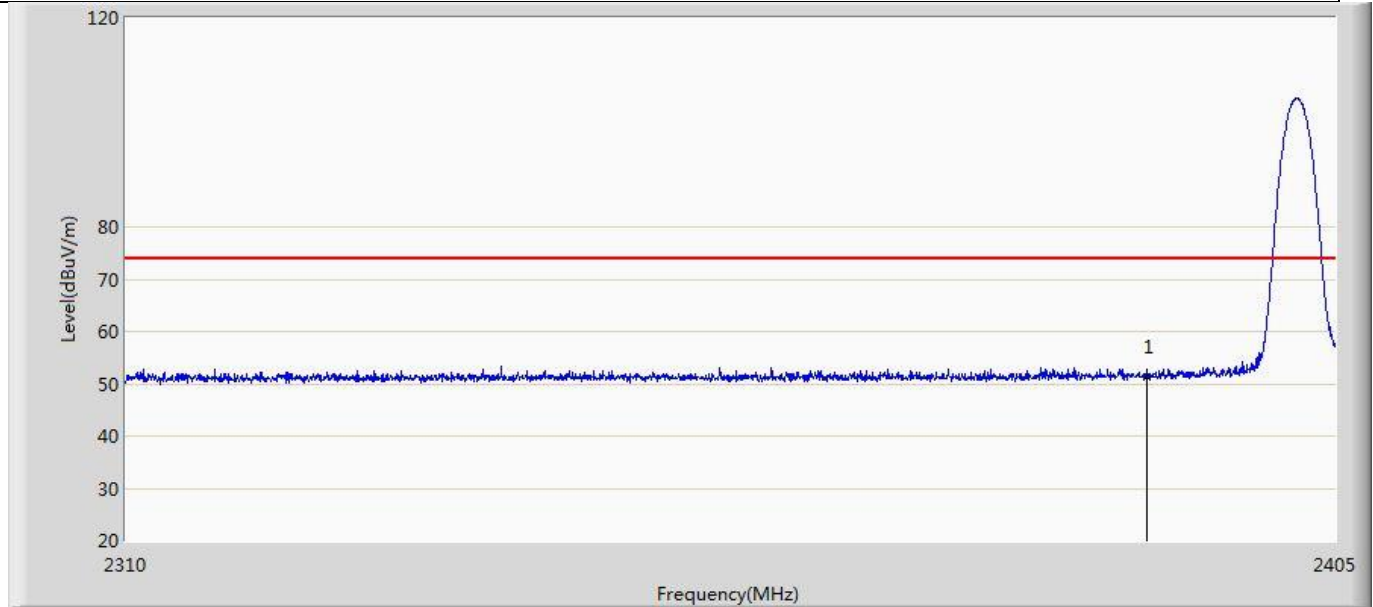

No	Mark	Frequency (MHz)	Measure Level (dBuV/m)	Reading Level (dBuV)	Over Limit (dB)	Limit (dBuV/m)	Factor (dB)	Type
1	*	2390.000	51.194	14.998	-22.806	74.000	36.196	PK

Profile: 22A0151R	Page No.: 20
Engineer: YuLiu	
Site: AC5	Time: 2022/08/15 - 22:19
Limit: FCC_Part15.209_RE(3m)	Margin: 0
Probe: Horn_3117_00167055(1-18GHz)	Polarity: Horizontal
EUT: AH80 BLUETOOTH HEADSET DONGLE	Power: DC 5V
Note: Mode3:Transmit at 2402MHz by 3DH5	

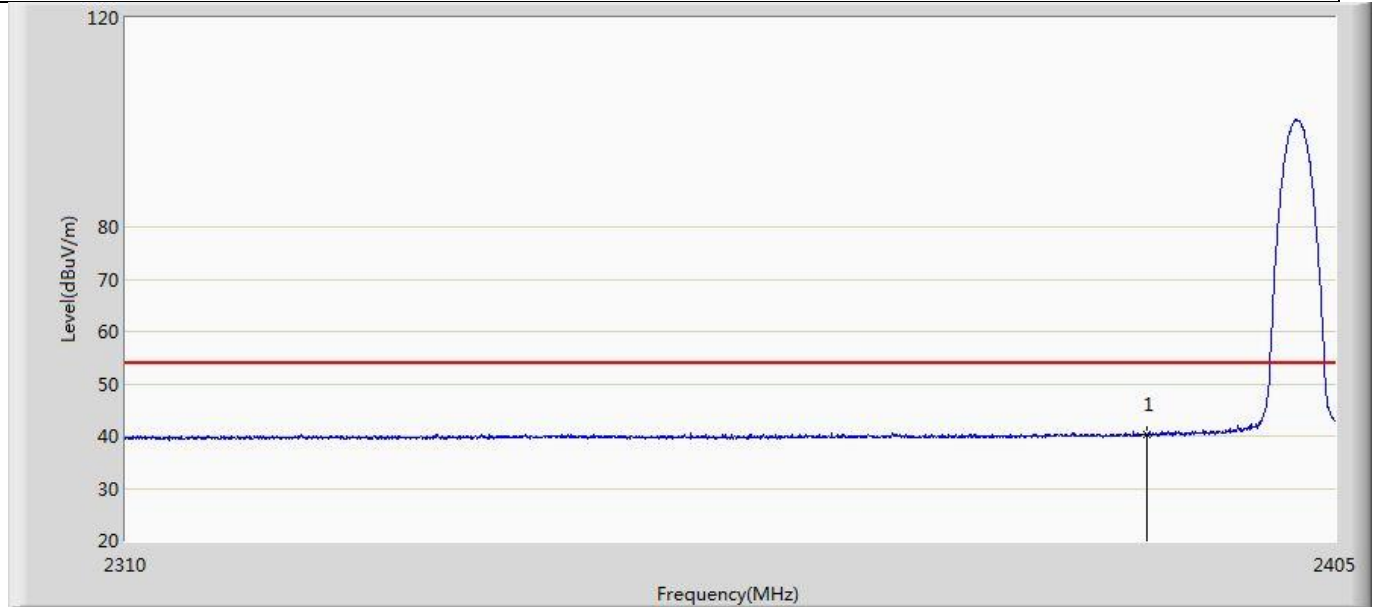

No	Mark	Frequency (MHz)	Measure Level (dBuV/m)	Reading Level (dBuV)	Over Limit (dB)	Limit (dBuV/m)	Factor (dB)	Type
1	*	2390.000	40.228	4.032	-13.772	54.000	36.196	AV

Profile: 22A0151R	Page No.: 21
Engineer: YuLiu	
Site: AC5	Time: 2022/08/15 - 22:20
Limit: FCC_Part15.209_RE(3m)	Margin: 0
Probe: Horn_3117_00167055(1-18GHz)	Polarity: Vertical
EUT: AH80 BLUETOOTH HEADSET DONGLE	Power: DC 5V
Note: Mode3:Transmit at 2480MHz by 3DH5	

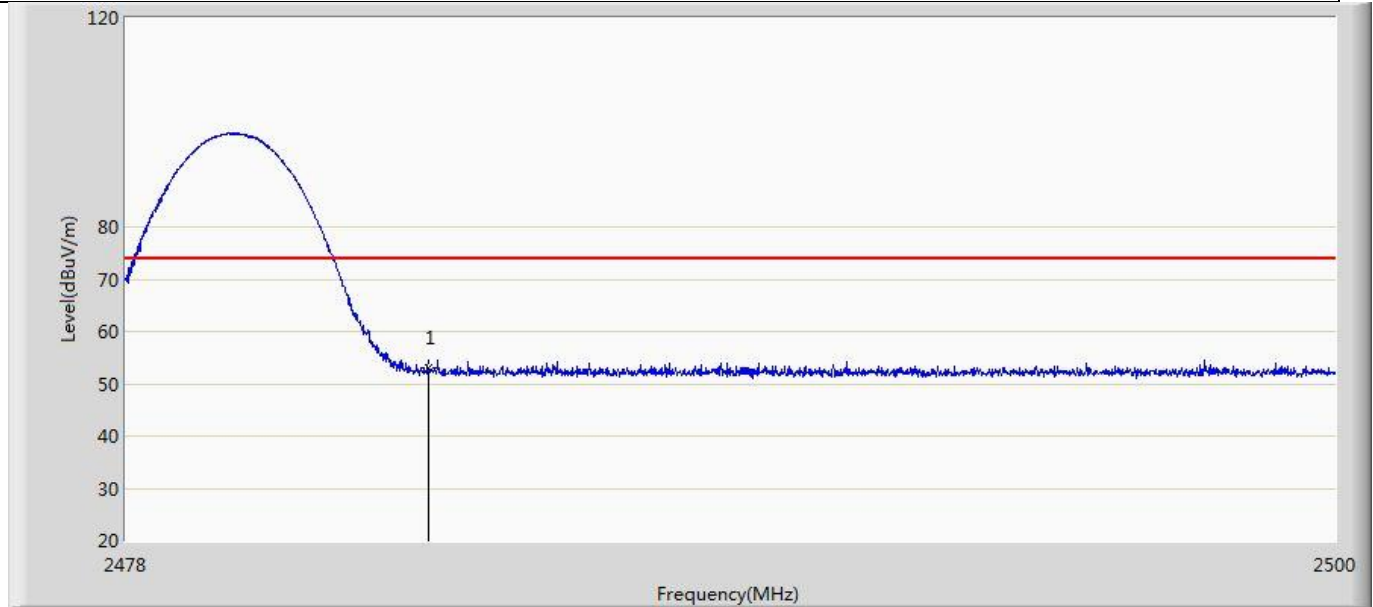

No	Mark	Frequency (MHz)	Measure Level (dBuV/m)	Reading Level (dBuV)	Over Limit (dB)	Limit (dBuV/m)	Factor (dB)	Type
1	*	2483.500	53.146	16.561	-20.854	74.000	36.585	PK

Profile: 22A0151R	Page No.: 22
Engineer: YuLiu	
Site: AC5	Time: 2022/08/15 - 22:23
Limit: FCC_Part15.209_RE(3m)	Margin: 0
Probe: Horn_3117_00167055(1-18GHz)	Polarity: Vertical
EUT: AH80 BLUETOOTH HEADSET DONGLE	Power: DC 5V
Note: Mode3:Transmit at 2480MHz by 3DH5	

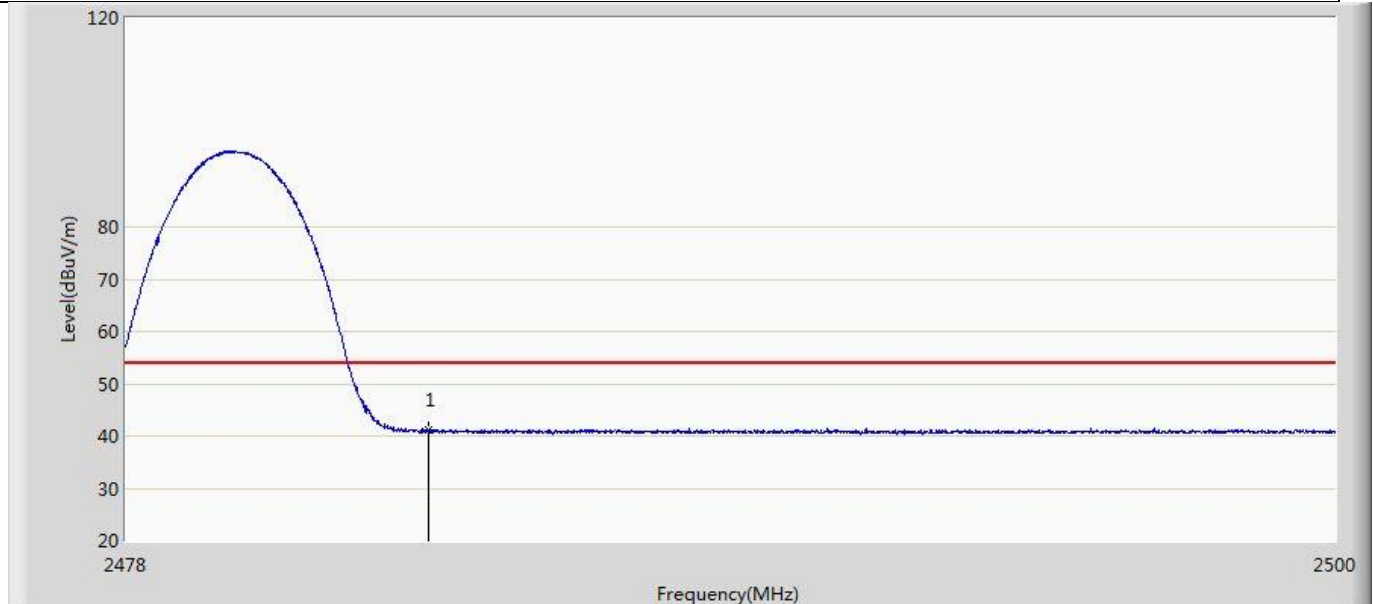

No	Mark	Frequency (MHz)	Measure Level (dBuV/m)	Reading Level (dBuV)	Over Limit (dB)	Limit (dBuV/m)	Factor (dB)	Type
1	*	2483.500	41.066	4.481	-12.934	54.000	36.585	AV

Profile: 22A0151R	Page No.: 23
Engineer: YuLiu	
Site: AC5	Time: 2022/08/15 - 22:25
Limit: FCC_Part15.209_RE(3m)	Margin: 0
Probe: Horn_3117_00167055(1-18GHz)	Polarity: Horizontal
EUT: AH80 BLUETOOTH HEADSET DONGLE	Power: DC 5V
Note: Mode3:Transmit at 2480MHz by 3DH5	

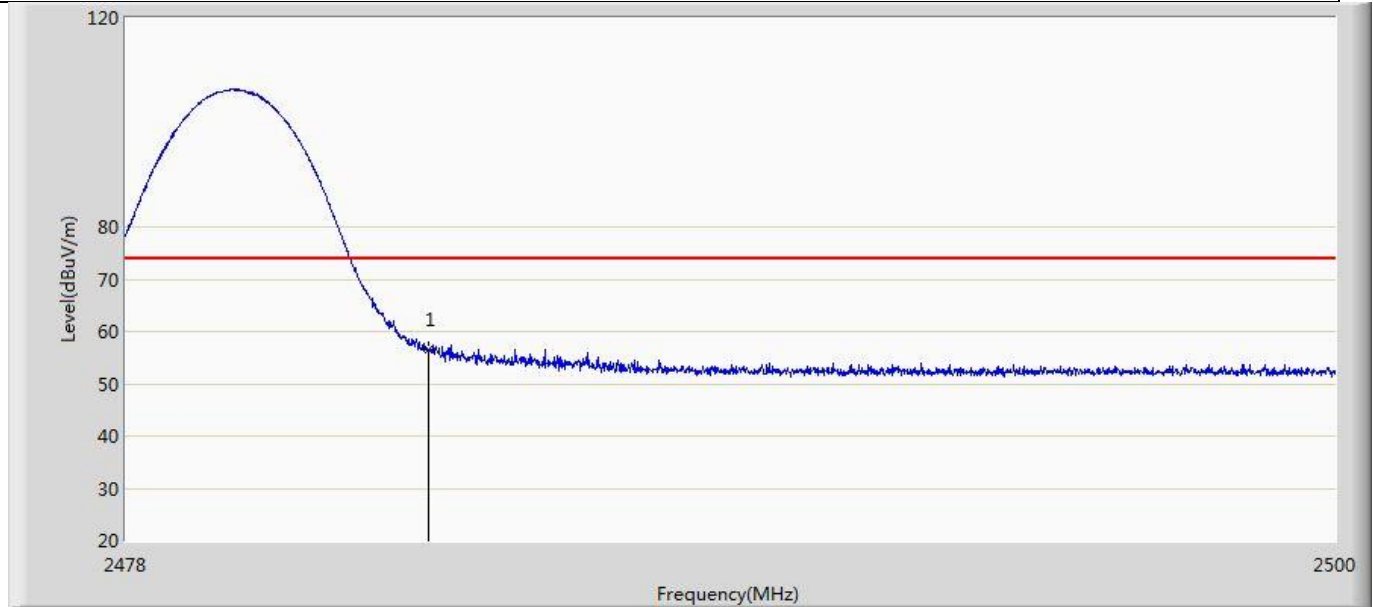

No	Mark	Frequency (MHz)	Measure Level (dBuV/m)	Reading Level (dBuV)	Over Limit (dB)	Limit (dBuV/m)	Factor (dB)	Type
1	*	2483.500	56.395	19.810	-17.605	74.000	36.585	PK

Profile: 22A0151R	Page No.: 24
Engineer: YuLiu	
Site: AC5	Time: 2022/08/15 - 22:26
Limit: FCC_Part15.209_RE(3m)	Margin: 0
Probe: Horn_3117_00167055(1-18GHz)	Polarity: Horizontal
EUT: AH80 BLUETOOTH HEADSET DONGLE	Power: DC 5V
Note: Mode3:Transmit at 2480MHz by 3DH5	

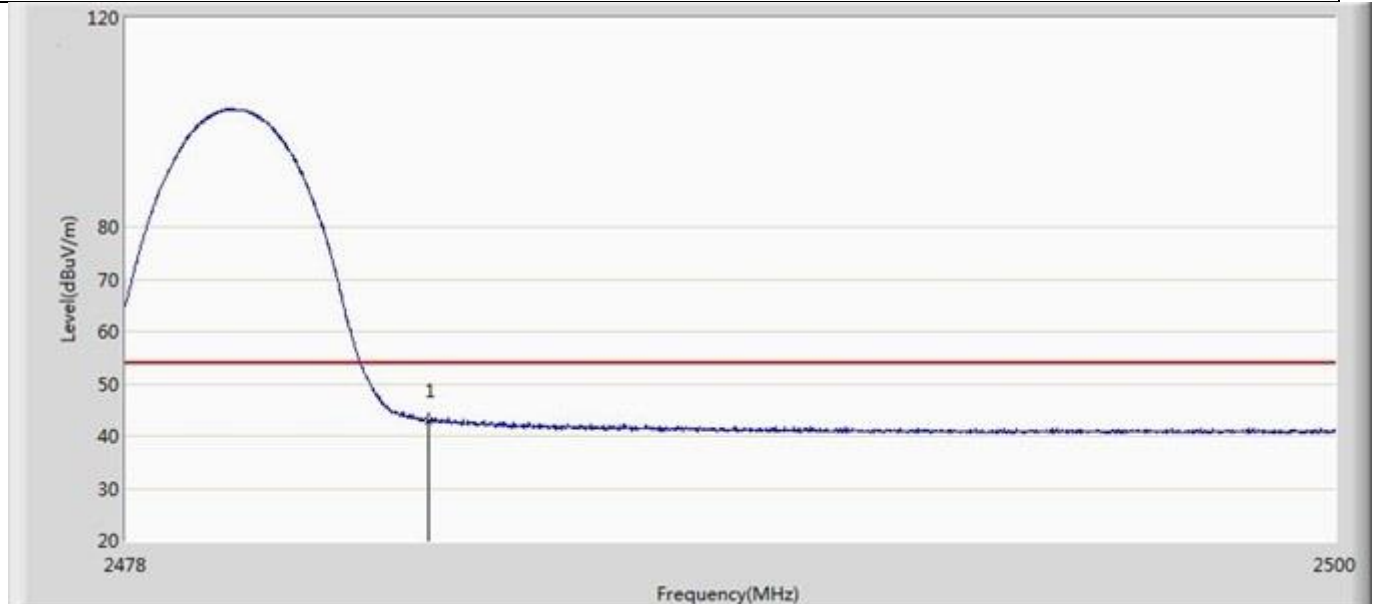

No	Mark	Frequency (MHz)	Measure Level (dBuV/m)	Reading Level (dBuV)	Over Limit (dB)	Limit (dBuV/m)	Factor (dB)	Type
1	*	2483.500	43.006	6.421	-10.994	54.000	36.585	AV

4.11 Antenna Requirement	VERDICT: PASS
---------------------------------	----------------------

4.11.1 Limit:	
Standard	FCC Part 15 Subpart C Paragraph 15.203
<p>An intentional radiator shall be designed to ensure that no antenna other than that furnished by the responsible party shall be used with the device. The use of a permanently attached antenna or of an antenna that uses a unique coupling to the intentional radiator shall be considered sufficient to comply with the provisions of this section. The manufacturer may design the unit so that a broken antenna can be replaced by the user, but the use of a standard antenna jack or electrical connector is prohibited. This requirement does not apply to carrier current devices or to devices operated under the provisions of §15.211, §15.213, §15.217, §15.219, or §15.221. Further, this requirement does not apply to intentional radiators that must be professionally installed, such as perimeter protection systems and some field disturbance sensors, or to other intentional radiators which, in accordance with §15.31(d), must be measured at the installation site. However, the installer shall be responsible for ensuring that the proper antenna is employed so that the limits in this part are not exceeded.</p>	

4.11.2 Antenna Connector Construction:	
<input checked="" type="checkbox"/>	The use of a permanently attached antenna
<input type="checkbox"/>	The antenna use of a unique coupling to the intentional radiator
<input type="checkbox"/>	The use of a nonstandard antenna jack or electrical connector
Please refer to the attached document "Internal Photograph" to show the antenna connector.	

5 TEST SETUP PHOTO AND EUT PHOTO

Remark: The test setup photo and EUT Photo please see appendix.

_____ The End _____