



Test report No:
22A0151R-RF-US-P06V02

FCC TEST REPORT

Product Name	AH80 Bluetooth Headset Dongle
Trademark	Alcatel-Lucent Enterprise
Model and /or type reference	AH80
FCC ID	OL3AH80DONGLE
Applicant's name / address	ALE International 32, Avenue Kléber – 92700 Colombes – FRANCE
Test method requested, standard	FCC CFR Title 47 Part 15 Subpart C Section 15.247 ANSI C63.10: 2013 KDB558074 D01 15.247 Meas Guidance v05r02
Verdict Summary	IN COMPLIANCE
Tested by (name / position & signature)	Jun Xu/ Project Engineer 
Approved by (name / position & signature)	Jack Zhang/Manager 
Date of issue	2022-10-26
Report Version	V1.0
Report template No	Template_FCC 15.247-RF-V1.0

INDEX

	page
General conditions	4
Environmental conditions	4
Possible test case verdicts	5
Abbreviations.....	5
Document History.....	6
Remarks and Comments	6
Used Equipment.....	7
Uncertainty	9
1 General Information	10
1.1 General Description of the Item(s).....	10
1.2 Antenna Information	11
1.3 Channel List.....	12
2 Description of Test Setup.....	13
2.1 Operating mode(s) used for tests	13
2.2 Auxiliary equipment / Test software for the EUT	13
2.3 Test Configuration / Block diagram used for tests.....	14
2.4 Testing process	15
3 Verdict summary section.....	16
3.1 Standards	16
3.2 Deviation(s) from the Standard(s) / Test Specification(s).....	16
3.3 Overview of results	17
3.4 Test Facility.....	18
4 Test Results	19
4.1 AC Power Line Conducted Emission.....	19
4.1.1 Limit	19
4.1.2 Test Setup	19
4.1.3 Test Procedure	19
4.1.4 Test Data	20
4.2 Emissions in restricted frequency bands	21
4.2.1 Limit	21
4.2.2 Test Setup	23
4.2.3 Test Procedure	24
4.2.4 Test Data	25
4.3 Emissions in non-restricted frequency band	39

4.3.1	Limit	39
4.3.2	Test Setup	39
4.3.3	Test Procedure	39
4.3.4	Test Data	40
4.4	Duty cycle	42
4.4.1	Limit	42
4.4.2	Test Setup	42
4.4.3	Test Procedure	42
4.4.4	Test Data	43
4.5	Band Edge	44
4.5.1	Limit	44
4.5.2	Test Setup	44
4.5.3	Test Procedure	44
4.5.4	Test Data	45
4.6	DTS Bandwidth	61
4.6.1	Limit	61
4.6.2	Test Setup	61
4.6.3	Test Procedure	61
4.6.4	Test Data	62
4.7	Fundamental emission output power	63
4.7.1	Limit	63
4.7.2	Test Setup	63
4.7.3	Test Procedure	64
4.7.4	Test Data	65
4.8	Power Density	66
4.8.1	Limit:	66
4.8.2	Test Setup	66
4.8.3	Test Procedure	66
4.8.4	Test Data	67
4.9	Antenna Requirement	68
4.9.1	Limit:	68
4.9.2	Antenna Connector Construction:	68
5	Test setup photo and EUT Photo	69

COMPETENCES AND GUARANTEES

DEKRA is a testing laboratory competent to carry out the tests described in this report.

In order to assure the traceability to other national and international laboratories, DEKRA has a calibration and maintenance program for its measurement equipment.

DEKRA guarantees the reliability of the data presented in this report, which is the result of the measurements and the tests performed to the item under test on the date and under the conditions stated in the report and it is based on the knowledge and technical facilities available at DEKRA at the time of performance of the test.

DEKRA is liable to the client for the maintenance of the confidentiality of all information related to the item under test and the results of the test.

The results presented in this Test Report apply only to the particular item under test established in this document.

IMPORTANT: No parts of this report may be reproduced or quoted out of context, in any form or by any means, except in full, without the previous written permission of DEKRA.

GENERAL CONDITIONS

Test Location	No. 99, Hongye Road, Suzhou Industrial Park Suzhou, 215006, P.R. China
Date(receive sample)	Jun. 22, 2022
Date (start test)	Jul. 29, 2022
Date (finish test)	Aug. 22, 2022

1. This report is only referred to the item that has undergone the test.
2. This report does not constitute or imply on its own an approval of the product by the Certification Bodies or Competent Authorities.
3. This document is only valid if complete; no partial reproduction can be made without previous written permission of DEKRA.
4. This test report cannot be used partially or in full for publicity and/or promotional purposes without previous written permission of DEKRA.

ENVIRONMENTAL CONDITIONS

The climatic conditions during the tests are within the limits specified by the manufacturer for the operation of the EUT and the test equipment. The climatic conditions during the tests were within the following limits:

Ambient temperature	15 °C – 35 °C
Relative Humidity air	30% - 60%

If explicitly required in the basic standard or applied product / product family standard the climatic values are recorded and documented separately in this test report.

POSSIBLE TEST CASE VERDICTS

Test case does not apply to test object	N/A
Test object does meet requirement	P (Pass) / PASS
Test object does not meet requirement	F (Fail) / FAIL
Not measured	N/M

ABBREVIATIONS

For the purposes of the present document, the following abbreviations apply:

EUT	: Equipment Under Test
QP	: Quasi-Peak
CAV	: CISPR Average
AV	: Average
CDN	: Coupling Decoupling Network
SAC	: Semi-Anechoic Chamber
OATS	: Open Area Test Site
BW	: Bandwidth
AM	: Amplitude Modulation
PM	: Pulse Modulation
HCP	: Horizontal Coupling Plane
VCP	: Vertical Coupling Plane
U_N	: Nominal voltage
T_x	: Transmitter
R_x	: Receiver
N/A	: Not Applicable
N/M	: Not Measured

DOCUMENT HISTORY

Report No.	Version	Description	Issued Date
22A0151R-RF-US-P06V02	V1.0	Initial issue of report.	2022-10-26

REMARKS AND COMMENTS

1. The equipment under test (EUT) does meet the essential requirements of the stated standard(s)/test(s).
2. These test results on a sample of the device are for the purpose of demonstrating Compliance with Part 15 Subpart C Paragraph 15.247.
3. The measurement result is considered in conformance with the requirement if it is within the prescribed limit, It is not necessary to account the uncertainty associated with the measurement result.
4. The test results presented in this report relate only to the object tested.
5. The test report shall not be reproduced without the written approval of DEKRA Testing and Certification (Suzhou) Co., Ltd.
6. This report will not be used for social proof function in China market.
7. DEKRA declines any responsibility with the following test data provided by customer that may affect the validity of result:
 - Chapter 1.1 General Description of the Item(s);
 - Chapter 1.2 Antenna Information;
 - Chapter 1.3 Channel List.

USED EQUIPMENT

AC Power Line Conducted Emission / TR1

Instrument	Manufacturer	Model No.	Serial No.	Cal. Date	Next Cal. Date
EMI Test Receiver	R&S	ESCI	101668	2021.10.30	2022.10.29
Two-Line V-Network	R&S	ENV216	101044	2022.07.01	2023.06.30
Two-Line V-Network	R&S	ENV 216	101189	2022.03.12	2023.03.11
50ohm Coaxial Switch	Anritsu	MP59B	6200464462	N/A	N/A
Temperature/Humidity Meter	RTS	RTS-8S	TR1-TH	2022.07.07	2023.07.06
Dekra test software	Dekra	-	-	-	-

Emissions in non-restricted frequency bands/ Occupied Bandwidth/ Fundamental emission output power/ Power Spectral Density/Band Edge/ TR8

Instrument	Manufacturer	Model No.	Serial No.	Cal. Date	Next Cal. Date
Spectrum Analyzer	Agilent	N9010A	MY48030494	2021.12.15	2022.12.14
MXA Signal Analyzer	Keysight	N9020A	MY56060147	2022.07.14	2023.07.13
4TX MIMO Power Sensor	Keysight	X8750A	MY59400102	2022.03.16	2023.03.15
Coaxial Cable	N/A	N/A	No.2007	2022.06.07	2023.06.06
Temperature/Humidity Meter	RTS	RTS-8S	RF08	2022.07.07	2023.07.06

Radiated Emission(30MHz-1GHz) / AC2

Instrument	Manufacturer	Model No.	Serial No.	Cal. Date	Next Cal. Date
EMI Test Receiver	R&S	ESCI	100573	2021.10.30	2022.10.29
Loop Antenna	R&S	HFH2-Z2	833799/003	2022.04.15	2023.04.14
Bilog Antenna	Teseq GmbH	CBL6112D	27613	2022.08.28	2023.08.27
Coaxial Cable	Huber+Suhner	RG 214	AC3-C	2022.03.30	2023.03.29
Temperature/Humidity Meter	RTS	RTS-8S	AC3-TH	2021.11.23	2022.11.22
Dekra test software	Dekra	-	-	-	-

Radiated Emission(1GHz-40GHz) / AC5

Instrument	Manufacturer	Model No.	Serial No.	Cal. Date	Next Cal. Date
EXA Spectrum Analyzer	Keysight	N9020B	MY59050482	2021.11.18	2022.11.17
Preamplifier	EMCI	EMC184045SE	980263	2022.05.21	2023.05.20
DRG Horn Antenna	ETS-Lindgren	3117	00167055	2022.08.29	2023.08.28
Broad-Band Horn Antenna	Schwarzbeck	BBHA9170	294	2022.05.19	2023.05.18
Coaxial Cable	Huber+Suhner	SUCOFLEX 106	AC5-C2	2022.03.30	2023.03.29
Coaxial Cable	ROSENBERGER	LA1-C011- 2000/3000	AC5-40G	2022.03.21	2023.03.20
High-Pass Filter	Wainwright	WHKX3.0/18G- 12SS	AC5/AC6	2022.06.07	2023.06.06
Temperature/Humidity Meter	RTS	RTS-8S	AC5-TH	2022.07.07	2023.07.06
Dekra test software	Dekra	-	-	-	-

UNCERTAINTY

Uncertainties have been calculated according to the DEKRA internal document. The reported expanded uncertainties are based on a standard uncertainty multiplied by a coverage factor of $k=2$, providing a level of confidence of approximately 95%. The Uncertainties is complice with standard required as below.

Test item	Uncertainty
AC Power Line Conducted Emission	9kHz~150kHz: 2.80dB 150kHz~30MHz: 2.40dB
Peak Power Output	± 1.27 dB
Radiated Emission(30MHz~1GHz)	Horizontal: 30MHz~200MHz: 3.50 dB 300MHz~1GHz: 3.60 dB Vertical: 30MHz~200MHz: 3.60 dB 300MHz~1GHz: 3.50 dB
Radiated Emission(1GHz~26.5GHz)	Horizontal: 1GHz~18GHz: 5.00 dB Vertical: 1GHz~18GHz: 4.80 dB
RF antenna conducted test	± 1.27 dB
Radiated Emission Band Edge	± 3.9 dB
DTS Bandwidth	± 150 Hz
Occupied Bandwidth	± 1 kHz
Power Density	± 1.27 dB

1 GENERAL INFORMATION

1.1 General Description of the Item(s)

Product Name	AH80 Bluetooth Headset Dongle
Model No.	AH80
FCC ID	OL3AH80DONGLE
Manufacturer	ALE International
Manufacturer Address.....	32, Avenue Kléber – 92700 Colombes – FRANCE

Wireless specification.....	Bluetooth 5.0					
Operating frequency range(s)	2400~2483.5MHz					
Type of Modulation.....	GFSK					
PHYs	<input checked="" type="checkbox"/>	LE 1M	<input checked="" type="checkbox"/>	LE 2M	<input type="checkbox"/>	LE Coded S=2/8
Data Rate	<input checked="" type="checkbox"/>	1Mbit/s	<input checked="" type="checkbox"/>	2Mbit/s	<input type="checkbox"/>	500/125 Kbit/s
Number of channel.....	40					

Rated power supply	Voltage and Frequency					
	<input type="checkbox"/>	AC: 220 – 240 V, 50/60 Hz				
	<input type="checkbox"/>	AC: 110 – 130 Vac, 50/60 Hz				
	<input type="checkbox"/>	48 Volt via POE				
	<input checked="" type="checkbox"/>	DC:5V				
Mounting position	<input type="checkbox"/>	Table top equipment				
	<input type="checkbox"/>	Wall/Ceiling mounted equipment				
	<input type="checkbox"/>	Floor standing equipment				
	<input type="checkbox"/>	Head-mounted equipment				
	<input checked="" type="checkbox"/>	Other: Bluetooth Headset Dongle				

1.2 Antenna Information

Antenna model / type number	N/A		
Antenna serial number	N/A		
Antenna Delivery	<input checked="" type="checkbox"/>	1TX + 1RX	
	<input type="checkbox"/>	2TX + 2RX	
	<input type="checkbox"/>	Others:.....	
Antenna technology	<input checked="" type="checkbox"/>	SISO	
	<input type="checkbox"/>	MIMO	<input type="checkbox"/> CDD
			<input type="checkbox"/> Beam-forming
Antenna Type	<input type="checkbox"/>	External	<input type="checkbox"/> Dipole
			<input type="checkbox"/> Sectorized
	<input checked="" type="checkbox"/>	Internal	<input type="checkbox"/> PIFA
			<input checked="" type="checkbox"/> PCB
			<input type="checkbox"/> Dipole
			<input type="checkbox"/> Others.....
Antenna Gain	3.2dBi		

1.3 Channel List

Bluetooth Working Frequency of Each Channel:							
Channel	Frequency	Channel	Frequency	Channel	Frequency	Channel	Frequency
00	2402 MHz	01	2404 MHz	02	2406 MHz	03	2408 MHz
04	2410 MHz	05	2412 MHz	06	2414 MHz	07	2416 MHz
08	2418 MHz	09	2420 MHz	10	2422 MHz	11	2424 MHz
12	2426 MHz	13	2428 MHz	14	2430 MHz	15	2432 MHz
16	2434 MHz	17	2436 MHz	18	2438 MHz	19	2440 MHz
20	2442 MHz	21	2444 MHz	22	2446 MHz	23	2448 MHz
24	2450 MHz	25	2452 MHz	26	2454 MHz	27	2456 MHz
28	2458 MHz	29	2460 MHz	30	2462 MHz	31	2464 MHz
32	2466 MHz	33	2468 MHz	34	2470 MHz	35	2472 MHz
36	2474 MHz	37	2476 MHz	38	2478 MHz	39	2480 MHz

Note: The general description of the Item(s), antenna information and channel list in clause 1 are provided and confirmed by the client.

2 DESCRIPTION OF TEST SETUP

2.1 Operating mode(s) used for tests

During the tests the following operating mode(s) has(have) been used.

Test Mode For Bluetooth	Mode1: Transmit by LE_1Mbps
	Mode1: Transmit by LE_2Mbps

2.2 Accessories Information

Accessories Information	Brand/model name	Cable		
		Length used during test [m]	Attached during test	Shielded
USB Cable	N/A	10	<input checked="" type="checkbox"/>	<input checked="" type="checkbox"/>
USB Cable	N/A	0.5	<input checked="" type="checkbox"/>	<input checked="" type="checkbox"/>

2.3 Auxiliary equipment / Test software for the EUT

Auxiliary equipment	Type / Version	Manufacturer	Supplied by
Notebook	2526	Think Pad	N/A
Software	Type / Version	Manufacturer	Supplied by
InstallBlueSuiteCda	N/A	N/A	N/A

2.4 Test Configuration / Block diagram used for tests

Test setup Diagram- AC Line Conducted Emission Test

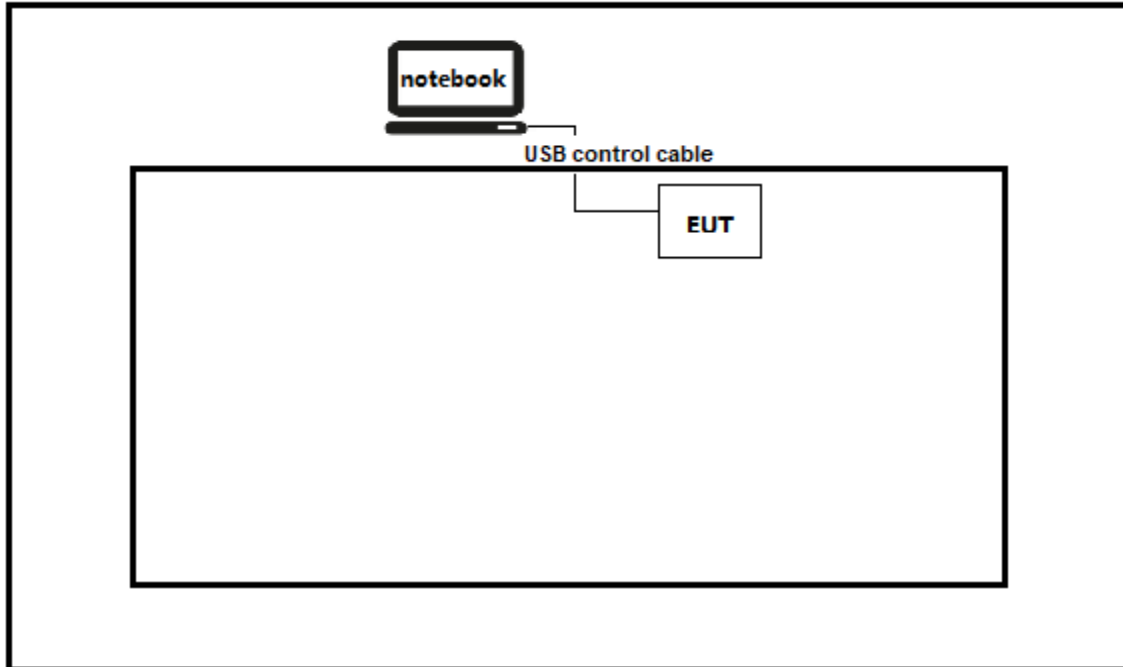

Test setup Diagram- Radiated Emission

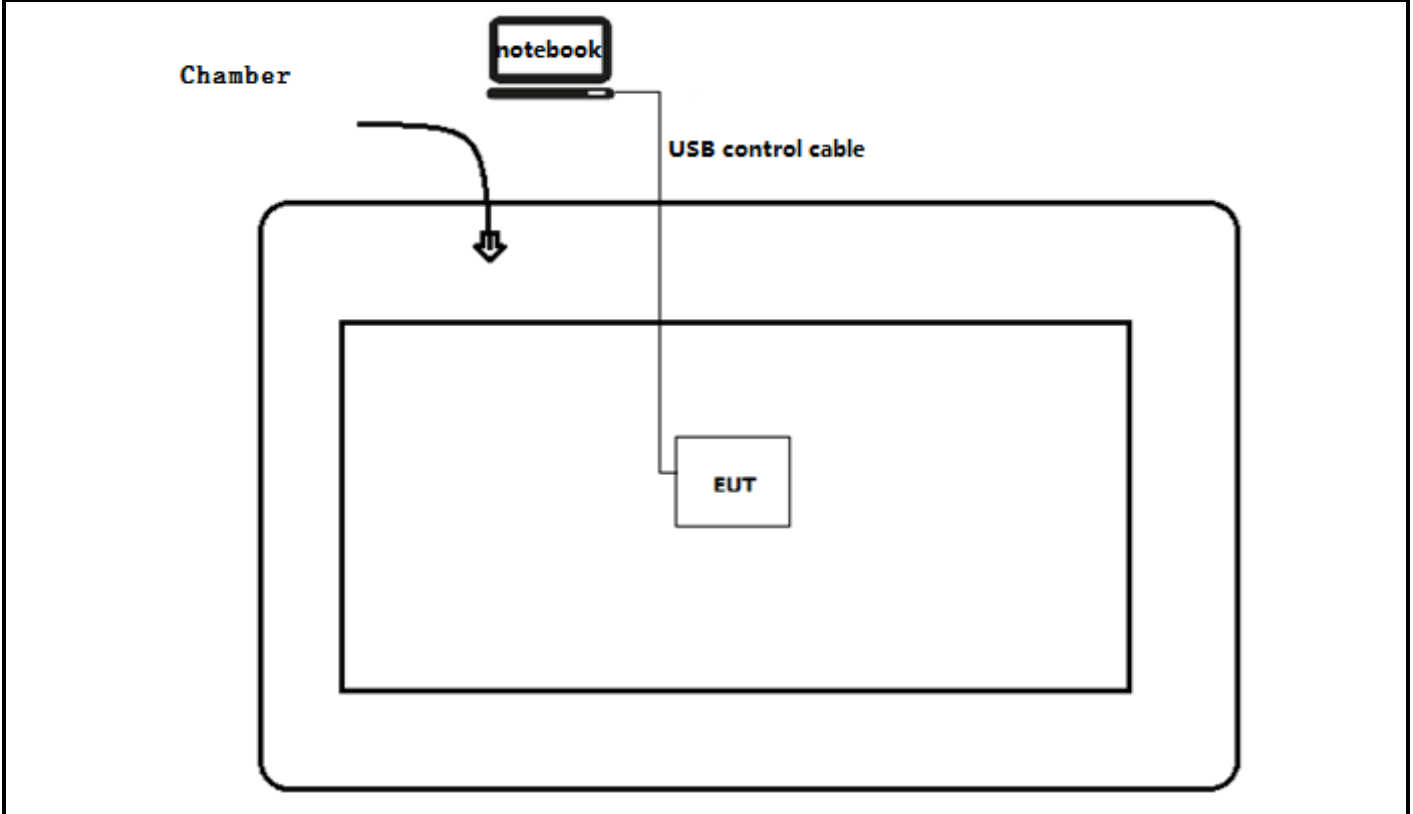

2.5 Testing process

1	Setup the EUT as shown in Section 2.4.
2	Run the software "InstallBlueSuiteCda" on the notebook computer.
3	Open the serial port and enter the corresponding commands to configure the test mode, test channel, test power and data rate.
4	Verify that the EUT works properly.

3 VERDICT SUMMARY SECTION

This chapter presents an overview of standards and results. Refer to the next chapters for details of measured test results and applied test levels.

3.1 Standards

Standard	Year	Description
FCC CFR Title 47 Part 15 Subpart C Section 15.247	2021	Operation within the bands 902–928 MHz, 2400–2483.5 MHz, and 5725–5850 MHz.
ANSI C63.10	2013	American National Standard of Procedures for Compliance Testing of Unlicensed Wireless Devices
KDB558074 D01 v05r02	2019	Guidance for performing compliance measurements on Digital Transmission System (DTS) operating under section 15.247

3.2 Deviation(s) from the Standard(s) / Test Specification(s)

The following deviation(s) was / were made from the published requirements of the listed standards: N/A.

(Please define the deviations from the standard(s) if applicable)

3.3 Overview of results

For FCC

Requirement – Test case	Basic standard(s)	Verdict	Remark
AC Power Line Conducted Emission	FCC 15.207	N/A	---
Emissions in restricted frequency bands	FCC 15.247(b)(3)	PASS	---
Duty cycle	ANSI C63.10:2013	PASS	---
Emissions in non-restricted frequency bands	FCC 15.247(d), FCC 15.209	PASS	---
Band Edge	FCC 15.247(d)	PASS	---
Fundamental emission output power	FCC 15.247(d), FCC 15.209	PASS	---
DTS Bandwidth	FCC 15.247(a)(2)	PASS	---
Power Spectral Density	FCC 15.247(e)	PASS	---
Antenna Requirement	FCC 15.203	PASS	---

3.4 Test Facility

USA : FCC Designation Number: CN1199

4 TEST RESULTS

4.1 AC Power Line Conducted Emission

VERDICT: N/A

4.1.1 Limit

Standard FCC Part 15 Subpart C Paragraph 15.207

Frequency range [MHz]	Limit: QP [dB(μV) ¹⁾	Limit: AV [dB(μV) ¹⁾
0,15 - 0,50	66 - 56 ²⁾	56 - 46 ²⁾
0,50 - 5,0	56	46
5,0 - 30	60	50

¹⁾ At the transition frequency, the lower limit applies.

²⁾ The limit decreases linearly with the logarithm of the frequency.

NOTE 1: The exclusion band for transmitters shall be considered for transmitters operating at frequencies below 30 MHz.

NOTE 2: Where the AC output port is directly connected (or via a circuit breaker) to the AC power input port of the EUT the AC power output port need not to be tested.

4.1.2 Test Setup

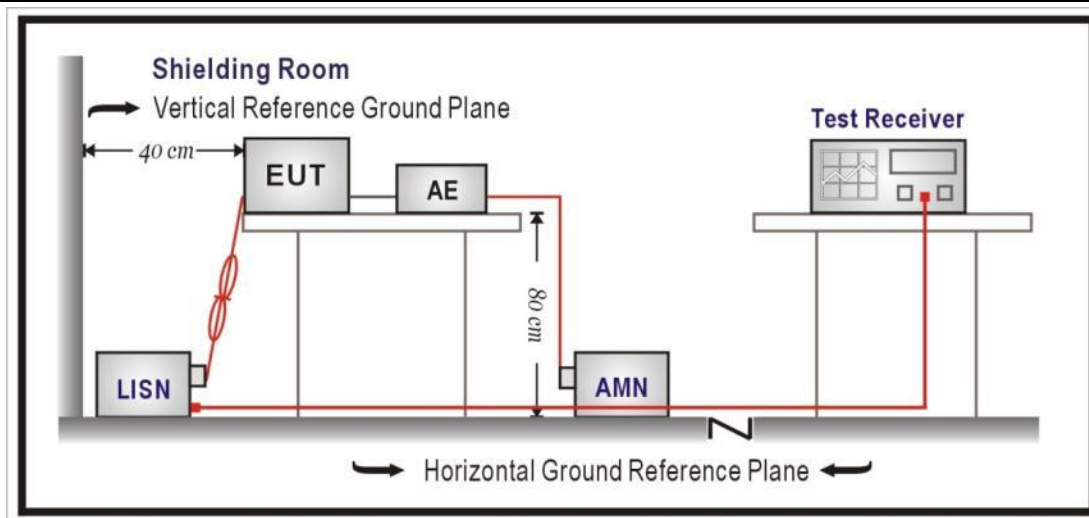

4.1.3 Test Procedure

	References Rule	Chapter	Item
<input checked="" type="checkbox"/>	ANSI C63.10-2013	6.2	Standard test method for ac power-line conducted emissions from unlicensed wireless devices

4.1.4 Test Data

Note: EUT is DC powered.

4.2 Emissions in restricted frequency bands**VERDICT: PASS****4.2.1 Limit****Standard** FCC Part 15 Subpart C Paragraph 15.209

Restricted Bands of operation for FCC

Frequency (MHz)	Frequency (MHz)	Frequency (MHz)	Frequency (GHz)
0.090 – 0.110	16.42 – 16.423	399.9 – 410	4.5 – 5.15
0.495 – 0.505	16.69475 – 16.69525	608 – 614	5.35 – 5.46
2.1735 – 2.1905	16.80425 – 16.80475	960 – 1240	7.25 – 7.75
4.125 – 4.128	25.5 – 25.67	1300 – 1427	8.025 – 8.5
4.17725 – 4.17775	37.5 – 38.25	1435 – 1626.5	9.0 – 9.2
4.20725 – 4.20775	73 – 74.6	1645.5 – 1646.5	9.3 – 9.5
6.215 – 6.218	74.8 – 75.2	1660 – 1710	10.6 – 12.7
6.26775 – 6.26825	108 – 121.94	1718.8 – 1722.2	13.25 – 13.4
6.31175 – 6.31225	123 – 138	2200 – 2300	14.47 – 14.5
8.291 – 8.294	149.9 – 150.05	2310 – 2390	15.35 – 16.2
8.362 – 8.366	156.52475 – 156.52525	2483.5 – 2500	17.7 – 21.4
8.37625 – 8.38675	156.7 – 156.9	2690 – 2900	22.01 – 23.12
8.81425 – 8.81475	162.0125 – 167.17	3260 – 3267	23.6 – 24.0
12.29 – 12.293	167.72 – 173.2	3332 – 3339	31.2 – 31.8
12.51975 – 12.52025	240 – 285	3345.8 – 3358	36.43 – 36.5
12.57675 – 12.57725	322 – 335.4	3600 – 4400	
13.36 – 13.41			

Restricted Band Emissions Limit			
Frequency (MHz)	Field strength (μ V/m)	Field strength (dB μ V/m)	Measurement distance (m)
0.009 - 0.49	2400/F(kHz)	48.5 – 13.8	300 _(Note 1)
0.49 - 1.705	24000/F(kHz)	33.8 - 23	30 _(Note 1)
1.705 - 30	30	29.5	30 _(Note 1)
30 -88	100	40	3 _(Note 2)
88-216	150	43.5	3 _(Note 2)
216 - 960	200	46	3 _(Note 2)
Above 960	500	54	3 _(Note 2)

Note 1: At frequencies below 30 MHz, measurements may be performed at a distance closer than that specified in the regulations; however, an attempt should be made to avoid making measurements in the near field. Pending the development of an appropriate measurement procedure for measurements performed below 30 MHz, when performing measurements at a closer distance than specified, the results shall be extrapolated to the specified distance by either making measurements at a minimum of two distances on at least one radial to determine the proper extrapolation factor or by using the square of an inverse linear distance extrapolation factor (40 dB/decade).

Note 2: At frequencies at or above 30 MHz, measurements may be performed at a distance other than what is specified provided: measurements are not made in the near field except where it can be shown that near field measurements are appropriate due to the characteristics of the device; and it can be demonstrated that the signal levels needed to be measured at the distance employed can be detected by the measurement equipment. Measurements shall not be performed at a distance greater than 30 meters unless it can be further demonstrated that measurements at a distance of 30 meters or less are impractical. When performing measurements at a distance other than that specified, the results shall be extrapolated to the specified distance using an extrapolation factor of 20 dB/decade (inverse linear-distance for field strength measurements; inverse-linear-distance-squared for power density measurements).

4.2.2 Test Setup

Below 30MHz Test Setup:

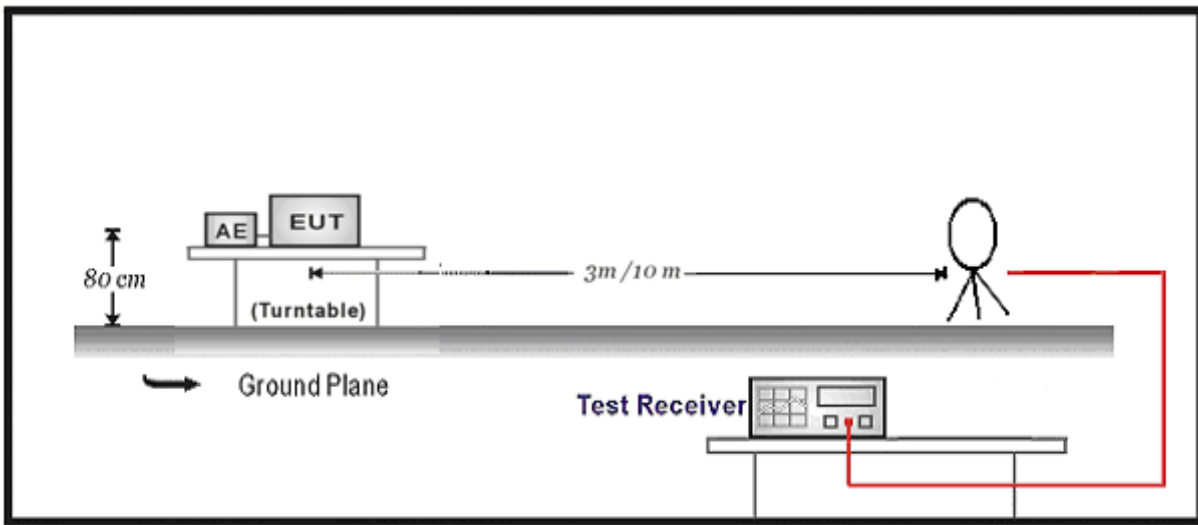

30MHz-1GHz Test Setup:

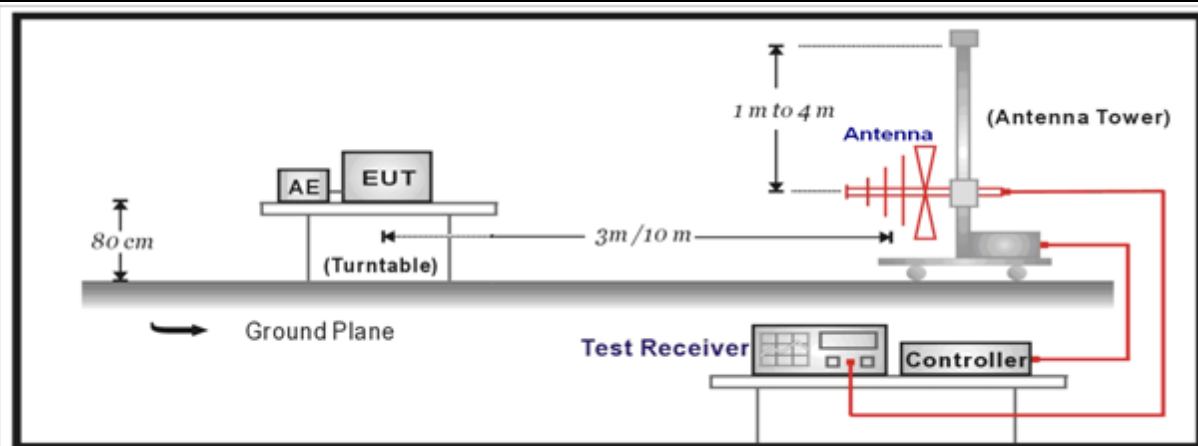

Above 1GHz Test Setup:

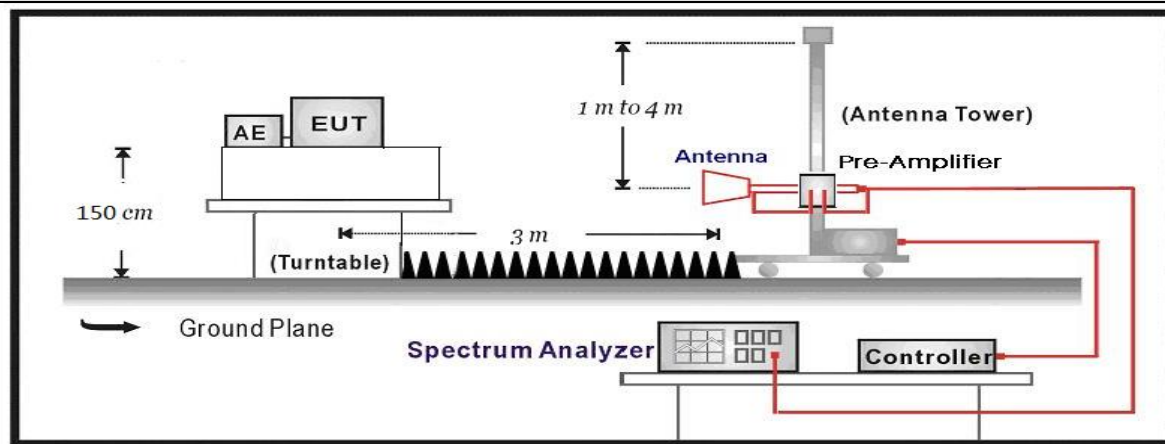

4.2.3 Test Procedure			
	References Rule	Chapter	Description
<input checked="" type="checkbox"/>	ANSI C63.10	11.12	Emissions in restricted frequency bands
<input checked="" type="checkbox"/>	<input checked="" type="checkbox"/> ANSI C63.10	11.12.1	Radiated emission measurements
<input checked="" type="checkbox"/>	<input checked="" type="checkbox"/> ANSI C63.10	11.12.2.7	Radiated spurious emission test
<input checked="" type="checkbox"/>	<input checked="" type="checkbox"/> ANSI C63.10	6.4	Radiated emissions from unlicensed wireless devices below 30 MHz
<input checked="" type="checkbox"/>	<input checked="" type="checkbox"/> ANSI C63.10	6.5	Radiated emissions from unlicensed wireless devices in the frequency range of 30 MHz to 1000 MHz
<input checked="" type="checkbox"/>	<input checked="" type="checkbox"/> ANSI C63.10	6.6	Radiated emissions from unlicensed wireless devices above 1 GHz

4.2.4 Test Data

Profile: 22A0151R	Page No.: 89
Engineer: YuLiu	
Site: AC5	Time: 2022/08/16 - 00:22
Limit: FCC_Part15.209_RE(3m)	Margin: 0
Probe: Horn_3117_00167055(1-18GHz)	Polarity: Vertical
EUT: AH80 BLUETOOTH HEADSET DONGLE	Power: DC 5V
Note: Mode1:Transmit at 2402MHz by BLE_1Mbps	

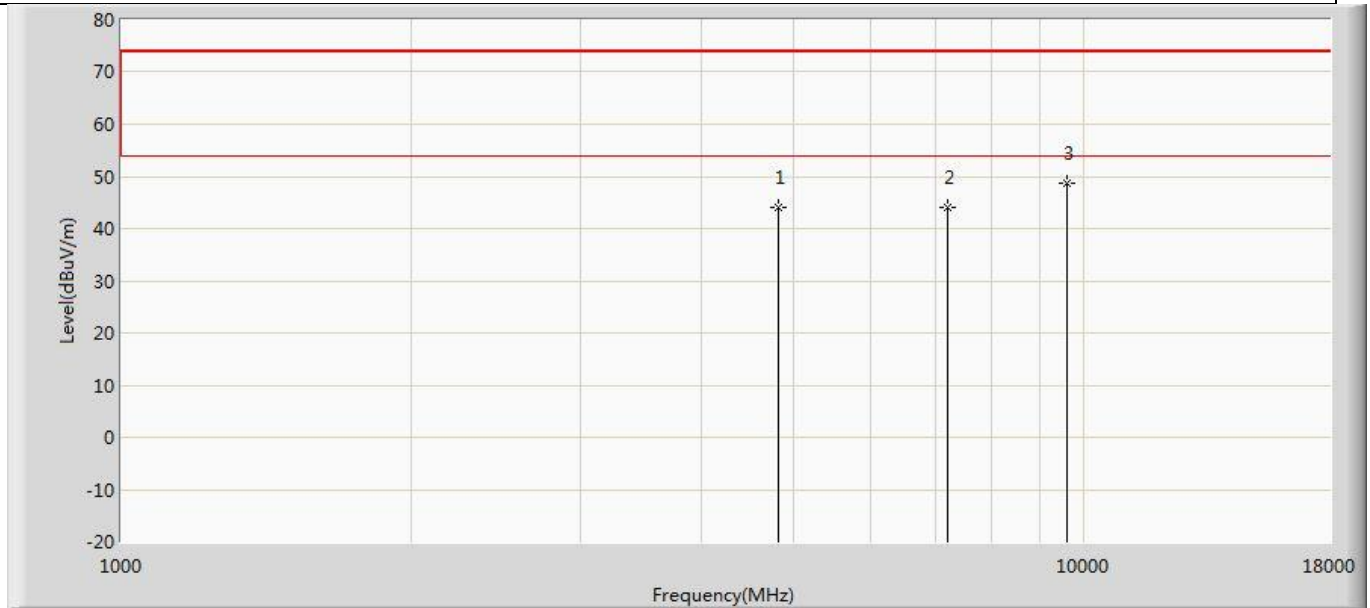

No	Mark	Frequency (MHz)	Measure Level (dBuV/m)	Reading Level (dBuV)	Over Limit (dB)	Limit (dBuV/m)	Factor (dB)	Type
1		4808.000	44.095	46.723	-29.905	74.000	-2.628	PK
2		7206.000	44.165	43.091	-29.835	74.000	1.074	PK
3	*	9610.500	48.767	46.432	-25.233	74.000	2.335	PK

Profile: 22A0151R	Page No.: 90
Engineer: YuLiu	
Site: AC5	Time: 2022/08/16 - 00:22
Limit: FCC_Part15.209_RE(3m)	Margin: 0
Probe: Horn_3117_00167055(1-18GHz)	Polarity: Horizontal
EUT: AH80 BLUETOOTH HEADSET DONGLE	Power: DC 5V
Note: Mode1:Transmit at 2402MHz by BLE_1Mbps	

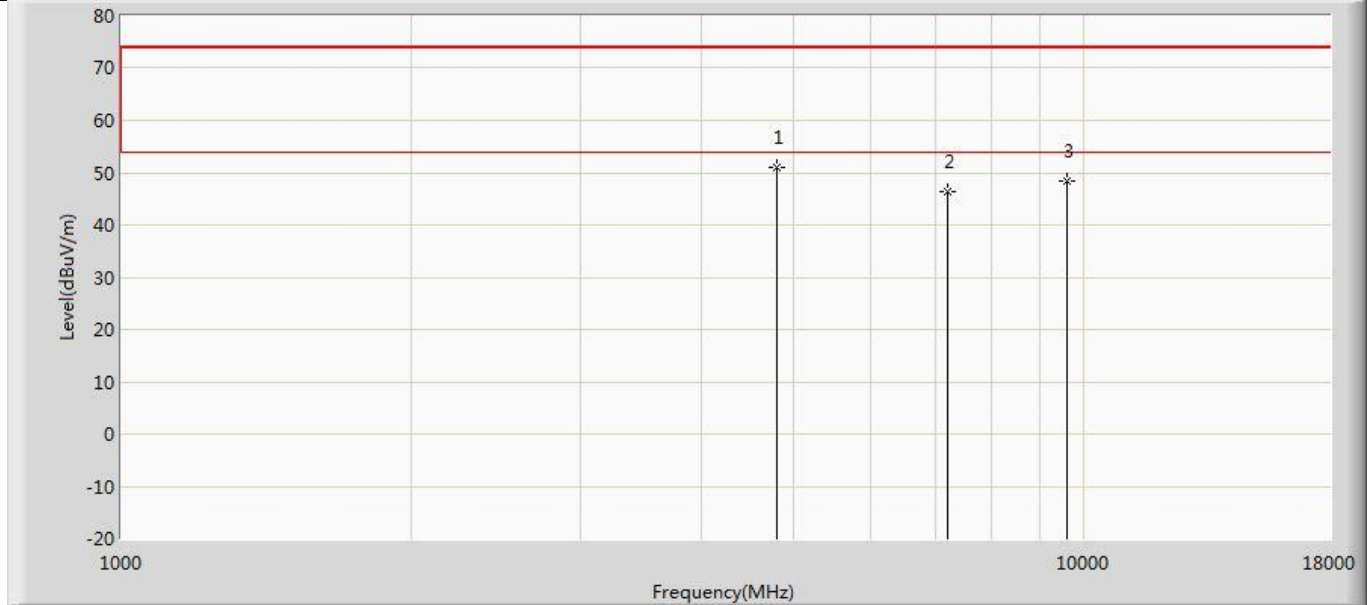

No	Mark	Frequency (MHz)	Measure Level (dBuV/m)	Reading Level (dBuV)	Over Limit (dB)	Limit (dBuV/m)	Factor (dB)	Type
1	*	4799.500	50.901	53.544	-23.099	74.000	-2.643	PK
2		7205.000	46.341	45.279	-27.659	74.000	1.062	PK
3		9610.500	48.419	46.084	-25.581	74.000	2.335	PK

Profile: 22A0151R	Page No.: 91
Engineer: YuLiu	
Site: AC5	Time: 2022/08/16 - 00:22
Limit: FCC_Part15.209_RE(3m)	Margin: 0
Probe: Horn_3117_00167055(1-18GHz)	Polarity: Vertical
EUT: AH80 BLUETOOTH HEADSET DONGLE	Power: DC 5V
Note: Mode1:Transmit at 2440MHz by BLE_1Mbps	

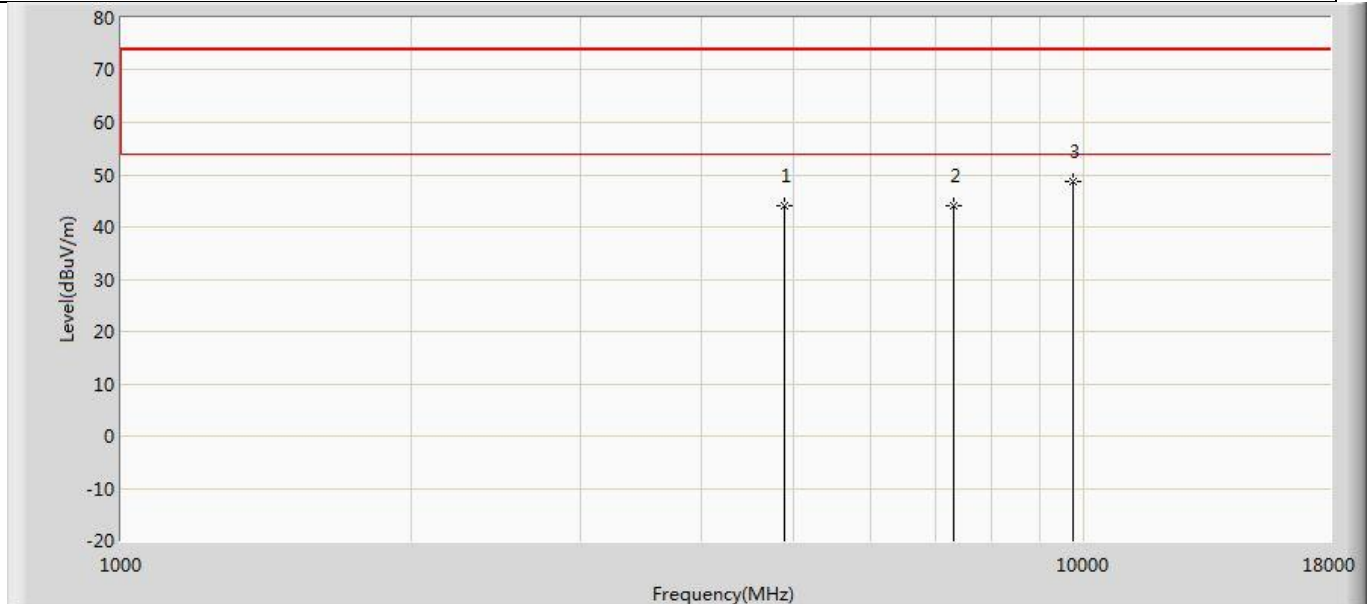

No	Mark	Frequency (MHz)	Measure Level (dBuV/m)	Reading Level (dBuV)	Over Limit (dB)	Limit (dBuV/m)	Factor (dB)	Type
1		4876.000	44.196	46.399	-29.804	74.000	-2.203	PK
2		7320.000	44.005	42.908	-29.995	74.000	1.098	PK
3	*	9755.000	48.605	45.543	-25.395	74.000	3.062	PK

Profile: 22A0151R	Page No.: 92
Engineer: YuLiu	
Site: AC5	Time: 2022/08/16 - 00:22
Limit: FCC_Part15.209_RE(3m)	Margin: 0
Probe: Horn_3117_00167055(1-18GHz)	Polarity: Horizontal
EUT: AH80 BLUETOOTH HEADSET DONGLE	Power: DC 5V
Note: Mode1:Transmit at 2440MHz by BLE_1Mbps	

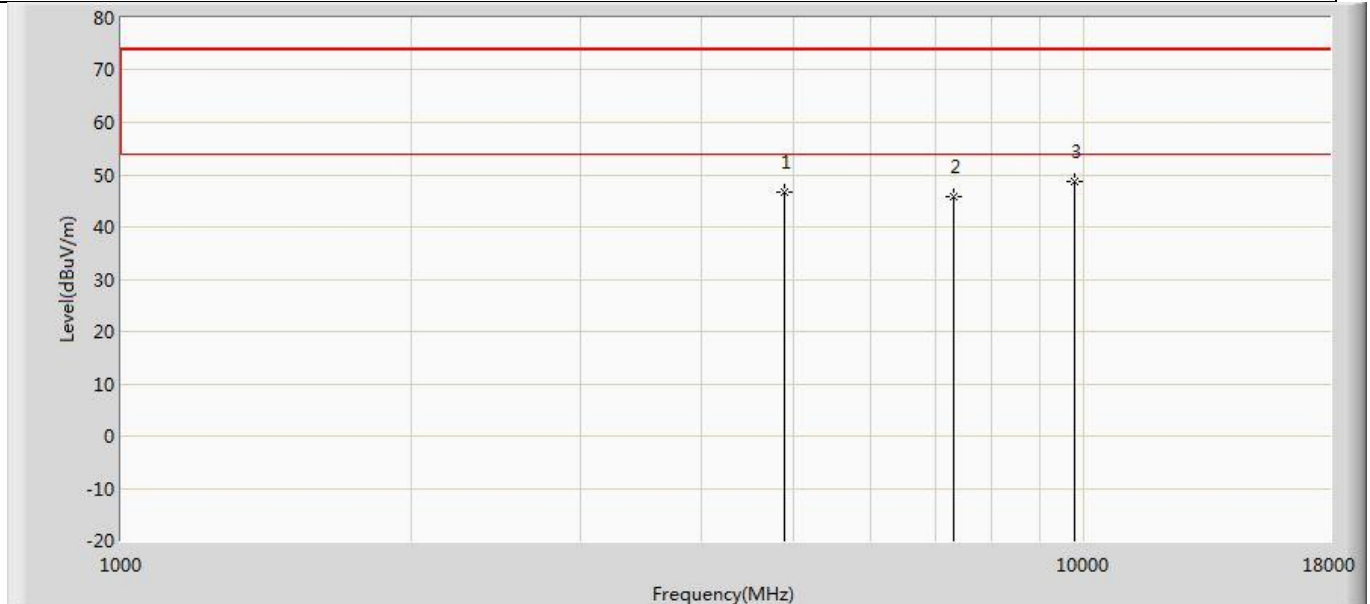

No	Mark	Frequency (MHz)	Measure Level (dBuV/m)	Reading Level (dBuV)	Over Limit (dB)	Limit (dBuV/m)	Factor (dB)	Type
1		4876.000	46.666	48.869	-27.334	74.000	-2.203	PK
2		7315.500	45.703	44.495	-28.297	74.000	1.208	PK
3	*	9763.500	48.820	45.941	-25.180	74.000	2.879	PK

Profile: 22A0151R	Page No.: 93
Engineer: YuLiu	
Site: AC5	Time: 2022/08/16 - 00:22
Limit: FCC_Part15.209_RE(3m)	Margin: 0
Probe: Horn_3117_00167055(1-18GHz)	Polarity: Vertical
EUT: AH80 BLUETOOTH HEADSET DONGLE	Power: DC 5V
Note: Mode1:Transmit at 2480MHz by BLE_1Mbps	

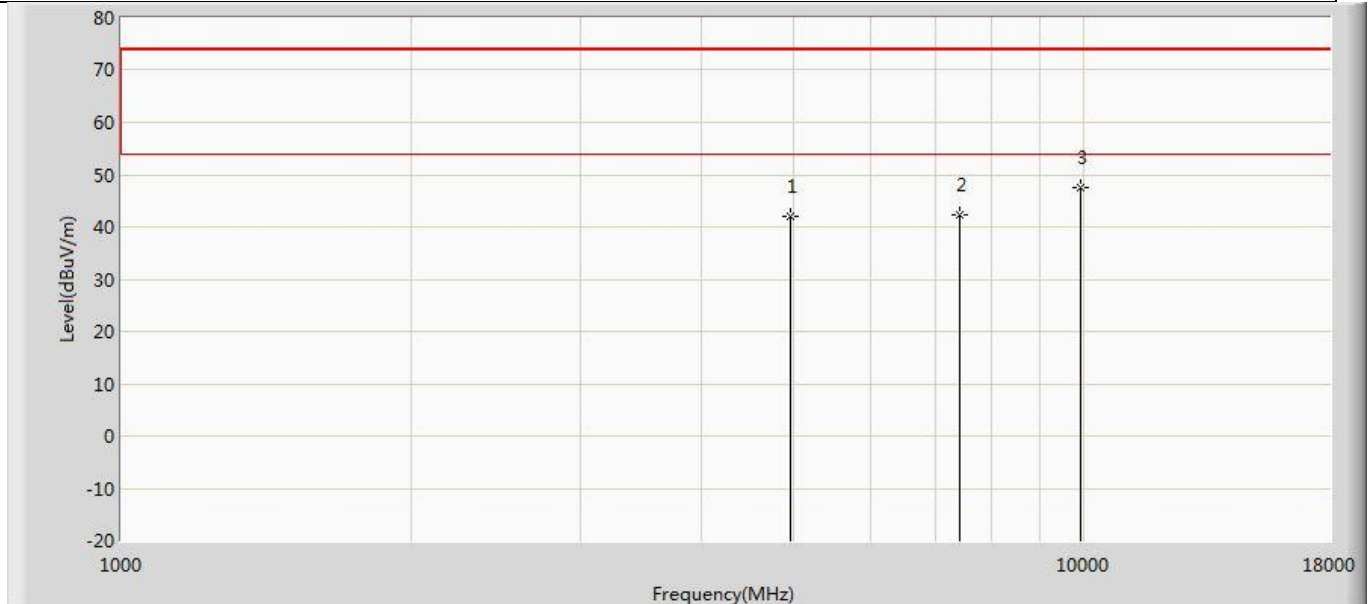

No	Mark	Frequency (MHz)	Measure Level (dBuV/m)	Reading Level (dBuV)	Over Limit (dB)	Limit (dBuV/m)	Factor (dB)	Type
1		4960.000	42.010	44.467	-31.990	74.000	-2.457	PK
2		7440.000	42.244	41.302	-31.756	74.000	0.943	PK
3	*	9920.000	47.599	44.840	-26.401	74.000	2.760	PK

Profile: 22A0151R	Page No.: 94
Engineer: YuLiu	
Site: AC5	Time: 2022/08/16 - 00:22
Limit: FCC_Part15.209_RE(3m)	Margin: 0
Probe: Horn_3117_00167055(1-18GHz)	Polarity: Horizontal
EUT: AH80 BLUETOOTH HEADSET DONGLE	Power: DC 5V
Note: Mode1:Transmit at 2480MHz by BLE_1Mbps	

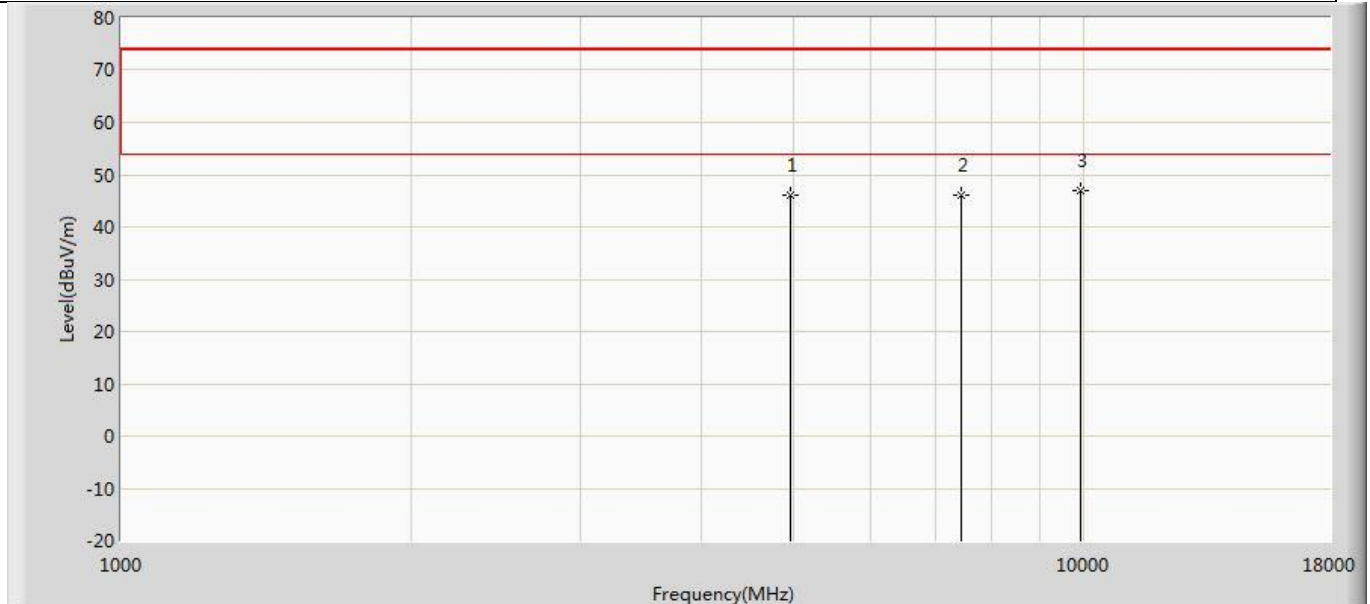

No	Mark	Frequency (MHz)	Measure Level (dBuV/m)	Reading Level (dBuV)	Over Limit (dB)	Limit (dBuV/m)	Factor (dB)	Type
1		4961.000	46.112	48.571	-27.888	74.000	-2.459	PK
2		7443.000	46.095	45.160	-27.905	74.000	0.935	PK
3	*	9916.500	47.077	44.244	-26.923	74.000	2.832	PK

Profile: 22A0151R	Page No.: 95
Engineer: YuLiu	
Site: AC5	Time: 2022/08/16 - 00:22
Limit: FCC_Part15.209_RE(3m)	Margin: 0
Probe: Horn_3117_00167055(1-18GHz)	Polarity: Vertical
EUT: AH80 BLUETOOTH HEADSET DONGLE	Power: DC 5V
Note: Mode2:Transmit at 2402MHz by BLE_2Mbps	

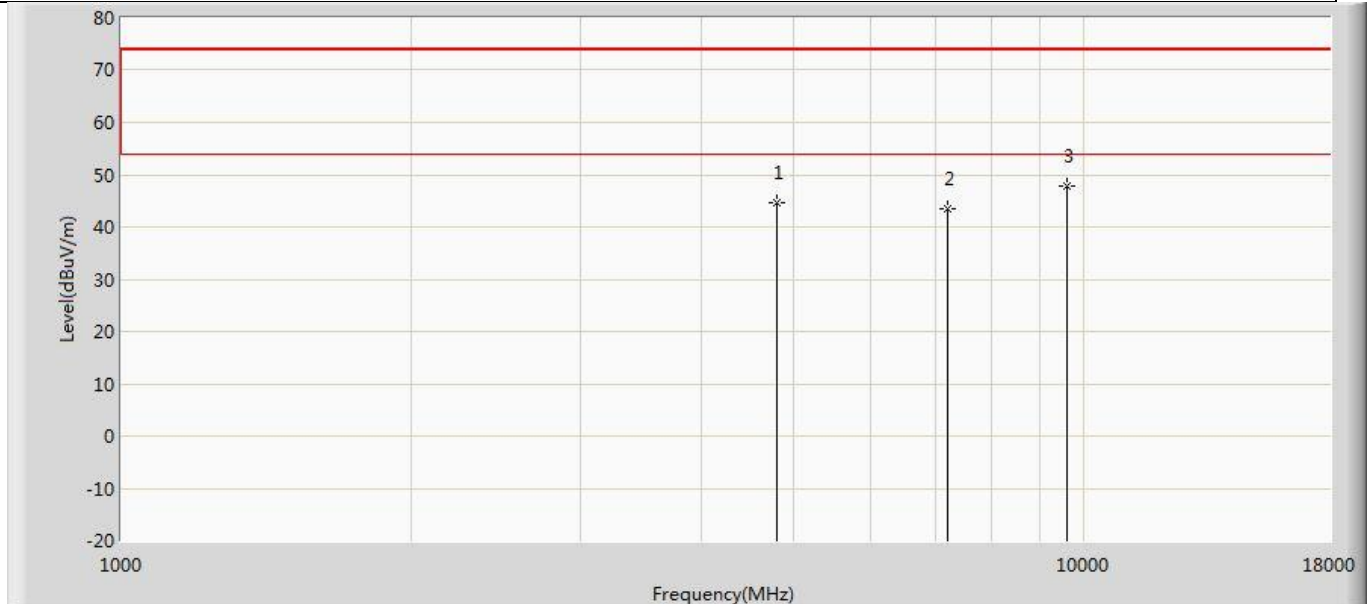

No	Mark	Frequency (MHz)	Measure Level (dBuV/m)	Reading Level (dBuV)	Over Limit (dB)	Limit (dBuV/m)	Factor (dB)	Type
1		4799.500	44.769	47.411	-29.231	74.000	-2.643	PK
2		7206.000	43.424	42.350	-30.576	74.000	1.074	PK
3	*	9610.500	47.761	45.427	-26.239	74.000	2.335	PK

Profile: 22A0151R	Page No.: 96
Engineer: YuLiu	
Site: AC5	Time: 2022/08/16 - 00:22
Limit: FCC_Part15.209_RE(3m)	Margin: 0
Probe: Horn_3117_00167055(1-18GHz)	Polarity: Horizontal
EUT: AH80 BLUETOOTH HEADSET DONGLE	Power: DC 5V
Note: Mode2:Transmit at 2402MHz by BLE_2Mbps	

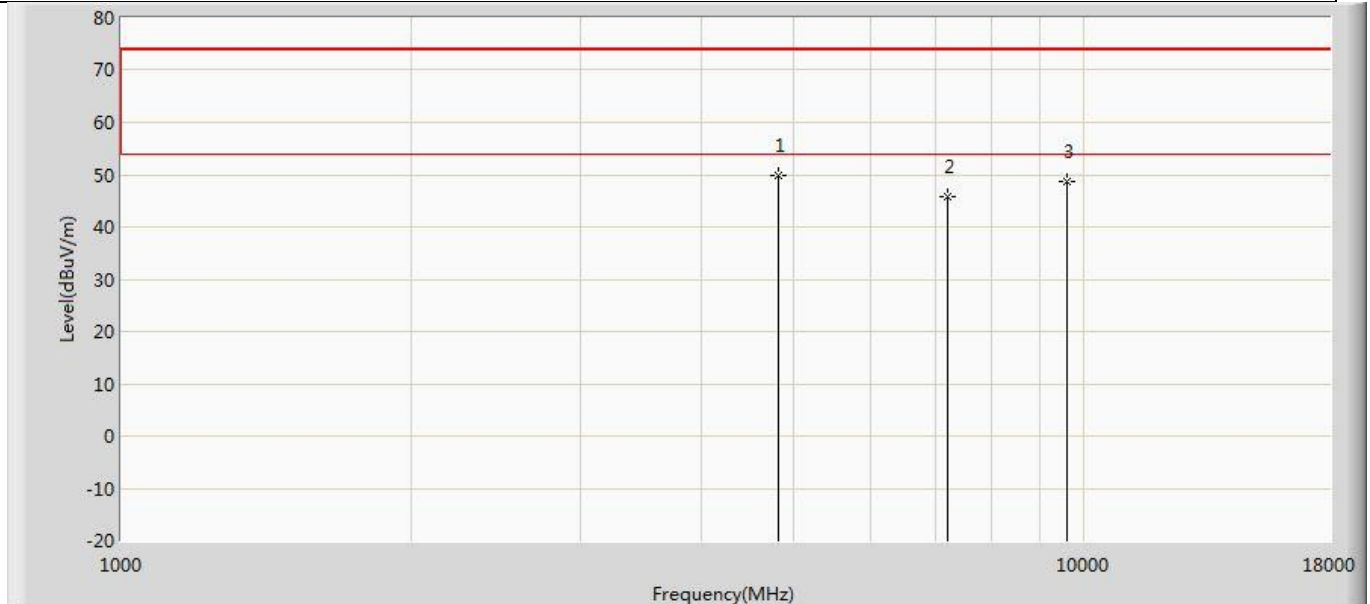

No	Mark	Frequency (MHz)	Measure Level (dBuV/m)	Reading Level (dBuV)	Over Limit (dB)	Limit (dBuV/m)	Factor (dB)	Type
1	*	4808.000	49.955	52.583	-24.045	74.000	-2.628	PK
2		7205.000	45.789	44.727	-28.211	74.000	1.062	PK
3		9610.500	48.576	46.241	-25.424	74.000	2.335	PK

Profile: 22A0151R	Page No.: 97
Engineer: YuLiu	
Site: AC5	Time: 2022/08/16 - 00:22
Limit: FCC_Part15.209_RE(3m)	Margin: 0
Probe: Horn_3117_00167055(1-18GHz)	Polarity: Vertical
EUT: AH80 BLUETOOTH HEADSET DONGLE	Power: DC 5V
Note: Mode2:Transmit at 2440MHz by BLE_2Mbps	

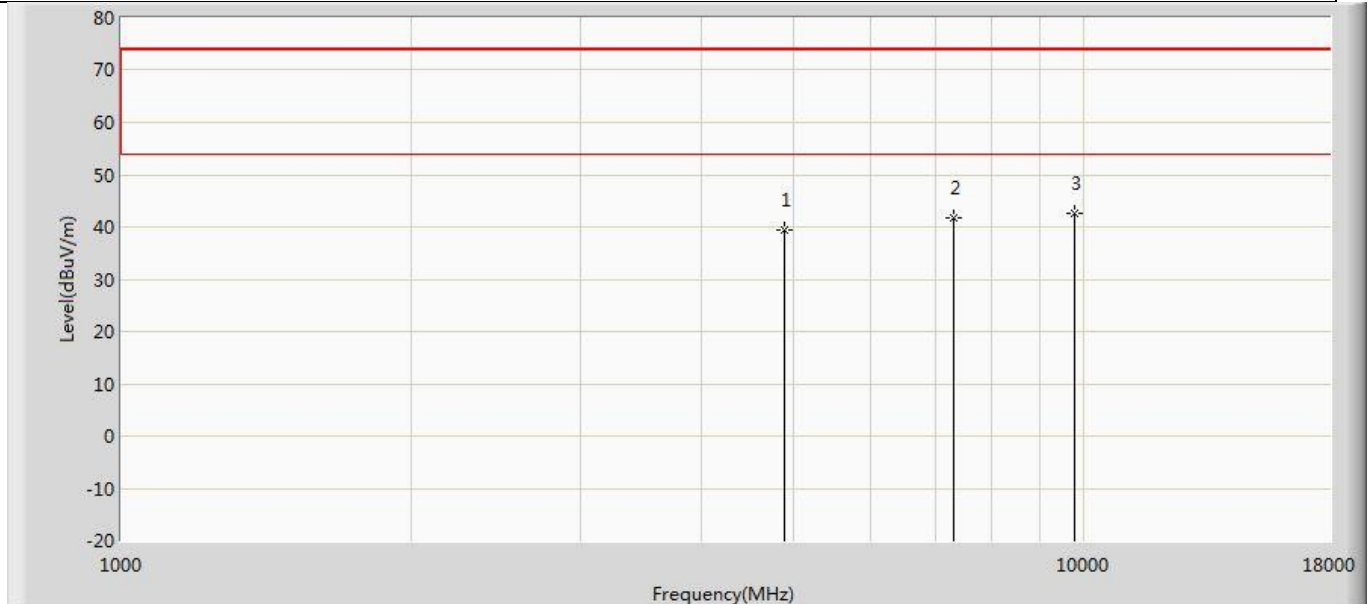

No	Mark	Frequency (MHz)	Measure Level (dBuV/m)	Reading Level (dBuV)	Over Limit (dB)	Limit (dBuV/m)	Factor (dB)	Type
1		4880.000	39.384	41.675	-34.616	74.000	-2.292	PK
2		7320.000	41.817	40.720	-32.183	74.000	1.098	PK
3	*	9760.000	42.735	39.781	-31.265	74.000	2.954	PK

Profile: 22A0151R	Page No.: 98
Engineer: YuLiu	
Site: AC5	Time: 2022/08/16 - 00:23
Limit: FCC_Part15.209_RE(3m)	Margin: 0
Probe: Horn_3117_00167055(1-18GHz)	Polarity: Horizontal
EUT: AH80 BLUETOOTH HEADSET DONGLE	Power: DC 5V
Note: Mode2:Transmit at 2440MHz by BLE_2Mbps	

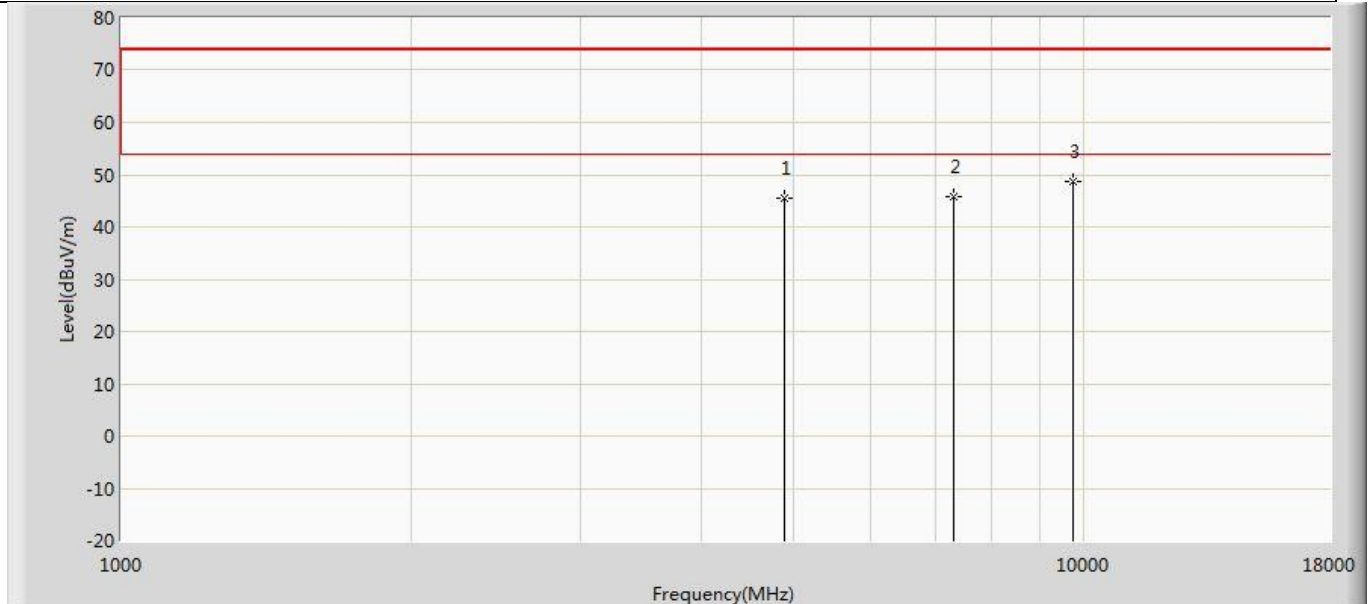

No	Mark	Frequency (MHz)	Measure Level (dBuV/m)	Reading Level (dBuV)	Over Limit (dB)	Limit (dBuV/m)	Factor (dB)	Type
1		4884.500	45.380	47.770	-28.620	74.000	-2.391	PK
2		7315.500	45.838	44.630	-28.162	74.000	1.208	PK
3	*	9755.000	48.698	45.636	-25.302	74.000	3.062	PK

Profile: 22A0151R	Page No.: 99
Engineer: YuLiu	
Site: AC5	Time: 2022/08/16 - 00:23
Limit: FCC_Part15.209_RE(3m)	Margin: 0
Probe: Horn_3117_00167055(1-18GHz)	Polarity: Vertical
EUT: AH80 BLUETOOTH HEADSET DONGLE	Power: DC 5V
Note: Mode2:Transmit at 2480MHz by BLE_2Mbps	

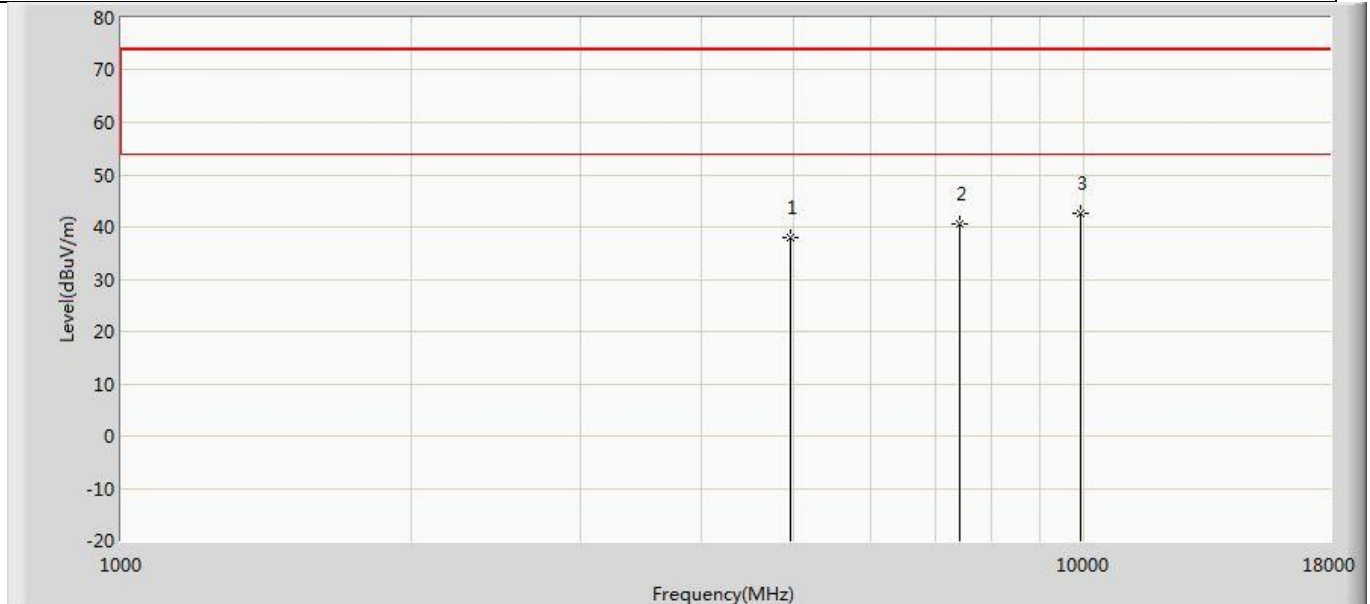

No	Mark	Frequency (MHz)	Measure Level (dBuV/m)	Reading Level (dBuV)	Over Limit (dB)	Limit (dBuV/m)	Factor (dB)	Type
1		4960.000	37.987	40.444	-36.013	74.000	-2.457	PK
2		7440.000	40.571	39.629	-33.429	74.000	0.943	PK
3	*	9920.000	42.717	39.958	-31.283	74.000	2.760	PK

Profile: 22A0151R	Page No.: 100
Engineer: YuLiu	
Site: AC5	Time: 2022/08/16 - 00:23
Limit: FCC_Part15.209_RE(3m)	Margin: 0
Probe: Horn_3117_00167055(1-18GHz)	Polarity: Horizontal
EUT: AH80 BLUETOOTH HEADSET DONGLE	Power: DC 5V
Note: Mode2:Transmit at 2480MHz by BLE_2Mbps	

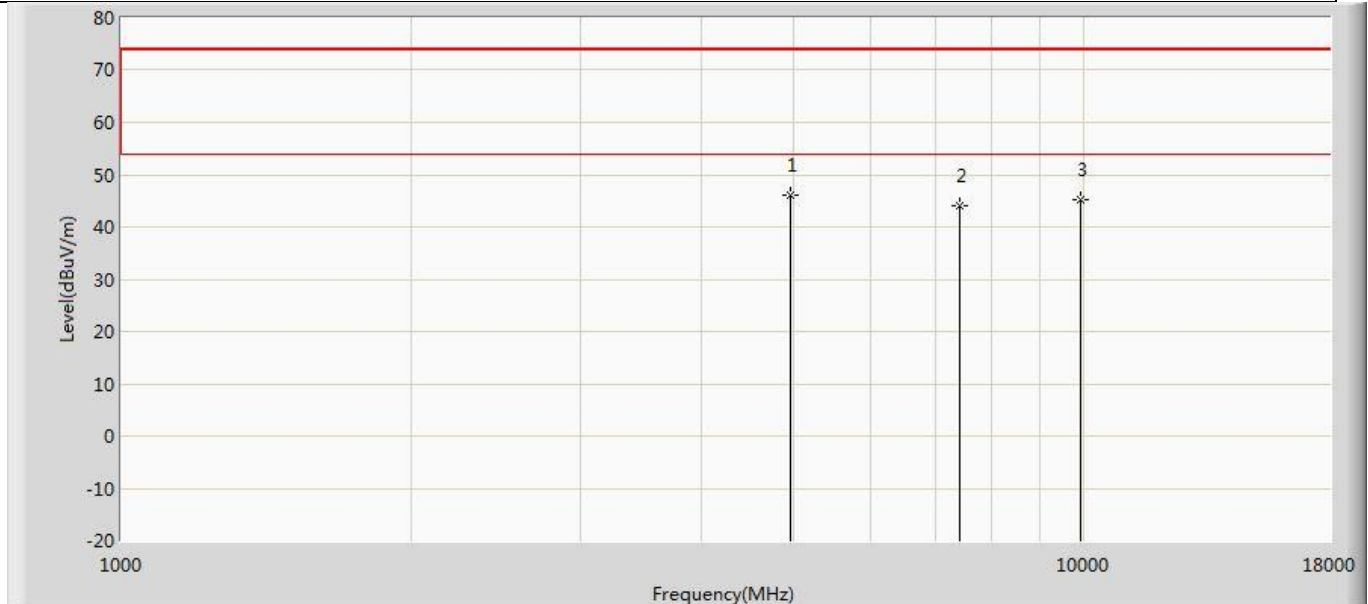

No	Mark	Frequency (MHz)	Measure Level (dBuV/m)	Reading Level (dBuV)	Over Limit (dB)	Limit (dBuV/m)	Factor (dB)	Type
1	*	4961.000	45.994	48.453	-28.006	74.000	-2.459	PK
2		7440.000	44.028	43.086	-29.972	74.000	0.943	PK
3		9920.000	45.206	42.447	-28.794	74.000	2.760	PK

Note:

1. Measured Level = Reading Level + Factor.
2. The test frequency range, 9kHz~30MHz, worst case are at least 20dB below the limits, therefore no data appear in the report.
3. The test frequency range, 18GHz~26GHz test result on peak is lower than average limit, all is the noise base, therefore no data appear in the report.
4. This limit applies for using average detector, if the test result on peak is lower than average limit, then average measurement needn't be performed.
5. As the radiated emission was performed, so conducted emission was not tested.

The worst case of Radiated Emission below 1GHz:

Profile: 22A0151R	Page No.: 1
Engineer: Yuliu	
Site: AC2	Time: 2022/08/26 - 23:23
Limit: FCC_Part15.209_RE(3m)_ClassB	Margin: 0
Probe: AC2_3M(30-1000M)	Polarity: Horizontal
EUT: AH80 BLUETOOTH HEADSET DONGLE	Power: DC5V
Note: Mode 1	

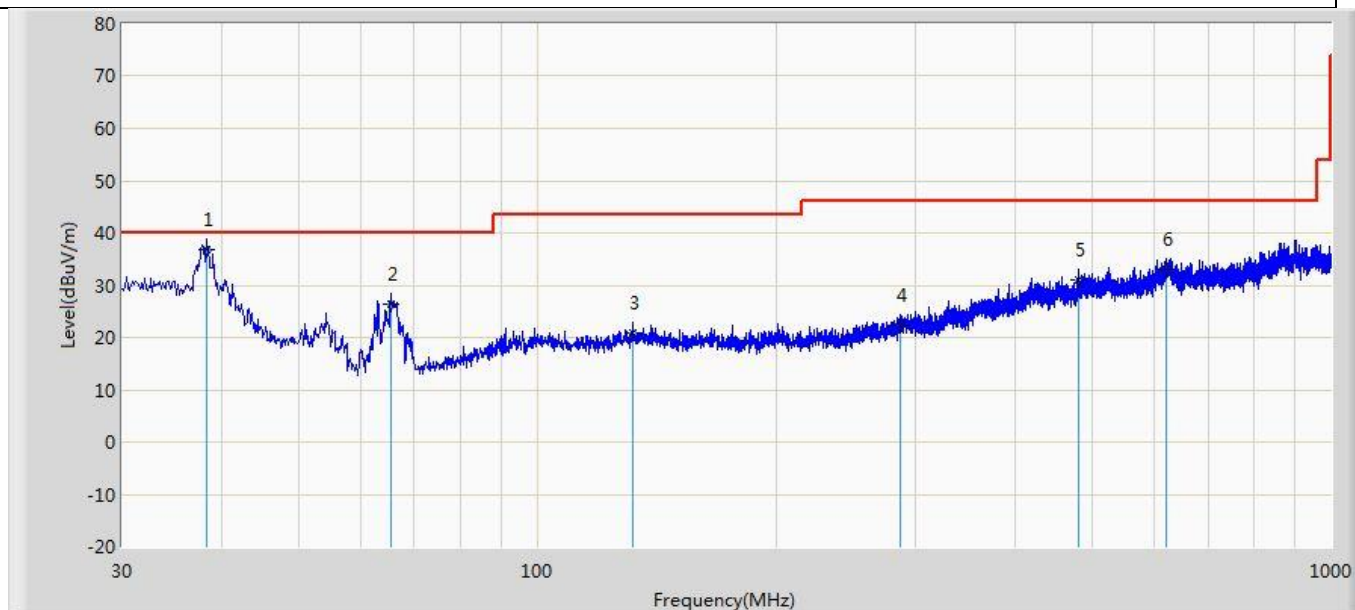

No	Mark	Frequency (MHz)	Measure Level (dBuV/m)	Reading Level (dBuV)	Over Limit (dB)	Limit (dBuV/m)	Factor (dB)	Type
1	*	38.366	36.911	13.110	-3.089	40.000	23.801	QP
2		65.405	26.481	16.311	-13.519	40.000	10.170	QP
3		131.850	20.784	3.166	-22.716	43.500	17.618	QP
4		286.565	22.285	1.771	-23.715	46.000	20.514	QP
5		480.080	31.128	4.011	-14.872	46.000	27.117	QP
6		621.458	33.165	2.402	-12.835	46.000	30.762	QP

Note:

1. All Readings below 1GHz are Quasi-Peak, above are performed with peak and/or average measurements as necessary.
2. " * ", means this data is the worst emission level.
3. Measurement Level = Reading Level + Factor(Probe+Cable-Amp)

Profile: 22A0151R	Page No.: 2
Engineer: Yuliu	
Site: AC2	Time: 2022/08/26 - 23:24
Limit: FCC_Part15.209_RE(3m)_ClassB	Margin: 0
Probe: AC2_3M(30-1000M)	Polarity: Vertical
EUT: AH80 BLUETOOTH HEADSET DONGLE	Power: DC5V
Note: Mode 1:	

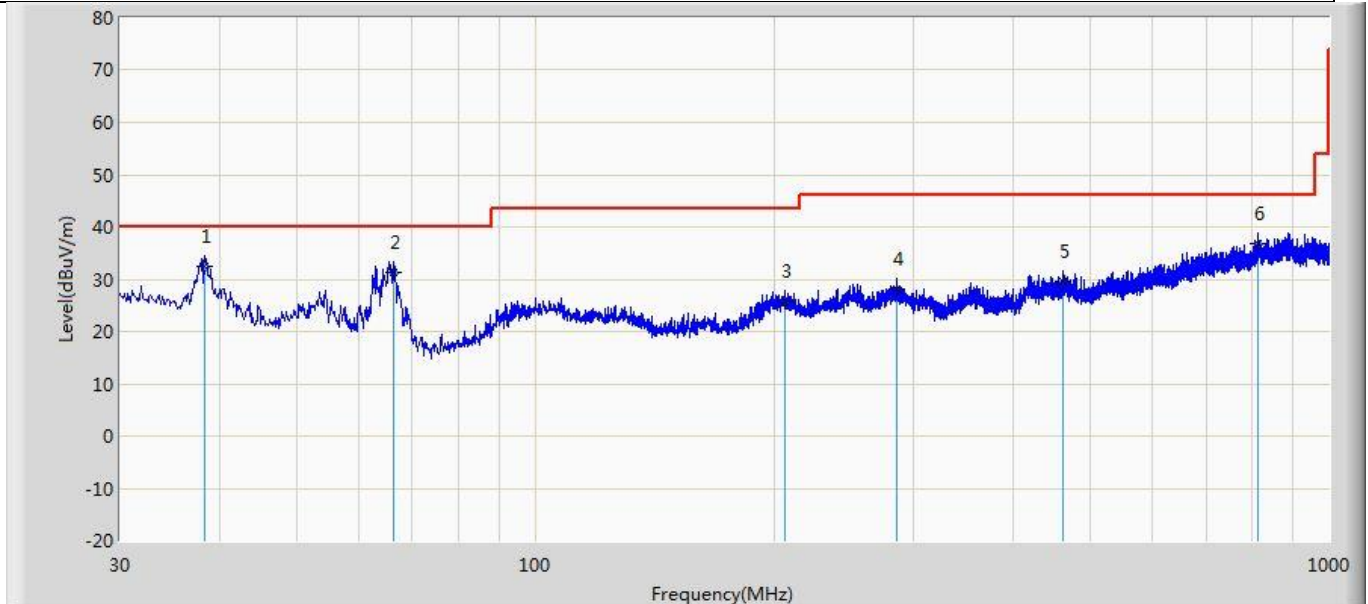

No	Mark	Frequency (MHz)	Measure Level (dBuV/m)	Reading Level (dBuV)	Over Limit (dB)	Limit (dBuV/m)	Factor (dB)	Type
1	*	38.366	32.384	12.214	-7.616	40.000	20.170	QP
2		66.375	31.343	15.658	-8.657	40.000	15.684	QP
3		206.176	25.834	2.402	-17.666	43.500	23.432	QP
4		285.474	28.150	2.994	-17.850	46.000	25.156	QP
5		463.226	29.710	3.060	-16.290	46.000	26.650	QP
6		814.609	36.868	4.000	-9.132	46.000	32.868	QP

Note:

1. All Readings below 1GHz are Quasi-Peak, above are performed with peak and/or average measurements as necessary.
2. " * ", means this data is the worst emission level.
3. Measurement Level = Reading Level + Factor(Probe+Cable-Amp)

4.3 Emissions in non-restricted frequency band	VERDICT: PASS
---	----------------------

4.3.1 Limit	
Standard	FCC Part 15 Subpart C Paragraph 15.247(d)
RF Output power (Detection methods)	Limit(dB)
RF Output power(Average detector)	30dBc(Note1)
RF Output power(PK detector)	20dBc(Note2)
<p>Note 1: If maximum conducted (average) output power was used to demonstrate compliance as described in 9.2, then the peak power in any 100 kHz bandwidth outside of the authorized frequency band shall be attenuated by at least 30 dB relative to the maximum in-band peak PSD level in 100 kHz (i.e., 30 dBc).</p> <p>Note 2: If the maximum peak conducted output power procedure was used, then the peak output power measured in any 100 kHz bandwidth outside of the authorized frequency band shall be attenuated by at least 20 dB relative to the maximum in-band peak PSD level in 100 kHz (i.e., 20 dBc).</p>	

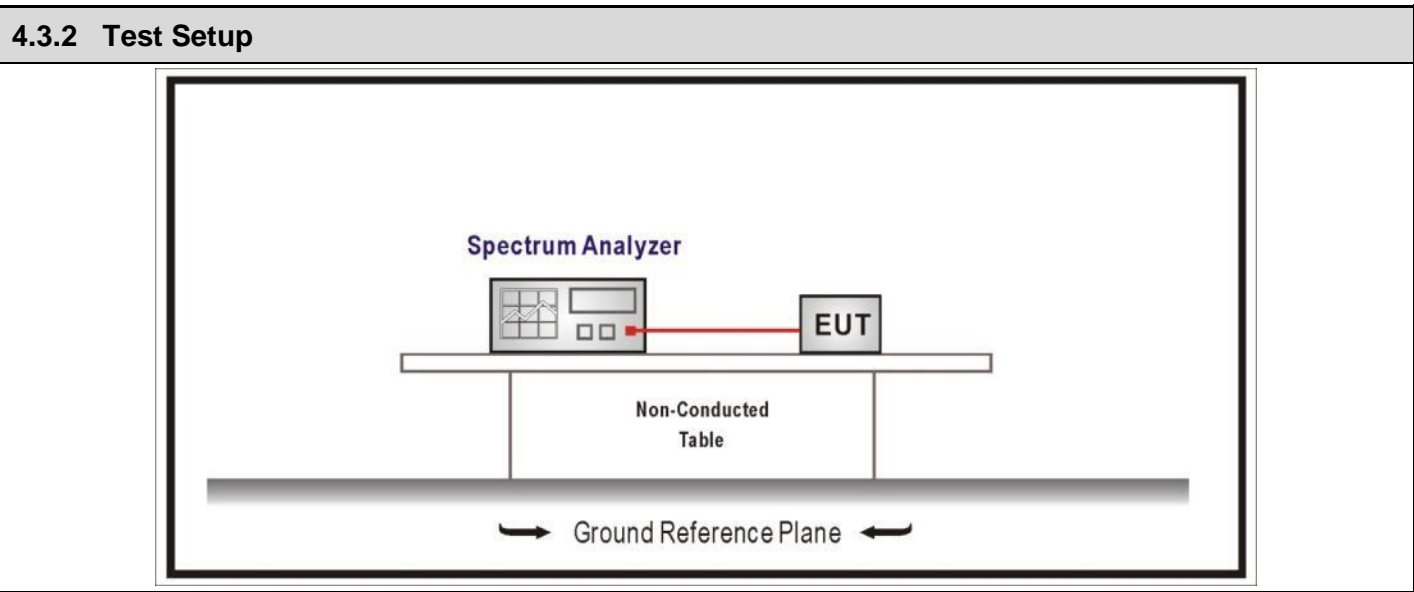

4.3.3 Test Procedure			
References Rule	Chapter	Description	
<input checked="" type="checkbox"/>	ANSI C63.10	11.11	Emissions in non-restricted frequency bands
<input checked="" type="checkbox"/>	ANSI C63.10	11.11.1	General
<input checked="" type="checkbox"/>	ANSI C63.10	11.11.2	Reference level measurement
<input checked="" type="checkbox"/>	ANSI C63.10	11.11.3	Emission level measurement

4.3.4 Test Data

Mode	Channel	Test Frequency (MHz)	Maximum In-Band PSD[a] (dBm/100kHz)	Frequency (MHz)	Out-Band PSD[b] (dBm/100kHz)	[a]-[b] (dB)	Limit (dB)	Result
1	00	2402	6.937	2400	-47.051	53.988	≥20	Pass
	39	2480	5.234	2500	-56.618	61.852	≥20	Pass
2	00	2402	5.445	2400	-24.830	30.275	≥20	Pass
	39	2480	2.741	2500	-55.491	58.232	≥20	Pass

Note: The worst case of emissions in non-restricted frequency bands as below:

Mode 2 CH00(2402MHz)

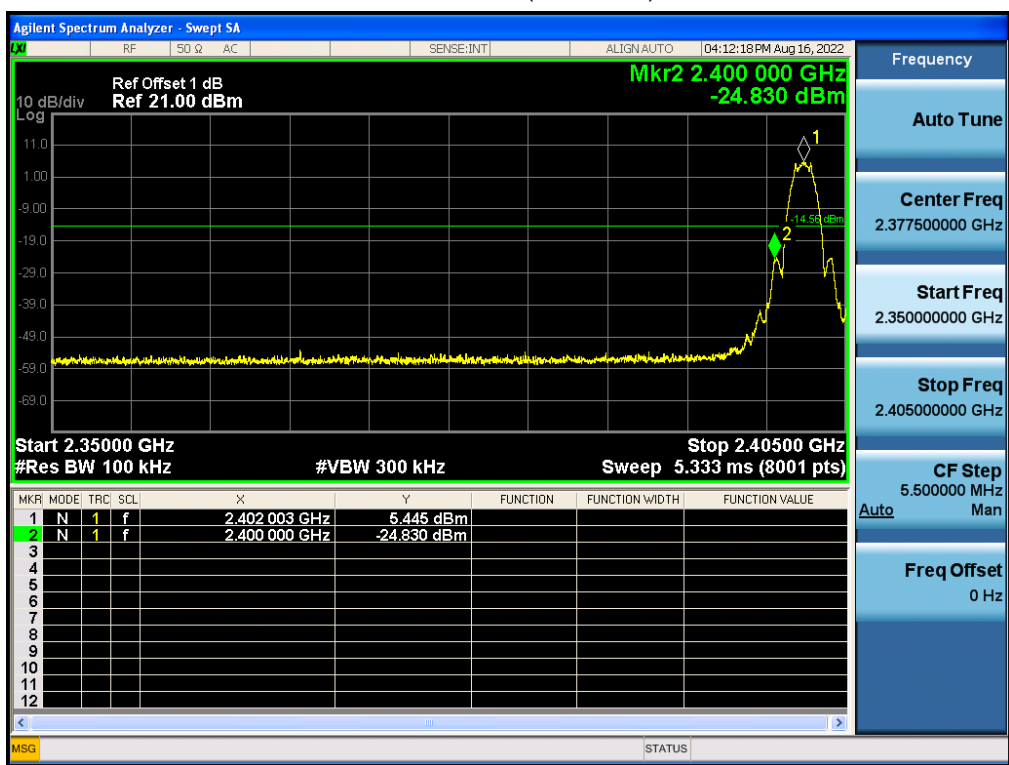

The data of entire corresponding spectrum:

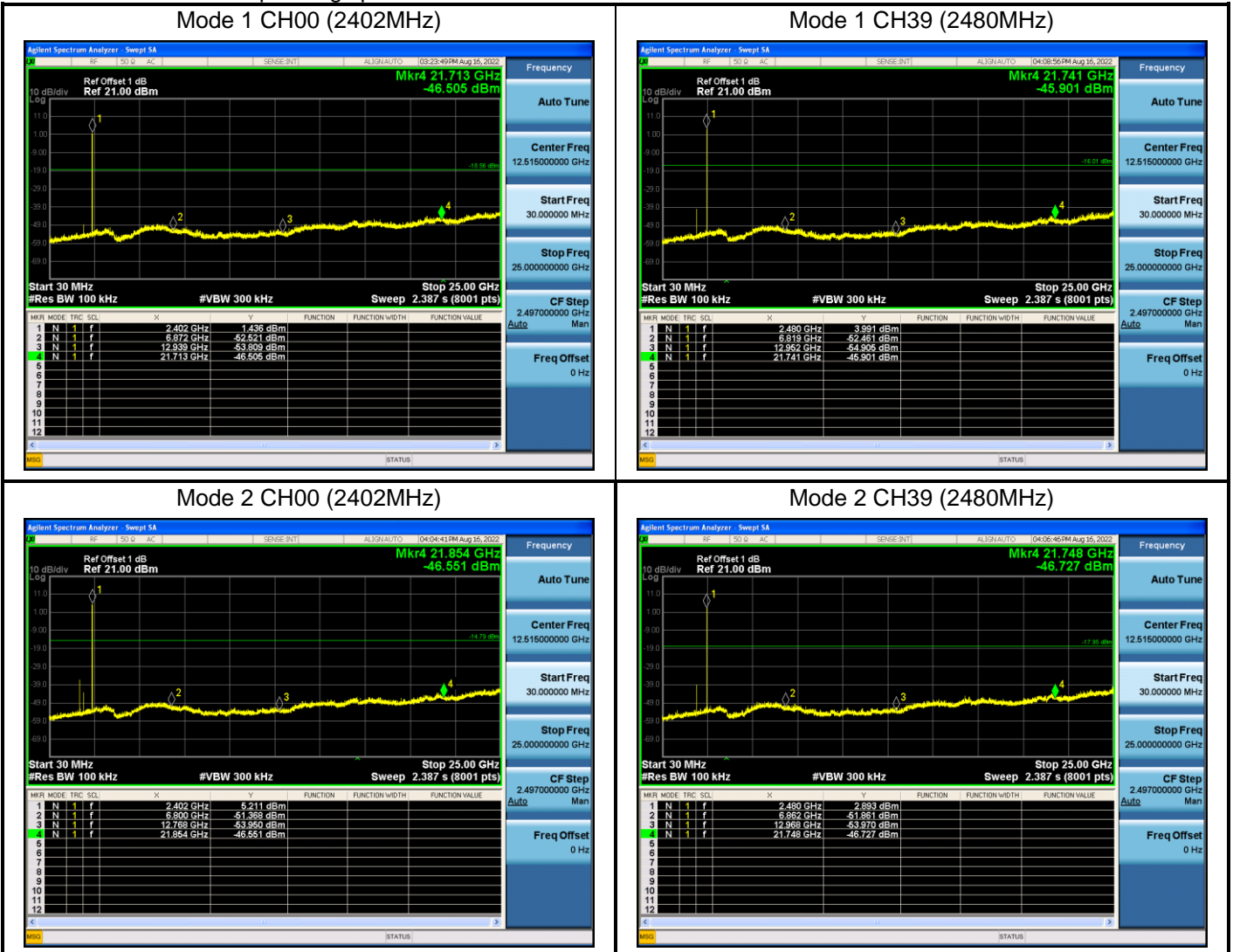

4.4 Duty cycle	VERDICT: PASS
-----------------------	----------------------

4.4.1 Limit
N/A

4.4.2 Test Setup

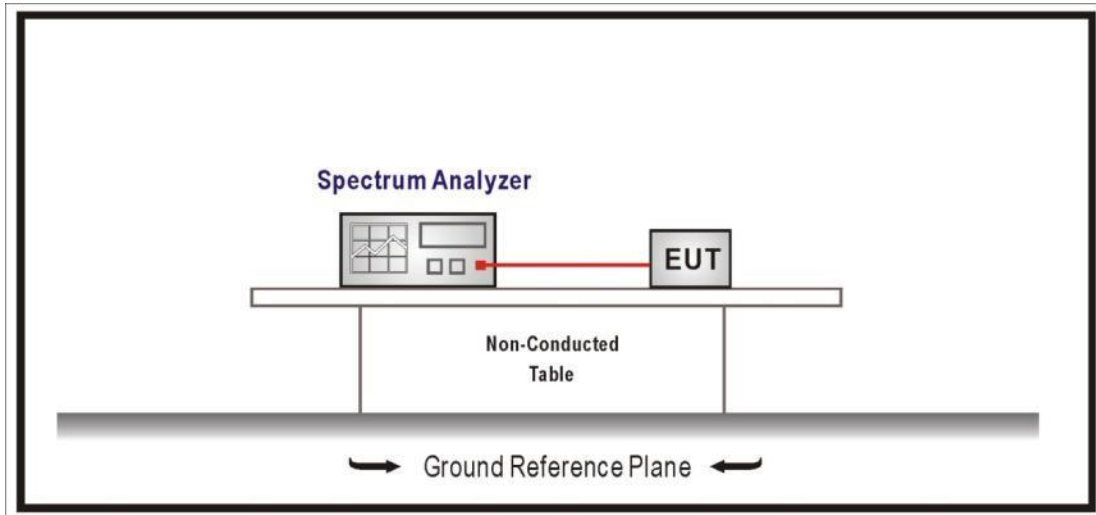

4.4.3 Test Procedure

	References Rule	Chapter	Description
<input checked="" type="checkbox"/>	ANSI C63.10	11.6	Duty cycle (D), transmission duration (T), and maximum power control level

4.4.4 Test Data

Test Mode	Tx On (us)	Tx Off (us)	VBW (Hz)	Tx On + Tx Off (us)	Duty Cycle (%)
Mode 1	N/A	N/A	10	N/A	N/A
Mode 2	N/A	N/A	10	N/A	N/A

Note 1: T means the minimum transmission duration over which the transmitter is on and is transmitting at its maximum power control level for the tested mode of operation.

Note 2: According to KDB 558074, when test for Radiated Emission Band Edge and Radiated Emission, for average detector set: $VBW \geq 1/T$ will be used.

Mode 1 CH19 2440MHz

Mode 2 CH19 2440MHz

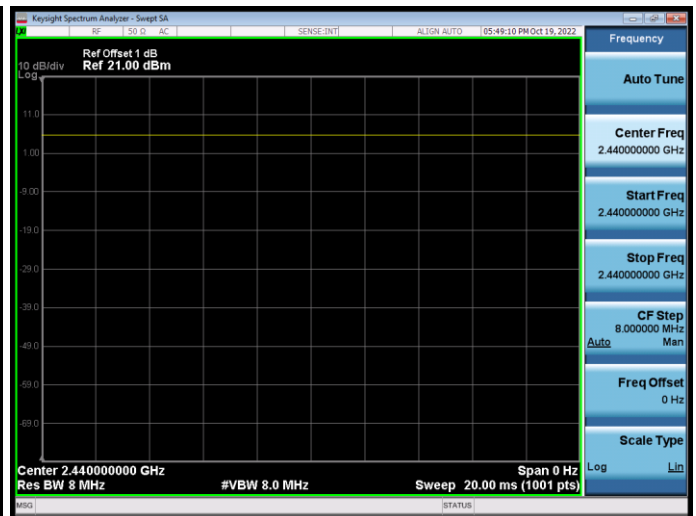

4.5 Band Edge	VERDICT: PASS
----------------------	----------------------

4.5.1 Limit

Standard		FCC Part 15 Subpart C Paragraph 15.247(d) ,15.209		
Frequency bands (MHz)	Detector	Limit (dB μ V/m)	RBW (MHz)	Distance (m)
2310-2390	PK	74	1	3
2483.5-2500	AV	54	1	3

Note: The field strength of emissions appearing within these frequency bands shall not exceed the limits.

4.5.2 Test Setup

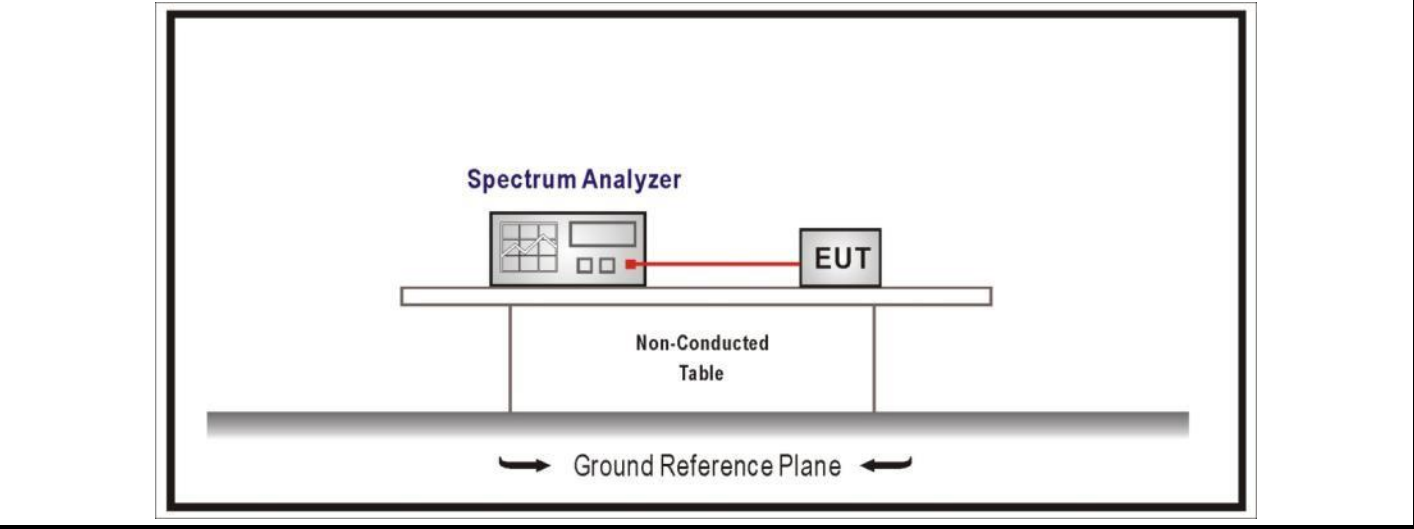

4.5.3 Test Procedure

	References Rule	Chapter	Description
<input checked="" type="checkbox"/>	ANSI C63.10	6.10	Band-edge testing
	<input checked="" type="checkbox"/> ANSI C63.10	6.10.5	Restricted-band band-edge measurements
	<input type="checkbox"/> ANSI C63.10	6.10.6	Marker-delta method
<input checked="" type="checkbox"/>	ANSI C63.10	11.12	Emissions in restricted frequency bands
	<input checked="" type="checkbox"/> ANSI C63.10	11.12.2	Antenna-port conducted measurements
	<input type="checkbox"/> ANSI C63.10	11.12.2.3	Quasi-peak measurement procedure
	<input checked="" type="checkbox"/> ANSI C63.10	11.12.2.4	Peak power measurement procedure
	<input checked="" type="checkbox"/> ANSI C63.10	11.12.2.5	Average power measurement procedures

4.5.4 Test Data

Profile: 22A0151R	Page No.: 25
Engineer: YuLiu	
Site: AC5	Time: 2022/08/15 - 22:29
Limit: FCC_Part15.209_RE(3m)	Margin: 0
Probe: Horn_3117_00167055(1-18GHz)	Polarity: Vertical
EUT: AH80 BLUETOOTH HEADSET DONGLE	Power: DC 5V
Note: Mode1:Transmit at 2402MHz by BLE_1M	

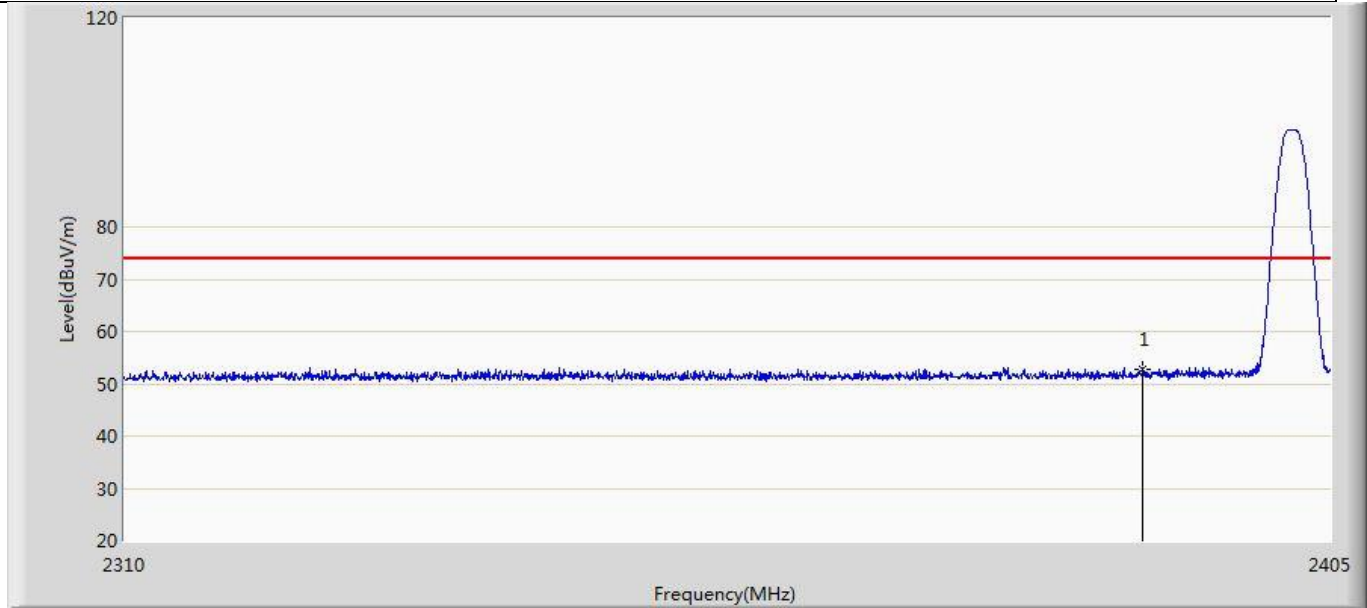

No	Mark	Frequency (MHz)	Measure Level (dBuV/m)	Reading Level (dBuV)	Over Limit (dB)	Limit (dBuV/m)	Factor (dB)	Type
1	*	2390.000	52.725	16.529	-21.275	74.000	36.196	PK

Profile: 22A0151R	Page No.: 26
Engineer: YuLiu	
Site: AC5	Time: 2022/08/15 - 22:31
Limit: FCC_Part15.209_RE(3m)	Margin: 0
Probe: Horn_3117_00167055(1-18GHz)	Polarity: Vertical
EUT: AH80 BLUETOOTH HEADSET DONGLE	Power: DC 5V
Note: Mode1:Transmit at 2402MHz by BLE_1M	

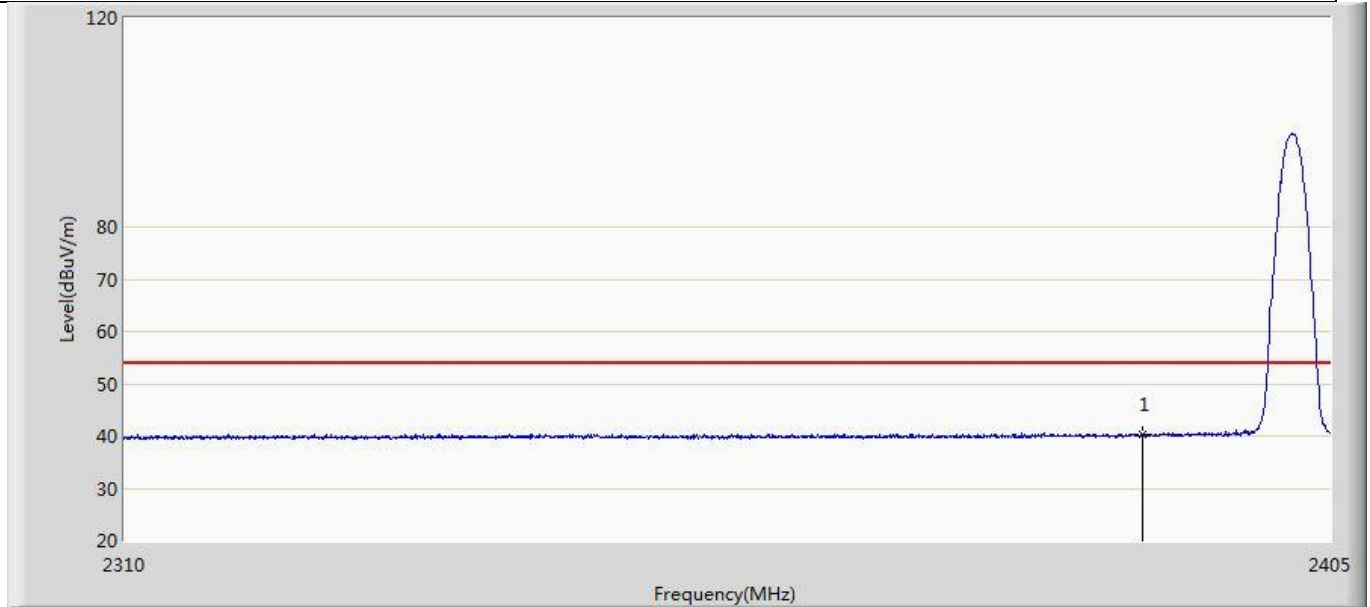

No	Mark	Frequency (MHz)	Measure Level (dBuV/m)	Reading Level (dBuV)	Over Limit (dB)	Limit (dBuV/m)	Factor (dB)	Type
1	*	2390.000	40.156	3.960	-13.844	54.000	36.196	AV

Profile: 22A0151R	Page No.: 27
Engineer: YuLiu	
Site: AC5	Time: 2022/08/15 - 22:33
Limit: FCC_Part15.209_RE(3m)	Margin: 0
Probe: Horn_3117_00167055(1-18GHz)	Polarity: Horizontal
EUT: AH80 BLUETOOTH HEADSET DONGLE	Power: DC 5V
Note: Mode1:Transmit at 2402MHz by BLE_1M	

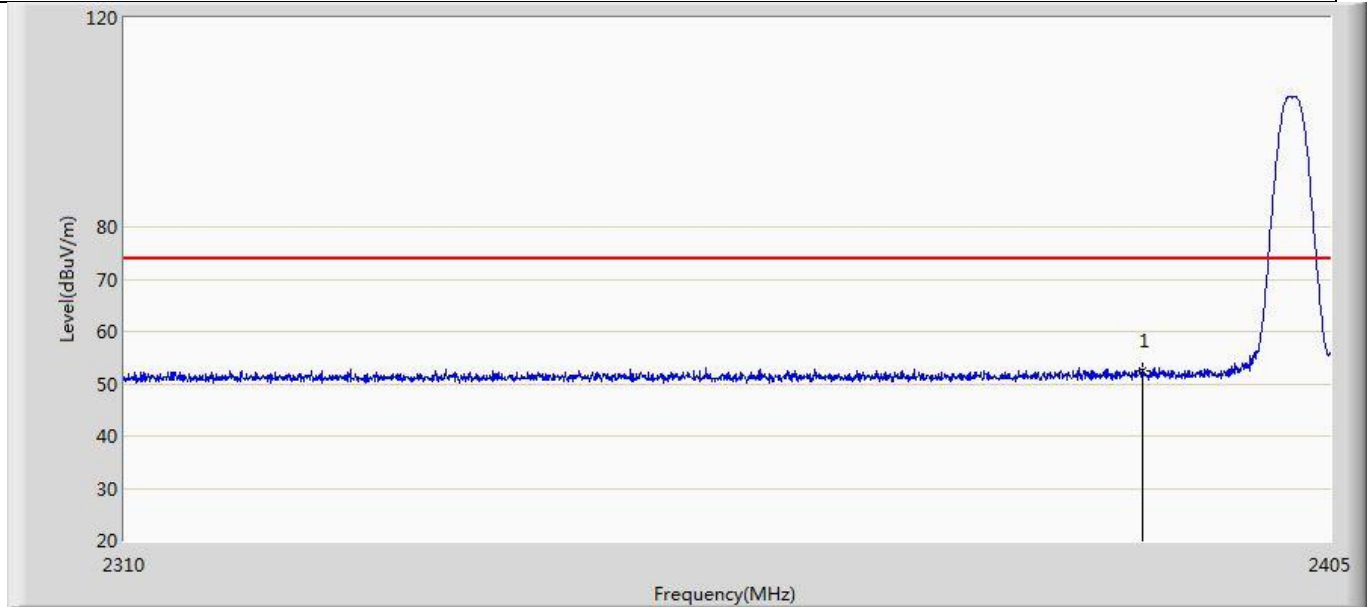

No	Mark	Frequency (MHz)	Measure Level (dBuV/m)	Reading Level (dBuV)	Over Limit (dB)	Limit (dBuV/m)	Factor (dB)	Type
1	*	2390.000	52.402	16.206	-21.598	74.000	36.196	PK

Profile: 22A0151R	Page No.: 28
Engineer: YuLiu	
Site: AC5	Time: 2022/08/15 - 22:34
Limit: FCC_Part15.209_RE(3m)	Margin: 0
Probe: Horn_3117_00167055(1-18GHz)	Polarity: Horizontal
EUT: AH80 BLUETOOTH HEADSET DONGLE	Power: DC 5V
Note: Mode1:Transmit at 2402MHz by BLE_1M	

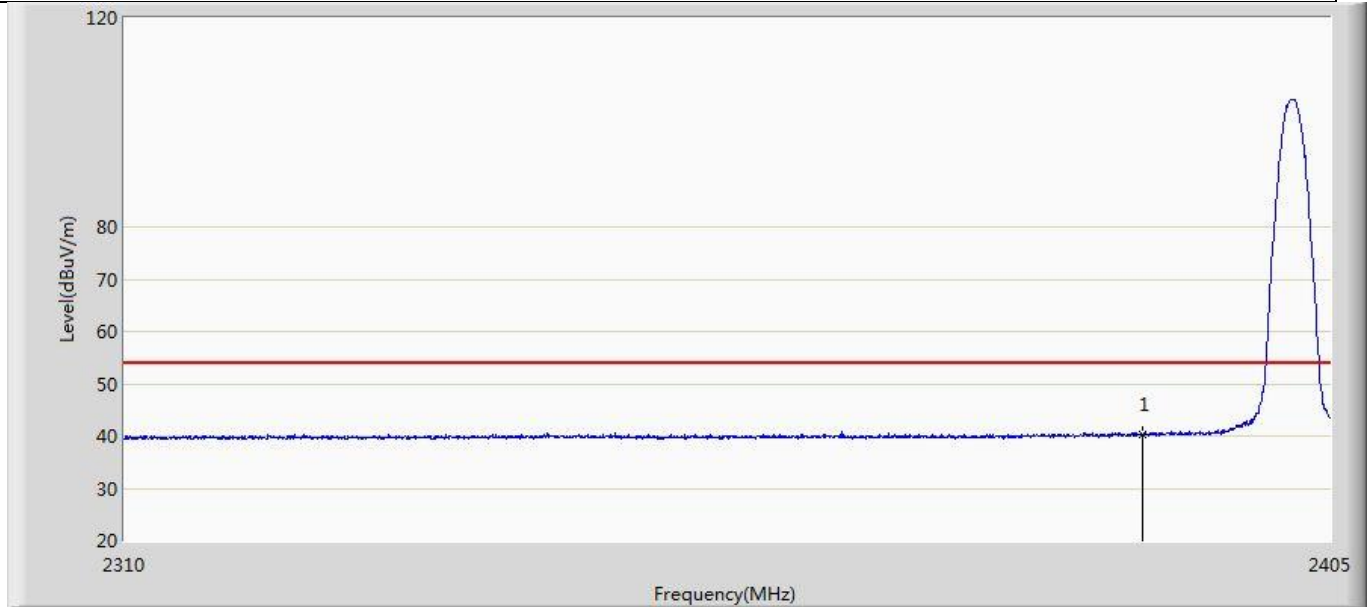

No	Mark	Frequency (MHz)	Measure Level (dBuV/m)	Reading Level (dBuV)	Over Limit (dB)	Limit (dBuV/m)	Factor (dB)	Type
1	*	2390.000	40.357	4.161	-13.643	54.000	36.196	AV

Profile: 22A0151R	Page No.: 29
Engineer: YuLiu	
Site: AC5	Time: 2022/08/15 - 22:36
Limit: FCC_Part15.209_RE(3m)	Margin: 0
Probe: Horn_3117_00167055(1-18GHz)	Polarity: Vertical
EUT: AH80 BLUETOOTH HEADSET DONGLE	Power: DC 5V
Note: Mode1:Transmit at 2480MHz by BLE_1M	

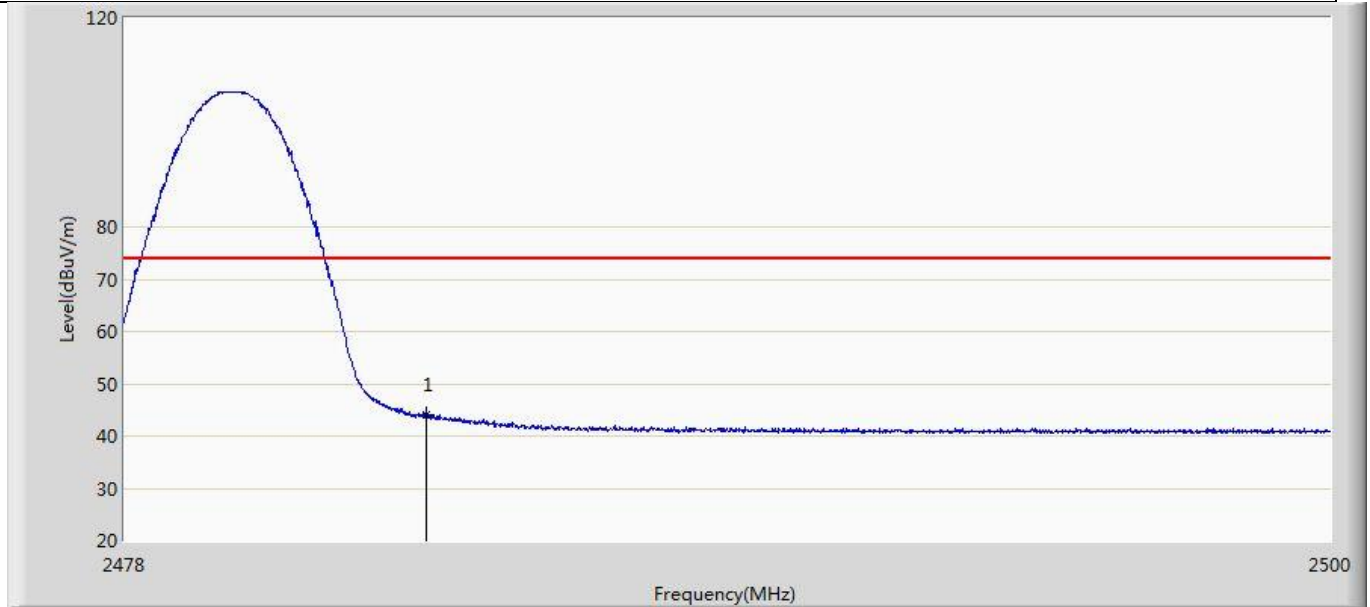

No	Mark	Frequency (MHz)	Measure Level (dBuV/m)	Reading Level (dBuV)	Over Limit (dB)	Limit (dBuV/m)	Factor (dB)	Type
1	*	2483.500	44.014	7.429	-29.986	74.000	36.585	PK

Profile: 22A0151R	Page No.: 30
Engineer: YuLiu	
Site: AC5	Time: 2022/08/15 - 22:39
Limit: FCC_Part15.209_RE(3m)	Margin: 0
Probe: Horn_3117_00167055(1-18GHz)	Polarity: Vertical
EUT: AH80 BLUETOOTH HEADSET DONGLE	Power: DC 5V
Note: Mode1:Transmit at 2480MHz by BLE_1M	

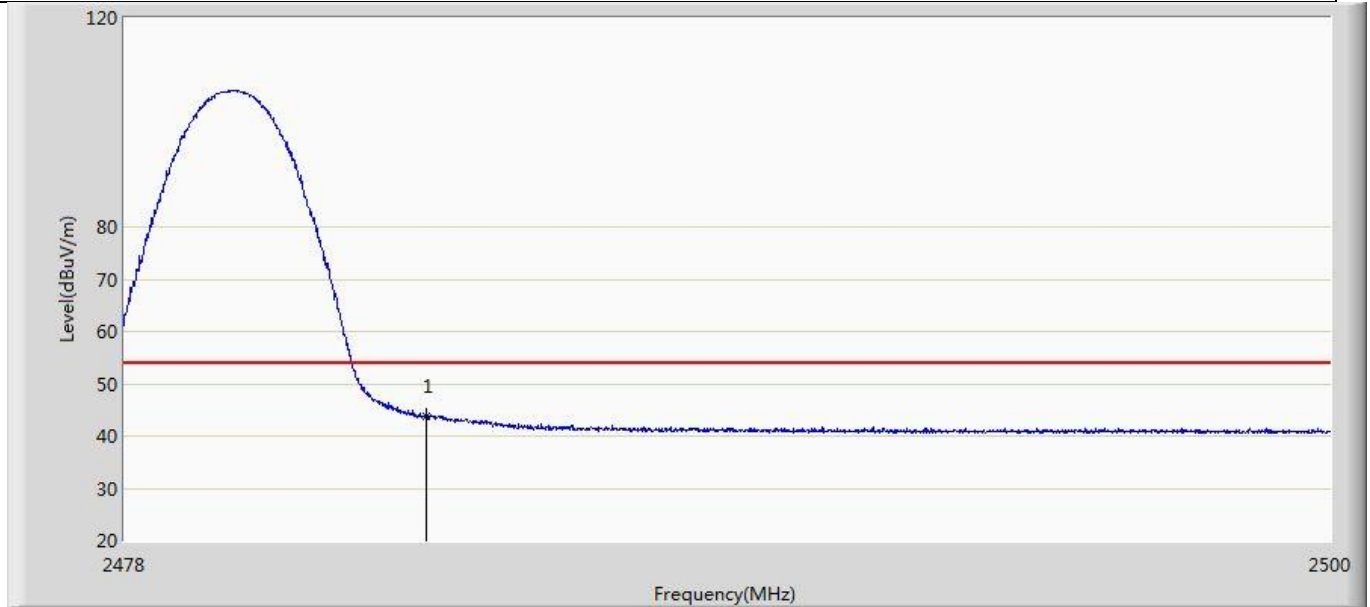

No	Mark	Frequency (MHz)	Measure Level (dBuV/m)	Reading Level (dBuV)	Over Limit (dB)	Limit (dBuV/m)	Factor (dB)	Type
1	*	2483.500	43.650	7.065	-10.350	54.000	36.585	AV

Profile: 22A0151R	Page No.: 31
Engineer: YuLiu	
Site: AC5	Time: 2022/08/15 - 22:40
Limit: FCC_Part15.209_RE(3m)	Margin: 0
Probe: Horn_3117_00167055(1-18GHz)	Polarity: Horizontal
EUT: AH80 BLUETOOTH HEADSET DONGLE	Power: DC 5V
Note: Mode1:Transmit at 2480MHz by BLE_1M	

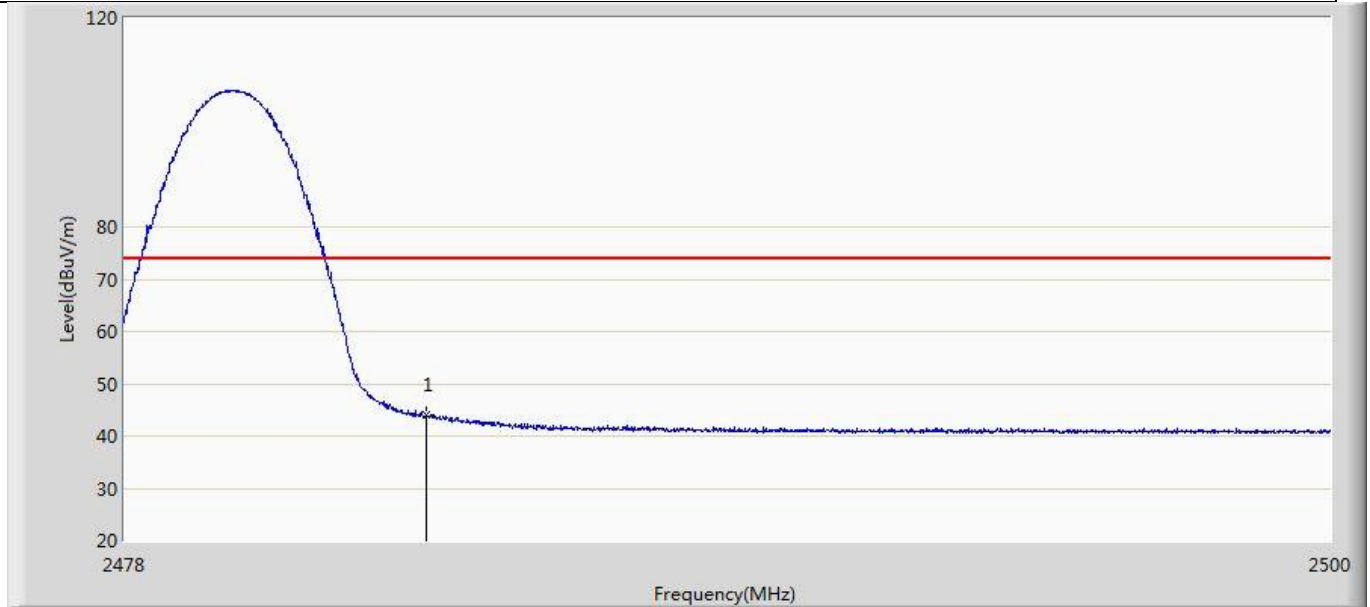

No	Mark	Frequency (MHz)	Measure Level (dBuV/m)	Reading Level (dBuV)	Over Limit (dB)	Limit (dBuV/m)	Factor (dB)	Type
1	*	2483.500	43.965	7.380	-30.035	74.000	36.585	PK

Profile: 22A0151R	Page No.: 32
Engineer: YuLiu	
Site: AC5	Time: 2022/08/15 - 22:41
Limit: FCC_Part15.209_RE(3m)	Margin: 0
Probe: Horn_3117_00167055(1-18GHz)	Polarity: Horizontal
EUT: AH80 BLUETOOTH HEADSET DONGLE	Power: DC 5V
Note: Mode1:Transmit at 2480MHz by BLE_1M	

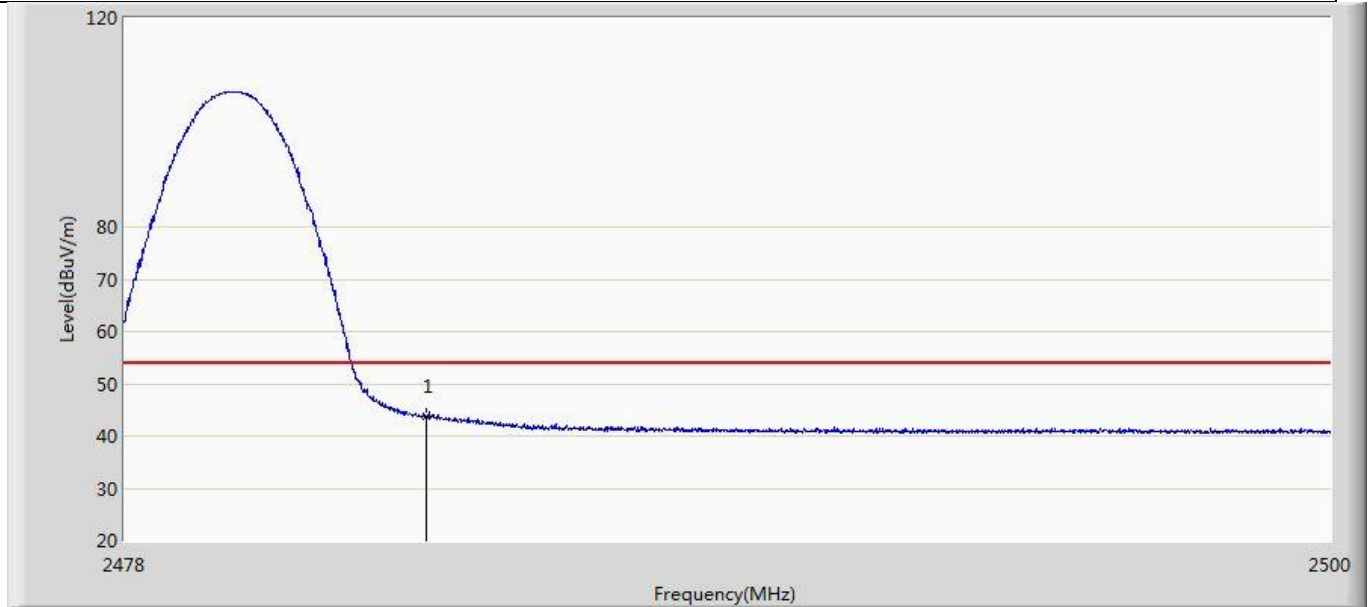

No	Mark	Frequency (MHz)	Measure Level (dBuV/m)	Reading Level (dBuV)	Over Limit (dB)	Limit (dBuV/m)	Factor (dB)	Type
1	*	2483.500	43.896	7.311	-10.104	54.000	36.585	AV

Profile: 22A0151R	Page No.: 33
Engineer: YuLiu	
Site: AC5	Time: 2022/08/15 - 22:44
Limit: FCC_Part15.209_RE(3m)	Margin: 0
Probe: Horn_3117_00167055(1-18GHz)	Polarity: Vertical
EUT: AH80 BLUETOOTH HEADSET DONGLE	Power: DC 5V
Note: Mode2:Transmit at 2402MHz by BLE_2M	

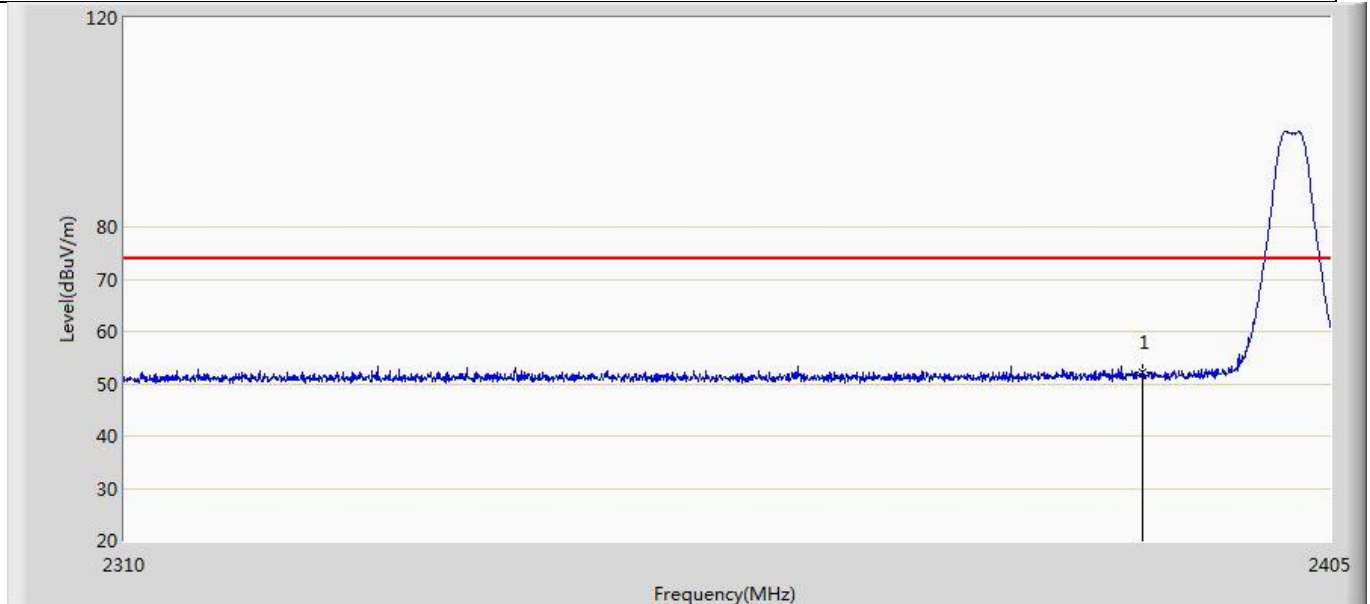

No	Mark	Frequency (MHz)	Measure Level (dBuV/m)	Reading Level (dBuV)	Over Limit (dB)	Limit (dBuV/m)	Factor (dB)	Type
1	*	2390.000	52.315	16.119	-21.685	74.000	36.196	PK

Profile: 22A0151R	Page No.: 34
Engineer: YuLiu	
Site: AC5	Time: 2022/08/15 - 22:46
Limit: FCC_Part15.209_RE(3m)	Margin: 0
Probe: Horn_3117_00167055(1-18GHz)	Polarity: Vertical
EUT: AH80 BLUETOOTH HEADSET DONGLE	Power: DC 5V
Note: Mode2:Transmit at 2402MHz by BLE_2M	

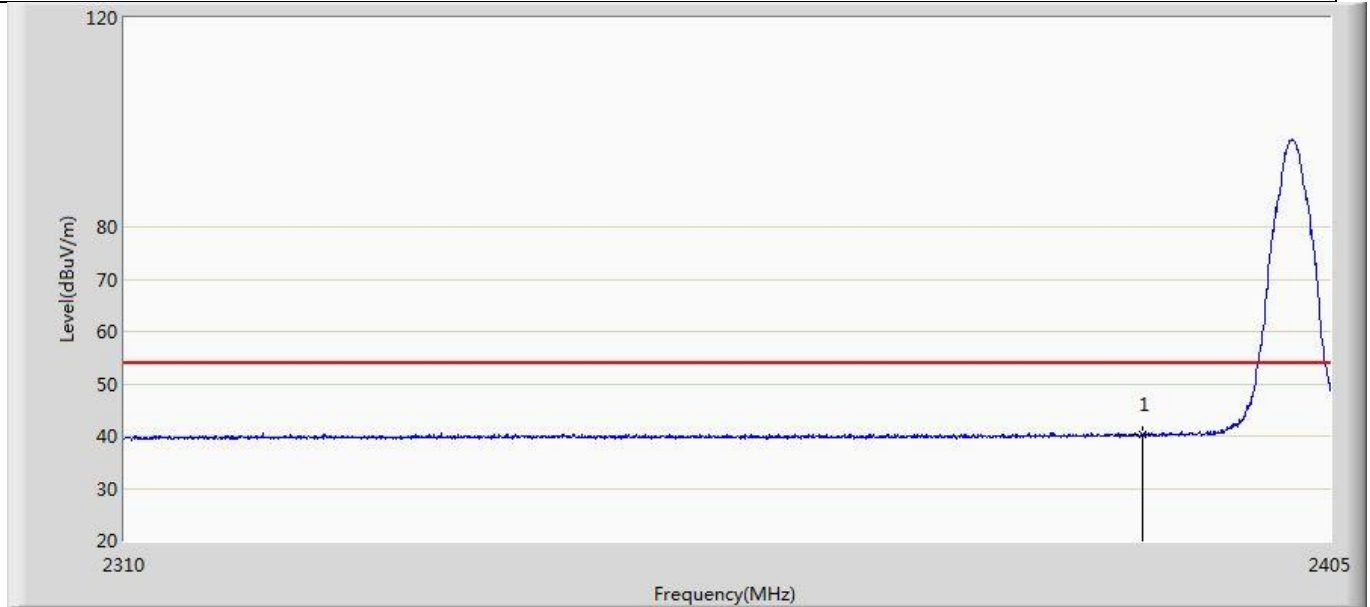

No	Mark	Frequency (MHz)	Measure Level (dBuV/m)	Reading Level (dBuV)	Over Limit (dB)	Limit (dBuV/m)	Factor (dB)	Type
1	*	2390.000	40.156	3.960	-13.844	54.000	36.196	AV

Profile: 22A0151R	Page No.: 35
Engineer: YuLiu	
Site: AC5	Time: 2022/08/15 - 22:47
Limit: FCC_Part15.209_RE(3m)	Margin: 0
Probe: Horn_3117_00167055(1-18GHz)	Polarity: Horizontal
EUT: AH80 BLUETOOTH HEADSET DONGLE	Power: DC 5V
Note: Mode2:Transmit at 2402MHz by BLE_2M	

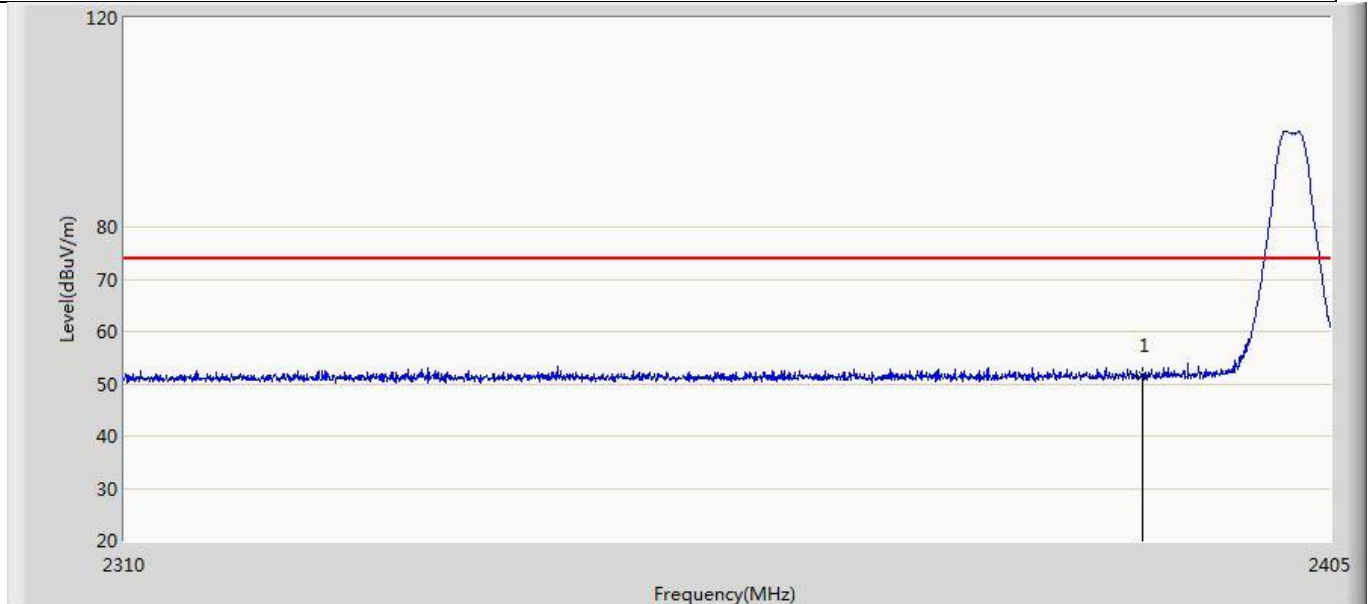

No	Mark	Frequency (MHz)	Measure Level (dBuV/m)	Reading Level (dBuV)	Over Limit (dB)	Limit (dBuV/m)	Factor (dB)	Type
1	*	2390.000	51.645	15.449	-22.355	74.000	36.196	PK

Profile: 22A0151R	Page No.: 36
Engineer: YuLiu	
Site: AC5	Time: 2022/08/15 - 22:48
Limit: FCC_Part15.209_RE(3m)	Margin: 0
Probe: Horn_3117_00167055(1-18GHz)	Polarity: Horizontal
EUT: AH80 BLUETOOTH HEADSET DONGLE	Power: DC 5V
Note: Mode2:Transmit at 2402MHz by BLE_2M	

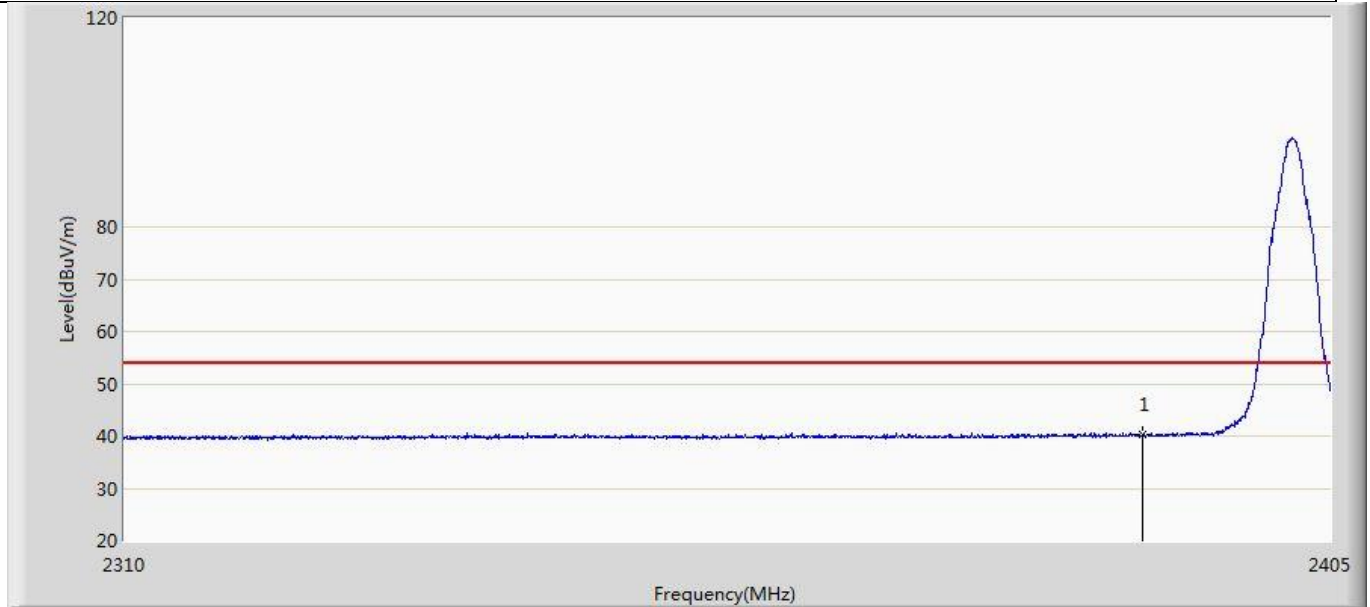

No	Mark	Frequency (MHz)	Measure Level (dBuV/m)	Reading Level (dBuV)	Over Limit (dB)	Limit (dBuV/m)	Factor (dB)	Type
1	*	2390.000	40.208	4.012	-13.792	54.000	36.196	AV

Profile: 22A0151R	Page No.: 37
Engineer: YuLiu	
Site: AC5	Time: 2022/08/15 - 22:50
Limit: FCC_Part15.209_RE(3m)	Margin: 0
Probe: Horn_3117_00167055(1-18GHz)	Polarity: Vertical
EUT: AH80 BLUETOOTH HEADSET DONGLE	Power: DC 5V
Note: Mode2:Transmit at 2480MHz by BLE_2M	

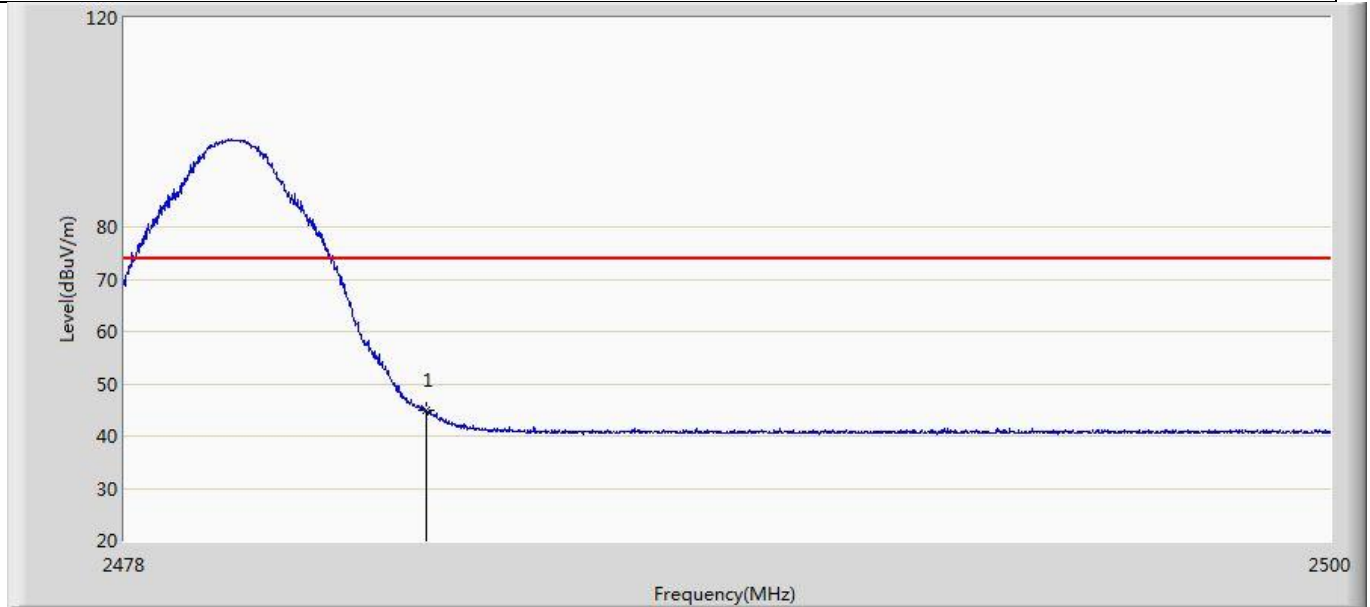

No	Mark	Frequency (MHz)	Measure Level (dBuV/m)	Reading Level (dBuV)	Over Limit (dB)	Limit (dBuV/m)	Factor (dB)	Type
1	*	2483.500	44.802	8.217	-29.198	74.000	36.585	PK

Profile: 22A0151R	Page No.: 38
Engineer: YuLiu	
Site: AC5	Time: 2022/08/15 - 22:52
Limit: FCC_Part15.209_RE(3m)	Margin: 0
Probe: Horn_3117_00167055(1-18GHz)	Polarity: Vertical
EUT: AH80 BLUETOOTH HEADSET DONGLE	Power: DC 5V
Note: Mode2:Transmit at 2480MHz by BLE_2M	

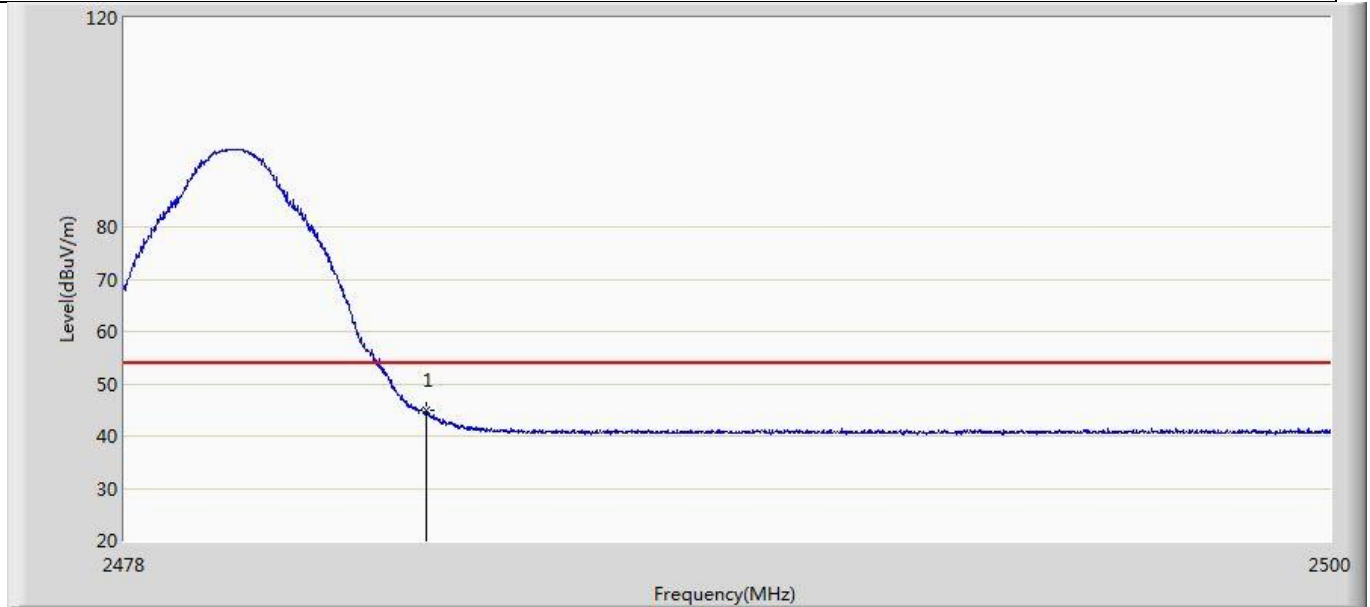

No	Mark	Frequency (MHz)	Measure Level (dBuV/m)	Reading Level (dBuV)	Over Limit (dB)	Limit (dBuV/m)	Factor (dB)	Type
1	*	2483.500	45.036	8.451	-8.964	54.000	36.585	AV

Profile: 22A0151R	Page No.: 39
Engineer: YuLiu	
Site: AC5	Time: 2022/08/15 - 22:53
Limit: FCC_Part15.209_RE(3m)	Margin: 0
Probe: Horn_3117_00167055(1-18GHz)	Polarity: Horizontal
EUT: AH80 BLUETOOTH HEADSET DONGLE	Power: DC 5V
Note: Mode2:Transmit at 2480MHz by BLE_2M	

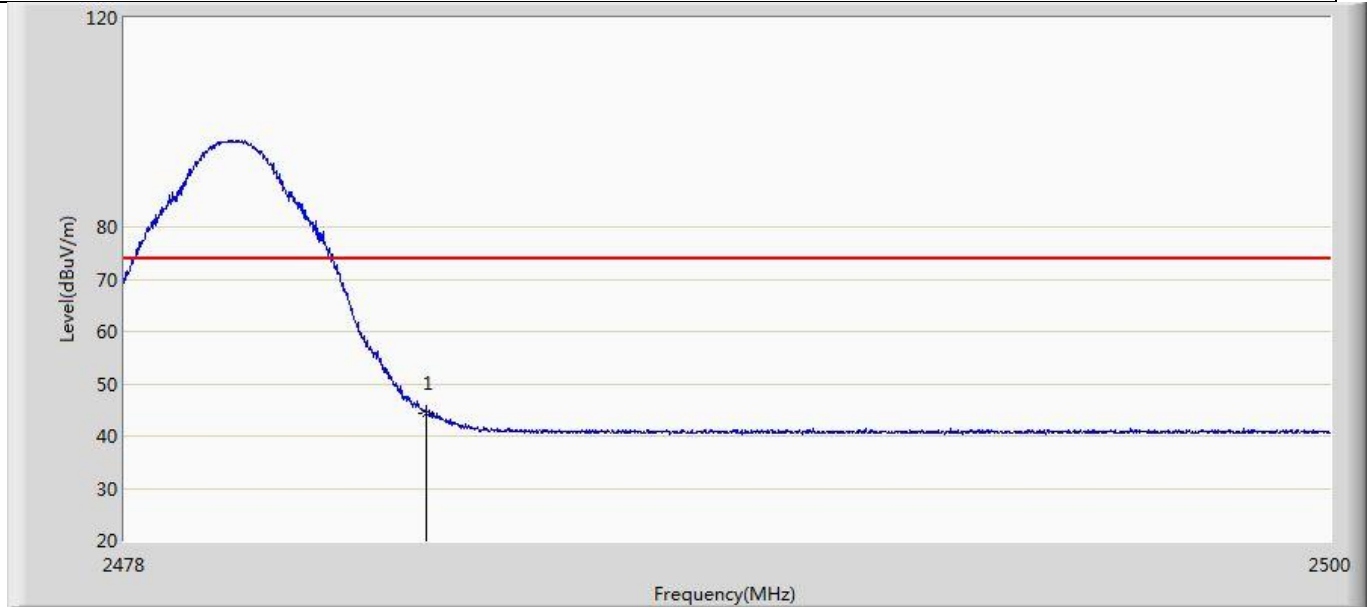

No	Mark	Frequency (MHz)	Measure Level (dBuV/m)	Reading Level (dBuV)	Over Limit (dB)	Limit (dBuV/m)	Factor (dB)	Type
1	*	2483.500	44.365	7.780	-29.635	74.000	36.585	PK

Profile: 22A0151R	Page No.: 40
Engineer: YuLiu	
Site: AC5	Time: 2022/08/15 - 22:54
Limit: FCC_Part15.209_RE(3m)	Margin: 0
Probe: Horn_3117_00167055(1-18GHz)	Polarity: Horizontal
EUT: AH80 BLUETOOTH HEADSET DONGLE	Power: DC 5V
Note: Mode2:Transmit at 2480MHz by BLE_2M	

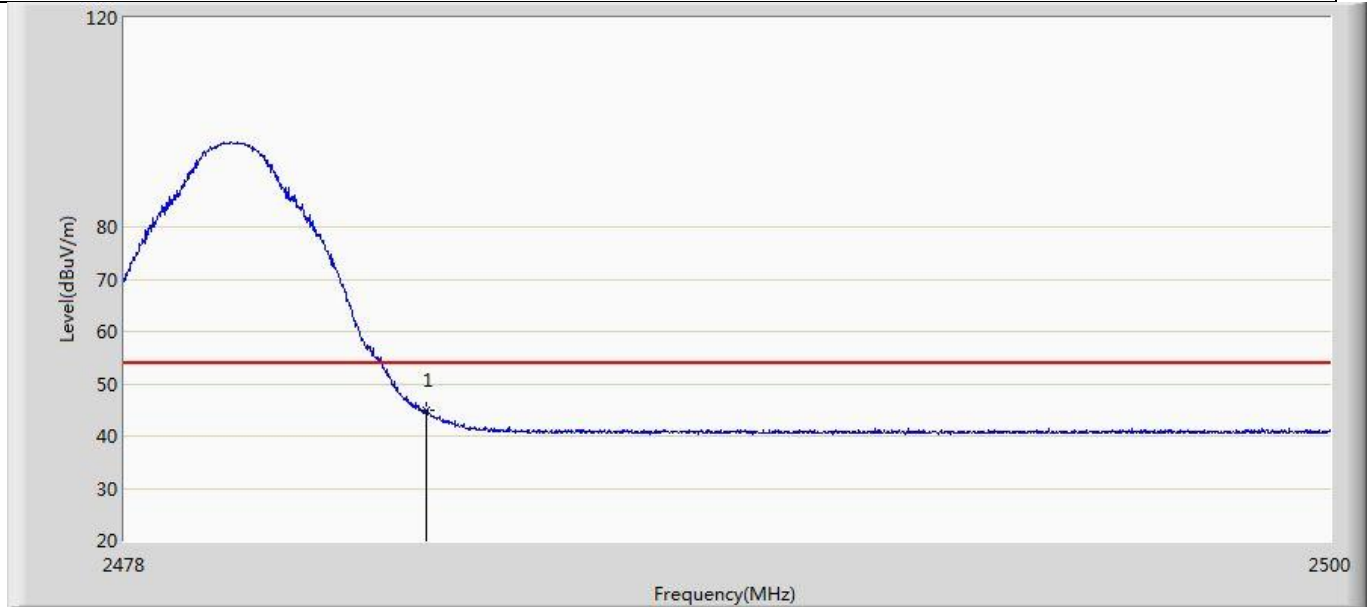

No	Mark	Frequency (MHz)	Measure Level (dBuV/m)	Reading Level (dBuV)	Over Limit (dB)	Limit (dBuV/m)	Factor (dB)	Type
1	*	2483.500	44.920	8.335	-9.080	54.000	36.585	AV

4.6 DTS Bandwidth	VERDICT: PASS
--------------------------	----------------------

4.6.1 Limit	
Standard	FCC Part 15 Subpart C Paragraph 15.247 (a)(2)
Systems using digital modulation techniques operate in the 2400-2483.5 MHz. The minimum 6 dB bandwidth shall be at least 500 kHz	

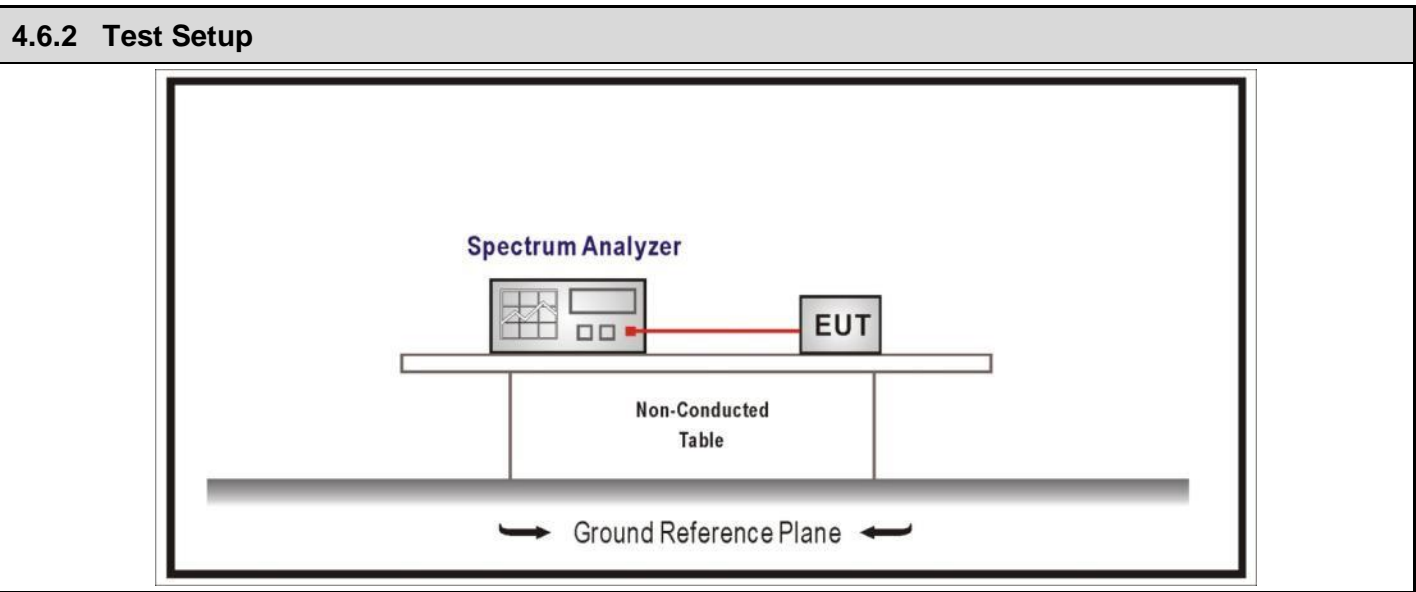

4.6.3 Test Procedure			
	Reference Rule	Chapter	Description
<input checked="" type="checkbox"/>	ANSI C63.10	11.8	DTS bandwidth
<input type="checkbox"/>	ANSI C63.10	11.8.1	Option 1
<input checked="" type="checkbox"/>	ANSI C63.10	11.8.2	Option 2

4.6.4 Test Data						
Mode	CH.	Test Freq. (MHz)	99% Occupied Bandwidth (MHz)	6dB Occupied Bandwidth (kHz)	Limit (kHz)	Result
1	00	2402	1.0455	721.7	>500	Pass
	19	2440	1.0539	714.1	>500	Pass
	39	2480	1.0500	705.4	>500	Pass
2	00	2402	2.0944	1499	>500	Pass
	19	2440	2.0881	1481	>500	Pass
	39	2480	2.0804	1404	>500	Pass

Note : The worst case of Occupied Bandwidth as below:

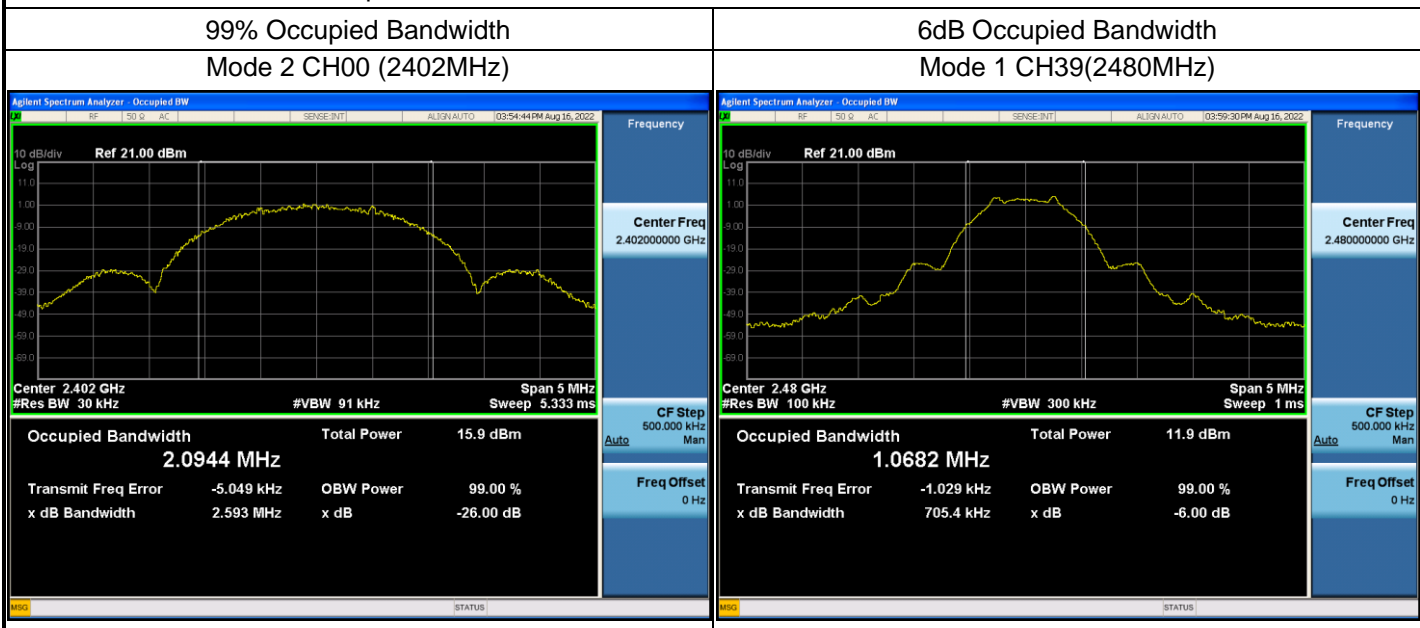

4.7 Fundamental emission output power	VERDICT: PASS
--	----------------------

4.7.1 Limit		
Standard	FCC Part 15 Subpart C Paragraph 15.247 (b)(3)	
<input checked="" type="checkbox"/>	GTX < 6dBi	Pout ≤ 30dBm
<input type="checkbox"/>	GTX > 6dBi	
<input type="checkbox"/>	Non-Fix point-point	Pout ≤ 30 - (GTX - 6)
<input type="checkbox"/>	Fix point-point	Pout ≤ 30 - [(GTX - 6)]/3
<input type="checkbox"/>	Point-to-multipoint	Pout ≤ 30 - (GTX - 6)
<input type="checkbox"/>	Overlap Beams	Pout ≤ 30 - [(GTX - 6)]/3
<input type="checkbox"/>	Aggregate power transmitted simultaneously on all beams	Pout ≤ 30 - [(GTX - 6)]/3
<input type="checkbox"/>	single directional beam	Pout ≤ 30 - [(GTX - 6)]/3 + 8dB
<p>Note 1 : GTX directional gain of transmitting antennas.</p> <p>Note 2 : Pout is maximum peak conducted output power .</p>		

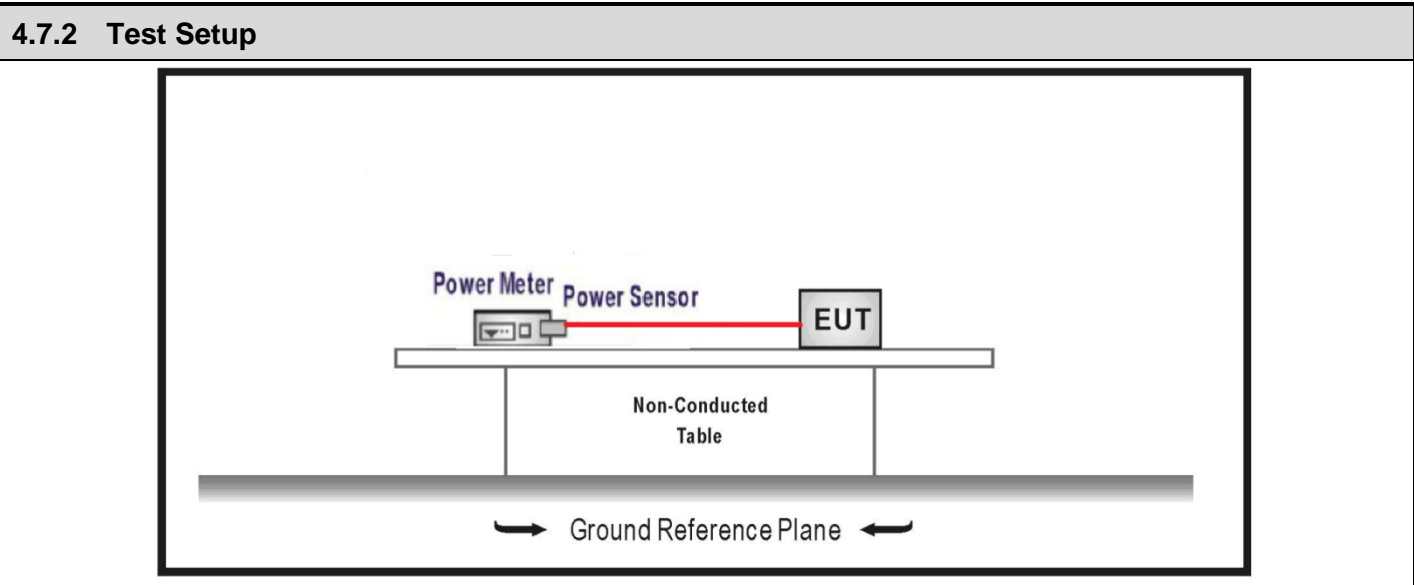

4.7.3 Test Procedure					
	References Rule		Chapter	Description	
<input checked="" type="checkbox"/>	ANSI C63.10		11.9	Fundamental emission output power	
	<input checked="" type="checkbox"/>	ANSI C63.10		11.9.1 Maximum peak conducted output power	
		<input type="checkbox"/>	ANSI C63.10	11.9.1.1 RBW \geq DTS bandwidth	
		<input type="checkbox"/>	ANSI C63.10	11.9.1.2 Integrated band power method	
		<input checked="" type="checkbox"/>	ANSI C63.10	11.9.1.3 PKPM1 Peak power meter method	
	<input type="checkbox"/>	ANSI C63.10		11.9.2 Maximum conducted (average) output power	
		<input type="checkbox"/>	ANSI C63.10		11.9.2.2 Measurement using a spectrum analyzer (SA)
			<input type="checkbox"/>	ANSI C63.10	11.9.2.2.2 Method AVGSA-1(Duty cycle \geq 98%)
			<input type="checkbox"/>	ANSI C63.10	11.9.2.2.3 Method AVGSA-1A(Duty cycle \geq 98%)
			<input type="checkbox"/>	ANSI C63.10	11.9.2.2.4 Method AVGSA-2(Duty cycle \leq 98%)
			<input type="checkbox"/>	ANSI C63.10	11.9.2.2.5 Method AVGSA-2A(Duty cycle \leq 98%)
			<input type="checkbox"/>	ANSI C63.10	11.9.2.2.4 Method AVGSA-3
			<input type="checkbox"/>	ANSI C63.10	11.9.2.2.5 Method AVGSA-3A
		<input type="checkbox"/>	ANSI C63.10		11.9.2.3 Measurement using a power meter (PM)
			<input type="checkbox"/>	ANSI C63.10	11.9.2.3.1 Method AVGPM
	<input type="checkbox"/>		ANSI C63.10	11.9.2.3.2 Method AVGPM-G	

4.7.4 Test Data

Mode	Channel	Test Frequency (MHz)	Conducted Power (dBm)	Conducted Power Limit (dBm)	Result
Mode 1	00	2402	7.24	≤30	Pass
	19	2440	6.17	≤30	Pass
	39	2480	5.55	≤30	Pass
Mode 2	00	2402	7.35	≤30	Pass
	19	2440	6.26	≤30	Pass
	39	2480	5.65	≤30	Pass

Power setting parameter:

Mode	Channel	Test Frequency (MHz)	Power setting
Mode 1	00	2402	6
	19	2440	6
	39	2480	6
Mode 2	00	2402	6
	19	2440	6
	39	2480	6

4.8 Power Density	VERDICT: PASS
--------------------------	----------------------

4.8.1 Limit:	
Standard	FCC Part 15 Subpart C Paragraph 15.247 (b)(3)
Power Spectral Density $\leq 8\text{dBm}/3\text{kHz}$	

4.8.2 Test Setup

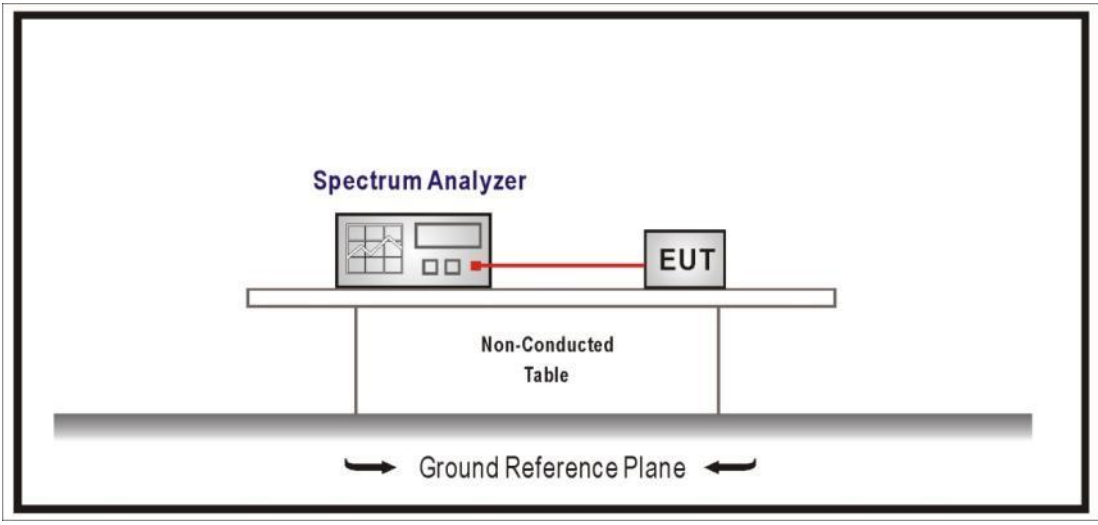

4.8.3 Test Procedure

	References Rule	Chapter	Description
<input checked="" type="checkbox"/>	ANSI C63.10	11.10	Maximum power spectral density level in the fundamental emission
<input checked="" type="checkbox"/>	ANSI C63.10	11.10.2	Method PKPSD (peak PSD)
<input type="checkbox"/>	ANSI C63.10	11.10.3	Method AVGPSD-1(Duty cycle $\geq 98\%$)
<input type="checkbox"/>	ANSI C63.10	11.10.4	Method AVGPSD-1A(Duty cycle $\geq 98\%$)
<input type="checkbox"/>	ANSI C63.10	11.10.5	Method AVGPSD-2(Duty cycle $< 98\%$)
<input type="checkbox"/>	ANSI C63.10	11.10.6	Method AVGPSD-2A(Duty cycle $< 98\%$)
<input type="checkbox"/>	ANSI C63.10	11.10.7	Method AVGPSD-3
<input type="checkbox"/>	ANSI C63.10	11.10.8	Method AVGPSD-3A

4.8.4 Test Data

Mode	Channel	Test Frequency (MHz)	Measurement PSD (dBm/3kHz)	Limit (dBm/3kHz)	Result
Mode 1	00	2402	-4.901	≤8	Pass
	19	2440	-5.881	≤8	Pass
	39	2480	-7.079	≤8	Pass
Mode 2	00	2402	-8.255	≤8	Pass
	19	2440	-8.297	≤8	Pass
	39	2480	-9.741	≤8	Pass

Note : The worst case of PSD as below:

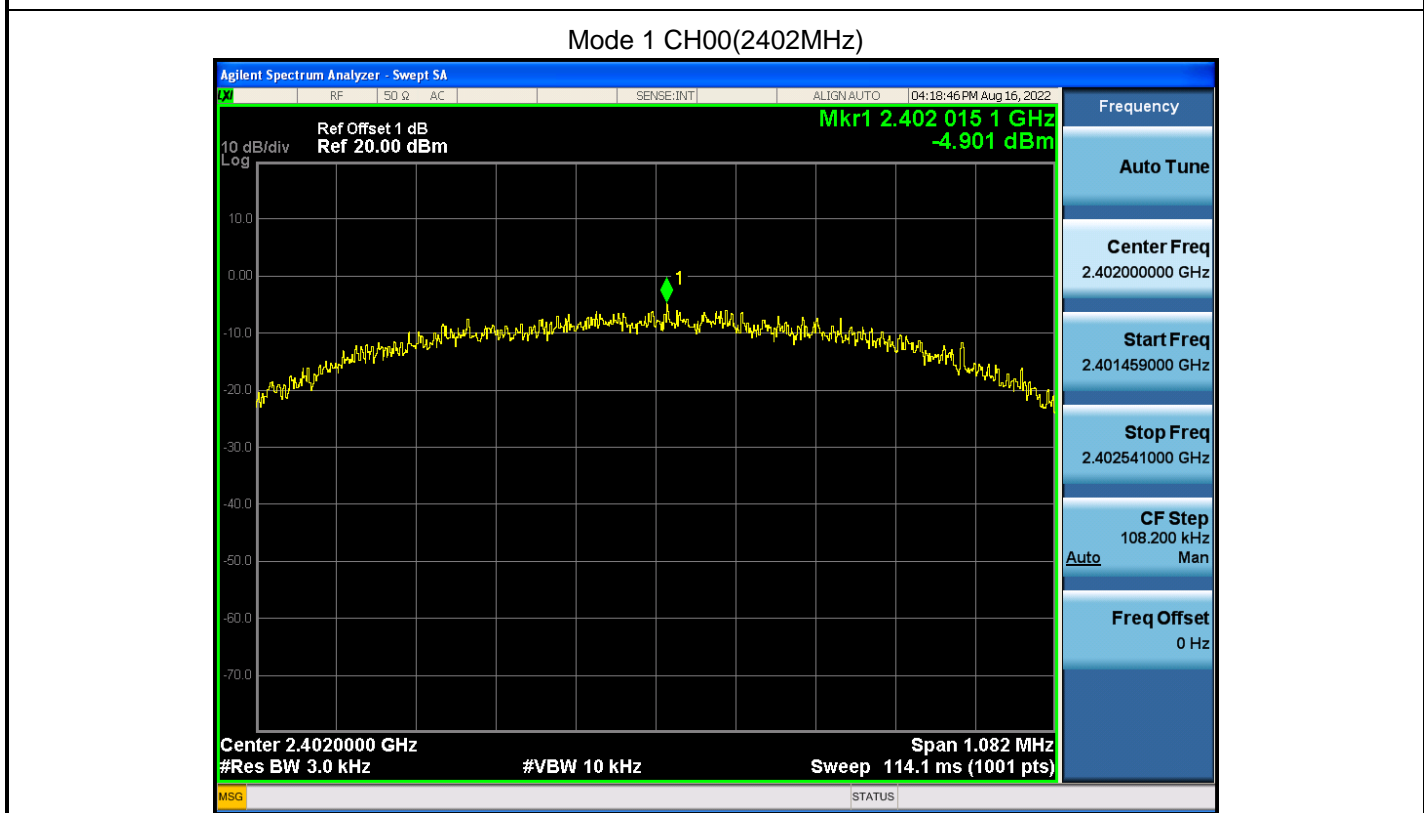

4.9 Antenna Requirement	VERDICT: PASS
--------------------------------	----------------------

4.9.1 Limit:	
Standard	FCC Part 15 Subpart C Paragraph 15.203
<p>An intentional radiator shall be designed to ensure that no antenna other than that furnished by the responsible party shall be used with the device. The use of a permanently attached antenna or of an antenna that uses a unique coupling to the intentional radiator shall be considered sufficient to comply with the provisions of this section. The manufacturer may design the unit so that a broken antenna can be replaced by the user, but the use of a standard antenna jack or electrical connector is prohibited. This requirement does not apply to carrier current devices or to devices operated under the provisions of §15.211, §15.213, §15.217, §15.219, or §15.221. Further, this requirement does not apply to intentional radiators that must be professionally installed, such as perimeter protection systems and some field disturbance sensors, or to other intentional radiators which, in accordance with §15.31(d), must be measured at the installation site. However, the installer shall be responsible for ensuring that the proper antenna is employed so that the limits in this part are not exceeded.</p>	

4.9.2 Antenna Connector Construction:	
<input checked="" type="checkbox"/>	The use of a permanently attached antenna
<input type="checkbox"/>	The antenna use of a unique coupling to the intentional radiator
<input type="checkbox"/>	The use of a nonstandard antenna jack or electrical connector
Please refer to the attached document "Internal Photograph" to show the antenna connector.	

5 TEST SETUP PHOTO AND EUT PHOTO

Remark: The test setup photo and EUT Photo please see appendix.

_____ The End _____