

SYLVANIA

WIFI SPEAKER WITH AMAZON ALEXA VOICE

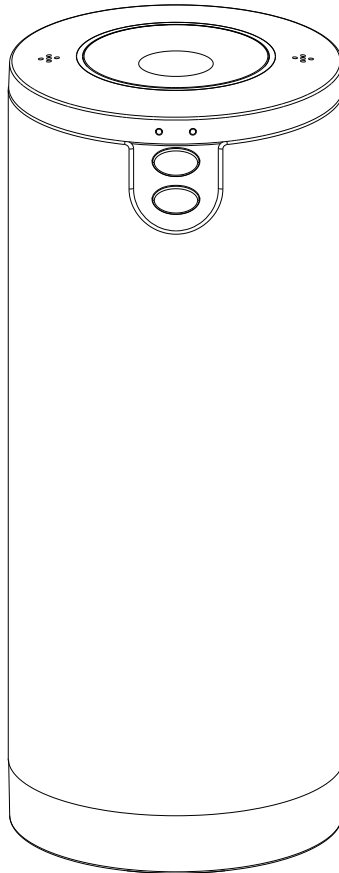

MODEL: SP5775

**PLEASE READ CAREFULLY BEFORE OPERATING THIS EQUIPMENT
KEEP IT IN A SAFE PLACE FOR FUTURE REFERENCE**

IMPORTANT SAFETY INSTRUCTIONS



CAUTION: TO REDUCE THE ELECTRIC SHOCK, DO NOT REMOVE THE COVER (OR BACK). NO USER SERVICEABLE PART INSIDE, REFER SERVICING TO QUALIFIED SERVICE PERSONNEL.



DANGEROUS VOLTAGE:The lightning flash with arrowhead symbol within an equilateral triangle is intended to alert the user to the presence of uninsulated “dangerous voltage” within the product’s enclosure that may be of sufficient magnitude to constitute a risk of electric shock to persons.



ATTENTION:The exclamation point within an equilateral triangle is intended to alert the user to the presence of important operating and maintenance (servicing) instructions in the literature accompanying the appliance.

WARNING: TO PREVENT FIRE OR SHOCK HAZARD, DO NOT EXPOSE THIS UNIT TO RAIN OR MOISTURE.

WARNING: USE UNDER SUPERVISION OF AN ADULT DUE TO LONG CORD This unit has a long cord that can be easily tripped on or pulled on, causing injury. Please make sure it is arranged so that it will not drape over a tabletop, etc. Where it can be pulled on by children or tripped over accidentally.

IC Caution:

This device complies with Industry Canada licence-exempt RSS standard(s). Operation is subject to the following two conditions:

- (1) this device may not cause interference,
- (2) this device must accept any interference, including interference that may cause undesired operation of the device.

This Class [B] digital apparatus complies with Canadian ICE-003.

Le présent appareil est conforme aux CNR d'Industrie Canada applicables aux appareils radio exempts de licence. L'exploitation est autorisée aux deux conditions suivantes : (1) l'appareil ne doit pas produire de brouillage, et (2) l'utilisateur de l'appareil doit accepter tout brouillage radioélectrique subi, même si le brouillage est susceptible d'en compromettre le fonctionnement.

Cet appareil numérique de la classe [B] est conforme à la norme NMB-003 du Canada.

IC ID:10765A-SP5775

FCC STATEMENT:

This device complies with part 15 of the FCC Rules. Operation is subject to the following two conditions:

- (1) This device may not cause harmful interference, and
- (2) This device must accept any interference received, including interference that may cause undesired operation.

This equipment should be installed and operated with minimum distance 20cm between the radiator and your body.

FCC NOTICE:

This equipment has been tested and found to comply with the limits for a Class B digital device, pursuant to Part 15 of the FCC Rules. These limits are designed to provide reasonable protection against harmful interference in a residential installation. This equipment generates, uses and can radiate radio frequency energy and, if not installed and used in accordance with the instructions, may cause harmful interference to radio communications. However, there is no guarantee that interference will not occur in a particular installation. If this equipment does cause harmful interference to radio or television reception, which can be determined by turning the equipment off and on, the user is encouraged to try to correct the interference by one or more of the following measures:

- Reorient or relocate the receiving antenna.
- Increase the separation between the equipment and receiver.
- Connect the equipment into an outlet on a circuit different from that to which the receiver is connected.
- Consult the dealer or an experienced radio/TV technician for help.

FCC ID:OKUSP5775

FCC WARNING:

To assure continued operation, follow the attached installation instructions and use only shield cables when connecting to other devices. Changes or modifications not expressly approved by the party responsible for compliance could void the user's authority to operate the equipment.

IMPORTANT SAFETY INSTRUCTIONS

Before using the unit, be sure to read all operating instruction carefully, please note that these are general precautions and may not pertain to your unit. For example, this unit may not have the capability to be connected to an outdoor antenna.

1. Read these instructions

All the safety and operating instructions should be read before the appliance is operated.

2. Keep these instructions

The safety and operating instructions should be kept for future reference.

3. Heed all warnings

All warnings on the appliance and in the operating instructions should be adhered to.

4. Follow all instructions

All operation and use instructions should be followed.

5. Do not use this apparatus near water

The appliance should not be used near water; for example, near a bath tub,

washbowl, kitchen sink, laundry tub, in a wet basement, or near a swimming pool.

6. Clean only with dry cloth

The appliance should be cleaned only as recommended by the manufacturer.

7. Do not block any ventilation openings. Install in accordance with the manufacturer's instructions.

Slots and openings in the cabinet and in the back or bottom are provided for ventilation, to ensure reliable operation of the product and to protect it from overheating. These openings must not be blocked or covered. The openings should never be blocked by placing the product on a bed, sofa, rug, or similar surface. This product should never be placed near or over a radiator or heat source. This product should not be placed in a built-in installation, such as a bookcase or rack unless proper ventilation is provided or the manufacturer's instructions have been adhered to.

8. Do not install near any heat sources such as radiators, heat registers, stoves, or other apparatus (including amplifiers) that produce heat.

9. Do not defeat the safety purpose of the polarized or grounding-type plug. A polarized plug has two blades with one wider than the other. A grounding type plug has two blades and a third grounding prong. The wide or the third prong are provided for your safety. If the provided plug does not fit into your outlet, consult an electrician for replacement of the obsolete outlet.

10. Protect the power cord from being walked on or pinched particularly at plugs, convenience receptacles, and the point where they exit from the apparatus.

11. Only use attachments / accessories specified by the manufacturer.

12. Use only with a cart, stand, tripod, bracket, or table specified by the manufacturer, or sold with the apparatus.

When a cart is used, use caution when moving the cart/apparatus combination to avoid injury from tip-over.



Portable Cart Warning

An appliance and cart combination should be moved with care. Quick stop, excessive force and uneven surfaces may cause the appliance and cart combination to overturn.

13. Unplug this apparatus during lightning storms or when unused for long periods of time.

To protect your product from a lightning storm, or when it is left unattended and unused for long periods of time, unplug it from the wall outlet and disconnect the antenna or cable system. This will prevent damage to the product due to lightning and power-line surges.

14. Refer all servicing to qualified service personnel. Servicing is required when the apparatus has been damaged in any way, such as power-supply cord or plug is damaged, liquid has been spilled or objects have fallen into the apparatus, the apparatus has been exposed to rain or

moisture, does not operate normally, or has been dropped.

15. Power source

This product should be operated only from the type of power source indicated on the marking label. If you are not sure of the type of power supply to your home, consult your appliance dealer or local power company. For products intended to operate from battery power, or other source, refer to the operation instructions.

16. Power lines

An outside antenna system should not be located in the vicinity of overhead power lines or other electric light or power circuits, or where it can fall into such power lines or circuits. When installing an outside antenna system, extreme care should be taken to keep from touching such power lines or circuits as contact with them might be fatal.

17. Overloading

Do not overload wall outlets and extension cords as this can result in a risk of fire or electric shock.

18. Object and liquid entry

Never push objects of any kind into the product through openings as they may touch dangerous voltage points or short out parts that could result in fire or electric shock. Never spill or spray any type of liquid on the product.

19. Outdoor antenna grounding

If an outside antenna is connected to the product, be sure the antenna system is grounded so as to provide some protection against voltage surges and built up static charges. Section 810 of the National Electric Code ANSI/ NFPA 70 provides information with respect to proper grounding of the mast and supporting structure, grounding of the lead-in wire to an antenna discharge product, size of grounding conductors, location of antenna-discharge product, connection to grounding electrodes and requirements for the grounding electrodes.

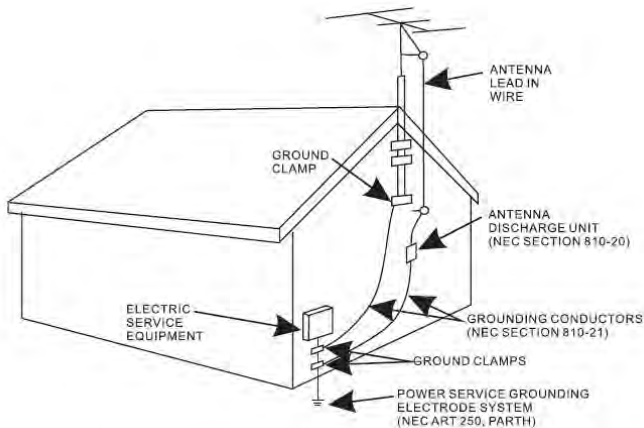

20. Service

Do not attempt to service this product yourself as opening or removing covers may expose you to dangerous voltage or other hazards. Refer all servicing to qualified service personnel.

21. Replacement parts

When replacement parts are required, be sure the service technician uses replacement parts specified by the manufacturer or those that have the same characteristics as the original parts. Unauthorized substitutions may result in fire or electric shock or other hazards.

22. Safety check

Upon completion of any service or repairs to this product, ask the service technician to perform safety checks to determine that the product is in proper operating condition.

23. Wall or ceiling mounting

The product should be mounted to a wall or ceiling only as recommended by the manufacturer.

24. Damage requiring service

Unplug this product from the wall outlet and refer service to qualified service personnel under the following conditions.

- a)When the power- supply cord or plug is damaged.
- b)If liquid has been spilled or objects have fallen into the product.
- c)If the product has been exposed to rain or water.
- d)If the product does not operate normally by following the operating instructions. Adjust only those controls that are covered by the operating instructions, as an adjustment of other controls may result in damage and will require extensive work by a qualified technician to restore the product to its normal operation.
- e)If the product has been dropped or the cabinet has been damaged.
- f)When the product exhibits a distinct change in performance- this indicates a need for service.

25. Note to CATV system installer

This reminder is provided to call the CATV system installer' s attention to Article 820- 40 of the NEC that provides guidelines for proper grounding and, in particular, specifies that the cable ground shall be connected to the grounding system of the building, as close to the point of cable entry as practical.

NOTE: Refer all servicing to qualified service personnel. Servicing is required when the unit has been damaged in any way such as the following: the power-supply cord or plug has been damaged, liquid has been spilled into unit, the unit has been exposed to rain or moisture, the unit has been dropped or the unit does not operate normally.

PRODUCT OVERVIEW

FRONT VIEW

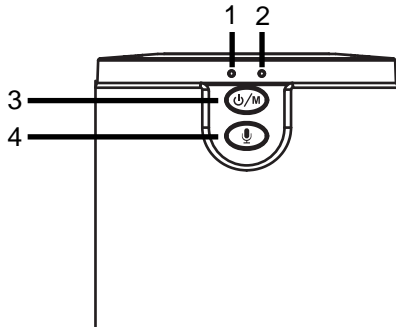

REAR VIEW

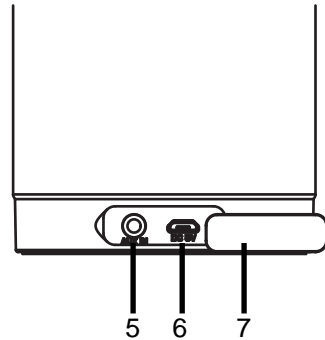

TOP VIEW

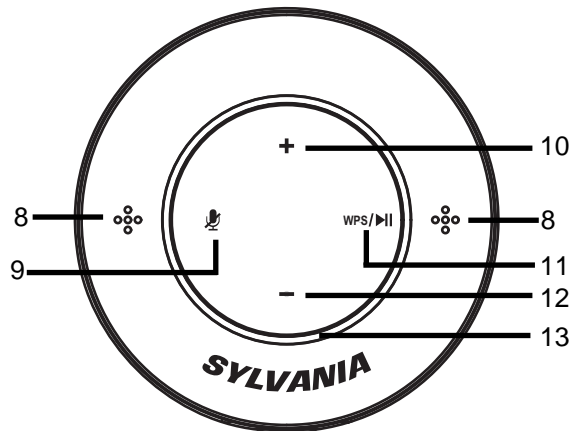

1. Charge Indicator
2. Mode Indicator
3. Power on/off, Mode Button
4. Alexa Control Button
5. AUX IN Jack
6. DC IN Jack
7. Rubber Cover

8. Built-in Microphone
9. Microphone Control Button
10. Volume Up Button
11. Play/Pause, WPS Button
12. Volume Down Button
13. LED Ring

POWER SOURCE:

There is a built in Li-ion rechargeable battery, recharge it if the battery is low.



1. Uncover the rubber cover at the rear of the unit.
2. Connect the Micro USB Plug from the supplied USB Connection Cable to the Micro USB Port on the rear of unit.
3. Connect the full size USB Plug from the supplied USB Connection Cable to the USB Port on the USB Charger(not included). When charging, the charge indicator on top of the unit will turn RED, When fully charged, the indicator will turn off.

NOTES:



Your battery will last longer if you're following these simple guidelines for charging and storing:

- A. Before first time use, charge it approximately 4 hours until the unit is fully charged.
- B. Recharge and store the unit within the temperature range of 5°C~35°C (40°F~95°F).
- C. Do not charge longer than 24 hours. Excessive charging or running the unit until battery fully drains will damage battery. Battery life will be extended if you keep the battery fully charged.
- D. Battery life naturally shortens slowly over time.
- E. The rechargeable battery incorporated in this product is not user replaceable.



AUX IN:

1. Connect one end of the Audio Connection Cable to the AUX Out/Line Out/Phone Jack on the external Audio Player.
2. Connect the other end of the cable to the AUX IN Jack on the rear of the unit.
Press and hold the  button to power on the unit, wait the mode indicator blinks WHITE only, press the  button repeatedly until the Mode Indicator turns GREEN.
3. Play the music on the connected Player as usual.

BLUETOOTH OPERATION:

1. Press and hold the  button to power on the unit, wait the mode indicator blinks WHITE only, press the  button repeatedly until the Mode Indicator will turn BLUE and blinks.
2. Activate the bluetooth menu on the device you wish to connect to the speaker, try to search the speaker, the pairing name " **SP5775** " will appear on bluetooth device list, select it and make connection.
3. After successful connection, the unit will send a tone, the mode indicator stays lit.
4. Play a track on your paired audio player as normal.
5. Press and hold the  button to disconnect the current connection if you want to pair with another external bluetooth device.

During playing:

- Press the  Button to switch between playing and pause.
- Press the  or  button to adjust volume.

NOTE:

After first time pairing, the unit will be automatically paired with the device last connected when the bluetooth of the device and speaker are activated and in range.

SETUP

APP DOWNLOAD AND INSTALLATION



- Download the PRO-SY Audio from Apple App store for iOS devies.
- Or, download from Google Play store for Android devices.
- The App icon will appear as the figure on right after successful installation. PRO-SY Audio

NOTE:

- The following operation bases on iOS system. The operation of Android is similar.

CONNECTION

1. Press and hold the  button to power on the unit, wait the mode indicator blinks WHITE only, now it is WiFi mode.
2. Turn on the WiFi on your iOS device (smart phone or tablet with WiFi function), Connect your device to the desired WiFi network (router).

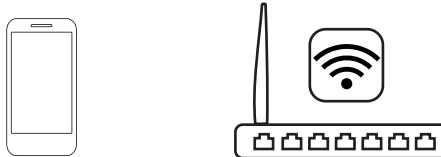

3. Tap the App icon and the following picture will appear.
Read the screen instructions and tap the  to continue.

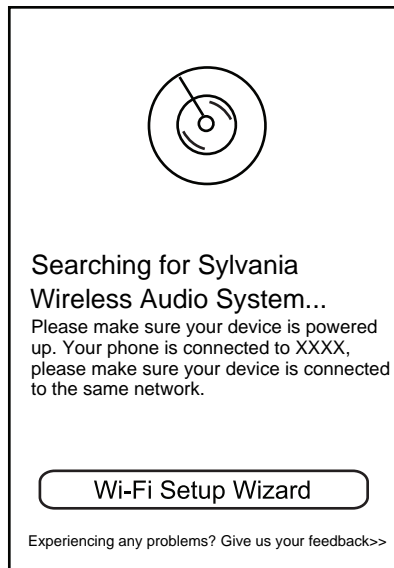

4. Read the instructions on screen and tap " Next " to continue.

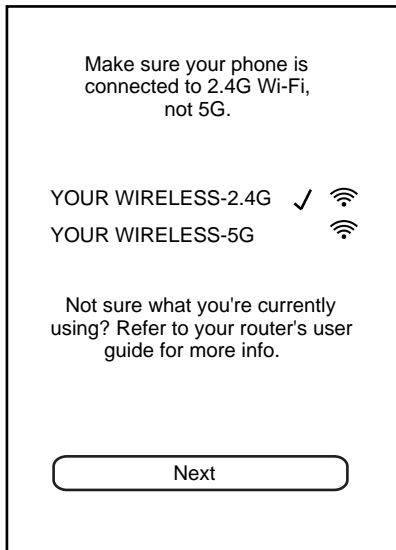

5. Select the desired device SP5775. Tap " Connect Speaker " to continue.

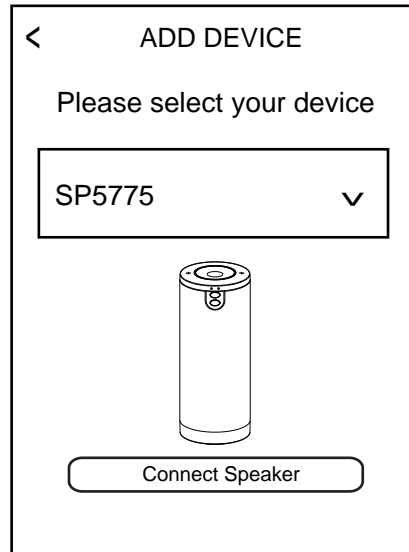

6. Tap the Password column to input the password to make the speaker to connect to Wi-Fi network(router), tap " Next " to continue.

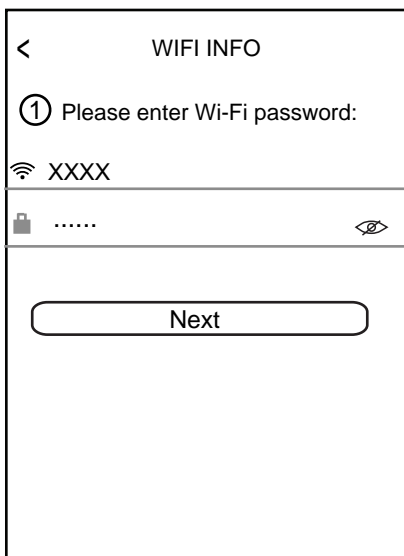

7. **Press and hold the WPS /▶▶ button** on top of the speaker. Tap " Next " to continue.

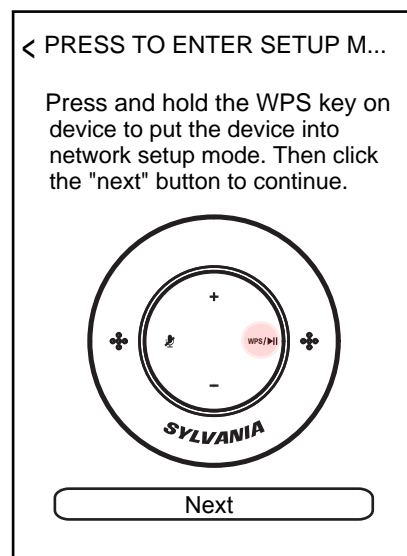

8. There will be voice instructing during the connecting process.

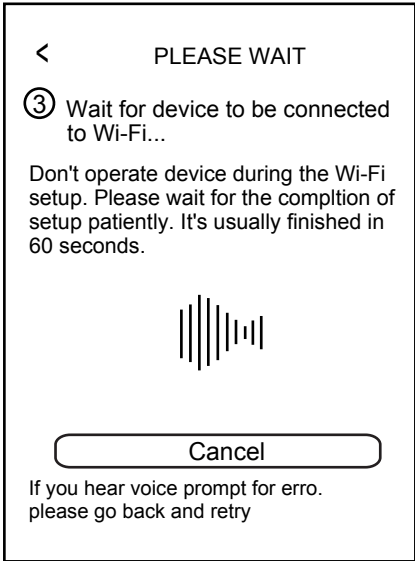

9. When the speaker is connected to the network successfully, the Mode Indicator will stay lit.

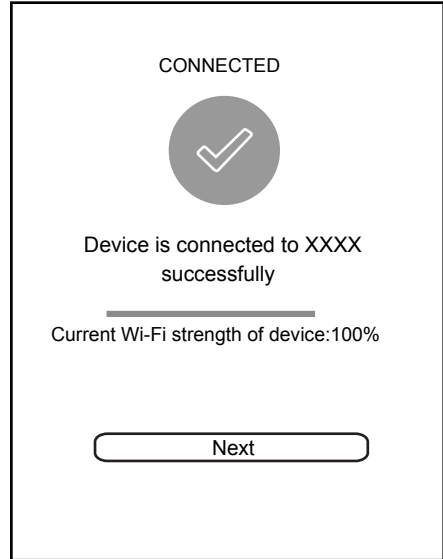

Note 1:
If the connection fails, the following page will appear. Then tap the "Cancel Setup" to reconnect as the on screen instructions.

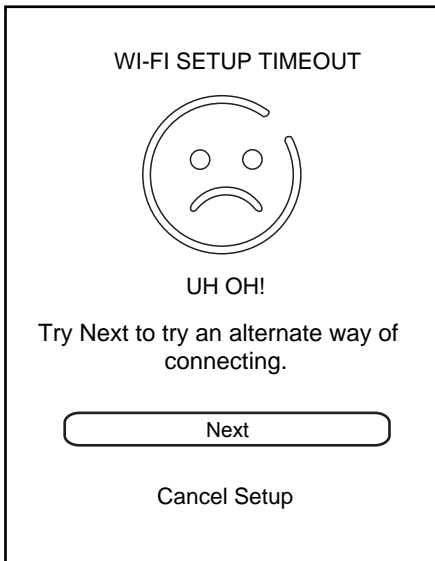

Note 2:
If you tap "Next", the following page will appear, then go to your phone to set up.

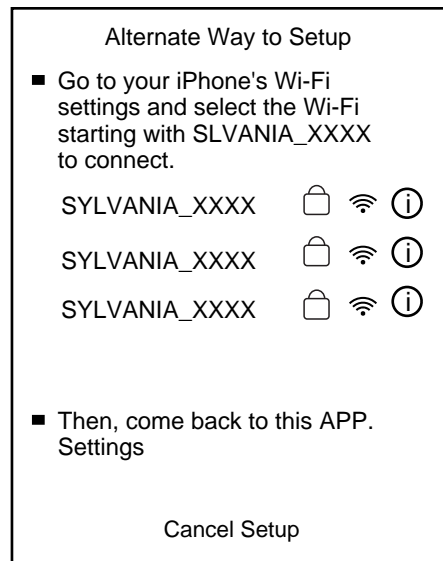

10. After connected, the following screen will appear, tap "Custom..." to set a new desired location name, or tap one in the name list as the selected location. Then tap > to continue.

11. The following page will appear. If you already have an account, then tap "Sign in with Amazon" Button on the following screen.

12. The following page will appear, input the account and password and tap the "Sign in" Button on the screen to log on.

13. If you do not have an Amazon account, tap "Create a new Amazon account" to start registration and create a new Amazon account as the on screen instructions.

14. When the following page appears, tap "I agree" to log in Amazon.

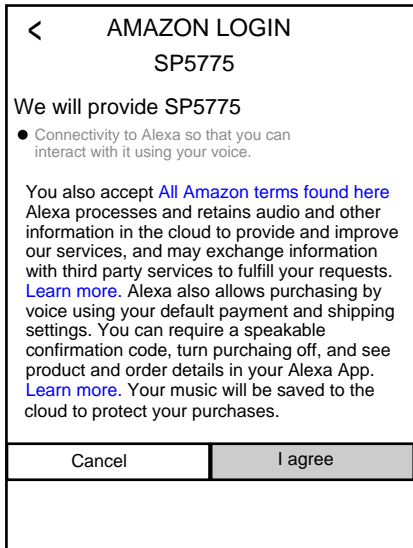

15. After log in, the following page will appear, tap the language to set the desired language.

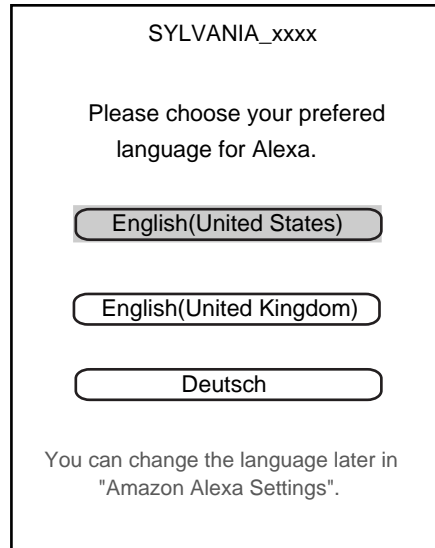

16. The following page will appear, tap the "Next" Button on the screen.



17. You can mute the microphone following the on screen instructions or tap the "Next" button to continue.

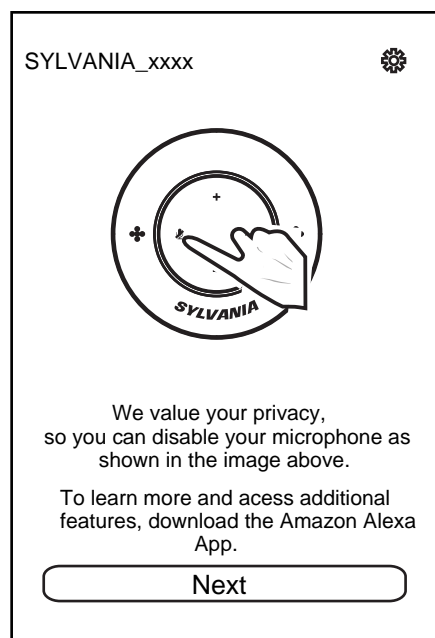

18. Then the DEVICE LIST will appear.

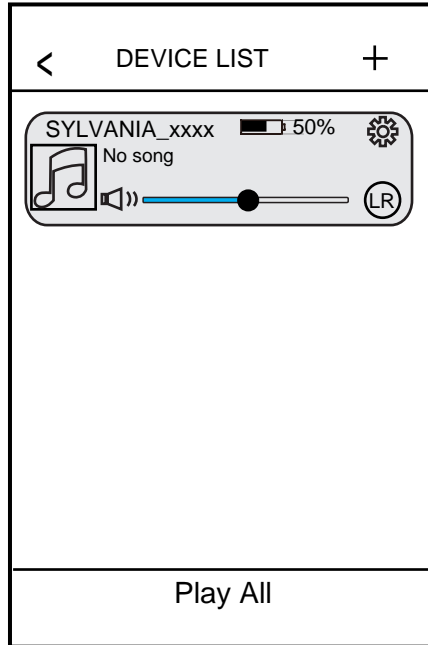

On DEVICE LIST:

- Tap the "+" to add more units to the network, repeat the procedure above and make connection as the on screen instructions.
- Tap the "⚙️" to rename the unit, check the speaker info or preset content and set or reset the Alexa settings.
- Tap the "LR" to change the audio mode to L (left channel), R (right channel) and LR (stereo).
- Drag and slide down from the top screen to update the DEVICE LIST, if there is other speaker on the same network, they will be added into the list.

19. If more than one unit has been added into the DEVICE LIST, you can tap the instruction “ How to switch between solo and multi mode? ” to learn how to switch solo and multi mode as below:

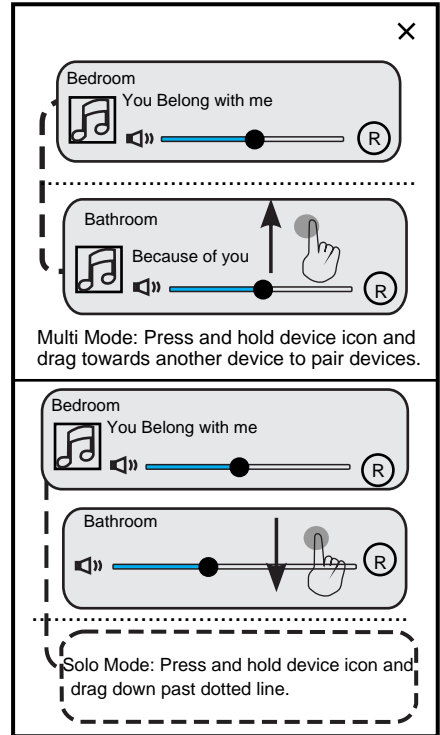
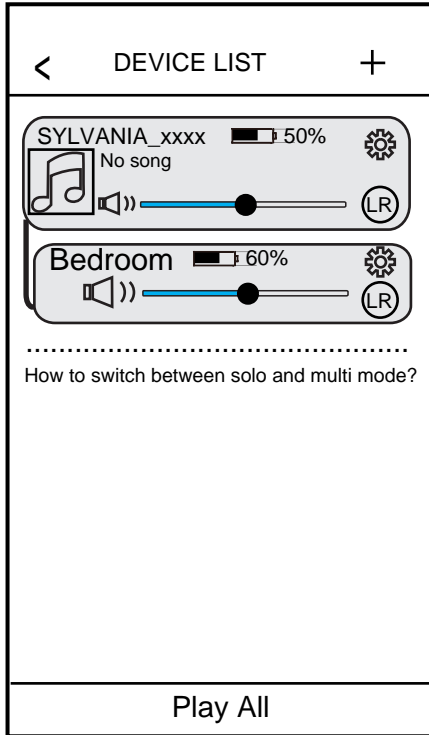

20. When finished, shut off the unit by pressing and holding the  /M button on the unit.

HOME PAGE INTERFACE

Tap and slide to right screen to enter homepage, operate as below instructions and the screen instructions. Some platforms may need registration or download the related APP.

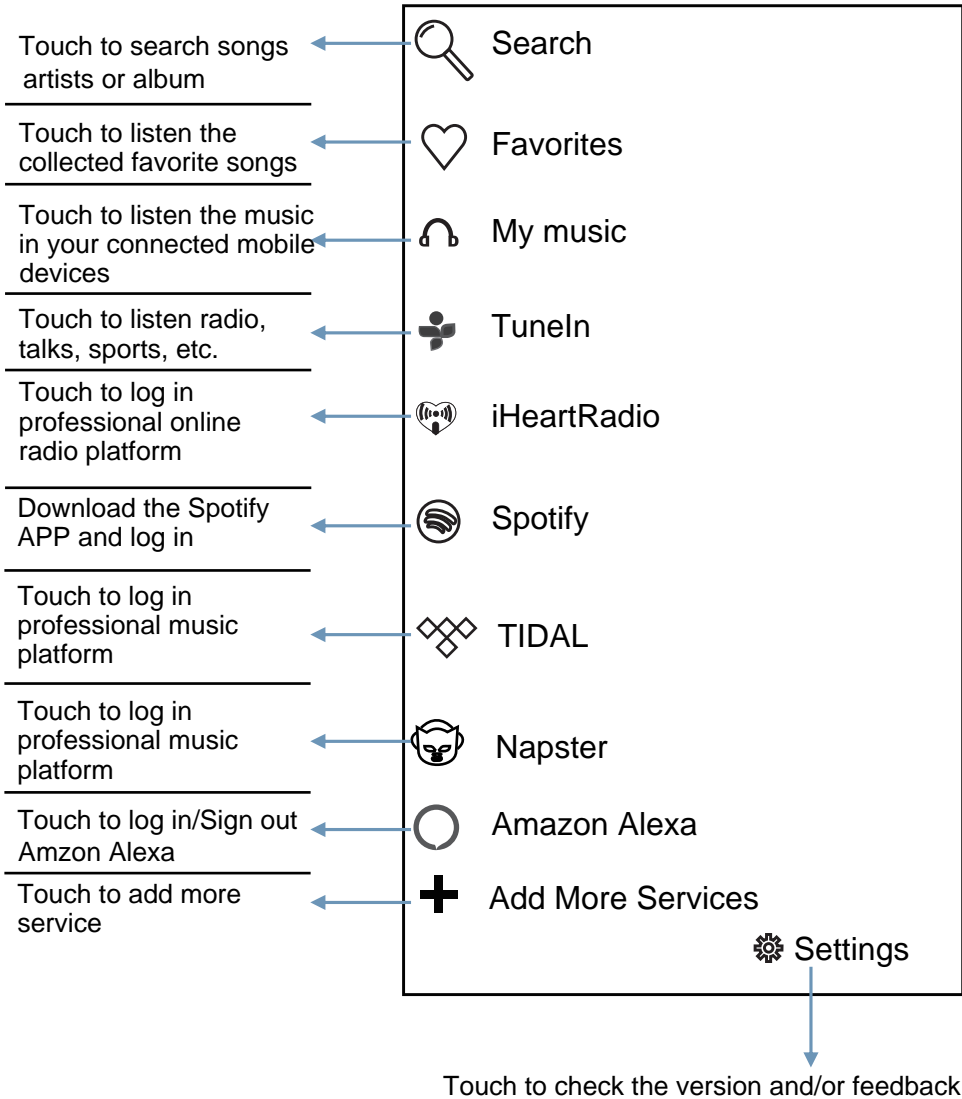

SPOTIFY OPERATION

Before use, you have to create an spotify account and download the APP for log in.

1. Tap "Spotify" on homepage.
2. Input your account and password to log in.
3. Open the Spotify on your phone, tablet or PC, and play any song.
4. Tap the connect icon  .
5. Pick your device from the list.

Licenses

The Spotify Software is subject to third party licenses found here:
www.spotify.com/connect/third-party-licenses.

IHEARTRADIO OPERATION

Before use, you have to create an iHeartradio account for log in.

1. Tap "iHeartradio" on homepage.
2. Input your account and password to log in.
3. Select the desired song and play.

TIDAL OPERATION

Before use, you have to create a TIDAL account for log in.

1. Tap "TIDAL" on homepage.
2. Input your account and password to log in.
3. Select the desired song and play.

AMAZON ALEXA VOICE CONTROL

Voice Control of Amazon Alexa:

1. Speak "Alexa" to the built-in microphone. The color of the Decorative Ring will turn to Blue. Then you can ask your question through the built-in microphone. The unit will answer you by audible reply. The typical question and answer will be:

Q: Alexa --- what's the time now?

A: It's XX (XX=Current time) o'clock now.

Q: Alexa --- what's the weather like?

A: The weather is not so cold.

Q: Alexa --- what day is today?

A: Today is XXXXX (XXXXX=Current day).

Q: Alexa --- what's the news today?

A: Here is the flash briefing.

Q: Alexa --- who is the president in USA?

A: The USA president is XX (XX=Name of USA president).

Q: Alexa --- what's the capital in USA?

A: The United States' capital is Washington D.C.

2. Or, press the  Button on the unit, the color of the Decorative Ring will turn to Blue. Then you can ask your question through the built-in microphone. The unit will answer you by audible reply. The typical question and answer will be:

Q: What's the time now?

A: It's XX (XX=Current time) o'clock now.

Q: What's the weather like?

A: The weather is not so cold.

Q: What day is today?

A: Today is XXXXX (XXXXX=Current day).

Q: What's the news today?

A: Here is the flash briefing.

Q: Who is the president in USA?

A: The USA president is XX (XX=Name of USA president).

Q: What's the capital in USA?

A: The United States' capital is Washington D.C.

3. During Amazon Alexa operation, you can use the following voice command to control the unit:

- Voice command: (Alexa)---play the song <XX> (XX=Name of the desired song)!
Action: The song will be played.
- Voice command: (Alexa) --- pause/stop the song!
Action: The song will be paused or stopped.
- Voice command: (Alexa) --- continue to play!
Action: The song will continue to play.
- Voice command: (Alexa) --- volume up!
Action: The volume will increase.
- Voice command: (Alexa) --- volume down!
Action: The volume will decrease.
- Voice command: (Alexa) --- fastforward!
Action: The track will be fastwarded.
- Voice command: (Alexa) --- rewind!
Action: The track will rewind.
- Voice command: (Alexa) --- previous!
Action: The track will skip to previous track.
- Voice command: (Alexa) --- next!
Action: The track will skip to next track.

4. To turn off the microphone. Press the  Button, the color of the Decorative Ring will turn to Red. To turn on again, press the button again. The color of the Decorative Ring will turn to White.

LED RING STATUS

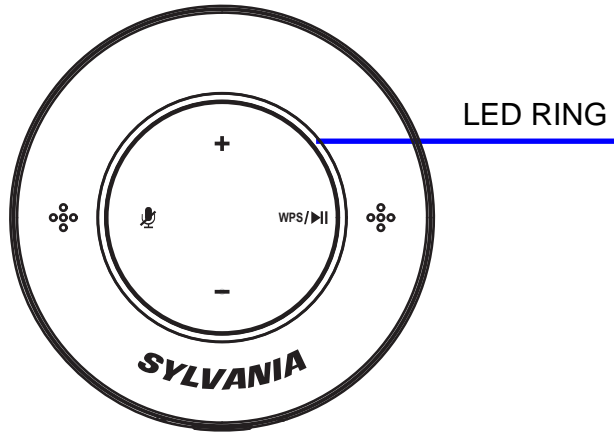

SPEAKER STATUS	LED RING STATUS
Idle	White LED ON
Listening	Blue LED ON
Thinking	Blue LED ON
Talking	Blue LED blinks
Microphone Off	Red LED ON

TROUBLESHOOTING

Check the following before requesting service:

SYMPTOM	POSSIBLE CAUSE	POSSIBLE SOLUTION
Can't power on	Built in battery drained	Recharge the battery
No sound or sound weak	Volume level of paired/connected device is in low level	Rise the volume level of the paired/connected device
Sound distortion	Volume level of the connected/paired device too high	Reduce the volume level of the connected/paired device
BT not functioning	The external BT device had NOT paired to the unit	Pair the external BT device to the unit
	The external BT device too far from the unit	Place the external BT device close to the unit

SPECIFICATIONS

Power source: Built-in DC --- 3.7V, 2500mAh (9.2WH) rechargeable Li-ion Battery,
Recharge by DC --- 5V through Micro USB Port

BT Version:	4.1
BT Operation Distance:	about 32 Feet in open area
Wifi Operation Distance:	about 96 Feet in open area
Audio Output Power:	5.5 W (RMS)
Dimension:	90 x 90 x 190mm
Product Net Weight:	470 g

INCLUDED ACCESSORIES

- 1x User manual (this manual)
- 1x USB charging cable (for charging only)
- 1x 3.5mm plug stereo audio cable

**SPECIFICATIONS AND ACCESSORIES ARE SUBJECT TO CHANGE
WITHOUT NOTICE**