

# atune analog

---

30" Bluetooth soundbar speaker with wireless subwoofer and Dolby

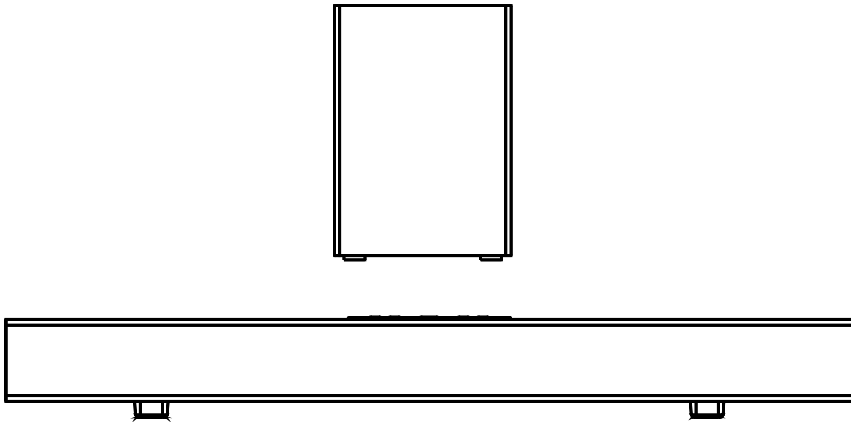

Model: SBB-A5521

Please read this instruction manual carefully and keep it for future reference

## IMPORTANT SAFETY INSTRUCTIONS



**CAUTION**  
**RISK OF ELECTRIC SHOCK**  
**DO NOT OPEN**



CAUTION: TO REDUCE THE ELECTRIC SHOCK, DO NOT REMOVE THE COVER (OR BACK). NO USER SERVICEABLE PART INSIDE, REFER SERVICING TO QUALIFIED SERVICE PERSONNEL.



**DANGEROUS VOLTAGE:**The lighting flash with arrowhead symbol within an equilateral triangle is intended to alert the user to the presence of uninsulated “dangerous voltage” within the product’s enclosure that may be of sufficient magnitude to constitute a risk of electric shock to persons.



**ATTENTION:**The exclamation point within an equilateral triangle is intended to alert the user to the presence of important operating and maintenance (servicing) instructions in the literature accompanying the appliance.

**WARNING: TO PREVENT FIRE OR SHOCK HAZARD, DO NOT EXPOSE THIS UNIT TO RAIN OR MOISTURE.**

**WARNING: USE UNDER SUPERVISION OF AN ADULT DUE TO LONG CORD** This unit has a long cord that can be easily tripped on or pulled on, causing injury. Please make sure it is arranged so that it will not drape over a tabletop, etc. Where it can be pulled on by children or tripped over accidentally.

## IMPORTANT SAFETY INSTRUCTIONS

Before using the unit, be sure to read all operating instructions carefully, please note that these are general precautions.

### 1. Read these instructions

All the safety and operating instructions should be read before the appliance is operated.

### 2. Keep these instructions

The safety and operating instructions should be kept for future reference.

### 3. Heed all warnings

All warnings on the appliance and in the operating instructions should be adhered to.

### 4. Follow all instructions

All operation and use instructions should be followed.

### 5. Do not use this apparatus near water

The appliance should not be used near water; for example, near a bath tub,

washbowl, kitchen sink, laundry tub, in a wet basement, or near a swimming pool.

**6. Clean only with dry cloth**

The appliance should be cleaned only as recommended by the manufacturer.

**7. Do not block any ventilation openings. Install in accordance with the manufacturer's instructions.**

Slots and openings in the cabinet and in the back or bottom are provided for ventilation, to ensure reliable operation of the product and to protect it from overheating. These openings must not be blocked or covered. The openings should never be blocked by placing the product on a bed, sofa, rug, or similar surface. This product should never be placed near or over a radiator or heat source. This product should not be placed in a built-in installation, such as a bookcase or rack unless proper ventilation is provided or the manufacturer's instructions have been adhered to.

**8. Do not install near any heat sources such as radiators, heat registers, stoves, or other apparatus (including amplifiers) that produce heat.**

**9. Do not defeat the safety purpose of the grounding-type plug. A grounding type plug has two prongs and a third grounding prong. The third prong is provided for your safety. If the provided plug does not fit into your outlet, consult an electrician for replacement of the obsolete outlet.**

**10. Protect the power cord from being walked on or pinched particularly at plugs, convenience receptacles, and the point where they exit from the apparatus.**

**11. Only use attachments / accessories specified by the manufacturer.**

**12. Use only with a cart, stand, tripod, bracket, or table specified by the manufacturer, or sold with the apparatus.**

**When a cart is used, use caution when moving the cart/apparatus combination to avoid injury from tip-over.**



Portable Cart Warning

An appliance and cart combination should be moved with care. Quick stop, excessive force and uneven surfaces may cause the appliance and cart combination to overturn.

**13. Unplug this apparatus during lightning storms or when unused for long periods of time.**

To protect your product from a lightning storm, or when it is left unattended and unused for long periods of time, unplug it from the wall outlet. This will prevent damage to the product due to lightning and power-line surges.

**14. Refer all servicing to qualified service personnel. Servicing is required when the apparatus has been damaged in any way, such as power-supply cord or plug is damaged, liquid has been spilled or objects have fallen into the apparatus, the apparatus has been exposed to rain or**

**moisture, does not operate normally, or has been dropped.**

**15. Power source**

This product should be operated only from the type of power source indicated on the marking label. If you are not sure of the type of power supply to your home, consult your appliance dealer or local power company. For products intended to operate from battery power, or other source, refer to the operation instructions.

**16. Power lines**

An outside antenna system should not be located in the vicinity of overhead power lines or other electric light or power circuits, or where it can fall into such power lines or circuits. When installing an outside antenna system, extreme care should be taken to keep from touching such power lines or circuits as contact with them might be fatal.

**17. Overloading**

Do not overload wall outlets and extension cords as this can result in a risk of fire or electric shock.

**18. Object and liquid entry**

Never push objects of any kind into the product through openings as they may touch dangerous voltage points or short out parts that could result in fire or electric shock. Never spill or spray any type of liquid on the product.

**19. Service**

Do not attempt to service this product yourself as opening or removing covers may expose you to dangerous voltage or other hazards. Refer all servicing to qualified service personnel.

**20. Replacement parts**

When replacement parts are required, be sure the service technician uses replacement parts specified by the manufacturer or those that have the same characteristics as the original parts. Unauthorized substitutions may result in fire or electric shock or other hazards.

**21. Safety check**

Upon completion of any service or repairs to this product, ask the service technician to perform safety checks to determine that the product is in proper operating condition.

**22. Wall or ceiling mounting**

The product should be mounted to a wall or ceiling only as recommended by the manufacturer.

### **23. Damage requiring service**

Unplug this product from the wall outlet and refer service to qualified service personnel under the following conditions.

- a)When the power- supply cord or plug is damaged.
- b)If liquid has been spilled or objects have fallen into the product.
- c)If the product has been exposed to rain or water.
- d)If the product does not operate normally by following the operating instructions. Adjust only those controls that are covered by the operating instructions, as an adjustment of other controls may result in damage and will require extensive work by a qualified technician to restore the product to its normal operation.
- e)If the product has been dropped or the cabinet has been damaged.
- f)When the product exhibits a distinct change in performance- this indicates a need for service.

**FCC STATEMENT:**

This device complies with part 15 of the FCC Rules. Operation is subject to the following two conditions:

- (1) This device may not cause harmful interference, and
- (2) This device must accept any interference received, including interference that may cause undesired operation. The antenna(s) used for this transmitter must be installed to provide a separation distance of at least 20 cm from all persons and must not be co-located or operating in conjunction with any other antenna or transmitter.

**FCC NOTICE:**

This equipment has been tested and found to comply with the limits for a Class B digital device, pursuant to Part 15 of the FCC Rules. These limits are designed to provide reasonable protection against harmful interference in a residential installation. This equipment generates, uses and can radiate radio frequency energy and, if not installed and used in accordance with the instructions, may cause harmful interference to radio communications. However, there is no guarantee that interference will not occur in a particular installation. If this equipment does cause harmful interference to radio or television reception, which can be determined by turning the equipment off and on, the user is encouraged to try to correct the interference by one or more of the following measures:

- Reorient or relocate the receiving antenna.
- Increase the separation between the equipment and receiver.
- Connect the equipment into an outlet on a circuit different from that to which the receiver is connected.
- Consult the dealer or an experienced radio/TV technician for help.

**FCC WARNING:**

To assure continued operation, follow the attached installation instructions and use only shield cables when connecting to other devices. Changes or modifications not expressly approved by the party responsible for compliance could void the user's authority to operate the equipment.

**WARNING:**

Cancer and Reproductive Harm-[www.P65Warnings.ca.gov](http://www.P65Warnings.ca.gov)

# PRODUCT OVERVIEW

## SOUNDBAR

### FRONT VIEW

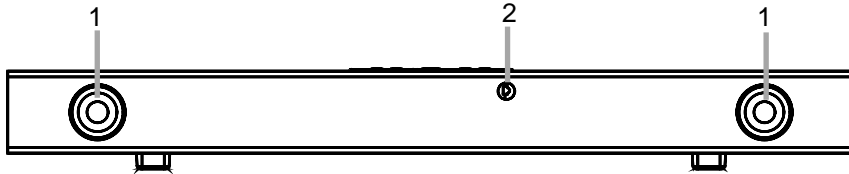

### CONTROL PANEL

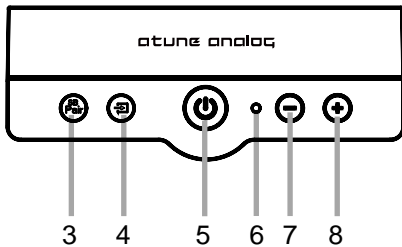

### REAR PANEL

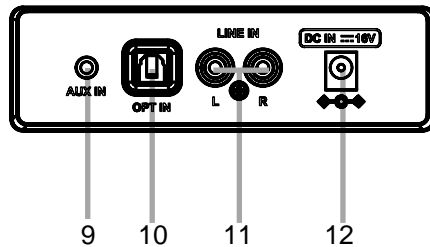

### SUBWOOFER

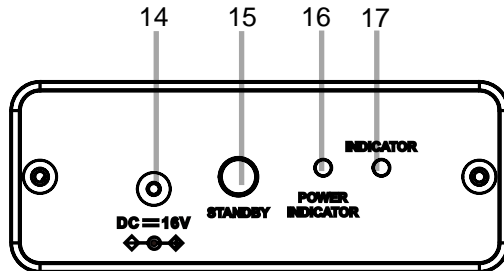
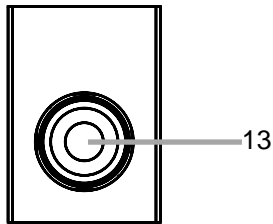

- 1. Speaker
- 2. Remote sensor
- 3. SB PAIR button
- 4. Mode button
- 5. Power button
- 6. Mode indicator
- 7. Volume down button
- 8. Volume up button
- 9. AUX IN jack

- 10. Optical In jack
- 11. LINE IN jacks
- 12. DC IN jack
- 13. Speaker
- 14. DC IN jack
- 15. STANDBY button
- 16. Power indicator
- 17. indicator(for pairing)

## REMOTE CONTROL

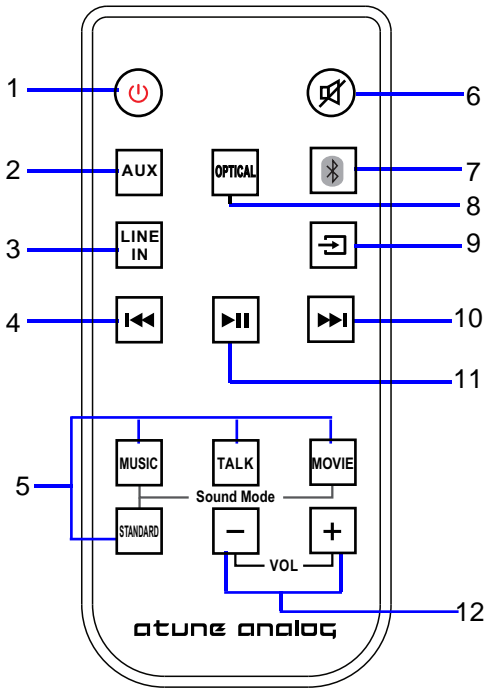

1. ⏻ (Power On/Off) Button
2. AUX Button
3. LINE IN Button
4. ⏮ (Previous) Button
5. Sound Mode (MUSIC, TALK, MOVIE, STANDARD)
6. 🔇 (Mute) Button
7. 📶 (Bluetooth) Button
8. OPTICAL Button
9. ➡ (Mode Switch) Button
10. ⏭ (Next) Button
11. ⏸ Play/Pause Button
12. - + (Volume Down/Up) Button

## BATTERY INSTALLATION OF REMOTE CONTROL

### First time use

Remove and discard the insulation film as Fig.1.

### Replacing battery for Remote Control

1. Pull out the battery holder as indicated in Fig.2.
2. Replace the old button cell with a new CR2025 button cell with the polarity markings facing upward as Fig.3.
3. Push back the battery holder as Fig.4.

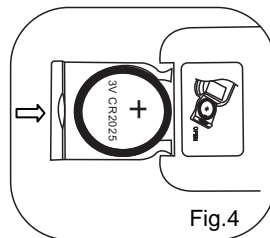
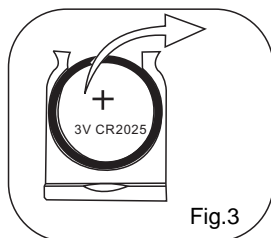
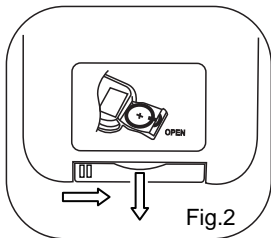
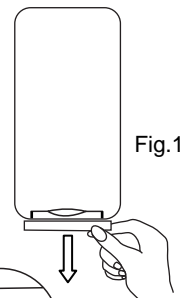



## BATTERY PRECAUTIONS

Follow these precautions when using a battery in this device:

1. Use only the size and type of battery specified.
2. Be sure to follow the correct polarity when installing the battery as indicated in the battery compartment, a reversed battery may cause damage to the device.
3. Do not mix different types of batteries together ( e.g: Alkaline and Carbon-zinc ) or old batteries with fresh ones.
4. If the batteries in the device are consumed or the device is not to be used for a long period of time, remove the batteries to prevent damage or injury from possible leakage.
5. Do not try to recharge the battery as it is not intended to be recharged; it can overheat and rupture. ( Follow the battery manufacturer's instructions.)
6. The batteries shall not be exposed to excessive heat such as sunshine or fire.
7. Clean the battery contacts and also those of the device prior to battery installation.
8. The remote control is supplied with a coin/button cell battery. If the coin / button cell battery is swallowed, it can cause severe internal burns in just 2 hours and can lead to death. Keep new and used battery away from children. If the battery compartment does not close securely, stop using the product and keep it away from children. If you think batteries might have been swallowed or placed any part of the body, seek immediate medical attention.



## CAUTION

- Danger of explosion if the battery is incorrectly replaced.
- Replace only with the same or equivalent type.

## Remote control operation range

- When there is an obstacle between the transmitter and the unit, the unit may not operate.
- When direct sunlight, an incandescent lamp, fluorescent lamp or any other strong light shines on the REMOTE SENSOR of the unit, the operation of the remote may be unstable.

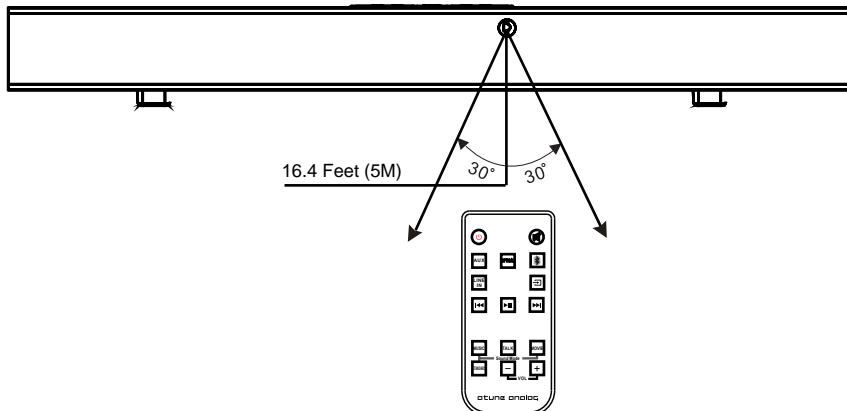

## PLACEMENT AND MOUNTING

### 1. Placing the device on a table - Ventilation

When placing the soundbar and the subwoofer on an entertainment center, bookshelf, or any type of enclosed space, be sure to allow enough space for ventilation. Otherwise, the heat generated will produce potential heat hazard.

SOUNDBAR

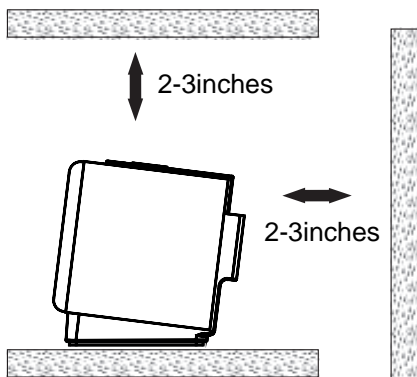

SUBWOOFER

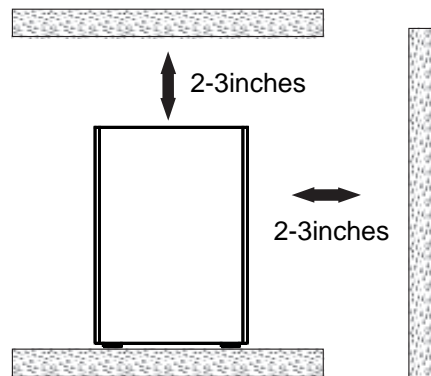

### 2. The Installation Distance

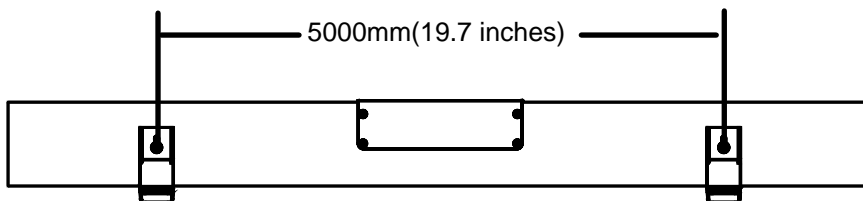

## 2.1 Mounting to a wooden wall

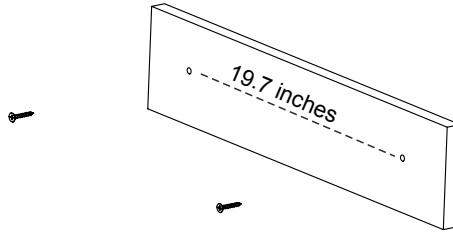

(screws not included)

- A. Mark the position of the mounting screws on the wall using a pencil.
- B. Drill the screws directly into the marks that you have made on the wall and leave approx. 0.3 inches length to hook the sound bar.
- C. Put the sound bar onto the mounting screws. Make sure they are firm and stable.

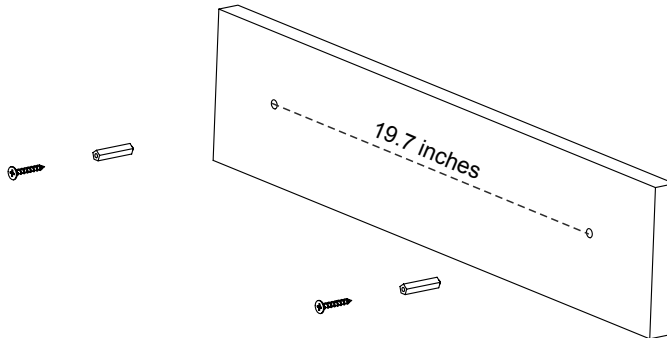

## 2.2 Mounting to a brick wall



(screws and plastic fixing plug are not included)

- A. Mark the position of the mounting screws on the wall using a pencil.
- B. Drill 2 holes on wall with a powerful electric drill.
- C. Insert the fixing plug and hammer into the holes.
- D. Secure the screws into the fixing plug and leave approx. 0.3 inches length to hook the sound bar.
- E. Put the sound bar onto the mounting screws. Make sure they are firm and stable.

## GENERAL OPERATION



1. Connect the DC 16V, 1.8A Adapter to the DC IN jack on the Unit. Plug the Adapter into the AC outlet with AC100~240V;50/60Hz. The mode indicator on the Unit will light up and turn RED.
2. Connect the DC 16V, 1.8A Adapter to the DC IN jack on the subwoofer. Plug the Adapter into the AC outlet with AC100~240V;50/60Hz.
3. Press and hold the  button on the unit or press the  button on remote control to power on the unit.  
Press the STANDBY button on the subwoofer to power on.
4. After a few seconds, the unit will be connected with subwoofer automatically, the indicator on subwoofer will be solid blue.

**IMPORTANT NOTE:** If the pairing INDICATOR on the SUBWOOFER is off, it means the Main Unit is not connected with the SUBWOOFER successfully. Please operate as the steps below:

**A:** Press and hold the SB Pair button on the Main Unit for 3-5 seconds.

**B:** Press and hold the STANDBY button on SUBWOOFER to power off, then press the STANDBY button on SUBWOOFER once to power on again, the pairing INDICATOR on SUBWOOFER will blink several times and then turn off, it means the SUBWOOFER is connected with Main Unit successfully.

**C:** Press the SB PAIR button on the Main Unit again, the pairing INDICATOR on the SUBWOOFER will be solid BLUE.

5. Press the  button on remote control or press the  button on the unit repeatedly to switch to the desired mode. Or press the AUX, OPTICAL,  , LINE IN, on remote control to turn to desired mode, the indicator will turn to:

Blue.....Bluetooth Mode  
Violet (red+blue).....AUX IN Mode  
Green.....LINE IN Mode  
Indigo (blue+green).....OPTICAL IN Mode

## GENERAL OPERATION





### 6. During Playback:

- ~ Press the + or - button on the unit or remote control repeatedly to adjust volume.
- ~ Press the  button on remote control to turn off sound, the mode indicator on the unit will blink, press the button again to resume.
- ~ Press the MUSIC button on remote control to turn to MUSIC sound effect mode.
- ~ Press the TALK button on remote control to turn to TALK sound effect mode.
- ~ Press the MOVIE button on remote control to turn to MOVIE sound effect mode.
- ~ Press the STANDARD button on remote control to turn to normal sound effect mode.

### 7. Press the button on the unit or press the button on the remote control to power off the unit.

Press and hold the STANDBY button on the subwoofer to power off subwoofer.

## BLUETOOTH OPERATION

1. Press the  button on the soundbar repeatedly until the indicator turns blue, or press the  button on remote control to switch to the Bluetooth mode, the the indicator on front of soundbar will turn Blue and blink.
2. Power on external Bluetooth enabled device and enter Bluetooth mode and try searching the soundbar.
3. When **atune analog 07** appears, select it and make connection.
4. After successful paired, the indicator will be solid blue.
5. During playing:
  - Press the  or  button on remote control to skip tracks.
  - Press the  button on remote control to pause, press it again to resume.
6. Press and hold the BT Pair button on remote control to disconnect current connection with subwoofer, the pairing indicator will turn off. Press this button again to reconnect with subwoofer.

### NOTE:

The soundbar will be automatically connected with the last connected Bluetooth device if their Bluetooth function are activated and they are in working range.

## AUX IN OPERATION

An external Audio player(such as mobile phone, MP3 player etc.) can be connected to this soundbar and listen through the speakers.

1. Plug one end of the AUX IN cable into the AUX IN jack on the soundbar.
2. Plug another end of the AUX IN cable into the headphone jack or AUX OUT jack on the external audio player.

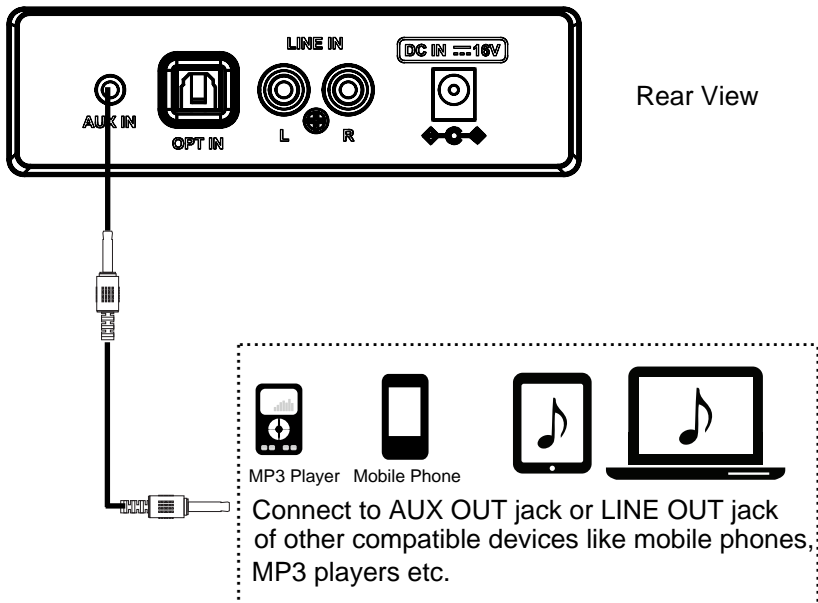



3. Press the  button on the soundbar repeatedly or press the AUX button on remote control to switch to the AUX IN mode, the indicator on top of the soundbar will turn Violet.
4. Power on the connected external player and start playing.

## LINE IN OPERATION

An external Audio/Video device(such as Set-Top Box, DVD player etc.) can be connected to this soundbar and listen through the speakers.

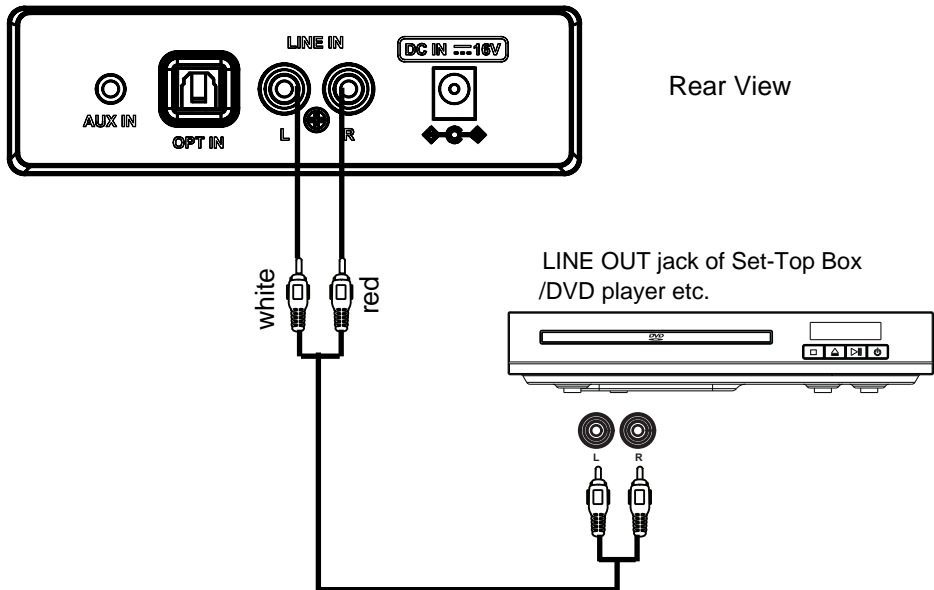
1. Plug one end of the LINE IN cable into the LINE IN jack(L&R) on soundbar.
2. Plug the other end of the LINE IN cable into the LINE OUT jack(L&R) on Set-Top Box or DVD player etc.





3. Press the  button on the soundbar repeatedly or press the LINE IN button on remote control to switch to the LINE IN mode, the indicator on top of the soundbar will turn Green.
4. Power on the connected external device and start playing.



## OPTICAL IN OPERATION

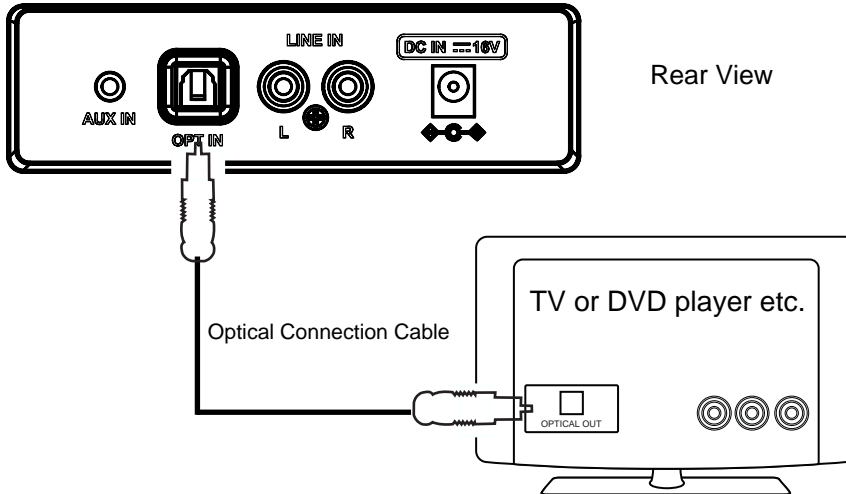

1. Connect the OPTICAL OUT jack from the external audio player (such as TV, DVD player etc.) to the OPTICAL IN jack on the rear of the soundbar with the optical connection cable as illustrated below:(For PCM format only)



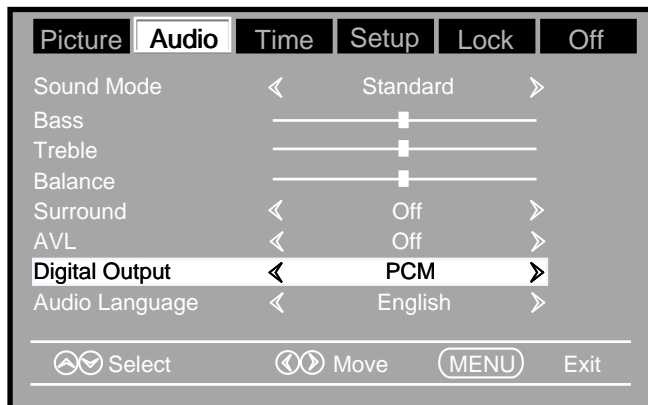

2. Press the  button on soundbar repeatedly or press the OPTICAL button on remote control to switch to the OPTICAL IN mode, the indicator on top of soundbar will turn Indigo(blue+green).
3. Power on the connected external player and start playing .  
Turn on the digital audio output and set it to PCM (Pulse Code Modulation) type similar to the below figure:



## TROUBLESHOOTING

SYMPTOM	POSSIBLE CAUSE	POSSIBLE SOLUTION
No power	The Adapter is not connected	Connect the Adapter to the wall outlet
	Soundbar is in power off mode	Press the  button on soundbar or press the  button on remote control to power on
No sound or low sound	Volume level in minimum position	Raise the volume level by pressing the + Button on soundbar Or press VOL + button on remote control
	The paired/connected device is not in playback mode	Play music/movie in the paired/connected device and make sure the volume level is high
	Input source incorrect	Press the  button repeatedly to switch to desired mode
Sound distortion/rattle	Volume level too high	Reduce the volume level by pressing the - Button on the top of the soundbar Or press VOL - button on remote control  Reduce the volume level of the paired/connected device.
Remote Control not functioning	Out of range	Point the remote control to the remote sensor on the unit within 16 feet, +/-30 degrees
	The battery in the remote control is drained	Replace with new battery
Bluetooth reception failure	The external device is too far from soundbar	Put the external BT device close to the soundbar
	Have not paired	Pair the soundbar with the BT Device as mentioned

## SPECIFICATIONS

Power input .....	AC 100~240V, 50/60Hz
Power output .....	DC 16V  1.8A  
Audio output of the unit.....	2 x 15 W
Audio output of the subwoofer.....	30W
Bluetooth effective working range in open area.....	up to 32 feet
Remote effective working range.....	up to 16 feet

### PACKAGES

- 1x The Unit
- 1x Subwoofer
- 1x User Manual
- 1x Remote Control
- 1x LINE IN Cable
- 1x Power Adapter for the Soundbar (16V, 1.8A)
- 1x Power Adapter for the Subwoofer (16V,1.8A)

**SPECIFICATIONS AND ACCESSORIES ARE SUBJECT TO CHANGE  
WITHOUT NOTICE**



is a trademark on a registered trademark of Bluetooth SIG Inc. All other trademarks and trade names are those of their respective owners.

OKUSBBA5521  
CustomerService@ttnno.com