

**WALL MOUNTABLE 2.1-CHANNEL BLUETOOTH
SOUNDBAR SPEAKER WITH FM RADIO**



MODEL: JSBW-650

USER MANUAL



**PLEASE READ THIS USER MANUAL COMPLETELY BEFORE OPERATING THIS UNIT AND
RETAIN THIS BOOKLET FOR FUTURE REFERENCE.**

**Please contact Spectra Customer Service at 1-800-777-5331 if
you have any questions about operating this product.**

IMPORTANT SAFETY INSTRUCTIONS

When used in the directed manner, this unit has been designed and manufactured to ensure your personal safety. However, improper use can result in potential electrical shock or fire hazards. Please read all safety and operating instructions carefully before installation and use, and keep these instructions handy for future reference. Take special note of all warnings listed in these instructions and on the unit.

1. Read these instructions – All the safety and operating instructions should be read before the appliance is operated.
2. Keep these instructions – The safety and operating instructions should be kept for future reference.
3. Heed all warnings – All warnings on the appliance and in the operating instructions should be adhered to.
4. Follow all instructions – All operation and use instructions should be followed.
5. Do not use this apparatus near water – The appliance should not be used near water; for example, near a bath tub, washbowl, kitchen sink, laundry tub, in a wet basement, or near a swimming pool.
6. Clean only with dry cloth – The appliance should be cleaned only as recommended by the manufacturer.
7. Do not block any ventilation openings. Install in accordance with the manufacturer's instructions. The appliance should be situated so that its location or position does not interfere with its proper ventilation. For example, the appliance should not be situated on a bed, sofa, rug, or similar surface that may block the ventilation openings; or placed in a built-in installation, such as a bookcase or cabinet that may impede the flow of air through the ventilation openings.
8. Do not install near any heat sources such as radiators, heat registers, stoves, or other apparatus (including amplifiers) that produce heat.
9. AC adaptor is used as disconnect device and it should remain readily operable during intended use. In order to disconnect the apparatus from the mains completely, the AC adaptor should be disconnected from the mains socket outlet completely.
10. Only use attachments / accessories specified by the manufacturer.
11. Use only with a cart, stand, tripod, bracket, or table specified by the manufacturer, or sold with the apparatus. When a cart is used, use caution when moving the cart/apparatus combination to avoid injury from tip-over.
12. Unplug this apparatus during lightning storms or when unused for long periods of time.
13. Refer all servicing to qualified service personnel. Servicing is required when the apparatus has been damaged in any way, such as power-supply cord or plug is damaged, liquid has been spilled or objects have fallen into the apparatus, the apparatus has been exposed to rain or moisture, does not operate normally, or has been dropped.
14. This appliance shall not be exposed to dripping or splashing water and that no object filled with liquids such as vases shall be placed on the apparatus.
15. Power Sources – The appliance should be connected to a power supply only of the type described in the operating instructions or as marked on the appliance. Do not overload wall outlet.



16. Battery shall not be exposed to excessive heat such as sunshine, fire or the like
17. Danger of explosion if battery is incorrectly replaced. Replace only with the same or equivalent type.
18. Do not attempt to dismantle, open or repair this product yourself. If a fault occurs, seek advice from your local qualified service technician or contact the distributor via the telephone number at the back of this instruction manual.
19. Caution marking and nameplate are located on bottom of product.

IMPORTANT NOTE

Avoid installing the unit in locations described below:

- Places exposed to direct sunlight or close to heat radiating appliances such as electric heaters.
- Places subject to constant vibration.
- Dusty, humid or moist places.
- Sources of electrical noise such as fluorescent lamps or motors.
- In case of malfunction due to electrostatic discharge, the apparatus has to be reset by disconnecting it from mains supply, wait at least for 60 seconds before reconnect the AC power cord.

COMPLIANCE WITH FCC REGULATIONS

FCC ID: OKUSB78QGC0

This device complies with Part 15 of the FCC Rules. Operation is subject to the following two conditions:

- (1) this device may not cause harmful interference, and
- (2) this device must accept any interference received, including interference that may cause undesired operation.

NOTE: This equipment has been tested and found to comply with the limits for a Class B digital device, pursuant to Part 15 of the FCC Rules. These limits are designed to provide reasonable protection against harmful interference in a residential installation. This equipment generates, uses and can radiate radio frequency energy and, if not installed and used in accordance with the instructions, may cause harmful interference to radio communications. However, there is no guarantee that interference will not occur in a particular installation. If this equipment does cause harmful interference to radio or television reception, which can be determined by turning the equipment off and on, the user is encouraged to try to correct the interference by one or more of the following measures:

- Reorient or relocate the receiving antenna.
- Increase the separation between the equipment and receiver.
- Connect the equipment into an outlet on a circuit different from that to which the receiver is connected.
- Consult the dealer or an experienced radio/TV technician for help.

CAUTION: Changes or modifications not expressly approved by the party responsible for compliance could void the user's authority to operate the equipment.

Protect Your Furniture

This product is equipped with non-skid rubber 'feet' to prevent the product from moving when you operate the controls. These 'feet' are made from non-migrating rubber material specially formulated to avoid leaving any marks or stains on your furniture. However certain types of oil based furniture polishes, wood preservatives, or cleaning sprays may cause the rubber 'feet' to soften, and leave marks or a rubber residue on the furniture. To prevent any damage to your furniture we strongly recommend that you purchase small self-adhesive felt pads, available at hardware stores and home improvement centers everywhere, and apply these pads to the bottom of the rubber 'feet' before you place the product on fine wooden furniture.

DEAR JENSEN® CUSTOMER

Selecting fine audio equipment such as the unit you've just purchased is only the start of your musical enjoyment. Now it's time to consider how you can maximize the fun and excitement your equipment offers. This manufacturer and the Electronic Industries Association's Consumer Electronics Group want you to get the most out of your equipment by playing it at a safe level. One that lets the sound come through loud and clear without annoying blaring or distortion and, most importantly, without affecting your sensitive hearing.

Sound can be deceiving. Over time your hearing "comfort level" adapts to higher volumes of sound. So what sounds "normal" can actually be loud and harmful to your hearing. Guard against this by setting your equipment at a safe level BEFORE your hearing adapts.

To establish a safe level:

- Start your volume control at a low setting.
- Slowly increase the sound until you can hear it comfortably and clearly, and without distortion.

Once you have established a comfortable sound level:

- Set the dial and leave it there.

Taking a minute to do this now will help to prevent hearing damage or loss in the future. After all, we want you listening for a lifetime.

We Want You Listening For a Lifetime

Used wisely, your new sound equipment will provide a lifetime of fun and enjoyment. Since hearing damage from loud noise is often undetectable until it is too late, this manufacturer and the Electronic Industries Association's Consumer Electronics Group recommend you avoid prolonged exposure to excessive noise.

Customer's Record:

The serial number of this product is found on its bottom cover. You should note the serial number of this unit in the space provided as a permanent record of your purchase to aid in identification in the event of theft or loss.

Model Number: JSBW-650

Serial Number: _____

ACCESSORIES

- 1 x AC Adaptor
- 1 x Remote Control,
- 1 x Stereo Audio Connection Cable with 3.5mm stereo plugs
- 1 x User Manual
- 1 x RCA Connection Cable
- 1 x Speaker Base for Stand
- 1 x Wall Mount Template
- 2 x Metallic Wall Mount Brackets
- 4 x Anchor (For Wall Mounting)
- 4 x Flat Head Screws (For Wall Mounting)
- 1 x Round Head Screw (For Vertical Base Mounting)

INSTALLATIONS

Placing the JSBW-650 on a table

Ventilation

When placing the Sound Bar on an entertainment center, bookshelf, or any type of enclosed space, be sure to allow at least 2-3 inches of space around the Sound Bar for ventilation. If the Sound Bar is enclosed in a tight space, without ventilation, heat generated from the Sound Bar could create potential overheating.

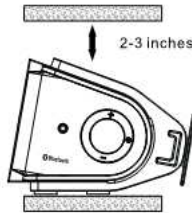

Placing the JSBW-650 on the floor (vertical configuration)

Attach the base as shown below and use the supplied round head screw to secure it to the sound bar. Be sure the assembled sound bar is placed on a level surface.

Note: The JENSEN logo on the front of the speaker can be rotated 90 degrees for vertical mounting.

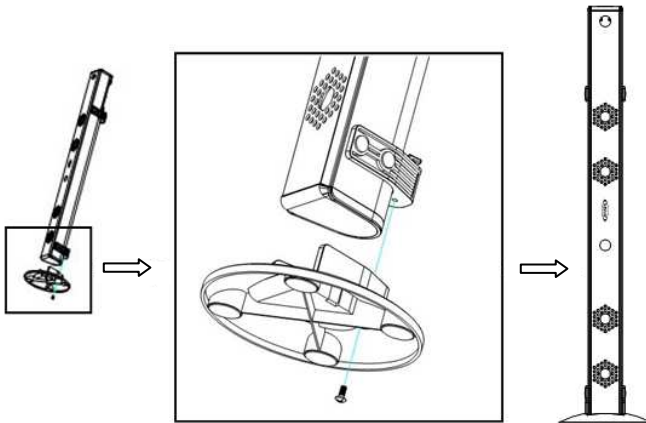

Mounting the JSBW-650 on a wooden wall

It's important to be sure there are no electric, gas or water lines located behind the wall where you are attaching the sound bar. We recommend having this speaker professionally installed. Use the included wall mounting accessories and template to attach the sound bar to the wall.

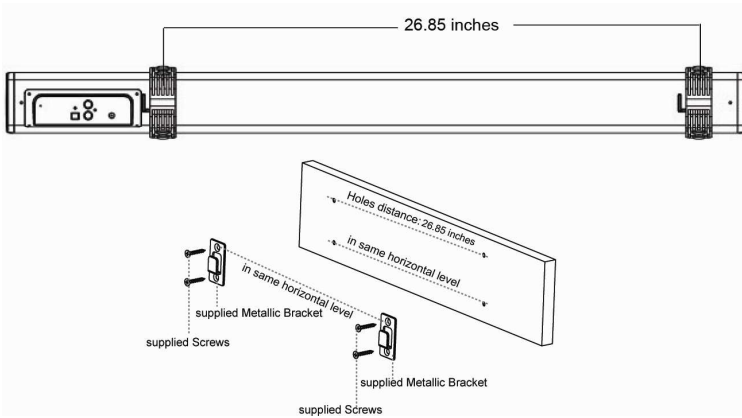

1. Use the supplied wall mounting template to make drill hole marks on the wall. Make sure the marks are level before drilling.
2. Attach the Metallic Brackets to the wall by screwing the supplied flat head screws directly into the marks that you have made on the wall as shown above.
3. Place the sound bar onto the mounting brackets. Make sure the sound bar is attached firmly to the wall.

Mounting the JSBW-650 on wall

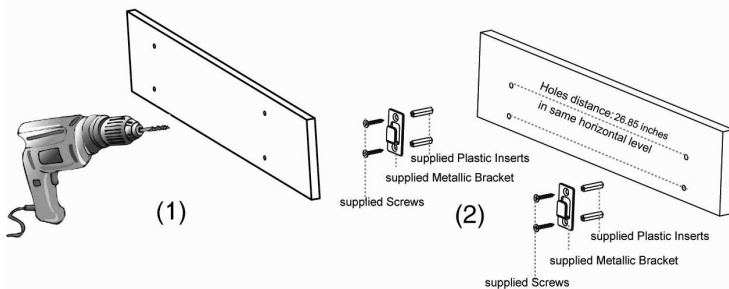

Use a power drill to make pilot holes for the plastic anchors

1. Use the supplied wall mounting template to make drill hole marks on the wall for the anchors. Make sure the marks are level before drilling.
2. Use a 1/4" (6.35mm) bit and power drill (Not supplied) to drill holes on the marks.
3. Insert the included plastic anchors into the holes and push in until they are flush with the wall.
4. Secure the supplied Metallic Brackets to the wall by screwing the included flat head

screws into the anchors and tighten until the screw head is fully inserted and flush with the metallic bracket.

5. Place the sound bar onto the mounting brackets. Make sure the sound bar is attached firmly to the wall.

LOCATION OF CONTROLS

MAIN UNIT

Front View

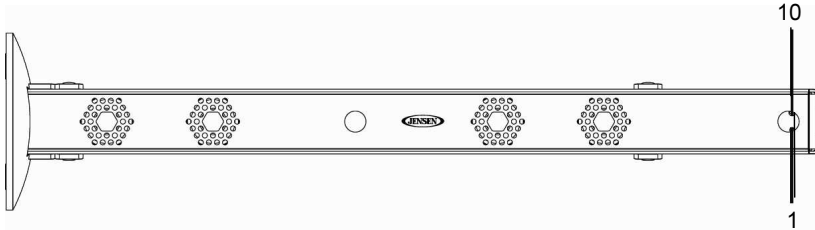

Back View

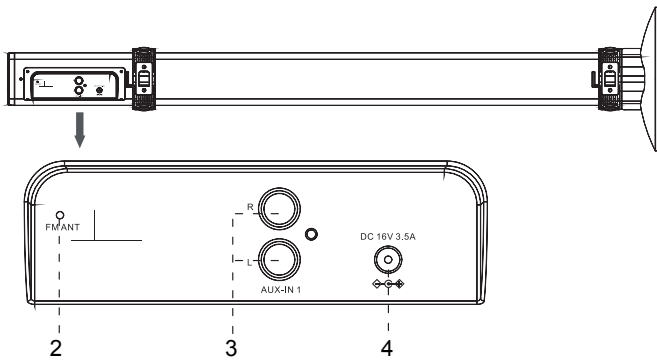



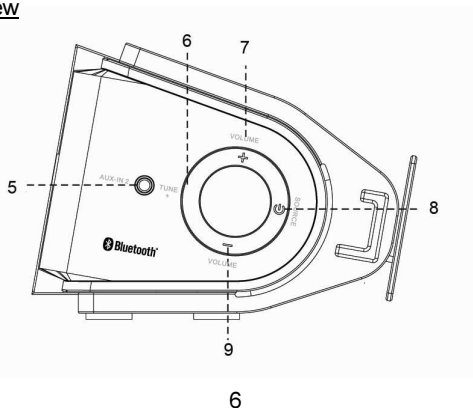

Right Hand Side View



1. MODE INDICATOR LED
2. FM WIRE ANTENNA
3. AUX-IN 1 L/R RCA CONNECTORS
4. DC IN JACK
5. AUX-IN 2 JACK
6. FM TUNE +
7. VOLUME + BUTTON
8. POWER ON/STANDBY ; SOURCE BUTTON
9. VOLUME - BUTTON
10. REMOTE INFRARED SENSOR

REMOTE CONTROL



1. POWER ON/STANDBY  BUTTON
2. VOLUME – BUTTON
3. SOURCE BUTTON
4. BASS – BUTTON
5. TREBLE – BUTTON
6. TUNE-/SKIP BACKWARD  BUTTON, FM Mono/Stereo BUTTON
7. BLUETOOTH PLAY/PAUSE  BUTTON, FM Mono/Stereo BUTTON
8. MUTE  BUTTON
9. VOLUME + BUTTON
10. BASS + BUTTON
11. BLUETOOTH PAIR BUTTON
12. TREBLE + BUTTON
13. EQ BUTTON
14. TUNE+/SKIP FORWARD  BUTTON

GETTING STARTED

CONNECTING THE JSBW-650 TO EXTERNAL AUDIO DEVICES

You can connect the JSBW-650 audio input to the audio output of your television or DVD Player. Please see figure below.

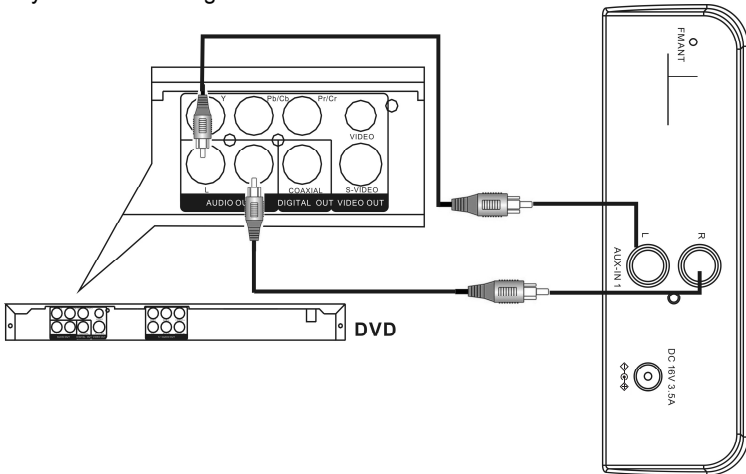

NOTE:

1. Make sure that the power is turned off when connecting or disconnecting the other devices. Make sure that the other devices are connected to the correct terminals.
2. This unit is not magnetically shielded and may cause color distortion on the screen of some TVs or video monitors. To avoid this, you may need to move the unit further away from the TV or monitor if unnatural color shifts or image distortion occurs.

CONNECTING THE AC POWER

This unit operates using the included AC adaptor with 16V \equiv 3.5A (center-positive \diamond - \ominus - \diamond) output, and is compatible with standard 120V~ 60Hz AC household power

1. Insert the the DC Plug of the AC Adaptor into the DC IN jack on the back of the unit. Plug the AC Adaptor into a standard 120V~ 60Hz AC wall outlet.
2. Press the Power On/Standby ⏻ button on main unit or remote control to turn on the unit. Mode LED Indicator changes color from red to relative mode.
3. Press the Power On/Standby ⏻ button on remote control or press and hold the ⏻ /SOURCE button on the main unit to turn the unit into standby mode after you finish listening.

REMOTE CONTROL BATTERY INSTALLATION

The remote control operates on one CR2025 battery (included). To activate the remote control, remove the insulation tab inserted in the battery compartment. To remove the tab, pull it in the direction of the arrow in the illustration as shown.

When the operation of the remote control becomes intermittent or unsatisfactory, replace the original battery with a new 3-volt lithium battery.

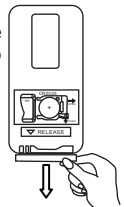

Replacing the battery in the remote control:

- 1.) Press in on the side of the battery holder and pull the holder out of the remote.
- 2.) Removed the exhausted battery and then install 1 new "CR2025" lithium battery according to the polarity diagram on the battery compartment.
- 3.) Insert the battery holder into the remote control and make sure it locks into place.

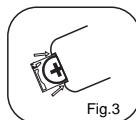
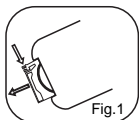

NOTE: Only use a well-known brand of battery to ensure the longest life and best performance.

Battery Precautions

- Replacement of batteries must be done by an adult.
- The supply terminals are not to be short-circuited.
- Non-rechargeable batteries are not to be recharged.
- Exhausted batteries are to be removed.
- Only batteries of the equivalent type are to be used.
- Batteries are to be inserted with the correct polarity.
- Dispose of batteries properly. Do not dispose of batteries in fire. The batteries may explode or leak.



WARNING

DO NOT INGEST BATTERY, CHEMICAL BURN

HAZARD







The remote control supplied with this product contains a coin/button cell battery. If the coin/button cell battery is swallowed, it can cause severe internal burns in just 2 hours and can lead to death.

Keep new and used batteries away from children. If the battery compartment does not close securely, stop using the product and keep it away from children.

If you think batteries might have been swallowed or placed inside any part of the body, seek immediate medical attention.

LISTENING TO THE FM RADIO

TUNING THE FM RADIO

1. Press the  POWER button to turn on the unit.
2. Press the SOURCE button on remote control or tap the /SOURCE button on main unit repeatedly to select FM radio mode, the Mode Indicator LED turns to purple color.
3. To manually tune a radio station, press the TUNE +  / TUNE -  button on the remote control repeatedly to change stations. Use the manual tuning method to tune to weaker stations that are occasionally skipped during Automatic Tuning.
4. To automatically tune to the next radio station with the strongest signal, press and hold the  /  button on the remote for 1-2 seconds until the purple FM indicator begins to flash. Release the button or tap the TUNE + button on main unit. The tuner will stop scanning when it receives the next strongest station signal.
5. Press the VOLUME +/- button to adjust the volume control to the desired level.
6. If necessary, press the EQ to select one of the preset EQ settings or the TREBLE and BASS +/- buttons on the remote control to adjust the separate treble and bass levels.

NOTE:

1. Press and hold the EQ Button for 5 seconds to reset the EQ to the default (NORMAL) setting. BASS and TREBLE settings will also be reset to the center position.
2. If you press the BASS or TREBLE buttons (+ or -) while listening, the EQ will reset to the default (NORMAL) setting to allow you to increase or decrease the BASS and TREBLE as needed.

FM & FM-Stereo reception

- When listening to the FM radio, press the FM MO/ST (MONO/STEREO) button to switch between stereo mode and mono mode. It is preferable to receive the program in mono when you are receiving a weak station.

HINTS FOR BEST RECEPTION:

To obtain the best FM/FM Stereo reception, unwrap and fully extend the FM Antenna and adjust the position of the wire for best station reception



- NOTE:** Automatic tuning depends on the signal strength of the broadcasting station, so weak stations may be skipped. You can manually tune to find the weak stations if a station gets skipped. With strong signals, the tuner may stop before it reaches the actual broadcast frequency, so you may need to manually tune for the best reception.

BLUETOOTH OPERATION

PAIRING (LINKING) A BLUETOOTH ENABLED CELL PHONE OR OTHER BLUETOOTH ENABLED DEVICE to the JSBW-650

1. With the power on, press the SOURCE button on remote control or tap the SOURCE button on main unit repeatedly to select Bluetooth mode. The Mode Indicator LED turns blue and will be flashing. The JSBW-650 is now ready to pair (link) with your Bluetooth device.
2. Turn on the Bluetooth feature of your cell phone and enable the search or scan feature to find the JSBW-650.
3. Select "JSBW-650" from the device list when it appears on your device screen. If required, enter the pass code "0000" to pair (link) the JSBW-650 with your cell phone.
4. After successfully pairing (linking) your cell phone with the JSBW-650, the Mode Indicator LED stops flashing and remains lit blue. You can now play music from your cell phone or Bluetooth device wirelessly to the JSBW-650.



Note: If you want to connect the JSBW-650 to another cell phone after pairing successfully, then you need to turn off the Bluetooth on the paired cell phone first if it is in range before going through the above steps. Otherwise, the JSBW-650 will automatically reconnect to the previously linked cell phone or device.

5. Press the VOLUME +/- button to adjust the desired volume level.
6. To turn off the JSBW-650 Bluetooth, press the  POWER button on remote control or press and hold the SOURCE button on main unit to turn the unit to standby mode. Mode Indicator LED turns red. Don't forget to also turn off the Bluetooth feature on your cell phone or Bluetooth device.

Notes:

- 1.) Refer to manual of your cell phone or other Bluetooth enabled device for Bluetooth operation, since it may vary from model to model.
- 2.) If your Bluetooth enabled device does not support A2DP, it will not play the music through the speaker, even after it's paired (linked).
- 3.) If you are pairing (linking) your computer to the JSBW-650 using Bluetooth, you may need to set the JSBW-650 as your computer's default sound device.

CONTROLLING THE MUSIC PLAYBACK ON YOUR BLUETOOTH DEVICE USING THE REMOTE CONTROL

1. Press the  POWER button to turn on the unit.
2. Turn on Bluetooth of your cell phone or device which was previously paired with the JSBW-650, press the SOURCE button on remote control or tap SOURCE button

on main unit repeatedly to select the Bluetooth mode, the Mode Indicator LED turns blue and begins flashing.

3. After the Bluetooth device is paired with the JSBW-650, wait for around 5 seconds and then press the PLAY/PAUSE ►|| button on remote control to start music playback from your cell phone or Bluetooth device.
4. Press the PLAY/PAUSE ►|| button to pause or resume playback.
5. Press the VOLUME+/- button to adjust your desired volume level
6. If necessary, press the TREBLE or BASS +/- buttons on the remote control to adjust the separate treble and bass levels.
7. Press the ◀◀ or ▶▶ button on the remote to select the desire music track.
8. Press the ⏻ POWER button on remote control or press and hold the ⏻ button on main unit to turn off the unit after listening.

Re-linking to a cell phone or Bluetooth device

If your cell phone or Bluetooth device is already paired with the JSBW-650, but became unlinked at some point, even with both Bluetooth devices turned on. You can re-link them by:

1. Press and hold the PAIR button to re-link your cell phone. The Mode Indicator LED will turn blue and flash while linking.
2. Select the JSBW-650 from the devices list on your cell phone for linking. The Mode Indicator LED stops flashing and remains lit blue if the JSBW-650 and your cell phone have been re-linked successfully.
3. You can also re-link the JSBW-650 by using Bluetooth operation of your cell phone. Please refer to operation manual of your cell phone for more information.

PRESET EQ (REMOTE CONTROL ONLY)

The JSBW-650 features 5 different EQ modes to enhance your listening experience. You can select the desired effect by pressing the "EQ" button on remote control repeatedly at following sequence:





In addition, you can adjust treble and bass effects by using the TREBLE & BASS +/- buttons.

NOTE:



1. Press and hold the EQ Button for 5 seconds to reset the EQ to the default (NORMAL) setting. BASS and TREBLE settings will also be reset to the center position.
2. If you press the BASS or TREBLE buttons (+ or -) while listening, the EQ will reset to the default (NORMAL) setting to allow you to increase or decrease the BASS and TREBLE as needed.

MUTE (Remote Control Only)

- Press the MUTE  button on remote control to mute the sound output from speaker temporarily, the Mode Indicator LED will flash.
- Press the  button again to resume to normal speaker playback.

LISTENING TO AUDIO FROM A TV/DVD PLAYER/VCR OR DVR

You can connect the JSBW-650 to other external audio devices using the AUX-IN 1 RCA connectors located on the back of the unit.

1. Connect the external TV/DVD/VCR/DVR to AUX-IN 1 RCA connectors on the back of the unit (RCA connection cable included). Make sure the color coded plugs are attached to the corresponding color coded connectors on the device.
2. Press the  POWER button to turn the unit on.
3. Select external audio input by pressing the SOURCE button on the remote control or tap the /SOURCE button on the main unit repeatedly to select AUX IN 1 mode, Mode Indicator LED turns green.
4. The volume level can now be controlled through the main unit. Operate all other functions on the external device as usual.

AUXILIARY INPUT

This unit provides an auxiliary audio signal input jack for connecting external audio devices like MP3 players, CD players and listen to them through the speakers of this unit.

1. Use an audio cable (included) with one 3.5 mm stereo plug on each end of the cable.
2. Plug one end into the AUX-IN 2 jack on the right hand side (top panel) of main unit and the other end of the cable into the Line-out Jack or Headphone Jack of your external audio device.
3. Turn on the external audio device and the main unit.
4. To select auxiliary audio input, press the SOURCE button on remote control or tap /SOURCE button on main unit repeatedly to select AUX IN 2 mode, Mode Indicator LED turns orange.
5. The volume level can now be controlled through the main unit. Operate all other functions on the auxiliary device as usual.

NOTE:

- If you connect this unit to the Line-Out Jack of your external device then you only need to adjust the volume control of this unit. If you connected the Headphone Jack of your external device then you may need to adjust both the volume control of your

external device and the volume control of this unit to find the most desirable volume setting.

- Press the  POWER button to turning off the unit when you finish listening. Don't forget to switch off the power of your external device as well.

CARE AND MAINTENANCE

1. Do not subject the unit to excessive force, shock, dust or extreme temperature.
2. Do not tamper the internal components of the unit.
3. Clean your unit with a dry cloth. Solvent or detergent should never be used.
4. Avoid leaving your unit in direct sunlight or in hot, humid or dusty places.
5. Keep your unit away from heating appliances and sources of electrical noise such as fluorescent lamps or motors.

CLEANING THE UNIT

- To prevent fire or shock hazard, disconnect your unit from the AC power source when cleaning.
- The finish on the unit may be cleaned with a dust cloth and cared for as other furniture. Use caution when cleaning and wiping the plastic parts.
- If the cabinet becomes dusty wipe it with a soft dry dust cloth. Do not use any wax or polish sprays on the cabinet.
- If the front panel becomes dirty or smudged with fingerprints it may be cleaned with a soft cloth slightly dampened with a mild soap and water solution. Never use abrasive cloths or polishes, as these will damage the finish of your unit.

CAUTION: Never allow any water or other liquids to get inside the unit while cleaning.

TROUBLESHOOTING GUIDE

Should you experience difficulties in the use of this player please refer to the following chart or call 1-800-777-5331 for Product Service and Support.

Symptom	Possible Problem	Solution
The unit does not respond (no power)	The unit is disconnected from the AC outlet.	Reconnect to the AC outlet.
	The AC outlet has not power.	Try the unit on another outlet.
Unit is ON but there is low or no volume	The volume control has been turned all the way down.	Turn the Volume control to a higher output.
No Sound	Bluetooth speaker is not linked with the cell phone	Go through "Bluetooth Operations" process to link the speakers.
	Speaker placement out of range	Relocate the speaker within Bluetooth operating range
Noise or sound distorted on FM broadcast	Station not tuned properly for FM.	Full extend or rotate the wire antenna for best reception. Retune the FM broadcast station.
Sound is distorted	Volume level is set too high.	Decrease the volume.

	Sound source is distorted.	If the external device original sound source is of poor quality, distortion and noise are easily noticed with high-power speakers. Try a different audio source such as a music CD. If you are using an external sound source like older generation of iPod, try reducing the output volume on the device itself. Also try turning bass boost OFF or change the EQ setting.
Unit gets warm after extended play at high volume	This is normal.	Turn the unit off for a period of time or lower volume.

SPECIFICATION

Power requirement:

Main Unit AC-DC Adaptor DC 16V, 3.5A 

Remote Control 1 X DC 3V CR2025 lithium Battery

Frequency Range

Radio Band FM 87.5 ~ 108 MHz



At Spectra, environmental and social responsibility is a core value of our business. We are dedicated to continuous implementation of responsible initiatives with an aim to conserve and maintain the environment through responsible recycling.

Please visit us at <http://www.spectraintl.com/green.htm> for more information on Spectra's green initiatives or to find a recycler in your area.

The *Bluetooth*® word mark and logos are registered trademarks owned by Bluetooth SIG, Inc. and any use of such marks by Spectra Merchandising Intl, Inc. is under license. Other trademarks and trade names are those of their respective owners.

**90 DAY LIMITED WARRANTY AND SERVICE
VALID IN THE U.S.A. ONLY**

SPECTRA MERCHANDISING INTERNATIONAL, INC. warrants this unit to be free from defective materials or factory workmanship for a period of 90 days from the date of original customer purchase and provided the product is utilized within the U.S.A. This warranty is not assignable or transferable. Our obligation under this warranty is the repair or replacement of the defective unit or any part thereof, except batteries, when it is returned to the SPECTRA Service Department, accompanied by proof of the date of original consumer purchase, such as a duplicate copy of a sales receipt.

You must pay all shipping charges required to ship the product to SPECTRA for warranty service. If the product is repaired or replaced under warranty, the return charges will be at SPECTRA's expense. There are no other express warranties other than those stated herein.

This warranty is valid only in accordance with the conditions set forth below:

1. The warranty applies to the SPECTRA product only while:
 - a. It remains in the possession of the original purchaser and proof of purchase is demonstrated.
 - b. It has not been subjected to accident, misuse, abuse, improper service, usage outside the descriptions and warnings covered within the user manual or non-SPECTRA approved modifications.
 - c. Claims are made within the warranty period.
2. This warranty does not cover damage or equipment failure caused by electrical wiring not in compliance with electrical codes or SPECTRA user manual specifications, or failure to provide reasonable care and necessary maintenance as outlined in the user manual.
3. Warranty of all SPECTRA products applies to residential use only and is void when products are used in a nonresidential environment or installed outside the United States.

This warranty gives you specific legal rights, and you may also have other rights which vary from state to state. TO OBTAIN SERVICE please remove all batteries (if any) and pack the unit carefully and send it freight prepaid to SPECTRA at the address shown below. IF THE UNIT IS RETURNED WITHIN THE WARRANTY PERIOD shown above, please include a proof of purchase (dated cash register receipt) so that we may establish your eligibility for warranty service and repair of the unit without cost. Also include a note with a description explaining how the unit is defective. A customer service representative may need to contact you regarding the status of your repair, so please include your name, address, phone number and email address to expedite the process.

IF THE UNIT IS OUTSIDE THE WARRANTY PERIOD, please include a check for **\$ 55.00** to cover the cost of repair, handling and return postage. All out of warranty returns must be sent prepaid.

It is recommended that you contact SPECTRA first at 1-800-777-5331 or by email at custserv@spectrainintl.com for updated information on the unit requiring service. In some cases the model you have may be discontinued, and SPECTRA reserves the right to offer alternative options for repair or replacement.

SPECTRA MERCHANDISING INTERNATIONAL, INC.
4230 North Normandy Avenue,
Chicago, IL 60634, USA.
1-800-777-5331

To register your product, visit the link on the website below to enter your information.
<http://www.spectrainintl.com/wform.htm>

0521

Printed in China
(JSBW-650A)

FCC Warning

This device complies with part 15 of the FCC rules. Operation is subject to the following two conditions: (1) this device may not cause harmful interference, and (2) this device must accept any interference received, including interference that may cause undesired operation.

Changes or modifications not expressly approved by the party responsible for compliance could

void the user's authority to operate the equipment.

NOTE: This equipment has been tested and found to comply with the limits for a Class B digital

device, pursuant to part 15 of the FCC Rules. These limits are designed to provide reasonable protection against harmful interference in a residential installation. This equipment generates uses and can radiate radio frequency energy and, if not installed and used in accordance with the

instructions, may cause harmful interference to radio communications. However, there is no guarantee that interference will not occur in a particular installation. If this equipment does cause harmful interference to radio or television reception, which can be determined by turning the equipment off and on, the user is encouraged to try to correct the interference by one or more of the following measures:

- Reorient or relocate the receiving antenna.
- Increase the separation between the equipment and receiver.
- Connect the equipment into an outlet on a circuit different from that to which the receiver is connected.
- Consult the dealer or an experienced radio/TV technician for help.

Radiation Exposure Statement

This equipment complies with FCC radiation exposure limits set forth for an uncontrolled environment. This equipment should be installed and operated with minimum distance 20cm between the radiator and your body.