



**BELMONT
8-IN-1 WOOD MUSIC CENTER**

VWRP-3600



Instruction Manual

Please read carefully before use and keep for future reference.

WARNING



CAUTION: TO REDUCE THE RISK OF ELECTRIC SHOCK, DO NOT REMOVE COVER (OR BACK). NO USER SERVICEABLE PARTS INSIDE. REFER SERVICING TO QUALIFIED SERVICE PERSONNEL.



DANGEROUS VOLTAGE: The lightning flash with arrowhead symbol within an equilateral triangle is intended to alert the user to the presence of uninsulated dangerous voltage within the product's enclosure that may be of sufficient magnitude to constitute a risk of electric shock to persons.



ATTENTION: The exclamation point within an equilateral triangle is intended to alert the user to the presence of important operating and maintenance (servicing) instructions in the literature accompanying the appliance.



WARNING: Invisible laser radiation when open and interlock failed or defeated. Avoid direct exposure to laser beam.



This equipment is a Class II or double insulated electrical appliance. It has been designed in such a way that it does not require a safety connection to electrical earth.

Important Safety Instructions

1. Read these instructions – All the safety and operating instructions should be read before this product is operated.
2. Keep these instructions – The safety and operating instructions should be retained for future reference.
3. Heed all warnings – All warnings on the appliance and in the operating instructions should be adhered to.
4. Follow all instructions – All operating and use instructions should be followed.
5. Do not use this apparatus near water – The appliance should not be used near water or moisture – for example, in a wet basement or near a swimming pool.
6. Clean only with a dry cloth.
7. Do not block any ventilation openings. Install in accordance with the manufacturer's instructions.
8. Do not install near any heat sources such as radiators, heat registers, stoves, or other devices (including amplifiers) that produce heat.
9. Protect the power cord from being walked on or pinched – particularly at the plugs, power outlets, and at the point where they exit from the apparatus.
10. Only use attachments or accessories specified by the manufacturer.

11. Use only with the cart, stand, tripod, bracket, or table specified by the manufacturer, or sold with the apparatus. When a cart or rack is used, use caution when moving the cart/apparatus combination to avoid injury from tip-over.



12. Unplug the apparatus during lighting storms or when unused for long periods of time.
13. Refer all servicing to qualified personnel. Servicing is required when the apparatus has been damaged in any way, such as when a power supply cord or plug is damaged, liquid has been spilled or objects have fallen into the device, the device has been exposed to rain or moisture, the device does not operate normally, or the device has been dropped.
14. The mains plug is used as disconnect device. The disconnect device shall remain readily operable.
15. **WARNING:** To reduce the risk of fire or electric shock, do not expose this device to rain or moisture. The device shall not be exposed to dripping or splashing, and no objects filled with liquids, such as vases, shall be placed on the device.
16. Use the equipment only in moderate climates.
17. The ventilation should not be impeded. Do not cover the ventilation openings with items, such as newspapers, tablecloths, or curtains.
18. Do not place open flame sources, such as lighted candles, on the apparatus.
19. The symbol with \sim indicates AC voltage.
20. **CAUTION:** These servicing instructions are for use by qualified service personnel only. To reduce the risk of electric shock do not perform any servicing other than that contained in the operating instructions unless you are qualified to do so.

TABLE OF CONTENTS

FEATURES.....	6
SPECIFICATIONS	6
PRODUCT OVERVIEW	7
SET-UP & BASIC OPERATION.....	8
RADIO OPERATION.....	9
CD OPERATION.....	9
AUX-IN OPERATION.....	10
USB OPERATION	10
CASSETTE TAPE OPERATION	11
VINYL RECORD OPERATION	12
BLUETOOTH® OPERATION	13
CARE & MAINTENANCE	14
TROUBLESHOOTING GUIDE	17
FCC NOTICE.....	18
CAUTION ON MODIFICATIONS	19
SUPPORT.....	19

FEATURES

The 8-in-1 Belmont Wooden Music Center features a great retro design and solid wood construction. With a 3-Speed turntable, CD, and Cassette Player, the unit is ready to play all your music! The Dual Bluetooth feature allows streaming of your music to an external speaker. Record and playback all your favorite songs with the built in USB player & recorder. It also features built-in Speakers and an AM/FM Radio.

- 3-Speed record player with Auto Return will play 33 1/3, 45, 78 rpm records.
- Bluetooth In connectivity allows you to stream music from another source up to 33 feet away.
- Bluetooth Out Connectivity allows you to stream vinyl playback through any external Bluetooth Speaker.
- CD Player, Cassette Player, and AM/FM Radio.
- USB Input for Playback & One Touch Recording of your favorite music.
- Built-in Stereo Speakers for playback convenience.
- Includes a 3.5mm Aux input for additional connectivity options.

SPECIFICATIONS

Product Name	BELMONT (8-in-1 Wood Music Center)
Turntable Speed	33 1/3, 45, 78 RPM
FM Frequency Range	88 - 108MHz
AM Frequency Range	530 - 1710KHz
Bluetooth® Version	V5.1
Bluetooth® Transmission Distance	Up to 33 feet (10 Meters)*
Input	Aux In, USB
Output	Line Out
Built-in Speakers	3" x 2
Power Output	5W x 2
Power Source	AC/DC 100-240V 50-60Hz 9V/1.5A
Accessories Included	45 RPM Adaptor, Aux In Cable, Power Adaptor, User Manual, Quick Set-Up Guide, 3 Record Needles, Microfiber Cleaning Cloth, and Warranty Card

* Distance may vary depending on any objects or interference between devices.

**SPECIFICATIONS AND ACCESSORIES ARE SUBJECT TO CHANGE
WITHOUT NOTICE**

PRODUCT OVERVIEW

Turntable

1. Turntable Platter
2. Turntable Spindle
3. Transport Screw
4. Cue Lever
5. Speed Selector
6. Hold Down Clip
7. Tone Arm

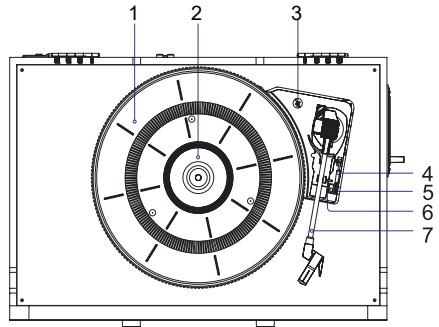

Front Panel

1. USB Port
2. CD Door
3. AUX IN Jack
4. Volume +/- Power
5. Function Knob
6. Record/Erase Button
7. Open/Close
8. Repeat /FOL+ Button
9. Rewind / Previous Button
10. Display
11. Fast Forward / Next Button
12. Stop / Pair Button
13. PROG/FOL-
14. Play/ Pause /BT Out Button
15. ERA Indicator
16. RX Indicator
17. REC Indicator
18. TX Indicator
19. Tuning Knob

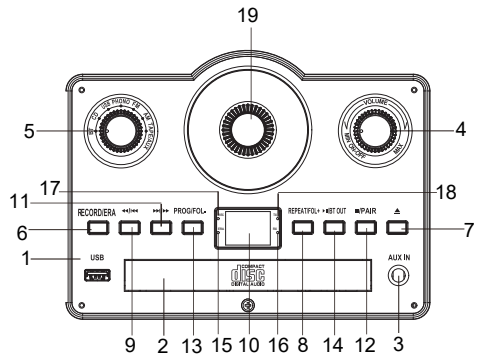

Back Panel

1. FM Antenna
2. Cassette Eject/Fast Forward Button

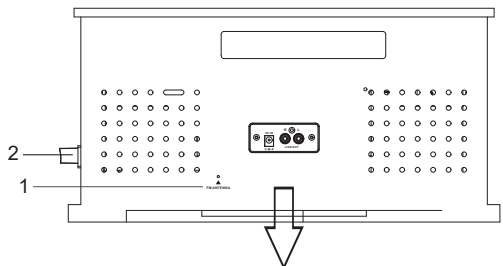

3. DC IN Jack
4. Line Out Jack

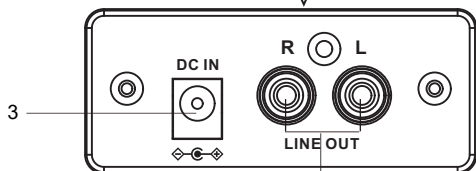

SET-UP & BASIC OPERATION

Essential Set-up

1. Unpack the unit and remove all packaging materials.
2. Place the unit on a flat and level surface. The selected location should be stable and free from vibration.
3. Plug the power adaptor into a 120V AC electrical outlet and the other end into the port at the back of the unit.
4. Extend the FM antennae.
5. Turn on the unit by rotating the Volume/Power knob clockwise until you hear a 'click' sound.

To Open Turntable Cover

1. Lift the turntable cover all the way up until it stops.
2. Lower the cover slowly until the latch engages. If the latch does not engage, pull the lower bar by hand.
3. The cover will now stay open.

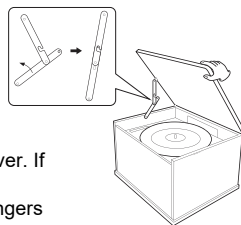

To Close Turntable Cover

1. Lift the cover all the way up until it stops.
2. The latch should disengage and you may now slowly lower the cover. If the latch does not disengage, push out the lower bar by hand.

CAUTION: Make sure you hold the cover to avoid pinching your fingers as it closes.

Common Playback Control

- Press the PLAY/PAUSE button to pause/play the playback.
- Press the <</> or >>/> button to skip to next or previous track.
- To search for a part of track: press and hold the <</> or >>/> buttons and release it when the part you want is found.
- To search for and choose a folder, press and hold the PROG/FOL- button or REAPT/FOL+ button.
- To stop playing, press the STOP/PAIR button.

Note: These controls do NOT always function in specified playback mode.

Repeat Function

Press the Repeat /FOL+ button:

- one time, to repeat the current track.
- two times, to repeat the current folder.

Press and hold Repeat /FOL+ button to skip to next file.

Note: This feature functions in CD and USB mode.

Program Function

This function enables you to set the playback of tracks into an ordered playlist.

1. Press the STOP button; then press the PROG/FOL- button to activate the program feature. The display will show "P01" and blinking.
2. Press the <</> or >>/> buttons to select your track.
3. Press the PROG/FOL- button again to confirm.
4. Repeat the above steps to program other tracks.
5. After finishing programming tracks, press the PLAY/PAUSE button to start playback.
6. Press the STOP button once to stop.
7. Press the STOP button twice to erase the programmed track.

Notes:

- This feature functions in CD and USB mode.
- This unit can program up to 20 tracks.
- Turning the power off or switching to other playback modes will automatically erase the programmed playlist.

RADIO OPERATION

1. Set the Function Knob to the **AM/FM** position to receive AM or FM signals.



2. Extend the FM antennae when you want to listen to FM stations.
3. Rotate the Tuning Knob to search for available stations.
4. Adjust the volume by rotating the VOLUME +/- Power knob.

You can improve the signal receiving strength by:

- Extending the FM Antenna to a higher position.
- Turn the unit to face different directions.
- Move the unit to a different place.
- Connect the FM Antenna to your outdoor antenna.

CD OPERATION

1. Set the Function Knob to the **CD** position.



2. Press the **▲** OPEN/CLOSE button to open the disc tray.
3. Place your desired audio CD on the tray with its label side up.
4. Press the **▲** OPEN/CLOSE button to close the tray.
5. The CD will start to play automatically.

Notes:

- Do not pull or push the disc tray manually.
- Ensure the disc is placed in the center of the disc tray with its label side up.
- Be sure the inserted disc is an Audio CD / MP3 CD, and not a DVD or any other type of disc.

AUX IN OPERATION

With the AUX IN function, you can play music from an external device on the speakers of your device.

1. Insert one end of the 3.5mm AUX IN Cable into the AUX IN Jack on the front control panel and the other end to your playing device.



2. Set the Function knob to the TAPE/AUX position.



3. Start to play your favorite music on your playing device.

USB OPERATION

1. Set the Function knob to the USB position.



2. Insert a USB device (only with .mp3 audio files) to the USB Port.
3. The unit will start playback automatically.
4. Use the volume and control buttons to control playback.

Note: control buttons may not work with all USB devices due to manufacturing differences.

Recording with USB

With this function you can record music from your player onto a USB device in .mp3 format.

1. Insert a USB device into the USB port.
2. Play music in the CD, AUX, Phono, BT or Tape mode.
3. Press the RECORD/ERASE button. The recording process will start and the REC Indicator will light up in the lower left corner of the display.

Note: The information on the display varies with the playback mode each time the RECORD/ERASE button is pressed.

4. Press the **STOP/PAIR** button to stop recording. 'END' will appear on display.

Note: If the unit does not play automatically, press the **◀/▶** buttons to listen to the latest record track.

Erasing Files In the USB Device

1. Insert a USB device into the USB port and play the song you want to delete.
2. Press and hold the **RECORD/ERASE** button for about two seconds. 'ERA' will light up and 'ONE' will appear on the display.
3. Press the **◀/▶** or **▶/▶▶** button to select:
 - a. ERA ONE - erase the current track
 - b. ERA FOLD - erase all the audio tracks in the entire folder
 - c. ERA ALL - erase all the audio tracks in the USB device
4. Press the **RECORD/ERASE** button again to confirm. The erasing process will start.
5. When all tracks and folders erased, 'NO' will be shown on display.

CASSETTE TAPE OPERATION

1. Set the Function Knob to **TAPE** position.



2. Insert a recorded cassette with its exposed side facing outwards. Push inwards until you hear a 'Click' sound. The cassette will be played automatically.

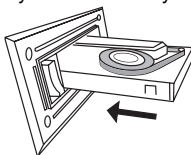

3. During playback, you can lightly press and hold the Eject/Fast Forward button to accelerate the playing speed. Release your finger when the part you want to listen to is found.

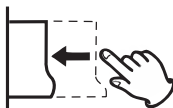

4. To stop playback and eject the tape, push the Eject/Fast Forward button all the way in until the tape is ejected.

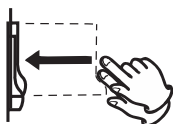

Note : Make sure to pull out the Aux in cable before playing the tape mode or the unit will switch to AUX mode automatically.

VINYL RECORD OPERATION

1. Press the Power Button to turn on the unit and open the cover.
2. Set the Function Knob to the 'PHONO' position.



3. Detach the stylus protector by pressing both sides and pulling straight in the direction shown.

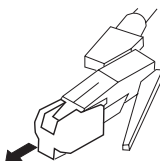

4. Place a vinyl record on the Turntable by aligning the Turntable Spindle to the record hole.
5. Slide the Speed Selector to 33, 45, or 78 to match the play speed of the record.
6. Unlock the Hold Down Clip.

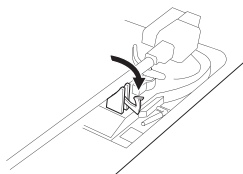

7. Raise the Cue Lever to lift the Tone Arm off the Tone Arm support.
8. Gently move the Tone Arm to the edge of the record (or the starting point of a track).
9. Release the Cue Lever to put the Tone Arm onto the record. The Turntable will begin playback.
10. Turn the VOLUME +/- Power to adjust the volume. To pause/stop during playback, raise the Cue Lever to lift the Tone Arm off the record.
11. When finished listening:
 - a. Raise the Cue Lever to lift the Tone Arm off the record.
 - b. Move the Tone Arm to its support.
 - c. Lower the Cue Lever to release the Tone Arm.
 - d. Lock the Hold Down Clip.

Note:

- The 45 RPM was packaged with this manual.
- Put the 45 RPM Adapter across the Turntable Spindle first if playing a 45 RPM record.

BLUETOOTH® OPERATION

With the Bluetooth® In function, you can play music from an external Bluetooth® device on the speakers of your VICTOR VWRP-3600.

1. Set the Function Knob to the **BT** position. 'BT' and 'RX' will blink on the display.



2. Turn on your external Bluetooth device and pair it with the **'VICTOR VWRP-3600'** device.
3. When the Bluetooth connection is established, you will hear a short confirmation sound from the unit, then 'BT' and 'RX' will stop blinking on the display.
4. Start to play your favorite music on the connected device.
5. Press and hold STOP/PAIR button to disconnect the current pairing.

Bluetooth® Transmitter

You can play music from your VICTOR VWRP-3600 on external Bluetooth® speakers, soundbars, earbuds, or headphones.

1. Disable the Bluetooth® function on all nearby devices (e.g. amplifier, soundbars, wireless headphones, smart phone, or tablets).
2. Play music in the CD, AUX, Phono, USB, Tuner, or Tape mode.
3. Press and hold the **Play/Pause/BT OUT** button to activate the Bluetooth Transmitter function. The TX indicator will start to blink in blue.
4. Power on your Bluetooth® speakers or headphones and activate its Bluetooth pairing mode.
5. After a few seconds, the blinking TX indicator will turn to solid blue and you will hear a beep. This means that the Turntable has been automatically connected.
6. To change volume playback, turn the volume knob on the unit or adjust the volume on your Bluetooth® device.
7. To turn off BT OUT mode, press and hold the **Play/Pause/BT OUT** button again. The TX indicator will be turned off.

CARE & MAINTENANCE

Always keep the turntable clean. If the surface of the unit gets dirty, wipe with a soft dry cloth or use a diluted mild liquid soap. Be sure to remove any excess liquid completely. Do not use thinner, benzene, or alcohol as they may damage the surface of the unit. Allow the surface of the unit to dry completely before using.

Beware of Condensation

When the unit (or a record/disc) is moved from a cold to warm place, or used after a sudden temperature change, condensation may form; vapor in the air could condense on the internal mechanism, making correct operation erratic or impossible. To prevent this, or if this occurs, leave the unit turned off for one or two hours. The unit will stabilize at the temperature of its surroundings.

Using Compact Discs

Discs which can be played on this unit:

- Conventional audio CDs
- Properly finalized CD-R and CD-RW discs
- Always place the disc on the disc tray with the label side up. (Compact discs can be played or recorded only on one side.)
- To remove a disc from its storage case, press down on the center of the case and lift the disc out, holding it carefully by the edges. Should the disc become dirty, wipe the surface radially (from the center hole outward towards the outer edge) with a soft, dry cloth.



How to remove the disc



How to hold the disc



How to clean the disc

- Never use such chemicals as record sprays, anti-static sprays or fluid, benzene, or thinner to clean the discs. Such chemicals will do irreparable damage to the disc's plastic surface.
- Discs should be returned to their cases after use to avoid dust and scratches that could cause the laser pickup to 'skip'.
- Do not expose discs to direct sunlight, high humidity, or high temperatures for extended periods. Long exposure to high temperatures will warp the disc.
- Do not play any disc that is warped, deformed or damaged. Playing such discs may cause irreparable harm to the playing mechanism.
- CD-R and CD-RW discs are more sensitive to the effects of heat and ultraviolet rays than ordinary CDs. It is important that they are not stored in a location where direct sunlight will fall on them, and away from sources of heat such as radiators or heat-generating electrical devices.
- Printable CD-R and CD-RW discs are not recommended, as the label side might be sticky and damage the unit.
- Do not stick papers or protective sheets on the discs, and do not use any protective coating spray.
- Use a soft oil-based felt-tipped pen to write the information on the label side. Never use a ball-point or hard-tipped pen, as this may cause damage to the recorded side.
- Never use a stabilizer. Using commercially available CD stabilizers with this unit will damage the mechanisms and cause them to malfunction.
- Do not use CDs with an irregular shapes (octagonal, heart shaped, business card size, etc.). CDs of this sort can damage the unit:



- If you are in any doubt as to the care and handling of a CD-R/CD-RW disc, read the precautions supplied with the disc, or contact the disc manufacturer directly.

CARE & MAINTENANCE

Using Cassette Tapes

Tape Handling:

- Use your finger or a pencil to turn the cassette tape's hub and take up any slack tape.
- Avoid touching the tape. Fingerprints attract dust and dirt.
- Avoid dropping or subjecting cassettes to excessive shocks.
- As C-120 tapes are physically weak and could become entangled in the transport mechanism, do not use them.

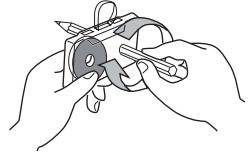

Do Not store tapes in the following places:

- On top of heaters, exposed to direct sunlight, or in any other places with high temperatures.
- Near speakers, on TV sets, on amplifiers, or where they would be exposed to strong magnetic fields.
- Where humidity is high or in dirty, dusty places.

Head Maintenance

The head and tape path should be cleaned and demagnetized periodically. Please use a cassette type head cleaning tape and demagnetizer. For specific details on the proper use of either item, please read each item's instruction manual.

Maintaining Vinyl Records

- Do not touch the record's grooves. Only handle records by edges or label.
- Make sure your hands are clean. Skin oils from even clean hands can leave a residue on the record surface that will gradually deteriorate the quality of your record.
- Keep your records away from dust. Store in a cool, dry place.
- Keep records in sleeves and jackets when not in use to avoid dust and scratches.
- Store records upright on edges. Records stored horizontally will bend and warp.
- Do not expose records to direct sunlight, high humidity, or high temperatures. Long exposure to high temperatures will warp records.
- Do not store records in the trunk of a car.
- Store records in an area with a stable temperature and low humidity.
- Should the record become dirty, gently wipe surface in a circular motion, using a soft anti-static cloth.

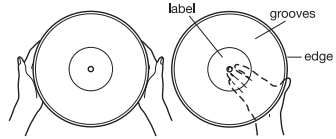

How to Replace the Stylus

The stylus should last about 50 hours under normal use. However, it is recommended that the stylus be replaced as soon as you notice a change in sound quality. Prolonged use of a worn-out stylus may damage the record. Wear and tear on the stylus will be accelerated when playing 78 RPM records. The higher speed of 78 RPM records can wear the stylus more quickly .

Caution:

- Do not bend the stylus.
- To avoid injury, do not touch the needle.
- Turn off the unit's power before you replace the stylus.
- Keep out of the reach of children.

CARE & MAINTENANCE

- Handle with care, as the stylus is delicate. Use of a bent or broken stylus may damage the record and cause the turntable to malfunction.
- Do not expose the stylus to extreme heat.
- Contact a qualified repair company if you experience difficulty in changing the stylus.

Removing an Old Stylus

1. Insert a flathead screwdriver at the tip of the stylus and push down to the direction 'A' as shown below.
2. Pull the stylus out toward direction 'B' as shown below.

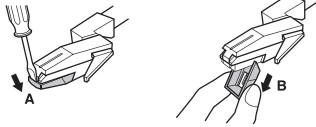

Installing a New Stylus

1. Hold the tip of the stylus and insert the other edge by pressing toward direction 'C' as shown below.
2. Push the stylus up toward direction 'D', as shown below, until it locks at the tip.

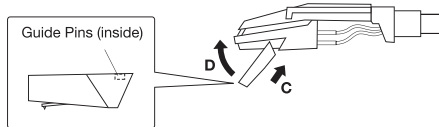

TROUBLESHOOTING GUIDE

In case of trouble with the unit, please look through the problems below and see if you can solve them yourself before calling your dealer.

Function	Problem	Solution
General	No power	<ul style="list-style-type: none"> Check the connection to the AC power source. Make sure the AC source is not a switched outlet and if it is, turn the switch on. Make sure there is power to the AC outlet by plugging in another device such as a lamp or fan.
	No sound	<ul style="list-style-type: none"> Adjust the volume Connect the AUX IN cables into the correct jack.
	The sound has interference	<ul style="list-style-type: none"> The unit is too close to a TV set or similar appliance. Relocate the unit further away from them or turn the other appliances off.
Radio	Cannot listen to any station or signal is weak	<ul style="list-style-type: none"> Tune in the station properly. If a TV is near the unit, turn it off. Rotate the unit or antenna wire for the best reception position.
Record Player	Will not play	<ul style="list-style-type: none"> Turn the VOLUME KNOB clockwise. Loosen the screw and detach the stylus guard. The stylus guard is a white plastic cover that protects the stylus during transportation. Failing to remove this guard will not allow the needle to contact the grooves of the record and no sound will be heard. If the stylus is worn-out, change the stylus. Select the correct playback speed.
	Sound skips	<ul style="list-style-type: none"> Place the unit on a stable surface to avoid vibration and shock. Make sure the unit is level--both front to back and side to side. Clean the surface of the record/disc. Do not use scratched, damaged or warped records/discs.
CD Player	Will not play	<ul style="list-style-type: none"> Turn the VOLUME knob clockwise and rotate the FUNCTION KNOB to 'CD'. Load a disc with the playback side facing down. If the disc is dirty, clean the surface of the disc. A blank disc has been loaded. Load a pre-recorded disc You cannot play back unfinalized CD-R/CD-RW discs. Finalize and try again.
Bluetooth®	Will not play	<ul style="list-style-type: none"> Device is NOT paired properly; turn OFF Bluetooth, turn ON Bluetooth and repair device.
Cassette Player	Button does not work	<ul style="list-style-type: none"> Insert the cassette tape securely.
	Sound is distorted	<ul style="list-style-type: none"> Clean and demagnetize the heads. Use normal tape.
AUX In	No Sound	<ul style="list-style-type: none"> Ensure external player works when not connected via AUX cable. Ensure AUX In cables are securely connected and not damaged. Increase the volume level.

FCC STATEMENT :

This device complies with Part 15 of the FCC Rules. Operation is subject to the following two conditions:

- (1) This device may not cause harmful interference, and
- (2) This device must accept any interference received, including interference that may cause undesired operation.

Warning: Changes or modifications not expressly approved by the party responsible for compliance could void the user's authority to operate the equipment.

NOTE: This equipment has been tested and found to comply with the limits for a Class B digital device, pursuant to Part 15 of the FCC Rules. These limits are designed to provide reasonable protection against harmful interference in a residential installation. This equipment generates uses and can radiate radio frequency energy and, if not installed and used in accordance with the instructions, may cause harmful interference to radio communications. However, there is no guarantee that interference will not occur in a particular installation. If this equipment does cause harmful interference to radio or television reception, which can be determined by turning the equipment off and on, the user is encouraged to try to correct the interference by one or more of the following measures:

- Reorient or relocate the receiving antenna.

- Increase the separation between the equipment and receiver.

- Connect the equipment into an outlet on a circuit different from that to which the receiver is connected.

- Consult the dealer or an experienced radio/TV technician for help.

FCC Radiation Exposure Statement:

This equipment complies with FCC radiation exposure limits set forth for an uncontrolled environment. This equipment should be installed and operated with minimum distance 20cm between the radiator & your body.

CAUTION ON MODIFICATIONS

Any changes or modifications not expressly approved by the grantee of this device may void the authority granted by the FCC to operate this equipment. Electric and electronic equipment contains materials, components and substances that can be hazardous to your health and the environment, if the waste material (discarded electric and electronic equipment) is not handled correctly. Electric and electronic equipment is marked with the crossed-out trash can symbol, seen the right side. This symbol signifies that electric and electronic equipment should not be disposed of with other household waste but should be disposed of separately. All cities have established collection points, where electric and electronic equipment can either be submitted free of charge at recycling stations and other collection sites or be collected from the households. Additional information is available at the technical department of your city.



SUPPORT

We do our best to offer high quality products to our customers. If you experience any issues or problems with your product, please contact customer support as many issues can be quickly resolved.

If you have problems with your device, please consult the instructions in this manual. Please also visit us on the web at www.victoraudio.com to get up to the minute news, alerts, and documentation for your device. For additional assistance, please contact Naxa Technical Support.

Naxa Technical Support

2320 East 49th St.
Vernon, CA 90058
(866) 411-6292

<http://www.naxa.com/supportcenter>

** This product has been manufactured and sold under the responsibility of NAXA ELECTRONICS INC.*

VICTOR and the DOG & GRAMOPHONE logo are trademarks used under license by NAXA ELECTRONICS INC.

Further information at www.victoraudio.com.

All other products, services, companies, trademarks, trade or product names and logos referenced herein are the property of their respective owners