

OTIC[®]

10.1 Inch Portable DVD Player



MODEL: HJ10PRB01

PLEASE READ CAREFULLY BEFORE OPERATING THIS EQUIPMENT
KEEP IT IN A SAFE PLACE FOR FUTURE REFERENCE

CONTENTS

Important Safety Information.....	3-7
About Discs	8
Location of Controls.....	9-10
Remote Control	11
Making Connections	12-13
Swivel Panel.....	14
General Operations.....	15-16
USB or Card Playback.....	17
Other Way to Play.....	18
Bluetooth Transmitter Operation	19-21
Remote Control Operation.	22-23
System Setup.....	24-26
Troubleshooting.....	27
Region-free Guide.	28
Care and Maintenance.....	29
Specifications.....	30
Accessories.....	30
Mounting Strap Usage Guide.....	31

IMPORTANT SAFETY INSTRUCTIONS



CAUTION: TO REDUCE THE RISK OF ELECTRIC SHOCK, DO NOT REMOVE COVER (OR BACK). NO USER SERVICEABLE PARTS INSIDE. REFER SERVICING TO QUALIFIED SERVICE PERSONNEL.

CAUTION: THIS DIGITAL VIDEO DISC PLYER EMPLOYS A LASER SYSTEM. TO ENSURE PROPER USE OF THIS PRODUCT.

PLEASE READ THIS OWNER'S MANUAL CAREFULLY AND RETAIN FOR FUTURE REFERENCE.

SHOULD THE UNIT REQUIRE MAINTENANCE, CONTACT AN AUTHORIZED SERVICE LOCATION SEE SERVICE PROCEDURE.

USE CONTROLS, ADJUSTMENTS OR THE PERFORMANCE OF PROCEDURES OTHER THAN THOSE SPECIFIED HEREIN MAY RESULT IN HAZARDOUS RADIATION EXPOSURE.

TO PREVENT DIRECT EXPOSURE TO LASER BEAM, DO NOT TRY TO OPEN THE ENCLOSURE. VISIBLE LASER RADIATION MAY BE PRESENT WHEN THE ENCLOSURE IS OPENED. DO NOT STARE INTO BEAM.

WARNING: TO REDUCE THE RISK OF FIRE OR ELECTRIC SHOCK, DO NOT EXPOSE THIS PRODUCT TO RAIN OR MOISTURE.

WARNING: TO REDUCE THE RISK OF FIRE OR ELECTRIC SHOCK, AND ANNOYING INTERFERENCE, USE THE RECOMMENDED ACCESSORIES ONLY.

 The lightning flash with arrowhead symbol within an equilateral triangle is intended to alert the user to the presence of uninsulated dangerous voltage within the product's enclosure that may be of sufficient magnitude to constitute a risk of electric shock to persons.

 The exclamation point within an equilateral triangle is intended to alert the user to the presence of important operating and maintenance (servicing) instructions in the literature accompanying the appliance.

 **DANGER:** Invisible and hazardous laser radiation when open and interlock failed or defeated. Avoid direct exposure to beam.

Caution
Invisible laser beam.
Please do not look into or touch the lens.

SURGE PROTECTORS:
It is recommended to use a surge protector for AC connection. Lightning and power surges ARE NOT covered under warranty for this product.

IMPORTANT SAFETY INSTRUCTIONS

FCC NOTICE:

This equipment has been tested and found to comply with the limits for a Class B digital device, pursuant to part 15 of the FCC rules. These limits are designed to provide reasonable protection against harmful interference in a residential installation. This equipment generates, uses and can radiate radio frequency energy and, if not installed and used in accordance with the instructions, may cause harmful interference to radio communications.

However, there is no guarantee that interference will not occur in a particular installation. If this equipment does cause harmful interference to radio or television reception, which can be determined by turning the equipment off and on, the user is encouraged to try to correct the interference by one or more of the following measures:

- Reorient or relocate the receiving antenna. Increase the separation between the equipment and receiver.
- Connect the equipment into an outlet on a circuit different from that to which the receiver is connected.
- Consult the dealer or an experienced radio/TV technician for help.

FCC WARNING:

To assure continued compliance, follow the attached installation instructions and use only shielded cables when connecting to other devices. Modifications not authorized by the manufacturer may void user's authority to operate this device.

WARNING

USE UNDER SUPERVISION OF AN ADULT DUE TO LONG CORD

This unit has a long AC cord or other long cord that can easily be tripped on or pulled on, causing injury. Please make sure it is arranged so it will not drape over

a tabletop etc. where it can be pulled on by children or tripped over accidentally.

EXERCISE CAUTION AS UNIT HAS SHARP POINTS.

Before using the unit, be sure to read all operating instructions carefully. Please note that these are general precautions and may not pertain to your unit.

1) Read these instructions

All the safety and operating instructions should be read before the product is operated.

2) Keep these instructions

The safety and operating instructions should be retained for future reference.

3) Heed all warnings

All warnings on the product and in the operating instructions should be adhered to.

4) Follow all instructions

All operating and use instructions should be followed.

5) Do not use this apparatus near water

Do not use this product near water and moisture, for example: near a bathtub, washbowl, kitchen sink or laundry tub; in a wet basement or near a swimming pool.

6) Clean only with dry cloth

Unplug this product from the wall outlet before cleaning. Do not use liquid cleaners or aerosol cleaners. Use a dry cloth for cleaning.

7) Do not block any ventilation openings. Install in accordance with the manufacturer's instructions.

Slots and openings in the cabinet and in the back or bottom are provided for ventilation, to ensure reliable operation of the product and to protect it from overheating. These openings must not be

IMPORTANT SAFETY INSTRUCTIONS

placed near or over a radiator or heat source. This product should not be placed in a built-in installation such as a bookcase or rack unless proper ventilation is provided or the manufacturer's instructions have been adhered to.

8) Do not install near any heat sources such as radiators, heat registers, stoves, or other apparatus (including amplifiers) that produce heat.

9) Do not defeat the safety purpose of the polarized or grounding-type plug. A polarized plug has two blades with one wider than the other. A grounding type plug has two blades and a third grounding prong. The wide blade or the third prong are provided for your safety. If the provided plug does not fit into your outlet, consult an electrician for replacement of the obsolete outlet.

10) Protect the power cord from being walked on or pinched particularly at plugs, convenience receptacles, and the point where they exit from the apparatus.

11) Only use attachments/accessories specified by the manufacturer.

12) Unplug this apparatus during lightning storms or when unused for long periods of time.

To protect your product from a lightning storm, or when it is left unattended and unused for long periods of time, unplug it from the wall outlet and disconnect the antenna or cable system.

This will prevent damage to the product due to lightning and power-line surges.

13) Refer all servicing to qualified service personnel. Servicing is required when the apparatus has been damaged in any way, such as power-supply cord or plug is damaged, liquid has been spilled or objects have fallen into the apparatus,

the apparatus has been exposed to rain or moisture does not operate normally, or has been dropped.

14) Power source

This product should be operated only from the type of power source indicated on the marking label.

If you are not sure of the type of power supply to your home, consult your appliance dealer or local power company. For products intended to operate from battery power, or other source, refer to the operation instructions.

15) Power lines

An outside antenna system should not be located in the vicinity of overhead power lines or other electric light or power circuits, or where it can fall into such power lines or circuits.

When installing an outside antenna system, extreme care should be taken to keep from touching such power lines or circuits as contact with them might be fatal.

16) Overloading

Do not overload wall outlets and extension cords as this can result in a risk of fire or electric shock.

17) Object and liquid entry

Never push objects of any kind into the product through openings as they may touch dangerous voltage points or short out parts that could result in fire or electric shock. Never spill or spray any type of liquid on the product.

18) Service

Do not attempt to service this product yourself as opening or removing covers may expose you to dangerous voltage or other hazards. Refer all servicing to qualified service personnel.

19) Replacement parts

When replacement parts are required,

IMPORTANT SAFETY INSTRUCTIONS

be sure the service technician uses replacement parts specified by the manufacturer or those that have the same characteristics as the original parts. Unauthorized substitutions may result in fire or electric shock or other hazards.

20) Safety check

Upon completion of any service or repairs to this product, ask the service technician to perform safety checks to determine that the product is in proper operational condition.

21) Damage requiring service

Unplug this product from the wall outlet and refer service to qualified service personnel under the following conditions.

- a) When the power-supply cord or plug is damaged.
- b) If liquid has been spilled or objects have fallen into the product.
- c) If the product has been exposed to rain or water.
- d) If the product does not operate normally by following the operating instructions. Adjust only those controls that are covered by the operating instructions, as an adjustment of other controls may result in damage and will require extensive work by a qualified technician to restore in the product to its normal operation.
- e) If the product has been dropped or the cabinet has been damaged.
- f) When the product exhibits a distinct change in performance-this indicates a need for service.

NOTES ON HANDLING:

- When shipping the unit, always use the original shipping carton and packing materials. For maximum protection, repack the unit as it was originally packed at the factory.
- Do not use volatile liquids, such as insect spray, near the unit. Do not leave rubber or plastic products in contact with the unit for a long time. They will leave marks on the finish.
- The top and rear panels of the unit may become warm after a long period of use. This is normal and not a malfunction.
- When the DVD player is not in use, be sure to remove the disc and turn off the power.

NOTES ON LOCATING THE DVD PLAYER:

When you place this unit near a TV, radio or VCR, the playback picture may become poor and the sound may be distorted. In this case, move the unit away from the TV, radio or VCR.

NOTES ON CLEANING:

Use a soft, dry cloth for cleaning

- For stubborn dirt, soak the cloth in a weak detergent solution, wring well and wipe. Use a dry cloth to wipe it dry. Do not use any type of solvent, such as thinner and benzene, as they may damage the surface of the unit.
- If you use a chemical-saturated cloth to clean the unit, follow that product's instructions.

Warning: Cleaning and adjustment of lenses and/or other components of playback mechanism should be performed by a qualified service technician.

IMPORTANT SAFETY INSTRUCTIONS

NOTES ON MOISTURE

CONDENSATION:

Moisture condensation damages the DVD player.

Please read the following carefully.

- Moisture condensation occurs, for example, when you pour a cold drink into a glass on a warm day. Drops of water form on the outside of the glass. In the same way, moisture may condense on the optical pick-up lens inside this unit, one of the most crucial internal parts of the DVD player.

Moisture condensation occurs during the following cases:

- When you bring the DVD player directly from a cold place to a warm place.
- When you use the DVD player in a room where you just turned on the heater, or a place where the cold wind from the air conditioner directly hits the unit.
- In summer, when you use the DVD player in a hot and humid place just after you moved the unit from an air conditioner room.
- When you use the DVD player in a humid place.

WARNING:

- Do not use or leave the device in direct sunlight or a hot environment such as a vehicle etc. that is in hot environment. Overheating can damage the device.
- Do not overcharge the device – do not leave the device on the charger for very long after the battery has been fully charged.
- Device should be protected from any physical impact or damage and care should be taken not to drop the device.
- Only use the factory supplied charger. The use of unapproved charger or cable may cause the battery to fail, explode and/or damage the device.
- Do not disassemble, puncture, crush or expose your device to temperatures

above 40°C / 104°F.

- Keep your device away from fire or water.
- Keep your device from moisture and extreme temperatures.
- Should your battery swell or expand, please immediately discontinue use of your device.

ABOUT DISCS

The region number for this DVD Player is: 1
See the following page for information regarding region numbers.



PLAYABLE DISCS:

The following discs can be played back on this DVD player:



DISC TYPES:

DVD

Data on most DVDs is divided into sections called titles and then into subsections called chapters, each of which is given a title or chapter number. Some features of this DVD player will not operate with some DVD discs as they are preset. If a function you selected does not run as desired, refer to the manual accompanying the DVD disc.

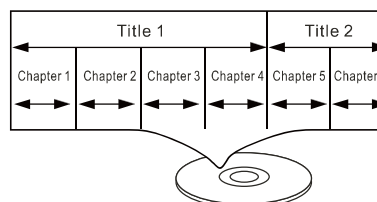

AUDIO CD

Data on an audio CD is divided into sections called tracks, each of which is given a track number.

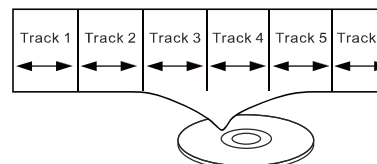

IMPORTANT:

It is important that you read the manual that accompanies the DVD disc, as there are features that are on the DVD player that cannot be used with certain DVDs. There are also extra features on the DVD disc that are different for each DVD disc, so they are not explained in this owner's manual.

This player conforms to the NTSC and PAL color systems. However, if you are in the USA, Canada or Mexico, leave this setting on NTSC. If incorrectly set to PAL, the TV picture may roll vertically. In this case, set the TV system to NTSC.

Notes on Copyright:

It is forbidden by law to copy, broadcast, show, broadcast on cable, play in public and rent copyrighted material without permission. DVD video discs are copy protected, and any recordings made from these discs will be distorted. This product incorporates copyright protection technology that is protected by method claims of certain U.S. Patents and other intellectual property rights owned by Macrovision Corporation, and is intended for home and other limited viewing uses only, unless otherwise authorized by Macrovision Corporation. Reverse engineering or disassembly is prohibited.

Region Management Information:

This DVD Player is designed and manufactured to respond to the Region Management Information that is recorded on a DVD disc. If the Region number described on the DVD disc does not correspond to the Region number of this DVD player, this DVD player cannot play that disc. You may not be able to play back some DVD video discs on this player if they were purchased from outside your geographic area or made for business purposes. When you try to play back an unauthorized disc, Wrong Region appears on the TV screen.

LOCATION OF CONTROLS

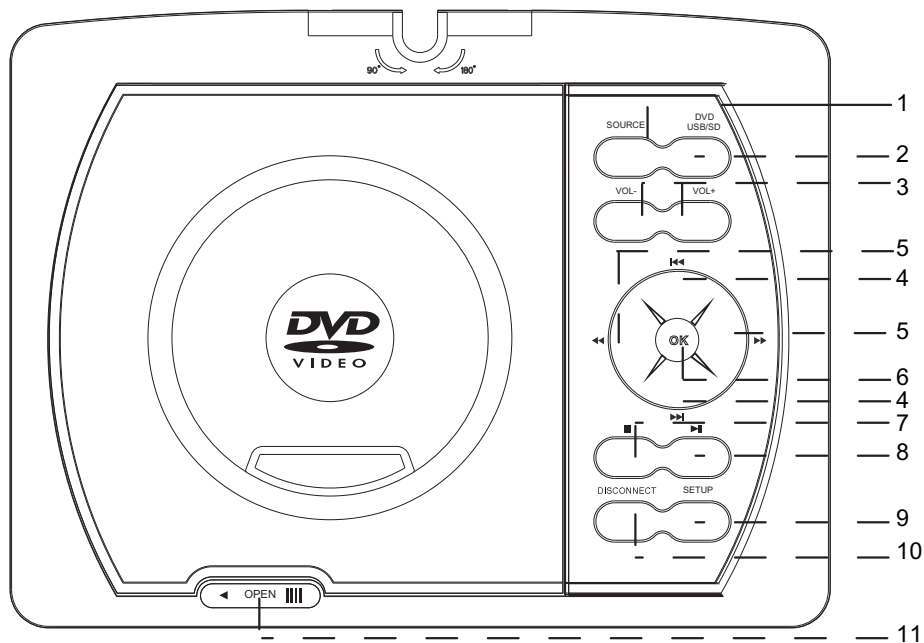

1. **SOURCE:** Press to switch to AV IN mode, press again to resume normal mode.
2. **DVD/USB/SD:** When USB device and/or SD Card was inserted, press repeatedly select the playback source as desired.
3. **VOL(volume) - :** Press to decrease the volume level
VOL(volume) + : Press to increase the volume level.
4. **◀◀/▶▶** In disc playback mode, press repeatedly to skip to previous/next chapters/tracks as desired.
 In setting menu, press repeatedly to move the cursor upward or downward within the menu.
5. **◀◀/▶▶** In disc playback mode, press to fast backward or fast forward.
 In setting menu, press repeatedly to move the cursor left or right within the menu, or return to previous menu.
6. **OK:** Press to confirm the selection.
7. **■** While DVD/CD playing, press this button once to pre-stop (In this mode, when press the ▶|| button, the player will start to play from the point stopped) Press this button twice to stop playback completely (In this mode, when press the ▶|| button, the player will start to play the current disc from the beginning)
8. **▶||** During playback, press this button to pause, press again to resume normal playback.
9. **SETUP:** Press this button to enter setting menu, when setting finished, press this button again to save and exit.
10. **DISCONNECT:** Press to disconnect the connected Bluetooth device.
11. **OPEN:** Slide to left to open the disc door.

LOCATION OF CONTROLS

Right Side View:

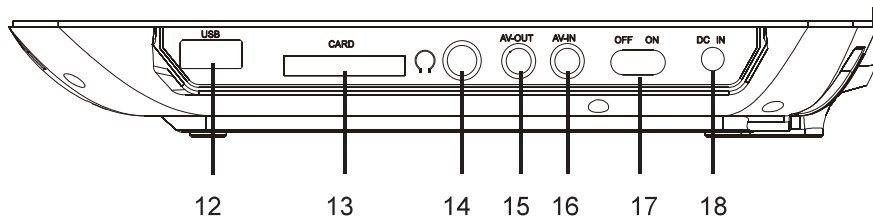

- 12. USB Port
- 13. CARD Slot
- 14. Earphone Jack
- 15. AV OUT Jack

- 16. AV IN Jack
- 17. POWER ON/OFF Switch
- 18. DC IN Jack

Front Side View:



- 19. Charging indicator
- 20. Remote sensor
- 21. Bluetooth indicator

REMOTE CONTROL

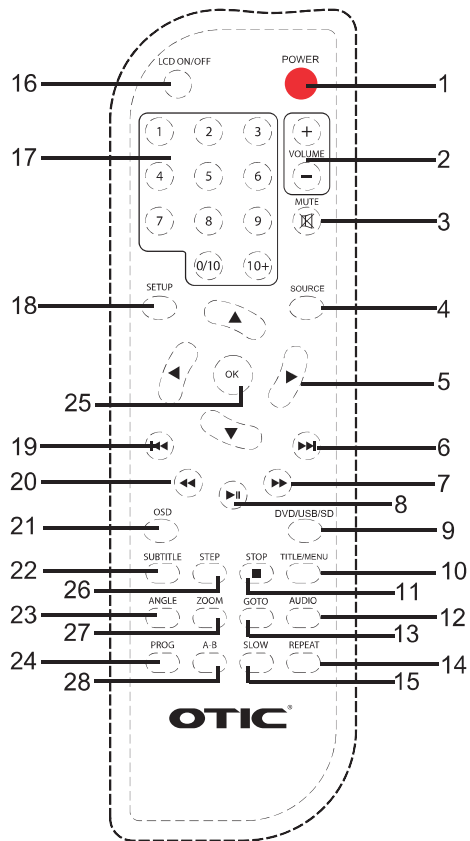

- | | |
|---|------------------------------------|
| 1. POWER button | 15. SLOW button |
| 2. VOLUME +/- buttons | 16. LCD ON/OFF button |
| 3. MUTE button | 17. Numeric buttons |
| 4. SOURCE button | 18. SETUP button |
| 5. Direction $\leftarrow \rightarrow \nabla \blacktriangle$ buttons | 19. \lll Skip Previous button |
| 6. \ggg Skip Next button | 20. \lll Fast Backward button |
| 7. \ggg Fast Forward button | 21. OSD (On Screen Display) button |
| 8. $\blacktriangleright \parallel$ (Play/Pause) button | 22. SUBTITLE button |
| 9. DVD/USB/SD button | 23. ANGLE button |
| 10. TITLE/MENU button | 24. PROG (Program) button |
| 11. \blacksquare (STOP) button | 25. OK button |
| 12. AUDIO button | 26. STEP button |
| 13. GOTO button | 27. ZOOM button |
| 14. REPEAT button | 28. A-B Repeat button |

MAKING CONNECTIONS

For the Unit

Charging by AC/DC Adapter:

1. Connect the small plug of AC/DC Adapter to the DC IN Jack on the right of unit.
2. Connect the other plug of AC/DC Adapter to the wall outlet with AC 100-240V~; 50/60Hz.

Note:

Your battery will last longer if these simple guides for caring for and storing is followed.

- A. Recharge and store the device within the temperature range of 40 ~ 95°F. (5°C~35°C)
- B. Do not overcharge (longer than 24 hours). Excessive charging or discharging may shorten the battery's life.
- C. Battery life naturally shortens slowly over time.
- D. The rechargeable battery incorporated in this product is not replaceable.

Charging Indicator status

DVD player Built-in Battery	On	Off
charging	RED	RED
Fully-charged	GREEN	OFF

When the power adapter is not connected the DC power supply, the charging indicator is always off.

Charging by Car Adapter:

1. Connect to the cigarette lighter socket of a vehicle with 12V battery as the figure below.

NOTE: It is NOT compatible with a vehicle with 24V battery.

2. This is a special negative ground Car Adapter. Using this Car Adapter with a plus grounded car can cause malfunction.
3. Do not plug in the Car Adapter until the car ignition is turned on.
4. Disconnect the Car Adapter from the cigarette lighter and the unit after use.

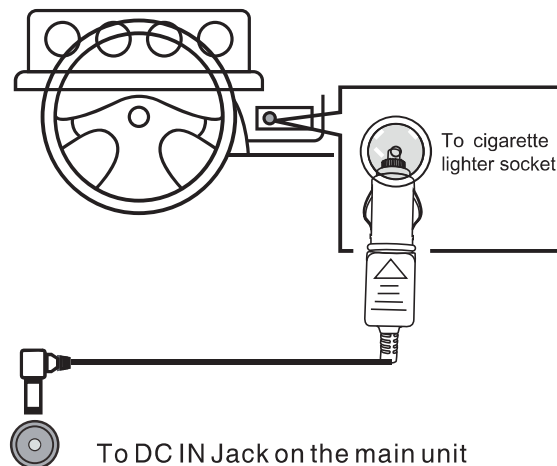

MAKING CONNECTIONS

For the Remote Control

Battery installation

1. Press the tabs on the battery door and lift it off.
2. Install two (2) x AAA size batteries into the battery compartment as the figure on right and the polarity markings inside battery compartment.
3. Replace the battery door.

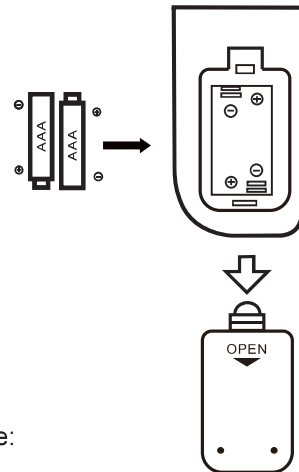

Battery Precautions

Follow these precautions when using batteries in this device:

1. Use only the size and type of batteries specified.
2. Be sure to follow the correct polarity when installing the batteries as indicated next to the battery compartment. Reversed batteries may cause damage to the device.
3. Do not mix different types of batteries together (e.g. Alkaline, Rechargeable and Carbon Zinc) or old batteries with fresh ones.
4. If the device is not to be used for a long period of time, remove the batteries to prevent damage or injury from possible battery leakage.
5. Do not try to recharge batteries not intended to be recharged; they can overheat and rupture. (Follow battery manufacturer's directions.)
6. Do not dispose of batteries in fire, batteries may explode or leak.
7. Clean the battery contacts and those of the device prior to battery installation.

Remote Control Working Range

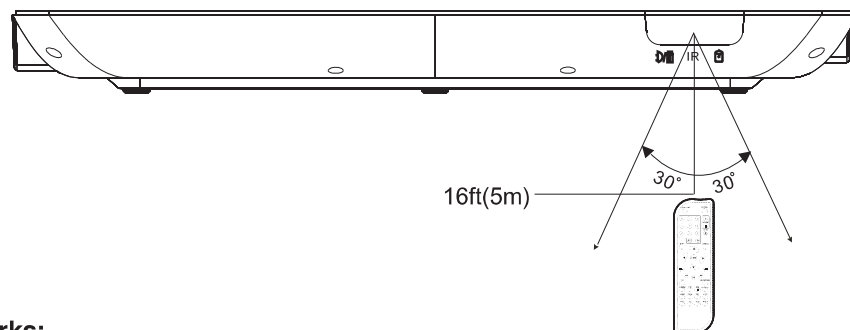

Remarks:

1. When there is an obstacle between the unit and the transmitter, the transmitter may not operate.
2. When direct sunlight, an incandescent lamp, fluorescent lamp or any other strong light shines on the remote control of the unit, the remote operation may be unstable.

SWIVEL PANEL

The screen panel can be swiveled as below:

①

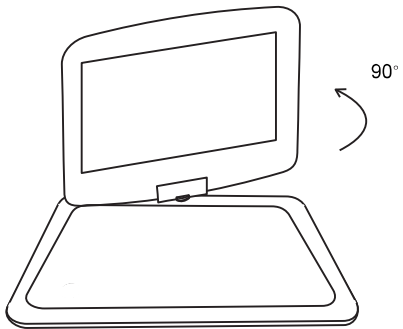

②

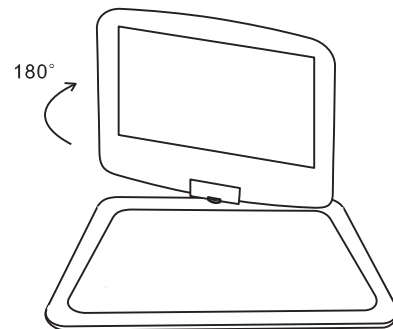

③

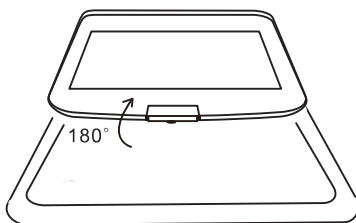

④

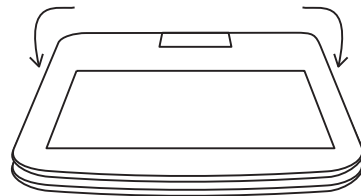

GENERAL OPERATIONS

1. Lift the panel and turn to desired angle. Slide the Power ON/OFF switch to "ON" position to power on the unit.
2. Slide the OPEN switch to right to open the disc door. Place a disc on the center spindle with label side facing up. Close the disc door and the player will start playback automatically.
3. During playback:
 - ~ Press the ►► or ◀◀ button repeatedly to fast search for a specific section forward or backward. Press the ►|| button to resume normal playback.
 - ~ Press the ►►| or ◀◀| button repeatedly to skip to specific track.
 - ~ Press the ►|| button to pause, press it again to resume normal playback.
 - ~ Press the VOL(volume)+/- buttons to adjust volume level.
 - ~ Press the ■ button to stop playback. The player will remember the point where the disc was stopped. Press the ►|| button to start playback from this point. Press the ■ button twice to stop completely, press the ►|| button to start playback from the beginning of the disc.
4. Press the **POWER** button on the Remote Control to turn the player to standby mode. The Bluetooth indicator will light in red. Press the **POWER** button again to turn the player on from standby mode. (For saving energy, always power off the player by slide the Power ON/OFF switch on the player to OFF position or unplug the AC/DC Adaptor from player and wall outlet)

Note:

The screen will enter into Screensave mode if the DVD player is stopped for about 3-5 minutes..

Repeat Playback: (CD)

- During playback, press the **REPEAT** button once to repeat the current Track.
- Press the **REPEAT** button twice to repeat all the tracks.
- Press the **REPEAT** button repeatedly to turn off the repeat mode.

Repeat Playback: (DVD)

- During playback, press the **REPEAT** button once to repeat the current Chapter.
- Press the **REPEAT** button twice to repeat the current Title.
- Press the **REPEAT** button the third time to repeat all.
- Press the **REPEAT** button repeatedly to turn off the repeat mode.

CD Program:

1. During CD playback, press the **PROG** (Program) button to open program window as below:

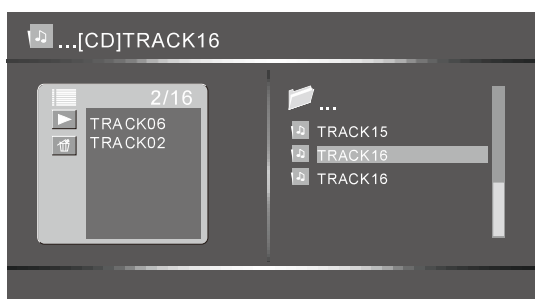

GENERAL OPERATIONS

2. Using the Direction buttons and OK button (or ENTER button) select and set the desired track playback order.
 - a. Use ▼ or ▲ button to select the desired track on the right; use OK button to confirm it. then the track is added into the left box.
 - b. Use ► button to move to next page.
 - c. Use ◀ button to move the cursor to the left box, and use ▼ or ▲ button to your selected tracks.
 - d. If you want to delete a track in the left box, just use ▼ or ▲ button to select it, and then press OK button (or ENTER button) to delete it.
 - e. To play the programed playback order list, press ◀ button to ► icon, and then press OK button (or ENTER button) to delete it.
 - f. To delete the whole program playback order list, press ◀ button to 🗑 icon, and then press OK button (or ENTER button) to delete it.
3. Press STOP button twice to exit the program playback mode.

DVD Program:

1. During a disc of DVD is playback, press the **PROG** (Program) button to open program window as below:

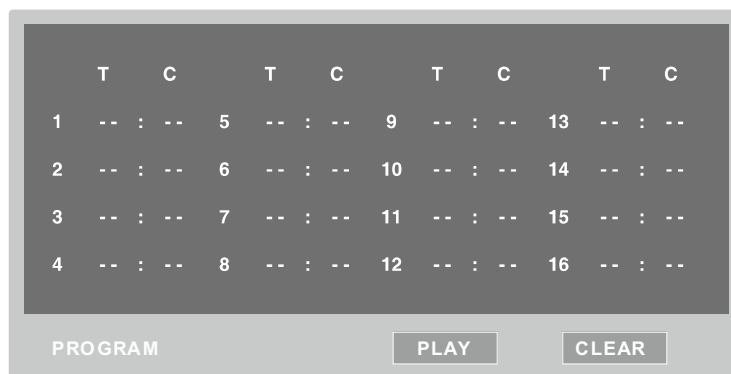

2. Use the Directional buttons to move the cursor to a specified playback order position, and use Numeric buttons to input the Title and Chapter of the movie segment. If there is no chapter in a Title, input "01" at the C position.
3. To play the programed playback list, press ▼ button to move cursor to PLAY button and press OK or ENTER button to start the playback.
4. To delete the programed playback list, press ▼ and ► button to move cursor to CLEAR button and press OK or ENTER button to delete the list.
5. Press STOP button twice to exit the program playback mode.

USB OR CARD PLAYBACK

1. Insert the USB Device or SD/MMC memory card into the USB port/card slot as the figure below.

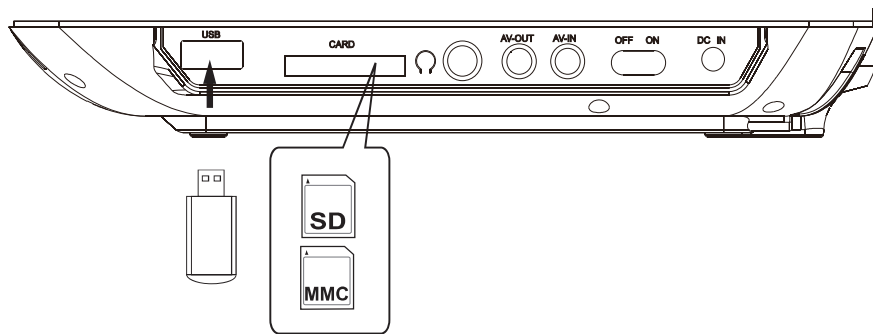

2. Turn on your DVD player, and press the **DVD/USB/SD** button, the "DISC, CARD, USB" selection window will pop up on the screen. Use the Direction buttons to select and highlight the desired source then press the **OK** button to confirm.
3. During playback:
 - ~ Press the **▶▶** or **◀◀** button repeatedly to skip tracks.
 - ~ Press the **◀◀** or **▶▶** button repeatedly to select and set the fast searching speed.
 - ~ Press the **▶||** Play/Pause button to pause, press it again to resume normal playback.
 - ~ Press the **■** Stop button to stop current playback.
4. When the playback is stopped:
 - ~ Press the **◀◀** or **▶▶** button on the operation panel, or **◀** or **▶** on the remote to go to next/previous track list page.
 - ~ Press **■** Stop button to go back to the upper level menu.

OTHER WAY TO PLAY

Connecting to a TV or Video Player (such like DVD, VCR, DVR Players ...) with AV connection cable.

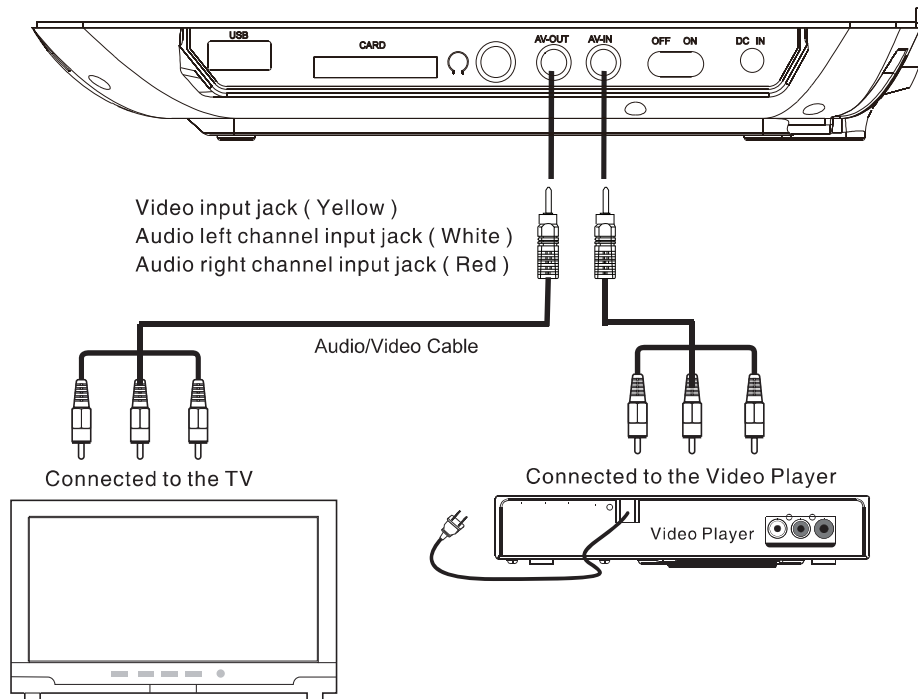

NOTE:

- The default setting of the unit is AV OUT, if connect to external video player (such like DVD, VCR, DVR Players ...), press the SOURCE button to set to AV IN mode ("AV IN" will appear on the screen). Press again to turn back to resume normal mode.
- Using the supplied Earphone to listen privately.

BLUETOOTH TRANSMITTER OPERATION

With the Bluetooth transmitter feature, you can enjoy the movie or music through your home theater system instead of through the DVD player.

A. Bluetooth Overview

Bluetooth version: 5.0

Bluetooth connection range: 10m (on the line of sight without obstacles)

B. Compatible Devices

This unit is designed as an audio Bluetooth sender. It can be connected to BT receivers such as:

BT speakers

BT headphones,

BT earbuds,

...

The supported brands include most of famous ones, such as Apple AirPods, SAMSUNG, JBL, SONY, Xiaomi, EDIFIER, HONOR, ...

It cannot be connected to BT senders including smart TV, cell phone, gaming devices, projector, mouse, etc.

C. Before Connection

1. Power on your home theater system and turn it to BT mode. Note that it must be disconnected from other audio/video input devices via Bluetooth.
2. Move your portable DVD player close to your home theater system, keep the distance between them no more 10 m, and stop disturbance from the working micro oven, cordless phone or Wi-Fi hotspot, etc.
3. Turn on your DVD player, and press SETUP button to enter SETUP mode.

D. Making the Connection

1. Press ▼ button to move the cursor to BT SETUP menu, and then press ► button to select BT CONTROL and then SCAN as follows:

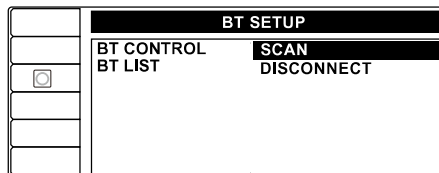

BLUETOOTH TRANSMITTER OPERATION

2. Press OK/ENTER button to start scan the device name of your home theater system. The Bluetooth indicator will start blink in blue rapidly, and after about 20 seconds. it will turn off automatically when the searching process is finished.
3. When the Bluetooth indicator turns off, press ▼ button to select BT LIST, and the Pair Name of your home theater system should appear on the right side as below.

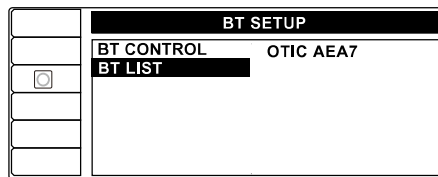

("OTIC AEA7" is just an example of the Pair Name of your home theater system.)

4. Press ► button to highlight Pair Name. and press OK/ENTER button to confirm it. If you press ◀ button to move away the cursor, you will find the Pair Name of your home theater system has already turn to yellow. The Bluetooth indicator turns to solid blue, and your home theater system will also indicate it is connected through the display, sound or the indicator lamp.
5. Insert a desired CD/DVD to the DVD player, or insert USB/SD/MMC card to relative slot, and start to play like usual.

Now, it's time to enjoy the audiovisual feast via your DVD player and home theater system!

To disconnect the Bluetooth connection, press DISCONNECT button on the DVD player, or select DISCONNECT in the BT SETUP menu.

NOTE:

- When the SOURCE button is pressed, the BT transmitter function will be disabled.
- The Bluetooth connection cannot be re-established automatically, and it is needed to enter SETUP mode to scan and make it reconnected manually.
- If the AV IN mode is used, the Bluetooth connection will be disconnected automatically. If you want to connect other BT receivers to this unit, just reconnect it as above.
- The volume of the paired device cannot be adjusted by the DVD player. Adjust the volume of the paired device itself if needed.

BLUETOOTH TRANSMITTER OPERATION

In most cases the Bluetooth connection will be established smoothly. If it is failed, please check as follows:

Problem	Possible Cause	Solution
Cannot find the pair name of the device to be connected	The device is not compatible	Be sure the device is an BT receiver, such as BT speaker, BT earphone...
	The Bluetooth function of the device may malfunction	Connect the waiting device to your smartphone via BT. If it still fails , it is due to the waiting device, not your DVD player. If connected , check other items and solve them according to the recommendations listed in Row Solution of this chart, then reset the waiting device or switch it back to BT mode, and make the scan again.
	Your device has already been connected to other devices via BT.	Power off other devices to disconnect the connection, and make the scan again.
	The device is not turned on.	Turn on your device.
	The device is not in BT mode	Switch your device to BT mode.
	The Pair name of the device is remembered wrongly	Remember it correctly.
	The strong wave transmitter such as cordless phone, Wi-Fi hotspot or micro oven is working.	Stop them and make the scan again.
	The portable DVD player is too far from the device	Move them closer (within 10 m and without obstacles).
Pairing is succeeded, but still not working.	The paired device is not the desired one.	The font color the pair name of the connected device on the SETUP menu will become yellow. Make sure it is the right one. If not, disconnect it and make the scan again.
	The Pair name of the device is remembered wrongly	Remember it correctly.
	No picture	Video signal transmission via BT is not supported.
Playback interruption	The disc is dirty, distorted or scratched.	Clean the disc, or change another disc and try again.
	The DVD player is in a bumpy state.	Place the player on a steady surface.
Sound too large/small, or cannot be adjusted	The volume of the paired device is set too high/low	The volume from the paired device cannot be adjusted by the DVD player, Adjust the volume of paired device itself.
	The paired device may malfunction	Connect your DVD player to another device to try again.
	The audio file played is corrupted.	Play normal audio files.
No sound	The sound of the connected device is muted or turned to minimum level.	Unmute it, and set the volume to a proper level.

REMOTE CONTROL OPERATIONS

LCD ON/OFF: Press to turn on or off the LCD display.

POWER: Press to turn to standby mode, press again to turn on.

VOLUME +/-: Press to increase or decrease volume.

MUTE: Press to turn off the sound, press again to resume.

SOURCE: Press to switch to AV IN mode, press again to resume normal mode.

OSD: (On Screen Display)

During playback, press the **OSD** button repeatedly to read the information of playback status.

SUBTITLE:

During DVD playback, press repeatedly to select desired subtitle (Function depends on the recording of disc).

STEP:

During movie playback, press **STEP** button repeatedly to play the movie frame by frame. Press the **▶II** button to resume normal playback.

TITLE/MENU:

Press repeatedly to return to disc's title /menu page (Function depends on the recording of the disc).

ANGLE:

During DVD playback, press repeatedly to select the viewing angle (Function depends on the recording of the disc).

AUDIO:

During DVD playback, press repeatedly to select the desired language or channel. (Function depends on the recording of the disc)

ZOOM:

During movies playback, press this button repeatedly to zoom in/out the picture. When in zoom mode, press Direction buttons to select the parts of the zoomed picture to watch. (Function depends on the recording of the disc.)

Note: Zooming into an image will degrade the quality as the pixels of the image are being enlarged.

SLOW:

During playback, press the **SLOW** button repeatedly to set the slow motion speed. Press **▶II** button to resume normal playback.

GOTO (DVD):

~ Press the **GOTO** button once to display the Title and Chapter selection menu.

Use Direction and Numeric buttons to select the desired Title and Chapter.

The player will play the selected Chapter automatically.

~ Press the **GOTO** button twice to display the time selection under Title, using the

Direction and Numeric buttons to enter the desired time. The unit will start play the movie from the selected time automatically.

~ Press the **GOTO** button the third time to display the time selection under Chapter.

Using the Direction and Numeric buttons to enter the desired time. The unit will start

REMOTE CONTROL OPERATIONS

play the movie from the selected time automatically.

GOTO (CD)

- ~ Press the **GOTO** button once, using the Numeric and **OK** buttons to set the desired playback time of disc.
- ~ Press the **GOTO** button twice, using the Numeric and **OK** buttons to set the desired playback time of track.
- ~ Press the **GOTO** button the third time, using the Numeric and **OK** buttons to set the desired track.

A-B Repeat

During Playback, press the A-B button to select the starting point, press it again to select the ending then the player will play the selected section repeatedly and continuously. Press the A-B button again to resume to the normal playback (This function is not available on all discs).

SYSTEM SETUP

System setup

The SETUP menu enables you to set your preferences for the different options available on your DVD Player. You can use the ▲ Up, ▼ Down, ◀ Left and ▶ Right directional buttons to highlight each function or option and then press the OK button to confirm.

To move to the next set of Setup options after making changes, press the Left arrow ◀, followed by the ▼ down arrow.

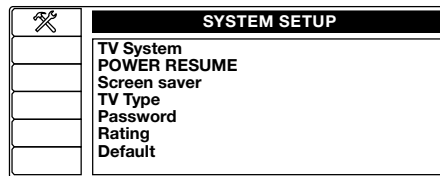

1. Press the SETUP button to display the SETUP menu options.
2. Use the ▼ Down and ▲ Up buttons to move through the menu options screens.
3. You can then use the directional buttons to highlight each function or option and then press the OK button to confirm.

TV system

Options of NTSC, PAL or AUTO are available for you to match to the type of DVD disc that you plan to watch. The AUTO setting is the default.

(This menu is only enabled in AV OUT mode, and be sure use the remote of this device)

Power Resume

There are two options available, ON or OFF. If you set the Resume feature to ON and play a disc that you have played before, the disc will start from the place it was last stopped.

Screensaver

When your DVD player is not in use, the DVD logo can be used as a screensaver to help to prevent screen burn. You can choose to set this ON or OFF.



TV Type

The TV type option enables you to set the aspect ratio of the DVD Player to match to the connected TV. The following options are available:

- 4:3/PS (pan and scan)
- 4:3/LB (letter box)
- 16:9 (widescreen)

Password

You can set the viewing rating for your DVD Player and protect it with your own password. Setting your own password:

1. Within the SETUP menu, scroll down and highlight PASSWORD and press the OK button. The 4-digit password and lock symbol will be highlighted .
2. Enter the default password of 0000 and press the OK button. The lock symbol will change to be unlocked .

SYSTEM SETUP

3. Use the ► right arrow to highlight the 4-digit password and unlock symbol again. Enter your own 4 digit password and press the OK button. The lock symbol will now be changed to be locked 🔒 again and your new 4-digit password has been saved.

Rating

To set the viewing rating:

1. Follow the steps above and ensure that the PASSWORD screen is displaying the unlock symbol 🔓. If the lock symbol is shown, enter the default password of 0000 or the new password you have set and press OK.
2. Scroll down and highlight RATING. Use the ► Right arrow to move to the Rating options, then use the ▲Up and ▼Down buttons to highlight your chosen rating. Press the OK button to confirm.
3. Scroll up and highlight PASSWORD and then press OK. Enter the default password of 0000 or the new password you have set and press OK.
4. The lock symbol will change to be locked 🔒 and your viewing rating is now password protected.

Rate levels:

- 1 (Kid Safe): Kid safe
- 2 (G): All ages
- 3 (PG): Parental Guidance
- 4 (Pg 13): Parental Guidance less than 13 years old
- 5 (Pgr): Under 17 years old, Parental Guidance suggested
- 6 (R): Under 17 years old, Parental Guidance strongly
- 7 (Nc 17): 17 years old or above
- 8 (Adult): Adult only

Default

If you highlight this option and then move to RESTORE and then press the OK button. The DVD Player will be reset to its factory default settings.

Language options

This menu option display enables you to choose the DVD player default audio and on-screen language. You can choose from English, French, German and Spanish.

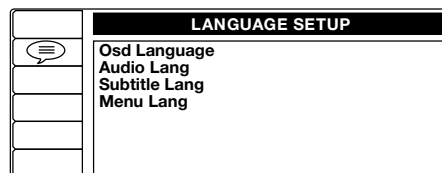

SYSTEM SETUP

BT Setup

This menu option display is for the BT setup. You can change the Bluetooth settings with ▲ Up, ▼ Down, ◀ Left and ▶ Right buttons to highlight each option and then press the OK button to confirm.

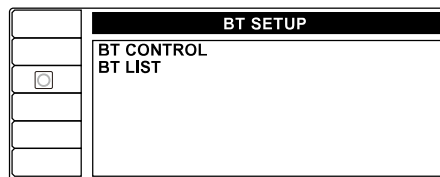

TFT display

This menu option display is for the TFT display. You can change the display settings for the Brightness, Contrast, Hue and Saturation.

You can use the ▲ Up, ▼ Down, ◀ Left and ▶ Right buttons to highlight each option and then press the OK button to confirm.

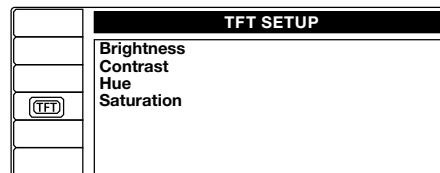

Digital Setup

This menu option is for Audio.

You can use the ▲ Up, ▼ Down, ◀ Left and ▶ Right buttons to highlight each option and then press the OK button to confirm.

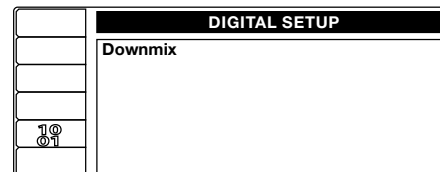

TROUBLESHOOTING

Problem	Possible Cause	Solutions
No power/No response	The power supply is not connected.	Check the mains power plug connection at the wall socket and ensure that it is switched on.
	Power in the battery has run out (when not connected to power supply)	Recharge the internal battery as mentioned in the section of "Charing by AC/DC Adapter".
	The player is switched off	Slide the POWER switch to ON position to turn on the player
	The player is in Standby mode	Press "POWER" button on the remote control to wake the player up from sleeping.
No picture and/or No sound	Display is turned off.	Press the LCD ON/OFF button on the unit or remote control to turn on display.
	The player (or the connected device) is muted	Press the MUTE button on the remote (or on the connected device) again to unmute it.
	The volume (of the player or the connected device) is set to minimum	Increase the volume of the dvd player and the connected device.
Sound via Bluetooth too large/small, or can not be adjusted	The volume of the paired device is set too high/low	The volume from the paired device cannot be adjusted by the DVD player, Adjust the volume of paired device itself.
	The paired device may malfunction	Connect your DVD player to another device to try again.
	The audio file played is corrupted.	Play normal audio files.
Playback interruption	The disc is dirty, distorted or scratched.	Clean the disc, or change another disc and try again.
	The DVD player is in a bumpy state.	Place the player on a steady surface.
Shut down unexpectedly	Power in the battery has run out (when not connected to power supply)	Recharge the internal battery as mentioned in the section of "Charing by AC/DC Adapter".
Unable to play	The regional code of the inserted disc is incorrect.	Insert a region 1 disc instead. (The discs bought outside the USA and Canada have different regional codes, and thus cannot be played)
	The disc is inserted placed improperly.	Check that the disc in the DVD/CD tray is the correct label side up and that it is sitting correctly within the recessed area of the tray.
	The disc is dirty or scratched.	Clean the disc, or change another disc and try
	The file format is not supported in the USB/SD card	Make sure the files are supported by the player.
The remote control is not working	The batteries may be exhausted.	Replace with new good quality batteries.
	An obstacle between the remote control and the remote sensor on your DVD Player	Remove the obstacle.
	Direct sunlight or other bright light sources is shining,	Change another place.
	Too far from the DVD player	Move closer to the DVD player. (within 5 m).

REGION-FREE GUIDE

1. Power on your DVD player, and slide "OPEN" switch to open the disc door. The screen will appear as follows:



2. Press the numeral buttons "5", "1", "6" and "8" on the remote, then the "CUSTOM PAGE" window will pop out.

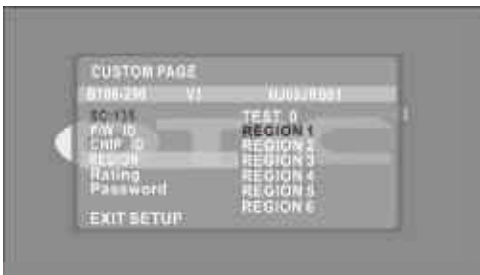

Note:

- When the numbers are being input, the "OPEN" label on the upper left corner of the first screen will change to "⊗". No other change occurs until the passcode 5168 is input continuously and correctly.
- If the CUSTOM window does not pop out after input, it indicates the numbers input is not correct, or the input speed is too long. If this happens, just wait for no less than 5 seconds and input the passcode again.

3. Use the directional buttons to highlight the "TEST 0", then press OK button to confirm. After you finished, the screen should be like below:

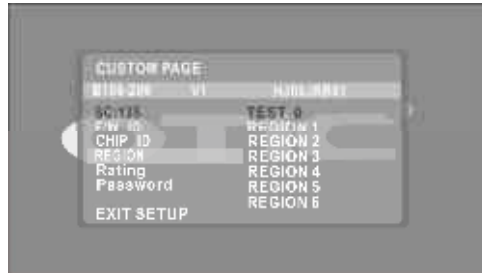

Note:

The font color of the item "TEXT 0" turns to yellow if every step is followed correctly.

4. Use directional buttons to highlight "EXIT SETUP" to exit the CUSTOM PAGE window, or just press SETUP button on the remote to exit.

CARE AND MAINTENANCE

Caring for Disc

Treat the disc carefully. Handle the disc only by its edges.

Never allow your fingers to contact with the shin, unprinted side of the disc.

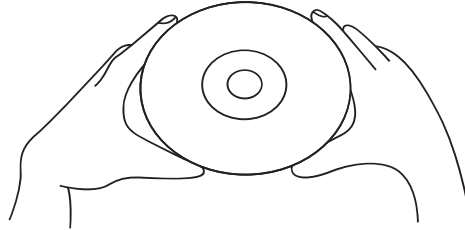

- Do not attach adhesive tape, stickers, etc. to the disc label.
- Clean the disc periodically with a soft, lint-free, dry cloth. Never use detergents or abrasive cleaners to clean the disc. If necessary, use a CD cleaning kit.
- If a disc skips or gets stuck on a section of the disc, it is probably dirty or damaged (scratched).
- When cleaning the disc, wipe in straight lines from the center of the disc to the outer edge of the disc. Never wipe in circular motions.

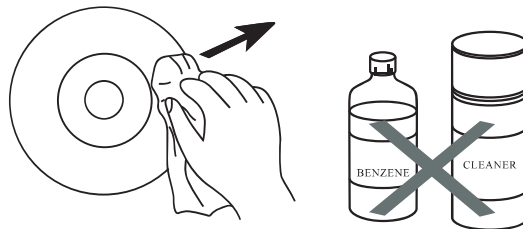

- Discs should be stored in their cases to avoid damage after use.
- Do not expose discs to direct sunlight, high temperatures or dust, etc. Prolonged exposure or extreme temperatures can warp the disc.
- Do not stick or write anything on either side of the disc. Sharp writing Instruments, or the ink, may damage the surface.

Cleaning the Unit

- To prevent fire or shock hazard, disconnect your unit from the AC power source when cleaning.
- The finish on your unit may be cleaned with a dust cloth and cared for as other furniture. Use caution when cleaning and wiping the plastic parts.
- Mild soap and a damp cloth may be used on the front panel.

SPECIFICATIONS

Power Source: Built-in DC 12V 1A

Lithium-ion rechargeable battery, recharge by: DC 7.4V 2000mAh

Disc Compatibility: DVD/CD/CD-R/CD-RW/DVD±R/DVD±RW/Xvid/JPEG

Charging time: about 5 hours

Playback time: about 5 hours

Speaker output: 3.27V/1.34W (1K0dB/ VOL Max)

Bluetooth version: 5.0

Bluetooth connection range: 10m (on the line of sight)

ACCESSORIES

1 x User's Manual

1 x AC/DC Adaptor

1 x Remote Control

2 x AAA Batteries

1 x Car Adaptor

1 x Earphone

1 x AV Cable

1 x Carrying Bag

1 x Car Mounting Strap

**SPECIFICATIONS AND ACCESSORIES ARE SUBJECT TO CHANGE
WITHOUT NOTICE**

Mounting Strap Usage Guide

1. Screen swivel 180 degrees.

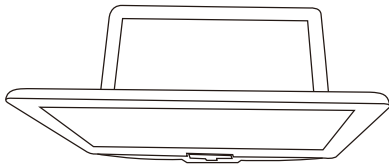

2. Put the strap on the operation panel.

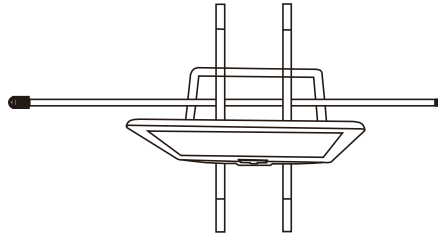

3. Fasten the loop and hook at the bottom.

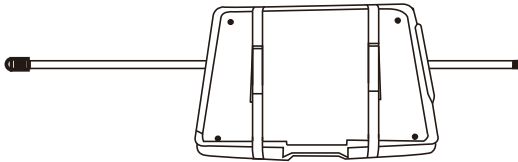

4. Put the strap across headrest frame.

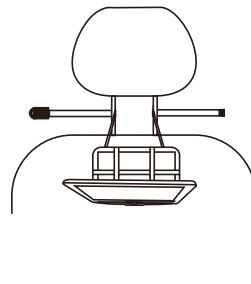

5. Put one end of strap across the lock.

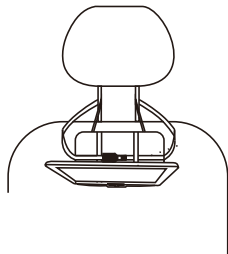

6. Pull the strap at the direction of the arrow.

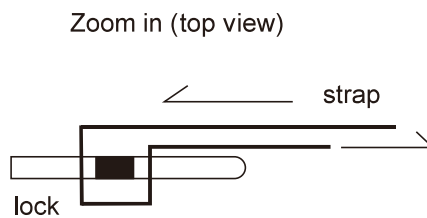

7. Swivel the screen to the operation panel.

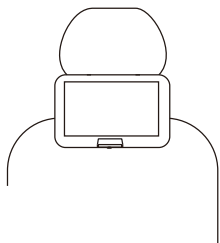

Done!

FCC Statement

This equipment has been tested and found to comply with the limits for a Class B digital device, pursuant to part 15 of the FCC Rules. These limits are designed to provide reasonable protection against harmful interference in a residential installation. This equipment generates, uses and can radiate radio frequency energy and, if not installed and used in accordance with the instructions, may cause harmful interference to radio communications. However, there is no guarantee that interference will not occur in a particular installation. If this equipment does cause harmful interference to radio or television reception, which can be determined by turning the equipment off and on, the user is encouraged to try to correct the interference by one or more of the following measures:

- Reorient or relocate the receiving antenna.
- Increase the separation between the equipment and receiver.
- Connect the equipment into an outlet on a circuit different from that to which the receiver is connected.
- Consult the dealer or an experienced radio/TV technician for help.

Caution: Any changes or modifications to this device not explicitly approved by manufacturer could void your authority to operate this equipment.

This device complies with part 15 of the FCC Rules. Operation is subject to the following two conditions: (1) This device may not cause harmful interference, and (2) this device must accept any interference received, including interference that may cause undesired operation.

RF Exposure Information

The device has been evaluated to meet general RF exposure requirement. The device can be used in portable exposure condition without restriction.

OTIC[®]

Get 24/7 Assistance at



Use camera or QR scanner to scan

Or Visit: <https://otic.afterservice.vip>

Shenzhen Junlan Electronics Ltd.

Add: No. 277 PingKui Road, Pingshan District, Shenzhen, CHINA

After Service: <https://otic.afterservice.vip>

Email: otic@afterservice.vip

FC MADE IN CHINA