

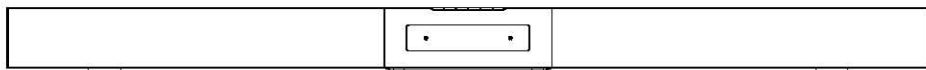

42" TV Sound Bar with Amazon Alexa Voice Control



MODEL:NHS-5002

PLEASE READ CAREFULLY BEFORE OPERATING THIS EQUIPMENT
KEEP IT IN A SAFE PLACE FOR FUTURE REFERENCE

FCC NOTICE:

This device complies with part 15 of the FCC Rules. Operation is subject to the following two conditions: (1) this device may not cause harmful interference, and (2) this device must accept any interference received, including interference that may cause undesired operation..

Any changes or modifications not expressly approved by the party responsible for compliance could void the user's authority to operate the equipment.

NOTE: This equipment has been tested and found to comply with the limits for a Class B digital device, pursuant to Part 15 of the FCC Rules. These limits are designed to provide reasonable protection against harmful interference in a residential installation. This equipment generates, uses and can radiate radio frequency energy and, if not installed and used in accordance with the instructions, may cause harmful interference to radio communications. However, there is no guarantee that interference will not occur in a particular installation.

If this equipment does cause harmful interference to radio or television reception, which can be determined by turning the equipment off and on, the user is encouraged to try to correct the interference by one or more of the following measures:

- Reorient or relocate the receiving antenna.
- Increase the separation between the equipment and receiver.
- Connect the equipment into an outlet on a circuit different from that to which the receiver is connected.
- Consult the dealer or an experienced radio/TV technician for help.

To maintain compliance with FCC's RF Exposure guidelines, This equipment should be installed and operated with minimum distance between 20cm the radiator your body: Use only the supplied antenna.

FCC ID: OKUCAW70040

PRODUCT OVERVIEW

TOP VIEW

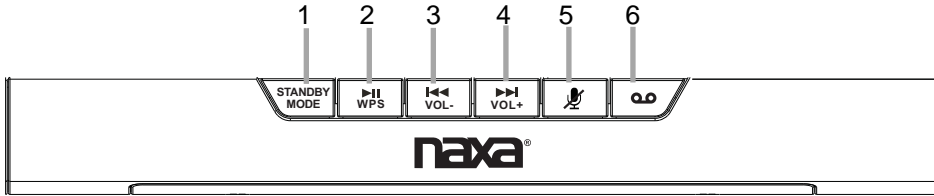

1. STANDBY/MODE Button
2. ►►/WPS Button
3. ◀◀/VOL- Button

4. ►►/VOL+ Button
5. 🎤 (Microphone On/Off) Button
6. 📶 (Communication) Button

FRONT VIEW

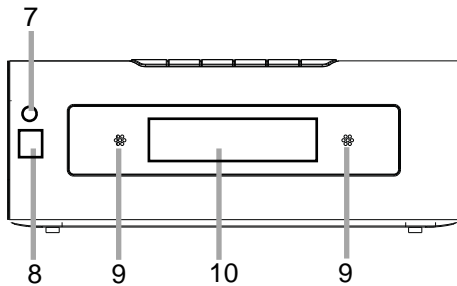

7. Communication Status LED Indicator
8. Remote IR Sensor
9. Built-in Microphone
10. Display

REAR VIEW

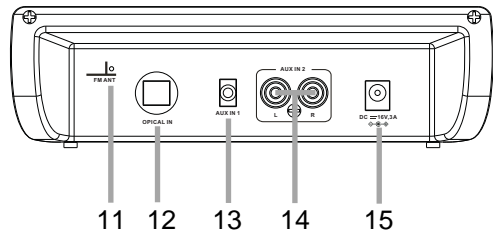

11. FM Antenna
12. OPTICAL IN Port
13. AUX IN 1 Jack
14. AUX IN 2 Jack
15. DC IN Jack



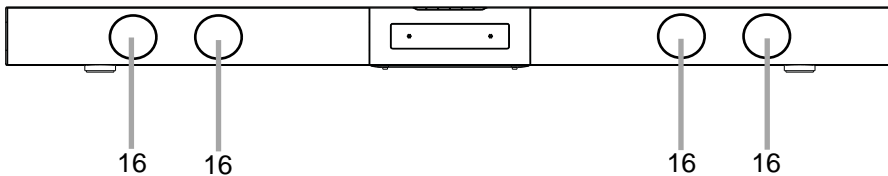



FRONT VIEW

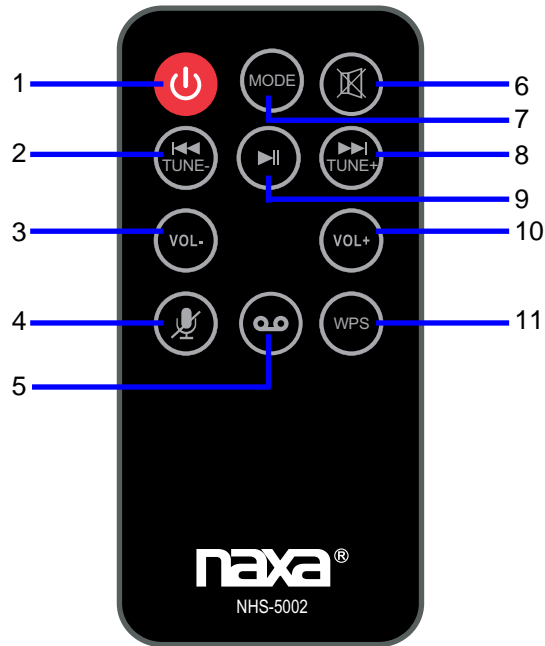

16. Speaker

REMOTE CONTROL



1.  Power Button
2.  (Previous)/ TUNE- Button
3. VOL - (Volume down) Button
4.  (Microphone On/Off) Button
5.  (Communication) Button
6.  (Mute)Button
7. MODE Button
8.  (Next)/TUNE+ Button
9.  (Play/pause) Button
10. VOL + (Volume up) Button
11. WPS Button

BATTERY INSTALLATION OF REMOTE CONTROL

FIRST TIME USE

- Remove and discard the insulation film as figure on the right.

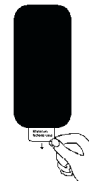

● Replacing Batteries For Remote Control

1. Push and slide out the battery holder as figure 1 below.
2. Replace the battery with a new CR2025 button cell as the polarity markings on the rear of the Remote Control.
3. Close the battery holder.

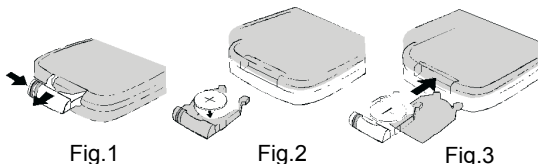

BATTERY PRECAUTIONS

Follow these precautions when using a battery in this device:

1. Use only the size and type of battery specified.
2. Be sure to follow the correct polarity when installing the battery as indicated in the battery compartment, a reserved battery may cause damage to the device.
3. Do not mix different types of batteries together (e.g: Alkaline and Carbon-zinc) or old batteries with fresh ones.
4. If the batteries in the device are consumed or the device is not to be used for a long period of time, remove the batteries to prevent damage or injury from possible leakage.
5. Do not try to recharge the battery not intended to be recharged; it can overheat and rupture. (Follow battery manufacturer's instructions.)
6. The batteries shall not be exposed to excessive heat such as sunshine, fire or the like.
7. Clean the battery contacts and also those of the device prior to battery installation.
8. The remote control supplied with a coin/button cell battery. If the coin button cell battery is swallowed, it can cause severe internal burns in just 2 hours and can lead to death. Keep new and used battery away from children. If the Battery compartment does not close securely, stop using the product and keep it away from children. If you think batteries might have been swallowed or placed any part of the body, seek immediate medical attention.

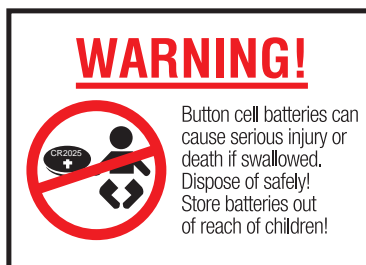

CAUTION

- Danger of explosion if the battery is incorrectly replaced.
- Replace only with the same or equivalent type.

Remote control operation range

- When there is an obstacle between the remote and the transmitter, the unit may not operate.
- When direct sunlight, an incandescent lamp, fluorescent lamp or any other strong light shines on the REMOTE SENSOR of the unit, the operation of the remote may be unstable.

PLACEMENT AND MOUNTING

1. Placing the device on table - Ventilation

When placing the Sound Bar on an entertainment center, bookshelf, or any type of enclosed space, be sure to allow at least 2-3 inches of space around the Sound Bar for ventilation. If the Sound Bar is enclosed in a tight space, without ventilation, heat generated from the Sound Bar could produce a potential heat hazard.

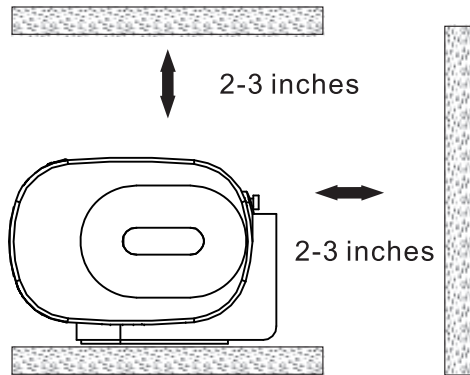

2. The Installation Distance

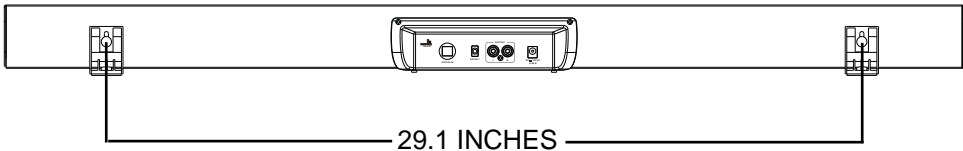

Mounting to a wall

2.1 Mounting to a wooden wall

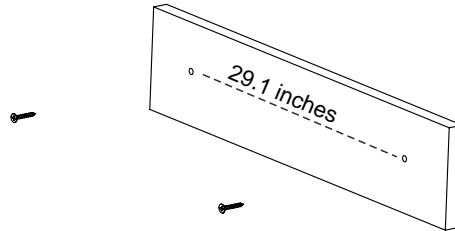

(screws not included)

- Mark the position of the mounting screws on the wall using a pencil.
- Drill the screws directly into the marks that you have made on the wall and leave approx. 0.3 inches length to hook the sound bar.
- Put the sound bar onto the mounting screws. Make sure they are firm and stable.

2.2 Mounting to a brick wall

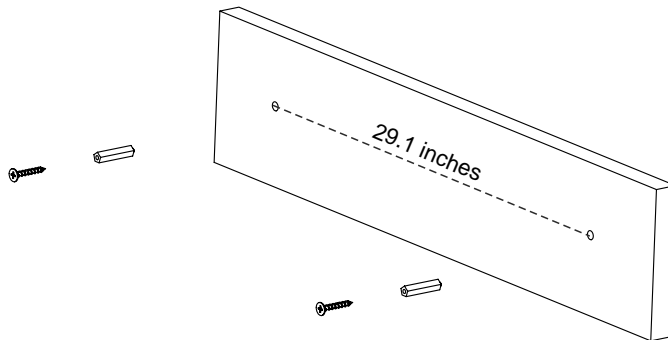



(screws and plastic fixing plug are not included)

- Mark the position of the mounting screws on the wall using a pencil.
- Drill 2 holes on wall with a powerful electric drill.
- Insert the fixing plug and hammer into the holes.
- Secure the screws into the fixing plug and leave approx. 0.3 inches length to hook the sound bar.
- Put the sound bar onto the mounting screws. Make sure they are firm and stable.

GENERAL OPERATION

1. Connect the AC/DC adapter to the unit and wall outlet. "WAIT" will appear on display.
2. Press and hold the STANDBY/MODE button on the unit or press the  Button on remote control to turn on the unit. Press the STANDBY/MODE button on the unit or press the MODE button on remote control repeatedly to turn to desired mode as below:

WIFI.....	WIFI Mode
BT.....	Bluetooth Mode
RADIO.....	FM Radio Mode
AUX 1.....	AUX IN 1 Mode
AUX 2.....	AUX IN 2 Mode
OPT.....	OPTICAL IN Mode

3. During Playback:
 - Press and hold the VOL- or VOL+ button on the unit or press the VOL- or VOL+ button on remote control to adjust the volume.
 - Press the  button on remote control to turn off sound, press again to resume.
4. When finishing listening, press and hold the STANDBY/MODE button on the unit or press the  button on remote control to put the unit into standby mode.

WIFI SETUP

APP DOWNLOAD AND INSTALLATION

- Download the MUZO Player from Apple App store for iOS devies.
- Download MUZO Player from Google Play store for Android devices.
- The App icon will appear as the figure on right after successful installation.



CONNECTION

1. Plug one end of the adapter to DC IN jack of the speaker, then plug the adapter into the wall outlet, press and hold the STANDBY/MODE button on the unit to turn on the unit. Wait until "WIFI" blinks on display, now the speaker is ready for connection.

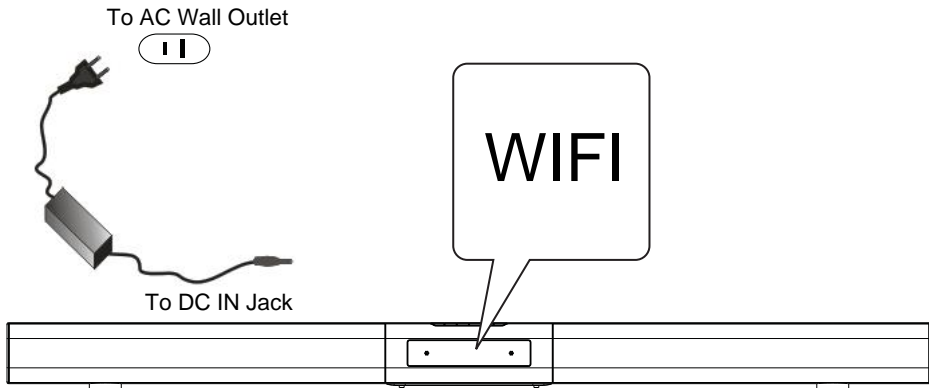

2. Turn on the WiFi on your iOS or Android device(smart phone or tablet with WiFi function), Connect your iOS or Android device to the desired WiFi network (router).

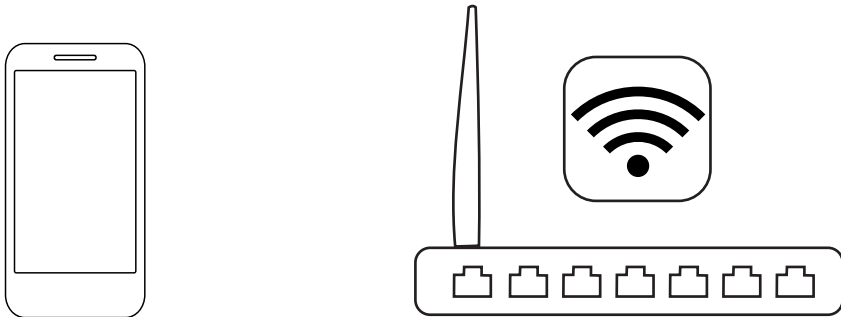

4. Inputing the WiFi password to make the speaker to connect to WiFi network(router),
Press the to continue.



5. **Press and hold the WPS button** on top of the speaker.

Press the button on your MUZO Player to continue.

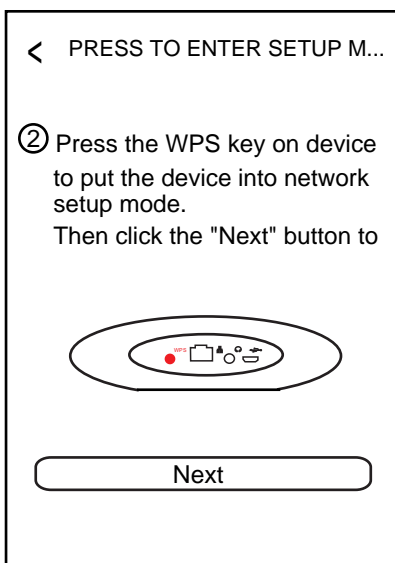

6. There will be voice instructing like " searching for WiFi connection", " waiting for WiFi connection" during the connecting process.

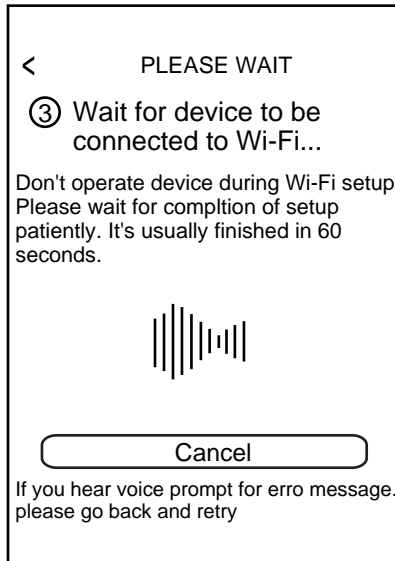

7. When the speaker is connected to the Wi-Fi (router) successfully, and the voice sounds "Wi-Fi connected", the Indicator on front of the speaker will keep **WHITE** and "WIFI" will stay on display.

If connection fails, please try again and repeat the above connecting steps.



communication status indicator

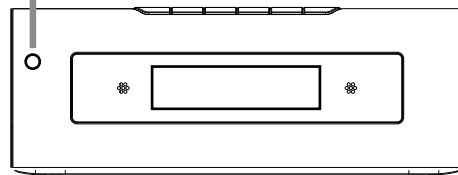

FRONT VIEW OF THE UNIT

HOME PAGE INTERFACE

Click the " MUZO " on screen to enter homepage, operate as below instructions and the screen instructions. Some platforms may need registration.

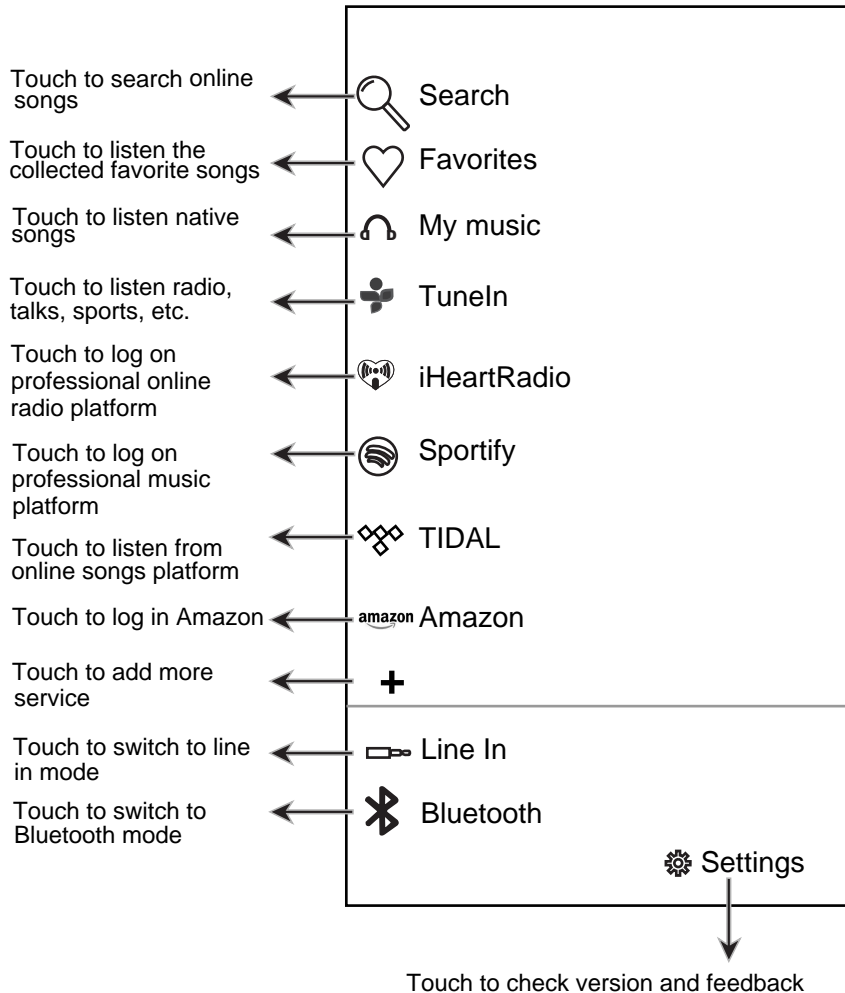

SPOTIFY OPERATION

Before use, you have to create an spotify premium account for log in.

1. Tap "Spotify" on MUZO homepage.
2. Input your account and password to log in.
3. Open the Spotify on your phone, tablet or PC, and play any song.
4. Tap the connect icon  .
5. Pick your device from the list.

Licenses

The Spotify Software is subject to third party licenses found here:
www.spotify.com/connect/third-party-licenses.

IHEARTRADIO OPERATION

Before use, you have to create an iHeartradio account for log in.

1. Tap "iHeartradio" on MUZO homepage.
2. Input your account and password to log in.
3. Select the desired song and play.

TIDAL OPERATION

Before use, you have to create a TIDAL account for log in.

1. Tap "TIDAL" on MUZO homepage.
2. Input your account and password to log in.
3. Select the desired song and play.

AMAZON LINKPLAY ALEXA VOICE CONTROL

Before using Amazon linkplay Alexa voice control function, you must get an Amazon prime account, create an account on Amazon website.

1. Touch  Amazon on homepage, the log in window will pop up, input your account and password to log in.
2. If you have logged in before, the figures below will appear and operate as the tips.

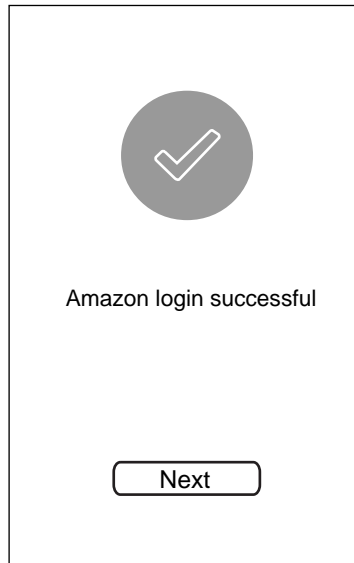

3. Press the  button once to activate the speaker to communicate before asking the speaker, (or you must say "ALEXA" to activate the speaker's communication system without pressing any button).

Example 1:

- Press the  button first, then ask the speaker, what's the weather like today?
The speaker will reply: the weather is not so cold.

Example 2:

- Just say "ALEXA", then you can ask the speaker, what's the time now?
The speaker will reply: it is 8 o'clock now.
- Continue to ask the speaker to do other things, such as "Play Music!".
The speaker will reply: here is the station we found, the music will be played.

4. If you want to stop asking or inquiring the speaker, or avoiding external voice interference, press and hold the  button to turn off voice input, the communication indicator will turn **RED**, press and hold this button again to turn on.

COMMUNICATION INDICATOR STATUS

communication status indicator

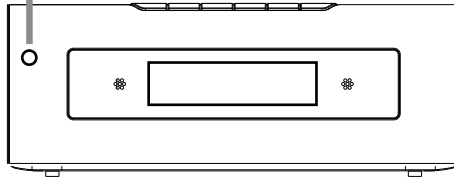

FRONT VIEW OF THE UNIT

SPEAKER STATUS	LED STATUS
Idle	White LED ON
Listening	Blue LED ON
Thinking	Blue LED ON
Talking	Blue LED blinks
Microphone Off	Red LED ON

BLUETOOTH OPERATION

Pairing the speaker with Bluetooth devices (phone or music device)

1. Plug one end of the adapter to DC IN jack of the speaker, plug the adapter into the wall outlet, press and hold the STANDBY/MODE button to power on the unit, wait until "WIFI" appears on display.
2. Press the MODE button repeatedly until the "BT" blinks on display. Now it is in pairing mode.
3. Activate the Bluetooth function on your Bluetooth device (phone or music device). Please refer to the manufacturer's instructions of your device.
4. Once you have activated Bluetooth on your device, select the speaker name from the pairing list of available Bluetooth devices.
NOTE: The pairing name is " NAXA NHS-5002 ".
5. Once paired successfully, "BT" will stay on display and a tone will be heard.
6. If pairing is unsuccessful, turn off the speaker first and then re-pair following above steps.
7. Once you have paired the speaker with a device, the speaker will remember this device and will pair automatically when the device's Bluetooth is activated and in range.

During playing:

- Press the ►|| button on the unit to pause, press again to resume playing.
- Press the ►| or |◄◄ on the unit to skip to next or previous track.
- Press and hold the VOL- or VOL+ button on the unit to adjust the volume.

RADIO OPERATION

Before using your unit for FM reception, unwrap and fully extend the antenna wire. You may need to adjust the position of the antenna wire for maximum signal strength.

1. Plug one end of the adapter to DC IN jack of the speaker, plug the adapter into the wall outlet, press and hold the STANDBY/MODE button to power on the unit, wait until "WIFI" appears on display.
2. Press the MODE button repeatedly until the "RADIO" blinks on display.
3. Press the ►| /WPS button on the unit to search up and down the band. The radio will search the station available and store automatically.
4. Press the ►► or ◀◀ to listen the stored station.

AUX IN 1 OPERATION

1. Connect the external audio device to the unit by an audio connection cable with 3.5mm stereo mini jacks as:
 - ~ Insert one end to the Phone; Line Out or AUX Out Jack on the external audio device.
 - ~ Insert the other end to the AUX IN jack on the rear of the main unit.

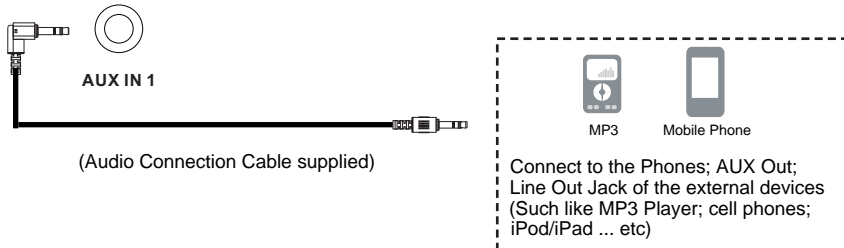

2. Plug one end of the adapter to DC IN jack of the speaker, plug the adapter into the wall outlet, press and hold the STANDBY/MODE button to power on the unit, wait until "WIFI" appears on display.
3. Press the MODE button repeatedly until the "AUX 1" blinks on display.
4. Play music as usual on your external device.

AUX IN 2 OPERATION

An external Video/audio player(such as TV, DVD Player, VCR etc.) can be connected to this unit and heard through the speakers.

1. Plug one end of RCA White and Red cable into the LINE IN jacks on the rear of the unit. Plug the other end of RCA White and Red cable into audio out jacks of TV or external device as the illustration shown as below.

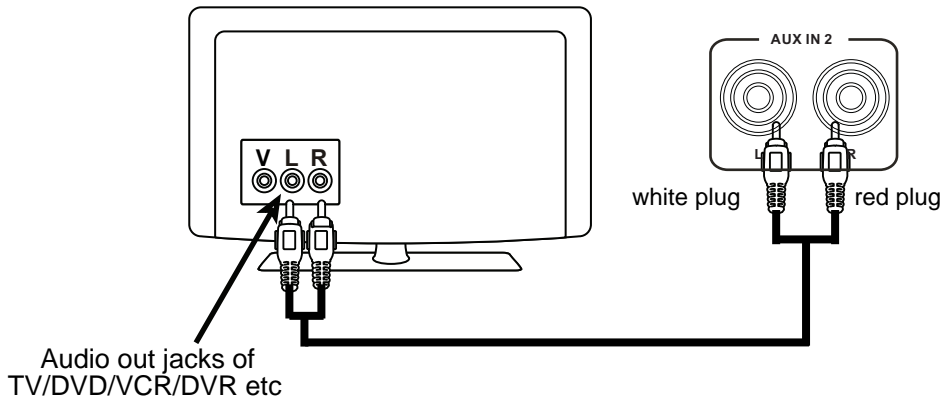

2. Plug one end of the adapter to DC IN jack of the speaker, plug the adapter into the wall outlet, press and hold the STANDBY/MODE button to power on the unit, wait until "WIFI" appears on display.
3. Press the MODE button repeatedly until the "AUX 2" blinks on display.
4. Play music as usual on your external device.

OPTICAL IN OPERATION

1. Connect the Optical out jack from the external audio Player (such like TV, DVD Player BD Player ...etc.) to the OPTICAL IN jack on the top of unit by the Optical Connection Cable (not supplied) as the figure below: (For PCM format only)

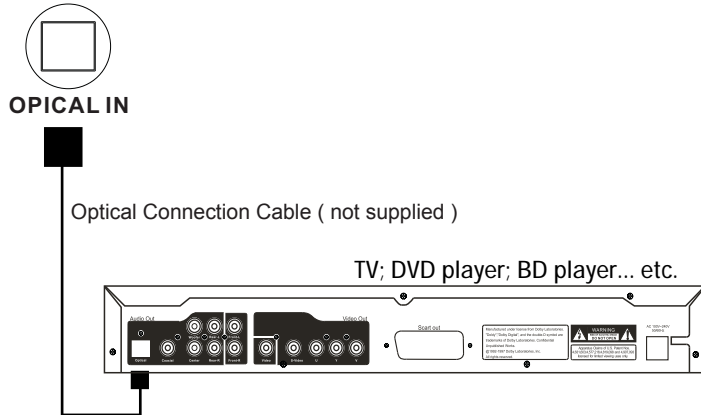

2. Plug one end of the adapter to DC IN jack of the speaker, plug the adapter into the wall outlet, press and hold the STANDBY/MODE button to power on the unit, wait until "WIFI" appears on display.
3. Press the MODE button repeatedly until the "OPT" blinks on display.
4. Power on the connected external player and start playback the Music as usual. Turn on the digital audio output and set it to PCM (Plus Code Modulation) type similar to the follows figure:

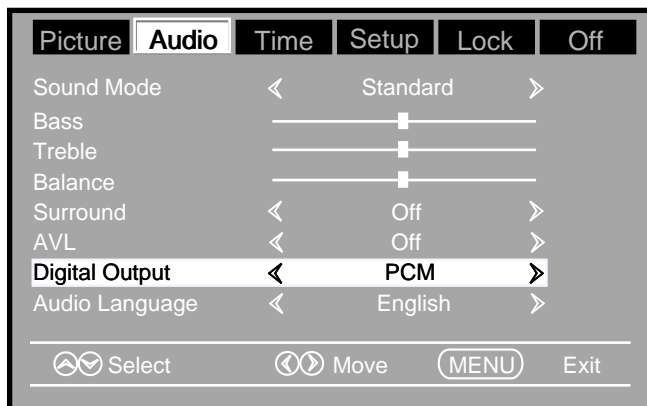





TROUBLESHOOTING

Check the following before requesting service:

SYMPTOM	POSSIBLE CAUSE	POSSIBLE SOLUTION
No sound or sound weak	Volume level of paired/connected device is in low level	Rise the volume level of the paired/connected device
Sound distortion	Volume level of the connected/paired device too high	Reduce the volume level of the connected/paired device
BT not functioning	The external BT device had NOT paired to the unit	Pair the external BT device to the unit
	The external BT device too far from the unit	Place the external BT device close to the unit

SPECIFICATTIONS

Power Source:

DC16V  3A   

BT Version:

4.1

BT Operation Distance:

about 32 Feet in open area

Wifi Operation Distance:

about 96 Feet in open area

PACKAGE INCLUDES

- 1 X User's Manual
- 1 X AC/DC Adapter
- 1 X Audio Cable with 3.5mm Plug
- 1 X RCA Audio Cable

**SPECIFICATIONS AND ACCESSORIES ARE SUBJECT TO CHANGE
WITHOUT NOTICE**



LIMITED WARRANTY

NAXA LIMITED WARRANTY (“Warranty”) — For Product Categories Listed in Chart Below (as applicable, “Product”).

Before returning your Product for service under this Warranty, please read the instruction manual carefully and visit our website at www.naxa.com for product updates and extended support documentation (e.g., Frequently Asked Questions, Common Troubleshooting Guides, etc ...). If you are still having trouble with your Product, please contact Naxa Customer Support.

Warning: *Some Products may contain components that are small enough to be swallowed. Please keep out of reach of children.*

Subject to the terms and conditions herein, Naxa Electronics, Inc. (herein after called “Naxa”) warrants to the original purchaser of the Product (“Customer”) that the Product will be free from defects in material or workmanship under normal, non-commercial use (“Defects”) for the applicable Warranty Period listed below.

Warranty Period encompasses separate “Coverage Periods” for Parts and Labor as listed in the table below. Each Coverage Period begins from the original date of Customer purchase. If Customer returns a defective Product (or any component thereof) during the applicable Coverage Period, Naxa will, at its option: (1) repair the Product (or any component thereof) or; (2) replace the Product (or any component thereof) with a new or refurbished Product (or any component thereof), in either case free of charge to Customer for Parts and/or Labor during the specified Coverage Period only, and excluding the applicable shipping charges noted below for which the Customer is responsible. The foregoing states the Customer’s exclusive remedy and Naxa’s sole liability for breach of the limited warranty contained herein.

This warranty specifically excludes any product that has been subject to or has defects resulting from:(a)any neglect or misuse by a Customer; (b) an accident, improper application, violation of operating instructions for the Product, or any other Customer-induced damage; (c) the alteration or removal of any Product serial number; (d) any modification or repair to Product (or any component thereof) by any party other than Naxa or a party authorized in writing by Naxa; (e) any damage to Product due to power surges, incorrect electrical voltage, misconnection to any device, or malfunction of any device used with the Product (or, as applicable, any component thereof); (f) cosmetic damage to the Product caused by normal wear and tear; (g) shipping damage that occurs while the Product is in transit; (h) damage caused by heat sources, sunlight, electromagnetic conditions, or other climatic conditions; or (i) any acts of God. Refurbished products are not covered by this Warranty.

Product is sold to Customer for personal, non-commercial use only. Product is not warranted for commercial or rental use. In addition, Product is not warranted against failure, and should not be used by Customer for any application where there is a risk that any data stored on Product will be breached or otherwise compromised, or the data stored on Product is relied upon for medical or lifesaving applications. Naxa disclaims any Warranty for any of the foregoing uses to the fullest extent permitted by law. Customer assumes any and all risks associated with such uses of Product, and agrees to indemnify Naxa for any damages claimed for such uses.

EXCEPT FOR THE EXPRESS WARRANTIES STATED ABOVE AND TO THE MAXIMUM EXTENT PERMITTED BY LAW, ALL PRODUCTS ARE PROVIDED “AS IS”, AND NAXA DISCLAIMS ALL OTHER WARRANTIES, INCLUDING WITHOUT LIMITATION ANY IMPLIED WARRANTY OF (I) MERCHANTABILITY; (II) FITNESS FOR A PARTICULAR PURPOSE, OR; (III) NON-INFRINGEMENT OF THIRD PARTY RIGHTS. TO THE MAXIMUM EXTENT PERMITTED BY APPLICABLE LAW, IN NO EVENT WILL NAXA BE LIABLE TO CUSTOMER OR ANY THIRD PARTY FOR ANY INDIRECT, SPECIAL, INCIDENTAL, CONSEQUENTIAL, EXEMPLARY OR PUNITIVE DAMAGES, INCLUDING, WITHOUT LIMITATION, ANY LOST PROFITS OR REVENUES, LOSS OR INACCURACY OF ANY DATA, OR COST OF SUBSTITUTE GOODS, REGARDLESS OF THE THEORY OF LIABILITY (INCLUDING NEGLIGENCE) AND EVEN IF NAXA HAS BEEN ADVISED OF THE POSSIBILITY OF SUCH DAMAGES, NAXA’S AGGREGATE LIABILITY TO CUSTOMER FOR ACTUAL DIRECT DAMAGES FOR ANY CAUSE WHATSOEVER SHALL BE LIMITED TO THE CUMULATIVE PRODUCT FEES PAID BY THAT CUSTOMER FOR THE PRODUCTS CAUSING THE DAMAGES, IF ANY.

This Warranty gives Customer specific rights, and Customer may also have other rights that vary from jurisdiction to jurisdiction.

All warranty returns must have an RMA number provided by Naxa Customer Support. An RMA number can be obtained by contacting Naxa Customer Support by phone, email, or online by using the RMA ticketing system at www.naxa.com.

Naxa Electronics, Inc.
RMA Processing / Customer Support
2320 E. 49th St., Vernon, CA 90058

Email: support@naxa.com
Phone: (866) 411-6292
Web: www.naxa.com

Hours of Operation:
Monday – Friday
10:00 AM to 5:00 PM PST