



# FCC RADIO TEST REPORT-BT

## FCC ID:OKUCAW37051

**Product:** Wi-Fi&Bluetooth Speaker with Amazon Alexa Voice Control  
**Trade Mark:** NAXA  
**Model No.:** NAS-5000  
**Serial Model:** CAW-37051  
**Report No.:** NTEK- 2017NT02101410F2  
**Issue Date:** 06 Mar. 2017

### Prepared for

Shenzhen Junlan Electronic Ltd  
No.277 PingKui Road, Shijing Community, Pingshan Street, Pingshan New  
District, Shenzhen, China

### Prepared by

NTEK TESTING TECHNOLOGY CO., LTD.  
1/F, Building E, Fenda Science Park, Sanwei Community,  
Xixiang Street Bao'an District, Shenzhen 518126 P.R. China  
Tel.: +86-755-6115 6588  
Fax.: +86-755-6115 6599  
Website:<http://www.ntek.org.cn>

## TABLE OF CONTENTS

|          |   |           |
|----------|---|-----------|
| <b>1</b> | <b>TEST RESULT CERTIFICATION .....</b>          | <b>3</b>  |
| <b>2</b> | <b>SUMMARY OF TEST RESULTS.....</b>             | <b>4</b>  |
| <b>3</b> | <b>FACILITIES AND ACCREDITATIONS .....</b>      | <b>5</b>  |
| 3.1      | FACILITIES .....                                | 5         |
| 3.2      | LABORATORY ACCREDITATIONS AND LISTINGS .....    | 5         |
| 2.3      | MEASUREMENT UNCERTAINTY .....                   | 5         |
| <b>4</b> | <b>GENERAL DESCRIPTION OF EUT .....</b>         | <b>6</b>  |
| <b>5</b> | <b>DESCRIPTION OF TEST MODES .....</b>          | <b>8</b>  |
| <b>6</b> | <b>SETUP OF EQUIPMENT UNDER TEST .....</b>      | <b>10</b> |
| 6.1      | BLOCK DIAGRAM CONFIGURATION OF TEST SYSTEM..... | 10        |
| 6.2      | SUPPORT EQUIPMENT.....                          | 11        |
| 6.3      | EQUIPMENTS LIST FOR ALL TEST ITEMS.....         | 12        |
| <b>7</b> | <b>TEST REQUIREMENTS .....</b>                  | <b>14</b> |
| 7.1      | CONDUCTED EMISSIONS TEST .....                  | 14        |
| 7.2      | RADIATED SPURIOUS EMISSION .....                | 19        |
| 7.3      | 6DB BANDWIDTH.....                              | 28        |
| 7.4      | 20DB BANDWIDTH.....                             | 32        |
| 7.5      | DUTY CYCLE.....                                 | 36        |
| 7.6      | MAXIMUM OUTPUT POWER.....                       | 40        |
| 7.7      | POWER SPECTRAL DENSITY .....                    | 42        |
| 7.8      | CONDUCTED BAND EDGE MEASUREMENT.....            | 46        |
| 7.9      | SPURIOUS RF CONDUCTED EMISSIONS.....            | 49        |
| 7.10     | ANTENNA APPLICATION .....                       | 62        |

# 1 TEST RESULT CERTIFICATION

|                                   |   |
|-----------------------------------|---|
| Applicant's name .....            | Shenzhen Junlan Electronic Ltd  |
| Address .....                     | No.277 PingKui Road, Shijing Community, Pingshan Street, Pingshan New District, Shenzhen, China |
| Manufacturer's Name .....         | Shenzhen Junlan Electronic Ltd  |
| Address .....                     | No.277 PingKui Road, Shijing Community, Pingshan Street, Pingshan New District, Shenzhen, China |
| Factory's Name .....              | Shenzhen Junlan Electronic Ltd  |
| Address .....                     | No.277 PingKui Road, Shijing Community, Pingshan Street, Pingshan New District, Shenzhen, China |
| Product description               |   |
| Product name .....                | Wi-Fi&Bluetooth Speaker with Amazon Alexa Voice Control   |
| Model and/or type reference ..... | NAS-5000  |
| Serial Model .....                | CAW-37051   |

Measurement Procedure Used:

| APPLICABLE STANDARDS   |             |
|--|-------------|
| APPLICABLE STANDARD/ TEST PROCEDURE  | TEST RESULT |
| FCC 47 CFR Part 2, Subpart J:2016<br>FCC 47 CFR Part 15, Subpart C:2016<br>KDB 174176 D01 Line Conducted FAQ v01r01<br>ANSI C63.10-2013<br>FCC KDB 558074 D01 DTS Meas Guidance v03r05 | Complied    |

This device described above has been tested by NTEK Testing Technology Co., Ltd., and the test results show that the equipment under test (EUT) is in compliance with the FCC requirements. And it is applicable only to the tested sample identified in the report.

This report shall not be reproduced except in full, without the written approval of NTEK Testing Technology Co., Ltd., this document may be altered or revised by NTEK Testing Technology Co., Ltd., personnel only, and shall be noted in the revision of the document.

The test results of this report relate only to the tested sample identified in this report.

Date of Test : 10 Feb. 2017 ~ 06 Mar. 2017

Testing Engineer :   
(Allen Liu)

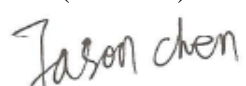
Technical Manager :   
(Jason Chen)

Authorized Signatory :   
(Sam Chen)

## 2 SUMMARY OF TEST RESULTS

| FCC Part15 (15.247), Subpart C |                            |         |        |
|--------------------------------|----------------------------|---------|--------|
| Standard Section               | Test Item                  | Verdict | Remark |
| 15.207                         | Conducted Emission         | PASS    |        |
| 15.247 (a)(2)                  | 6dB Bandwidth              | PASS    |        |
| 15.247 (a)(2)                  | 20dB Bandwidth             | PASS    |        |
| 15.247 (a)(2)                  | DUTY CYCLE                 | PASS    |        |
| 15.247 (b)                     | Maximum Output Power       | PASS    |        |
| 15.247 (c)                     | Radiated Spurious Emission | PASS    |        |
| 15.247 (d)                     | Power Spectral Density     | PASS    |        |
| 15.205                         | Band Edge Emission         | PASS    |        |
| 15.203                         | Antenna Requirement        | PASS    |        |

**Remark:**

1. "N/A" denotes test is not applicable in this Test Report.
2. All test items were verified and recorded according to the standards and without any deviation during the test.

### 3 FACILITIES AND ACCREDITATIONS

#### 3.1 FACILITIES

All measurement facilities used to collect the measurement data are located at 1/F, Building E, Fenda Science Park, Sanwei Community, Xixiang Street, Bao'an District, Shenzhen P.R. China.

The sites are constructed in conformance with the requirements of ANSI C63.7, ANSI C63.10 and CISPR Publication 22.

#### 3.2 LABORATORY ACCREDITATIONS AND LISTINGS

Site Description

EMC Lab. : Accredited by CNAS, 2014.09.04  
 The certificate is valid until 2017.09.03  
 The Laboratory has been assessed and proved to be in compliance with CNAS-CL01:2006 (identical to ISO/IEC 17025:2005)  
 The Certificate Registration Number is L5516.

Accredited by Industry Canada, August 29, 2012  
 The Certificate Registration Number is 9270A-1.

Accredited by FCC, September 6, 2013  
 The Certificate Registration Number is 238937.

Name of Firm : NTEK Testing Technology Co., Ltd  
 Site Location : 1/F, Building E, Fenda Science Park, Sanwei Community, Xixiang Street, Bao'an District, Shenzhen P.R. China.

#### 2.3 MEASUREMENT UNCERTAINTY

The reported uncertainty of measurement  $y \pm U$ , where expanded uncertainty  $U$  is based on a standard uncertainty multiplied by a coverage factor of  $k=2$ , providing a level of confidence of approximately 95 %.

| No. | Item                          | Uncertainty             |
|-----|-------------------------------|-------------------------|
| 1   | Conducted Emission Test       | $\pm 1.38\text{dB}$     |
| 2   | RF power, conducted           | $\pm 0.16\text{dB}$     |
| 3   | Spurious emissions, conducted | $\pm 0.21\text{dB}$     |
| 4   | All emissions, radiated(<1G)  | $\pm 4.68\text{dB}$     |
| 5   | All emissions, radiated(>1G)  | $\pm 4.89\text{dB}$     |
| 6   | Temperature                   | $\pm 0.5^\circ\text{C}$ |
| 7   | Humidity                      | $\pm 2\%$               |

#### 4 GENERAL DESCRIPTION OF EUT

| Product Feature and Specification |  |
|-----------------------------------|--|
| Equipment                         | Wi-Fi&Bluetooth Speaker with Amazon Alexa Voice Control                                  |
| Trade Mark                        | NAXA   |
| FCC ID                            | OKUCAW37051  |
| Model No.                         | NAS-5000   |
| Serial Model                      | CAW-37051  |
| Model Difference                  | All the model are the same circuit and RF module, except the model No..                  |
| Operating Frequency               | 2412-2462MHz for 802.11b/g/11n(HT20/);<br>2422-2452MHz for 802.11n(HT40);                |
| Modulation                        | DSSS with DBPSK/DQPSK/CCK for 802.11b;<br>OFDM with BPSK/QPSK/16QAM/64QAM for 802.11g/n; |
| Number of Channels                | 11 channels for 802.11b/g/11n(HT20);<br>7 channels for 802.11n(HT40);                    |
| Antenna Type                      | Steel antenna  |
| Antenna Gain                      | 1 dBi  |
| Rating(s)                         | DC 3.7V from battery or DC 5V from USB Port  |
| Power supply                      | <input checked="" type="checkbox"/> DC supply:<br>DC 3.7V/2000mAh                        |
|                                   | <input type="checkbox"/> Adapter supply:   |
| HW Version                        | V1.0   |
| SW Version                        | V1.0   |

Note: Based on the application, features, or specification exhibited in User's Manual, the EUT is considered as an ITE/Computing Device. More details of EUT technical specification, please refer to the User's Manual.



## 5 DESCRIPTION OF TEST MODES

To investigate the maximum EMI emission characteristics generates from EUT, the test system was pre-scanning tested base on the consideration of following EUT operation mode or test configuration mode which possible have effect on EMI emission level. Each of these EUT operation mode(s) or test configuration mode(s) mentioned above was evaluated respectively.

The Transmitter was operated in the normal operating mode. The TX frequency was fixed which was for the purpose of the measurements.

Test of channel included the lowest and middle and highest frequency to perform the test, then record on this report.

Those data rates (802.11b: 1 Mbps; 802.11g: 6 Mbps; 802.11n (HT20): MCS0; were used for all test.

The EUT was pretested with 3 orientations placed on the table for the radiated emission measurement –X, Y, and Z-plane. The Y-plane results were found as the worst case and were shown in this report.

Frequency and Channel list for 802.11b/g/n (HT20):

| Channel | Frequency(MHz) |
|---------|----------------|
| 1       | 2412           |
| 2       | 2417           |
| ...     | ...            |
| 5       | 2432           |
| 6       | 2437           |
| ...     | ...            |
| 10      | 2457           |
| 11      | 2462           |

Note:  $f_c=2412\text{MHz}+k \times 5\text{MHz}$   $k=0$  to 10

1. EUT built-in battery-powered, fully-charged battery use of the test battery



Test Mode:

| Test Items                        | Mode        | Data Rate | Channel | Ant |
|-----------------------------------|-------------|-----------|---------|-----|
| AC Power Line Conducted Emissions | Normal Link | -         | -       | -   |
| Maximum Conducted Output Power    | 11b/CCK     | 1 Mbps    | 1/6/11  | 1   |
|                                   | 11g/BPSK    | 6 Mbps    | 1/6/11  | 1   |
|                                   | 11n HT20    | MCS0      | 1/6/11  | 1   |
|                                   | 11n HT40    | MCS0      | 3/6/9   | 1   |
| Power Spectral Density            | 11b/CCK     | 1 Mbps    | 1/6/11  | 1   |
|                                   | 11g/BPSK    | 6 Mbps    | 1/6/11  | 1   |
|                                   | 11n HT20    | MCS0      | 1/6/11  | 1   |
|                                   | 11n HT40    | MCS0      | 3/6/9   | 1   |
| 6dB Spectrum Bandwidth            | 11b/CCK     | 1 Mbps    | 1/6/11  | 1   |
|                                   | 11g/BPSK    | 6 Mbps    | 1/6/11  | 1   |
|                                   | 11n HT20    | MCS0      | 1/6/11  | 1   |
|                                   | 11n HT40    | MCS0      | 3/6/9   | 1   |
| Radiated Emissions Below 1GHz     | Normal Link | -         | -       | -   |
| Radiated Emissions Above 1GHz     | 11b/CCK     | 1 Mbps    | 1/6/11  | 1   |
|                                   | 11g/BPSK    | 6 Mbps    | 1/6/11  | 1   |
|                                   | 11n HT20    | MCS0      | 1/6/11  | 1   |
|                                   | 11n HT40    | MCS0      | 3/6/9   | 1   |
| Band Edge Emissions               | 11b/CCK     | 1 Mbps    | 1/6/11  | 1   |
|                                   | 11g/BPSK    | 6 Mbps    | 1/6/11  | 1   |
|                                   | 11n HT20    | MCS0      | 1/6/11  | 1   |
|                                   | 11n HT40    | MCS0      | 3/6/9   | 1   |

## 6 SETUP OF EQUIPMENT UNDER TEST

### 6.1 BLOCK DIAGRAM CONFIGURATION OF TEST SYSTEM

For AC Conducted Emission Mode

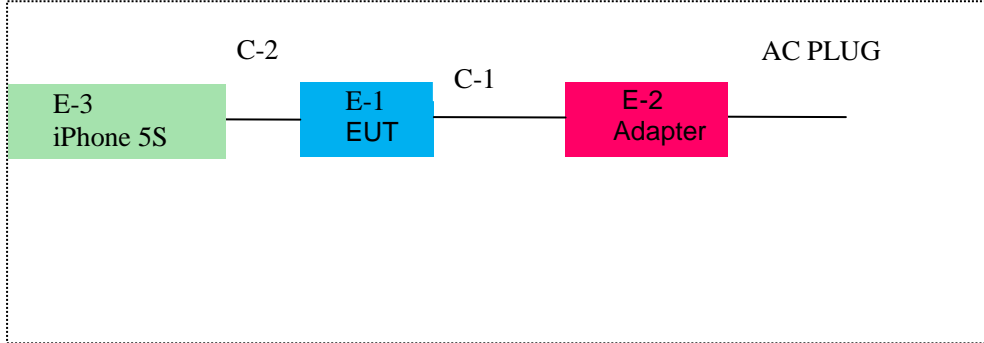

For Radiated Test Cases

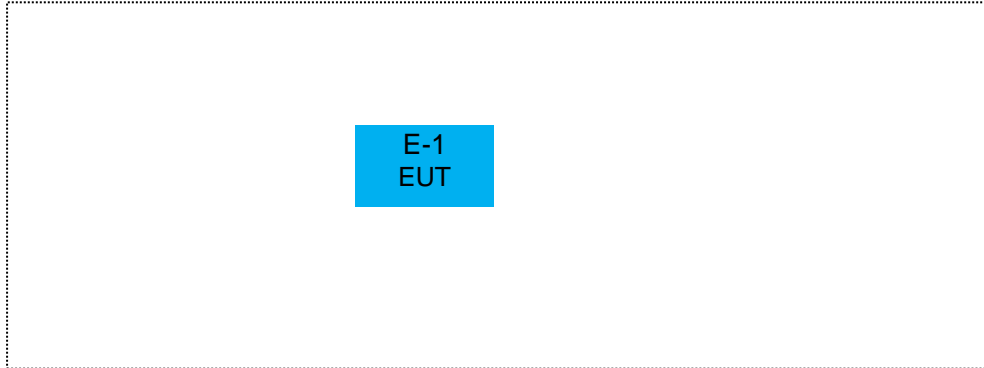

For Conducted Test Cases

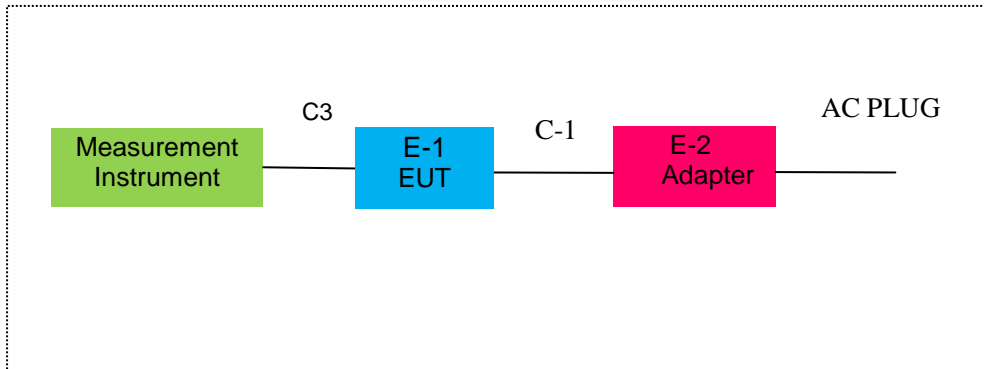

Note: The temporary antenna connector is soldered on the PCB board in order to perform conducted tests and this temporary antenna connector is listed in the equipment list.

**6.2 SUPPORT EQUIPMENT**

The EUT has been tested as an independent unit together with other necessary accessories or support units. The following support units or accessories were used to form a representative test configuration during the tests.

| Item | Equipment   | Mfr/Brand | Model/Type No.    | FCC ID      | Note        |
|------|---|-----------|-------------------|-------------|-------------|
| E-1. | Wi-Fi&Bluetooth Speaker with Amazon Alexa Voice Control | NAXA      | NAS-5000          | OKUCAW37051 | EUT         |
| E-2  | Adapter   | N/A       | ADAPAQ11050020006 | N/A         | Peripherals |
| E-3  | iPhone 5S   | Apple     | A1518             | N/A         |             |
|      |   |           |                   |             |             |

| Item | Cable Type | Shielded Type | Ferrite Core | Length |
|------|------------|---------------|--------------|--------|
| C-1  | USB Cable  | NO            | NO           | 1.2m   |
| C-2  | USB Cable  | NO            | NO           | 1.2m   |
| c-3  | RF Cable   | NO            | NO           | 0.5m   |
|      |            |               |              |        |
|      |            |               |              |        |
|      |            |               |              |        |
|      |            |               |              |        |

**Notes:**

- (1) The support equipment was authorized by Declaration of Confirmation.
- (2) For detachable type I/O cable should be specified the length in cm in 『Length』 column.
- (3) “YES” is means “shielded” “with core”; “NO” is means “unshielded” “without core”.

### 6.3 EQUIPMENTS LIST FOR ALL TEST ITEMS

#### Radiation Test equipment

| Item | Kind of Equipment                         | Manufacturer | Type No.      | Serial No. | Last calibration | Calibrated until | Calibration period |
|------|---|--------------|---------------|------------|------------------|------------------|--------------------|
| 1    | Spectrum Analyzer                         | Agilent      | E4407B        | MY45108040 | 2016.07.06       | 2017.07.05       | 1 year             |
| 2    | Spectrum Analyzer                         | Agilent      | N9020A        | MY49100060 | 2016.07.06       | 2017.07.05       | 1 year             |
| 3    | EMI Test Receiver                         | Agilent      | N9038A        | MY53227146 | 2016.06.06       | 2017.06.05       | 1 year             |
| 4    | Test Receiver                             | R&S          | ESPI          | 101318     | 2016.06.06       | 2017.06.05       | 1 year             |
| 5    | Bilog Antenna                             | TESEQ        | CBL6111D      | 31216      | 2016.07.06       | 2017.07.05       | 1 year             |
| 6    | 50Ω Coaxial Switch                        | Anritsu      | MP59B         | 6200264416 | 2016.06.06       | 2017.06.05       | 1 year             |
| 7    | Horn Antenna                              | EM           | EM-AH-10180   | 2011071402 | 2016.07.06       | 2017.07.05       | 1 year             |
| 8    | Horn Ant                                  | Schwarzbeck  | BBHA 9170     | 9170-181   | 2016.07.06       | 2017.07.05       | 1 year             |
| 9    | Amplifier                                 | EM           | EM-30180      | 060538     | 2016.12.22       | 2017.12.21       | 1 year             |
| 10   | Amplifier                                 | MITEQ        | TTA1840-35-HG | 177156     | 2016.06.06       | 2017.06.05       | 1 year             |
| 11   | Loop Antenna                              | ARA          | PLA-1030/B    | 1029       | 2016.06.06       | 2017.06.05       | 1 year             |
| 12   | Power Meter                               | DARE         | RPR3006W      | 100696     | 2016.07.06       | 2017.07.05       | 1 year             |
| 13   | Test Cable (9KHz-30MHz)                   | N/A          | R-01          | N/A        | 2016.07.06       | 2017.07.05       | 1 year             |
| 14   | Test Cable (30MHz-1GHz)                   | N/A          | R-02          | N/A        | 2016.07.06       | 2017.07.05       | 1 year             |
| 15   | High Test Cable(1G-40G Hz)                | N/A          | R-03          | N/A        | 2016.06.06       | 2017.06.05       | 1 year             |
| 16   | High Test Cable(1G-40G Hz)                | N/A          | R-04          | N/A        | 2016.06.06       | 2017.06.05       | 1 year             |
| 17   | temporary antenna connector<br><br>(Note) | NTS          | R001          | N/A        | N/A              | N/A              | N/A                |

Note:

We will use the temporary antenna connector (soldered on the PCB board) When conducted test  
And this temporary antenna connector is listed within the instrument list

Conduction Test equipment

| Item | Kind of Equipment       | Manufacturer | Type No. | Serial No. | Last calibration | Calibrated until | Calibration period |
|------|-------------------------|--------------|----------|------------|------------------|------------------|--------------------|
| 1    | Test Receiver           | R&S          | ESCI     | 101160     | 2016.06.06       | 2017.06.05       | 1 year             |
| 2    | LISN                    | R&S          | ENV216   | 101313     | 2016.08.24       | 2017.08.23       | 1 year             |
| 3    | LISN                    | EMCO         | 3816/2   | 00042990   | 2016.08.24       | 2017.08.23       | 1 year             |
| 4    | 50Ω Coaxial Switch      | Anritsu      | MP59B    | 6200264417 | 2016.06.07       | 2017.06.06       | 1 year             |
| 5    | Test Cable (9KHz-30MHz) | N/A          | C01      | N/A        | 2016.06.08       | 2017.06.07       | 1 year             |
| 6    | Test Cable (9KHz-30MHz) | N/A          | C02      | N/A        | 2016.06.08       | 2017.06.07       | 1 year             |
| 7    | Test Cable (9KHz-30MHz) | N/A          | C03      | N/A        | 2016.06.08       | 2017.06.07       | 1 year             |

Note: Each piece of equipment is scheduled for calibration once a year.

## 7 TEST REQUIREMENTS

### 7.1 CONDUCTED EMISSIONS TEST

#### 7.1.1 Applicable Standard

According to FCC Part 15.207(a) and KDB 174176 D01 Line Conducted FAQ v01r01

#### 7.1.2 Conformance Limit

| Frequency(MHz) | Conducted Emission Limit |         |
|----------------|--------------------------|---------|
|                | Quasi-peak               | Average |
| 0.15-0.5       | 66-56*                   | 56-46*  |
| 0.5-5.0        | 56                       | 46      |
| 5.0-30.0       | 60                       | 50      |

Note: 1. \*Decreases with the logarithm of the frequency  
 2. The lower limit shall apply at the transition frequencies  
 3. The limit decreases in line with the logarithm of the frequency in the range of 0.15 to 0.50MHz.

#### 7.1.3 Measuring Instruments

The Measuring equipment is listed in the section 6.3 of this test report.

#### 7.1.4 Test Configuration

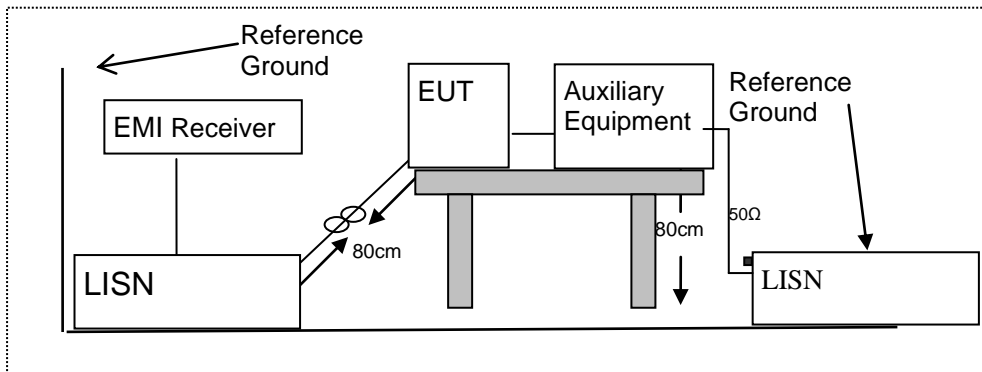

#### 7.1.5 Test Procedure

According to the requirements in Section 13.1.4.1 of ANSI C63.10-2013 Conducted emissions the EUT measured in the frequency range between 0.15 MHz and 30 MHz using CISPR Quasi-Peak and average detector mode.

1. The EUT was placed 0.4 meter from the conducting wall of the shielding room.
2. The EUT was placed on a table which is 0.8m above ground plane.
3. Connect EUT to the power mains through a line impedance stabilization network (LISN). All other support equipments powered from additional LISN(s). The LISN provide 50 Ohm/ 50uH of coupling impedance for the measuring instrument.
4. Interconnecting cables that hang closer than 40 cm to the ground plane shall be folded back and forth in the center forming a bundle 30 to 40cm long.
5. I/O cables that are not connected to a peripheral shall be bundled in the center. The end of the cable may be terminated, if required, using the correct terminating impedance. The overall length shall not exceed 1 m.
6. LISN at least 80 cm from nearest part of EUT chassis.
7. The frequency range from 150KHz to 30MHz was searched.
8. Set the test-receiver system to Peak Detect Function and specified bandwidth(IF bandwidth=9KHz) with Maximum Hold Mode
9. For the actual test configuration, please refer to the related Item –EUT Test Photos.

**7.1.6 Test Results**

|                |   |                    |             |
|----------------|---|--------------------|-------------|
| EUT:           | Wi-Fi&Bluetooth Speaker with Amazon Alexa Voice Control | Model Name :       | NAS-5000    |
| Temperature:   | 26 °C   | Relative Humidity: | 54%         |
| Pressure:      | 1010hPa   | Phase :            | L           |
| Test Voltage : | DC 5V from USB Port AC 120V/60Hz                        | Test Mode:         | Normal Link |

| Frequency (MHz) | Reading Level (dBμV) | Correct Factor (dB) | Measure-ment (dBμV) | Limits (dBμV) | Margin (dB) | Remark |
|-----------------|----------------------|---------------------|---------------------|---------------|-------------|--------|
| 0.19            | 36.72                | 10.16               | 46.88               | 64.03         | -17.15      | QP     |
| 0.19            | 26.96                | 10.16               | 37.12               | 54.03         | -16.91      | AVG    |
| 0.462           | 36.56                | 9.88                | 46.44               | 56.66         | -10.22      | QP     |
| 0.462           | 31.38                | 9.88                | 41.26               | 46.66         | -5.4        | AVG    |
| 1.386           | 38.46                | 9.75                | 48.21               | 56            | -7.79       | QP     |
| 1.386           | 30.06                | 9.75                | 39.81               | 46            | -6.19       | AVG    |
| 2.31            | 36.21                | 9.76                | 45.97               | 56            | -10.03      | QP     |
| 2.31            | 29.83                | 9.76                | 39.59               | 46            | -6.41       | AVG    |
| 3.2299          | 35.78                | 9.77                | 45.55               | 56            | -10.45      | QP     |
| 3.2299          | 25.81                | 9.77                | 35.58               | 46            | -10.42      | AVG    |
| 4.1539          | 36.12                | 9.78                | 45.9                | 56            | -10.1       | QP     |
| 4.1539          | 27.24                | 9.78                | 37.02               | 46            | -8.98       | AVG    |

Remark:

1. All readings are Quasi-Peak and Average values.
2. Factor = Insertion Loss + Cable Loss.

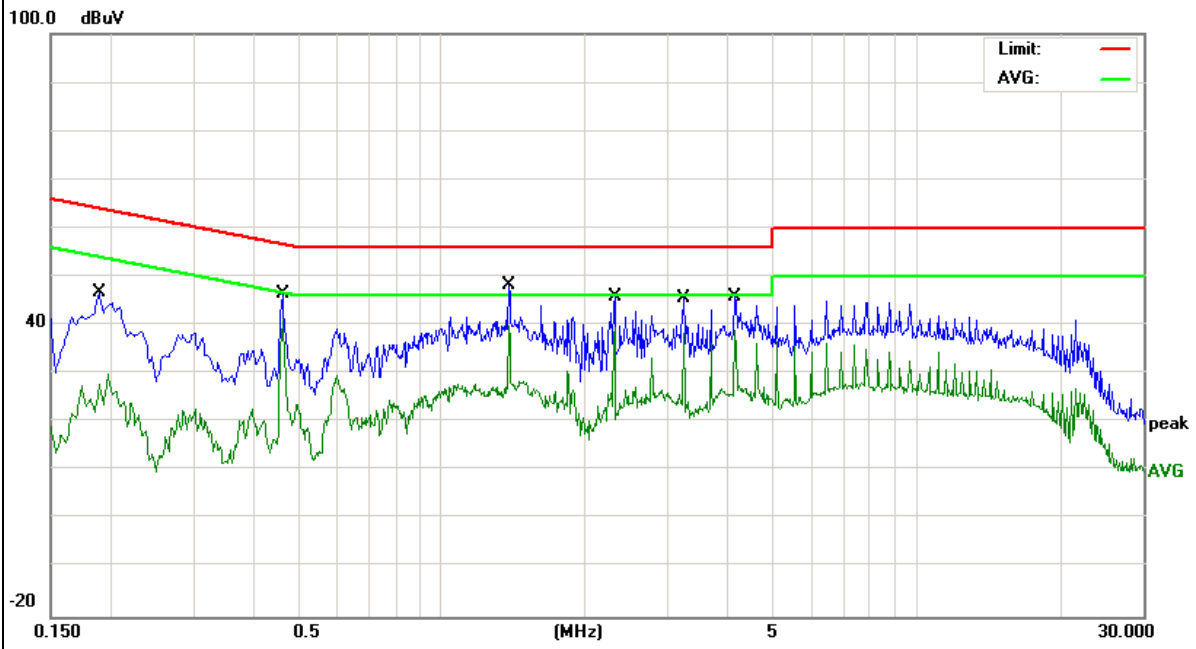

|                |   |                    |             |
|----------------|---|--------------------|-------------|
| EUT:           | Wi-Fi&Bluetooth Speaker with Amazon Alexa Voice Control | Model Name :       | NAS-5000    |
| Temperature:   | 26 °C   | Relative Humidity: | 54%         |
| Pressure:      | 1010hPa   | Phase :            | N           |
| Test Voltage : | DC 5V from USB Port AC 120V/60Hz                        | Test Mode:         | Normal Link |

| Frequency (MHz) | Reading Level (dBμV) | Correct Factor (dB) | Measure-ment (dBμV) | Limits (dBμV) | Margin (dB) | Remark |
|-----------------|----------------------|---------------------|---------------------|---------------|-------------|--------|
| 0.19            | 34.92                | 10.12               | 45.04               | 64.03         | -18.99      | QP     |
| 0.19            | 27                   | 10.12               | 37.12               | 54.03         | -16.91      | AVG    |
| 0.462           | 30.61                | 9.88                | 40.49               | 56.66         | -16.17      | QP     |
| 0.462           | 27.33                | 9.88                | 37.21               | 46.66         | -9.45       | AVG    |
| 0.5899          | 30.68                | 9.81                | 40.49               | 56            | -15.51      | QP     |
| 0.5899          | 22.77                | 9.81                | 32.58               | 46            | -13.42      | AVG    |
| 1.386           | 31.68                | 9.75                | 41.43               | 56            | -14.57      | QP     |
| 1.386           | 27.73                | 9.75                | 37.48               | 46            | -8.52       | AVG    |
| 2.31            | 29.98                | 9.76                | 39.74               | 56            | -16.26      | QP     |
| 2.31            | 26.23                | 9.76                | 35.99               | 46            | -10.01      | AVG    |
| 3.238           | 29.87                | 9.78                | 39.65               | 56            | -16.35      | QP     |
| 3.238           | 20.47                | 9.78                | 30.25               | 46            | -15.75      | AVG    |

Remark:

1. All readings are Quasi-Peak and Average values.
2. Factor = Insertion Loss + Cable Loss.

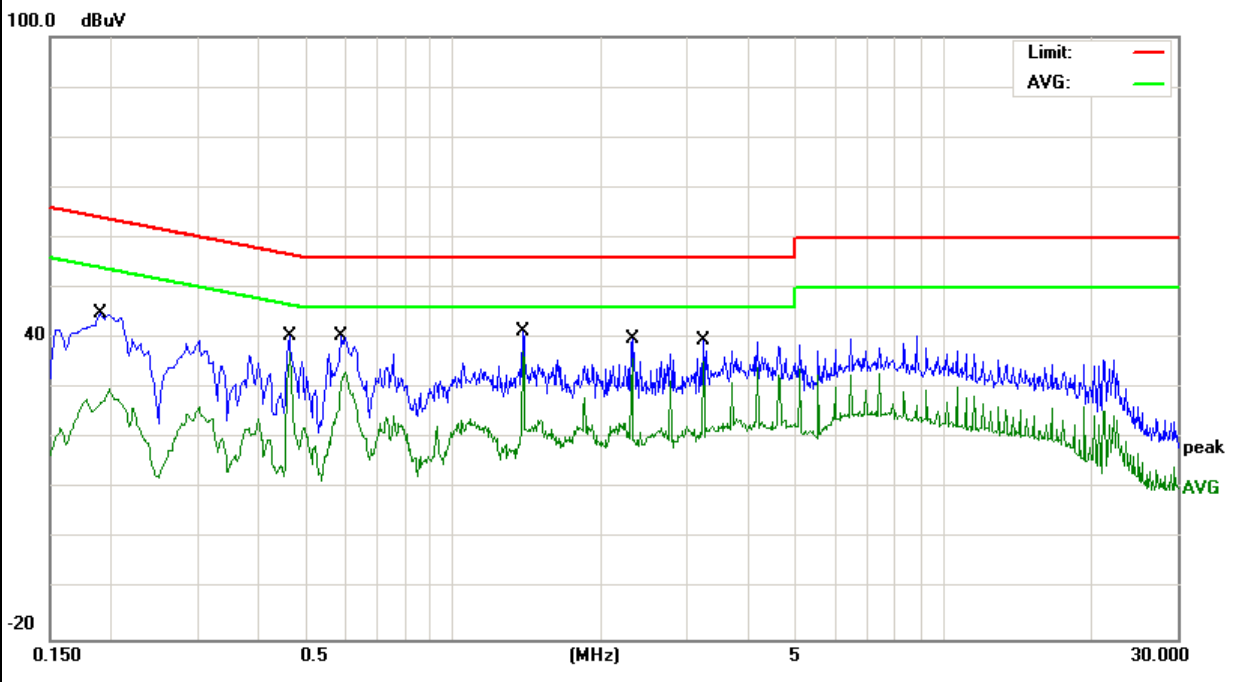



|                |   |                    |             |
|----------------|---|--------------------|-------------|
| EUT:           | Wi-Fi&Bluetooth Speaker with Amazon Alexa Voice Control | Model Name :       | NAS-5000    |
| Temperature:   | 26 °C   | Relative Humidity: | 54%         |
| Pressure:      | 1010hPa   | Phase :            | L           |
| Test Voltage : | DC 5V from USB Port AC 240V/60Hz                        | Test Mode:         | Normal Link |

| Frequency (MHz) | Reading Level (dBμV) | Correct Factor (dB) | Measure-ment (dBμV) | Limits (dBμV) | Margin (dB) | Remark |
|-----------------|----------------------|---------------------|---------------------|---------------|-------------|--------|
| 0.162           | 45.83                | 10.14               | 55.97               | 65.36         | -9.39       | QP     |
| 0.162           | 35.44                | 10.14               | 45.58               | 55.36         | -9.78       | AVG    |
| 0.1819          | 44.14                | 10.16               | 54.3                | 64.39         | -10.09      | QP     |
| 0.1819          | 33.96                | 10.16               | 44.12               | 54.39         | -10.27      | AVG    |
| 0.246           | 41.52                | 10.15               | 51.67               | 61.89         | -10.22      | QP     |
| 0.246           | 30.07                | 10.15               | 40.22               | 51.89         | -11.67      | AVG    |
| 0.458           | 37.86                | 9.88                | 47.74               | 56.73         | -8.99       | QP     |
| 0.458           | 30.84                | 9.88                | 40.72               | 46.73         | -6.01       | AVG    |
| 1.374           | 40.34                | 9.75                | 50.09               | 56            | -5.91       | QP     |
| 1.374           | 31.39                | 9.75                | 41.14               | 46            | -4.86       | AVG    |
| 2.294           | 40.08                | 9.76                | 49.84               | 56            | -6.16       | QP     |
| 2.294           | 30.84                | 9.76                | 40.6                | 46            | -5.4        | AVG    |

Remark:

1. All readings are Quasi-Peak and Average values.
2. Factor = Insertion Loss + Cable Loss.

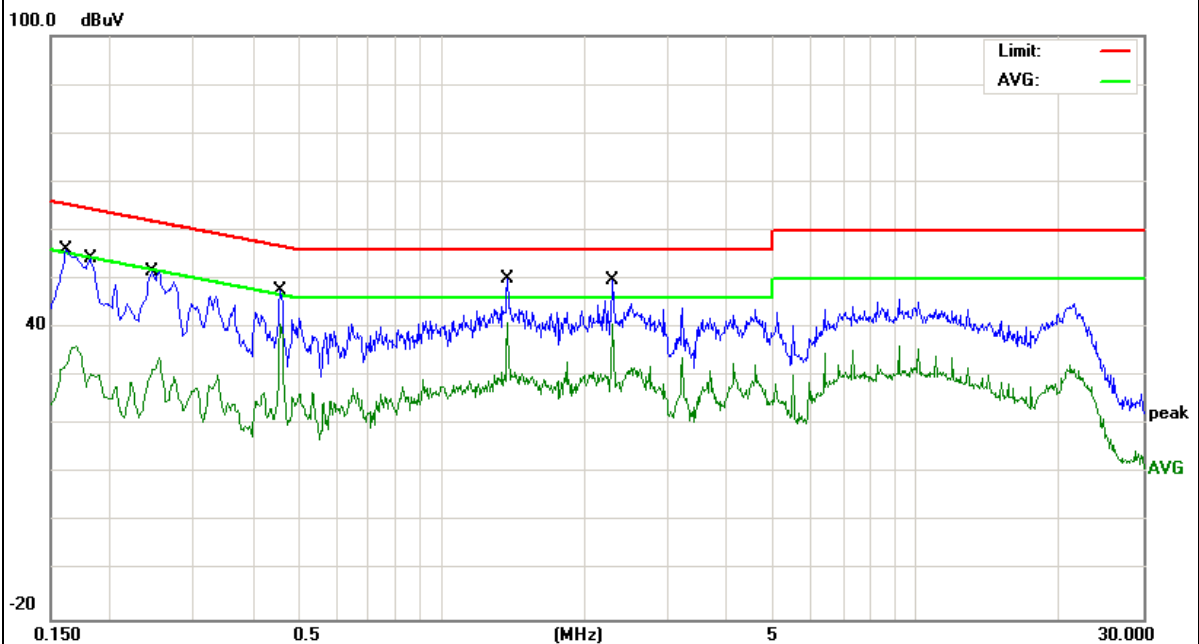

|                |   |                    |             |
|----------------|---|--------------------|-------------|
| EUT:           | Wi-Fi&Bluetooth Speaker with Amazon Alexa Voice Control | Model Name :       | NAS-5000    |
| Temperature:   | 26 °C   | Relative Humidity: | 54%         |
| Pressure:      | 1010hPa   | Phase :            | N           |
| Test Voltage : | DC 5V from USB Port AC 240V/60Hz                        | Test Mode:         | Normal Link |

| Frequency (MHz) | Reading Level (dBμV) | Correct Factor (dB) | Measure-ment (dBμV) | Limits (dBμV) | Margin (dB) | Remark |
|-----------------|----------------------|---------------------|---------------------|---------------|-------------|--------|
| 0.178           | 40.3                 | 10.1                | 50.4                | 64.57         | -14.17      | QP     |
| 0.178           | 30.02                | 10.1                | 40.12               | 54.57         | -14.45      | AVG    |
| 0.294           | 37.49                | 10.12               | 47.61               | 60.41         | -12.8       | QP     |
| 0.294           | 28.13                | 10.12               | 38.25               | 50.41         | -12.16      | AVG    |
| 0.358           | 35.03                | 10.01               | 45.04               | 58.77         | -13.73      | QP     |
| 0.358           | 27.35                | 10.01               | 37.36               | 48.77         | -11.41      | AVG    |
| 0.458           | 34.7                 | 9.89                | 44.59               | 56.73         | -12.14      | QP     |
| 0.458           | 25.13                | 9.89                | 35.02               | 46.73         | -11.71      | AVG    |
| 2.294           | 33.79                | 9.76                | 43.55               | 56            | -12.45      | QP     |
| 2.294           | 27.03                | 9.76                | 36.79               | 46            | -9.21       | AVG    |
| 4.0499          | 32.59                | 9.79                | 42.38               | 56            | -13.62      | QP     |
| 4.0499          | 20.66                | 9.79                | 30.45               | 46            | -15.55      | AVG    |

Remark:

1. All readings are Quasi-Peak and Average values.
2. Factor = Insertion Loss + Cable Loss.

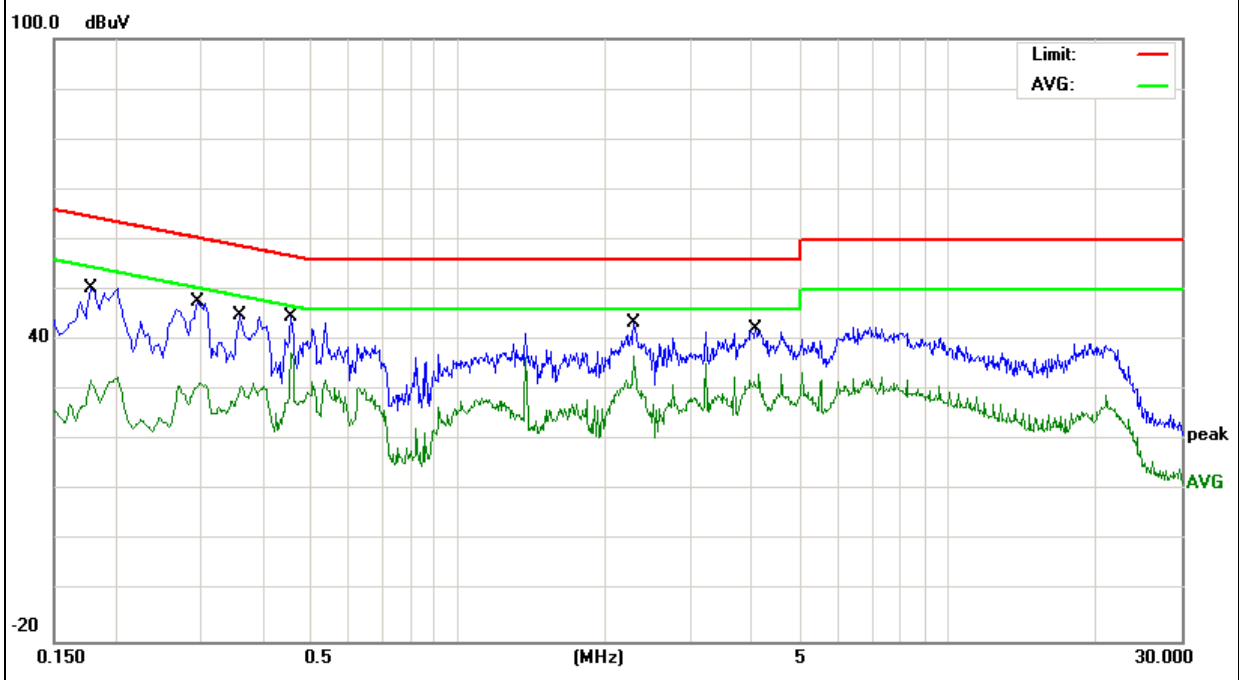

**7.2 RADIATED SPURIOUS EMISSION**

**7.2.1 Applicable Standard**

According to FCC Part 15.247(d) and 15.209 and ANSI C63.10-2013

**7.2.2 Conformance Limit**

According to FCC Part 15.247(d): radiated emissions which fall in the restricted bands, as defined in §15.205(a), must also comply with the radiated emission limits specified in §15.209(a) (see §15.205(c)).  
According to FCC Part 15.205, Restricted bands

| MHz               | MHz                 | MHz           | GHz         |
|-------------------|---------------------|---------------|-------------|
| 0.090-0.110       | 16.42-16.423        | 399.9-410     | 4.5-5.15    |
| 10.495-0.505      | 16.69475-16.69525   | 608-614       | 5.35-5.46   |
| 2.1735-2.1905     | 16.80425-16.80475   | 960-1240      | 7.25-7.75   |
| 4.125-4.128       | 25.5-25.67          | 1300-1427     | 8.025-8.5   |
| 4.17725-4.17775   | 37.5-38.25          | 1435-1626.5   | 9.0-9.2     |
| 4.20725-4.20775   | 73-74.6             | 1645.5-1646.5 | 9.3-9.5     |
| 6.215-6.218       | 74.8-75.2           | 1660-1710     | 10.6-12.7   |
| 6.26775-6.26825   | 123-138             | 2200-2300     | 14.47-14.5  |
| 8.291-8.294       | 149.9-150.05        | 2310-2390     | 15.35-16.2  |
| 8.362-8.366       | 156.52475-156.52525 | 2483.5-2500   | 17.7-21.4   |
| 8.37625-8.38675   | 156.7-156.9         | 2690-2900     | 22.01-23.12 |
| 8.41425-8.41475   | 162.0125-167.17     | 3260-3267     | 23.6-24.0   |
| 12.29-12.293      | 167.72-173.2        | 3332-3339     | 31.2-31.8   |
| 12.51975-12.52025 | 240-285             | 3345.8-3358   | 36.43-36.5  |
| 12.57675-12.57725 | 322-335.4           | 3600-4400     | (2)         |
| 13.36-13.41       |                     |               |             |

20dBc in any 100 kHz bandwidth outside the operating frequency band. In case the emission fall within the restricted band specified on 15.205(a), then the 15.209(a) limit in the table below has to be followed.

| Restricted Frequency(MHz) | Field Strength (µV/m) | Field Strength (dBµV/m) | Measurement Distance |
|---------------------------|-----------------------|-------------------------|----------------------|
| 0.009~0.490               | 2400/F(KHz)           | 20 log (uV/m)           | 300                  |
| 0.490~1.705               | 2400/F(KHz)           | 20 log (uV/m)           | 30                   |
| 1.705~30.0                | 30                    | 29.5                    | 30                   |
| 30-88                     | 100                   | 40                      | 3                    |
| 88-216                    | 150                   | 43.5                    | 3                    |
| 216-960                   | 200                   | 46                      | 3                    |
| Above 960                 | 500                   | 54                      | 3                    |

Limits of Radiated Emission Measurement(Above 1000MHz)

| Frequency(MHz) | Class B (dBuV/m) (at 3M) |         |
|----------------|--------------------------|---------|
|                | PEAK                     | AVERAGE |
| Above 1000     | 74                       | 54      |

- Remark :
1. Emission level in dBuV/m=20 log (uV/m)
  2. Measurement was performed at an antenna to the closed point of EUT distance of meters.
  3. Distance extrapolation factor =40log(Specific distance/ test distance)( dB);  
Limit line=Specific limits(dBuV) + distance extrapolation factor.

**7.2.3 Measuring Instruments**

The Measuring equipment is listed in the section 6.3 of this test report.

### 7.2.4 Test Configuration

(a) For radiated emissions below 30MHz

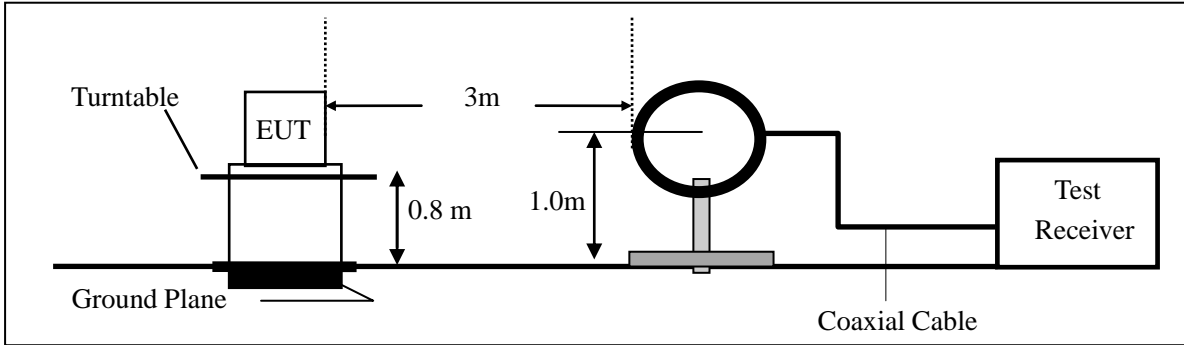

(b) For radiated emissions from 30MHz to 1000MHz

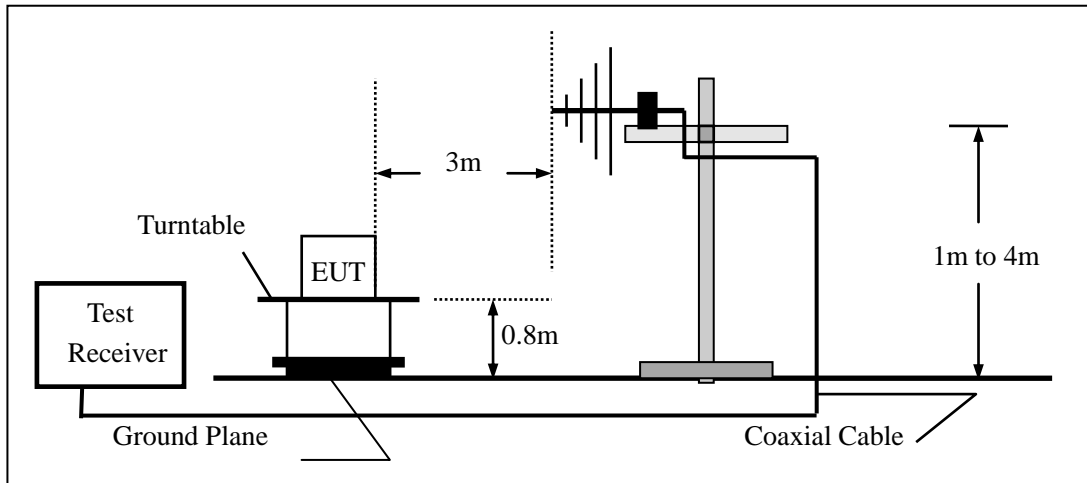

(c) For radiated emissions above 1000MHz

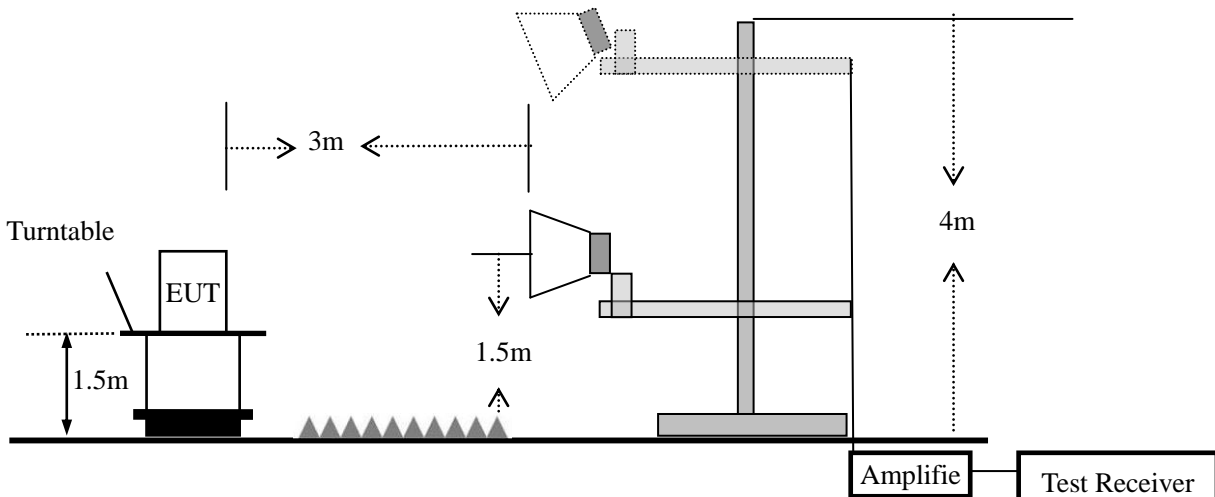

### 7.2.5 Test Procedure

The test site semi-anechoic chamber has met the requirement of NSA tolerance 4 dB according to the standards: ANSI C63.10-2013. The test distance is 3m. The setup is according to the requirements in Section 13.1.4.1 of ANSI C63.10-2013 and CAN/CSA-CEI/IEC CISPR 22.

This test is required for any spurious emission that falls in a Restricted Band, as defined in Section 15.205. It must be performed with the highest gain of each type of antenna proposed for use with the EUT.

Use the following spectrum analyzer settings:

| Spectrum Parameter                    | Setting  |
|---------------------------------------|--|
| Attenuation                           | Auto   |
| Start Frequency                       | 1000 MHz   |
| Stop Frequency                        | 10th carrier harmonic                            |
| RB / VB (emission in restricted band) | 1 MHz / 1 MHz for Peak, 1 MHz / 10Hz for Average |

| Receiver Parameter     | Setting                          |
|------------------------|----------------------------------|
| Attenuation            | Auto                             |
| Start ~ Stop Frequency | 9kHz~150kHz / RB 200Hz for QP    |
| Start ~ Stop Frequency | 150kHz~30MHz / RB 9kHz for QP    |
| Start ~ Stop Frequency | 30MHz~1000MHz / RB 120kHz for QP |

- a. The measuring distance of at 3 m shall be used for measurements at frequency up to 1GHz and frequencies above 1GHz,
- b. The EUT was placed on the top of a rotating table 0.8 m for below 1GHz and 1.5m for above 1GHz the ground at a 3 meter. The table was rotated 360 degrees to determine the position of the highest radiation.
- c. The height of the equipment or of the substitution antenna shall be 0.8 m for below 1GHz and 1.5m for above 1GHz; the height of the test antenna shall vary between 1 m to 4 m. Both horizontal and vertical polarizations of the antenna are set to make the measurement.
- d. For the radiated emission test above 1GHz:  
Place the measurement antenna away from each area of the EUT determined to be a source of emissions at the specified measurement distance, while keeping the measurement antenna aimed at the source of emissions at each frequency of significant emissions, with polarization oriented for maximum response. The measurement antenna may have to be higher or lower than the EUT, depending on the radiation pattern of the emission and staying aimed at the emission source for receiving the maximum signal. The final measurement antenna elevation shall be that which maximizes the emissions. The measurement antenna elevation for maximum emissions shall be restricted to a range of heights of from 1 m to 4 m above the ground or reference ground plane.
- e. The initial step in collecting conducted emission data is a spectrum analyzer peak detector mode pre-scanning the measurement frequency range. Significant peaks are then marked and then Quasi Peak detector mode re-measured.
- f. If the Peak Mode measured value compliance with and lower than Quasi Peak Mode Limit, the EUT shall be deemed to meet QP Limits and then no additional QP Mode measurement performed.
- g. For the actual test configuration, please refer to the related Item –EUT Test Photos.

Note:

Both horizontal and vertical antenna polarities were tested and performed pretest to three orthogonal axis. The worst case emissions were reported

During the radiated emission test, the Spectrum Analyzer was set with the following configurations:

For peak measurement:

Set RBW=100 kHz for  $f < 1$  GHz;  $VBW \geq RBW$ ; Sweep = auto; Detector function = peak; Trace = max hold;

Set RBW = 1 MHz, VBW= 3MHz for  $f \geq 1$  GHz

For average measurement:

VBW = 10 Hz, when duty cycle is no less than 98 percent.

$VBW \geq 1/T$ , when duty cycle is less than 98 percent where T is the minimum transmission duration over which the transmitter is on and is transmitting at its maximum power control level for the tested mode of operation.

Note: for the frequency ranges below 30 MHz, a narrower RBW is used for these ranges but the measured value should add a RBW correction factor (RBWCF) where  $RBWCF [dB] = 10 * \lg(100 [kHz] / \text{narrower RBW [kHz]})$ . , the narrower RBW is 1 kHz and RBWCF is 20 dB for the frequency 9 kHz to 150 kHz, and the narrower RBW is 10 kHz and RBWCF is 10 dB for the frequency 150 kHz to 30 MHz.

### 7.2.6 Test Results

■ Spurious Emission below 30MHz (9KHz to 30MHz)

|              |   |                    |           |
|--------------|---|--------------------|-----------|
| EUT:         | Wi-Fi&Bluetooth Speaker with Amazon Alexa Voice Control | Model No.:         | NAS-5000  |
| Temperature: | 20 °C   | Relative Humidity: | 48%       |
| Test Mode:   | 802.11b/g/n(HT20/ HT40)                                 | Test By:           | Allen Liu |

| Freq. (MHz) | Ant.Pol. H/V | Emission Level(dBuV/m) |    | Limit 3m(dBuV/m) |    | Over(dB) |    |
|-------------|--------------|------------------------|----|------------------|----|----------|----|
|             |              | PK                     | AV | PK               | AV | PK       | AV |
| --          | --           | --                     | -- | --               | -- | --       | -- |

Note: the amplitude of spurious emission that is attenuated by more than 20dB below the permissible limit has no need to be reported.

Distance extrapolation factor =  $20 \log(\text{Specific distance} / \text{test distance})$  ( dB);

Limit line = Specific limits(dBuV) + distance extrapolation factor

- Spurious Emission below 1GHz (30MHz to 1GHz)  
All the modulation modes have been tested, and the worst result was report as below:

|                |   |                    |             |
|----------------|---|--------------------|-------------|
| EUT:           | Wi-Fi&Bluetooth Speaker with Amazon Alexa Voice Control | Model Name :       | NAS-5000    |
| Temperature:   | 20 °C   | Relative Humidity: | 48%         |
| Pressure:      | 1010hPa   | Test Mode:         | Normal Link |
| Test Voltage : | DC 3.7V   |                    |             |

| Polar (H/V) | Frequency | Meter Reading | Factor | Emission Level | Limits   | Margin | Remark |
|-------------|-----------|---------------|--------|----------------|----------|--------|--------|
|             | (MHz)     | (dBuV)        | (dB)   | (dBuV/m)       | (dBuV/m) | (dB)   |        |
| V           | 35.4993   | 19.37         | 17     | 36.37          | 40       | -3.63  | QP     |
| V           | 43.8119   | 22.05         | 12.07  | 34.12          | 40       | -5.88  | QP     |
| V           | 114.1138  | 27.37         | 13.12  | 40.49          | 43.5     | -3.01  | QP     |
| V           | 121.5485  | 25.06         | 13.8   | 38.86          | 43.5     | -4.64  | QP     |
| V           | 375.9385  | 14.25         | 19.06  | 33.31          | 46       | -12.69 | QP     |
| V           | 588.9051  | 12.42         | 24.62  | 37.04          | 46       | -8.96  | QP     |

**Remark:**

Absolute Level= ReadingLevel+ Factor, Margin= Absolute Level - Limit

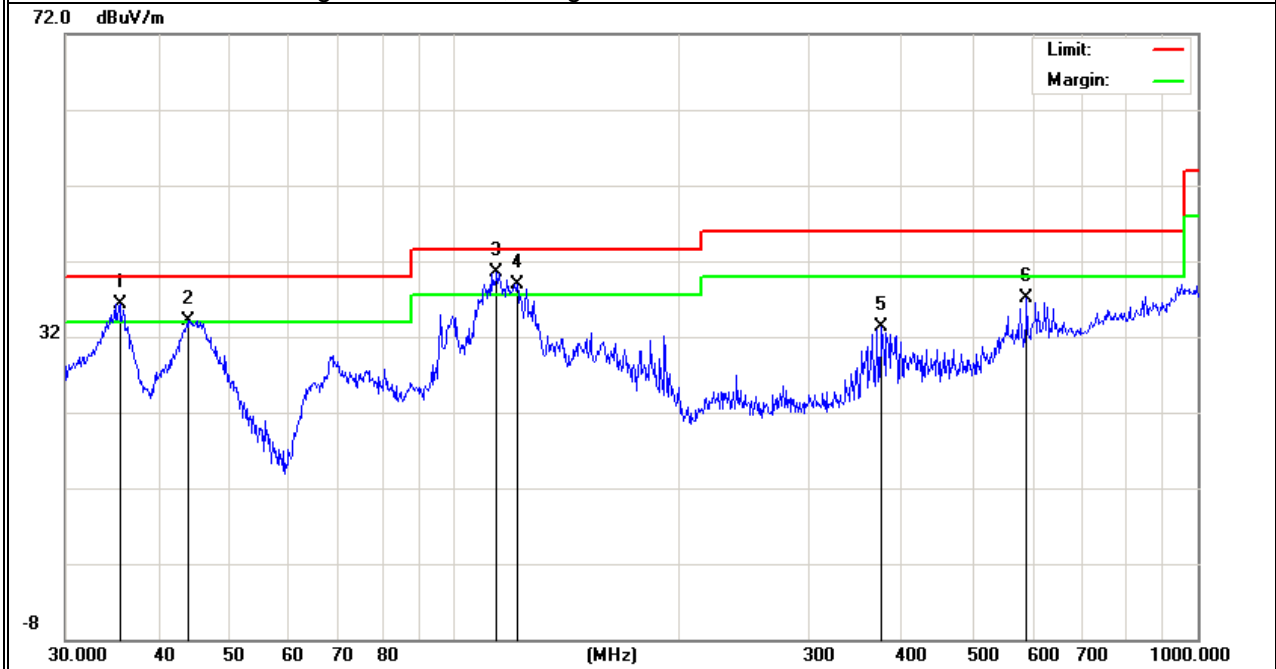

| Polar (H/V) | Frequency | Meter Reading | Factor | Emission Level | Limits   | Margin | Remark |
|-------------|-----------|---------------|--------|----------------|----------|--------|--------|
|             | (MHz)     | (dBuV)        | (dB)   | (dBuV/m)       | (dBuV/m) | (dB)   |        |
| H           | 78.6888   | 18.3          | 8.53   | 26.83          | 40       | -13.17 | QP     |
| H           | 110.9569  | 16.92         | 12.71  | 29.63          | 43.5     | -13.87 | QP     |
| H           | 121.1231  | 17.42         | 13.82  | 31.24          | 43.5     | -12.26 | QP     |
| H           | 178.1325  | 22.24         | 11.55  | 33.79          | 43.5     | -9.71  | QP     |
| H           | 191.745   | 24.09         | 10.46  | 34.55          | 43.5     | -8.95  | QP     |
| H           | 382.5879  | 18.58         | 19.38  | 37.96          | 46       | -8.04  | QP     |

**Remark:**

Absolute Level= ReadingLevel+ Factor, Margin= Absolute Level - Limit

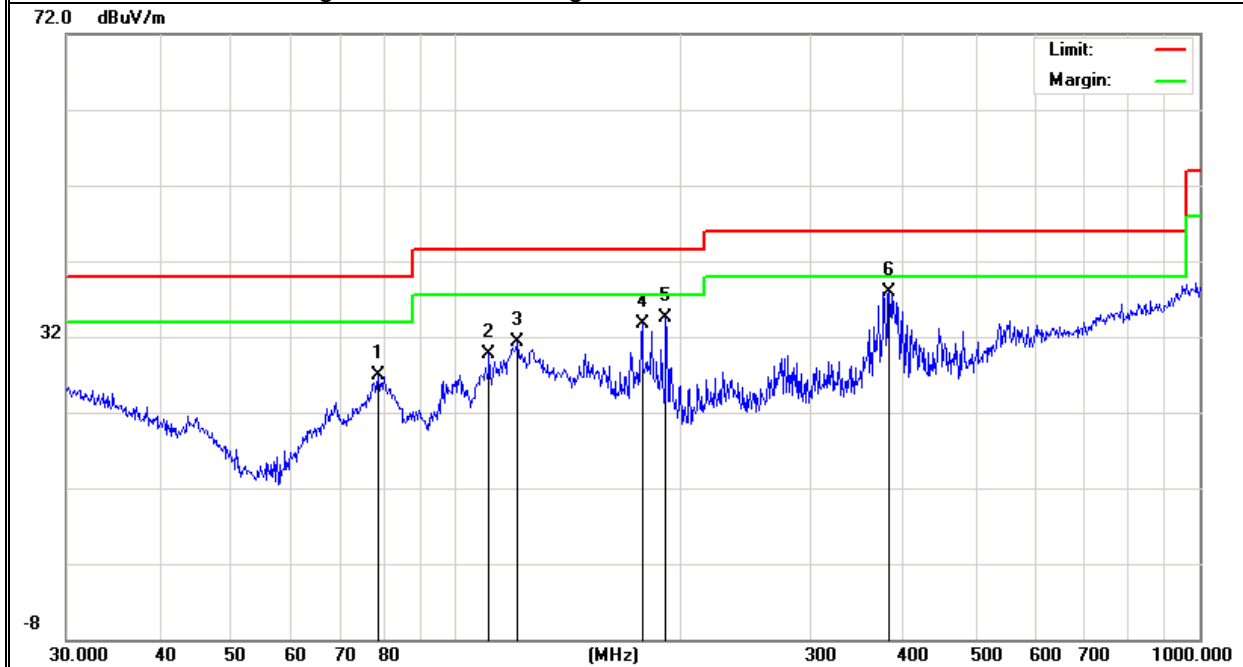



■ Spurious Emission Above 1GHz (1GHz to 27GHz)

|              |   |                    |           |
|--------------|---|--------------------|-----------|
| EUT:         | Wi-Fi&Bluetooth Speaker with Amazon Alexa Voice Control | Model No.:         | NAS-5000  |
| Temperature: | 20 °C   | Relative Humidity: | 48%       |
| Test Mode:   | 802.11b/g/n(HT20/ HT40)                                 | Test By:           | Allen Liu |

All the modulation modes have been tested, and the worst result was report as below:

| Frequency (MHz)                              | Read Level (dBμV) | Cable loss (dB) | Antenna Factor (dB/m) | Preamp Factor (dB) | Emission Level (dBμV/m) | Limits (dBμV/m) | Margin (dB) | Remark | Comment    |
|--|-------------------|-----------------|-----------------------|--------------------|-------------------------|-----------------|-------------|--------|------------|
| Low Channel (2412 MHz)(802.11b)--Above 1G    |                   |                 |                       |                    |                         |                 |             |        |            |
| 4824.113                                     | 65.12             | 5.21            | 35.59                 | 44.30              | 61.62                   | 74.00           | -12.38      | Pk     | Vertical   |
| 4824.113                                     | 43.32             | 5.21            | 35.59                 | 44.30              | 39.82                   | 54.00           | -14.18      | AV     | Vertical   |
| 7236.344                                     | 62.25             | 6.48            | 36.27                 | 44.60              | 60.40                   | 74.00           | -13.6       | Pk     | Vertical   |
| 7236.344                                     | 41.33             | 6.48            | 36.27                 | 44.60              | 39.48                   | 54.00           | -14.52      | AV     | Vertical   |
| 4824.056                                     | 61.59             | 5.21            | 35.55                 | 44.30              | 58.05                   | 74.00           | -15.95      | Pk     | Horizontal |
| 4824.056                                     | 43.22             | 5.21            | 35.55                 | 44.30              | 39.68                   | 54.00           | -14.32      | AV     | Horizontal |
| 7236.117                                     | 66.24             | 6.48            | 36.27                 | 44.52              | 64.47                   | 74.00           | -9.53       | Pk     | Horizontal |
| 7236.117                                     | 46.59             | 6.48            | 36.27                 | 44.52              | 44.82                   | 54.00           | -9.18       | AV     | Horizontal |
| Middle Channel (2437 MHz)(802.11b)--Above 1G |                   |                 |                       |                    |                         |                 |             |        |            |
| 4874.051                                     | 64.02             | 5.21            | 35.66                 | 44.20              | 60.69                   | 74.00           | -13.31      | Pk     | Vertical   |
| 4874.051                                     | 44.33             | 5.21            | 35.66                 | 44.20              | 41.00                   | 54.00           | -13.00      | AV     | Vertical   |
| 7311.644                                     | 62.58             | 7.10            | 36.50                 | 44.43              | 61.75                   | 74.00           | -12.25      | Pk     | Vertical   |
| 7311.644                                     | 51.47             | 7.10            | 36.50                 | 44.43              | 50.64                   | 54.00           | -3.36       | AV     | Vertical   |
| 4874.113                                     | 63.35             | 5.21            | 35.66                 | 44.20              | 60.02                   | 74.00           | -13.98      | Pk     | Horizontal |
| 4874.113                                     | 45.15             | 5.21            | 35.66                 | 44.20              | 41.82                   | 54.00           | -12.18      | AV     | Horizontal |
| 7311.216                                     | 64.02             | 7.10            | 36.50                 | 44.43              | 63.19                   | 74.00           | -10.81      | Pk     | Horizontal |
| 7311.216                                     | 42.15             | 7.10            | 36.50                 | 44.43              | 41.32                   | 54.00           | -12.68      | AV     | Horizontal |
| HIGH Channel (2462 MHz)(802.11b)--Above 1G   |                   |                 |                       |                    |                         |                 |             |        |            |
| 4924.055                                     | 63.44             | 5.21            | 35.52                 | 44.21              | 59.96                   | 74.00           | -14.04      | Pk     | Vertical   |
| 4924.055                                     | 41.22             | 5.21            | 35.52                 | 44.21              | 37.74                   | 54.00           | -16.26      | AV     | Vertical   |
| 7386.274                                     | 64.02             | 7.10            | 36.53                 | 44.60              | 63.05                   | 74.00           | -10.95      | Pk     | Vertical   |
| 7386.274                                     | 41.44             | 7.10            | 36.53                 | 44.60              | 40.47                   | 54.00           | -13.53      | AV     | Vertical   |
| 4924.115                                     | 65.33             | 5.21            | 35.52                 | 44.21              | 61.85                   | 74.00           | -12.15      | Pk     | Horizontal |
| 4924.115                                     | 43.22             | 5.21            | 35.52                 | 44.21              | 39.74                   | 54.00           | -14.26      | AV     | Horizontal |
| 7386.099                                     | 62.02             | 7.10            | 36.53                 | 44.60              | 61.05                   | 74.00           | -12.95      | Pk     | Horizontal |
| 7386.099                                     | 41.47             | 7.10            | 36.53                 | 44.60              | 40.50                   | 54.00           | -13.5       | AV     | Horizontal |

- Note:
- (1) All Readings are Peak Value (VBW=3MHz) and Peak Value (VBW=10Hz).
  - (2) Emission Level= Antenna Factor + Cable Loss + Read Level - Preamp Factor
  - (3) Data of measurement within this frequency range shown "--" in the table above means the reading of emissions are attenuated more than 20dB below the permissible limits or the field strength is too small to be measured.
  - (4)"802.11b" mode is the worst mode. When PK value is lower than the Average value limit, average don't record.

■ Spurious Emission in Restricted Band 2310MHz -18000MHz

All the modulation modes have been tested, and the worst result was report as below:

| Frequency (MHz) | Meter Reading (dBµV) | Cable Loss (dB) | Antenna Factor (dB/m) | Preamp Factor (dB) | Emission Level (dBµV/m) | Limits (dBµV/m) | Margin (dB) | Detector Type | Comment    |
|-----------------|----------------------|-----------------|-----------------------|--------------------|-------------------------|-----------------|-------------|---------------|------------|
| 802.11b         |                      |                 |                       |                    |                         |                 |             |               |            |
| 2310.00         | 61.58                | 2.97            | 27.80                 | 43.80              | 48.55                   | 74              | -25.45      | Pk            | Horizontal |
| 2310.00         | 41.33                | 2.97            | 27.80                 | 43.80              | 28.30                   | 54              | -25.7       | AV            | Horizontal |
| 2310.00         | 62.02                | 2.97            | 27.80                 | 43.80              | 48.99                   | 74              | -25.01      | Pk            | Vertical   |
| 2310.00         | 43.21                | 2.97            | 27.80                 | 43.80              | 30.18                   | 54              | -23.82      | AV            | Vertical   |
| 2390.00         | 59.55                | 3.14            | 27.21                 | 43.80              | 46.10                   | 74              | -27.9       | Pk            | Vertical   |
| 2390.00         | 42.17                | 3.14            | 27.21                 | 43.80              | 28.72                   | 54              | -25.28      | AV            | Vertical   |
| 2390.00         | 62.44                | 3.14            | 27.21                 | 43.80              | 48.99                   | 74              | -25.01      | Pk            | Horizontal |
| 2390.00         | 42.15                | 3.14            | 27.21                 | 43.80              | 28.70                   | 54              | -25.3       | AV            | Horizontal |
| 2483.50         | 60.31                | 3.58            | 27.70                 | 44.00              | 47.59                   | 74              | -26.41      | Pk            | Vertical   |
| 2483.50         | 41.22                | 3.58            | 27.70                 | 44.00              | 28.50                   | 54              | -25.5       | AV            | Vertical   |
| 2483.50         | 60.58                | 3.58            | 27.70                 | 44.00              | 47.86                   | 74              | -26.14      | Pk            | Horizontal |
| 2483.50         | 42.16                | 3.58            | 27.70                 | 44.00              | 29.44                   | 54              | -24.56      | AV            | Horizontal |
| 802.11g         |                      |                 |                       |                    |                         |                 |             |               |            |
| 2310.00         | 62.22                | 2.97            | 27.80                 | 43.80              | 49.19                   | 74              | -24.81      | Pk            | Horizontal |
| 2310.00         | 41.36                | 2.97            | 27.80                 | 43.80              | 28.33                   | 54              | -25.67      | AV            | Horizontal |
| 2310.00         | 61.33                | 2.97            | 27.80                 | 43.80              | 48.30                   | 74              | -25.7       | Pk            | Vertical   |
| 2310.00         | 43.25                | 2.97            | 27.80                 | 43.80              | 30.22                   | 54              | -23.78      | AV            | Vertical   |
| 2390.00         | 62.58                | 3.14            | 27.21                 | 43.80              | 49.13                   | 74              | -24.87      | Pk            | Vertical   |
| 2390.00         | 41.44                | 3.14            | 27.21                 | 43.80              | 27.99                   | 54              | -26.01      | AV            | Vertical   |
| 2390.00         | 59.66                | 3.14            | 27.21                 | 43.80              | 46.21                   | 74              | -27.79      | Pk            | Horizontal |
| 2390.00         | 41.25                | 3.14            | 27.21                 | 43.80              | 27.80                   | 54              | -26.2       | AV            | Horizontal |
| 2483.50         | 60.44                | 3.58            | 27.70                 | 44.00              | 47.72                   | 74              | -26.28      | Pk            | Vertical   |
| 2483.50         | 43.11                | 3.58            | 27.70                 | 44.00              | 30.39                   | 54              | -23.61      | AV            | Vertical   |
| 2483.50         | 62.15                | 3.58            | 27.70                 | 44.00              | 49.43                   | 74              | -24.57      | Pk            | Horizontal |
| 2483.50         | 41.55                | 3.58            | 27.70                 | 44.00              | 28.83                   | 54              | -25.17      | AV            | Horizontal |
| 802.11n20       |                      |                 |                       |                    |                         |                 |             |               |            |
| 2310.00         | 59.58                | 2.97            | 27.80                 | 43.80              | 46.55                   | 74              | -27.45      | Pk            | Horizontal |
| 2310.00         | 40.55                | 2.97            | 27.80                 | 43.80              | 27.52                   | 54              | -26.48      | AV            | Horizontal |
| 2310.00         | 62.49                | 2.97            | 27.80                 | 43.80              | 49.46                   | 74              | -24.54      | Pk            | Vertical   |
| 2310.00         | 43.74                | 2.97            | 27.80                 | 43.80              | 30.71                   | 54              | -23.29      | AV            | Vertical   |
| 2390.00         | 62.52                | 3.14            | 27.21                 | 43.80              | 49.07                   | 74              | -24.93      | Pk            | Vertical   |
| 2390.00         | 46.44                | 3.14            | 27.21                 | 43.80              | 32.99                   | 54              | -21.01      | AV            | Vertical   |
| 2390.00         | 63.80                | 3.14            | 27.21                 | 43.80              | 50.35                   | 74              | -23.65      | Pk            | Horizontal |
| 2390.00         | 45.11                | 3.14            | 27.21                 | 43.80              | 31.66                   | 54              | -22.34      | AV            | Horizontal |
| 2483.50         | 64.15                | 3.58            | 27.70                 | 44.00              | 51.43                   | 74              | -22.57      | Pk            | Vertical   |
| 2483.50         | 43.74                | 3.58            | 27.70                 | 44.00              | 31.02                   | 54              | -22.98      | AV            | Vertical   |
| 2483.50         | 58.22                | 3.58            | 27.70                 | 44.00              | 45.50                   | 74              | -28.5       | Pk            | Horizontal |
| 2483.50         | 47.15                | 3.58            | 27.70                 | 44.00              | 34.43                   | 54              | -19.57      | AV            | Horizontal |
| 802.11n40       |                      |                 |                       |                    |                         |                 |             |               |            |
| 2310.00         | 62.55                | 2.97            | 27.80                 | 43.80              | 49.52                   | 74              | -24.48      | Pk            | Horizontal |
| 2310.00         | 39.33                | 2.97            | 27.80                 | 43.80              | 26.30                   | 54              | -27.7       | AV            | Horizontal |
| 2310.00         | 62.58                | 2.97            | 27.80                 | 43.80              | 49.55                   | 74              | -24.45      | Pk            | Vertical   |
| 2310.00         | 43.89                | 2.97            | 27.80                 | 43.80              | 30.86                   | 54              | -23.14      | AV            | Vertical   |
| 2390.00         | 61.98                | 3.14            | 27.21                 | 43.80              | 48.53                   | 74              | -25.47      | Pk            | Vertical   |
| 2390.00         | 42.33                | 3.14            | 27.21                 | 43.80              | 28.88                   | 54              | -25.12      | AV            | Vertical   |
| 2390.00         | 61.41                | 3.14            | 27.21                 | 43.80              | 47.96                   | 74              | -26.04      | Pk            | Horizontal |
| 2390.00         | 42.05                | 3.14            | 27.21                 | 43.80              | 28.60                   | 54              | -25.4       | AV            | Horizontal |
| 2483.50         | 62.11                | 3.58            | 27.70                 | 44.00              | 49.39                   | 74              | -24.61      | Pk            | Vertical   |
| 2483.50         | 41.55                | 3.58            | 27.70                 | 44.00              | 28.83                   | 54              | -25.17      | AV            | Vertical   |
| 2483.50         | 62.04                | 3.58            | 27.70                 | 44.00              | 49.32                   | 74              | -24.68      | Pk            | Horizontal |
| 2483.50         | 40.44                | 3.58            | 27.70                 | 44.00              | 27.72                   | 54              | -26.28      | AV            | Horizontal |

Spurious Emission in Restricted Bands 3260MMHz- 18000MHz

All the modulation modes have been tested, the worst result was report as below:

| Frequency<br>(MHz) | Reading Level<br>(dB $\mu$ V) | Cable Loss<br>(dB) | Antenna Factor<br>dB/m | Preamp Factor<br>(dB) | Emission Level<br>(dB $\mu$ V/m) | Limits<br>(dB $\mu$ V/m) | Margin<br>(dB) | Detector<br>Type | Comment    |
|--------------------|-------------------------------|--------------------|------------------------|-----------------------|----------------------------------|--------------------------|----------------|------------------|------------|
| 3260               | 60.36                         | 4.04               | 29.57                  | 44.70                 | 49.27                            | 74                       | -24.73         | Pk               | Vertical   |
| 3260               | 50.25                         | 4.04               | 29.57                  | 44.70                 | 39.16                            | 54                       | -14.84         | AV               | Vertical   |
| 3260               | 61.25                         | 4.04               | 29.57                  | 44.70                 | 50.16                            | 74                       | -23.84         | Pk               | Horizontal |
| 3260               | 52.33                         | 4.04               | 29.57                  | 44.70                 | 41.24                            | 54                       | -12.76         | AV               | Horizontal |
| 3332               | 63.11                         | 4.26               | 29.87                  | 44.40                 | 52.84                            | 74                       | -21.16         | Pk               | Vertical   |
| 3332               | 49.21                         | 4.26               | 29.87                  | 44.40                 | 38.94                            | 54                       | -15.06         | AV               | Vertical   |
| 3332               | 62.58                         | 4.26               | 29.87                  | 44.40                 | 52.31                            | 74                       | -21.69         | Pk               | Horizontal |
| 3332               | 50.11                         | 4.26               | 29.87                  | 44.40                 | 39.84                            | 54                       | -14.16         | AV               | Horizontal |
| 17797              | 43.54                         | 10.99              | 43.95                  | 43.50                 | 54.98                            | 74                       | -19.02         | Pk               | Vertical   |
| 17797              | 30.22                         | 10.99              | 43.95                  | 43.50                 | 41.66                            | 54                       | -12.34         | AV               | Vertical   |
| 17788              | 41.25                         | 11.81              | 43.69                  | 44.60                 | 52.15                            | 74                       | -21.85         | Pk               | Horizontal |
| 17788              | 33.02                         | 11.81              | 43.69                  | 44.60                 | 43.92                            | 54                       | -10.08         | AV               | Horizontal |

"802.11b" mode is the worst mode. When PK value is lower than the Average value limit, average don't record.

### **7.3 6DB BANDWIDTH**

#### **7.3.1 Applicable Standard**

According to FCC Part 15.247(a)(2) and KDB 558074 DTS 01 Meas. Guidance v03r05

#### **7.3.2 Conformance Limit**

The minimum permissible 6dB bandwidth is 500 kHz.

#### **7.3.3 Measuring Instruments**

The Measuring equipment is listed in the section 6.3 of this test report.

#### **7.3.4 Test Setup**

Please refer to Section 6.1 of this test report.

#### **7.3.5 Test Procedure**

The testing follows KDB 558074 DTS 01 Meas. Guidance v03r05

The RF output of EUT was connected to the spectrum analyzer by RF cable and attenuator.

The path loss was compensated to the results for each measurement.

Set to the maximum power setting and enable the EUT transmit continuously.

The EUT was operating in controlled its channel.

Use the following spectrum analyzer settings:

Span = the frequency band of operation

RBW = 100KHz

VBW  $\geq$  3\*RBW

Sweep = auto

Detector function = peak

Trace = max hold

**7.3.6 Test Results**

|              |   |                    |           |
|--------------|---|--------------------|-----------|
| EUT:         | Wi-Fi&Bluetooth Speaker with Amazon Alexa Voice Control | Model No.:         | NAS-5000  |
| Temperature: | 20 °C   | Relative Humidity: | 48%       |
| Test Mode:   | 802.11b/g/n20/n40                                       | Test By:           | Allen Liu |

| Mode      | Channel | Frequency (MHz) | 6dB bandwidth | Limit (kHz) | Result |
|-----------|---------|-----------------|---------------|-------------|--------|
|           |         |                 | (MHz)         |             |        |
| 802.11b   | Low     | 2412            | 10.099        | 500         | Pass   |
|           | Middle  | 2437            | 10.083        | 500         | Pass   |
|           | High    | 2462            | 9.132         | 500         | Pass   |
| 802.11g   | Low     | 2412            | 15.053        | 500         | Pass   |
|           | Middle  | 2437            | 15.155        | 500         | Pass   |
|           | High    | 2462            | 15.145        | 500         | Pass   |
| 802.11n20 | Low     | 2412            | 15.158        | 500         | Pass   |
|           | Middle  | 2437            | 15.156        | 500         | Pass   |
|           | High    | 2462            | 15.150        | 500         | Pass   |
| 802.11n40 | Low     | 2422            | 35.139        | 500         | Pass   |
|           | Middle  | 2437            | 35.127        | 500         | Pass   |
|           | High    | 2452            | 35.120        | 500         | Pass   |

### Test plot

(802.11b) 6dB Bandwidth plot on channel 1

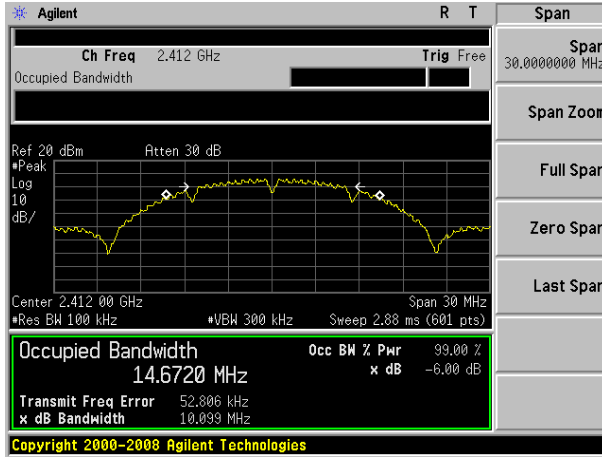

(802.11g) 6dB Bandwidth plot on channel 1

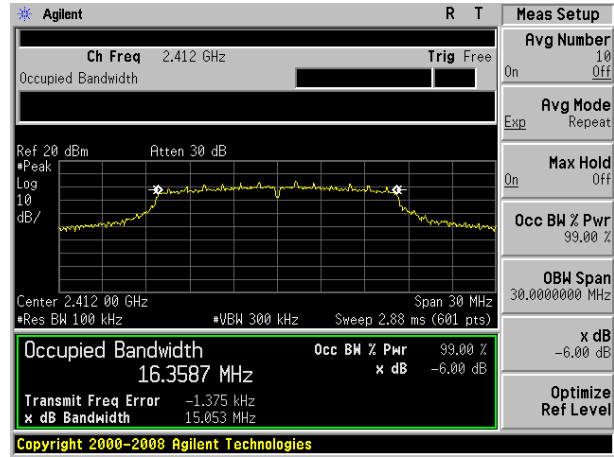

(802.11b) 6dB Bandwidth plot on channel 6

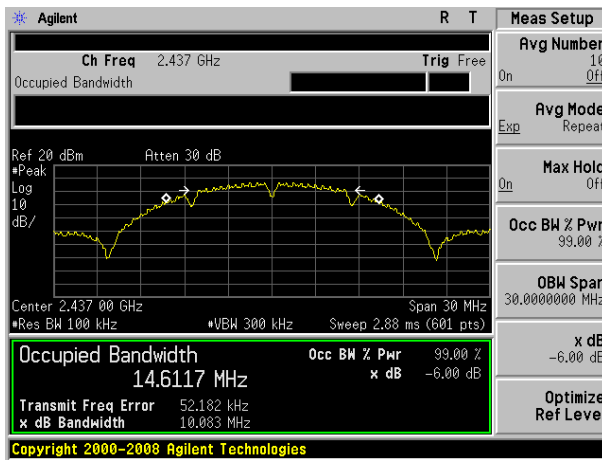

(802.11g) 6dB Bandwidth plot on channel 6

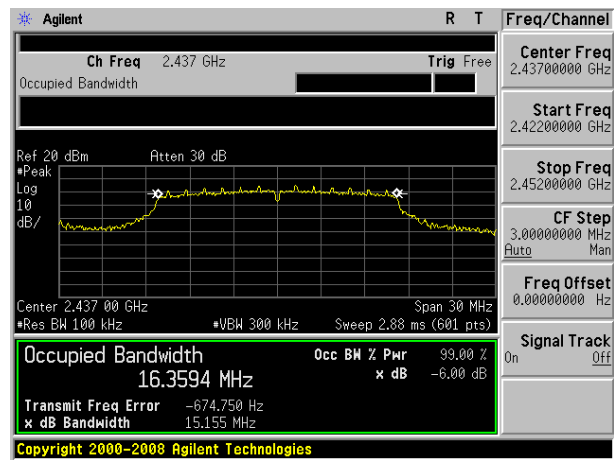

(802.11b) 6dB Bandwidth plot on channel 11

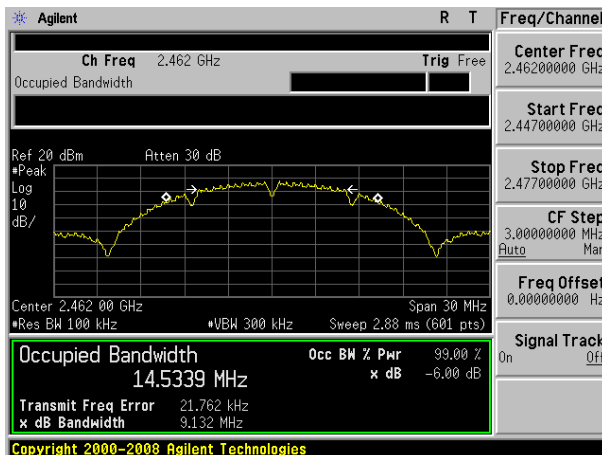

(802.11g) 6dB Bandwidth plot on channel 11

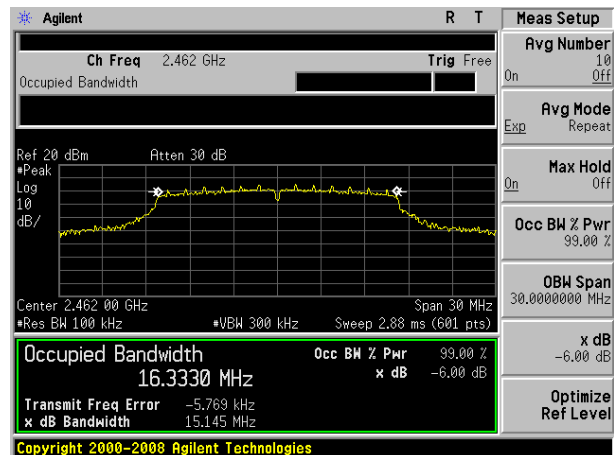

### Test plot

(802.11n20) 6dB Bandwidth plot on channel 1

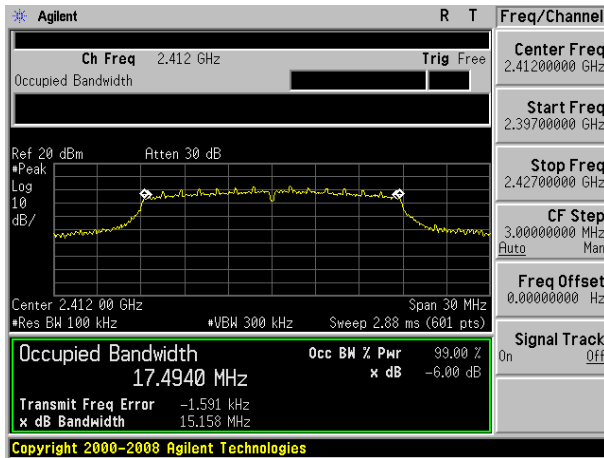

(802.11n40) 6dB Bandwidth plot on channel 3

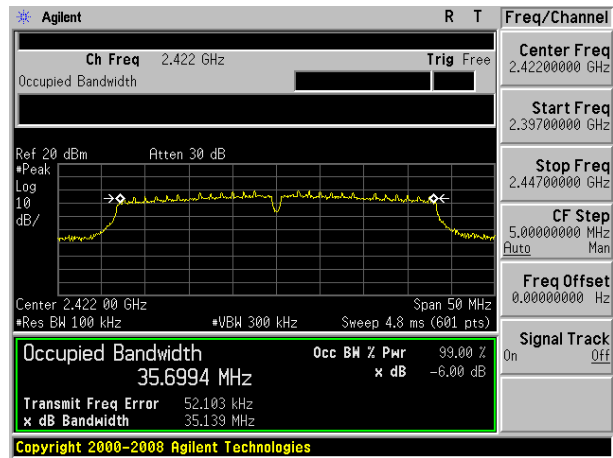

(802.11n20) 6dB Bandwidth plot on channel 6

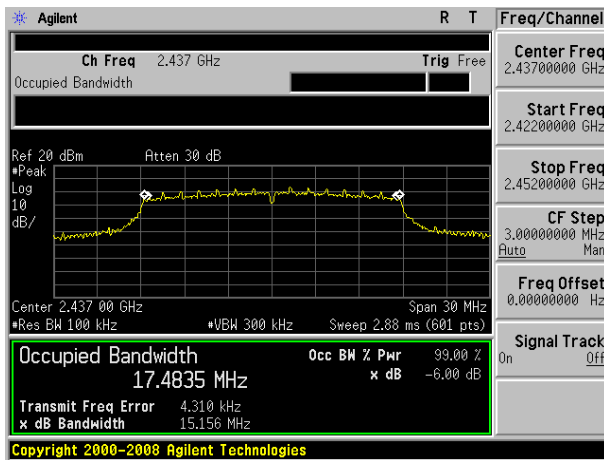

(802.11n40) 6dB Bandwidth plot on channel 6

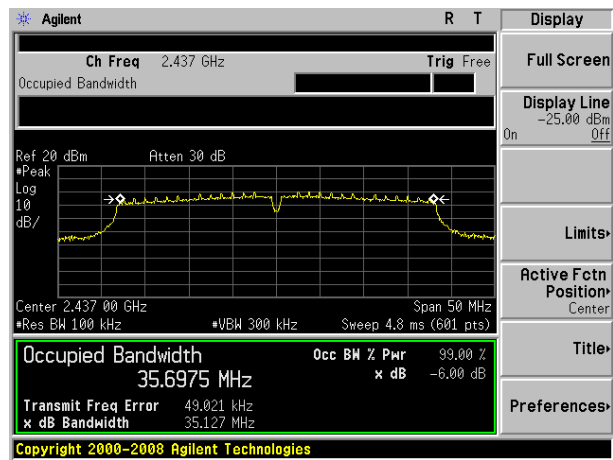

(802.11n20) 6dB Bandwidth plot on channel 11

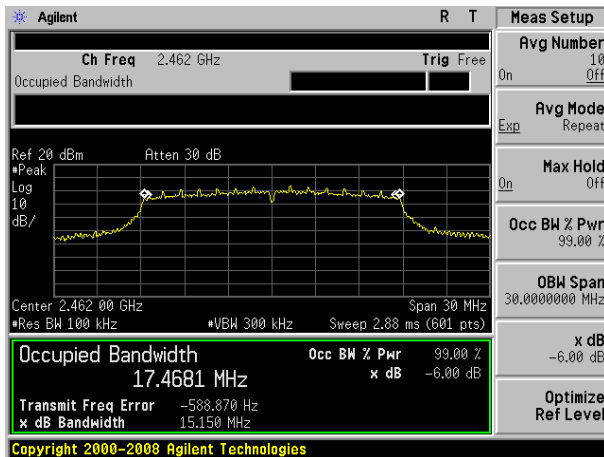

(802.11n40) 6dB Bandwidth plot on channel 9

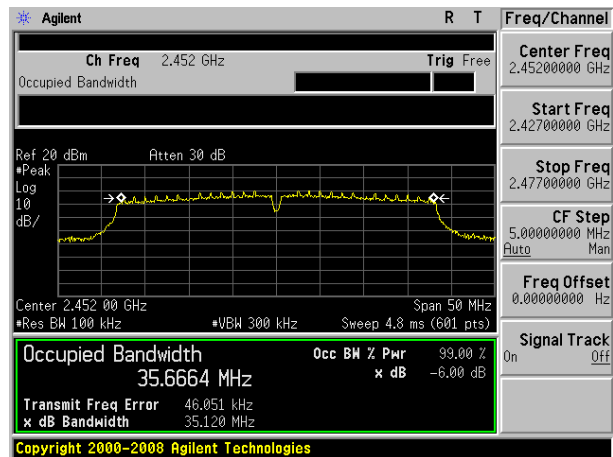

## **7.4 20DB BANDWIDTH**

### **7.4.1 Applicable Standard**

According to FCC Part 15.247(a)(2) and KDB 558074 DTS 01 Meas. Guidance v03r05

### **7.4.2 Conformance Limit**

No limit requirement.

### **7.4.3 Measuring Instruments**

The Measuring equipment is listed in the section 6.3 of this test report.

### **7.4.4 Test Setup**

Please refer to Section 6.1 of this test report.

### **7.4.5 Test Procedure**

The testing follows KDB 558074 DTS 01 Meas. Guidance v03r05

The RF output of EUT was connected to the spectrum analyzer by RF cable and attenuator.

The path loss was compensated to the results for each measurement.

Set to the maximum power setting and enable the EUT transmit continuously.

The EUT was operating in controlled its channel.

Use the following spectrum analyzer settings:

Span = the frequency band of operation

RBW = 100KHz

VBW  $\geq$  3\*RBW

Sweep = auto

Detector function = peak

Trace = max hold



**7.4.6 Test Results**

|              |   |                    |           |
|--------------|---|--------------------|-----------|
| EUT:         | Wi-Fi&Bluetooth Speaker with Amazon Alexa Voice Control | Model No.:         | NAS-5000  |
| Temperature: | 20 °C   | Relative Humidity: | 48%       |
| Test Mode:   | 802.11b/g/n20/n40                                       | Test By:           | Allen Liu |

All the bands and channels were tested, the data of the worst mode are described in the following table

| Mode      | Channel | Frequency (MHz) | -20dB bandwidth | Limit (kHz) | Result |
|-----------|---------|-----------------|-----------------|-------------|--------|
|           |         |                 | (MHz)           |             |        |
| 802.11b   | Low     | 2412            | 17.09           | 500         | Pass   |
|           | Middle  | 2437            | 17.05           | 500         | Pass   |
|           | High    | 2462            | 16.66           | 500         | Pass   |
| 802.11g   | Low     | 2412            | 17.50           | 500         | Pass   |
|           | Middle  | 2437            | 17.48           | 500         | Pass   |
|           | High    | 2462            | 17.48           | 500         | Pass   |
| 802.11n20 | Low     | 2412            | 18.35           | 500         | Pass   |
|           | Middle  | 2437            | 18.34           | 500         | Pass   |
|           | High    | 2462            | 18.36           | 500         | Pass   |
| 802.11n40 | Low     | 2422            | 37.15           | 500         | Pass   |
|           | Middle  | 2437            | 37.08           | 500         | Pass   |
|           | High    | 2452            | 37.11           | 500         | Pass   |

### Test plot

(802.11b) -20dB Bandwidth plot on channel 1

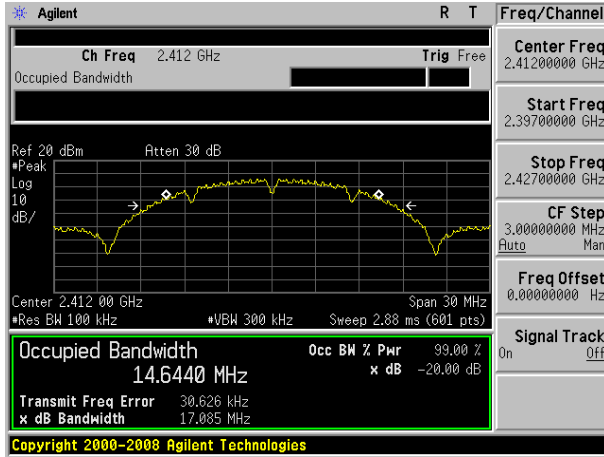

(802.11g) -20dB Bandwidth plot on channel 1

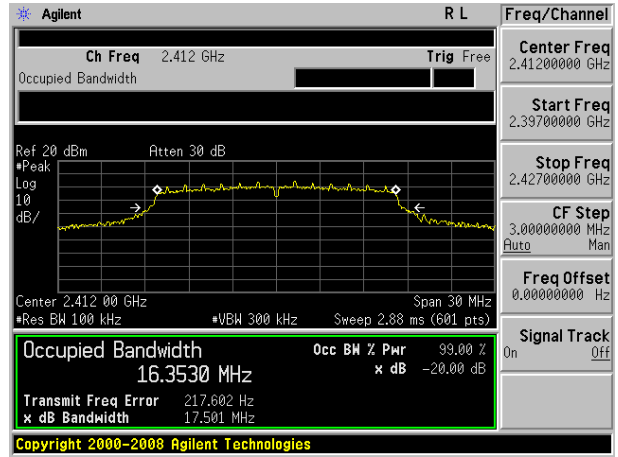

(802.11b) -20dB Bandwidth plot on channel 6

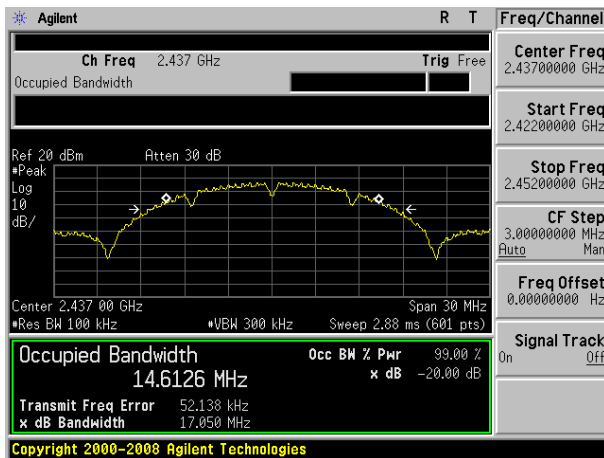

(802.11g) -20dB Bandwidth plot on channel 6

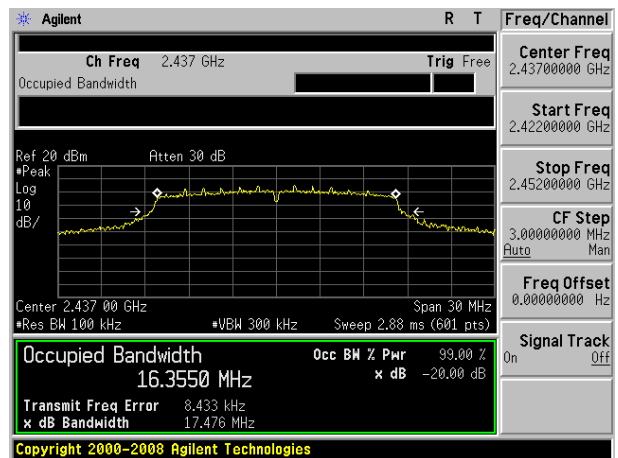

(802.11b) -20dB Bandwidth plot on channel 11

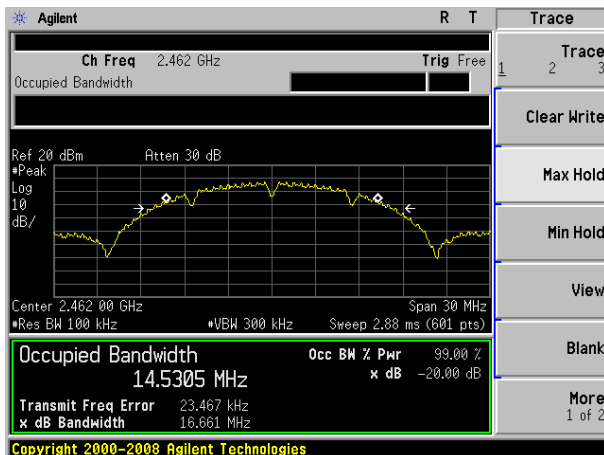

(802.11g) -20dB Bandwidth plot on channel 11

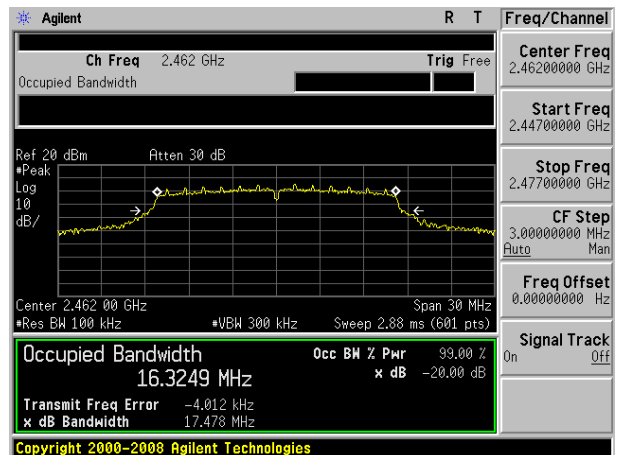

### Test plot

(802.11n20) -20dB Bandwidth plot on channel 1

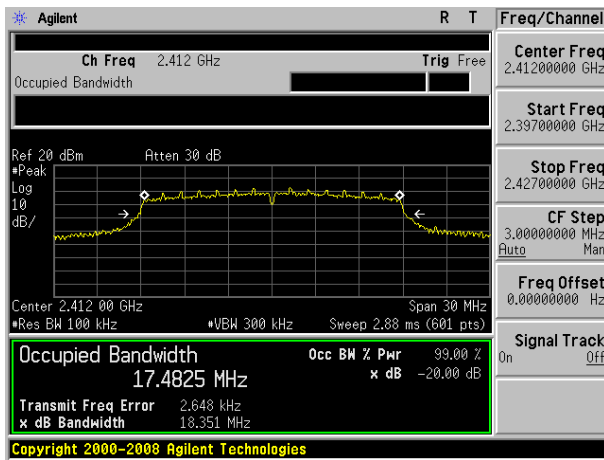

(802.11n40) -20dB Bandwidth plot on channel 3

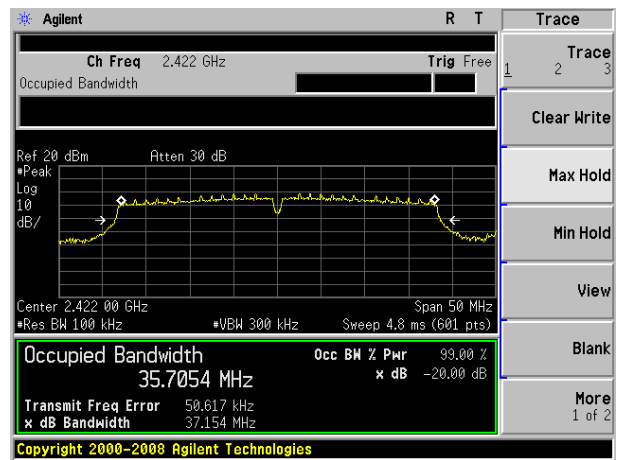

(802.11n20) -20dB Bandwidth plot on channel 6

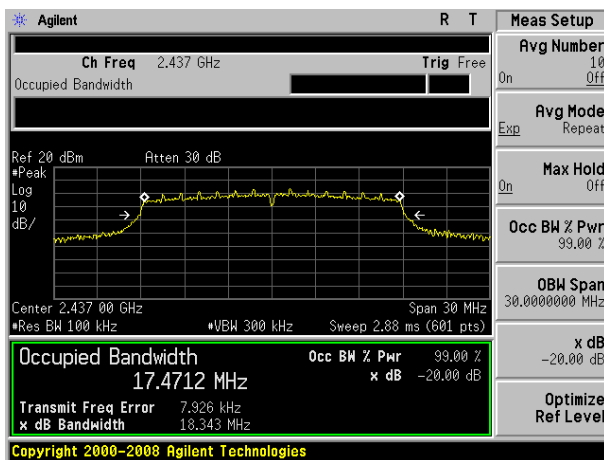

(802.11n40) -20dB Bandwidth plot on channel 6

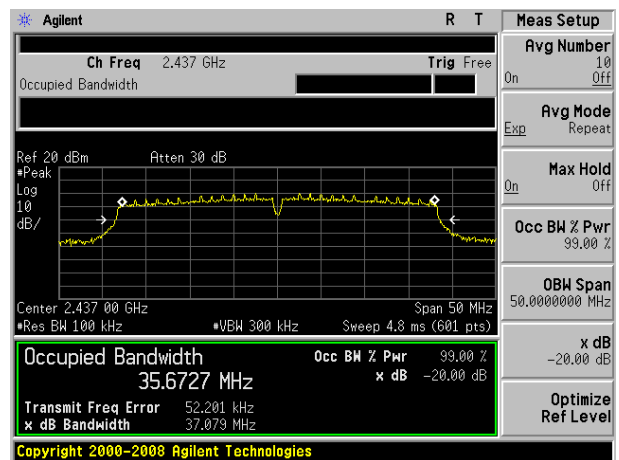

(802.11n20) -20dB Bandwidth plot on channel 11

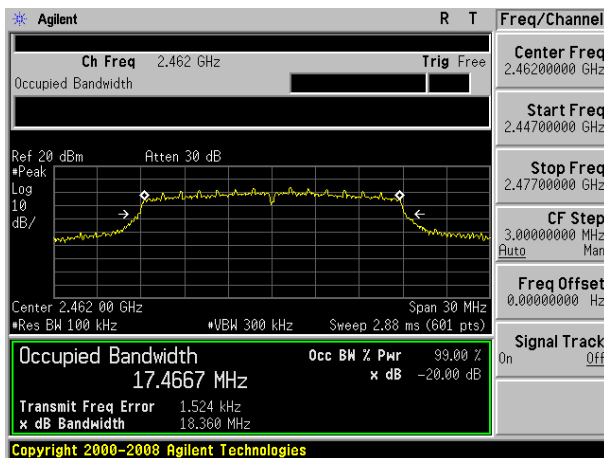

(802.11n40) -20dB Bandwidth plot on channel 9

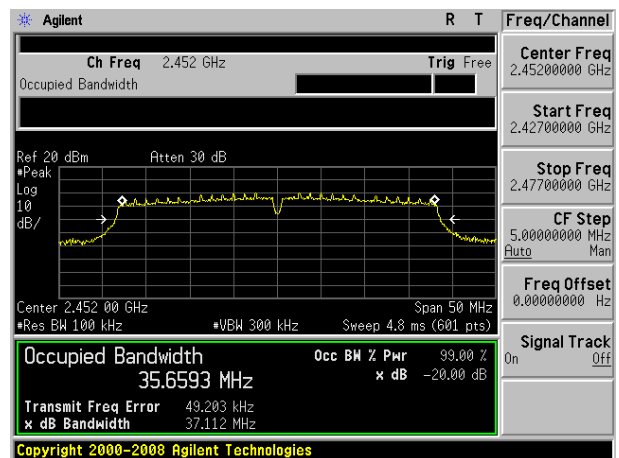

## 7.5 DUTY CYCLE

### 7.5.1 Applicable Standard

According to KDB 558074)6)b), issued 06/09/2015

### 7.5.2 Conformance Limit

No limit requirement.

### 7.5.3 Measuring Instruments

The Measuring equipment is listed in the section 6.3 of this test report.

### 7.5.4 Test Setup

Please refer to Section 6.1 of this test report.

### 7.5.5 Test Procedure

The zero-span mode on a spectrum analyzer or EMI receiver if the response time and spacing between bins on the sweep are sufficient to permit accurate measurements of the on and off times of the transmitted signal. Set the center frequency of the instrument to the center frequency of the transmission. Set  $RBW \geq OBW$  if possible; otherwise, set RBW to the largest available value. Set  $VBW \geq RBW$ . Set detector = peak or average. The zero-span measurement method shall not be used unless both RBW and VBW are  $> 50/T$  and the number of sweep points across duration T exceeds 100. (For example, if VBW and/or RBW are limited to 3 MHz, then the zero-span method of measuring duty cycle shall not be used if  $T \leq 16.7$  microseconds.)

The transmitter output is connected to the Spectrum Analyzer. We tested according to the zero-span measurement method, 6.0)b) in KDB 558074(issued 06/09/2015)

The largest available value of RBW is 8 MHz and VBW is 50 MHz. The zero-span method of measuring duty cycle shall not be used if  $T \leq 6.25$  microseconds. ( $50/6.25 = 8$ )

The zero-span method was used because all measured T data are  $> 6.25$  microseconds and both RBW and VBW are  $> 50/T$ .

The RF output of EUT was connected to the spectrum analyzer by RF cable and attenuator.

The path loss was compensated to the results for each measurement.

Set to the maximum power setting and enable the EUT transmit continuously.

The EUT was operating in controlled its channel.

Use the following spectrum analyzer settings:

Span = Zero Span

RBW = 8MHz(the largest available value)

VBW = 8MHz ( $\geq$  RBW)

Number of points in Sweep  $> 100$

Detector function = peak

Trace = Clear write

Measure  $T_{total}$  and  $T_{on}$

Calculate Duty Cycle =  $T_{on} / T_{total}$

### 7.5.6 Test Results

|              |   |                    |           |
|--------------|---|--------------------|-----------|
| EUT:         | Wi-Fi&Bluetooth Speaker with Amazon Alexa Voice Control | Model No.:         | NAS-5000  |
| Temperature: | 20 °C   | Relative Humidity: | 48%       |
| Test Mode:   | 802.11b/g/n20/n40                                       | Test By:           | Allen Liu |

| Mode         | Data rate | Channel | T <sub>on</sub> | T <sub>total</sub> | Duty Cycle | Duty Cycle Factor (dB) | VBW Setting |
|--------------|-----------|---------|-----------------|--------------------|------------|------------------------|-------------|
| 802.11b      | 1Mbps     | 6       | -               | -                  | 100%       | 0                      | 10Hz        |
| 802.11g      | 6Mbps     | 6       | -               | -                  | 100%       | 0                      | 1KHz        |
| 802.11n HT20 | MCS0      | 6       | -               | -                  | 100%       | 0                      | 1KHz        |
| 802.11n HT40 | MCS0      | 6       | -               | -                  | 100%       | 0                      | 1KHz        |

Note: All the modulation modes were tested, the data of the worst mode are described in the following table.

#### 802.11b

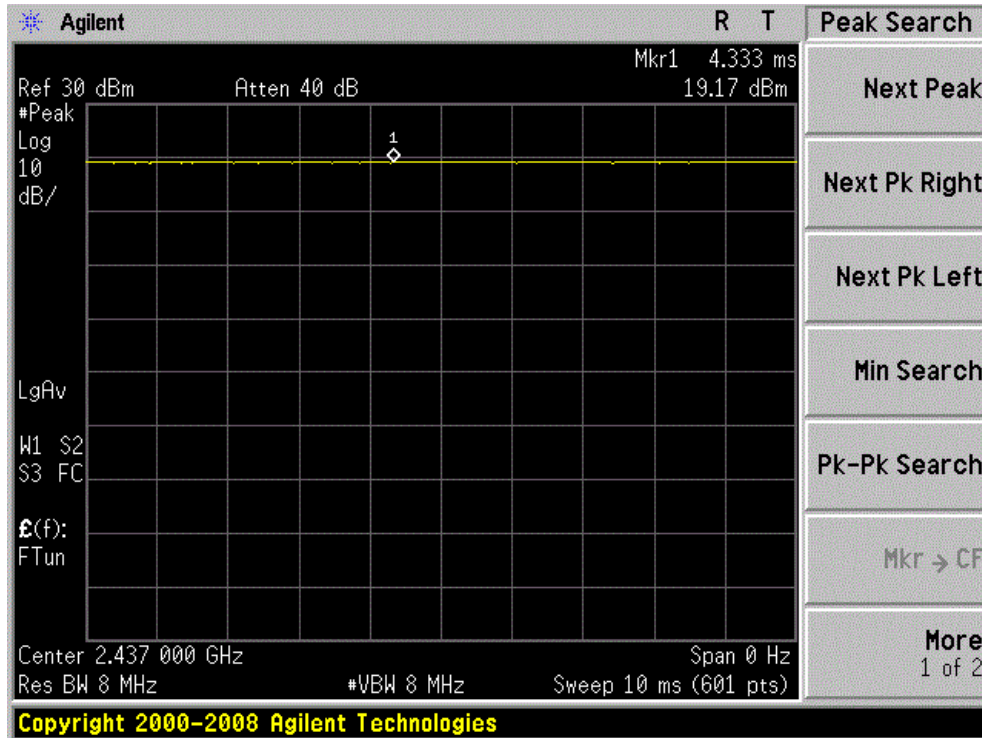

802.11G

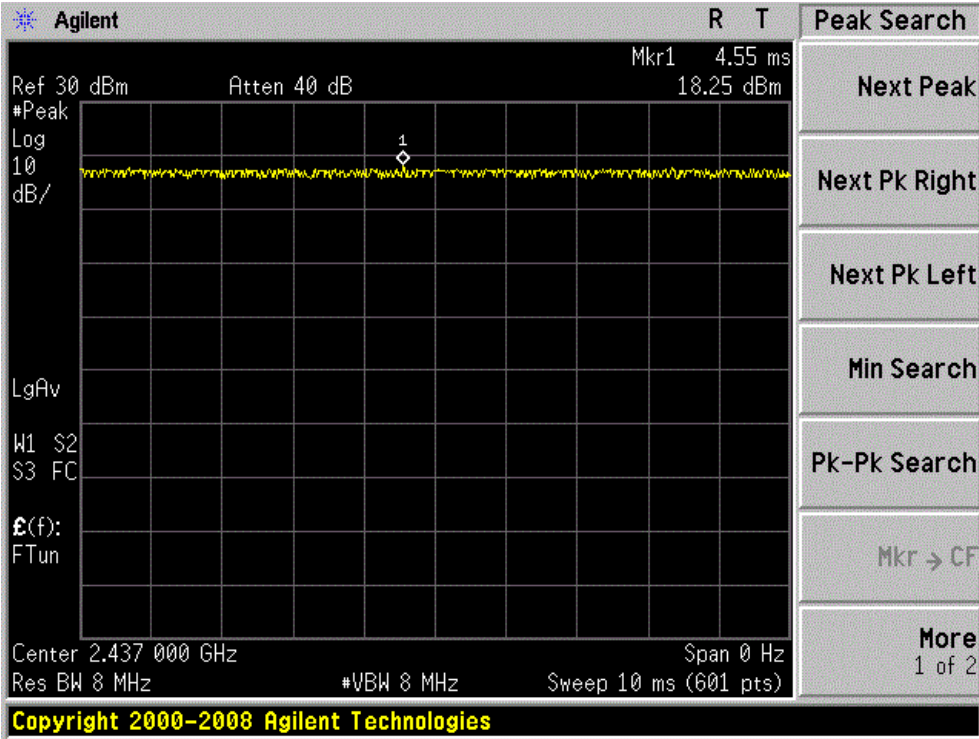

802.11N20

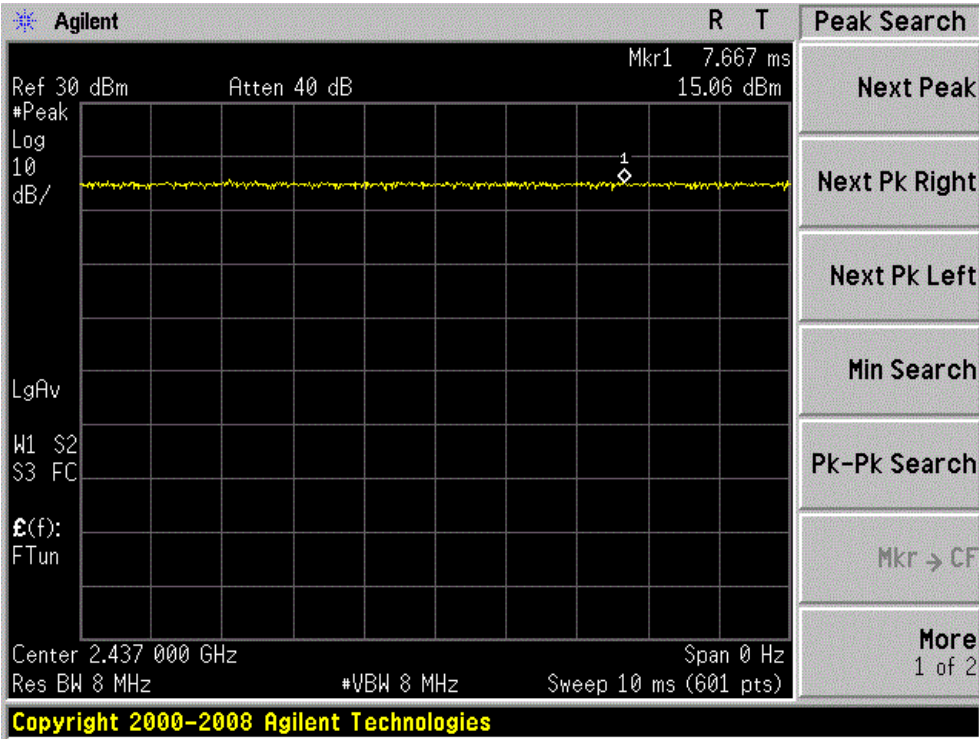

802.11N40

Agilent
R T
Peak Search

Ref 30 dBm    Atten 40 dB
Mkr1 1.75 ms  
13.01 dBm

#Peak

Log

10

dB/

LgAv

W1 S2  
S3 FC

£(f):  
FTun

Next Peak

Next Pk Right

Next Pk Left

Min Search

Pk-Pk Search

Mkr → CF

More  
1 of 2

Center 2.437 000 GHz
Span 0 Hz

Res BW 8 MHz
#VBW 8 MHz
Sweep 10 ms (601 pts)

Copyright 2000-2008 Agilent Technologies



**7.6 MAXIMUM OUTPUT POWER**

**7.6.1 Applicable Standard**

According to FCC Part 15.247(b)(3) and KDB 558074 DTS 01 Meas. Guidance v03r05

**7.6.2 Conformance Limit**

The maximum peak conducted output power of the intentional radiator for systems using digital modulation in the 2400 - 2483.5 MHz bands shall not exceed: 1 Watt (30dBm). If transmitting antenna of directional gain greater than 6dBi is used, the peak output power from the intentional radiator shall be reduced below the above stated value by the amount in dB that the directional gain of the antenna exceeds 6 dBi. In case of point-to-point operation, the limit has to be reduced by 1dB for every 3dB that the directional gain of the antenna exceeds 6dBi.

**7.6.3 Measuring Instruments**

The following table is the setting of the power meter.

| Power Meter Parameter | Setting |
|-----------------------|---------|
| Detector              | Average |

**7.6.4 Test Setup**

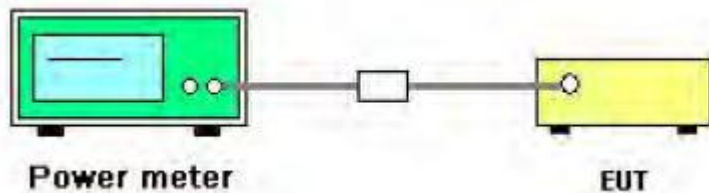

**7.6.5 Test Procedure**

1. Test procedures refer KDB 558074 D01 v03r05 section 9.2.3.2 Measurement using a power meter (PM).
2. Alternatively, measurements may be performed using a wideband gated RF power meter provided that the gate parameters are adjusted such that the power is measured only when the EUT is transmitting at its maximum power control level. Since this measurement is made only during the ON time of the transmitter, no duty cycle correction is required.
3. Multiple antenna system was performed in accordance with KDB 662911 D01 v02r01 Emissions Testing of Transmitters with Multiple Outputs in the Same Band.

**7.6.6 EUT operation during Test**

The EUT was programmed to be in continuously transmitting mode.



**7.6.7 Test Results**

|              |   |                    |           |
|--------------|---|--------------------|-----------|
| EUT:         | Wi-Fi&Bluetooth Speaker with Amazon Alexa Voice Control | Model No.:         | NAS-5000  |
| Temperature: | 20 °C   | Relative Humidity: | 48%       |
| Test Mode:   | 802.11b/g/n20/n40                                       | Test By:           | Allen Liu |

| Test Channel        | Frequency (MHz) | Power Setting | Duty Cycle Factor (dB) | Average Output Power (dBm) | Maximum Output Power(dBm) | LIMIT (dBm) | Verdict |
|---------------------|-----------------|---------------|------------------------|----------------------------|---------------------------|-------------|---------|
| <b>802.11b</b>      |                 |               |                        |                            |                           |             |         |
| 1                   | 2412            | Default       | 0                      | 15.5                       | 15.5                      | 30          | PASS    |
| 6                   | 2437            | Default       | 0                      | 15.6                       | 15.6                      | 30          | PASS    |
| 11                  | 2462            | Default       | 0                      | 15.3                       | 15.3                      | 30          | PASS    |
| <b>802.11g</b>      |                 |               |                        |                            |                           |             |         |
| 1                   | 2412            | Default       | 0                      | 13.4                       | 13.4                      | 30          | PASS    |
| 6                   | 2437            | Default       | 0                      | 13.5                       | 13.5                      | 30          | PASS    |
| 11                  | 2462            | Default       | 0                      | 13.8                       | 13.8                      | 30          | PASS    |
| <b>802.11n HT20</b> |                 |               |                        |                            |                           |             |         |
| 1                   | 2412            | Default       | 0                      | 12.3                       | 12.3                      | 30          | PASS    |
| 6                   | 2437            | Default       | 0                      | 12.7                       | 12.7                      | 30          | PASS    |
| 11                  | 2462            | Default       | 0                      | 12.2                       | 12.2                      | 30          | PASS    |
| <b>802.11n HT40</b> |                 |               |                        |                            |                           |             |         |
| 3                   | 2422            | Default       | 0                      | 10.4                       | 10.4                      | 30          | PASS    |
| 6                   | 2437            | Default       | 0                      | 10.6                       | 10.6                      | 30          | PASS    |
| 9                   | 2452            | Default       | 0                      | 10.7                       | 10.7                      | 30          | PASS    |

## 7.7 POWER SPECTRAL DENSITY

### 7.7.1 Applicable Standard

According to FCC Part 15.247(e) and KDB 558074 DTS 01 Meas. Guidance v03r05

### 7.7.2 Conformance Limit

The transmitter power spectral density conducted from the transmitter to the antenna shall not be greater than 8 dBm in any 3 kHz band during any time interval of continuous transmission.

### 7.7.3 Measuring Instruments

The Measuring equipment is listed in the section 6.3 of this test report.

### 7.7.4 Test Setup

Please refer to Section 6.1 of this test report.

### 7.7.5 Test Procedure

The testing follows Measurement Procedure 10.3 Method AVGPSD of FCC KDB Publication No. 558074 D01 DTS Meas. Guidance v03r05

This procedure may be used when the maximum (average) conducted output power was used to demonstrate compliance to the output power limit. This is the baseline method for determining the maximum (average) conducted PSD level. If the instrument has an RMS power averaging detector, it must be used; otherwise, use the sample detector. The EUT must be configured to transmit continuously (duty cycle  $\geq 98\%$ ); otherwise sweep triggering/signal gating must be implemented to ensure that measurements are made only when the EUT is transmitting at its maximum power control level (no transmitter off time is to be considered).

The RF output of EUT was connected to the spectrum analyzer by RF cable and attenuator.

The path loss was compensated to the results for each measurement.

Set to the maximum power setting and enable the EUT transmit continuously.

The EUT was operating in controlled its channel.

- a) Set instrument center frequency to DTS channel center frequency.
- b) Set span to at least 1.5 times the OBW.
- c) Set RBW to:  $3 \text{ kHz} \leq \text{RBW} \leq 100 \text{ kHz}$ .
- d) Set VBW  $\geq 3 \times \text{RBW}$ .
- e) Detector = power averaging (RMS) or sample detector (when RMS not available).
- f) Ensure that the number of measurement points in the sweep  $\geq 2 \times \text{span}/\text{RBW}$ .
- g) Sweep time = auto couple.
- h) Employ trace averaging (RMS) mode over a minimum of 100 traces.
- i) Use the peak marker function to determine the maximum amplitude level.
- j) If measured value exceeds limit, reduce RBW (no less than 3 kHz) and repeat (note that this may require zooming in on the emission of interest and reducin

**7.7.6 Test Results**

|              |   |                    |           |
|--------------|---|--------------------|-----------|
| EUT:         | Wi-Fi&Bluetooth Speaker with Amazon Alexa Voice Control | Model No.:         | NAS-5000  |
| Temperature: | 20 °C   | Relative Humidity: | 48%       |
| Test Mode:   | 802.11b/g/n20/n40                                       | Test By:           | Allen Liu |

| Test Channel        | Frequency (MHz) | Duty Cycle Factor(dB) | Power Density (dBm/3KHz) | Limit (dBm/3KHz) | Verdict |
|---------------------|-----------------|-----------------------|--------------------------|------------------|---------|
| <b>802.11b</b>      |                 |                       |                          |                  |         |
| 1                   | 2412            | 0                     | -7.432                   | 8                | PASS    |
| 6                   | 2437            | 0                     | -7.908                   | 8                | PASS    |
| 11                  | 2462            | 0                     | -9.725                   | 8                | PASS    |
| <b>802.11g</b>      |                 |                       |                          |                  |         |
| 1                   | 2412            | 0                     | -12.761                  | 8                | PASS    |
| 6                   | 2437            | 0                     | -12.412                  | 8                | PASS    |
| 11                  | 2462            | 0                     | -10.482                  | 8                | PASS    |
| <b>802.11n HT20</b> |                 |                       |                          |                  |         |
| 1                   | 2412            | 0                     | -13.205                  | 8                | PASS    |
| 6                   | 2437            | 0                     | -12.044                  | 8                | PASS    |
| 11                  | 2462            | 0                     | -13.055                  | 8                | PASS    |
| <b>802.11n HT40</b> |                 |                       |                          |                  |         |
| 3                   | 2422            | 0                     | -16.353                  | 8                | PASS    |
| 6                   | 2437            | 0                     | -16.015                  | 8                | PASS    |
| 9                   | 2452            | 0                     | -15.814                  | 8                | PASS    |

Test plot

(802.11b) PSD plot on channel 1

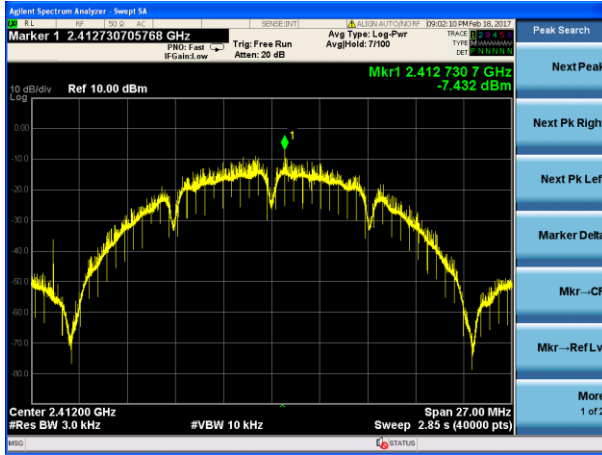

(802.11g) PSD plot on channel 1

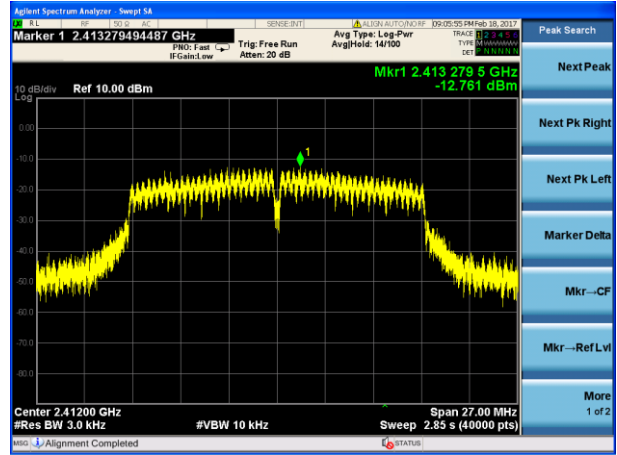

(802.11b) PSD plot on channel 6

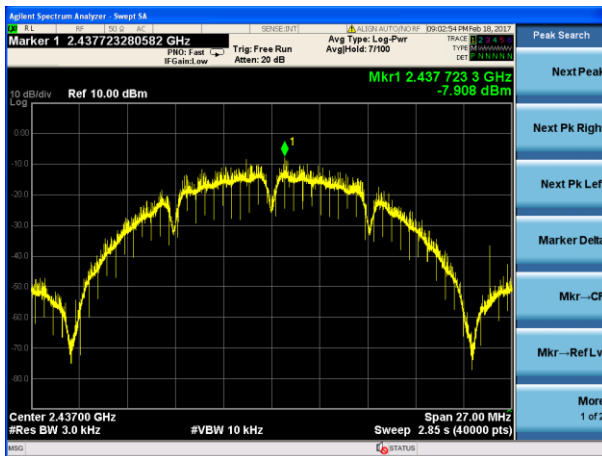

(802.11g) PSD plot on channel 6

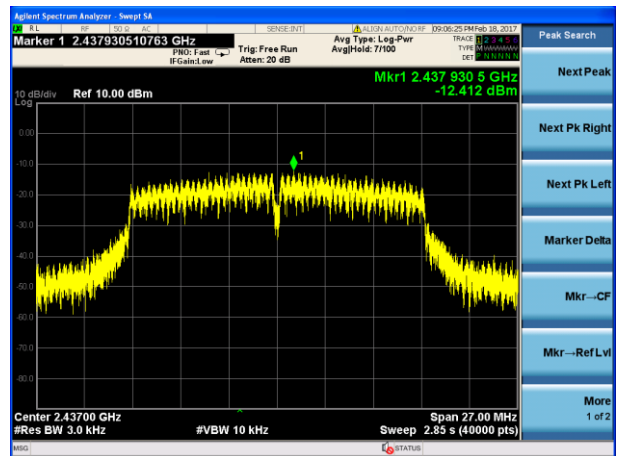

(802.11b) PSD plot on channel 11

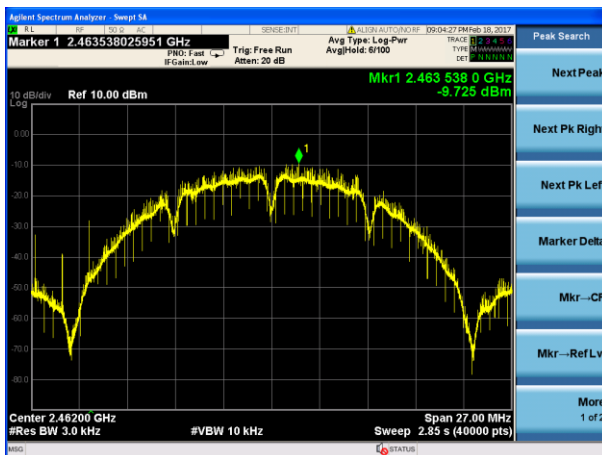

(802.11g) PSD plot on channel 11

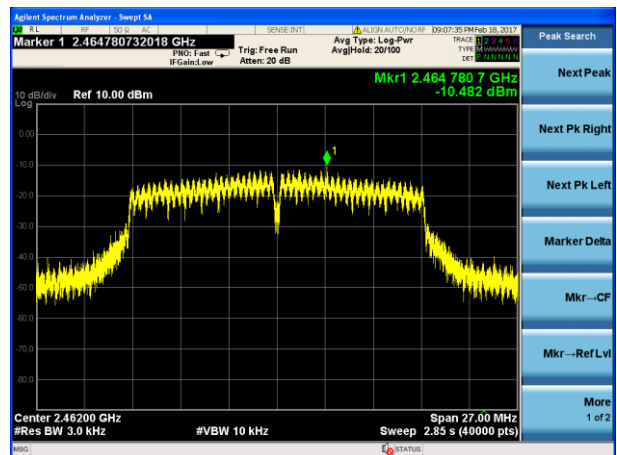

### Test plot

(802.11n20) PSD plot on channel 1

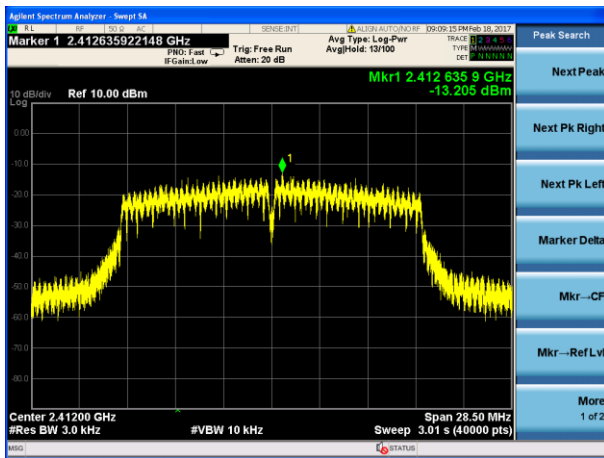

(802.11n40) PSD plot on channel 3

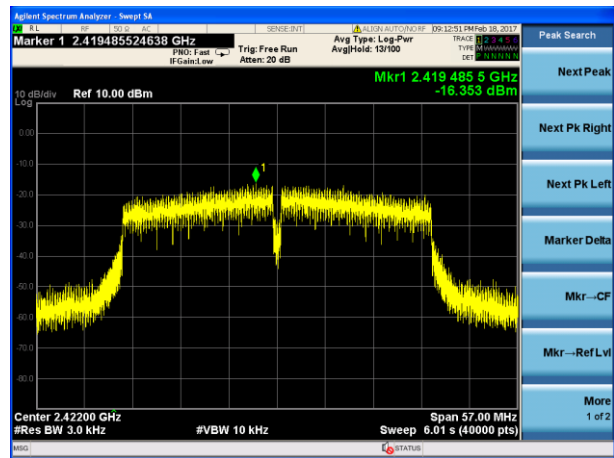

(802.11n20) PSD plot on channel 6

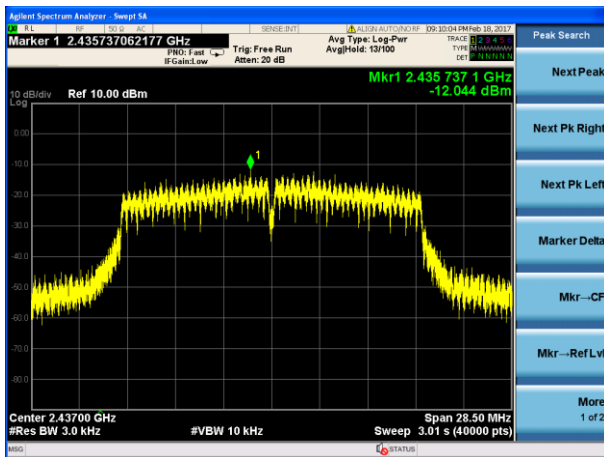

(802.11n40) PSD plot on channel 6

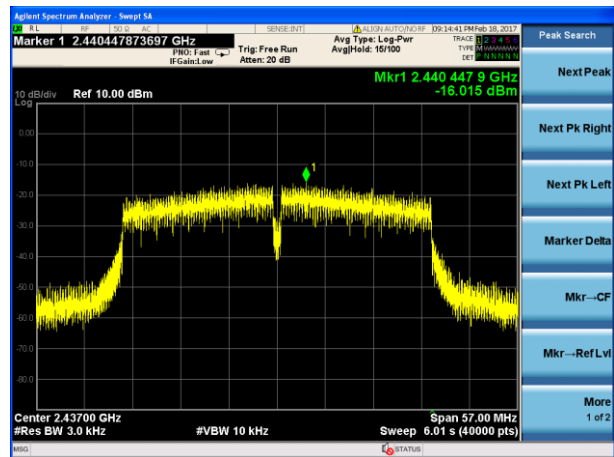

(802.11n20) PSD plot on channel 11

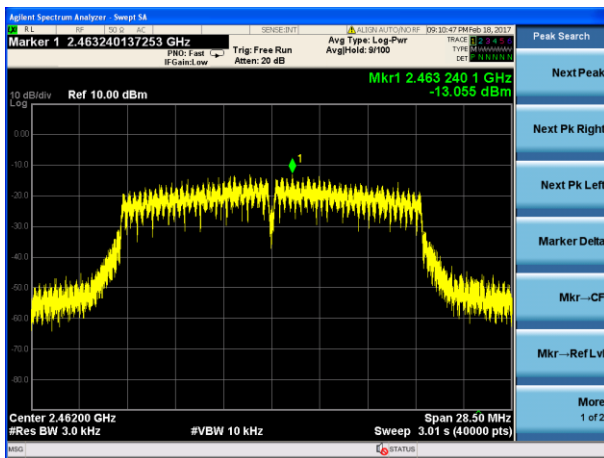

(802.11n40) PSD plot on channel 9

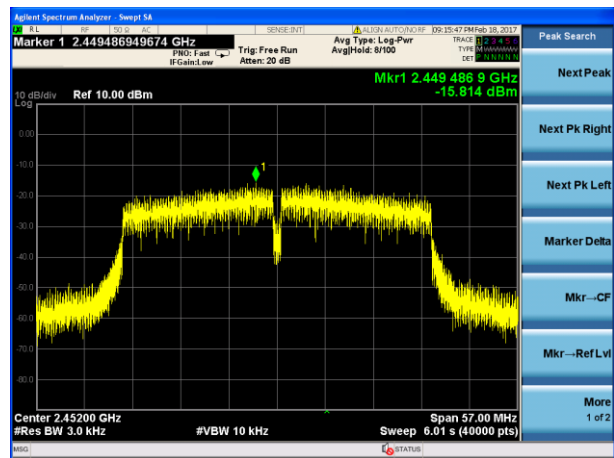

## **7.8 CONDUCTED BAND EDGE MEASUREMENT**

### **7.8.1 Applicable Standard**

According to FCC Part 15.247(d) and KDB 558074 DTS 01 Meas. Guidance v03r05

### **7.8.2 Conformance Limit**

In any 100 kHz bandwidth outside the frequency band in which the spread spectrum or digitally modulated intentional radiator is operating, the radio frequency power that is produced by the intentional radiator shall be at least 20 dB below that in the 100 kHz bandwidth within the band that contains the highest level of the desired power, based on either an RF conducted or a radiated measurement, provided the transmitter demonstrates compliance with the peak conducted power limits. If the transmitter complies with the conducted power limits based on the use of RMS averaging over a time interval, as permitted under paragraph (b)(3) of this section, the attenuation required under this paragraph shall be 30 dB instead of 20 dB.

### **7.8.3 Measuring Instruments**

The Measuring equipment is listed in the section 6.3 of this test report.

### **7.8.4 Test Setup**

Please refer to Section 6.1 of this test report.

### **7.8.5 Test Procedure**

The testing follows FCC KDB Publication No. 558074 D01 DTS Meas. Guidance v03r05.

The RF output of EUT was connected to the spectrum analyzer by RF cable and attenuator.

The path loss was compensated to the results for each measurement.

Set to the maximum power setting and enable the EUT transmit continuously.

The EUT was operating in controlled its channel.

Set RBW to 100 kHz and VBW of spectrum analyzer to 300 kHz with a convenient frequency span including 100 kHz bandwidth from band edge.

Measure the highest amplitude appearing on spectral display and set it as a reference level. Plot the graph with marking the highest point and edge frequency.

Repeat above procedures until all measured frequencies were complete.

### 7.8.6 Test Results

|              |   |                    |           |
|--------------|---|--------------------|-----------|
| EUT:         | Wi-Fi&Bluetooth Speaker with Amazon Alexa Voice Control | Model No.:         | NAS-5000  |
| Temperature: | 20 °C   | Relative Humidity: | 48%       |
| Test Mode:   | 802.11b/g/n20/n40                                       | Test By:           | Allen Liu |

#### Test plot For

802.11b: Band Edge-Low Channel

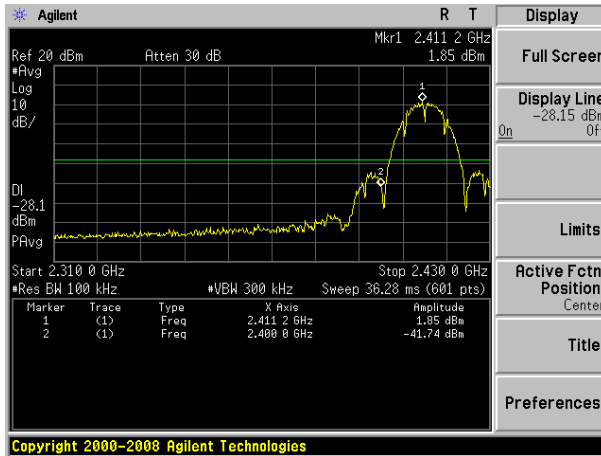

802.11g: Band Edge-Low Channel

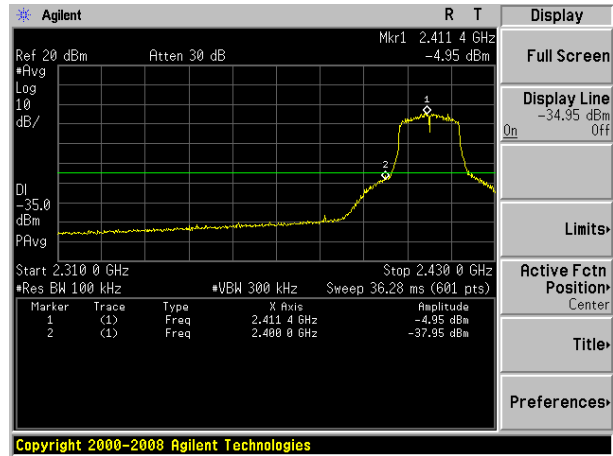

802.11b: Band Edge-High Channel

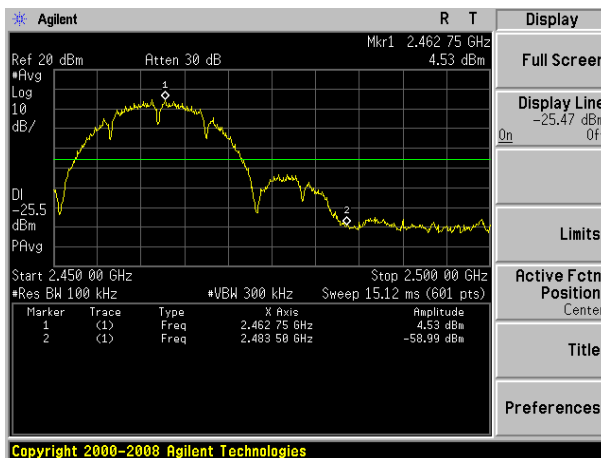

802.11g: Band Edge-High Channel

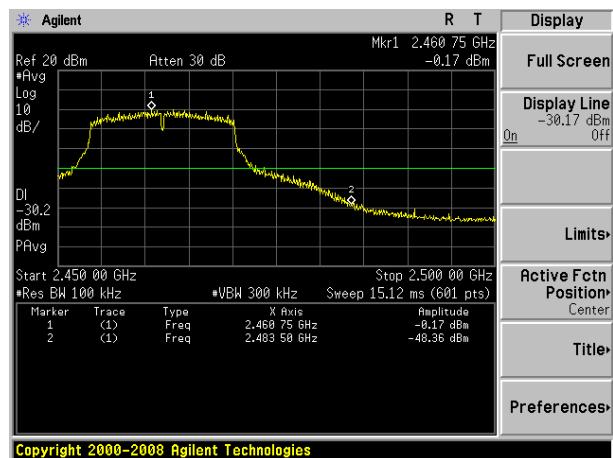

**Test plot For**

802.11n20: Band Edge-Low Channel

802.11n40: Band Edge-Low Channel

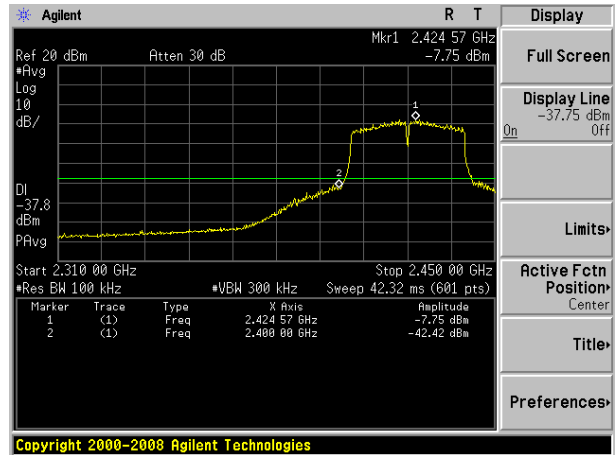
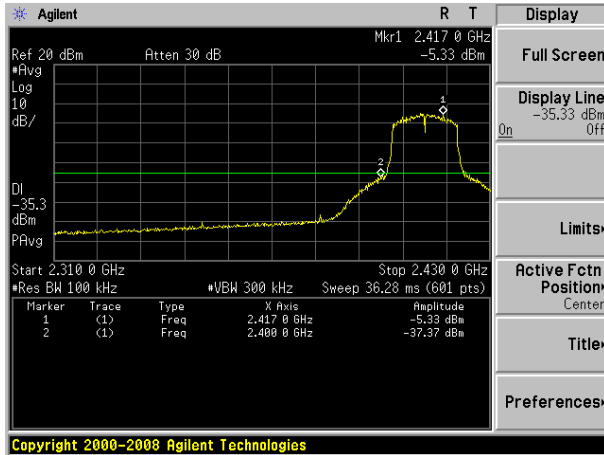

802.11n20: Band Edge-High Channel

802.11n40: Band Edge-High Channel

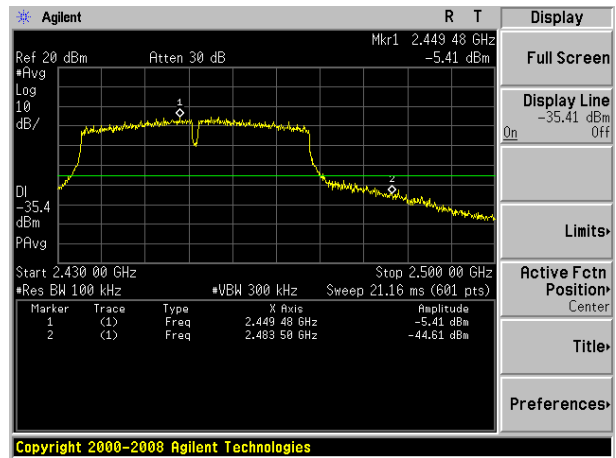
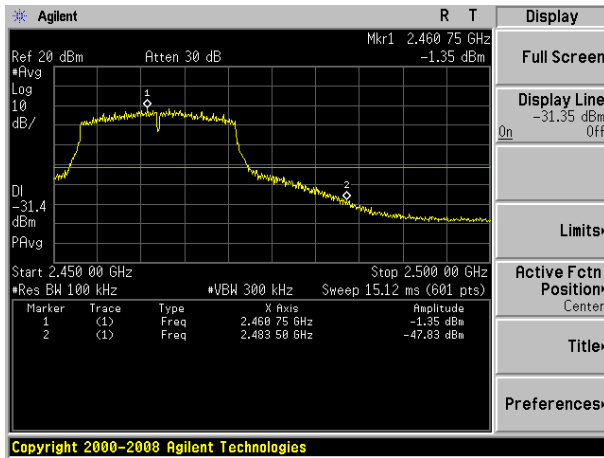



## **7.9 SPURIOUS RF CONDUCTED EMISSIONS**

### **7.9.1 Conformance Limit**

1. Below -20dB of the highest emission level in operating band.
2. Fall in the restricted bands listed in section 15.205. The maximum permitted average field strength is listed in section 15.209.

### **7.9.2 Measuring Instruments**

The Measuring equipment is listed in the section 6.3 of this test report.

### **7.9.3 Test Setup**

Please refer to Section 6.1 of this test report.

### **7.9.4 Test Procedure**

The Spurious RF conducted emissions compliance of RF radiated emission should be measured by following the guidance in ANSI C63.10-2013 with respect to maximizing the emission by rotating the EUT, measuring the emission while the EUT is situated in three orthogonal planes (if appropriate), adjusting the measurement antenna height and polarization etc. Set RBW=100kHz and VBW= 300kHz to measure the peak field strength , and measure frequency range from 9kHz to 26.5GHz.

### **7.9.5 Test Results**

Remark: The measurement frequency range is from 9kHz to the 10th harmonic of the fundamental frequency. The lowest, middle and highest channels are tested to verify the spurious emissions and band edge measurement data.

### Test Plot

802.11b on channel 01

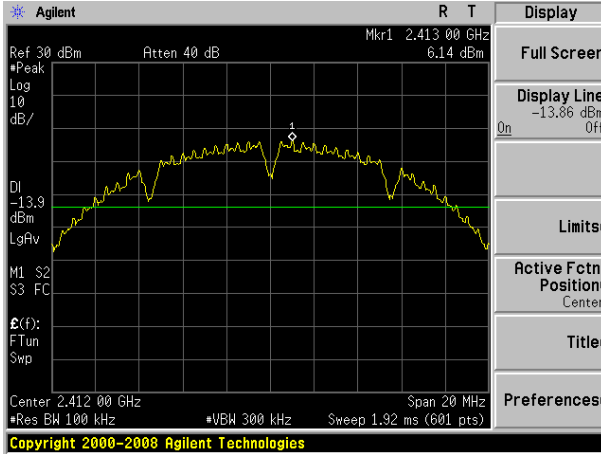

802.11b on channel 01

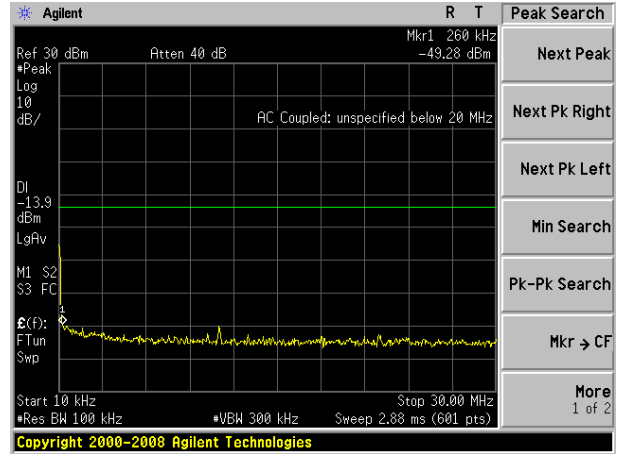

802.11b on channel 01

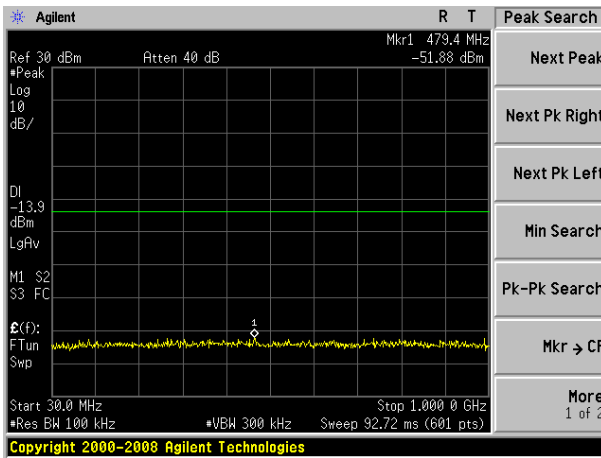

802.11b on channel 01

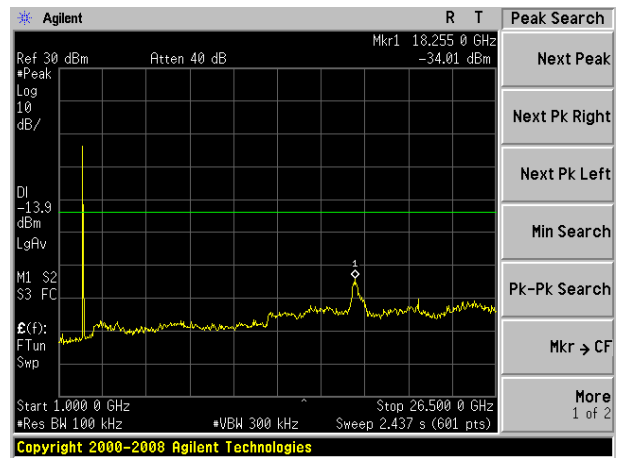

### Test Plot

802.11b on channel 06

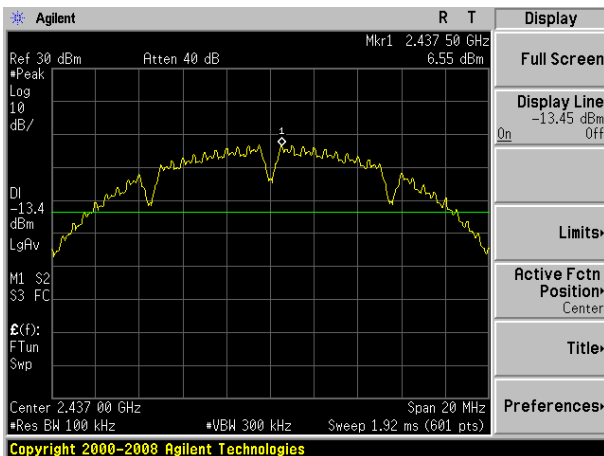

802.11b on channel 06

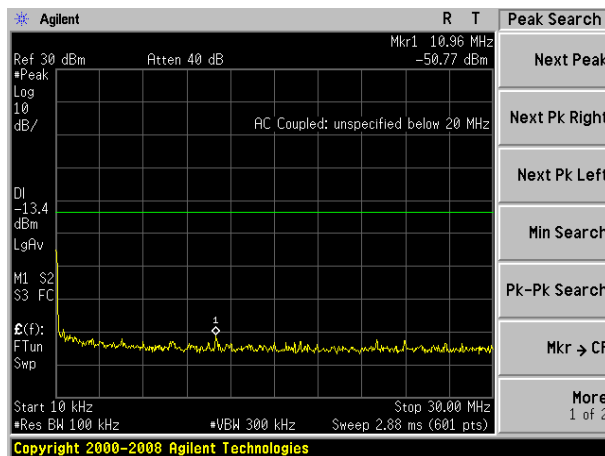

802.11b on channel 06

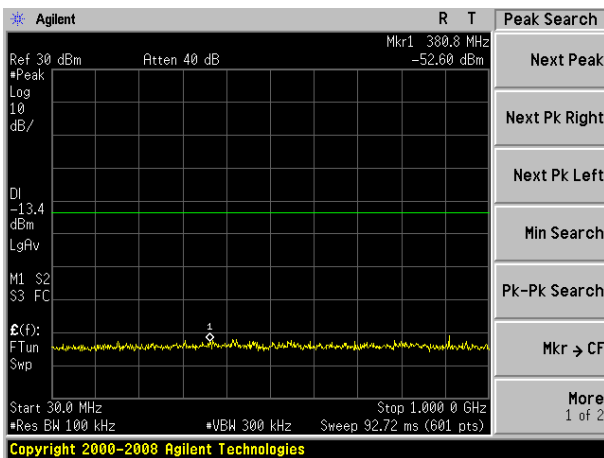

802.11b on channel 06

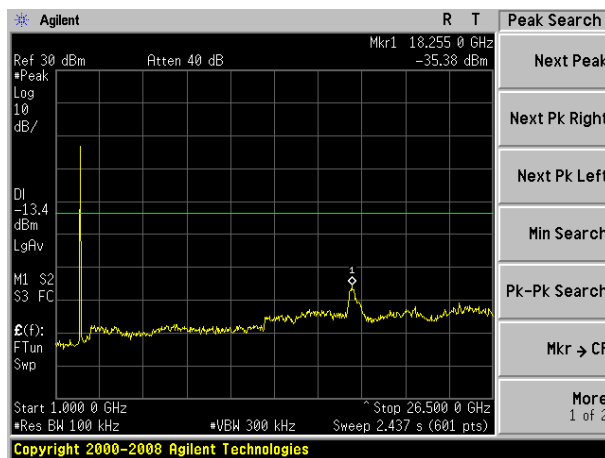

### Test Plot

802.11b on channel 11

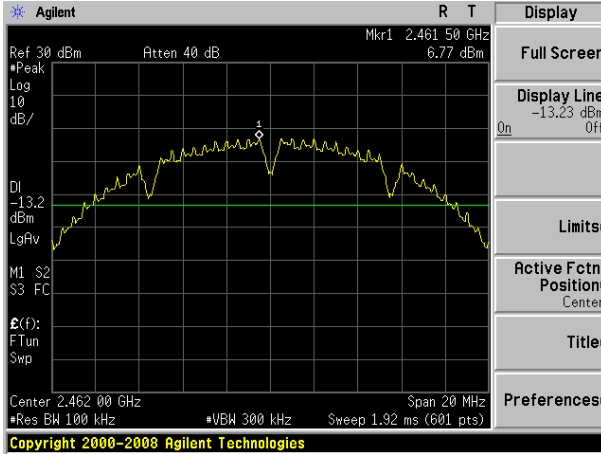

802.11b on channel 11

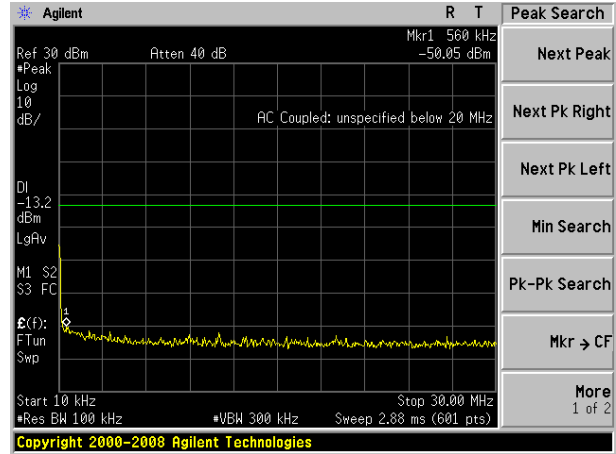

802.11b on channel 11

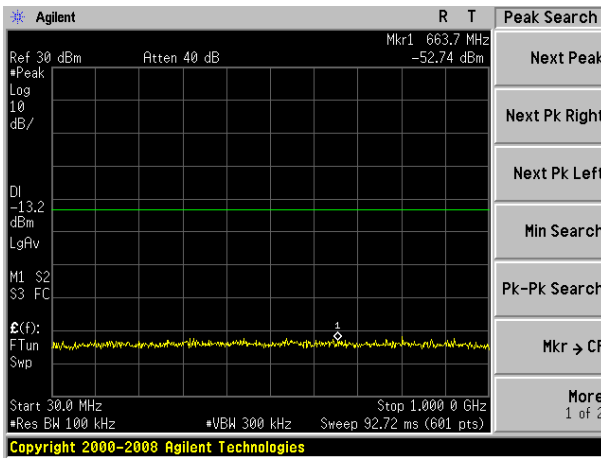

802.11b on channel 11

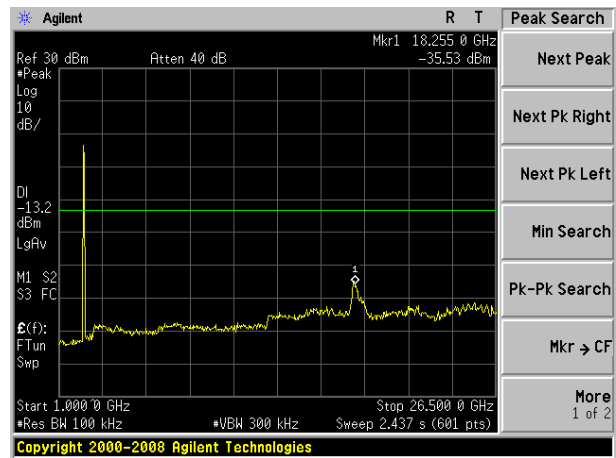

### Test Plot

802.11g on channel 01

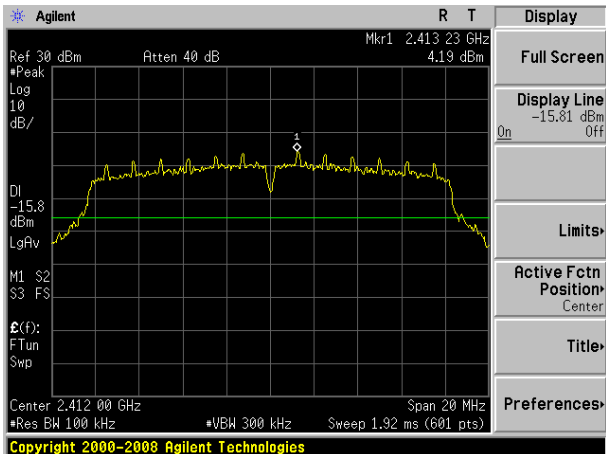

802.11g on channel 01

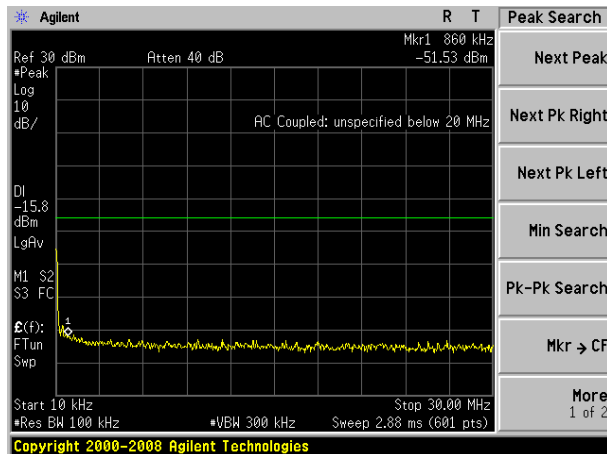

802.11g on channel 01

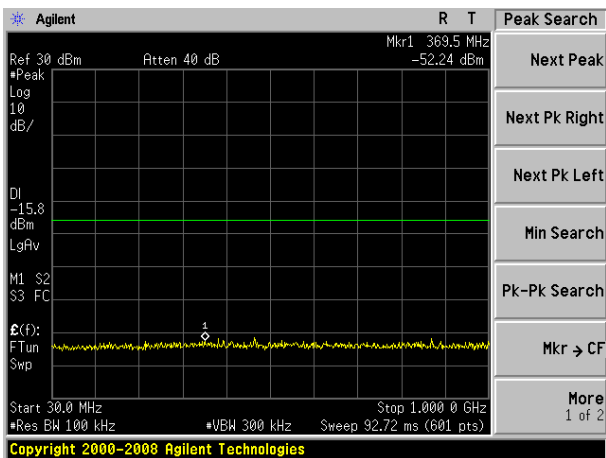

802.11g on channel 01

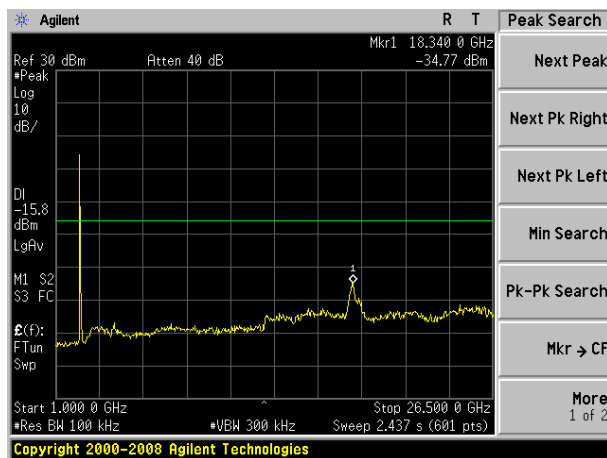

### Test Plot

802.11g on channel 06

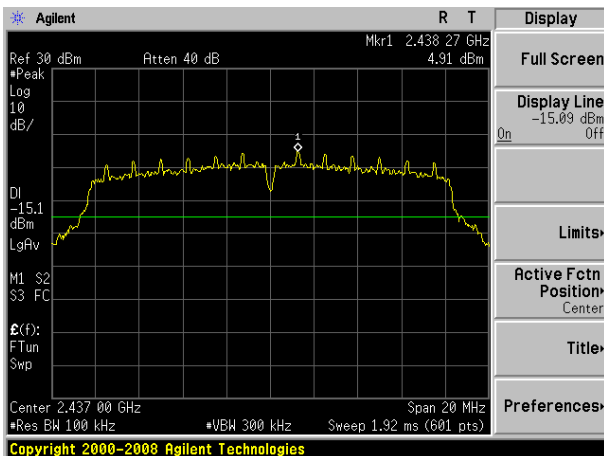

802.11g on channel 06

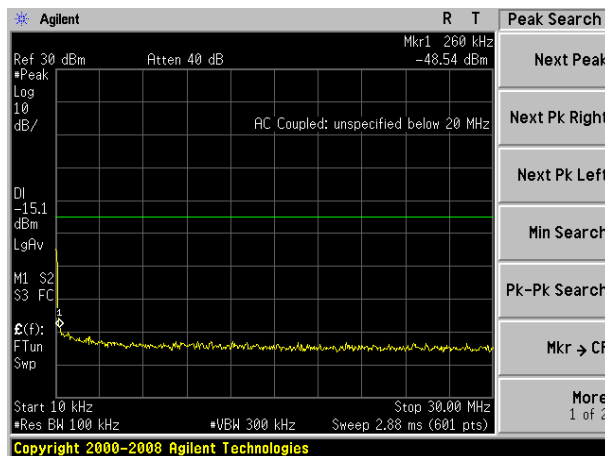

802.11g on channel 06

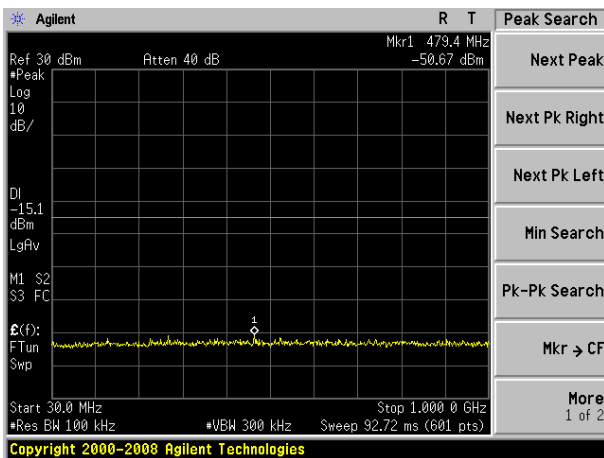

802.11g on channel 06

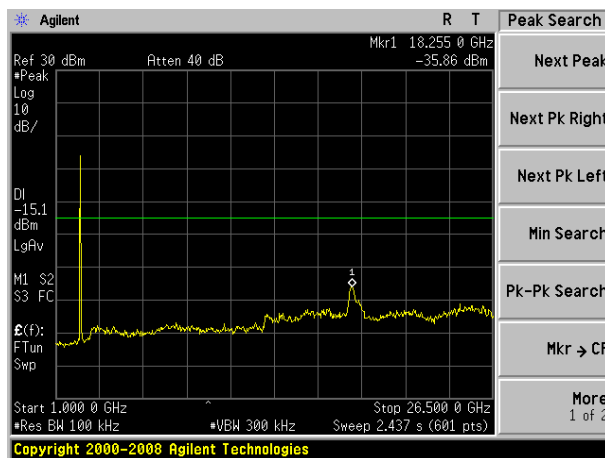

### Test Plot

802.11g on channel 11

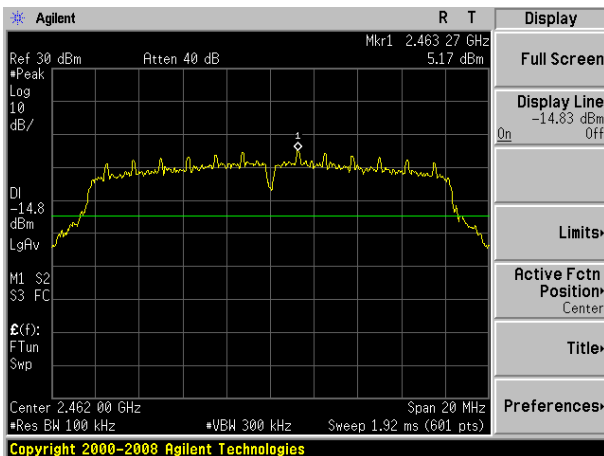

802.11g on channel 11

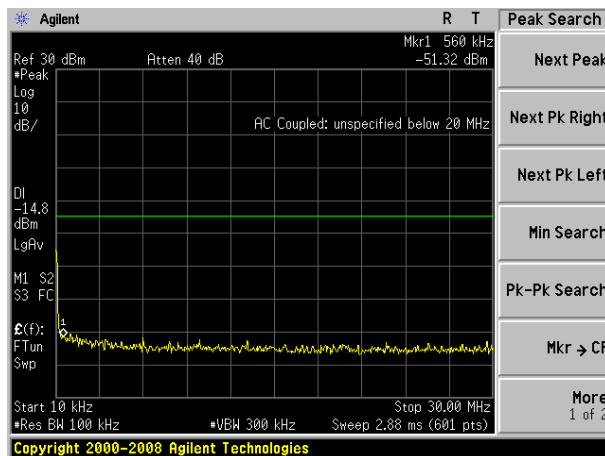

802.11g on channel 11

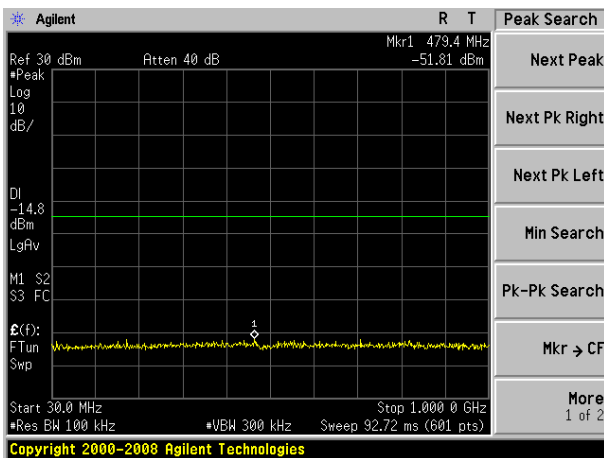

802.11g on channel 11

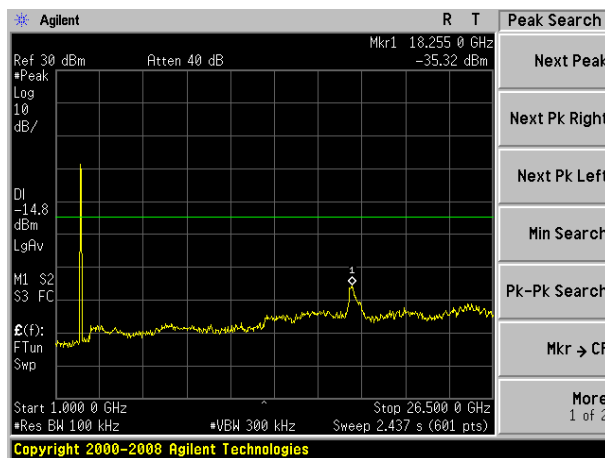

### Test Plot

802.11n20 on channel 01

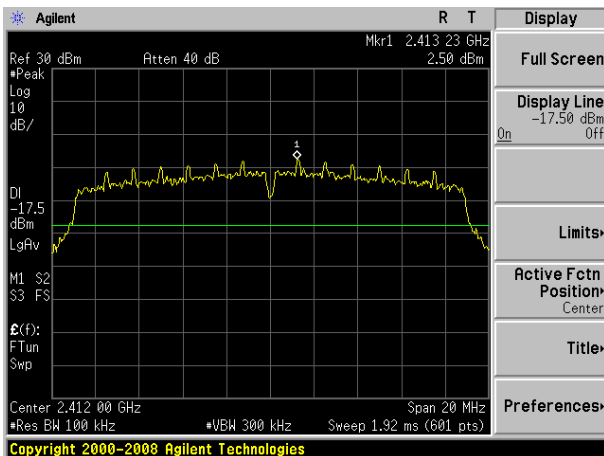

802.11n20 on channel 01

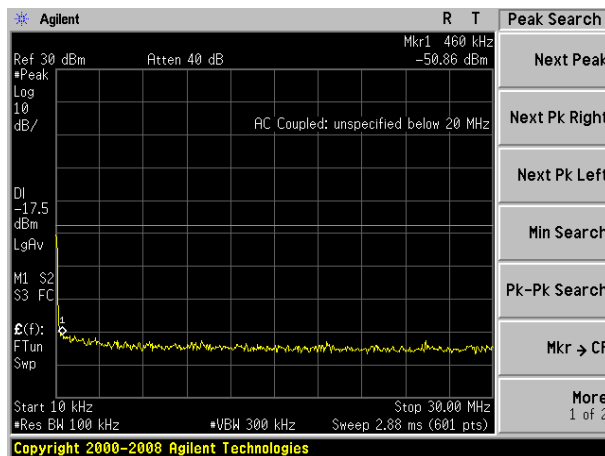

802.11 n20 on channel 01

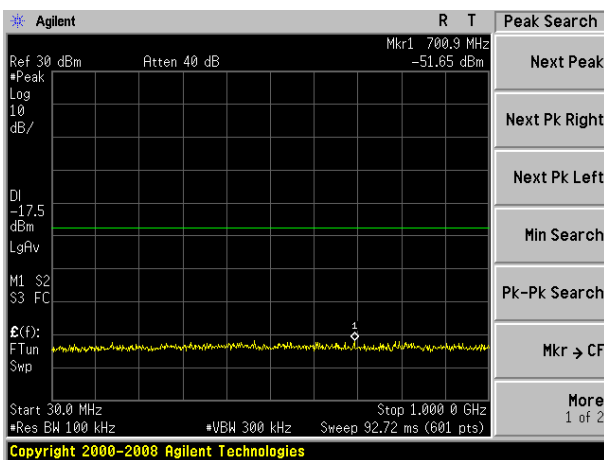

802.11 n20 on channel 01

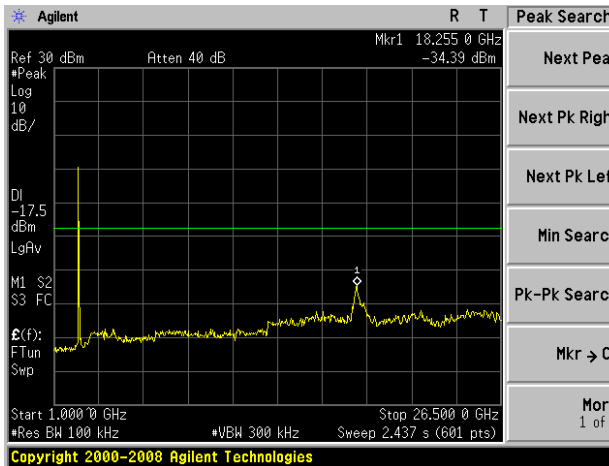



### Test Plot

802.11 n20 on channel 06

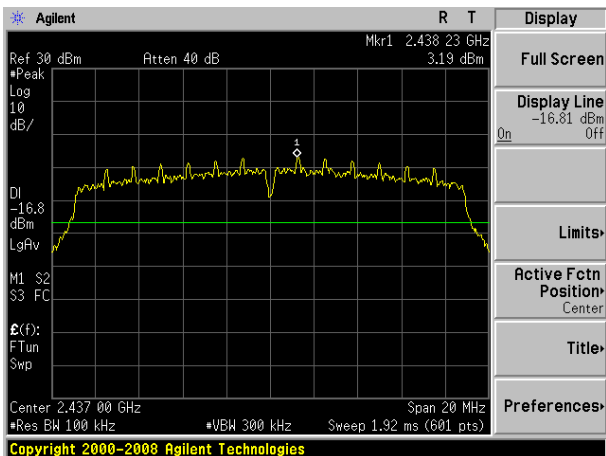

802.11 n20 on channel 06

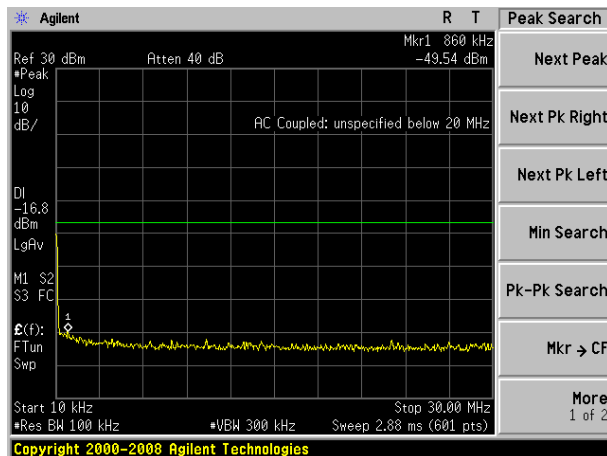

802.11 n20 on channel 06

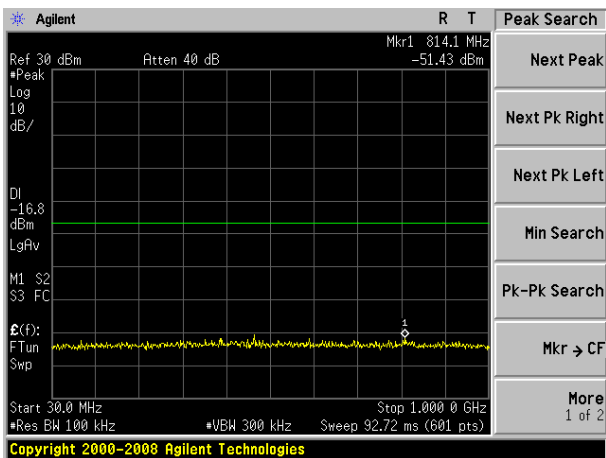

802.11 n20 on channel 06

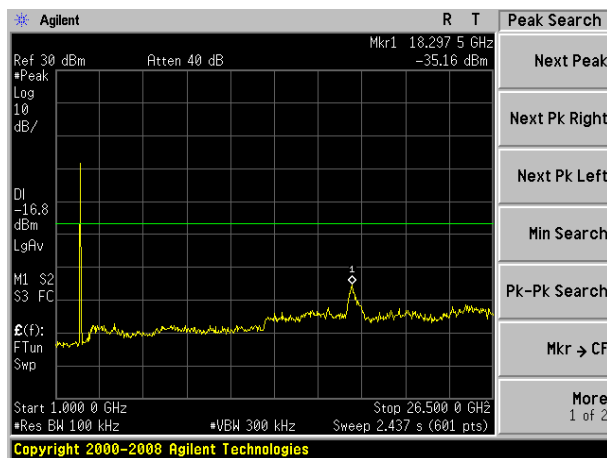

### Test Plot

802.11 n20 on channel 11

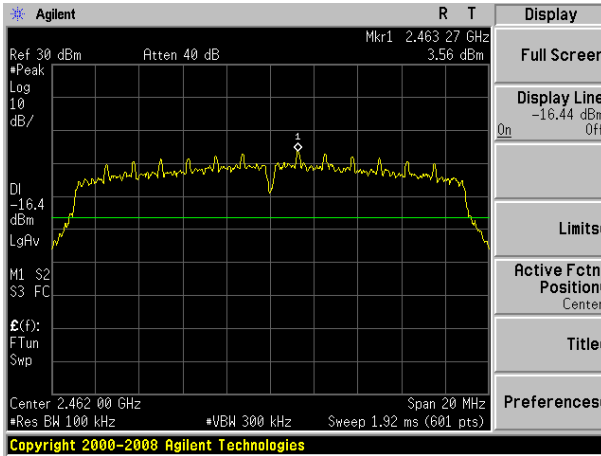

802.11 n20 on channel 11

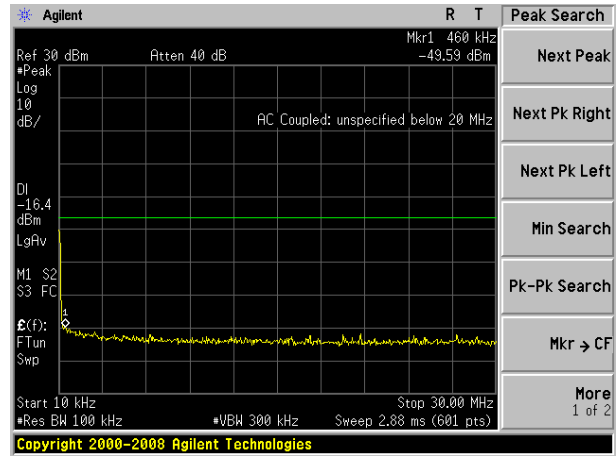

802.11 n20 on channel 11

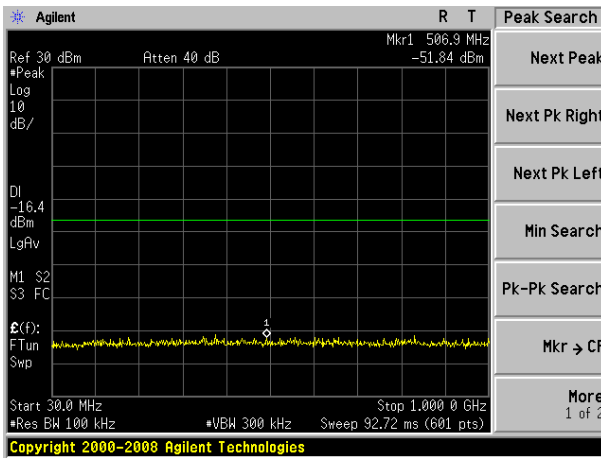

802.11 n20 on channel 11

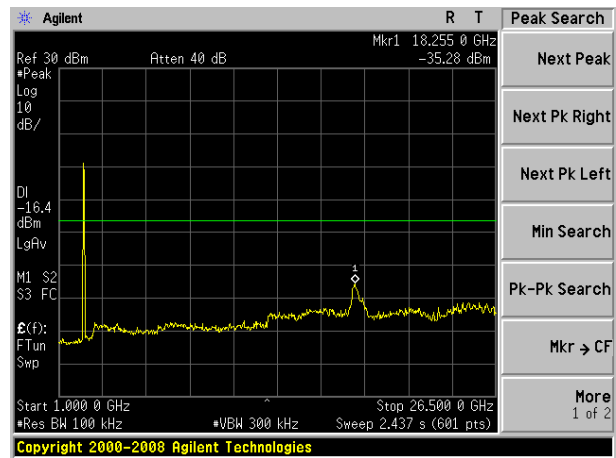

### Test Plot

802.11n40 on channel 03

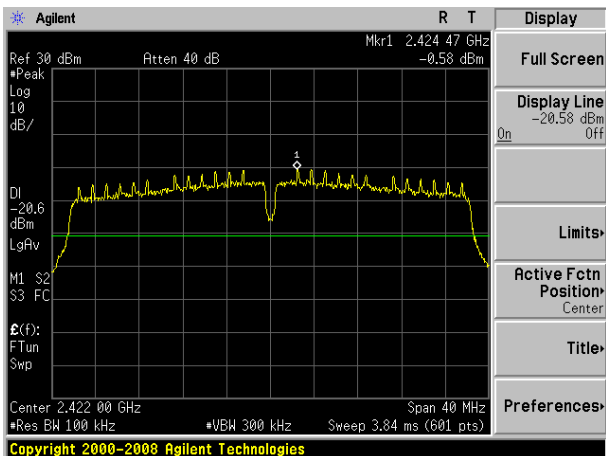

802.11n40 on channel 03

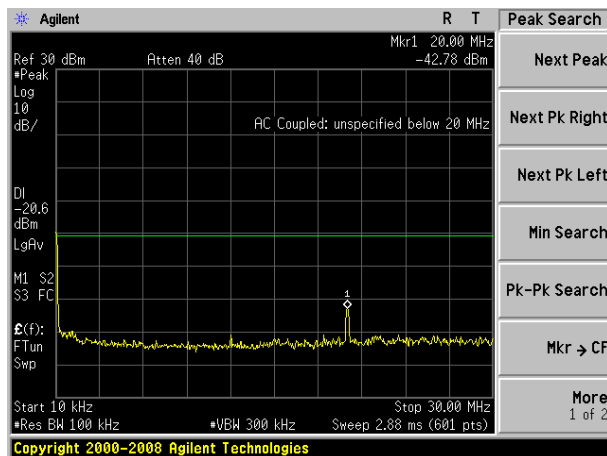

802.11n40 on channel 03

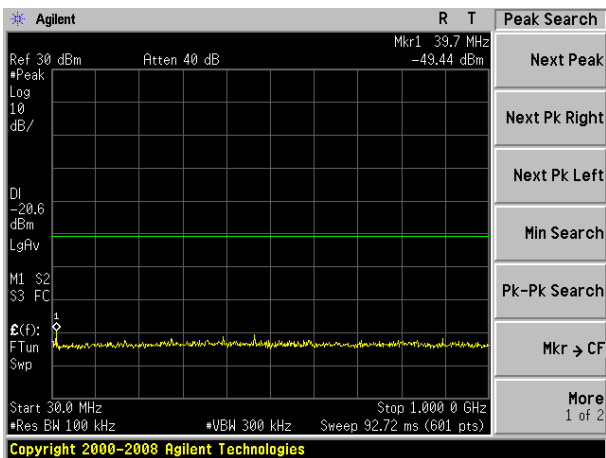

802.11n40 on channel 03

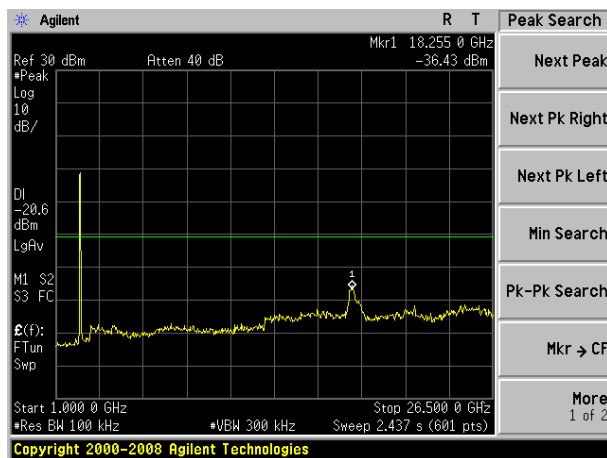

### Test Plot

802.11n40 on channel 06

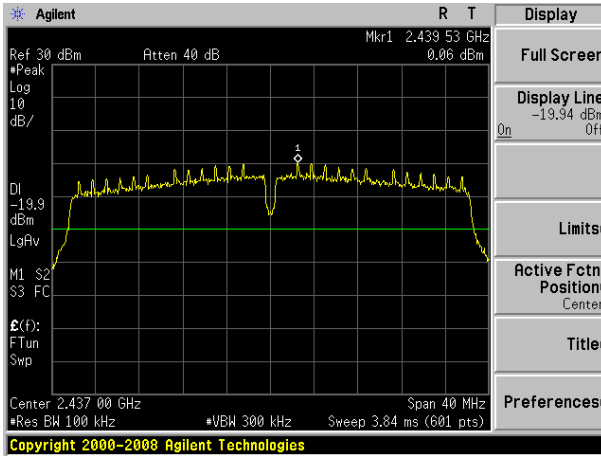

802.11 n40 on channel 06

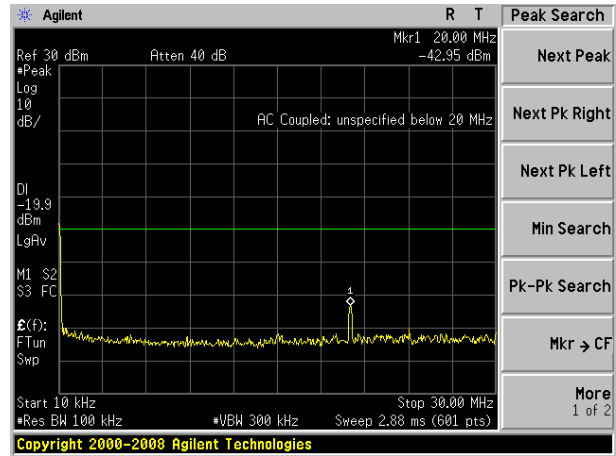

802.11 n40 on channel 06

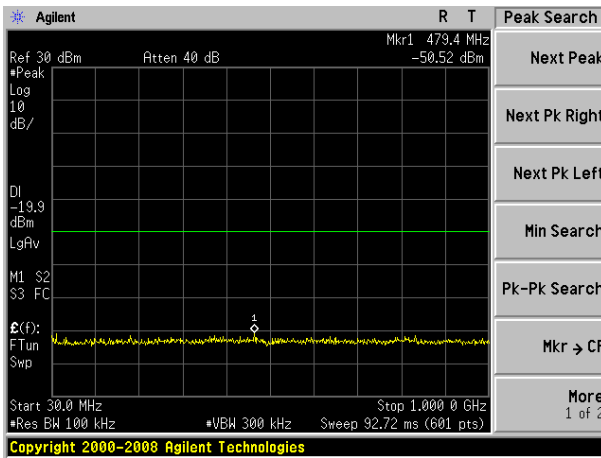

802.11 n40 on channel 06

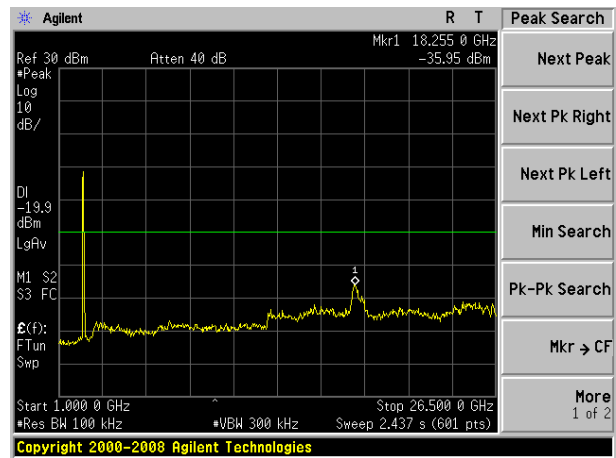

### Test Plot

802.11 n40 on channel 9

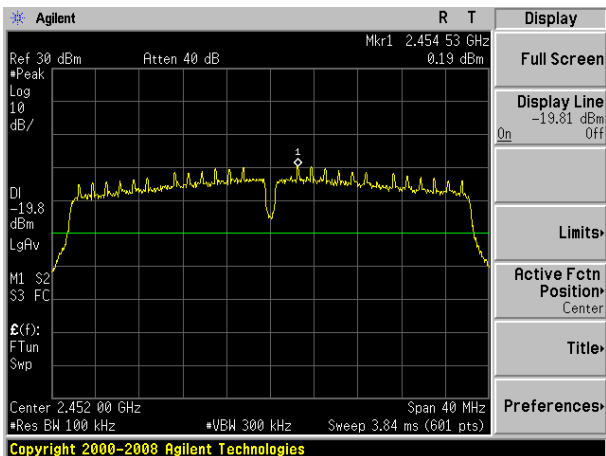

802.11 n40 on channel 9

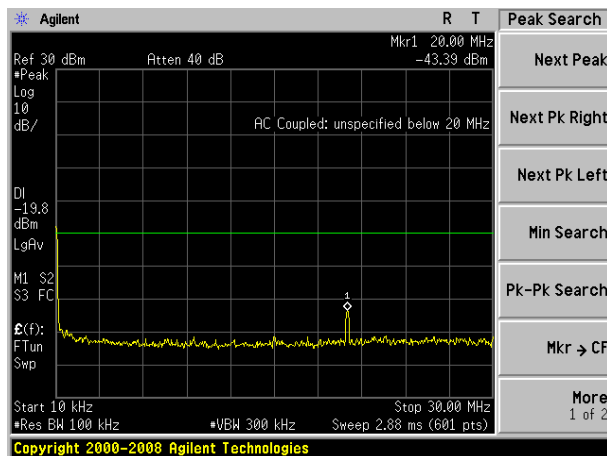

802.11 n40 on channel 9

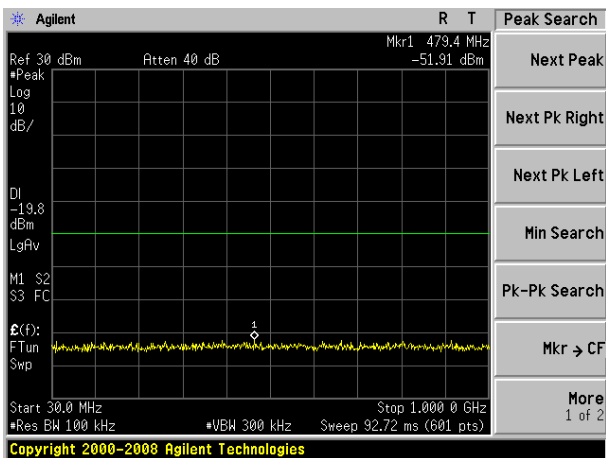

802.11 n40 on channel 9

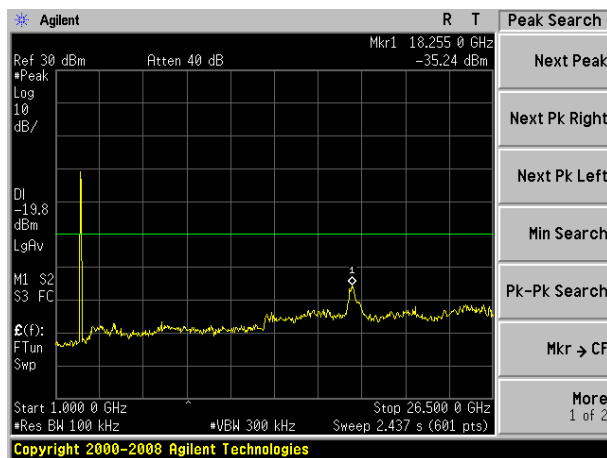

## **7.10 ANTENNA APPLICATION**

### **7.10.1 Antenna Requirement**

15.203 requirement: For intentional device, according to 15.203: an intentional radiator shall be designed to ensure that no antenna other than that furnished by the responsible party shall be used with the device.

### **7.10.2 Result**

The EUT antenna is permanent attached Steel antenna (Gain:1dBi). It comply with the standard requirement.

END OF REPORT