



RADIO TEST REPORT

FCC ID: OKUCAW37051

Product: Wi-Fi&Bluetooth Speaker with Amazon Alexa Voice Control
Trade Mark: NAXA
Model No.: NAS-5000
Serial Model: CAW-37051
Report No.: NTEK-2017NT02101410F1
Issue Date: 06 Mar. 2017

Prepared for

Shenzhen Junlan Electronic Ltd
No.277 PingKui Road, Shijing Community, Pingshan Street,
Pingshan New District, Shenzhen, China

Prepared by

NTEK TESTING TECHNOLOGY CO., LTD.
1/F, Building E, Fenda Science Park, Sanwei Community,
Xixiang Street Bao'an District, Shenzhen 518126 P.R. China
Tel.: +86-755-6115 6588
Fax.: +86-755-6115 6599
Website:<http://www.ntek.org.cn>

TABLE OF CONTENTS

1	TEST RESULT CERTIFICATION	3
2	SUMMARY OF TEST RESULTS.....	4
3	FACILITIES AND ACCREDITATIONS	5
3.1	FACILITIES.....	5
3.2	LABORATORY ACCREDITATIONS AND LISTINGS	5
3.3	MEASUREMENT UNCERTAINTY	5
4	GENERAL DESCRIPTION OF EUT	6
5	DESCRIPTION OF TEST MODES	8
6	SETUP OF EQUIPMENT UNDER TEST	9
6.1	BLOCK DIAGRAM CONFIGURATION OF TEST SYSTEM.....	9
6.2	SUPPORT EQUIPMENT.....	10
6.3	EQUIPMENTS LIST FOR ALL TEST ITEMS.....	11
7	TEST REQUIREMENTS	13
7.1	CONDUCTED EMISSIONS TEST	13
7.2	RADIATED SPURIOUS EMISSION	18
7.3	NUMBER OF HOPPING CHANNEL.....	27
7.4	HOPPING CHANNEL SEPARATION MEASUREMENT	29
7.5	AVERAGE TIME OF OCCUPANCY (DWELL TIME)	33
7.6	20DB BANDWIDTH TEST	37
7.7	PEAK OUTPUT POWER	41
7.8	CONDUCTED BAND EDGE MEASUREMENT.....	45
7.9	SPURIOUS RF CONDUCTED EMISSION.....	49
7.10	ANTENNA APPLICATION	53

1 TEST RESULT CERTIFICATION

Applicant's name	Shenzhen Junlan Electronic Ltd
Address	No.277 PingKui Road, Shijing Community, Pingshan Street, Pingshan New District, Shenzhen, China
Manufacturer's Name	Shenzhen Junlan Electronic Ltd
Address	No.277 PingKui Road, Shijing Community, Pingshan Street, Pingshan New District, Shenzhen, China
Factory's Name	Shenzhen Junlan Electronic Ltd
Address	No.277 PingKui Road, Shijing Community, Pingshan Street, Pingshan New District, Shenzhen, China
Product description	
Product name	Wi-Fi&Bluetooth Speaker with Amazon Alexa Voice Control
Model and/or type reference	NAS-5000
Serial Model	CAW-37051

Measurement Procedure Used:

APPLICABLE STANDARDS	
STANDARD/ TEST PROCEDURE	TEST RESULT
FCC 47 CFR Part 2, Subpart J:2016 FCC 47 CFR Part 15, Subpart C:2016 KDB 174176 D01 Line Conducted FAQ v01r01 ANSI C63.10-2013	Complied

This device described above has been tested by NTEK Testing Technology Co., Ltd., and the test results show that the equipment under test (EUT) is in compliance with the FCC requirements. And it is applicable only to the tested sample identified in the report.

This report shall not be reproduced except in full, without the written approval of NTEK Testing Technology Co., Ltd., this document may be altered or revised by NTEK Testing Technology Co., Ltd., personnel only, and shall be noted in the revision of the document.

The test results of this report relate only to the tested sample identified in this report.

Date of Test : 10 Feb. 2017 ~ 06 Mar. 2017

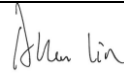
Testing Engineer : 
(Allen Liu)

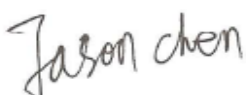
Technical Manager : 
(Jason Chen)

Authorized Signatory : 
(Sam Chen)

2 SUMMARY OF TEST RESULTS

FCC Part15 (15.247), Subpart C			
Standard Section	Test Item	Verdict	Remark
15.207	Conducted Emission	PASS	
15.247(c)	Radiated Spurious Emission	PASS	
15.247(a)(1)	Hopping Channel Separation	PASS	
15.247(b)(1)	Peak Output Power	PASS	
15.247(a)(iii)	Number of Hopping Frequency	PASS	
15.247(a)(iii)	Dwell Time	PASS	
15.247(a)(1)	Bandwidth	PASS	
15.205	Band Edge Emission	PASS	
15.203	Antenna Requirement	PASS	

Remark:

1. "N/A" denotes test is not applicable in this Test Report.
2. All test items were verified and recorded according to the standards and without any deviation during the test.

3 FACILITIES AND ACCREDITATIONS

3.1 FACILITIES

All measurement facilities used to collect the measurement data are located at 1/F, Building E, Fenda Science Park, Sanwei Community, Xixiang Street, Bao'an District, Shenzhen P.R. China.

The sites are constructed in conformance with the requirements of ANSI C63.7, ANSI C63.10 and CISPR Publication 22.

3.2 LABORATORY ACCREDITATIONS AND LISTINGS

Site Description

EMC Lab. : Accredited by CNAS, 2014.09.04
 The certificate is valid until 2017.09.03
 The Laboratory has been assessed and proved to be in compliance with CNAS-CL01:2006 (identical to ISO/IEC 17025:2005)
 The Certificate Registration Number is L5516.

Accredited by FCC, September 6, 2013
 The Certificate Registration Number is 238937.

Accredited by Industry Canada, August 29, 2012
 The Certificate Registration Number is 9270A-1.

Name of Firm : NTEK Testing Technology Co., Ltd
 Site Location : 1/F, Building E, Fenda Science Park, Sanwei Community, Xixiang Street, Bao'an District, Shenzhen P.R. China.

3.3 MEASUREMENT UNCERTAINTY

The reported uncertainty of measurement $y \pm U$, where expanded uncertainty U is based on a standard uncertainty multiplied by a coverage factor of $k=2$, providing a level of confidence of approximately 95 %.

No.	Item	Uncertainty
1	Conducted Emission Test	$\pm 1.38\text{dB}$
2	RF power, conducted	$\pm 0.16\text{dB}$
3	Spurious emissions, conducted	$\pm 0.21\text{dB}$
4	All emissions, radiated(<1G)	$\pm 4.68\text{dB}$
5	All emissions, radiated(>1G)	$\pm 4.89\text{dB}$
6	Temperature	$\pm 0.5^\circ\text{C}$
7	Humidity	$\pm 2\%$

4 GENERAL DESCRIPTION OF EUT

Product Feature and Specification	
Equipment	Wi-Fi&Bluetooth Speaker with Amazon Alexa Voice Control
Trade Mark	NAXA
FCC ID	OKUCAW37051
Model No.	NAS-5000
Serial Model	CAW-37051
Model Difference	All the model are the same circuit and RF module, except the model No..
Operating Frequency	2402MHz~2480MHz
Modulation	GFSK,π/4-DQPSK, 8DPSK
Bluetooth Version	BT V3.0(BR+EDR)
Number of Channels	79 Channels
Antenna Type	PCB Antenna
Antenna Gain	1 dBi
Rating(s)	DC 3.7V from battery or DC 5V from USB Port
Power supply	<input checked="" type="checkbox"/> DC supply: DC 3.7V/2000mAh
	<input type="checkbox"/> Adapter supply:
HW Version	V1.0
SW Version	V1.0

Note: Based on the application, features, or specification exhibited in User's Manual, the EUT is considered as an ITE/Computing Device. More details of EUT technical specification, please refer to the User's Manual.

Revision History

Report No.	Version	Description	Issued Date
NTEK-2017NT02101410F1	Rev.01	Initial issue of report	Mar 06, 2017

5 DESCRIPTION OF TEST MODES

To investigate the maximum EMI emission characteristics generates from EUT, the test system was pre-scanning tested base on the consideration of following EUT operation mode or test configuration mode which possible have effect on EMI emission level. Each of these EUT operation mode(s) or test configuration mode(s) mentioned above was evaluated respectively.

The Transmitter was operated in the normal operating mode. The TX frequency was fixed which was for the purpose of the measurements.

Test of channel included the lowest and middle and highest frequency to perform the test, then record on this report.

Those data rates (1Mbps for GFSK modulation; 2Mbps for $\pi/4$ -DQPSK modulation; 3Mbps for 8DPSK modulation) were used for all test.

The EUT was pretested with 3 orientations placed on the table for the radiated emission measurement –X, Y, and Z-plane. The X-plane results were found as the worst case and were shown in this report.

Carrier Frequency and Channel list:

Channel	Frequency(MHz)
0	2402
1	2403
...	...
39	2441
40	2442
...	...
77	2479
78	2480

Note: $f_c=2402\text{MHz}+k \times 1\text{MHz}$ $k=0$ to 78

The following summary table is showing all test modes to demonstrate in compliance with the standard.

For AC Conducted Emission	
Final Test Mode	Description
Mode 1	normal link mode

Note: AC power line Conducted Emission was tested under maximum output power.

For Radiated Test Cases	
Final Test Mode	Description
Mode 1	normal link mode
Mode 2	CH00(2402MHz)
Mode 3	CH39(2441MHz)
Mode 4	CH78(2480MHz)

Note: For radiated test cases, the worst mode data rate 1Mbps was reported only, because this data rate has the highest RF output power at preliminary tests, and no other significantly frequencies found in conducted spurious emission.

For Conducted Test Cases	
Final Test Mode	Description
Mode 2	CH00(2402MHz)
Mode 3	CH39(2441MHz)
Mode 4	CH78(2480MHz)
Mode 5	Hopping mode

Note: The engineering test program was provided and the EUT was programmed to be in continuously transmitting mode.

1. EUT built-in battery-powered, fully-charged battery use of the test battery

6 SETUP OF EQUIPMENT UNDER TEST

6.1 BLOCK DIAGRAM CONFIGURATION OF TEST SYSTEM

For AC Conducted Emission Mode

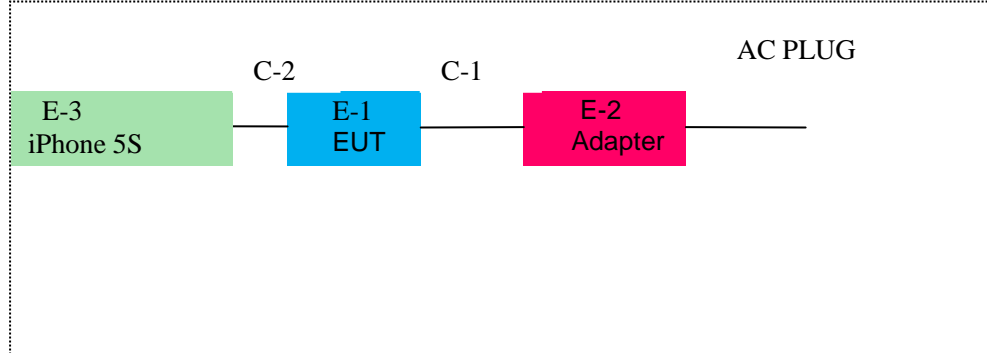

For Radiated Test Cases

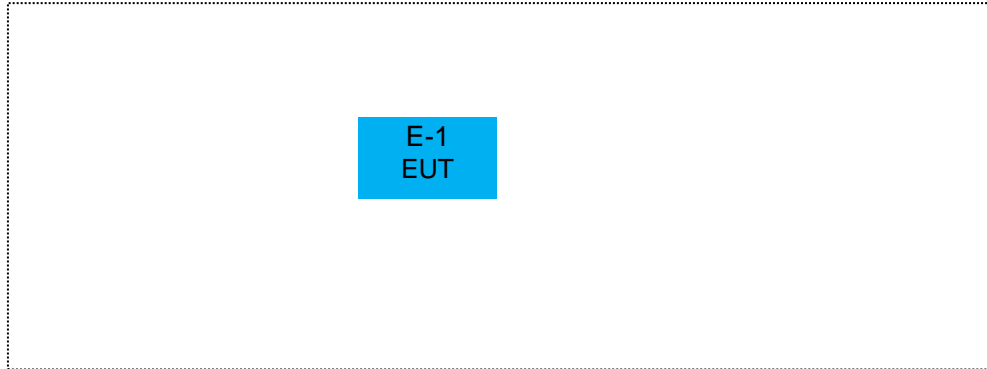

For Conducted Test Cases

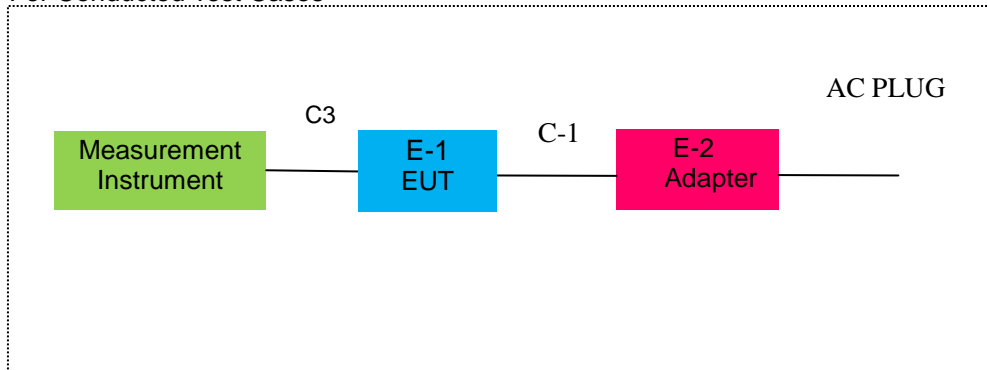

Note: The temporary antenna connector is soldered on the PCB board in order to perform conducted tests and this temporary antenna connector is listed in the equipment list.

6.2 SUPPORT EQUIPMENT

The EUT has been tested as an independent unit together with other necessary accessories or support units. The following support units or accessories were used to form a representative test configuration during the tests.

Item	Equipment	Mfr/Brand	Model/Type No.	FCC ID	Note
E-1	Wi-Fi&Bluetooth Speaker with Amazon Alexa Voice Control	NAXA	NAS-5000	OKUCAW37051	EUT
E-2	Adapter	N/A	ADAPAQ11050020006	N/A	Peripherals
E-3	iPhone 5S	Apple	A1518	N/A	

Item	Cable Type	Shielded Type	Ferrite Core	Length
C-1	USB Cable	NO	NO	1.2m
C-2	USB Cable	NO	NO	1.2m
c-3	RF Cable	NO	NO	0.5m

Notes:

- (1) The support equipment was authorized by Declaration of Confirmation.
- (2) For detachable type I/O cable should be specified the length in cm in 『Length』 column.
- (3) “YES” is means “shielded” “with core”; “NO” is means “unshielded” “without core”.

6.3 EQUIPMENTS LIST FOR ALL TEST ITEMS

Radiation Test equipment

Item	Kind of Equipment	Manufacturer	Type No.	Serial No.	Last calibration	Calibrated until	Calibration period
1	Spectrum Analyzer	Agilent	E4407B	MY45108040	2016.07.06	2017.07.05	1 year
2	Spectrum Analyzer	Agilent	N9020A	MY49100060	2016.11.19	2017.11.18	1 year
3	Test Receiver	R&S	ESPI	101318	2016.06.07	2017.06.06	1 year
4	Bilog Antenna	TESEQ	CBL6111D	31216	2016.07.06	2017.07.05	1 year
5	50Ω Coaxial Switch	Anritsu	MP59B	6200264416	2016.06.07	2017.06.06	1 year
7	Horn Antenna	EM	EM-AH-10180	2011071402	2016.07.06	2017.07.05	1 year
8	Horn Ant	Schwarzbeck	BBHA 9170	9170-181	2016.07.06	2017.07.05	1 year
9	Pre-Amplifier	EMC	EMC051835SE	980246	2016.08.09	2017.08.09	1 year
10	Loop Antenna	ARA	PLA-1030/B	1029	2016.06.08	2017.06.07	1 year
11	Test Cable (9KHz-30MHz)	N/A	R-04	N/A	2016.06.06	2017.06.05	1 year
12	Test Cable (30MHz-1GHz)	N/A	R-01	N/A	2016.07.06	2017.07.05	1 year
13	Test Cable (1-18GHz)	N/A	R-02	N/A	2016.07.06	2017.07.05	1 year
14	High Test Cable(18G-40 GHz)	N/A	R-03	N/A	2016.06.06	2017.06.05	1 year
15	temporary antenna connector (Note)	NTS	R001	N/A	N/A	N/A	N/A

Note:

We will use the temporary antenna connector (soldered on the PCB board) When conducted test And this temporary antenna connector is listed within the instrument list

Conduction Test equipment

Item	Kind of Equipment	Manufacturer	Type No.	Serial No.	Last calibration	Calibrated until	Calibration period
1	Test Receiver	R&S	ESCI	101160	2016.06.06	2017.06.05	1 year
2	LISN	R&S	ENV216	101313	2016.08.24	2017.08.23	1 year
3	LISN	EMCO	3816/2	00042990	2016.08.24	2017.08.23	1 year
4	50Ω Coaxial Switch	Anritsu	MP59B	6200264417	2016.06.07	2017.06.06	1 year
7	Test Cable (9KHz-30MHz)	N/A	C01	N/A	2016.06.08	2017.06.07	1 year
8	Test Cable (9KHz-30MHz)	N/A	C02	N/A	2016.06.08	2017.06.07	1 year
9	Test Cable (9KHz-30MHz)	N/A	C03	N/A	2016.06.08	2017.06.07	1 year

Note: Each piece of equipment is scheduled for calibration once a year.

7 TEST REQUIREMENTS

7.1 CONDUCTED EMISSIONS TEST

7.1.1 Applicable Standard

According to FCC Part 15.207(a) and KDB 174176 D01 Line Conducted FAQ v01r01

7.1.2 Conformance Limit

Frequency(MHz)	Conducted Emission Limit	
	Quasi-peak	Average
0.15-0.5	66-56*	56-46*
0.5-5.0	56	46
5.0-30.0	60	50

Note: 1. *Decreases with the logarithm of the frequency
 2. The lower limit shall apply at the transition frequencies
 3. The limit decreases in line with the logarithm of the frequency in the range of 0.15 to 0.50MHz.

7.1.3 Test Configuration

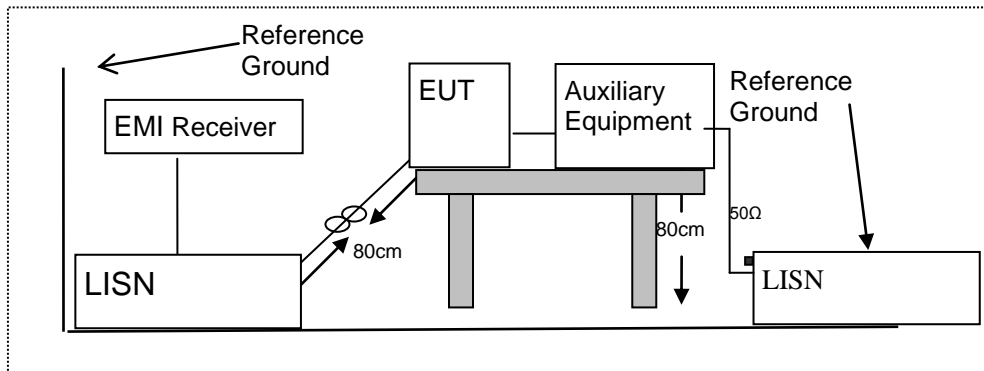

7.1.4 Test Procedure

According to the requirements in Section 13.1.4.1 of ANSI C63.10-2013 Conducted emissions the EUT measured in the frequency range between 0.15 MHz and 30 MHz using CISPR Quasi-Peak and average detector mode.

1. The EUT was placed 0.4 meter from the conducting wall of the shielding room.
2. The EUT was placed on a table which is 0.8m above ground plane.
3. Connect EUT to the power mains through a line impedance stabilization network (LISN). All other support equipments powered from additional LISN(s). The LISN provide 50 Ohm/ 50uH of coupling impedance for the measuring instrument.
4. Interconnecting cables that hang closer than 40 cm to the ground plane shall be folded back and forth in the center forming a bundle 30 to 40cm long.
5. I/O cables that are not connected to a peripheral shall be bundled in the center. The end of the cable may be terminated, if required, using the correct terminating impedance. The overall length shall not exceed 1 m.
6. LISN at least 80 cm from nearest part of EUT chassis.
7. The frequency range from 150KHz to 30MHz was searched.
8. Set the test-receiver system to Peak Detect Function and specified bandwidth(IF bandwidth=9KHz) with Maximum Hold Mode
9. For the actual test configuration, please refer to the related Item –EUT Test Photos.

7.1.5 Test Results

Pass

7.1.6 Test Results

EUT:	Wi-Fi&Bluetooth Speaker with Amazon Alexa Voice Control	Model Name :	NAS-5000
Temperature:	26 °C	Relative Humidity:	54%
Pressure:	1010hPa	Phase :	L
Test Voltage :	DC 5V from USB Port AC 120V/60Hz	Test Mode:	Mode 1

Frequency (MHz)	Reading Level (dBμV)	Correct Factor (dB)	Measure-ment (dBμV)	Limits (dBμV)	Margin (dB)	Remark
0.462	40.84	9.88	50.72	56.66	-5.94	QP
0.462	33.34	9.88	43.22	46.66	-3.44	AVG
1.386	41.53	9.75	51.28	56	-4.72	QP
1.386	31.6	9.75	41.35	46	-4.65	AVG
2.31	40.07	9.76	49.83	56	-6.17	QP
2.31	28.49	9.76	38.25	46	-7.75	AVG
3.234	40.63	9.77	50.4	56	-5.6	QP
3.234	30.25	9.77	40.02	46	-5.98	AVG
4.1579	38.75	9.78	48.53	56	-7.47	QP
4.1579	31.24	9.78	41.02	46	-4.98	AVG
4.6219	37.97	9.8	47.77	56	-8.23	QP
4.6219	30.72	9.8	40.52	46	-5.48	AVG

Remark:

1. All readings are Quasi-Peak and Average values.
2. Factor = Insertion Loss + Cable Loss.

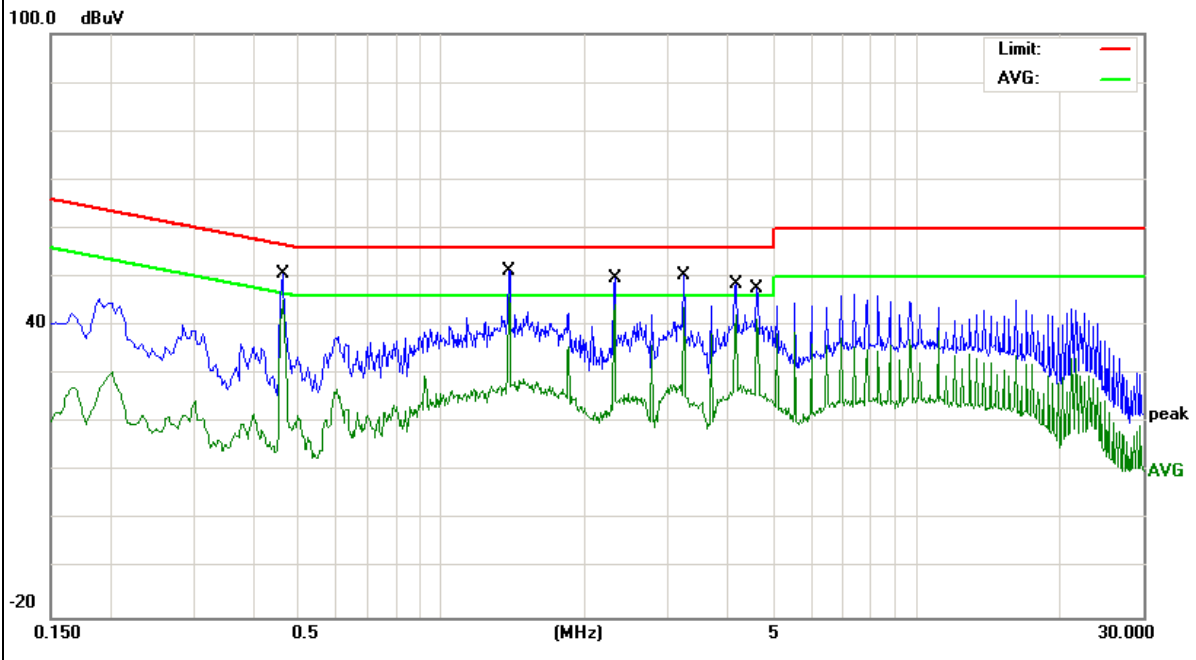

EUT:	Wi-Fi&Bluetooth Speaker with Amazon Alexa Voice Control	Model Name :	NAS-5000
Temperature:	26 °C	Relative Humidity:	54%
Pressure:	1010hPa	Phase :	N
Test Voltage :	DC 5V from USB Port AC 120V/60Hz	Test Mode:	Mode 1

Frequency (MHz)	Reading Level (dBµV)	Correct Factor (dB)	Measure-ment (dBµV)	Limits (dBµV)	Margin (dB)	Remark
0.19	37.53	10.12	47.65	64.03	-16.38	QP
0.19	29.93	10.12	40.05	54.03	-13.98	AVG
0.462	36.11	9.88	45.99	56.66	-10.67	QP
0.462	29.37	9.88	39.25	46.66	-7.41	AVG
1.386	35.85	9.75	45.6	56	-10.4	QP
1.386	30.35	9.75	40.1	46	-5.9	AVG
2.31	34.87	9.76	44.63	56	-11.37	QP
2.31	28.46	9.76	38.22	46	-7.78	AVG
3.2339	34.01	9.78	43.79	56	-12.21	QP
3.2339	26.58	9.78	36.36	46	-9.64	AVG
4.1619	33.26	9.79	43.05	56	-12.95	QP
4.1619	25.79	9.79	35.58	46	-10.42	AVG

Remark:

1. All readings are Quasi-Peak and Average values.
2. Factor = Insertion Loss + Cable Loss.

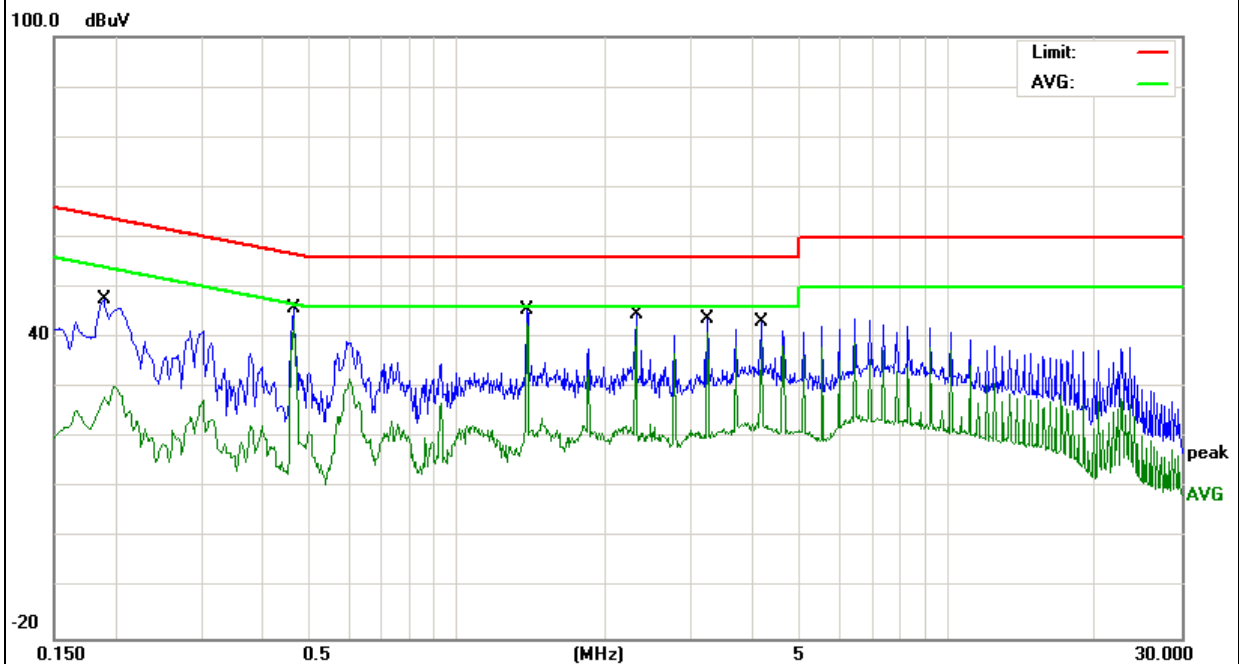

EUT:	Wi-Fi&Bluetooth Speaker with Amazon Alexa Voice Control	Model Name :	NAS-5000
Temperature:	26 °C	Relative Humidity:	54%
Pressure:	1010hPa	Phase :	L
Test Voltage :	DC 5V from USB Port AC 240V/60Hz	Test Mode:	Mode 1

Frequency (MHz)	Reading Level (dBμV)	Correct Factor (dB)	Measure-ment (dBμV)	Limits (dBμV)	Margin (dB)	Remark
0.462	41.6	9.88	51.48	56.66	-5.18	QP
0.462	30.34	9.88	40.22	46.66	-6.44	AVG
1.382	41.28	9.75	51.03	56	-4.97	QP
1.382	30.27	9.75	40.02	46	-5.98	AVG
2.306	41.59	9.76	51.35	56	-4.65	QP
2.306	32.35	9.76	42.11	46	-3.89	AVG
2.762	34.28	9.77	44.05	56	-11.95	QP
2.762	23.25	9.77	33.02	46	-12.98	AVG
4.1499	34.77	9.78	44.55	56	-11.45	QP
4.1499	24.37	9.78	34.15	46	-11.85	AVG
8.2979	36.52	9.85	46.37	60	-13.63	QP
8.2979	26.26	9.85	36.11	50	-13.89	AVG

Remark:

1. All readings are Quasi-Peak and Average values.
2. Factor = Insertion Loss + Cable Loss.

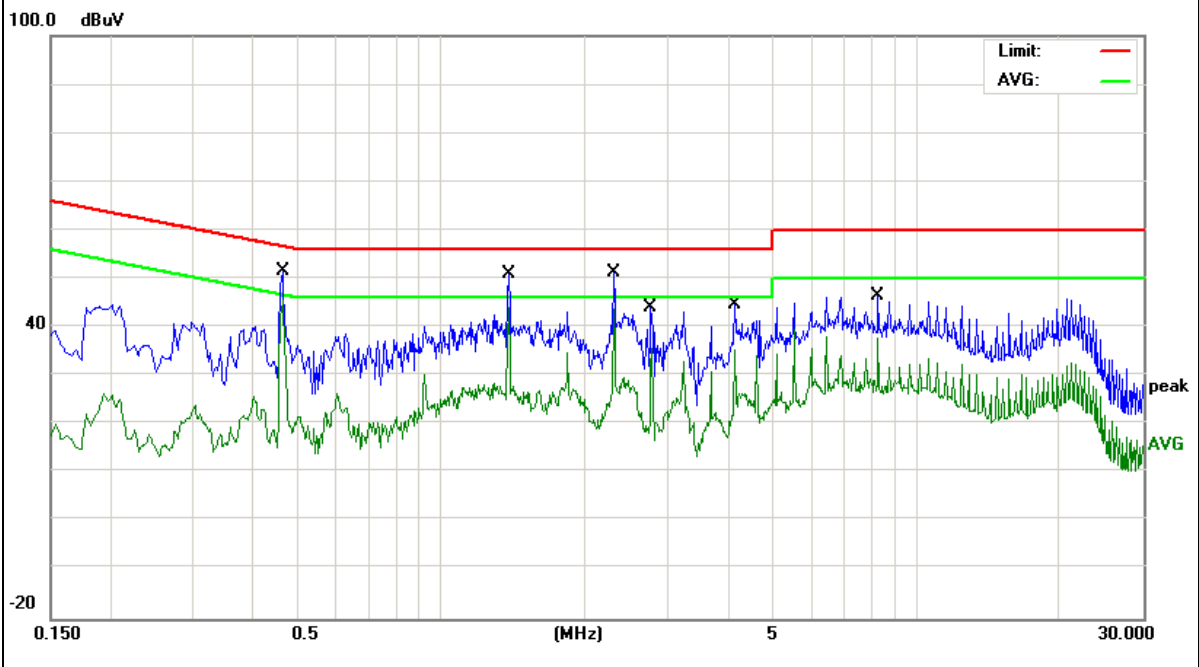

EUT:	Wi-Fi&Bluetooth Speaker with Amazon Alexa Voice Control	Model Name :	NAS-5000
Temperature:	26 °C	Relative Humidity:	54%
Pressure:	1010hPa	Phase :	N
Test Voltage :	DC 5V from USB Port AC 240V/60Hz	Test Mode:	Mode 1

Frequency (MHz)	Reading Level (dBμV)	Correct Factor (dB)	Measure-ment (dBμV)	Limits (dBμV)	Margin (dB)	Remark
0.462	36.22	9.88	46.1	56.66	-10.56	QP
0.462	27.7	9.88	37.58	46.66	-9.08	AVG
0.598	33.49	9.81	43.3	56	-12.7	QP
0.598	25.31	9.81	35.12	46	-10.88	AVG
1.382	35.05	9.75	44.8	56	-11.2	QP
1.382	26.7	9.75	36.45	46	-9.55	AVG
2.302	36.42	9.76	46.18	56	-9.82	QP
2.302	27.35	9.76	37.11	46	-8.89	AVG
3.226	33.43	9.78	43.21	56	-12.79	QP
3.226	28.47	9.78	38.25	46	-7.75	AVG
8.2858	35.89	9.86	45.75	60	-14.25	QP
8.2858	27.58	9.86	37.44	50	-12.56	AVG

Remark:

1. All readings are Quasi-Peak and Average values.
2. Factor = Insertion Loss + Cable Loss.

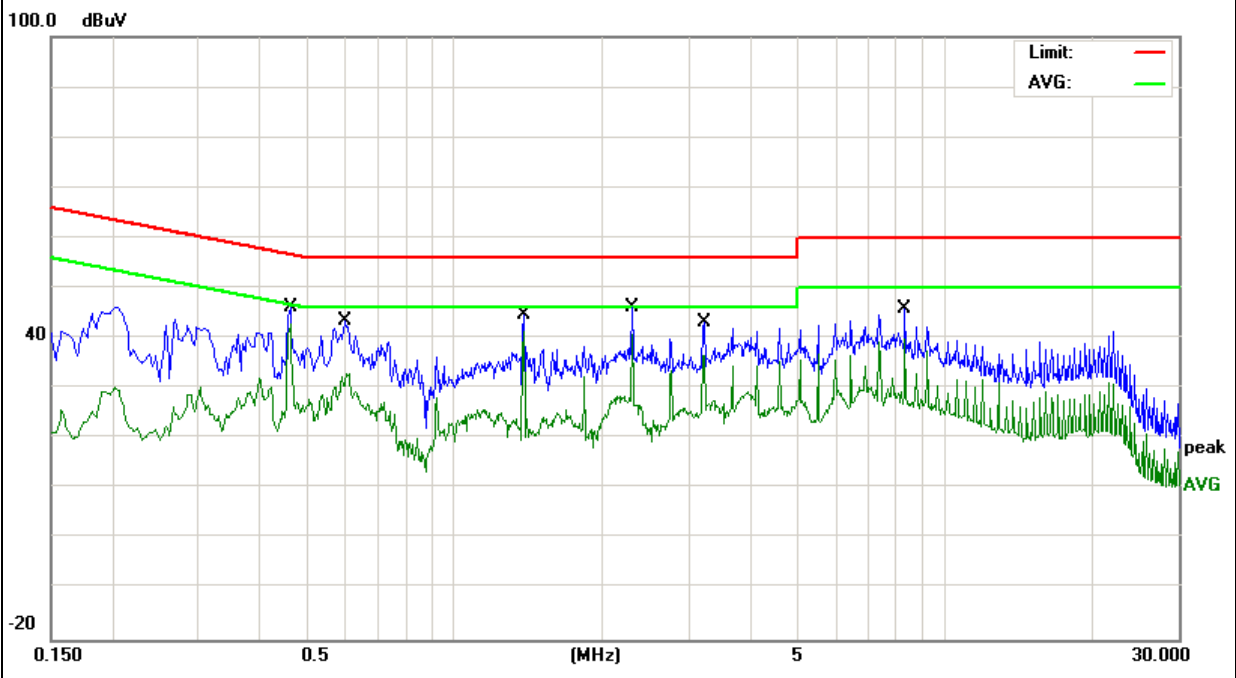

7.2 RADIATED SPURIOUS EMISSION

7.2.1 Applicable Standard

According to FCC Part 15.247(d) and 15.209 and ANSI C63.10-2013

7.2.2 Conformance Limit

According to FCC Part 15.247(d): radiated emissions which fall in the restricted bands, as defined in §15.205(a), must also comply with the radiated emission limits specified in §15.209(a) (see §15.205(c)). According to FCC Part 15.205, Restricted bands

MHz	MHz	MHz	GHz
0.090-0.110	16.42-16.423	399.9-410	4.5-5.15
10.495-0.505	16.69475-16.69525	608-614	5.35-5.46
2.1735-2.1905	16.80425-16.80475	960-1240	7.25-7.75
4.125-4.128	25.5-25.67	1300-1427	8.025-8.5
4.17725-4.17775	37.5-38.25	1435-1626.5	9.0-9.2
4.20725-4.20775	73-74.6	1645.5-1646.5	9.3-9.5
6.215-6.218	74.8-75.2	1660-1710	10.6-12.7
6.26775-6.26825	123-138	2200-2300	14.47-14.5
8.291-8.294	149.9-150.05	2310-2390	15.35-16.2
8.362-8.366	156.52475-156.52525	2483.5-2500	17.7-21.4
8.37625-8.38675	156.7-156.9	2690-2900	22.01-23.12
8.41425-8.41475	162.0125-167.17	3260-3267	23.6-24.0
12.29-12.293	167.72-173.2	3332-3339	31.2-31.8
12.51975-12.52025	240-285	3345.8-3358	36.43-36.5
12.57675-12.57725	322-335.4	3600-4400	(2)
13.36-13.41			

20dBc in any 100 kHz bandwidth outside the operating frequency band. In case the emission fall within the restricted band specified on 15.205(a), then the 15.209(a) limit in the table below has to be followed.

Restricted Frequency(MHz)	Field Strength (µV/m)	Field Strength (dBµV/m)	Measurement Distance
0.009~0.490	2400/F(KHz)	20 log (uV/m)	300
0.490~1.705	2400/F(KHz)	20 log (uV/m)	30
1.705~30.0	30	29.5	30
30-88	100	40	3
88-216	150	43.5	3
216-960	200	46	3
Above 960	500	54	3

Limits of Radiated Emission Measurement(Above 1000MHz)

Frequency(MHz)	Class B (dBuV/m) (at 3M)	
	PEAK	AVERAGE
Above 1000	74	54

- Remark :
1. Emission level in dBuV/m=20 log (uV/m)
 2. Measurement was performed at an antenna to the closed point of EUT distance of meters.
 3. Distance extrapolation factor =40log(Specific distance/ test distance)(dB);
Limit line=Specific limits(dBuV) + distance extrapolation factor.

7.2.3 Measuring Instruments

The Measuring equipment is listed in the section 6.3 of this test report.

7.2.4 Test Configuration

(a) For radiated emissions below 30MHz

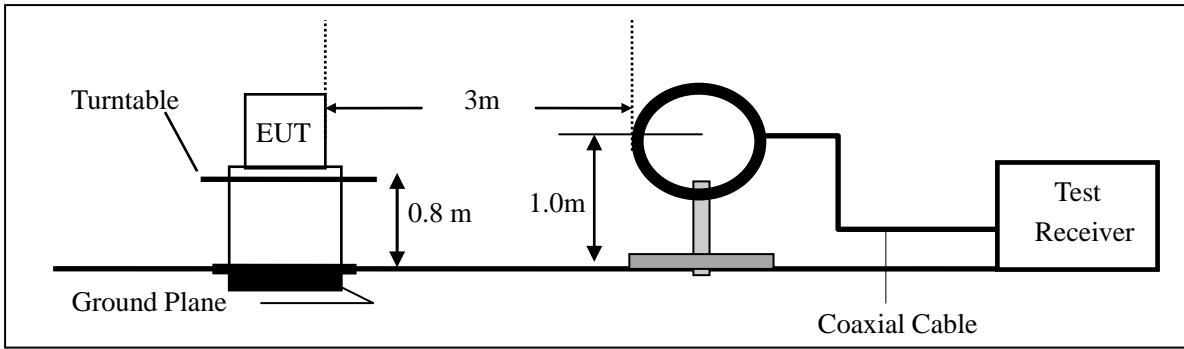

(b) For radiated emissions from 30MHz to 1000MHz

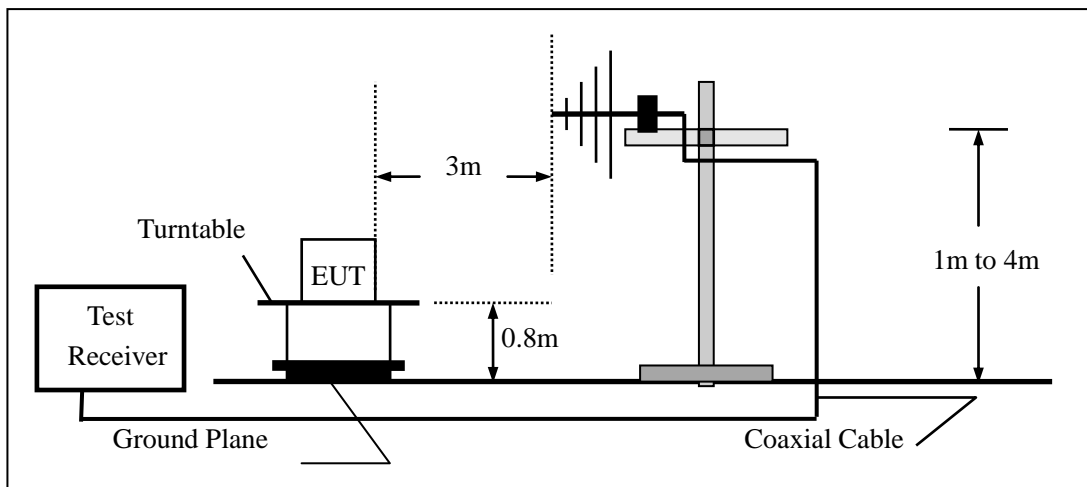

(c) For radiated emissions above 1000MHz

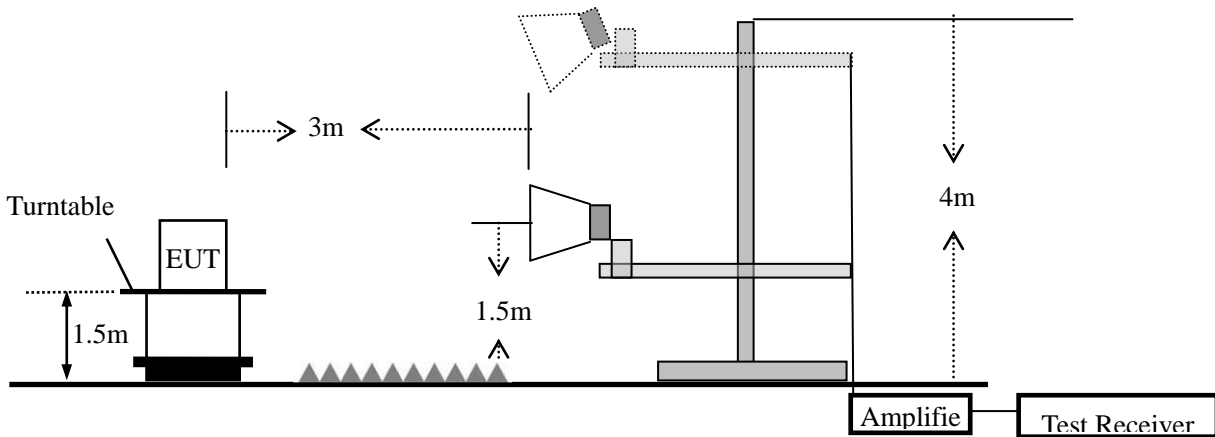

7.2.5 Test Procedure

The test site semi-anechoic chamber has met the requirement of NSA tolerance 4 dB according to the standards: ANSI C63.10-2013. The test distance is 3m. The setup is according to the requirements in Section 13.1.4.1 of ANSI C63.10-2013 and CAN/CSA-CEI/IEC CISPR 22.

This test is required for any spurious emission that falls in a Restricted Band, as defined in Section 15.205. It must be performed with the highest gain of each type of antenna proposed for use with the EUT.

Use the following spectrum analyzer settings:

Spectrum Parameter	Setting
Attenuation	Auto
Start Frequency	1000 MHz
Stop Frequency	10th carrier harmonic
RB / VB (emission in restricted band)	1 MHz / 1 MHz for Peak, 1 MHz / 10Hz for Average

Receiver Parameter	Setting
Attenuation	Auto
Start ~ Stop Frequency	9kHz~150kHz / RB 200Hz for QP
Start ~ Stop Frequency	150kHz~30MHz / RB 9kHz for QP
Start ~ Stop Frequency	30MHz~1000MHz / RB 120kHz for QP

- a. The measuring distance of at 3 m shall be used for measurements at frequency up to 1GHz. For frequencies above 1GHz, any suitable measuring distance may be used.
- b. The EUT was placed on the top of a rotating table 0.8 m for below 1GHz and 1.5m for above 1GHz the ground at a 3 meter. The table was rotated 360 degrees to determine the position of the highest radiation.
- c. The height of the equipment or of the substitution antenna shall be 0.8 m for below 1GHz and 1.5m for above 1GHz; the height of the test antenna shall vary between 1 m to 4 m. Both horizontal and vertical polarizations of the antenna are set to make the measurement.
- d. For the radiated emission test above 1GHz:
Place the measurement antenna away from each area of the EUT determined to be a source of emissions at the specified measurement distance, while keeping the measurement antenna aimed at the source of emissions at each frequency of significant emissions, with polarization oriented for maximum response. The measurement antenna may have to be higher or lower than the EUT, depending on the radiation pattern of the emission and staying aimed at the emission source for receiving the maximum signal. The final measurement antenna elevation shall be that which maximizes the emissions. The measurement antenna elevation for maximum emissions shall be restricted to a range of heights of from 1 m to 4 m above the ground or reference ground plane.
- e. The initial step in collecting conducted emission data is a spectrum analyzer peak detector mode pre-scanning the measurement frequency range. Significant peaks are then marked and then Quasi Peak detector mode re-measured.
- f. If the Peak Mode measured value compliance with and lower than Quasi Peak Mode Limit, the EUT shall be deemed to meet QP Limits and then no additional QP Mode measurement performed.
- g. For the actual test configuration, please refer to the related Item –EUT Test Photos.

Note:

Both horizontal and vertical antenna polarities were tested and performed pretest to three orthogonal axis. The worst case emissions were reported

During the radiated emission test, the Spectrum Analyzer was set with the following configurations:

Frequency Band (MHz)	Function	Resolution bandwidth	Video Bandwidth
30 to 1000	QP	120 kHz	300 kHz
Above 1000	Peak	1 MHz	1 MHz
	Average	1 MHz	10 Hz

Note: for the frequency ranges below 30 MHz, a narrower RBW is used for these ranges but the measured value should add a RBW correction factor (RBWCF) where $RBWCF [dB] = 10 * \lg(100 [kHz] / \text{narrower RBW [kHz]})$. , the narrower RBW is 1 kHz and RBWCF is 20 dB for the frequency 9 kHz to 150 kHz, and the narrower RBW is 10 kHz and RBWCF is 10 dB for the frequency 150 kHz to 30 MHz.

7.2.6 Test Results

■ Spurious Emission below 30MHz (9KHz to 30MHz)

EUT:	Wi-Fi&Bluetooth Speaker with Amazon Alexa Voice Control	Model No.:	NAS-5000
Temperature:	20 °C	Relative Humidity:	48%
Test Mode:	Mode2/Mode3/Mode4	Test By:	Allen Liu

Freq. (MHz)	Ant.Pol. H/V	Emission Level(dBuV/m)		Limit 3m(dBuV/m)		Over(dB)	
		PK	AV	PK	AV	PK	AV
--	--	--	--	--	--	--	--

Note: the amplitude of spurious emission that is attenuated by more than 20dB below the permissible limit has no need to be reported.

Distance extrapolation factor = $20 \log(\text{Specific distance} / \text{test distance})$ (dB);

Limit line = Specific limits(dBuV) + distance extrapolation factor

■ Spurious Emission below 1GHz (30MHz to 1GHz)

All the modulation modes have been tested, and the worst result was report as below:

EUT:	Wi-Fi&Bluetooth Speaker with Amazon Alexa Voice Control	Model Name :	NAS-5000
Temperature:	20 °C	Relative Humidity:	48%
Pressure:	1010hPa	Test Mode:	Mode 1
Test Voltage :	DC 3.7V		

Polar (H/V)	Frequency	Meter Reading	Factor	Emission Level	Limits	Margin	Remark
	(MHz)	(dBuV)	(dB)	(dBuV/m)	(dBuV/m)	(dB)	
V	35.2512	18.09	17.11	35.2	40	-4.8	QP
V	46.3402	26.2	10.49	36.69	40	-3.31	QP
V	94.0978	23.16	11.32	34.48	43.5	-9.02	QP
V	116.1321	24.51	13.39	37.9	43.5	-5.6	QP
V	158.1123	19.92	12.34	32.26	43.5	-11.24	QP
V	330.1949	19.51	17.2	36.71	46	-9.29	QP

Remark:

Absolute Level= ReadingLevel+ Factor, Margin= Absolute Level - Limit

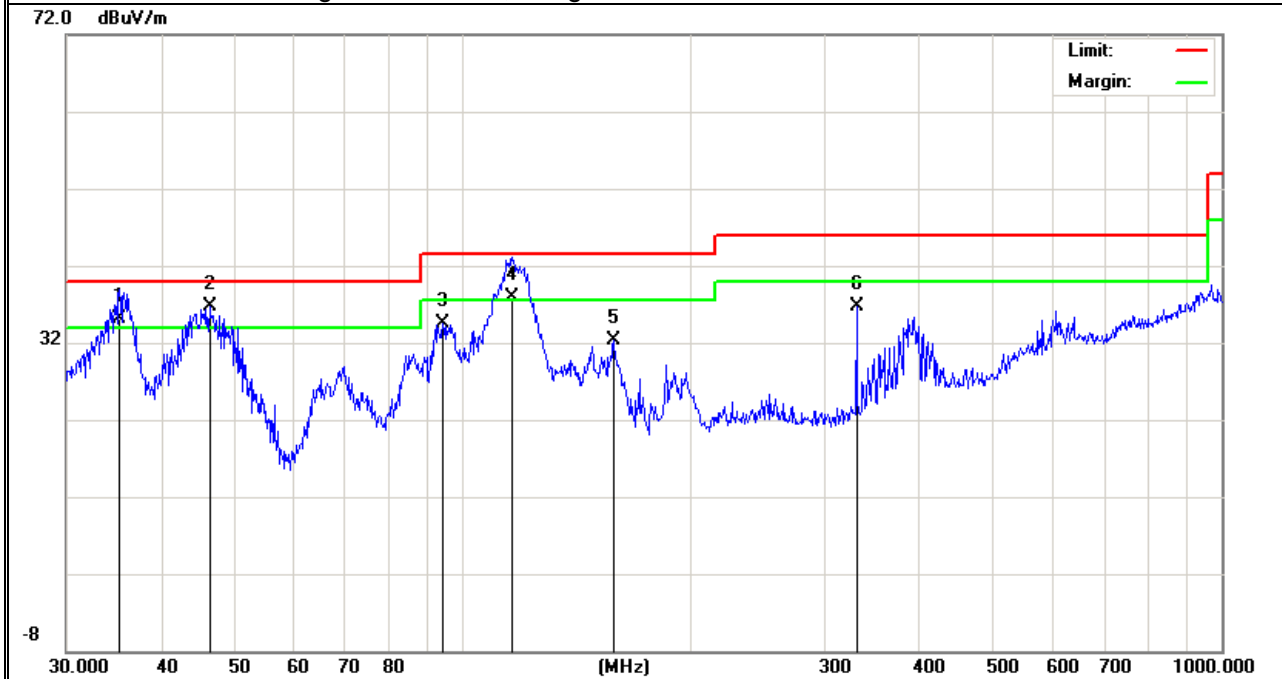

Polar (H/V)	Frequency	Meter Reading	Factor	Emission Level	Limits	Margin	Remark
	(MHz)	(dBuV)	(dB)	(dBuV/m)	(dBuV/m)	(dB)	
H	122.404	23.93	13.76	37.69	43.5	-5.81	QP
H	387.992	11.36	19.65	31.01	46	-14.99	QP
H	958.7943	7.81	31.35	39.16	46	-6.84	QP
H	104.9033	18.97	12.22	31.19	43.5	-12.31	QP
H	92.787	19.23	11.11	30.34	43.5	-13.16	QP
H	153.2004	20.78	12.78	33.56	43.5	-9.94	QP

Remark:

Absolute Level= ReadingLevel+ Factor, Margin= Absolute Level - Limit

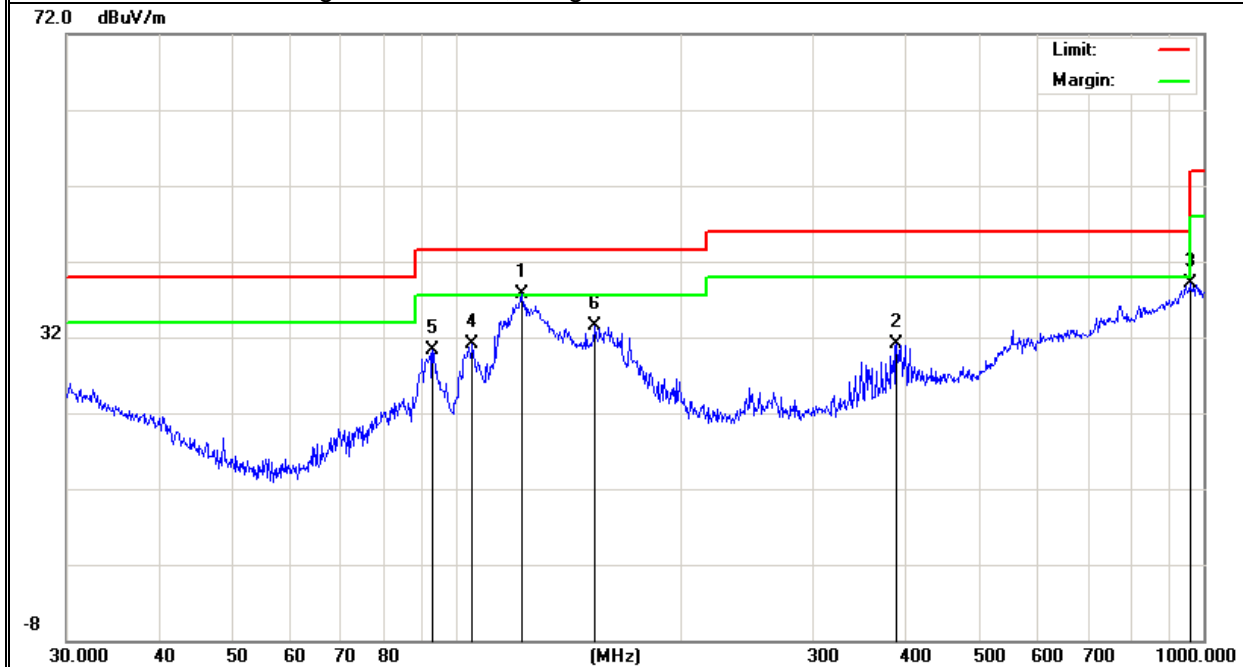

■ Spurious Emission Above 1GHz (1GHz to 25GHz)

EUT:	Wi-Fi&Bluetooth Speaker with Amazon Alexa Voice Control	Model No.:	NAS-5000
Temperature:	20 °C	Relative Humidity:	48%
Test Mode:	Mode2/Mode3/Mode4	Test By:	Allen Liu

All the modulation modes have been tested, and the worst result was report as below:

Frequency (MHz)	Read Level (dBµV)	Cable loss (dB)	Antenna Factor (dB/m)	Preamp Factor (dB)	Emission Level (dBµV/m)	Limits (dBµV/m)	Margin (dB)	Remark	Comment
Low Channel (2402 MHz)(GFSK)--Above 1G									
4804.113	64.33	5.21	35.59	44.30	60.83	74.00	-13.17	Pk	Vertical
4804.113	41.36	5.21	35.59	44.30	37.86	54.00	-16.14	AV	Vertical
7206.265	61.25	6.48	36.27	44.60	59.40	74.00	-14.60	Pk	Vertical
7206.265	42.05	6.48	36.27	44.60	40.20	54.00	-13.80	AV	Vertical
4804.512	63.36	5.21	35.55	44.30	59.82	74.00	-14.18	Pk	Horizontal
4804.512	45.33	5.21	35.55	44.30	41.79	54.00	-12.21	AV	Horizontal
7206.339	60.25	6.48	36.27	44.52	58.48	74.00	-15.52	Pk	Horizontal
7206.339	41.33	6.48	36.27	44.52	39.56	54.00	-14.44	AV	Horizontal
Mid Channel (2441 MHz)(GFSK)--Above 1G									
4882.147	63.25	5.21	35.66	44.20	59.92	74.00	-14.08	Pk	Vertical
4882.147	41.36	5.21	35.66	44.20	38.03	54.00	-15.97	AV	Vertical
7323.036	51.44	7.10	36.50	44.43	50.61	74.00	-23.39	Pk	Vertical
7323.036	41.25	7.10	36.50	44.43	40.42	54.00	-13.58	AV	Vertical
4882.159	58.33	5.21	35.66	44.20	55.00	74.00	-19.00	Pk	Horizontal
4882.159	49.33	5.21	35.66	44.20	46.00	54.00	-8.00	AV	Horizontal
7323.133	60.22	7.10	36.50	44.43	59.39	74.00	-14.61	Pk	Horizontal
7323.133	42.15	7.10	36.50	44.43	41.32	54.00	-12.68	AV	Horizontal
High Channel (2480 MHz)(GFSK)-- Above 1G									
4960.058	63.02	5.21	35.52	44.21	59.54	74.00	-14.46	Pk	Vertical
4960.058	43.64	5.21	35.52	44.21	40.16	54.00	-13.84	AV	Vertical
7440.187	60.33	7.10	36.53	44.60	59.36	74.00	-14.64	Pk	Vertical
7440.187	44.32	7.10	36.53	44.60	43.35	54.00	-10.65	AV	Vertical
4960.334	60.25	5.21	35.52	44.21	56.77	74.00	-17.23	Pk	Horizontal
4960.334	41.36	5.21	35.52	44.21	37.88	54.00	-16.12	AV	Horizontal
7440.247	58.25	7.10	36.53	44.60	57.28	74.00	-16.72	Pk	Horizontal
7440.247	41.34	7.10	36.53	44.60	40.37	54.00	-13.63	AV	Horizontal

Note: (1) All Readings are Peak Value (VBW=3MHz) and AV Value (VBW=10Hz).
 (2) Emission Level= Antenna Factor + Cable Loss + Read Level - Preamp Factor
 (3)All other emissions more than 20dB below the limit.

■ Spurious Emission in Band edge

EUT:	Wi-Fi&Bluetooth Speaker with Amazon Alexa Voice Control	Model No.:	NAS-5000
Temperature:	20 °C	Relative Humidity:	48%
Test Mode:	Mode2/ Mode4	Test By:	Allen Liu

All the modulation modes have been tested, and the worst result was report as below:

Frequency	Meter Reading	Cable Loss	Antenna Factor	Preamplifier Factor	Emission Level	Limits	Margin	Detector	Comment
(MHz)	(dBμV)	(dB)	dB/m	(dB)	(dBμV/m)	(dBμV/m)	(dB)	Type	
1Mbps (GFSK)-hopping									
2310.00	63.02	2.97	27.80	43.80	49.99	74	-24.01	Pk	Horizontal
2310.00	43.36	2.97	27.80	43.80	30.33	54	-23.67	AV	Horizontal
2310.00	61.45	2.97	27.80	43.80	48.42	74	-25.58	Pk	Vertical
2310.00	44.08	2.97	27.80	43.80	31.05	54	-22.95	AV	Vertical
2390.00	59.34	3.14	27.21	43.80	45.89	74	-28.11	Pk	Vertical
2390.00	43.26	3.14	27.21	43.80	29.81	54	-24.19	AV	Vertical
2390.00	61.54	3.14	27.21	43.80	48.09	74	-25.91	Pk	Horizontal
2390.00	41.25	3.14	27.21	43.80	27.80	54	-26.20	AV	Horizontal
2483.50	62.24	3.58	27.70	44.00	49.52	74	-24.48	Pk	Vertical
2483.50	44.02	3.58	27.70	44.00	31.30	54	-22.70	AV	Vertical
2483.50	61.02	3.58	27.70	44.00	48.30	74	-25.70	Pk	Horizontal
2483.50	41.36	3.58	27.70	44.00	28.64	54	-25.36	AV	Horizontal
1Mbps(GFSK)- Non-hopping									
2310.00	60.36	2.97	27.80	43.80	47.33	74	-26.67	Pk	Horizontal
2310.00	42.36	2.97	27.80	43.80	29.33	54	-24.67	AV	Horizontal
2310.00	59.32	2.97	27.80	43.80	46.29	74	-27.71	Pk	Vertical
2310.00	45.36	2.97	27.80	43.80	32.33	54	-21.67	AV	Vertical
2390.00	63.36	3.14	27.21	43.80	49.91	74	-24.09	Pk	Vertical
2390.00	45.57	3.14	27.21	43.80	32.12	54	-21.88	AV	Vertical
2390.00	54.66	3.14	27.21	43.80	41.21	74	-32.79	Pk	Horizontal
2390.00	45.22	3.14	27.21	43.80	31.77	54	-22.23	AV	Horizontal
2483.50	59.36	3.58	27.70	44.00	46.64	74	-27.36	Pk	Vertical
2483.50	47.25	3.58	27.70	44.00	34.53	54	-19.47	AV	Vertical
2483.50	61.34	3.58	27.70	44.00	48.62	74	-25.38	Pk	Horizontal
2483.50	43.38	3.58	27.70	44.00	30.66	54	-23.34	AV	Horizontal

Note: (1) All other emissions more than 20dB below the limit.

■ Spurious Emission in Restricted Band 3260MHz-18000MHz

EUT:	Wi-Fi&Bluetooth Speaker with Amazon Alexa Voice Control	Model No.:	NAS-5000
Temperature:	20 °C	Relative Humidity:	48%
Test Mode:	Mode2/ Mode4	Test By:	Allen Liu

All the modulation modes have been tested, and the worst result was report as below:

Frequency (MHz)	Reading Level (dBμV)	Cable Loss (dB)	Antenna (dB/m)	Preamp Factor (dB)	Emission Level (dBμV/m)	Limits (dBμV/m)	Margin (dB)	Detector Type	Comment
3260	60.15	4.04	29.57	44.70	49.06	74	-24.94	Pk	Vertical
3260	48.26	4.04	29.57	44.70	37.17	54	-16.83	AV	Vertical
3260	63.36	4.04	29.57	44.70	52.27	74	-21.73	Pk	Horizontal
3260	54.25	4.04	29.57	44.70	43.16	54	-10.84	AV	Horizontal
3332	64.36	4.26	29.87	44.40	54.09	74	-19.91	Pk	Vertical
3332	52.35	4.26	29.87	44.40	42.08	54	-11.92	AV	Vertical
3332	61.02	4.26	29.87	44.40	50.75	74	-23.25	Pk	Horizontal
3332	50.33	4.26	29.87	44.40	40.06	54	-13.94	AV	Horizontal
17797	41.25	10.99	43.95	43.50	52.69	74	-21.31	Pk	Vertical
17797	33.02	10.99	43.95	43.50	44.46	54	-9.54	AV	Vertical
17788	42.25	11.81	43.69	44.60	53.15	74	-20.85	Pk	Horizontal
17788	30.2	11.81	43.69	44.60	41.10	54	-12.90	AV	Horizontal

Note: (1) All other emissions more than 20dB below the limit.

7.3 NUMBER OF HOPPING CHANNEL

7.3.1 Applicable Standard

According to FCC Part 15.247(a)(1) (iii)and ANSI C63.10-2013

7.3.2 Conformance Limit

Frequency hopping systems in the 2400-2483.5MHz band shall use at least 15 channels.

7.3.3 Measuring Instruments

The Measuring equipment is listed in the section 6.3 of this test report.

7.3.4 Test Setup

Please refer to Section 6.1 of this test report.

7.3.5 Test Procedure

The testing follows ANSI C63.10-2013 clause 7.8.3
 The RF output of EUT was connected to the spectrum analyzer by RF cable and attenuator.
 The path loss was compensated to the results for each measurement.
 Set to the maximum power setting and enable the EUT transmit continuously.
 The EUT must have its hopping function enabled.
 Use the following spectrum analyzer settings:
 Span = the frequency band of operation
 RBW \geq 1% of the span
 VBW \geq RBW
 Sweep = auto
 Detector function = peak
 Trace = max hold

7.3.6 Test Results

EUT:	Wi-Fi&Bluetooth Speaker with Amazon Alexa Voice Control	Model No.:	NAS-5000
Temperature:	20 °C	Relative Humidity:	48%
Test Mode:	Mode 5(1Mbps)	Test By:	Allen Liu

Number of Hopping (Channel)	Adaptive Frequency hopping (Channel)	limit	Verdict
79	20	\geq 15	Pass

Number of Hopping Channel Plot

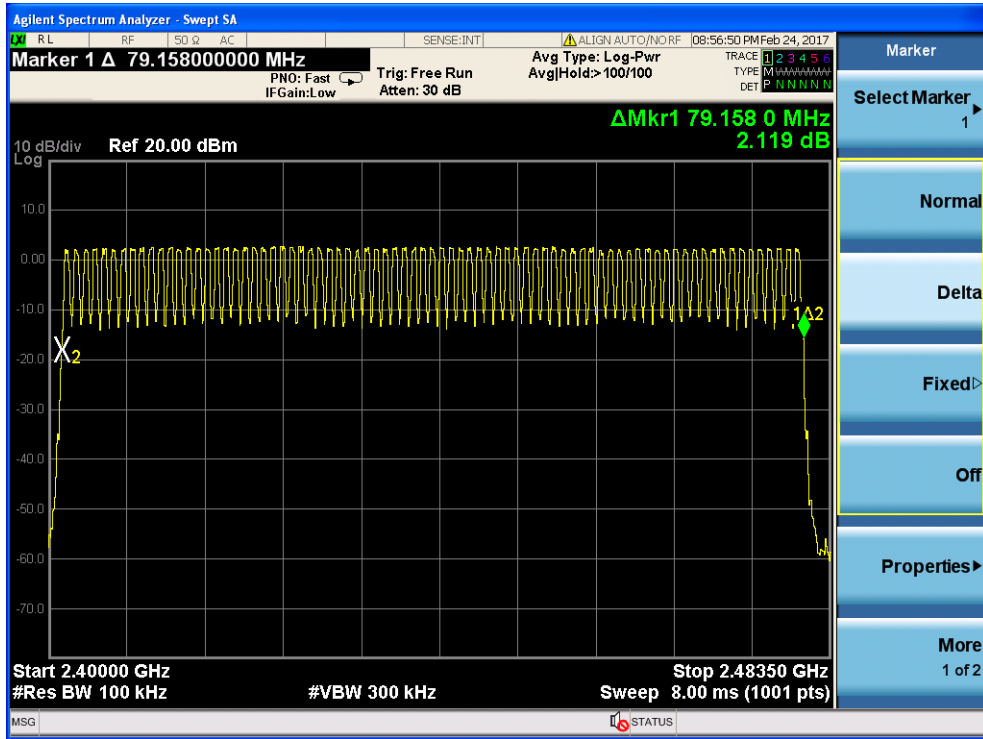

7.4 HOPPING CHANNEL SEPARATION MEASUREMENT

7.4.1 Applicable Standard

According to FCC Part 15.247(a)(1) and ANSI C63.10-2013

7.4.2 Conformance Limit

Frequency hopping systems operating in the 2400-2483.5MHz band shall have hopping channel carrier frequencies that are separated by 25kHz or two-thirds of the 20dB bandwidth of the hopping channel, whichever is greater.

7.4.3 Measuring Instruments

The Measuring equipment is listed in the section 6.3 of this test report.

7.4.4 Test Setup

Please refer to Section 6.1 of this test report.

7.4.5 Test Procedure

The testing follows ANSI C63.10-2013 clause 7.8.2

The RF output of EUT was connected to the spectrum analyzer by RF cable and attenuator.

The path loss was compensated to the results for each measurement.

Set to the maximum power setting and enable the EUT transmit continuously.

The EUT was operating in controlled its channel.

Use the following spectrum analyzer settings:

Span = Measurement Bandwidth or Channel Separation

RBW \geq 30KHz

VBW \geq 3*RBW

Sweep = auto

Detector function = peak

Trace = max hold

7.4.6 Test Results

EUT:	Wi-Fi&Bluetooth Speaker with Amazon Alexa Voice Control	Model No.:	NAS-5000
Temperature:	20 °C	Relative Humidity:	48%
Test Mode:	Mode2/Mode3/Mode4	Test By:	Allen Liu

Modulation Mode	Channel Number	Channel Frequency (MHz)	Measurement Bandwidth (MHz)	Limit (kHz)		Verdict
GFSK	0	2402	1	>933.3	20dB BW	PASS
	39	2441	1	>934.4	20dB BW	PASS
	78	2480	1	>935.5	20dB BW	PASS
π/4-DQPSK	0	2402	1	>839.333	2/3 of 20dB BW	PASS
	39	2441	1	>838.667	2/3 of 20dB BW	PASS
	78	2480	1	>838.667	2/3 of 20dB BW	PASS
8DPSK	0	2402	1	>844.667	2/3 of 20dB BW	PASS
	39	2441	1	>843.333	2/3 of 20dB BW	PASS
	78	2480	1	>843.333	2/3 of 20dB BW	PASS

Test Plot

(1Mbps) Channel Separation plot on channel 00-01



(2Mbps) Channel Separation plot on channel 00-01



(1Mbps) Channel Separation plot on channel 39-40

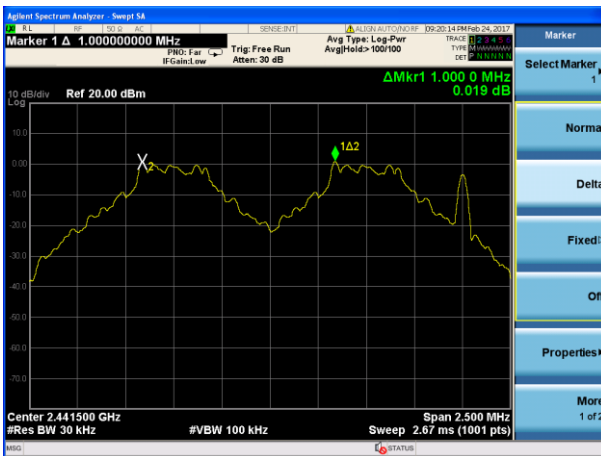

(2Mbps) Channel Separation plot on channel 39-40

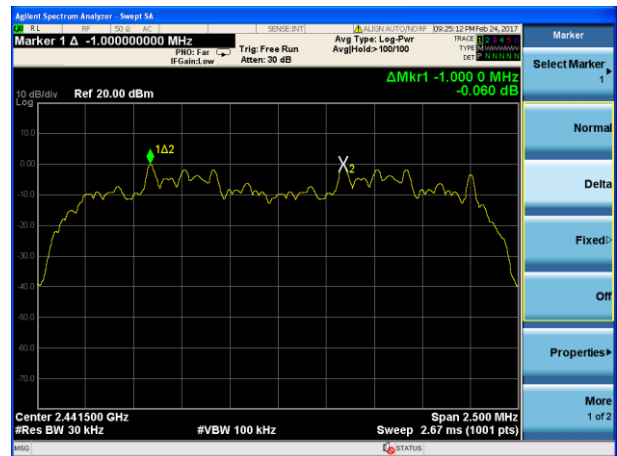

(1Mbps) Channel Separation plot on channel 77-78



(2Mbps) Channel Separation plot on channel 77-78



Test Plot

(3Mbps) Channel Separation plot on channel 00-01



(3Mbps) Channel Separation plot on channel 39-40

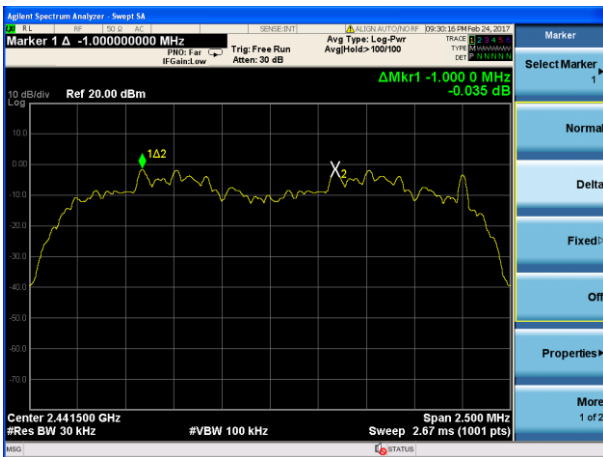

(3Mbps) Channel Separation plot on channel 77-78



7.5 AVERAGE TIME OF OCCUPANCY (DWELL TIME)

7.5.1 Applicable Standard

According to FCC Part 15.247(a)(1)(iii) and ANSI C63.10-2013

7.5.2 Conformance Limit

The average time of occupancy on any channel shall not be greater than 0.4s within a period of 0.4s multiplied by the number of hopping channels employed.

7.5.3 Measuring Instruments

The Measuring equipment is listed in the section 6.3 of this test report.

7.5.4 Test Setup

Please refer to Section 6.1 of this test report.

7.5.5 Test Procedure

The testing follows ANSI C63.10-2013 clause 7.8.4

The RF output of EUT was connected to the spectrum analyzer by RF cable and attenuator.

The path loss was compensated to the results for each measurement.

Set to the maximum power setting and enable the EUT transmit continuously.

The EUT must have its hopping function enabled.

Use the following spectrum analyzer settings:

Span = zero span, centered on a hopping channel

RBW \geq 1MHz

VBW \geq RBW

Sweep = as necessary to capture the entire dwell time per hopping channel

Detector function = peak

Trace = max hold

Measure the maximum time duration of one single pulse.

Set the EUT for DH5, DH3 and DH1 packet transmitting.

Measure the maximum time duration of one single pulse.

7.5.6 Test Results

EUT:	Wi-Fi&Bluetooth Speaker with Amazon Alexa Voice Control	Model No.:	NAS-5000
Temperature:	20 °C	Relative Humidity:	48%
Test Mode:	Mode3	Test By:	Allen Liu

Modulation Mode	Channel Number	Packet type	Mode	Hops Over Occupancy	Pulse width	dwell time (ms)	Limit	Verdict
				(ms)	(ms)		(ms)	
GFSK	39	DH1	Normal	320	0.408	130.560	<400	PASS
	39		AFH	160	0.408	65.280	<400	PASS
	39	DH3	Normal	160	1.664	266.240	<400	PASS
	39		AFH	80	1.664	133.120	<400	PASS
	39	DH5	Normal	106.67	2.904	309.770	<400	PASS
	39		AFH	53.33	2.904	154.870	<400	PASS
π/4-DQPSK	39	2DH1	Normal	320	0.408	130.560	<400	PASS
	39		AFH	160	0.408	65.280	<400	PASS
	39	2DH3	Normal	160	1.656	264.960	<400	PASS
	39		AFH	80	1.656	132.480	<400	PASS
	39	2DH5	Normal	106.67	2.912	310.623	<400	PASS
	39		AFH	53.33	2.912	155.297	<400	PASS
8DPSK	39	3DH1	Normal	320	0.4	128.000	<400	PASS
	39		AFH	160	0.4	64.000	<400	PASS
	39	3DH3	Normal	160	1.656	264.960	<400	PASS
	39		AFH	80	1.656	132.480	<400	PASS
	39	3DH5	Normal	106.67	2.92	311.476	<400	PASS
	39		AFH	53.33	2.92	155.724	<400	PASS

Note:

A Period Time = (channel number)*0.4

DH1 Time Slot: Reading * (1600/2)*31.6/(channel number)

DH3 Time Slot: Reading * (1600/4)*31.6/(channel number)

DH5 Time Slot: Reading * (1600/6)*31.6/(channel number)

For Example:

- In normal mode, hopping rate is 1600 hops/s with 6 slots in 79 hopping channels. With channel hopping rate (1600 / 6 / 79) in Occupancy Time Limit (0.4 x 79) (s), Hops Over Occupancy Time comes to (1600 / 6 / 79) x (0.4 x 79) = 106.67 hops.
- In AFH mode, hopping rate is 800 hops/s with 6 slots in 20 hopping channels. With channel hopping rate (800 / 6 / 20) in Occupancy Time Limit (0.4 x 20) (s), Hops Over Occupancy Time comes to (800 / 6 / 20) x (0.4 x 20) = 53.33 hops.
- Dwell Time(s) = Hops Over Occupancy Time (hops) x Package Transfer Time

Test Plot

Package Transfer Time Plot CH39-DH1

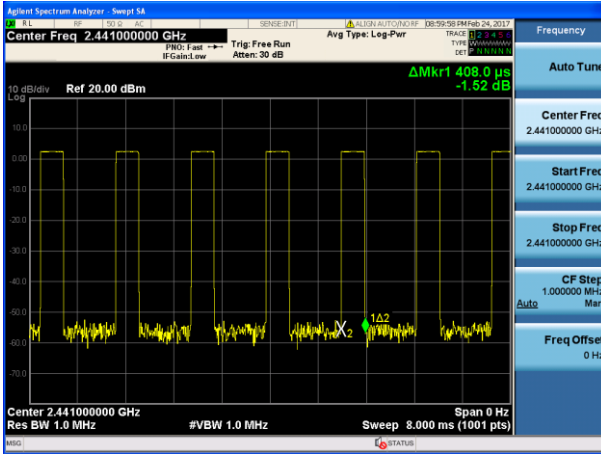

Package Transfer Time Plot CH39-2DH1

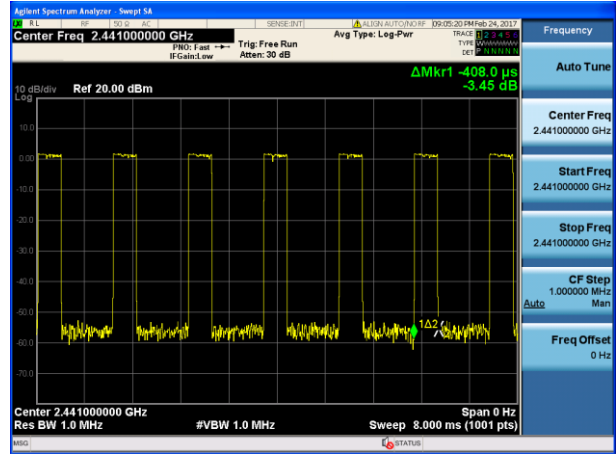

Package Transfer Time Plot CH39-DH3

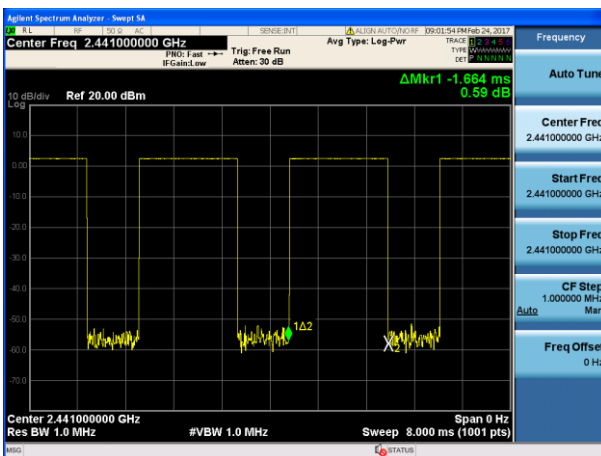

Package Transfer Time Plot CH39-2DH3

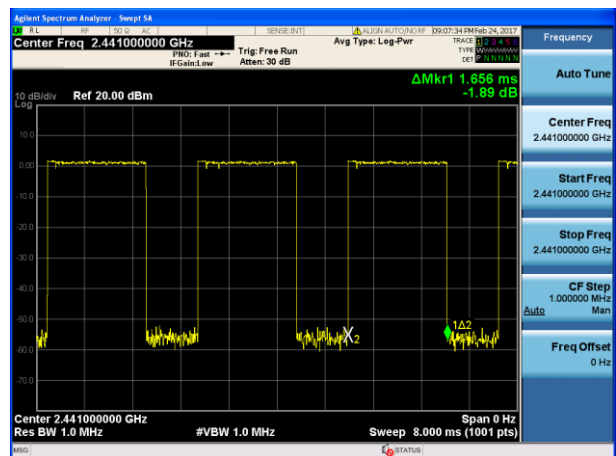

Package Transfer Time Plot CH39-DH5

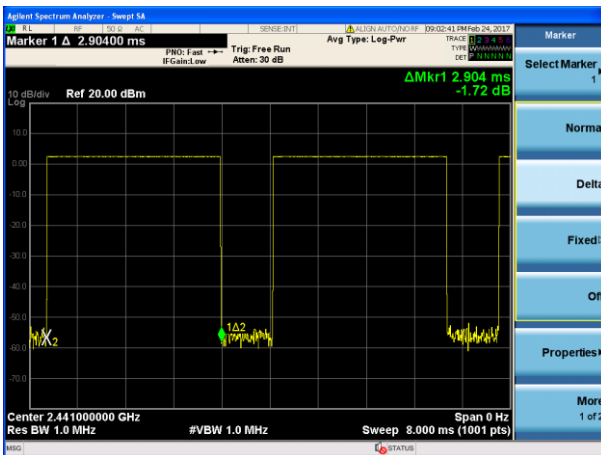

Package Transfer Time Plot CH39-2DH5

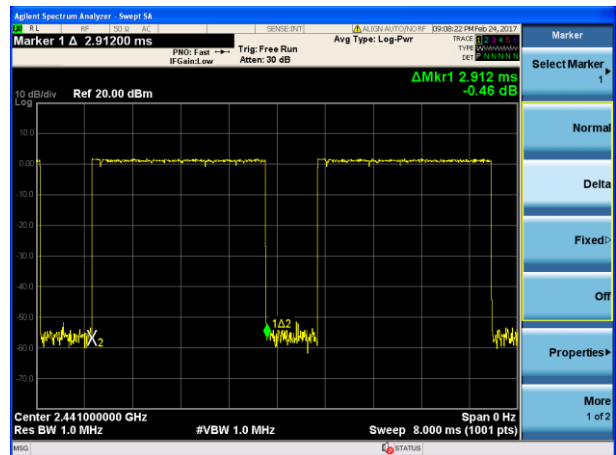

Test Plot

Package Transfer Time Plot CH39-3DH1

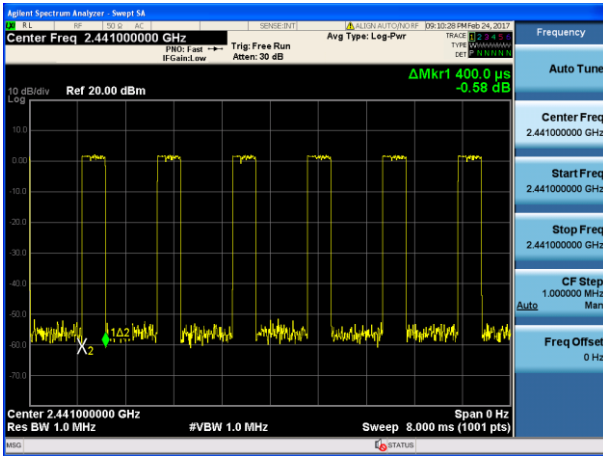

Package Transfer Time Plot CH39-3DH3

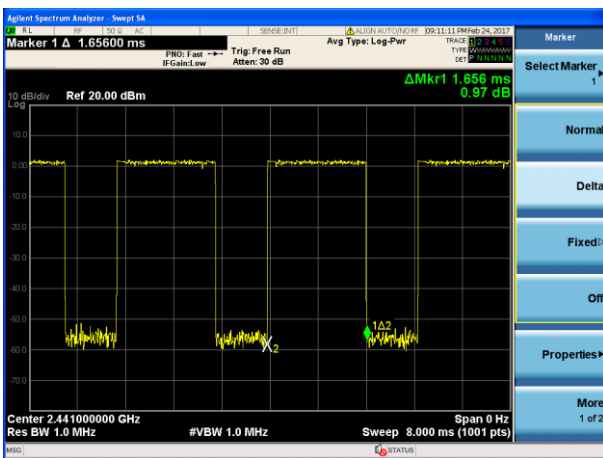

Package Transfer Time Plot CH39-3DH5

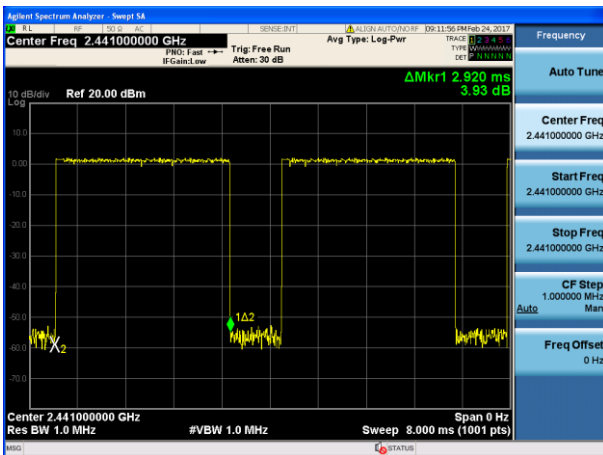

7.6 20DB BANDWIDTH TEST

7.6.1 Applicable Standard

According to FCC Part 15.247(a)(1) and ANSI C63.10-2013

7.6.2 Conformance Limit

No limit requirement.

7.6.3 Measuring Instruments

The Measuring equipment is listed in the section 6.3 of this test report.

7.6.4 Test Setup

Please refer to Section 6.1 of this test report.

7.6.5 Test Procedure

The testing follows ANSI C63.10-2013 clause 6.9.2

The RF output of EUT was connected to the spectrum analyzer by RF cable and attenuator.

The path loss was compensated to the results for each measurement.

Set to the maximum power setting and enable the EUT transmit continuously.

The EUT was operating in controlled its channel.

Use the following spectrum analyzer settings:

Span = approximately 2 to 3 times the 20 dB bandwidth, centered on a hopping channel

RBW \geq 1% of the 20 dB bandwidth

VBW \geq RBW

Sweep = auto

Detector function = peak

Trace = max hold

7.6.6 Test Results

EUT:	Wi-Fi&Bluetooth Speaker with Amazon Alexa Voice Control	Model No.:	NAS-5000
Temperature:	20 °C	Relative Humidity:	48%
Test Mode:	Mode2/Mode3/Mode4	Test By:	Allen Liu

Test Channel	Frequency	Measurement Bandwidth (KHz)	Limit	Verdict
	(MHz)		(kHz)	
1Mbps				
0	2402	933.3	N/A	PASS
39	2441	934.4	N/A	PASS
78	2480	935.5	N/A	PASS
2Mbps				
0	2402	1259	N/A	PASS
39	2441	1258	N/A	PASS
78	2480	1258	N/A	PASS
3Mbps				
0	2402	1267	N/A	PASS
39	2441	1265	N/A	PASS
78	2480	1265	N/A	PASS

Note: N/A (Not Applicable)

Test Plot

20dB Bandwidth plot on channel 00 (1Mbps)

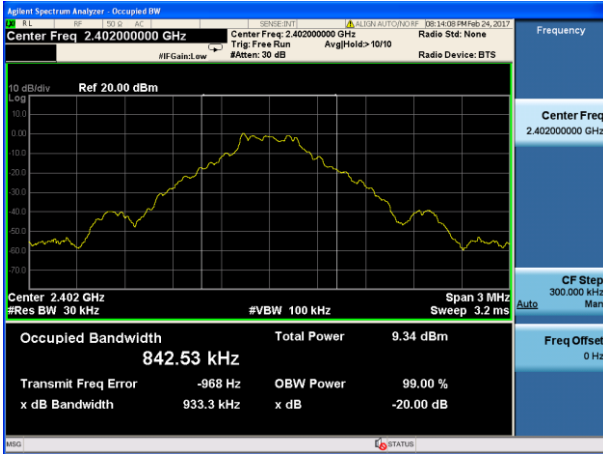

20dB Bandwidth plot on channel 00 (2Mbps)

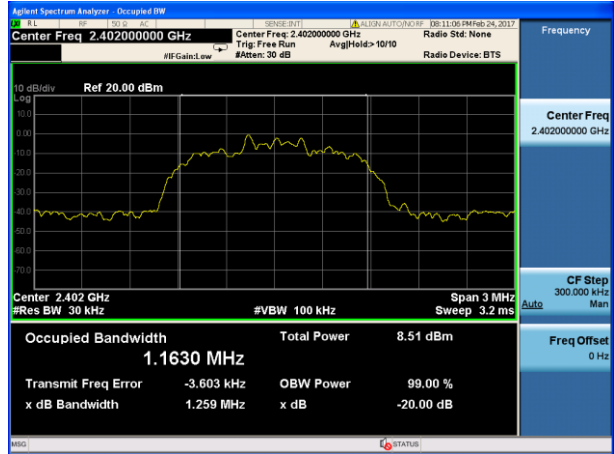

20dB Bandwidth plot on channel 39 (1Mbps)

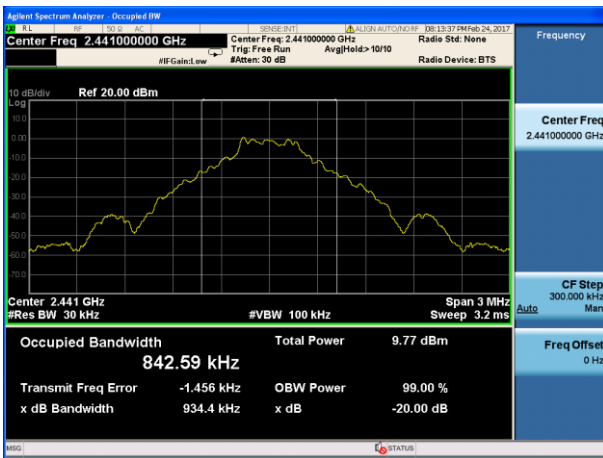

20dB Bandwidth plot on channel 39 (2Mbps)

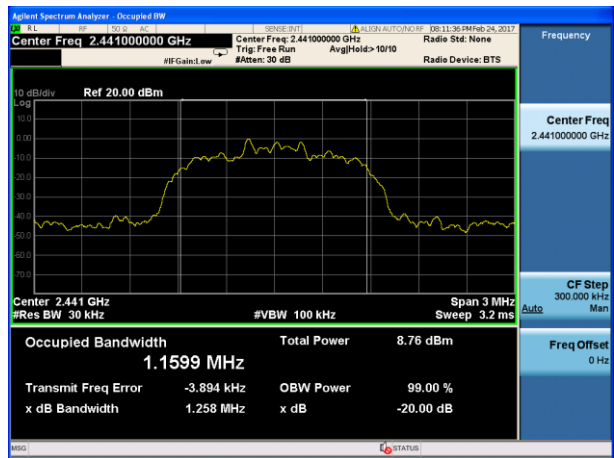

20dB Bandwidth plot on channel 78 (1Mbps)

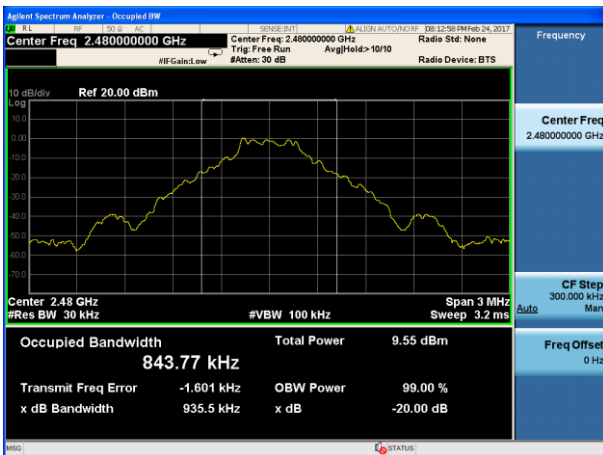

20dB Bandwidth plot on channel 78 (2Mbps)

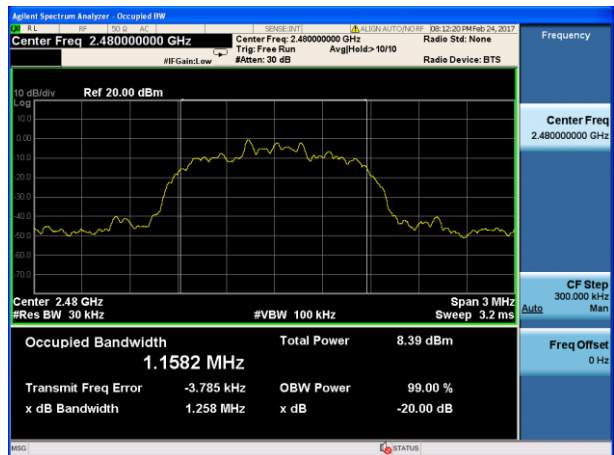

Test Plot

20dB Bandwidth plot on channel 00 (3Mbps)

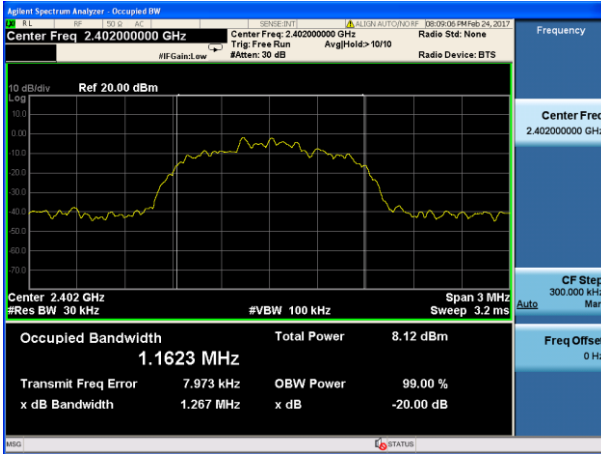

20dB Bandwidth plot on channel 39 (3Mbps)

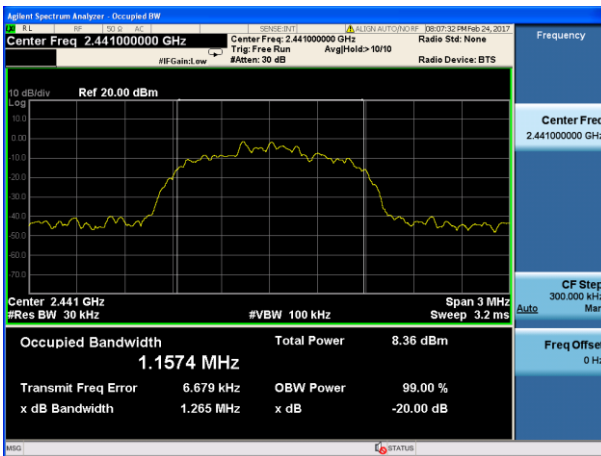

20dB Bandwidth plot on channel 78 (3Mbps)

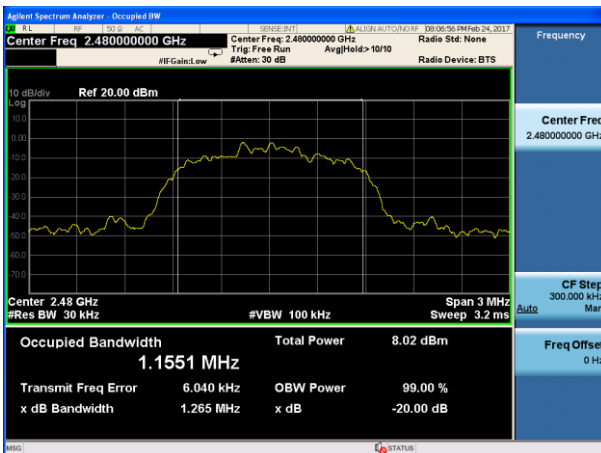

7.7 PEAK OUTPUT POWER

7.7.1 Applicable Standard

According to FCC Part 15.247(b)(1) and ANSI C63.10-2013

7.7.2 Conformance Limit

The maximum peak conducted output power of the intentional radiator shall not exceed the following: (1) For frequency hopping systems operating in the 2400-2483.5 MHz band employing at least 75 non-overlapping hopping channels, and all frequency hopping systems in the 5725-5850 MHz band: 1 watt. For all other frequency hopping systems in the 2400-2483.5 MHz band 0.125 watts.

7.7.3 Measuring Instruments

The Measuring equipment is listed in the section 6.3 of this test report.

7.7.4 Test Setup

Please refer to Section 6.1 of this test report.

7.7.5 Test Procedure

The testing follows ANSI C63.10-2013 clause 7.8.5.

The RF output of EUT was connected to the spectrum analyzer by RF cable and attenuator.

The path loss was compensated to the results for each measurement.

Set to the maximum power setting and enable the EUT transmit continuously.

The EUT was operating in controlled its channel.

Use the following spectrum analyzer settings:

Span = approximately 5 times the 20 dB bandwidth, centered on a hopping channel

RBW \geq the 20 dB bandwidth of the emission being measured

VBW \geq RBW

Sweep = auto

Detector function = peak

Trace = max hold

7.7.6 Test Results

EUT:	Wi-Fi&Bluetooth Speaker with Amazon Alexa Voice Control	Model No.:	NAS-5000
Temperature:	20 °C	Relative Humidity:	48%
Test Mode:	Mode2/Mode3/Mode4	Test By:	Allen Liu

Test Channel	Frequency	Power Setting	Peak Output Power	LIMIT	Verdict
	(MHz)		(dBm)	(dBm)	
1Mbps					
0	2402	Default	2.278	30	PASS
39	2441	Default	2.725	30	PASS
78	2480	Default	2.442	30	PASS
2Mbps					
0	2402	Default	1.812	20.97	PASS
39	2441	Default	2.198	20.97	PASS
78	2480	Default	1.928	20.97	PASS
3Mbps					
0	2402	Default	2.258	20.97	PASS
39	2441	Default	2.666	20.97	PASS
78	2480	Default	2.408	20.97	PASS

Test Plot

Peak output Power plot on channel 00 (1Mbps)

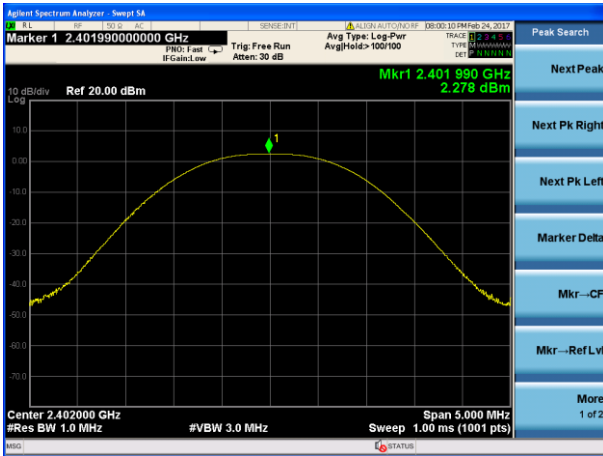

Peak output Power plot on channel 00 (2Mbps)

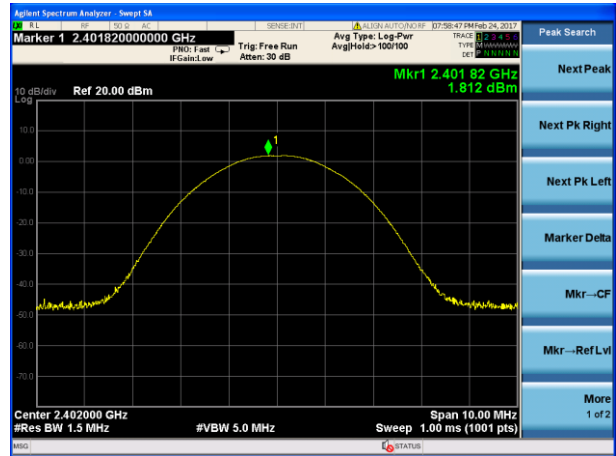

Peak output Power plot on channel 39 (1Mbps)

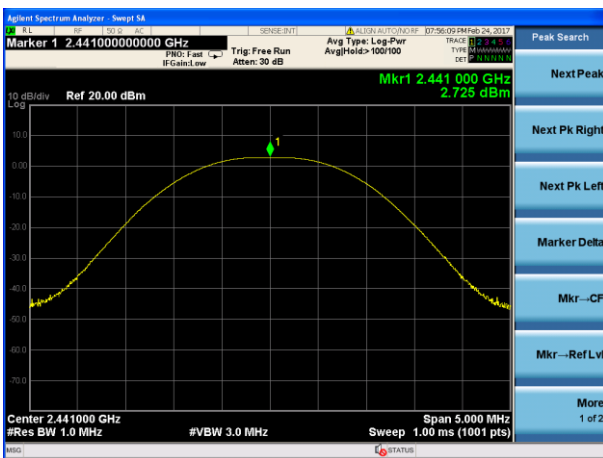

Peak output Power plot on channel 39 (2Mbps)

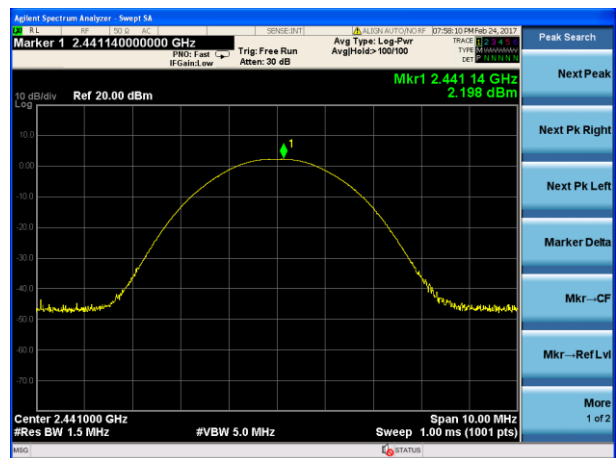

Peak output Power plot on channel 78 (1Mbps)

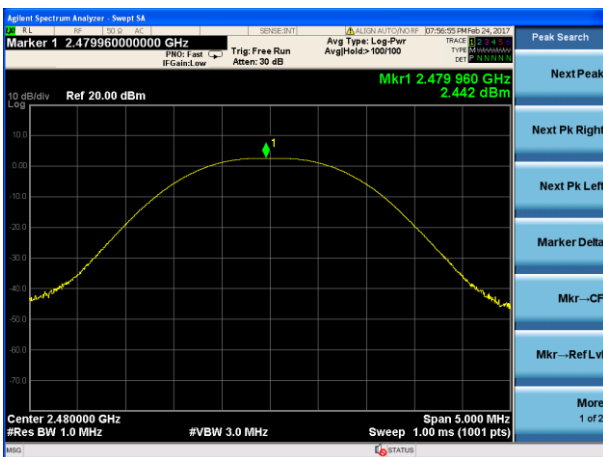

Peak output Power plot on channel 78 (2Mbps)

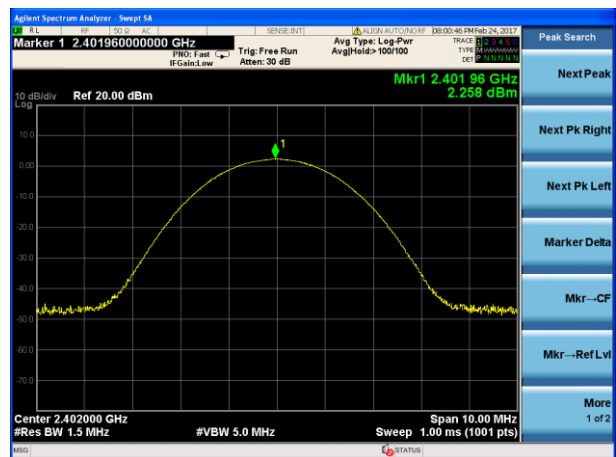

Test Plot

Peak output Power plot on channel 00 (3Mbps)

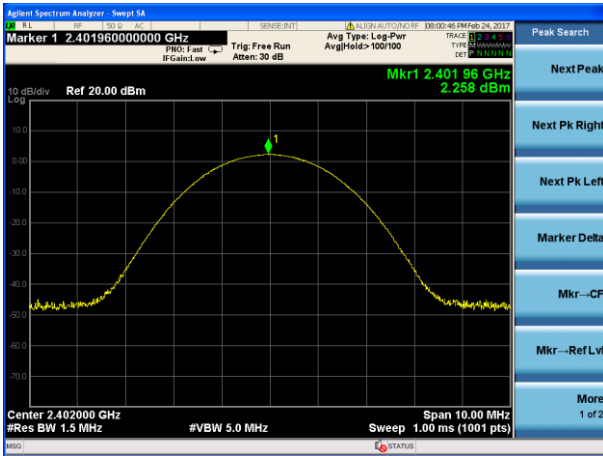

Peak output Power plot on channel 39 (3Mbps)

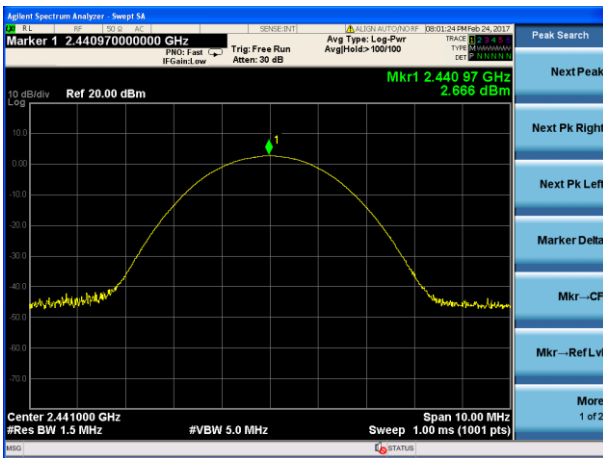

Peak output Power plot on channel 78 (3Mbps)

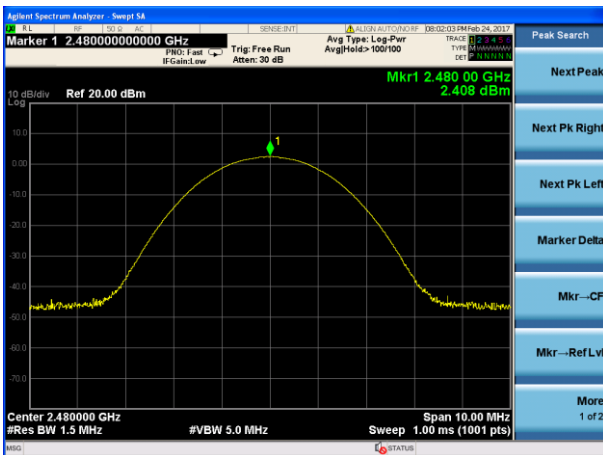

7.8 CONDUCTED BAND EDGE MEASUREMENT

7.8.1 Applicable Standard

According to FCC Part 15.247(d) and ANSI C63.10-2013

7.8.2 Conformance Limit

In any 100 kHz bandwidth outside the frequency band in which the spread spectrum or digitally modulated intentional radiator is operating, the radio frequency power that is produced by the intentional radiator shall be at least 20 dB below that in the 100 kHz bandwidth within the band that contains the highest level of the desired power, based on either an RF conducted or a radiated measurement, provided the transmitter demonstrates compliance with the peak conducted power limits. If the transmitter complies with the conducted power limits based on the use of RMS averaging over a time interval, as permitted under paragraph (b)(3) of this section, the attenuation required under this paragraph shall be 30 dB instead of 20 dB. Attenuation below the general limits specified in §15.209(a) is not required. In addition, radiated emissions which fall in the restricted bands, as defined in §15.205(a), must also comply with the radiated emission limits specified in §15.209(a) (see §15.205(c)).

7.8.3 Measuring Instruments

The Measuring equipment is listed in the section 6.3 of this test report.

7.8.4 Test Setup

Please refer to Section 6.1 of this test report.

7.8.5 Test Procedure

The testing follows ANSI C63.10-2013 clause 7.8.6.

The RF output of EUT was connected to the spectrum analyzer by RF cable and attenuator.

The path loss was compensated to the results for each measurement.

Set to the maximum power setting and enable the EUT transmit continuously.

The EUT must have its hopping function enabled.

Use the following spectrum analyzer settings:

Span = approximately 5 times the 20 dB bandwidth, centered on a hopping channel

RBW = 100KHz

VBW = 300KHz

Band edge emissions must be at least 20 dB down from the highest emission level within the authorized band as measured with a 100kHz RBW. The attenuation shall be 30 dB instead of 20 dB when RMS conducted output power procedure is used.

Measure the highest amplitude appearing on spectral display and set it as a reference level. Plot the graph with marking the highest point and edge frequency.

Repeat above procedures until all measured frequencies were complete.

7.8.6 Test Results

EUT:	Wi-Fi&Bluetooth Speaker with Amazon Alexa Voice Control	Model No.:	NAS-5000
Temperature:	20 °C	Relative Humidity:	48%
Test Mode:	Mode2 /Mode4/ Mode 5	Test By:	Allen Liu

Note: Hopping enabled and disabled have evaluated, and the worst data was reported

Test Plot

BDR mode (GFSK): Band Edge-Low Channel

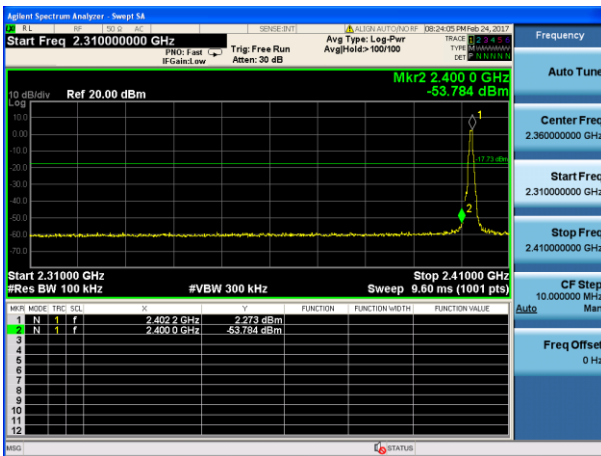

BDR mode (GFSK): Band Edge-High Channel

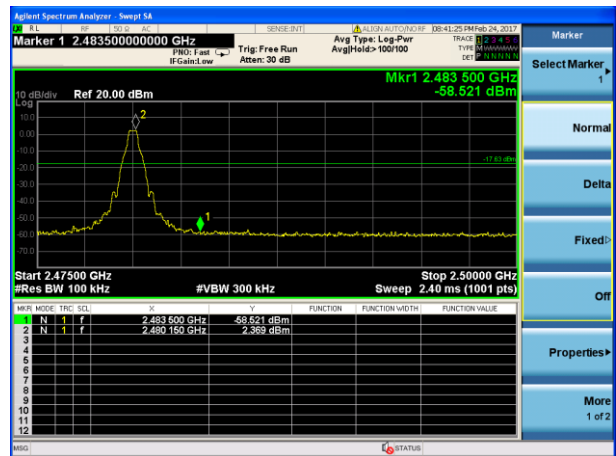

BDR mode (GFSK): Band Edge-Low Channel (Hopping Mode)

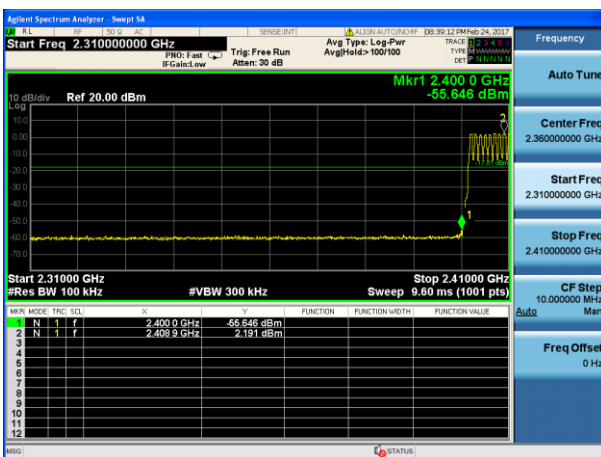

BDR mode (GFSK): Band Edge-High Channel (Hopping Mode)

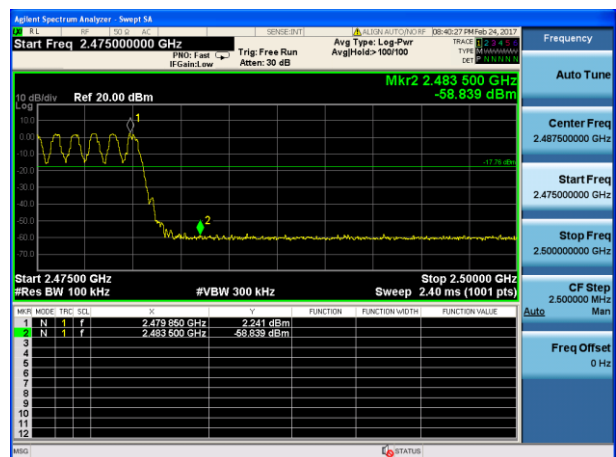

Test Plot

BDR mode ($\pi/4$ -DQPSK): Band Edge-Low Channel

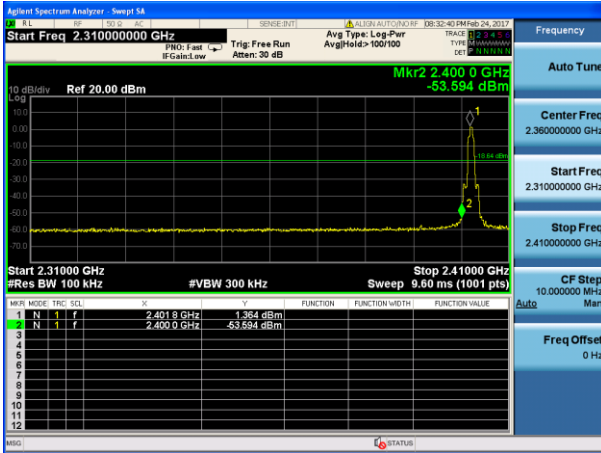

BDR mode ($\pi/4$ -DQPSK): Band Edge-High Channel

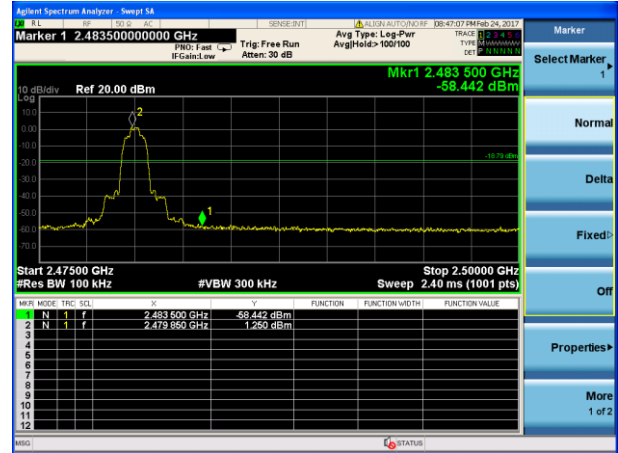

BDR mode ($\pi/4$ -DQPSK): Band Edge-Low Channel (Hopping Mode)

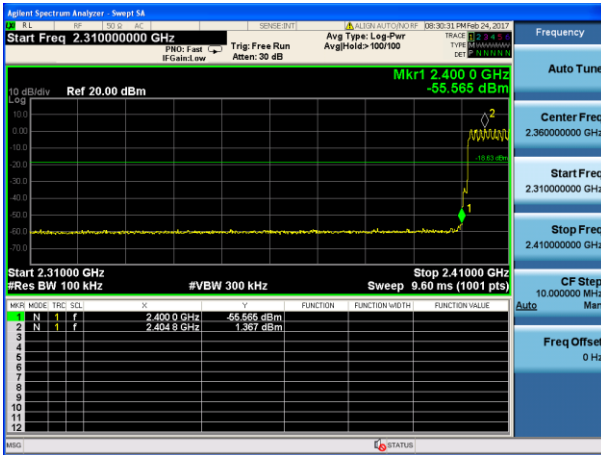

BDR mode ($\pi/4$ -DQPSK): Band Edge-High Channel (Hopping Mode)

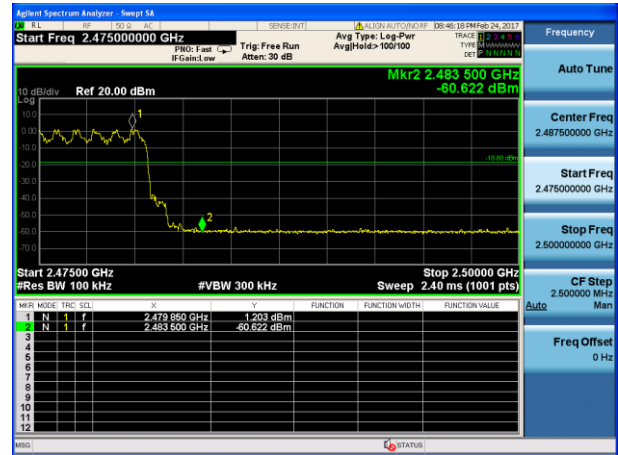

Test Plot

BDR mode (8DPSK): Band Edge-Low Channel

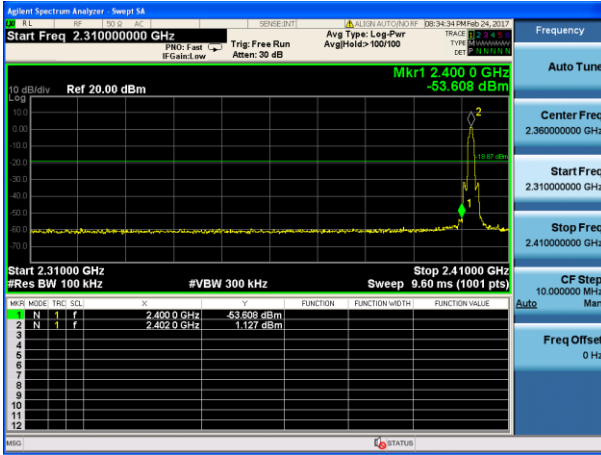

BDR mode (8DPSK): Band Edge-High Channel

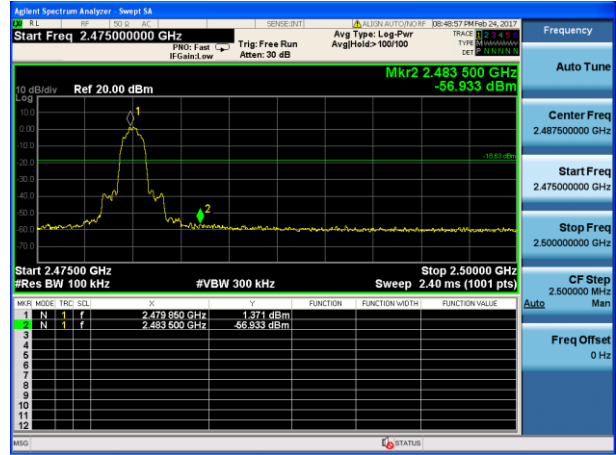

BDR mode (8DPSK): Band Edge-Low Channel
(Hopping Mode)

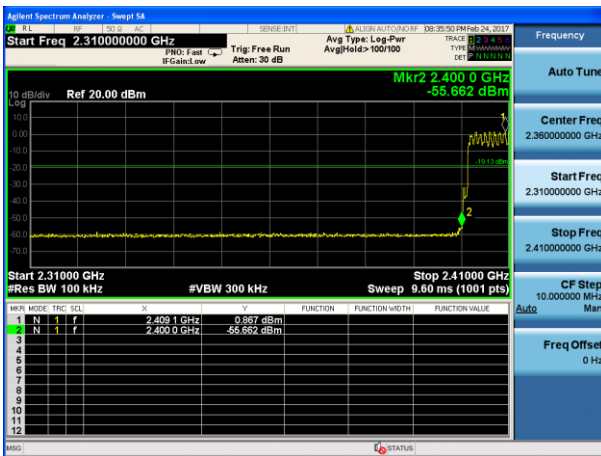

BDR mode (8DPSK): Band Edge-High Channel
(Hopping Mode)

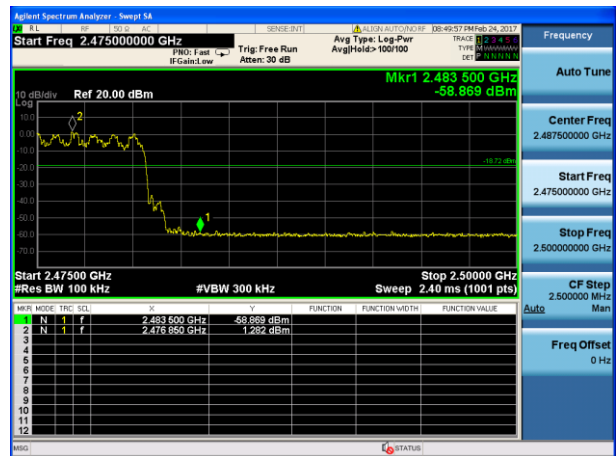

7.9 SPURIOUS RF CONDUCTED EMISSION

7.9.1 Applicable Standard

According to RSS-247 5.5 & RSS-Gen 6.13.

7.9.2 Conformance Limit

In any 100 kHz bandwidth outside the frequency band in which the spread spectrum or digitally modulated device is operating, the RF power that is produced shall be at least 20 dB below that in the 100 kHz bandwidth within the band that contains the highest level of the desired power, based on either an RF conducted or a radiated measurement, provided that the transmitter demonstrates compliance with the peak conducted power limits. If the transmitter complies with the conducted power limits based on the use of root-mean-square averaging over a time interval, as permitted under Section 5.4(4), the attenuation required shall be 30 dB instead of 20 dB. Attenuation below the general field strength limits specified in RSS-Gen is not required..

7.9.3 Measuring Instruments

The Measuring equipment is listed in the section 6.3 of this test report.

7.9.4 Test Setup

Please refer to Section 6.1 of this test report.

7.9.5 Test Procedure

The Spurious RF conducted emissions compliance of RF radiated emission should be measured by following the guidance in RSS-247 5.5 with respect to maximizing the emission by rotating the EUT, measuring the emission while the EUT is situated in three orthogonal planes (if appropriate), adjusting the measurement antenna height and polarization etc. Set RBW=100kHz and VBW= 300KHz to measure the peak field strength , and mwasure frequency range from 9KHz to 26.5GHz.

7.9.6 Test Results

Remark: The measurement frequency range is from 9KHz to the 10th harmonic of the fundamental frequency. The lowest, middle and highest channels are tested to verify the spurious emissions and bandege measurement data.

Test Plot(GFSK)

GFSK on channel 00

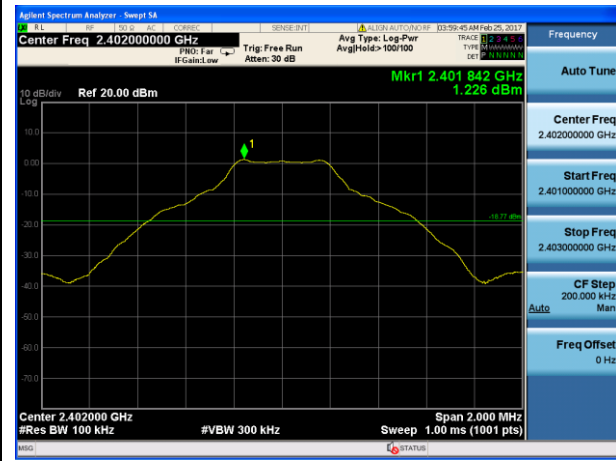

GFSK on channel 00

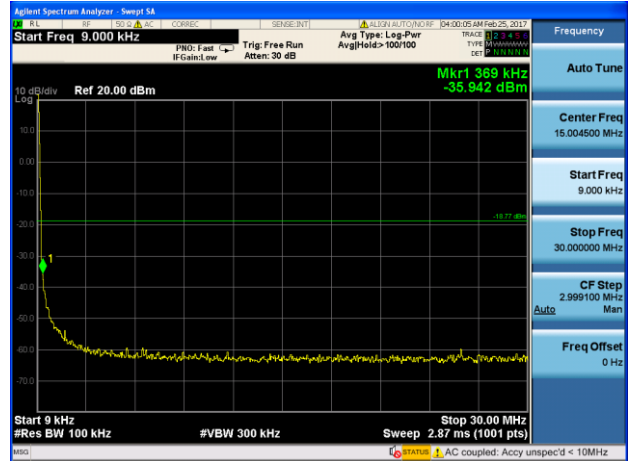

GFSK on channel 00

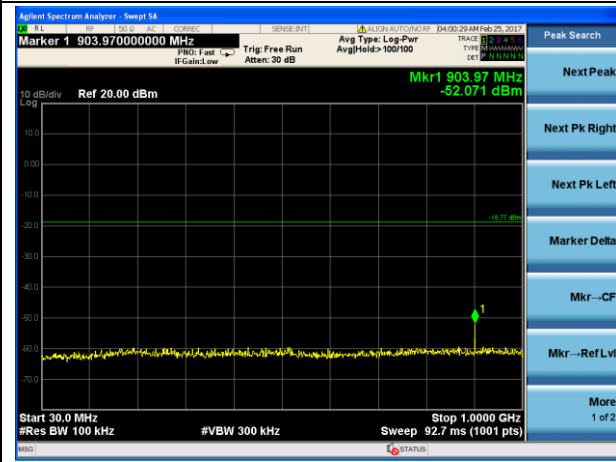

GFSK on channel 00



Test Plot

GFSK on channel 39

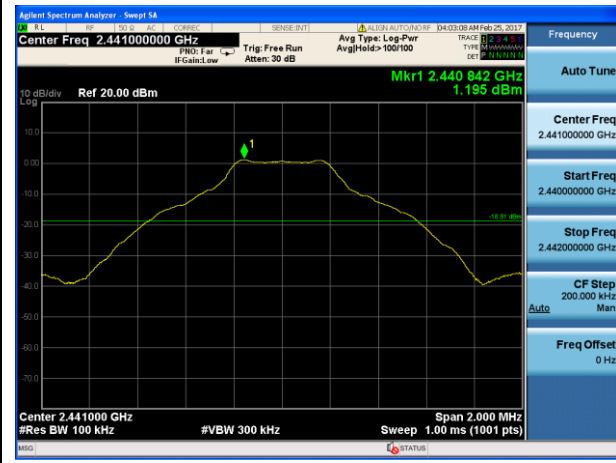

GFSK on channel 39

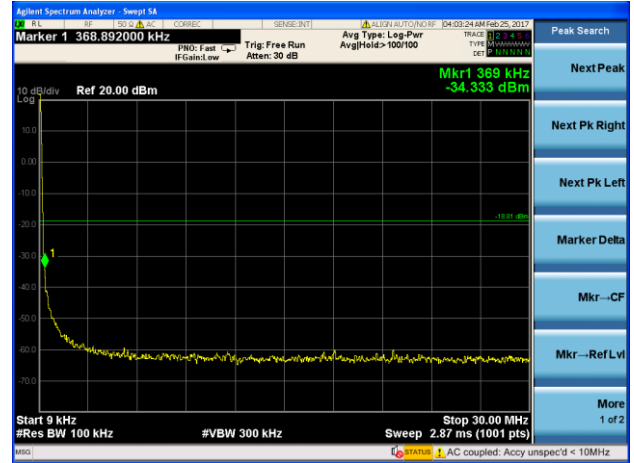

GFSK on channel 39

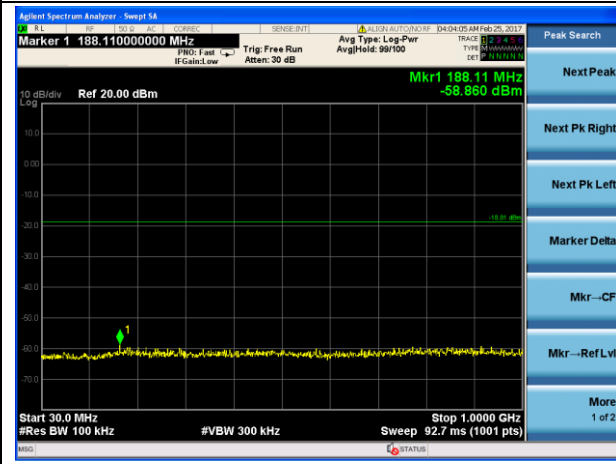

GFSK on channel 39



Test Plot

GFSK on channel 78

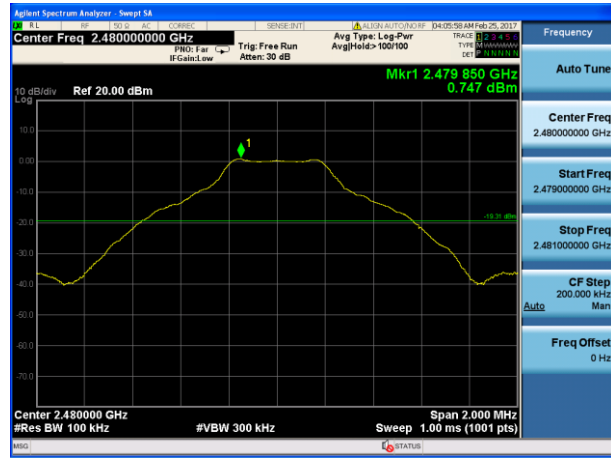

GFSK on channel 78

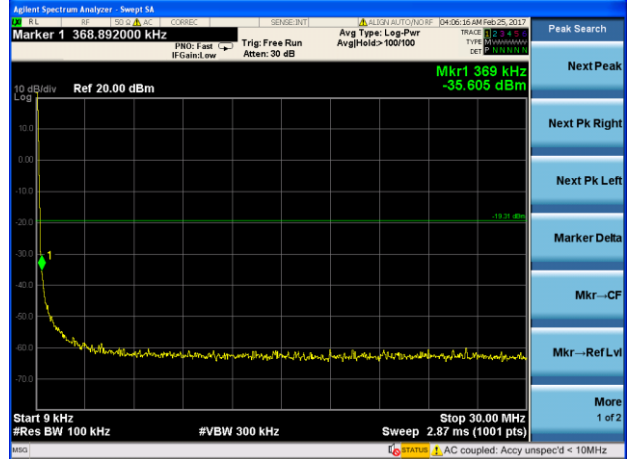

GFSK on channel 78

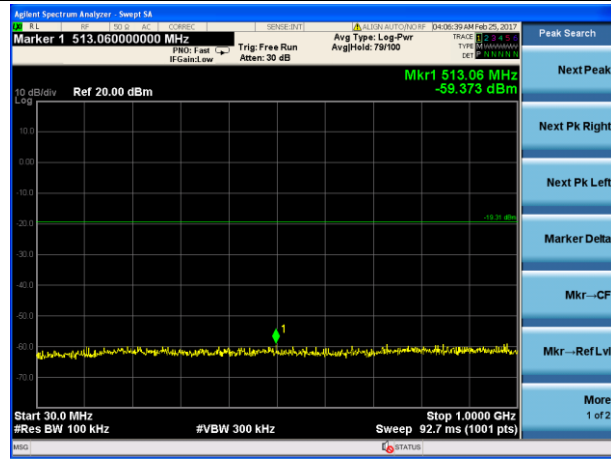

GFSK on channel 78



7.10 ANTENNA APPLICATION

7.10.1 Antenna Requirement

15.203 requirement: For intentional device, according to 15.203: an intentional radiator shall be designed to ensure that no antenna other than that furnished by the responsible party shall be used with the device.

7.10.2 Result

The EUT antenna is permanent attached PCB antenna(Gain:1dBi). It comply with the standard requirement.

END OF REPORT