

W05102TX FCC
49.860MHz

BLOCK DIAGRAM

ANTENNA

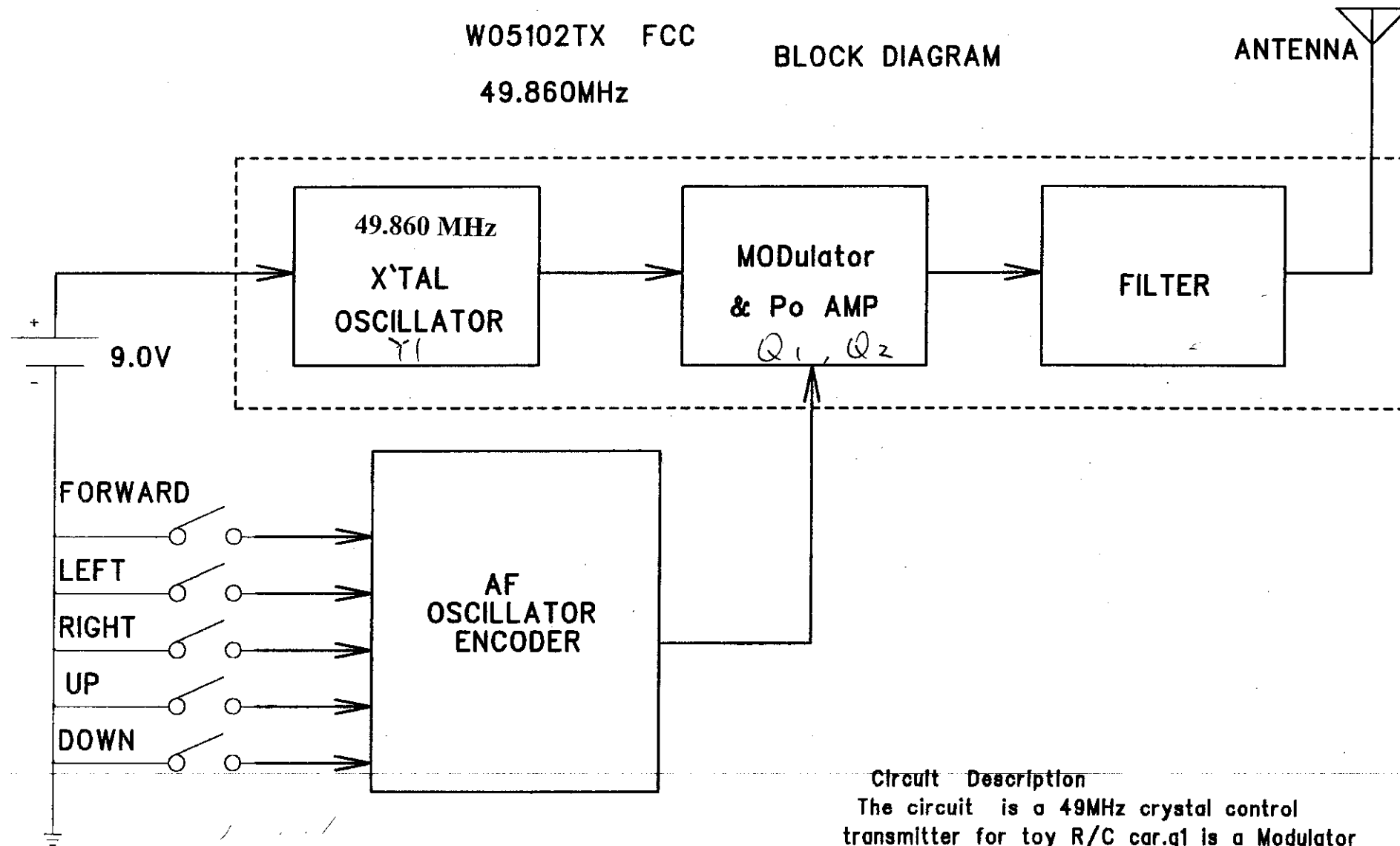

Circuit Description

The circuit is a 49MHz crystal control transmitter for toy R/C car. Q1 is a Modulator & Po AMP. Q2 & Y1 is a RF oscillator; U1 is a AF oscillator and Encoder C1, C2 and T1 is a harmonic filter