

Manufactured and distributed by © 2015 WowWee Group Limited. Product names, designations, and logos are trademarks or registered trademarks of WowWee Group Limited. All rights reserved.

Customer Service Website: www.wowweezone.com

We recommend that you retain our address for future reference.

Product and colors may vary.

Packaging printed in China.

WARNING! This product is not suitable for children under 3 years because of small parts - choking hazard.

Apple, the Apple logo, iPhone, iPad, iPad mini, iPad Air, and iPad touch are trademarks of Apple Inc., registered in the U.S. and other countries. App Store is a service mark of Apple Inc., registered in the U.S. and other countries.

Android and Google Play are trademarks of Google Inc.

Amazon and Amazon Appstore are trademarks of Amazon.com, Inc.

MADE IN CHINA

CAUTION

Changes or modifications not expressly approved by the party responsible for compliance could void the user's authority to operate the equipment.

NOTE

This equipment has been tested and found to comply with the limits for a class B digital device, pursuant to part 15 of the FCC rules. These limits are designed to provide reasonable protection against harmful interference in a residential installation. This equipment generates, uses and can radiate radio frequency energy and, if not installed and used in accordance with the instructions, may cause harmful interference to radio communications.

However, there is no guarantee that interference will not occur in a particular installation. If this equipment does cause harmful interference to radio or television reception, which can be determined by turning the equipment off and on, the user is encouraged to try and correct the interference by one or more of the following measures:

- Reorient or relocate the receiving antenna
- Increase the separation between the equipment and receiver
- Connect the equipment into an outlet on a circuit different from that to which the receiver is connected
- Consult the dealer or experienced radio/TV technician for help

This Device complies with Part 15 of the FCC Rules. Operation is subject to the following two conditions:

- (1) This device may not cause harmful interference, and
- (2) This device must accept any interference received, including interference that may cause undesired operation.

This device complies with Industry Canada Licence-exempt RSS-210. Operation is subject to the following two conditions:

- (1) This device may not cause interference, and
- (2) This device must accept any interference, including interference that may cause undesired operation of the device.

For these purposes, the party responsible is:

WowWee USA Inc.
7855 Fay Avenue, Suite 310
La Jolla CA, USA 92037
1-800-310-3033

For more indepth instructions, please refer to www.wowwee.com/chip
For warranty information, please visit <http://www.wowwee.com/information/warranty>

WARNING! This equipment may experience difficulty and/or memory loss when subjected to any electrostatic discharge, radio frequency interference, or sudden power surge/interruption. The user is encouraged to reset the equipment should any of these occur.



WowWee Group Limited WowWee Canada Inc.
Energy Plaza, 301A-C 3700 Saint Patrick Street
92 Granville Road Suite 206
T.S.T. East, Hong Kong Montreal, QC, H4E 1A2, Canada



I. INTRODUCTION

Item No.: 0805
Age: 8+

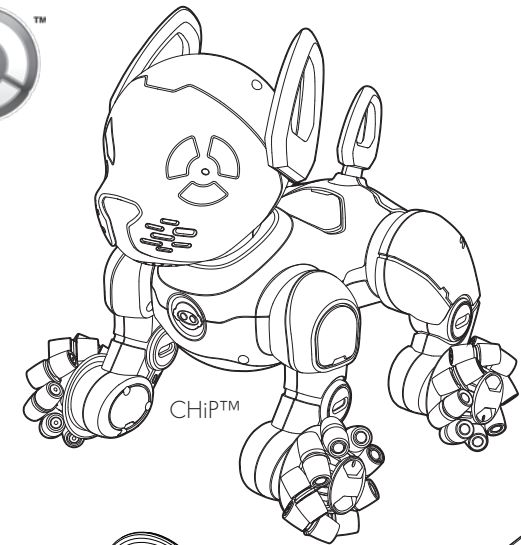

Product Contents:

- CHiP™ x 1
- CHiP SmartBand™ x 1
- CHiP SmartBall™ x 1
- Micro USB Cable x 1
- AC Adaptor x 1
- Wheel Guards x 4
- Screws (for Wheel Guards) x 8
- Quick Start Guide x 1
- User Manual x 1

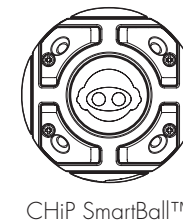

CHIP SmartBall™

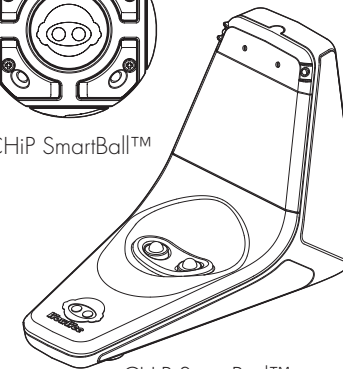

CHIP SmartBed™



4 x Wheel Guards

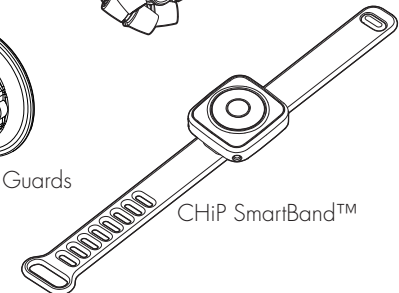

CHIP SmartBand™



8 x Screws

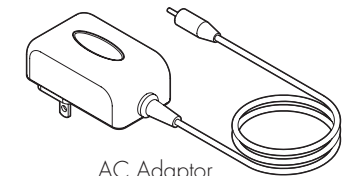

AC Adaptor



Micro USB Cable

Please note the following when operating CHiP™:

- Do not immerse CHiP™ or any of its parts or accessories in water or any other form of liquid.
- Do not drop, throw, or kick CHiP™ or its accessories as this may damage mechanical functions.
- Do not leave CHiP™ unattended near edges from which it could fall.

2. BATTERY INFORMATION

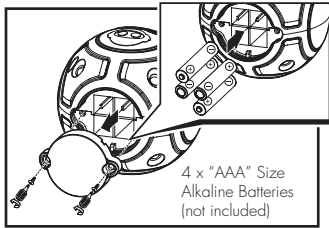

CHiP SmartBall™
Battery Diagram/Installation

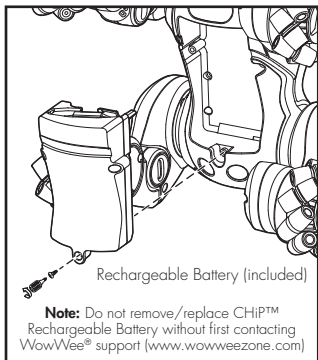

Note: Do not remove/replace CHiP™ Rechargeable Battery without first contacting WowWee® support (www.wowweezone.com)

CHiP™ Battery Diagram

Installing or changing batteries in the CHiP SmartBall™:

1. Lay the CHiP SmartBall™ so that the battery compartment faces upwards. The CHiP SmartBall™ requires 4 x "AAA" size alkaline batteries (not included).
2. Using a Phillips screwdriver (not included) remove the screws on the battery compartment cover located on the back of the ball.
3. Remove any existing batteries and insert new batteries according to the diagram. Ensure that the positive and negative polarities match the illustrations inside the battery compartment.
4. Replace the battery compartment cover and tighten screws using the screwdriver. Do not over-tighten.

LOW BATTERY INDICATORS:

- CHiP™ -** When the batteries grow weak, CHiP™ will move very slowly and will make a low battery indication sound. You can also see current battery levels via the CHiP™ App. When this happens, recharge CHiP™ as indicated in the Rechargeable Battery Instruction Sheet.
- CHiP SmartBand™ -** When the battery grow weak, CHiP SmartBand™ will flash red and then power down. When this happens, recharge CHiP SmartBand™ as indicated in the Rechargeable Battery Instruction Sheet.
- CHiP SmartBall™ -** When the batteries grow weak, the light on CHiP SmartBall™ will flash red and then power down. When this happens, power OFF and replace all batteries.

IMPORTANT BATTERY INFORMATION (CHiP SmartBall™):

- Use only fresh batteries of the required size and recommended type.
- Do not mix old and new batteries, different types of batteries [standard (Carbon-Zinc), Alkaline or rechargeable] or rechargeable batteries of different capacities.
- Remove rechargeable batteries from the toy before recharging them.
- Rechargeable batteries are only to be charged under adult supervision.
- Please respect the correct polarity, (+) and (-).
- Do not try to recharge non-rechargeable batteries.
- Do not dispose of batteries into fire.
- Replace all batteries of the same type/brand at the same time.
- The supply terminals are not to be short-circuited.
- Remove exhausted batteries from the toy.
- Batteries should be replaced by adults.
- Batteries should be recycled or disposed of as per state and local guidelines.

3. APP COMPATIBILITY

Apple® iOS devices:

Works with iPhone®, iPad® & iPod touch® devices running iOS 9 or later*.

*Devices must also support Bluetooth® Smart (also known as Bluetooth® Low Energy).

Android™ devices:

Works with most Bluetooth® Smart Ready (also known as Bluetooth® Low Energy) devices running Android™ 4.4.4 (KitKat) or later*.

*The easiest way to test compatibility before purchasing the product is to attempt to download and run the CHiP™ App. If your device is not compatible, Google Play™ will not allow you to see, download, or install the app.

4. DOWNLOADING THE APP



For Apple® Devices:

Go to the App Store™ and search for the WowWee "CHiP" App. Then, click download.

For Android™ Devices:

Go to the Google Play™ Store or Amazon Appstore™ and search for the CHiP™ App. Then, click download.

5. CONNECTING TO CHiP™ WITH YOUR DEVICE

To connect CHiP™ with your device:

1. Turn CHiP™ and its accessories ON as instructed in the Quick Start Guide.
2. Open the CHiP™ App on your device.
3. Follow the on-screen instructions.

Q & A

Q: Is my tablet or phone compatible with CHiP™?

A: CHiP™ can be controlled using our free apps available for compatible smart devices featuring Bluetooth® Smart technology. These apps are available on iTunes® or the Google Play™ store.

iOS devices:

All iPhone®, iPad® and iPod® devices (excluding iPad® 2) which run iOS 9 or later are compatible.

Android™ devices:

The app is compatible with most Bluetooth® Smart Ready (also known as Bluetooth® Low Energy) devices running Android™ 4.4.4 (KitKat) or later. The easiest way to test compatibility before purchasing the product is to attempt to download the CHiP™ App. If your device is not compatible, Google Play™ will not allow you to see, download, or install the app. If the app can download, install, and run correctly on your device, we expect full compatibility.

Q: I cannot access Google Play™ on my Android™ device, how can I download the application?

A: Try downloading the application on the Amazon AppStore™. All WowWee® applications are officially provided there for users who cannot use Google Play™.

Q: When I try to download the CHiP™ app on my Android™ phone, it says it's incompatible with my device.

A: CHiP™ only works with devices which are Bluetooth® Smart Ready and running compatible operating systems. Generally our toys are expected to be compatible with most Android™ phones or tablets that are Bluetooth® Smart Ready (also known as Bluetooth® Low Energy) and running Android™ 4.4.4 (KitKat) or later.

The easiest way to test CHiP™ app compatibility on your Android™ device is to attempt to download the CHiP™ App. If your device is not compatible, Google Play™ will not allow you to see, download, or install the app. If the app can download, install, and run correctly on your device, we expect full compatibility.

Q: My CHiP™ won't show up in the app when I try to connect.

A: Make sure your CHiP™ is fully charged and is turned on, then close the app and switch Bluetooth® on/off in

your device settings. If you're still having problems, try restarting your device completely.

Q: My CHiP™ disconnects often and/or seems to pause or run slow.

A: This is most likely caused by Bluetooth® interference. Ensure that there are no other Bluetooth® devices connected or switched on (especially audio devices), as these can cause interference which can cause issues. If you still having problems try turning your device's WiFi off to reduce interference.

Q: My CHiP™ turns on, plays a sound, then switches off and/or CHiP™ turns off unexpectedly during play.

A: Most likely the batteries are low or flat; try placing CHiP™ on it CHiP SmartBand™ and/or use the CHiP SmartBand™'s AC/DC adaptor to directly charge CHiP™. While charging, ensure that the charging lights on CHiP™ are on.

Q: Can I use CHiP™ without a compatible smart device?

A: Yes. CHiP™ is designed to be used without a smart device for normal play. For special functions or receiving rewards, a compatible smart device is required.

Q: Can I connect additional accessories to CHiP™?

A: Currently, CHiP™ can only support one additional CHiP SmartBand™. Future updates may support additional accessories.

Q: How do I pair another CHiP SmartBand™ to CHiP™ or replace a lost accessory?

A: Refer to the app or website.

Q: CHiP™ does not automatically go to CHiP SmartBed™ to recharge when batteries are low.

A: Ensure that CHiP™ has a clear line of sight to the SmartBand. CHiP™ cannot navigate between rooms.

Q: Does CHiP™ work outside or in bright sunlight?

A: CHiP™ is designed to work only indoors. Bright sunlight or Ultra-Violet light can interfere temporarily with CHiP™'s functions.

For a more in-depth FAQ, please refer to www.wowwee.com/chip



Manufactured and distributed by
© 2015 WowWee Group Limited.
All Rights Reserved.

WowWee Group Limited. Energy Plaza, 301A-C, 92 Granville Road
T.S.T. East, Hong Kong

WowWee Canada Inc. 3700 Saint Patrick Street, Suite 206, Montreal
QC, H4E 1A2, Canada

Customer Service: www.wowweezone.com

RECHARGEABLE BATTERY INSTRUCTION SHEET

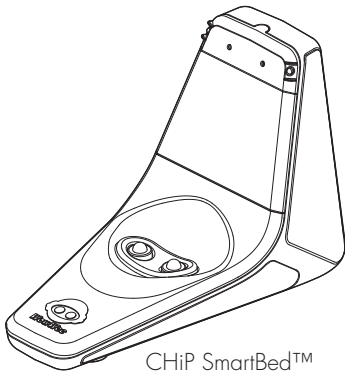

CHiP SmartBed™

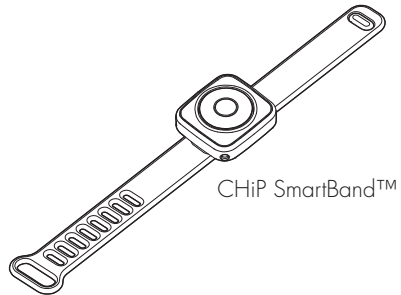

CHiP SmartBand™

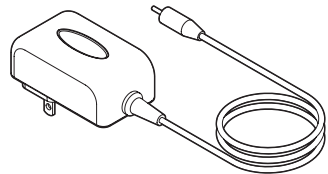

AC Adaptor (for CHiP SmartBed™)



Micro USB Cable (for CHiP SmartBand™)



WARNING!

Examine the AC/DC adaptor regularly for damage to the cord, plug, enclosure and other parts.

The AC/DC adaptor is NOT a toy.

Rechargeable batteries are only to be charged by adults.

CHiP SmartBed™ must only be used with the transformer included.

CHiP SmartBand™ is only to be charged with the included Micro USB Cable.

Parts to be cleaned with liquid are to be disconnected from the transformer before cleaning.

This product is intended for indoor use only.

The product is not recommended for use on loose dirt or wet surfaces.

Do not immerse in water. Immersing this battery pack can result in electric shock.

Burn hazard, fire hazard and explosion hazard associated with mishandling of the battery.

To avoid possible hazards, do not crush, disassemble, dispose of in fire.

An adult should periodically check this toy to ensure no damage or hazards exist, if so, remove from use.

AC/DC ADAPTOR INPUT

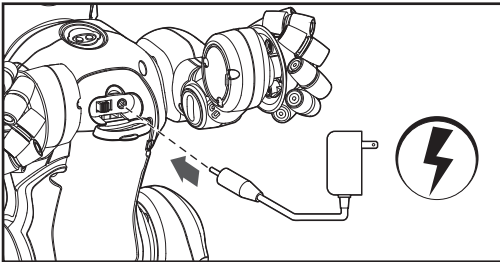
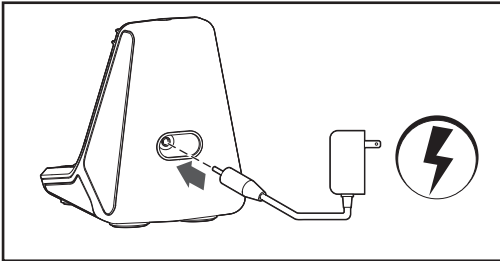

* The CHiP™ product is operated by 1 x 7.4V 1800 mAh Lithium-ion rechargeable.

Recharging CHiP™:

1. Ensure that both CHiP™ and CHiP SmartBed™ are ON and within close proximity (3 meters). CHiP™ will automatically detect when its power is low, and will drive to CHiP SmartBed™ and recharge; or
2. Press the bed button on CHiP SmartBand™ while both CHiP™ and CHiP SmartBed™ are within close proximity. CHiP™ will drive to CHiP SmartBed™ and recharge; or
3. In the case that CHiP™'s power is extremely low and unresponsive to (1) or (2), use the CHiP SmartBed™'s AC/DC adaptor to directly charge CHiP™.

DC IN 12V 1.5A



CENTER POSITIVE

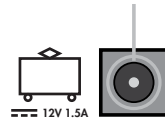

CHARGING RECHARGEABLE BATTERY

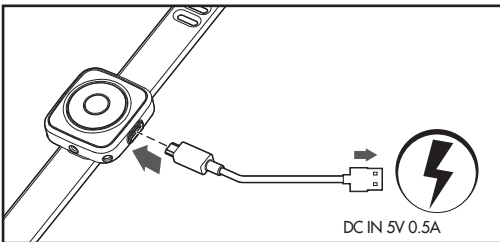

* The CHiP SmartBand™ is operated by 1 x 3.7V 130mAh Lithium-ion rechargeable.

Recharging the CHiP SmartBand™:

1. Plug the Micro USB Cable into the Micro USB port on the CHiP SmartBand™ and connect to a power source as indicated in the diagram.
2. Charging is indicated by a flashing white light.
3. When fully charged, the light on CHiP SmartBand™ will appear white
4. Press the center button on CHiP SmartBand™ to reactivate the band.

For Lithium-ion Batteries:

- Charge battery in isolated area.
- Never charge battery unattended.
- Keep from flammable materials.
- Do not expose to direct sunlight.
- There is a risk of the batteries exploding, overheating, or igniting. Do not disassemble, modify, heat, or short circuit the batteries. Do not place them in fires or leave them in hot places.
- Do not drop or subject to strong impacts.
- Do not allow the Rechargeable Battery or charging contacts to get wet.
- Only use the Rechargeable Battery in the device specified by WowWee®.
- Carefully read the instruction guide, and use the Rechargeable Battery correctly.
- In the unlikely event of leakage or explosion, use sand or a chemical fire extinguisher for the battery.
- Batteries must be recycled or disposed of properly.
- Batteries should be recycled or disposed of as per state and local guidelines.

We recommend that you retain our address for future reference.

Product and colors may vary.

Packaging printed in China.

WARNING! This product is not suitable for children under 3 years because of small parts - choking hazard.

MADE IN CHINA



Manufactured and distributed by
© 2015 WowWee Group Limited.

All Rights Reserved.

WowWee Group Limited.

Energy Plaza, 301A-C, 92 Granville Road
T.S.T. East, Hong Kong

WowWee Canada Inc.

3700 Saint Patrick Street, Suite 206, Montreal
QC, H4E 1A2, Canada

Customer Service:

www.wowweezone.com

WHEEL GUARD ASSEMBLY INSTRUCTION SHEET

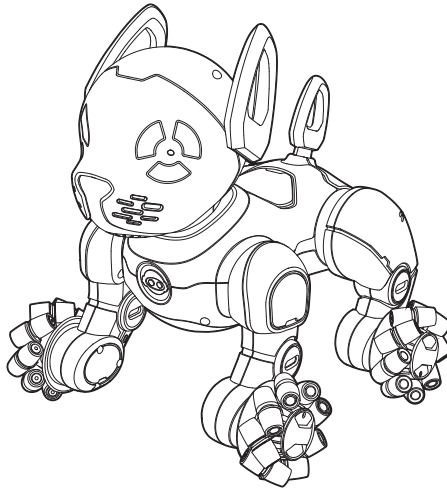

ChiP™

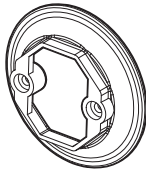

4 x Wheel Guards



8 x Screws



Caution

- Wheel guards **MUST** be assembled on product prior to playing.
- Assembly should be done by adults **ONLY**.
- If dirt or other foreign objects become trapped in the wheels, follow instructions for disassembly and then remove the foreign object(s). Do not use water or liquids.
- Avoid using the product near hair or anything with long fibers to avoid hair trapping issues.
- The included screws are **NOT** toys.

LOOSEN THE WHEEL

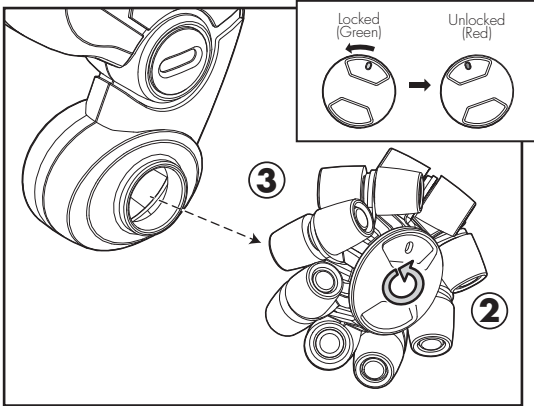

Loosen the Wheels from CHiP™:

1. Ensure that CHiP™'s power is OFF.
2. Turn the wheel cap counterclockwise as indicated in the diagram to loosen the wheel. Note that small indent on the wheel cap will show green when locked, and red when unlocked.
3. Remove the wheel and set aside.

NOTE: The wheels are unique to each of CHiP™'s legs. Assemble one at a time. DO NOT mix wheels between legs.

INSTALLING WHEEL GUARD

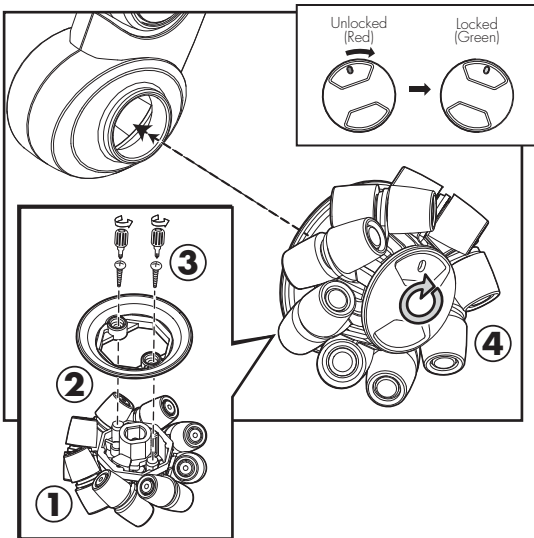

Installing Wheel Guards and Wheels:

1. Place the wheel on a smooth, flat surface with the wheel cap facing down.
2. Align the wheel guard to the wheel as indicated in the diagram
3. Using a Phillips screwdriver (not included), insert and tighten the screws until the wheel guard is securely fastened to the wheel. Do not overtighten.
4. With the wheel and wheel guard assembled, place back onto CHiP™'s leg as indicated in the diagram, and turn the wheel cap clockwise to secure the wheel to the leg. Do not overtighten.
5. Repeat this process individually for all the remaining wheels.

NOTE: The wheels are unique to each of CHiP™'s legs. Assemble one at a time. DO NOT mix wheels between legs.

We recommend that you retain our address for future reference.

Product and colors may vary.

Packaging printed in China.

WARNING! This product is not suitable for children under 3 years because of small parts - choking hazard.

MADE IN CHINA

0805US01FLA_OT2