



HERMON LABORATORIES



Electrical

Hermon Laboratories Ltd.
P.O.Box 23
Binyamina 30500, Israel
Tel. +972 46288001
Fax. +972 46288277
e-mail: mail@hermonlabs.com

ELECTROMAGNETIC EMISSIONS TEST REPORT

according to 47CFR Part 90, subparts I, S
for

Mobile Access Networks Ltd.

EQUIPMENT UNDER TEST:

Wireless network system repeater

Model: MA1000

This report is in conformity with ISO/IEC 17025. The A2LA logo endorsement applies only to the test methods and the standards that are listed in the scope of Hermon Laboratories accreditation.
The test results relate only to the items tested. **This test report must not be reproduced in full with the approval of Hermon Laboratories Ltd.**

Page 1 of 104

Document ID: **MOBRAD_FCC.16224-1_rev1.doc**
Date of Issue: **April 2005**



Contents

1	Applicant information.....	3
2	Equipment under test attributes	3
3	Manufacturer information	3
4	Test details	3
5	Summary and signatures.....	4
6	EUT description	5
6.1	GENERAL DESCRIPTION	5
6.2	OPERATING FREQUENCIES.....	5
6.3	EUT MODULES AND UNITS	5
6.4	PORTS AND LINES	6
6.5	SUPPORT AND TEST EQUIPMENT	6
6.6	CHANGES MADE IN THE EUT	6
6.7	TEST CONFIGURATION	7
7	Transmitter tests.....	8
7.1	PEAK OUTPUT POWER TEST ACCORDING TO PART 90 §§90.205 (J), 90.635	8
7.2	OCCUPIED BANDWIDTH ACCORDING TO PART 90 §90.209(5)	29
7.3	EMISSION MASK TEST ACCORDING TO PART 90 §§90.210(G), 90.210(J), 90.691	34
7.4	SPURIOUS EMISSIONS AT RF ANTENNA CONNECTOR TEST ACCORDING TO PART 90 §90.210	43
7.5	RADIATED SPURIOUS EMISSION MEASUREMENTS ACCORDING TO PART 90 §§90.210(G), 90.210(J)	53
8	Emissions tests according to 47CFR part 15 subpart B requirements	62
8.1	RADIATED EMISSION MEASUREMENTS	62
8.2	SPURIOUS EMISSIONS AT RF ANTENNA CONNECTOR.....	78
8.3	CONDUCTED EMISSIONS	81
	Appendix A Test equipment used for tests.....	88
	APPENDIX B Measurement uncertainties	90
	Appendix C Test equipment correction factors.....	91
	Appendix D General information.....	104
	TEST FACILITY DESCRIPTION	104
	ABBREVIATIONS AND ACRONYMS	104
	SPECIFICATION REFERENCES	104



1 Applicant information

Client name: Mobile Access Networks Ltd.
Address: Ofek One Center Building 2, Northern Industrial Zone, Lod 71293, Israel
Telephone: +972 8918 3879
Fax: +972 8918 3844
E-mail: shais@mobileaccess.com
Contact name: Mr. Shai Simhon

2 Equipment under test attributes

Product name: Wireless network system repeater
Model(s): MA1000
Receipt date 12/23/2004

3 Manufacturer information

Manufacturer name: Mobile Access Networks Ltd.
Address: Ofek One Center Building 2, Northern Industrial Zone, Lod 71293, Israel
Telephone: +972 8918 3879
Fax: +972 8918 3844
E-Mail: shais@mobileaccess.com
Contact name: Mr. Shai Simhon

4 Test details

Project ID: 16224
Location: Hermon Laboratories Ltd. P.O.Box 23, Binyamina 30500, Israel
Test started: 12/26/2004
Test completed: 4/5/2005
Test specification(s): 47CFR Part 90, §§90.205, 90.209, 90.210, 90.635, 90.691; part 15 §§15.107, 15.109



5 Summary and signatures

The EUT was tested according to FCC part 90 subparts I, S, §§90.205(j), 90.209, 90.210, 90.691, part 15 §§15.107, 15.109 and found to comply with the standard requirements.

Test description	Specification reference	Tested by	Date tested	Test report paragraph	Verdict
RF output power	90.205(j), 90.635	Mr. A. Adelberg, test engineer	December 26, 2004; April 3, 2005	7.1	Pass
Occupied bandwidth	90.209	Mr. A. Adelberg, test engineer	December 27, 2004; April 3, 2005	7.2	Pass
Emission mask	90.210 90.691	Mr. A. Adelberg, test engineer	December 29, 2004; April 3, 2005	7.3	Pass
Conducted spurious emissions and Intermodulation	90.210	Mr. A. Adelberg, test engineer	January 13, 2005; April 3, 2005	7.4	Pass
Radiated spurious emissions	90.210	Mr. M. Lerman, Mr. Y. Neuman, test engineers	January 31, 2005; April 4, 2005	7.5	Pass
Radiated emissions	15.109	Mr. M. Lerman, test engineer	January 31, 2005	8.1	Pass
Antenna power for receiver	15.111	Mr. M. Lerman, test engineer	January 31, 2005	8.2	Pass
Conducted emissions	15.107, 15.207	Mr. A. Adelberg, test engineer	January 13, 2005	8.3	Pass

This test report replaces the previously issued test report identified by Doc ID:MOBRAD_FCC.16224-1.

Test report prepared by:

Mrs. M. Cherniavsky, certification engineer



Test report approved by:

Mr. Michael Nikishin, EMC group leader



Mr. Alex Usoskin, C.E.O.





6 EUT description

6.1 General description

The MobileAccess™ system provides in-building coverage by routing RF signals from (up to three) BTS (base transmit station) or BDA (bi-directional amplifier) units, through optic fibers to remote areas where the signals are converted back to RF and interfaced to antennas covering the remote area. All system elements can be remotely controlled and monitored from a single location.

The MobileAccess™ coax and Fiber Optic hybrid solution consists of the following elements:

Radio Interface Unit (RIU) – Provides direct, simple interface to up to three BTS or BDA units supporting up to three different services. Connections can be simplex or duplex. RIU output signal is automatically adjusted to respond to a range of BTS or BDA output power levels. This significantly reduces or eliminates the need for extensive manual site measurements and adjustments required to provide the optimal input to the Base Units. The RIU RF output signals are combined and fed via direct coax connection to MobileAccess Base Units.

Base Units (BUs) – convert the RF signal received from the RIU (or passive interface) to an optic signal that is then split and routed via optic fiber to Remote Hub Units located in remote locations. Each BU can support up to eight RHUs.

Remote Hub Units (RHUs) – converts the optic signal to an RF signal and feeds it to the antennas in the remote areas in order to provide the required coverage. Each RHU supports two different services (one high-band and one low-band) and provides coax connections to up to four antennas. The RHU filters and amplifies the optic signal received from the BU according to the service it supports. A third service can be added using a MobileAccess 1200 add-on or independent module. Wireless LAN services can also be added to the MobileAccess 1000 RHU by connecting the MobileAccess 840 add-on module. This provides wireless LAN signals to the antennas connected to the MobileAccess 1000 RHU.

System Controller – provides monitoring and control to all MobileAccess system elements, from a single location.

The iDEN/SMR RHU intended to provide two bands of cellular operation.

6.2 Operating frequencies

Source	Frequency, MHz			
	Clock	Communication	iDEN	SMR
CPU	11.059	NA	NA	NA
FSK module	NA	399.04	NA	NA
FSK module	NA	396.965	NA	NA
Downlink	NA	NA	851 - 869	929 - 941
Uplink	NA	NA	806 - 824	896 - 901

6.3 EUT modules and units

Description	Manufacturer	Model number	Serial number
Base unit	Mobile Access	8 links	NA
Radio interface unit (RIU)	Mobile Access	RIU	NA
NMS controller	Mobile Access	NMS410	495
Power supply	Lambda	JWS150-48/A	V0A-236C03-0012W3701



6.4 Ports and lines

Port type	Port description	Connected to	Connector type	Qty.	Cable type	Cable length	Indoor / outdoor
Remote hub unit (RHU) MA1000							
Power	48 VDC	Power supply	DC jack	1	Unshielded	1.5 m	Indoor
Signal	Add on control	Add on unit	D type 9	1	Shielded	1.5 m	Indoor
Signal	Antenna	Termination	N type	4	NA	NA	Indoor
Signal	RF high band	Termination	SMA	1	NA	NA	Indoor
Signal	RF external filter	External filter	SMA	2	Coax 50 Ohm	0.05 m	Indoor
Signal	RF downlink/uplink	Termination	SMA	2	NA	NA	Indoor
Signal	Fiber optic	Base unit	Fiber optic	1	Fiber optic	6 m	Indoor
Signal	RS232	Open circuit	D type 9	1	Shielded	1.5 m	Indoor
Remote hub unit (RHU) MA2000							
Power	120 V AC	AC mains	IEC 320	1	Unshielded	1.5 m	Indoor
Signal	Antenna	Termination	N type	4	NA	NA	Indoor
Signal	Fiber optic	Base unit	Fiber optic	1	Fiber optic	6 m	Indoor
Signal	RS232	Not connected	D type 9	1	NA	NA	Indoor

6.5 Support and test equipment

Description	Manufacturer	Model number	Serial number
ESG Series signal generator 250 kHz – 3 GHz	Hewlett Packard	E4432B	GB39340672
ESG Series signal generator 250 kHz – 3 GHz	Hewlett Packard	E4432B	GB38450502
Signal generator 100 kHz – 3.2 GHz	Hewlett Packard	HP 8648C	3426A00540
Combiner	Mini Circuits	ZAPD-1	NA
Combiner	Mini Circuits	ZAPD-1	NA
Power supply	Mean Well	ESP-240-54	CA3A072725

6.6 Changes made in the EUT

No changes were implemented.



6.7 Test configuration

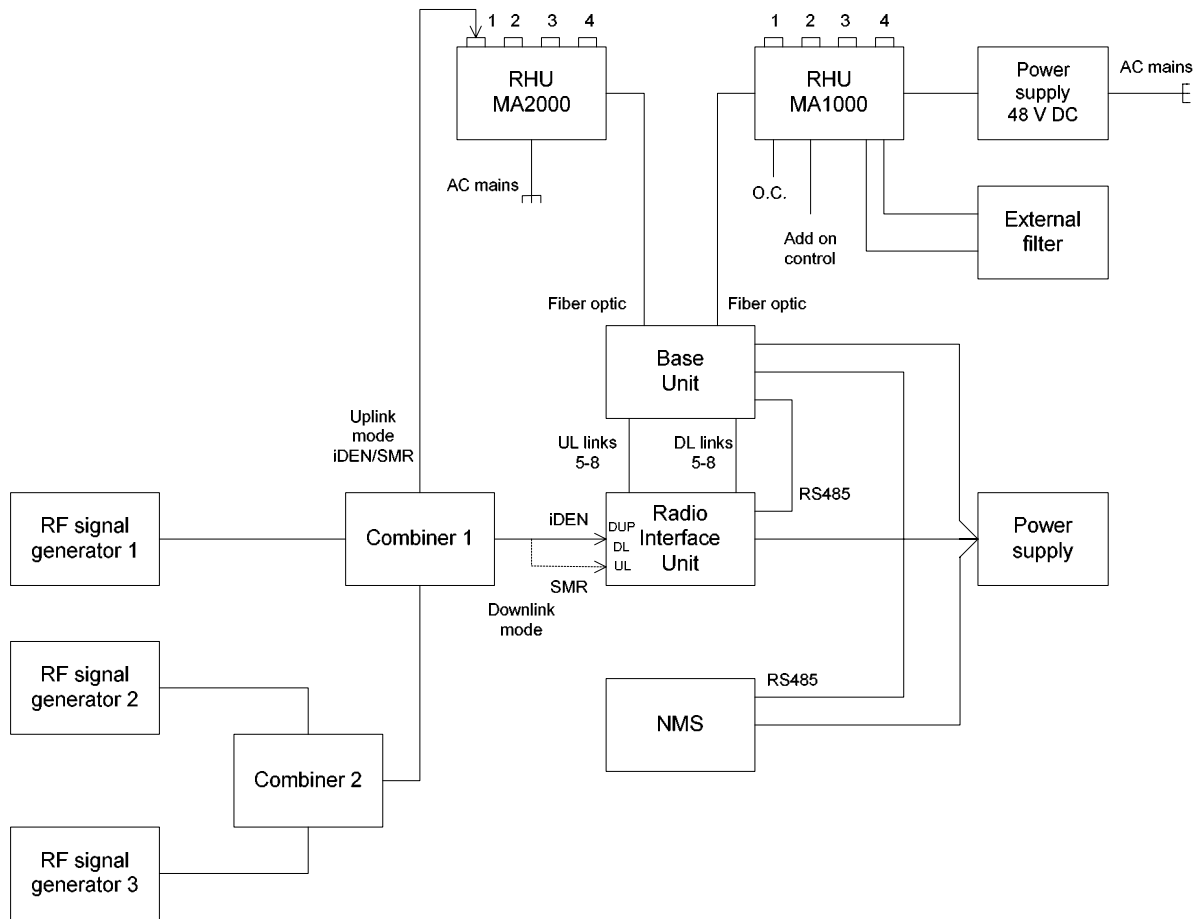



7 Transmitter tests

7.1 Peak output power test according to part 90 §§90.205 (j), 90.219

7.1.1 General

This test was performed to measure the peak output power at RF antenna connector. Specification test limits are given in Table 7.1.1.

Table 7.1.1 Peak output power limits for signal boosters

Assigned frequency range, MHz	Maximum peak output power	
	W	dBm
Above 150.0	5.0	37.0

7.1.2 Test procedure

7.1.2.1 The EUT was set up as shown in Figure 7.1.1, energized and its proper operation was checked.

7.1.2.2 The EUT was adjusted to produce maximum available to the end user RF output power.

7.1.2.3 The peak output power was measured with spectrum analyzer as provided in Table 7.1.2 and associated plots. The measurements were performed at the EUT input and output ports in downlink and uplink transmit modes of operation at maximum input signals for low, middle and high carrier (channel) frequencies.

Figure 7.1.1 Peak output power test setup

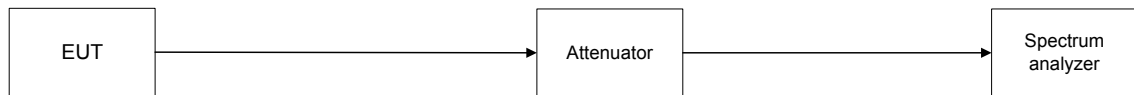



Table 7.1.2 Peak output power test results

DATE: December 26, 2004; April 3, 2005
RELATIVE HUMIDITY: 42 %
AMBIENT TEMPERATURE: 21°C
AIR PRESSURE: 1009 hPa
DETECTOR USED: Peak
RESOLUTION BANDWIDTH: 1 MHz
VIDEO BANDWIDTH: 3 MHz
TRANSMITTER OUTPUT POWER SETTINGS: Maximum

iDEN OPERATING FREQUENCY RANGE: 851 - 869 MHz (downlink)
806 - 824 MHz (uplink)
MODULATING SIGNAL: 16 QAM

Carrier frequency, MHz	Input port	Spectrum analyzer reading, dBm	External attenuation & cable loss, dB	RF output power, dBm	Limit, dBm	Margin*, dB	Verdict
Downlink transmit mode							
851.0125	DUP	22.75	included	22.75	37	-14.25	Pass
851.0125	DL	23.00	included	23.00	37	-14.00	Pass
858.5000	DUP	23.18	included	23.18	37	-13.72	Pass
858.5000	DL	22.59	included	22.59	37	-14.41	Pass
868.9875	DUP	19.50	included	19.50	37	-17.50	Pass
868.9875	DL	19.67	included	19.67	37	-17.33	Pass

SMR OPERATING FREQUENCY RANGE: 929 - 941 MHz (downlink)
896 - 902 MHz (uplink)
MODULATING SIGNAL: FM 12.5 kHz/1 kHz

Carrier frequency, MHz	Input port	Spectrum analyzer reading, dBm	External attenuation & cable loss, dB	RF output power, dBm	Limit, dBm	Margin*, dB	Verdict
Downlink transmit mode							
929.0125	DUP	17.73	included	17.73	37	-19.27	Pass
929.0125	DL	18.20	included	18.20	37	-18.80	Pass
935.0000	DUP	18.18	included	18.18	37	-18.82	Pass
935.0000	DL	18.12	included	18.12	37	-18.88	Pass
940.9875	DUP	19.16	included	19.16	37	-17.84	Pass
940.9875	DL	18.94	included	18.94	37	-18.05	Pass

*Margin = RF output power – specification limit

Reference numbers of test equipment used

HL 0053	HL 0056	HL 1455	HL 1463	HL 1481	HL 1653	HL 2254	
---------	---------	---------	---------	---------	---------	---------	--

Full description is given in Appendix A.



Plot 7.1.1 RF output power measurements at low frequency carrier. Port 1

OPERATIONAL MODE: SMR downlink transmit
INPUT PORT: DL
COMPOSITE INPUT POWER: 10 dBm

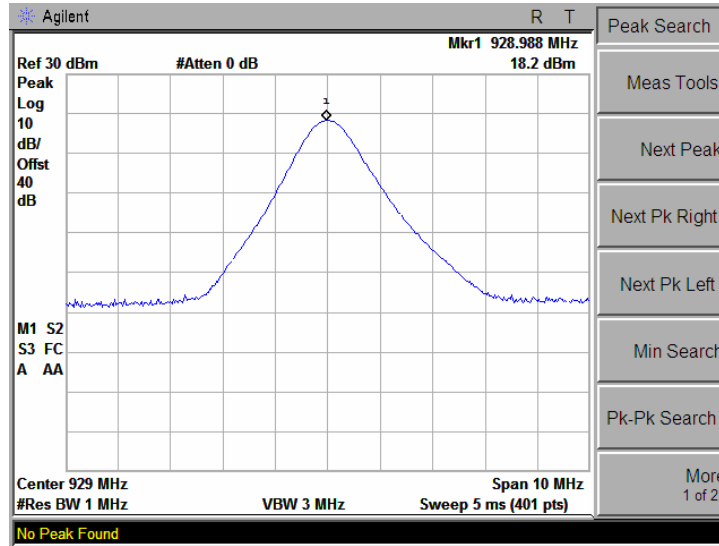

Plot 7.1.2 RF output power measurements at low frequency carrier. Port 2

OPERATIONAL MODE: SMR downlink transmit
INPUT PORT: DL
COMPOSITE INPUT POWER: 10 dBm

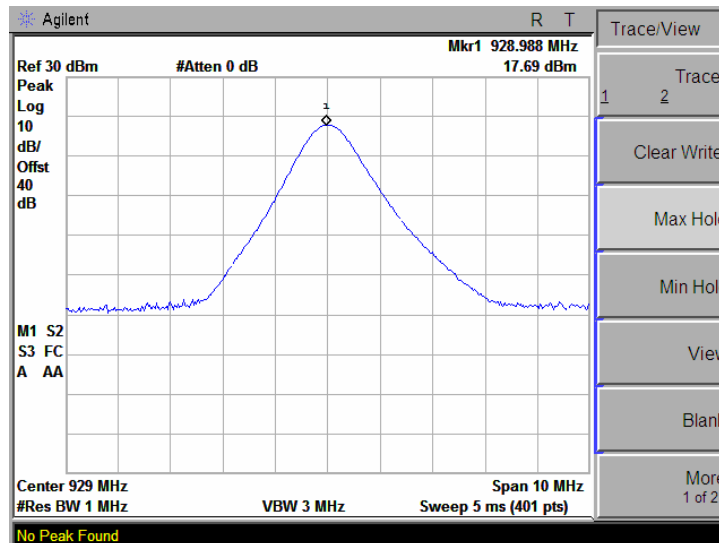



Plot 7.1.3 RF output power measurements at low frequency carrier. Port 3

OPERATIONAL MODE: SMR downlink transmit
INPUT PORT: DL
COMPOSITE INPUT POWER: 10 dBm

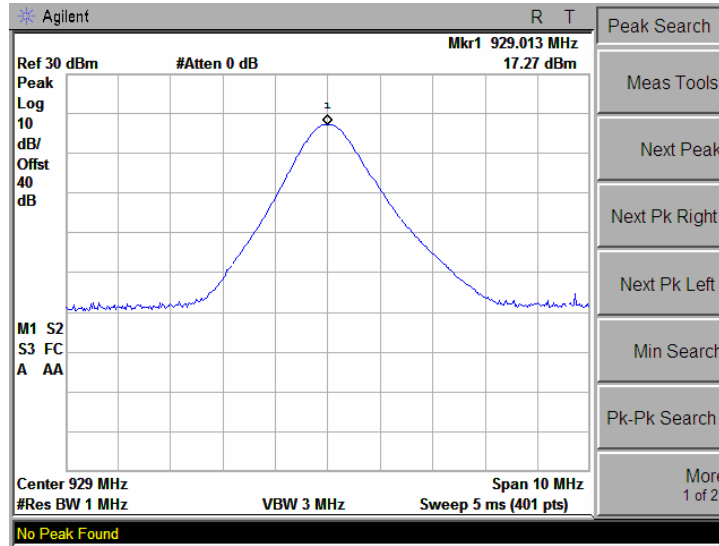

Plot 7.1.4 RF output power measurements at low frequency carrier. Port 4

OPERATIONAL MODE: SMR downlink transmit
INPUT PORT: DL
COMPOSITE INPUT POWER: 10 dBm

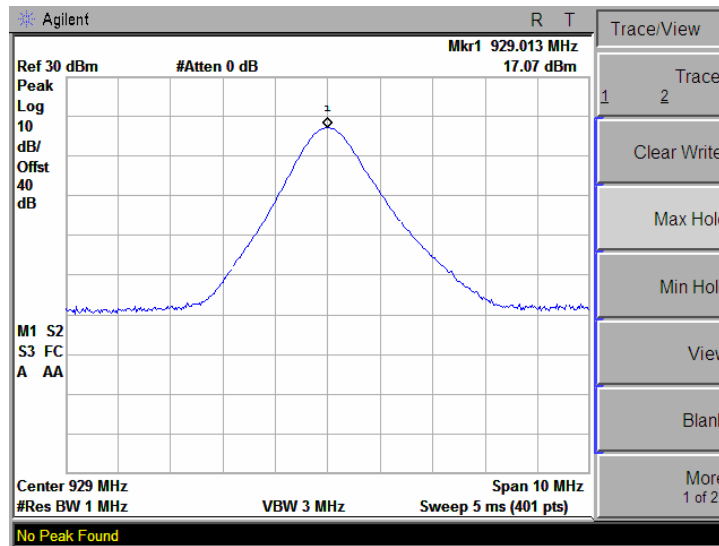



Plot 7.1.5 RF output power measurements at low frequency carrier. Port 1

OPERATIONAL MODE: SMR downlink transmit
INPUT PORT: DUP
COMPOSITE INPUT POWER: 10 dBm

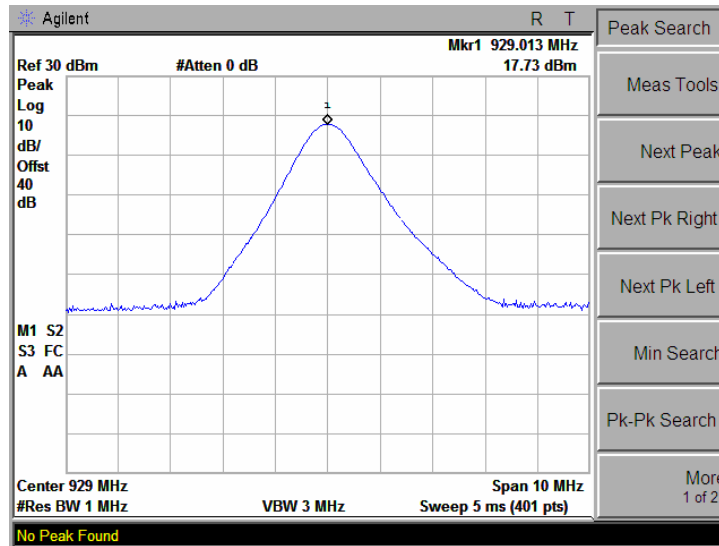



Plot 7.1.6 RF output power measurements at mid frequency carrier. Port 1

OPERATIONAL MODE: SMR downlink transmit
INPUT PORT: DUP
COMPOSITE INPUT POWER: 10 dBm

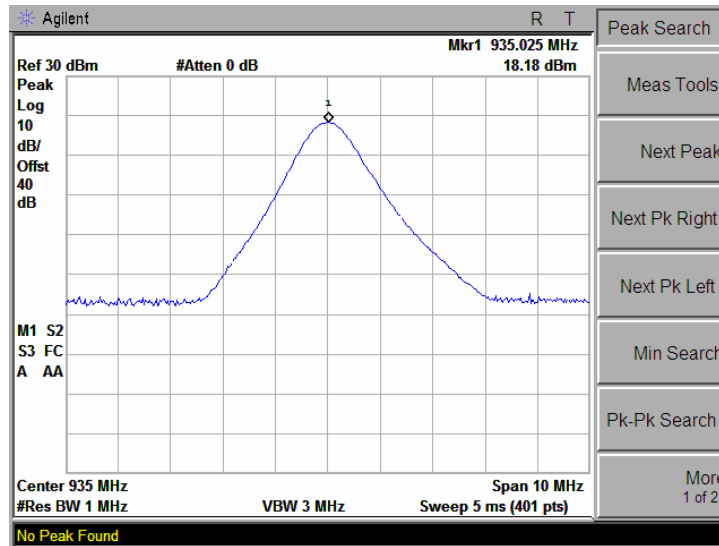

Plot 7.1.7 RF output power measurements at mid frequency carrier. Port 2

OPERATIONAL MODE: SMR downlink transmit
INPUT PORT: DUP
COMPOSITE INPUT POWER: 10 dBm

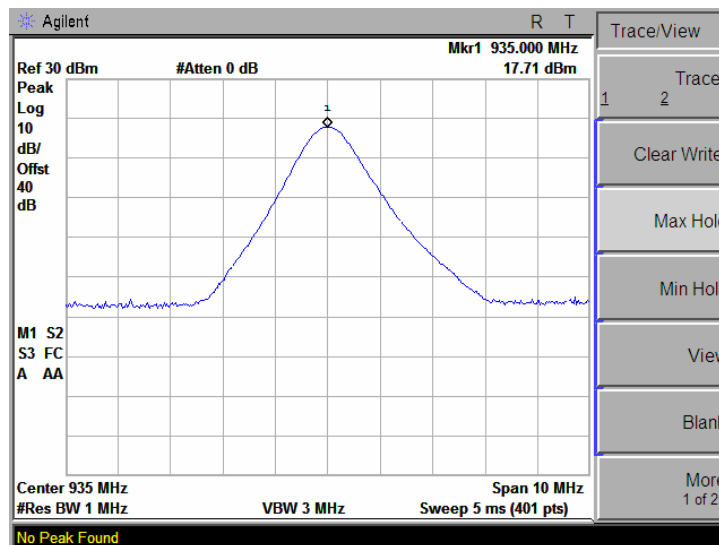



Plot 7.1.8 RF output power measurements at mid frequency carrier. Port 3

OPERATIONAL MODE: SMR downlink transmit
INPUT PORT: DUP
COMPOSITE INPUT POWER: 10 dBm

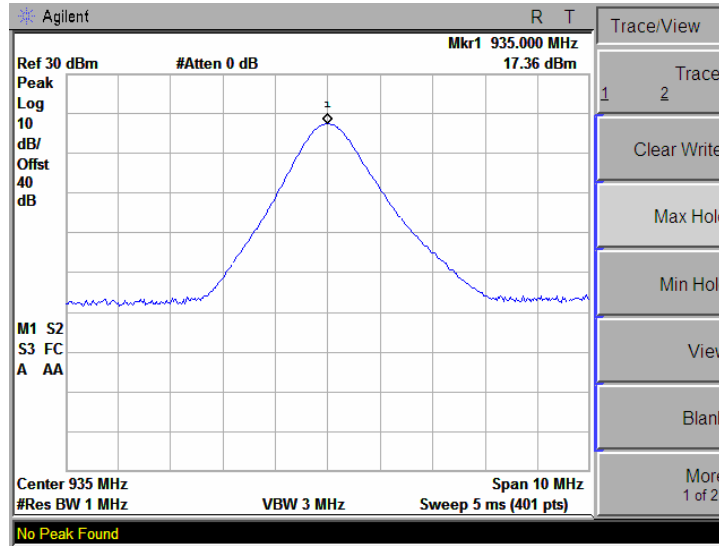

Plot 7.1.9 RF output power measurements at mid frequency carrier. Port 4

OPERATIONAL MODE: SMR downlink transmit
INPUT PORT: DUP
COMPOSITE INPUT POWER: 10 dBm

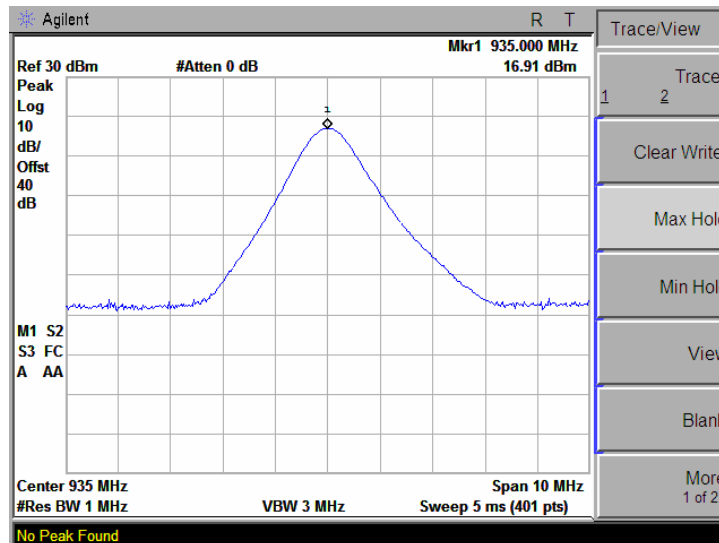



Plot 7.1.10 RF output power measurements at mid frequency carrier. Port 1

OPERATIONAL MODE: SMR downlink transmit
INPUT PORT: DL
COMPOSITE INPUT POWER: 10 dBm

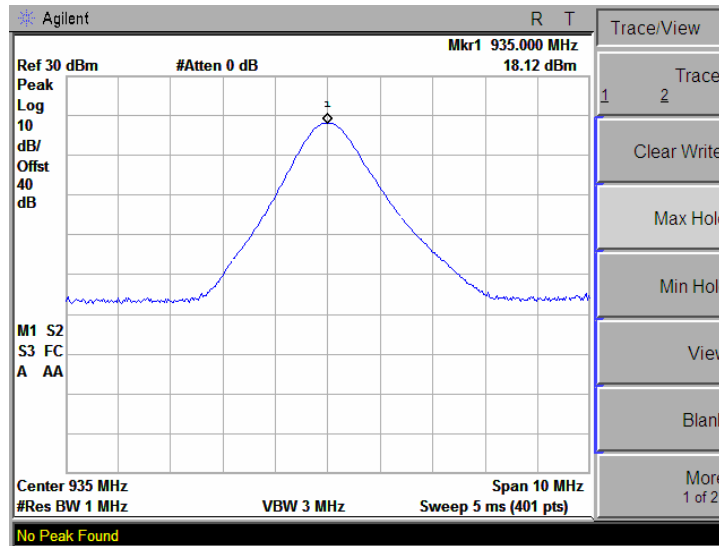



Plot 7.1.11 RF output power measurements at high frequency carrier. Port 1

OPERATIONAL MODE: SMR downlink transmit
INPUT PORT: DUP
COMPOSITE INPUT POWER: 10 dBm

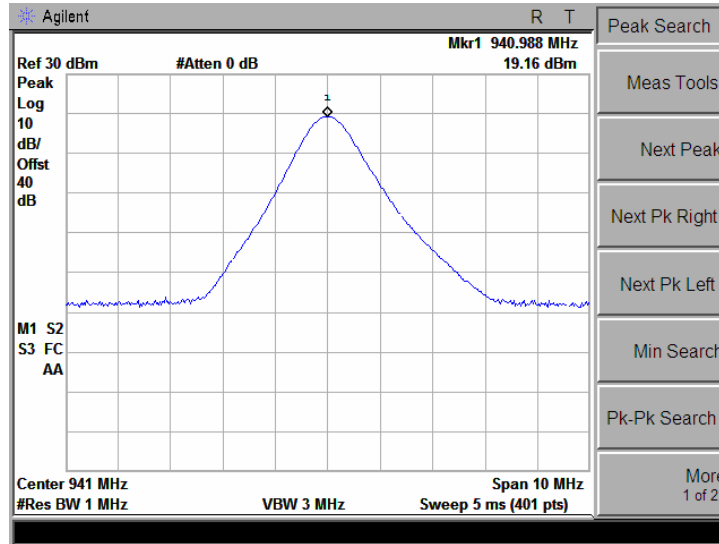

Plot 7.1.12 RF output power measurements at high frequency carrier. Port 2

OPERATIONAL MODE: SMR downlink transmit
INPUT PORT: DUP
COMPOSITE INPUT POWER: 10 dBm

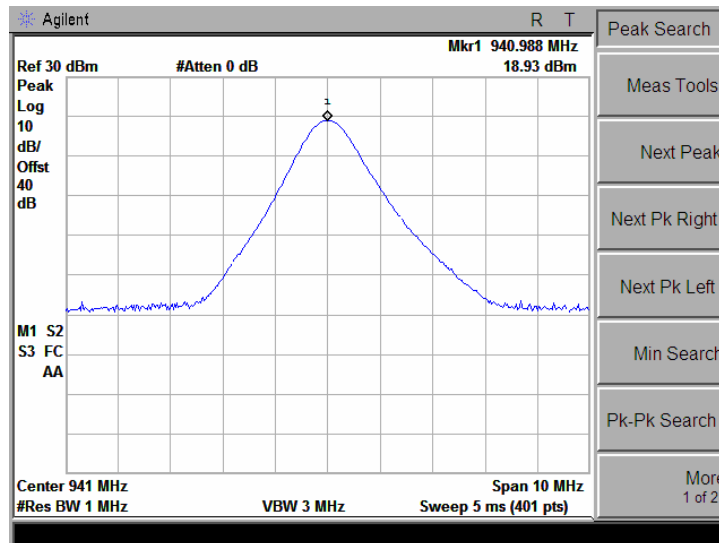



Plot 7.1.13 RF output power measurements at high frequency carrier. Port 3

OPERATIONAL MODE: SMR downlink transmit
INPUT PORT: DUP
COMPOSITE INPUT POWER: 10 dBm

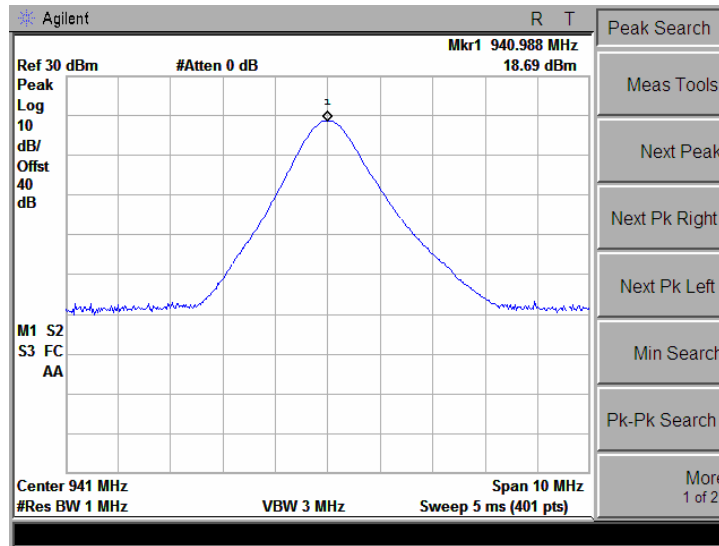

Plot 7.1.14 RF output power measurements at high frequency carrier. Port 4

OPERATIONAL MODE: SMR downlink transmit
INPUT PORT: DUP
COMPOSITE INPUT POWER: 10 dBm

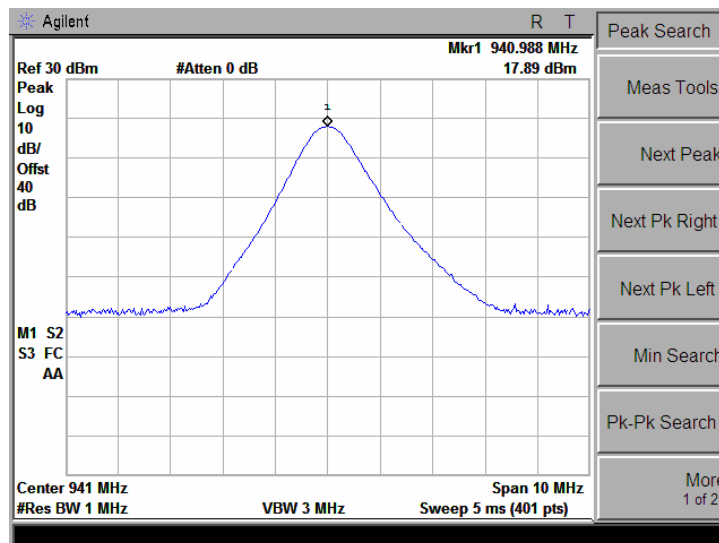



Plot 7.1.15 RF output power measurements at high frequency carrier. Port 1

OPERATIONAL MODE: SMR downlink transmit
INPUT PORT: DL
COMPOSITE INPUT POWER: 10 dBm

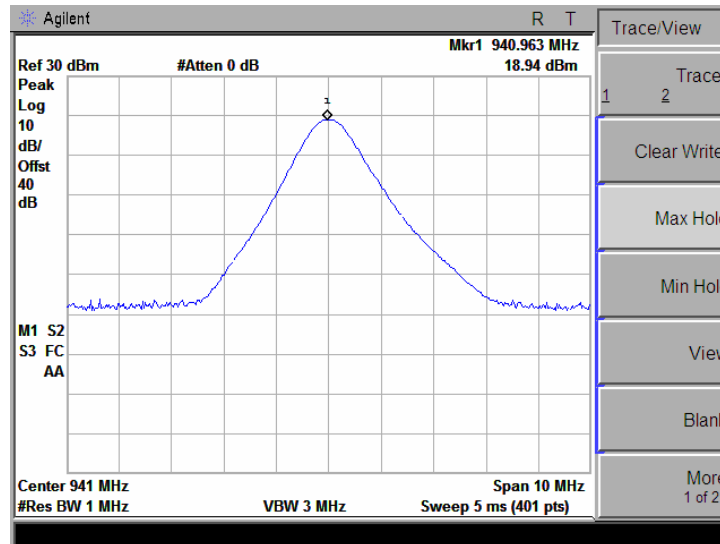



Plot 7.1.16 RF output power measurements at low frequency carrier. Port 1

OPERATIONAL MODE: iDEN downlink transmit
INPUT PORT: DUP
COMPOSITE INPUT POWER: 10 dBm

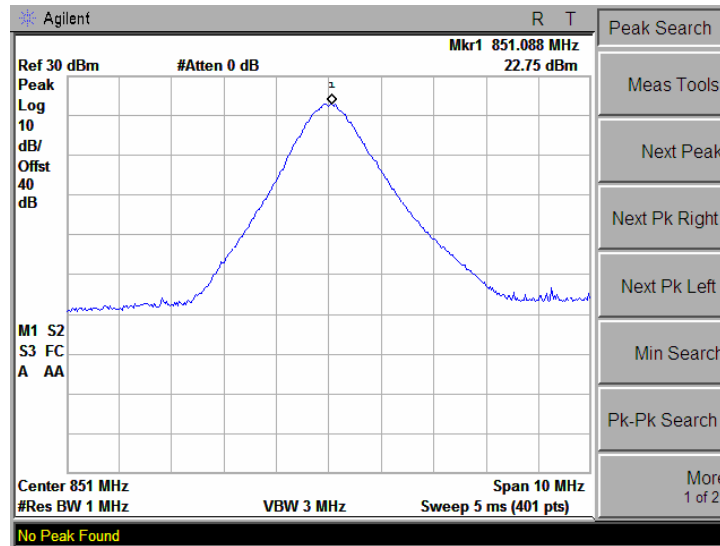

Plot 7.1.17 RF output power measurements at low frequency carrier. Port 2

OPERATIONAL MODE: iDEN downlink transmit
INPUT PORT: DUP
COMPOSITE INPUT POWER: 10 dBm

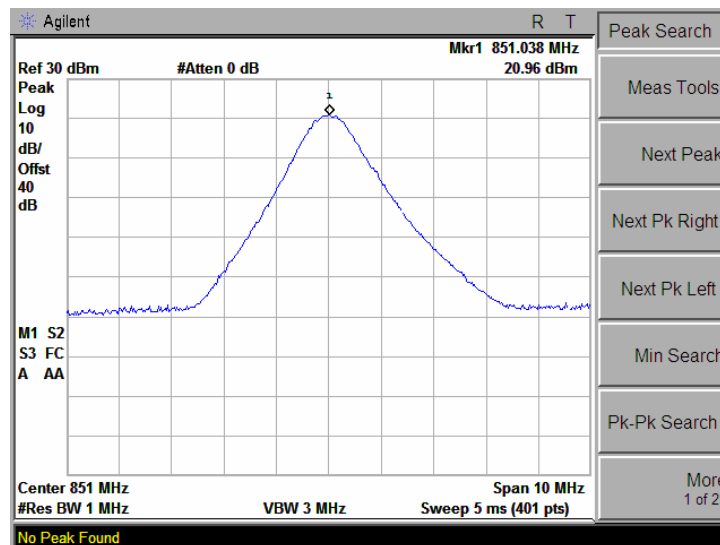



Plot 7.1.18 RF output power measurements at low frequency carrier. Port 3

OPERATIONAL MODE: iDEN downlink transmit
INPUT PORT: DUP
COMPOSITE INPUT POWER: 10 dBm

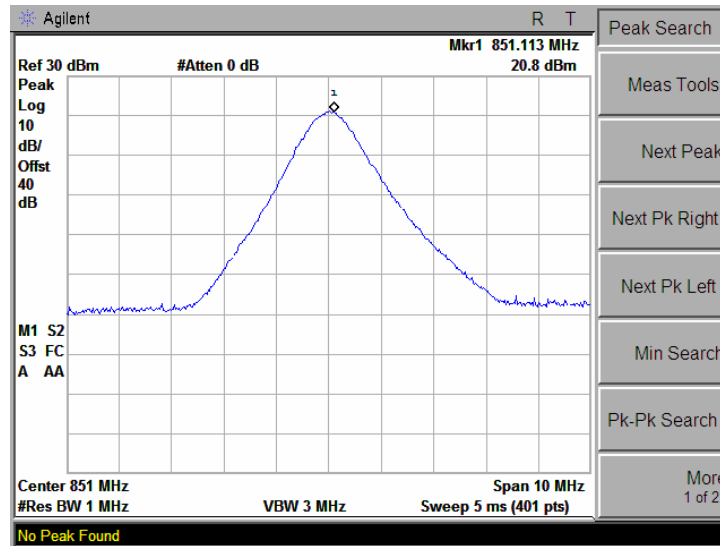

Plot 7.1.19 RF output power measurements at low frequency carrier. Port 4

OPERATIONAL MODE: iDEN downlink transmit
INPUT PORT: DUP
COMPOSITE INPUT POWER: 10 dBm

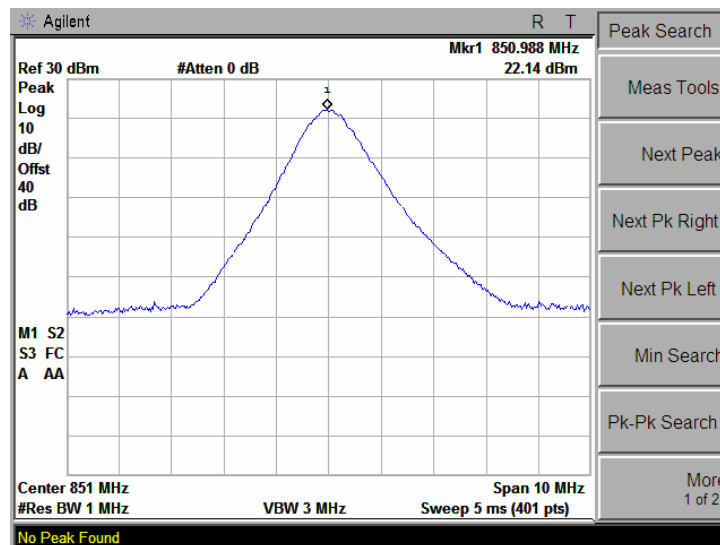



Plot 7.1.20 RF output power measurements at low frequency carrier. Port 1

OPERATIONAL MODE: iDEN downlink transmit
INPUT PORT: DL
COMPOSITE INPUT POWER: 10 dBm

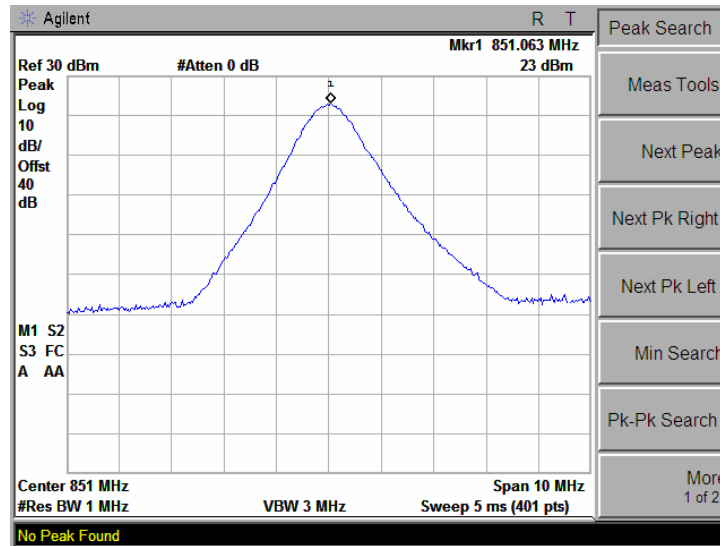



Plot 7.1.21 RF output power measurements at mid frequency carrier. Port 1

OPERATIONAL MODE: iDEN downlink transmit
INPUT PORT: DL
COMPOSITE INPUT POWER: 10 dBm

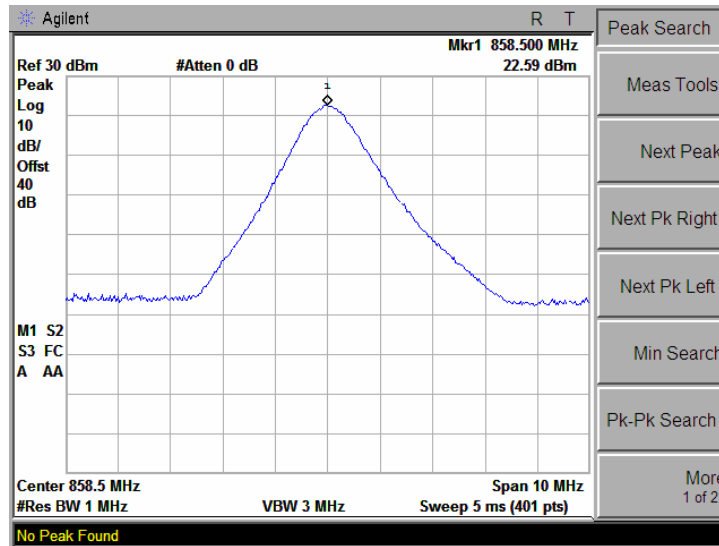

Plot 7.1.22 RF output power measurements at mid frequency carrier. Port 2

OPERATIONAL MODE: iDEN downlink transmit
INPUT PORT: DL
COMPOSITE INPUT POWER: 10 dBm

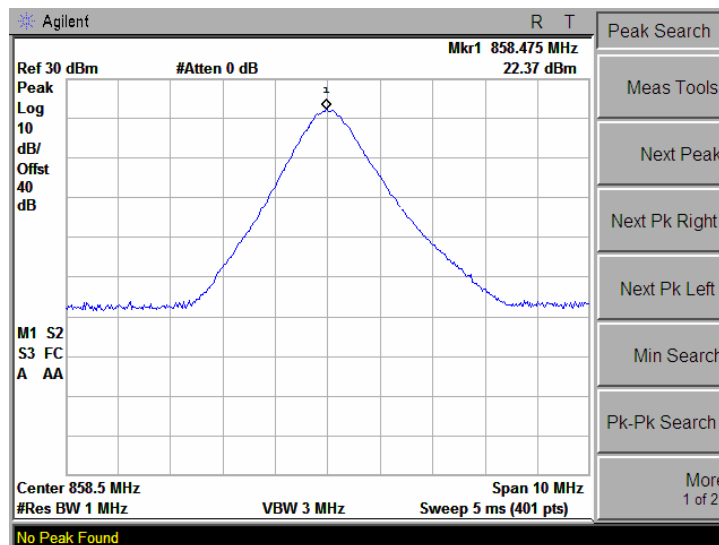



Plot 7.1.23 RF output power measurements at mid frequency carrier. Port 3

OPERATIONAL MODE: iDEN downlink transmit
INPUT PORT: DL
COMPOSITE INPUT POWER: 10 dBm

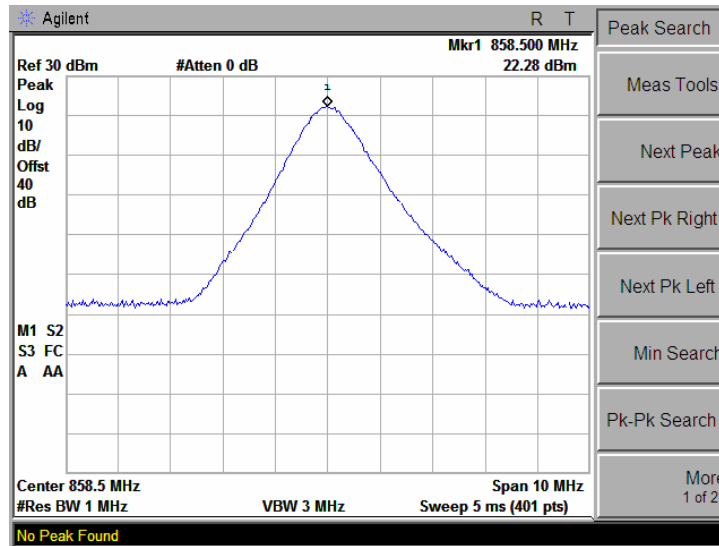

Plot 7.1.24 RF output power measurements at mid frequency carrier. Port 4

OPERATIONAL MODE: iDEN downlink transmit
INPUT PORT: DL
COMPOSITE INPUT POWER: 10 dBm

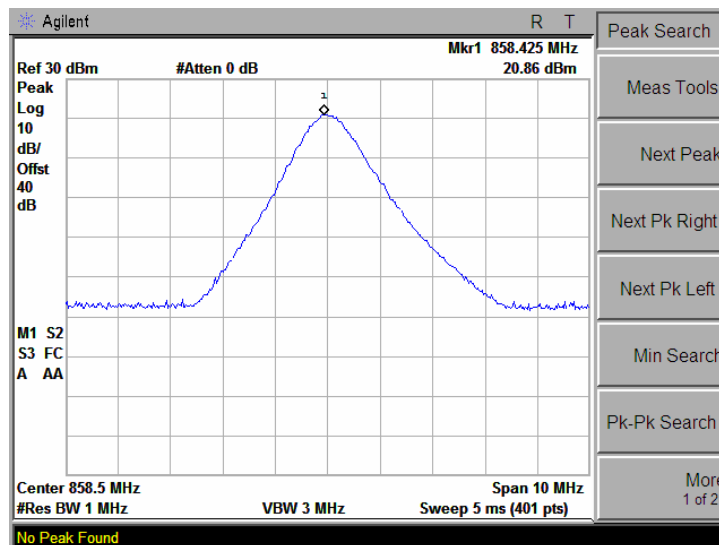



Plot 7.1.25 RF output power measurements at mid frequency carrier. Port 1

OPERATIONAL MODE: iDEN downlink transmit
INPUT PORT: DUP
COMPOSITE INPUT POWER: 10 dBm

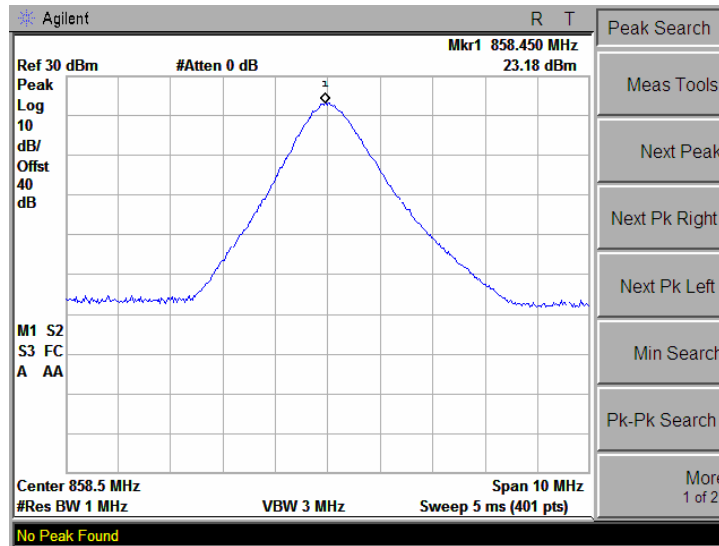



Plot 7.1.26 RF output power measurements at high frequency carrier. Port 1

OPERATIONAL MODE: iDEN downlink transmit
INPUT PORT: DUP
COMPOSITE INPUT POWER: 10 dBm

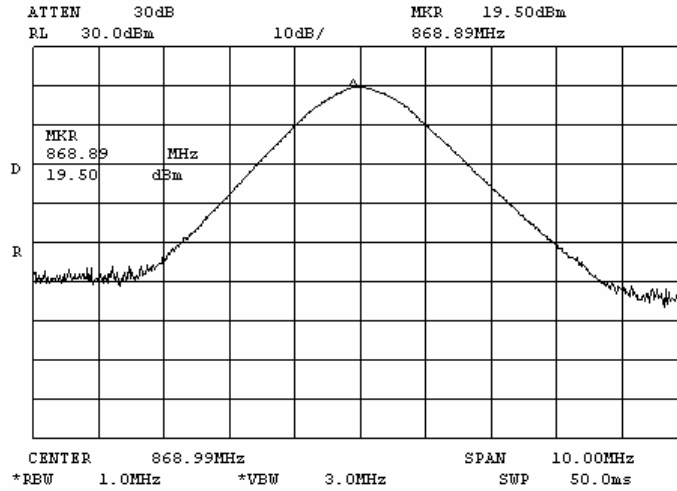

Plot 7.1.27 RF output power measurements at high frequency carrier. Port 2

OPERATIONAL MODE: iDEN downlink transmit
INPUT PORT: DUP
COMPOSITE INPUT POWER: 10 dBm

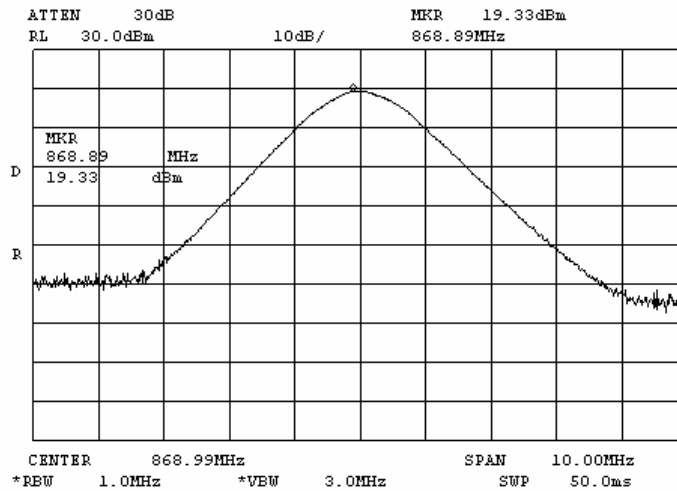



Plot 7.1.30 RF output power measurements at high frequency carrier. Port 1

OPERATIONAL MODE: iDEN downlink transmit
INPUT PORT: DL
COMPOSITE INPUT POWER: 10 dBm

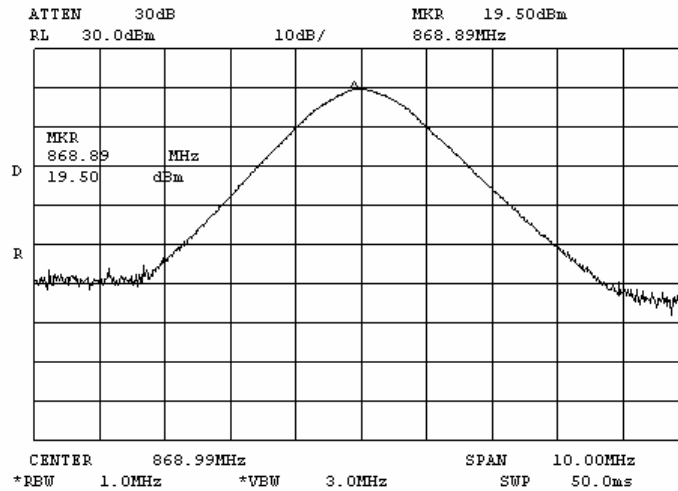

Plot 7.1.31 RF output power measurements at high frequency carrier. Port 2

OPERATIONAL MODE: iDEN downlink transmit
INPUT PORT: DL
COMPOSITE INPUT POWER: 10 dBm

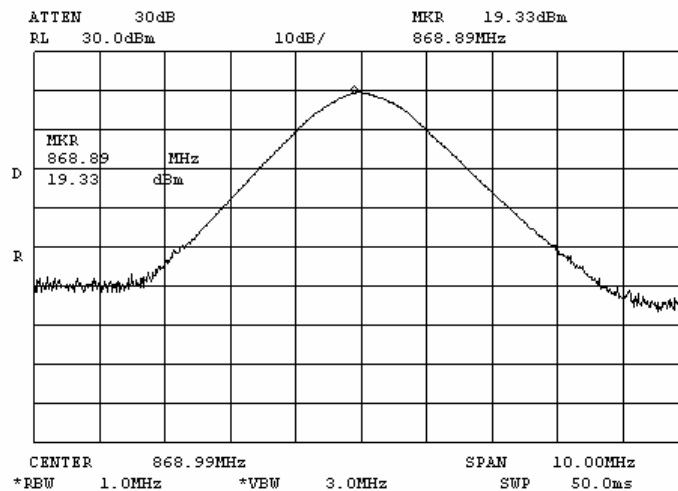



7.2 Occupied bandwidth according to part 90 §90.209(5)

7.2.1 General

This test was performed to measure transmitter occupied bandwidth. Specification test limits are given in Table 7.2.1. The test results are provided in Table 7.2.2 and the associated plots.

Table 7.2.1 Occupied bandwidth limits

Assigned frequency, MHz	Modulation envelope reference points*, dBc	Maximum allowed bandwidth, kHz
806 – 821/851 - 866	26	20

* - Modulation envelope reference points are provided in terms of attenuation below the unmodulated carrier.

7.2.2 Test procedure

- 7.2.2.1 The EUT was set up as shown in Figure 7.2.1, energized and its proper operation was checked.
- 7.2.2.2 The EUT was set to transmit the unmodulated carrier and the reference peak power level was measured.
- 7.2.2.3 The EUT was set to transmit the normally modulated carrier.
- 7.2.2.4 The transmitter occupied bandwidth was measured with spectrum analyzer as a frequency delta between the reference points on modulation envelope and provided in Table 7.2.2 and the associated plots. A comparison of the input signal bandwidth to the output signal was done: the blue graphs show input signal bandwidth, red graphs – output.
- 7.2.2.5 The measurements were performed at the EUT input and output ports in downlink and uplink transmit modes of operation for low, middle and high carrier (channel) frequencies.

Figure 7.2.1 Occupied bandwidth test setup

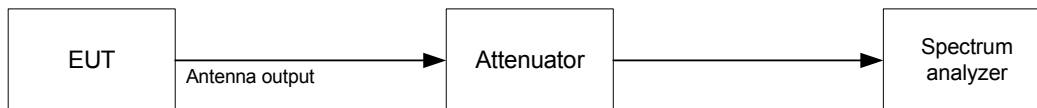

**Table 7.2.2 Occupied bandwidth test results**

DATE: December 27, 2004; April 4, 2005
RELATIVE HUMIDITY: 35 %
AMBIENT TEMPERATURE: 24°C
AIR PRESSURE: 1009 hPa
DETECTOR USED: Peak hold
RESOLUTION BANDWIDTH: 300 Hz
VIDEO BANDWIDTH: 1 kHz
MODULATION ENVELOPE REFERENCE POINTS: 26 dBc

iDEN OPERATING FREQUENCY RANGE: 851 - 869 MHz (downlink)
806 - 824 MHz (uplink)
MODULATING SIGNAL: 16 QAM

Carrier frequency, MHz	Output port	Occupied bandwidth, kHz	Limit, kHz	Margin, kHz	Verdict
Downlink transmit mode					
851.0125	1	9.70	20	-10.30	Pass
858.5000	1	9.80	20	-10.20	Pass
868.9875	2	9.75	20	-10.25	Pass

SMR OPERATING FREQUENCY RANGE: 929 - 941 MHz (downlink)
896 - 902 MHz (uplink)
MODULATING SIGNAL: FM 12.5 kHz/1 kHz

Carrier frequency, MHz	Output port	Occupied bandwidth, kHz	Limit, kHz	Margin, kHz	Verdict
Downlink transmit mode					
929.0125	1	32.00	NA	NA	Pass
935.0000	1	32.00	NA	NA	Pass
940.9875	1	32.00	NA	NA	Pass

Reference numbers of test equipment used

HL 0053	HL 0056	HL 1455	HL 1463	HL 1481	HL 1653	HL 2254	
---------	---------	---------	---------	---------	---------	---------	--

Full description is given in Appendix A.



Plot 7.2.1 Occupied bandwidth measurements at low frequency carrier. Port 1

OPERATIONAL MODE: iDEN downlink transmit
INPUT PORT: DL
COMPOSITE INPUT POWER: 10 dBm

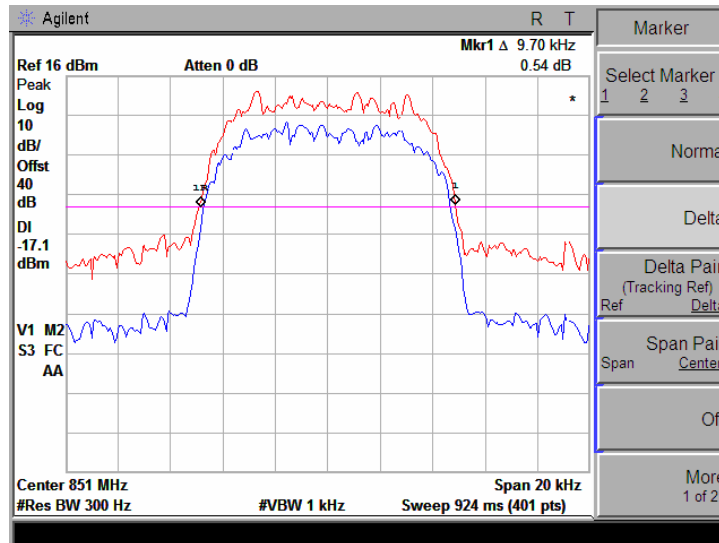

Plot 7.2.2 Occupied bandwidth measurements at mid frequency carrier. Port 1

OPERATIONAL MODE: iDEN downlink transmit
INPUT PORT: DUP
COMPOSITE INPUT POWER: 10 dBm

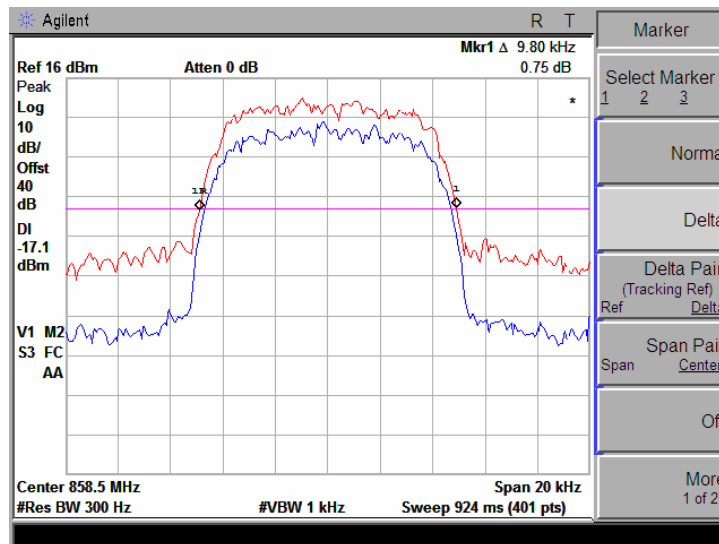



Plot 7.2.3 Occupied bandwidth measurements at high frequency carrier. Port 2

OPERATIONAL MODE: iDEN downlink transmit
INPUT PORT: DUP
COMPOSITE INPUT POWER: 10 dBm

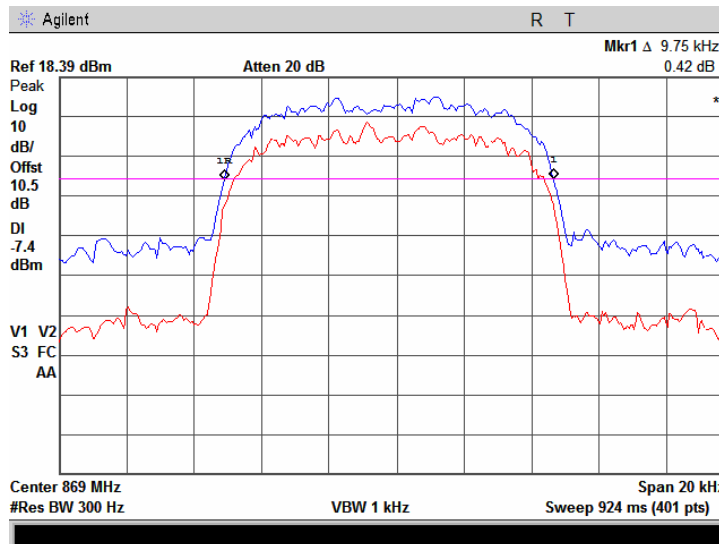

Plot 7.2.4 Occupied bandwidth measurements at low frequency carrier. Port 1

OPERATIONAL MODE: SMR downlink transmit
INPUT PORT: DL
COMPOSITE INPUT POWER: 10 dBm

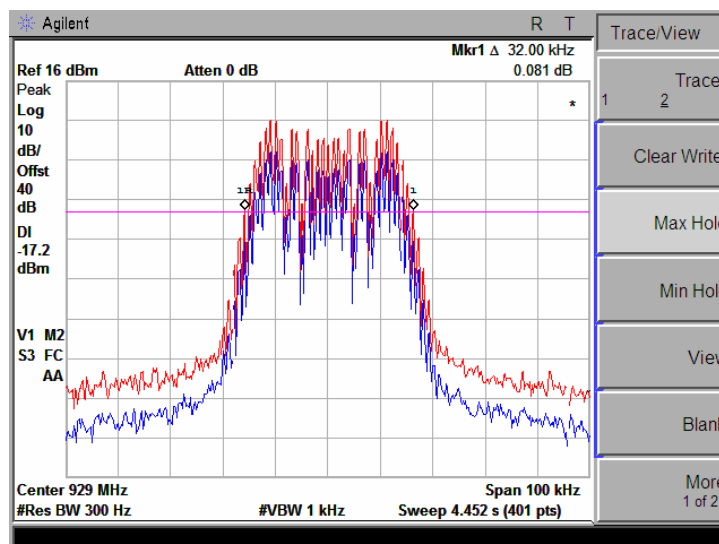



Plot 7.2.5 Occupied bandwidth measurements at mid frequency carrier. Port 1

OPERATIONAL MODE: SMR downlink transmit
INPUT PORT: DUP
COMPOSITE INPUT POWER: 10 dBm

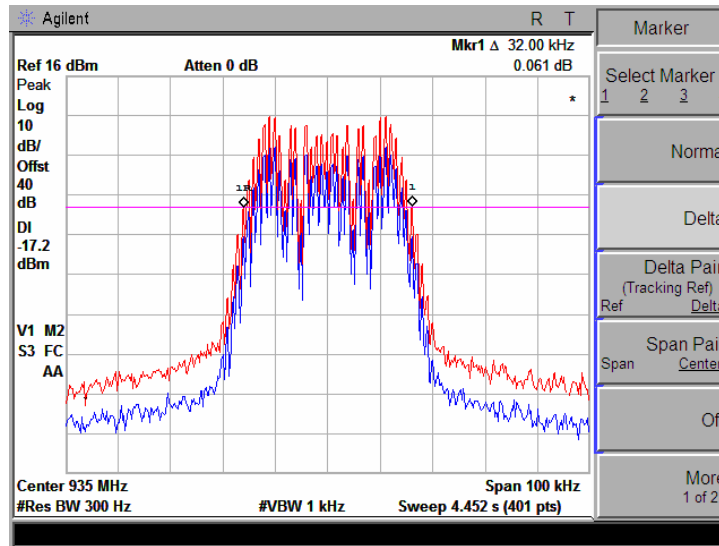

Plot 7.2.6 Occupied bandwidth measurements at high frequency carrier. Port 1

OPERATIONAL MODE: SMR downlink transmit
INPUT PORT: DUP
COMPOSITE INPUT POWER: 10 dBm

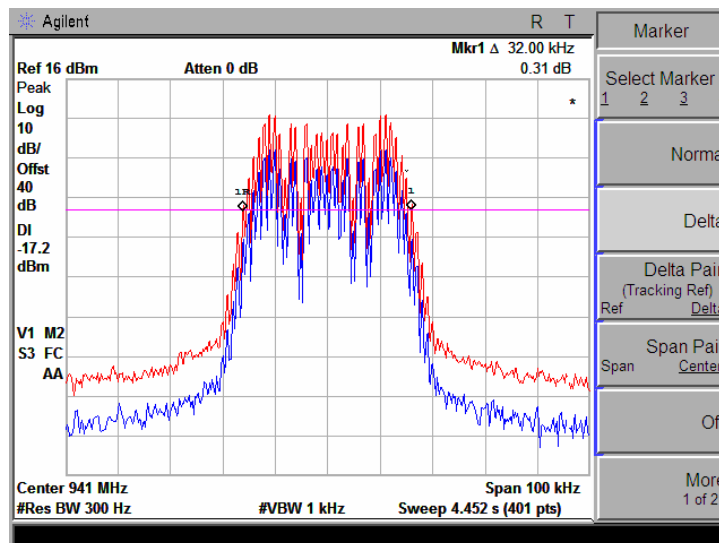



7.3 Emission mask test according to part 90 §§90.210(g), 90.210(j), 90.691

7.3.1 General

This test was performed to measure emission mask at RF antenna connector. Specification test limits are given in Table 7.3.1. The test results are provided in the associated plots.

Table 7.3.1 Emission mask limits

Frequency displacement from carrier	Attenuation below carrier, dBc
Emission mask G (Channel bandwidth 25.0 kHz, authorized bandwidth 20.0 kHz)	
0 – 5.0 kHz	0
5.0 – 10.0 kHz	0 – 25.0*
10.0 – 50.0 kHz	116 log (fd/6.1) or 50+10 log P(W) or 70.0, whichever is the lesser
More than 50.0 kHz**	43+10 log P(W)
Emission mask J (Channel bandwidth 12.5 kHz, authorized bandwidth 13.6 kHz)	
0 – 2.5 kHz	0
2.5 kHz – 6.25 kHz	0 – 21.0*
6.25 – 9.5 kHz	21.0 – 39.8*
More than 9.5 kHz	157 log (fd/5.3) or 50+10log P(W) or 70.0, whichever is the lesser
Emission mask §90.691	
0 – 12.5 kHz	0
12.5 kHz – 37.5 kHz	116 log (f / 6.1) dB or 50 + 10 log (P) dB or 80 dB, whichever is the lesser
More than 37.5 kHz	43+10 log P(W) or 80.0 whichever is the lesser

* - linearly increase with frequency

** - emission mask includes carrier modulation envelope within ± 250 % of the authorized bandwidth; the frequency range removed beyond ± 250 % of the authorized bandwidth from carrier was investigated as spurious emission

7.3.2 Test procedure

7.3.2.1 The EUT was set up as shown in Figure 7.3.1, energized and its proper operation was checked.

7.3.2.2 The emission mask was measured with spectrum analyzer as provided in the associated plots.

Table 7.3.2 Emission mask test results

Carrier frequency, MHz	Limit	Verdict
851 - 866	Emission mask G (§90.210) / §90.691	Pass
866 - 869	Emission mask H (§90.210)	
929 - 941	Emission mask G / J (§90.210)	

Reference numbers of test equipment used

HL 0053	HL 0056	HL 1455	HL 1463	HL 1481	HL 1653	HL 2254	
---------	---------	---------	---------	---------	---------	---------	--

Full description is given in Appendix A.



Figure 7.3.1 Emission mask test setup





Plot 7.3.1 Emission mask measurements according to §90.210(g) at low frequency carrier. Port 1

OPERATIONAL MODE: iDEN downlink transmit
INPUT PORT: DL
COMPOSITE INPUT POWER: 10 dBm
INPUT SIGNAL MODULATION: 16 QAM, 7 kbps, 4 bit/sym

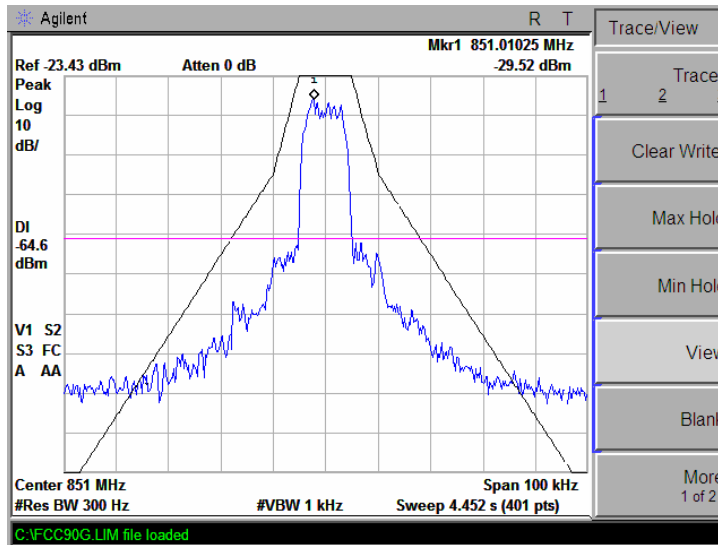

Plot 7.3.2 Emission mask measurements according to §90.691 at low frequency carrier. Port 1

OPERATIONAL MODE: iDEN downlink transmit
INPUT PORT: DL
COMPOSITE INPUT POWER: 10 dBm
INPUT SIGNAL MODULATION: 16 QAM, 7 kbps, 4 bit/sym

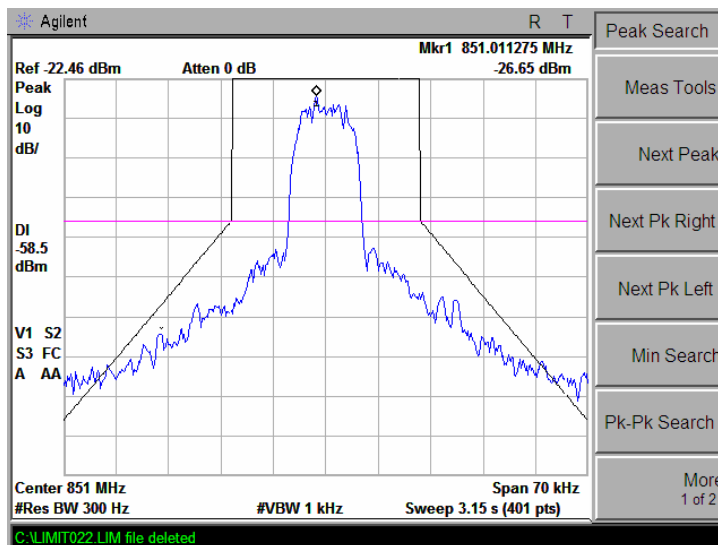



Plot 7.3.3 Emission mask measurements according to §90.210(g) at mid frequency carrier. Port 1

OPERATIONAL MODE: iDEN downlink transmit
INPUT PORT: DUP
COMPOSITE INPUT POWER: 10 dBm
INPUT SIGNAL MODULATION: 16 QAM, 7 kbps, 4 bit/sym

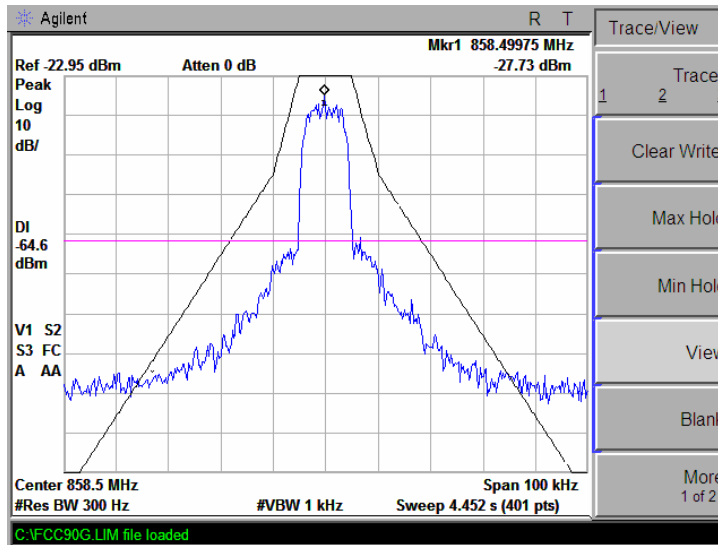

Plot 7.3.4 Emission mask measurements according to §90.691 at mid frequency carrier. Port 1

OPERATIONAL MODE: iDEN downlink transmit
INPUT PORT: DUP
COMPOSITE INPUT POWER: 10 dBm
INPUT SIGNAL MODULATION: 16 QAM, 7 kbps, 4 bit/sym

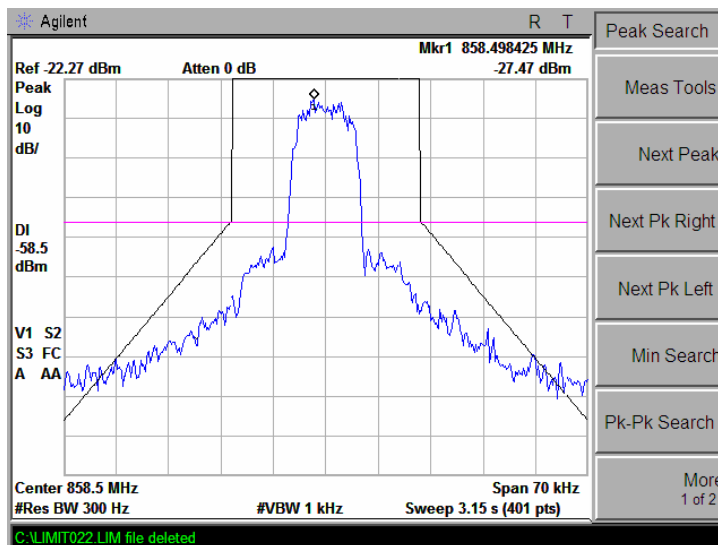



Plot 7.3.5 Emission mask measurements according to §90.210(g) at high frequency carrier. Port 1

OPERATIONAL MODE:	iDEN downlink transmit
INPUT PORT:	DUP
COMPOSITE INPUT POWER:	12.5 dBm
INPUT SIGNAL MODULATION:	16 QAM, 7.5 kbps, 4 bit/sym

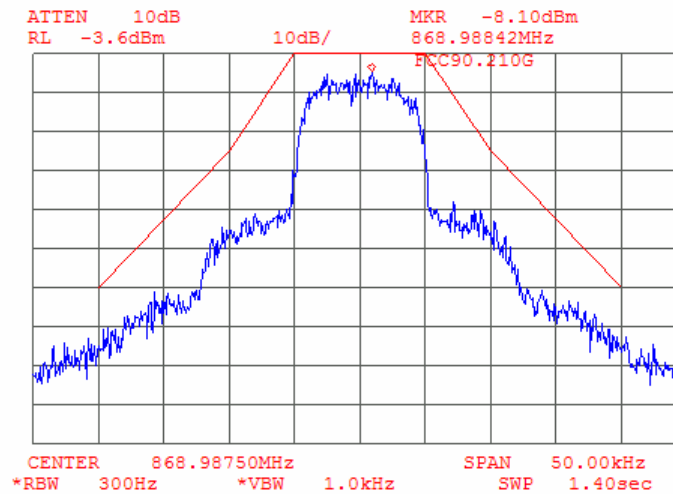

Plot 7.3.6 Emission mask measurements according to §90.691 at high frequency carrier. Port 1

OPERATIONAL MODE:	iDEN downlink transmit
INPUT PORT:	DUP
COMPOSITE INPUT POWER:	12.5 dBm
INPUT SIGNAL MODULATION:	16 QAM, 7.5 kbps, 4 bit/sym

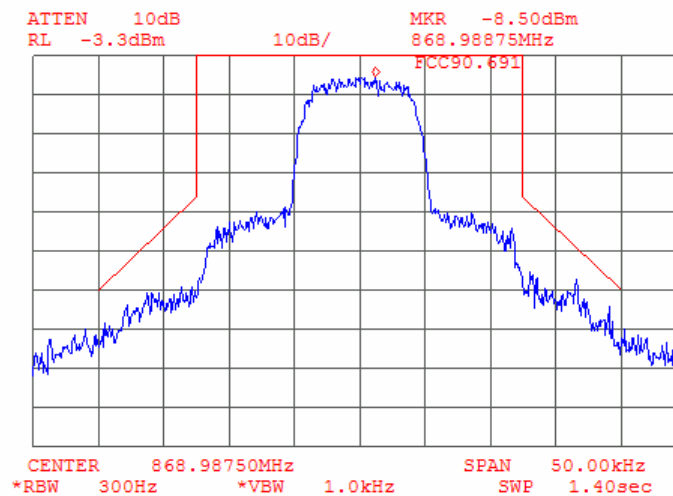



Plot 7.3.7 Emission mask measurements according to §90.210(h) at high frequency carrier. Port 1

OPERATIONAL MODE:	iDEN downlink transmit
INPUT SIGNAL:	16QAM 7.5 kbps
INPUT PORT:	DUP
COMPOSITE INPUT POWER:	12.5 dBm

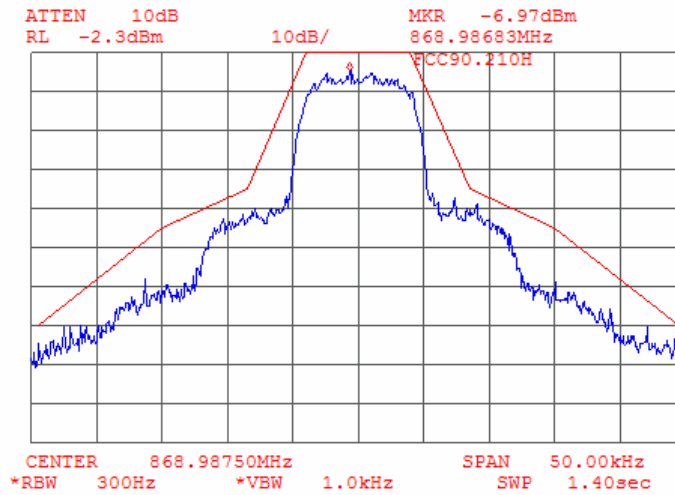



Plot 7.3.8 Emission mask measurements according to §90.210(j) at low frequency carrier. Port 1

OPERATIONAL MODE: SMR downlink transmit
INPUT PORT: DL
COMPOSITE INPUT POWER: 10 dBm
INPUT SIGNAL MODULATION: FM 2.5 kHz / 1 kHz

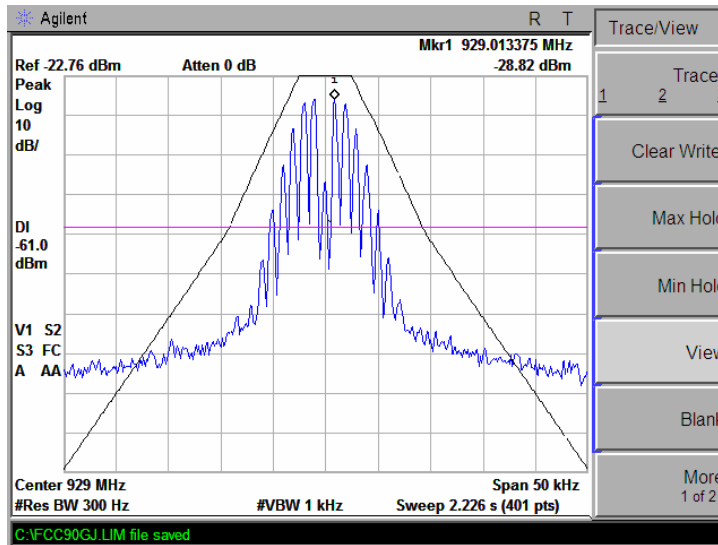

Plot 7.3.9 Emission mask measurements according to §90.210(g) at low frequency carrier. Port 1

OPERATIONAL MODE: SMR downlink transmit
INPUT PORT: DL
COMPOSITE INPUT POWER: 10 dBm
INPUT SIGNAL MODULATION: FM 5 kHz / 1 kHz

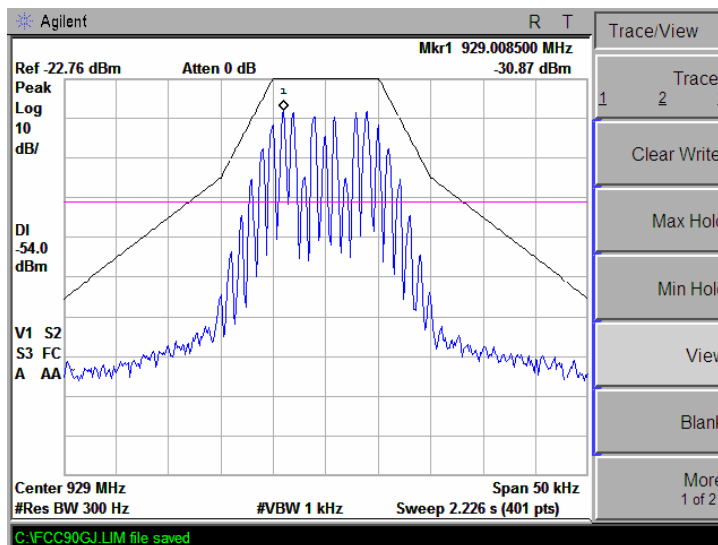



Plot 7.3.10 Emission mask measurements according to §90.210(j) at mid frequency carrier. Port 1

OPERATIONAL MODE: SMR downlink transmit
INPUT PORT: DUP
COMPOSITE INPUT POWER: 10 dBm
INPUT SIGNAL MODULATION: FM 2.5 kHz / 1 kHz

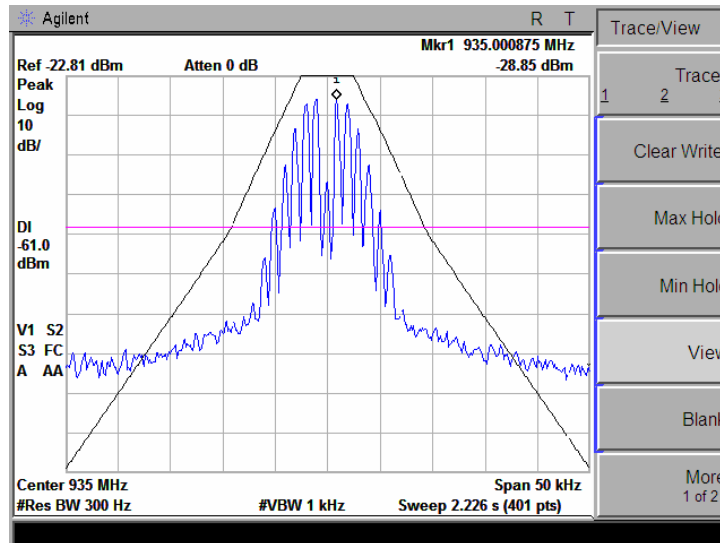

Plot 7.3.11 Emission mask measurements according to §90.210(g) at mid frequency carrier. Port 1

OPERATIONAL MODE: SMR downlink transmit
INPUT PORT: DUP
COMPOSITE INPUT POWER: 10 dBm
INPUT SIGNAL MODULATION: FM 5 kHz / 1 kHz

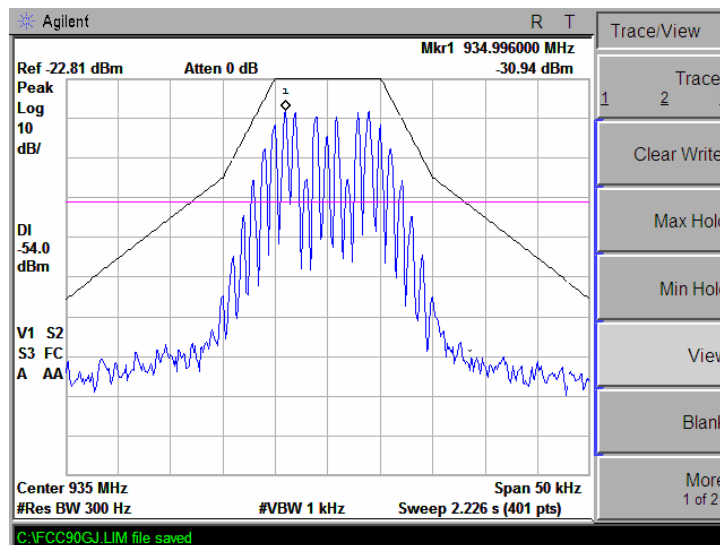



Plot 7.3.12 Emission mask measurements according to §90.210(j) at high frequency carrier. Port 1

OPERATIONAL MODE: SMR downlink transmit
INPUT PORT: DUP
COMPOSITE INPUT POWER: 10 dBm
INPUT SIGNAL MODULATION: FM 2.5 kHz / 1 kHz

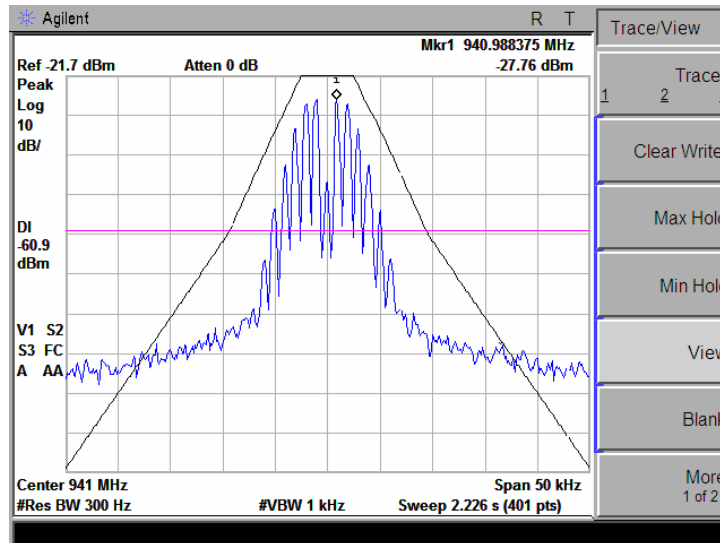

Plot 7.3.13 Emission mask measurements according to §90.210(g) at high frequency carrier. Port 1

OPERATIONAL MODE: SMR downlink transmit
INPUT PORT: DUP
COMPOSITE INPUT POWER: 10 dBm
INPUT SIGNAL MODULATION: FM 5 kHz / 1 kHz

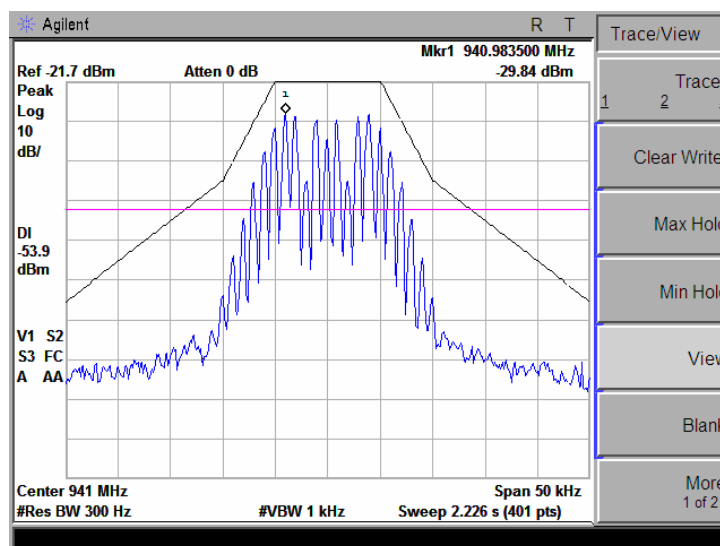



7.4 Spurious emissions at RF antenna connector test according to part 90 §90.210

7.4.1 General

This test was performed to measure spurious emissions and intermodulation products at RF antenna connector. Specification test limits are given in Table 7.4.1. The test results are provided in Table 7.4.2 and associated plots.

Table 7.4.1 Spurious emission limits

Frequency, MHz	Attenuation below carrier, dBc	ERP of spurious, dBm
0.009 – 10th harmonic*	$43+10\log P^{**}$	-13.0

* - spurious emission limits do not apply to the in band emission within $\pm 250\%$ of the authorized bandwidth from the carrier; investigated in course of emission mask testing

** - P is transmitter output power in Watts

7.4.2 Test procedure

7.4.2.1 The EUT was set up as shown in Figure 7.4.1, energized and its proper operation was checked.

7.4.2.2 The EUT was adjusted to produce maximum available for end user RF output power.

7.4.2.3 Three carrier (channel) signals of an equal magnitude at their highest rated output level, CW, two at one edge and one at the other edge of the assigned band, were applied to the EUT input.

7.4.2.4 The spurious emission was measured with spectrum analyzer in the frequency range from 9 kHz up to 10 GHz beyond $\pm 250\%$ of the authorized bandwidth from the carrier as provided in Table 7.4.2 and associated plots.

Figure 7.4.1 Spurious emission test setup

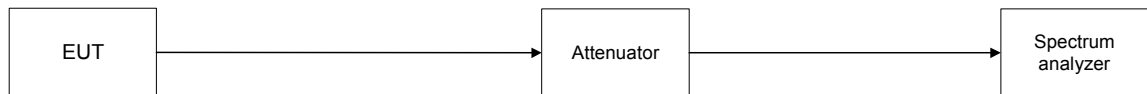

**Table 7.4.2 Spurious emission test results**

INVESTIGATED FREQUENCY RANGE: 0.009 – 10000 MHz
DETECTOR USED: Peak
VIDEO BANDWIDTH: \geq Resolution bandwidth

iDEN modulation 15.5 dBm @ 851.0125 MHz
15.5 dBm @ 851.0375 MHz
15.5 dBm @ 868.9875 MHz

Frequency, MHz	SA reading, dBm	Attenuator, dB	Cable loss, dB	RBW, kHz	Spurious emission, dBm	Limit, dBm	Margin, dB*	Verdict
2573.300	-31.37	included	included	1000	-31.37	-13	-18.37	Pass

SMR modulation 15.5 dBm @ 929.0125 MHz
15.5 dBm @ 929.0375 MHz
15.5 dBm @ 940.9875 MHz

Frequency, MHz	SA reading, dBm	Attenuator, dB	Cable loss, dB	RBW, kHz	Spurious emission, dBm	Limit, dBm	Margin, dB*	Verdict
916.000	-26.00	included	included	100	-26.00	-20	-6.00	Pass
952.875	-37.83	included	included	100	-37.83	-20	-17.83	Pass
7360.000	-29.67	included	included	1000	-29.67	-20	-9.67	Pass

*- Margin = Spurious emission – specification limit.
Pass outside the intended bands

Reference numbers of test equipment used

HL 0659	HL 1424	HL 1453	HL 1455	HL 1463	HL 1480	HL 1481	HL 1908
HL 2254	HL 2524						

Full description is given in Appendix A.



Plot 7.4.4 Conducted spurious emissions measurements from 800.0 to 1000 MHz at port 1

OPERATIONAL MODE: iDEN downlink transmit
INPUT PORT: DUP
COMPOSITE INPUT POWER: 12.5 dBm

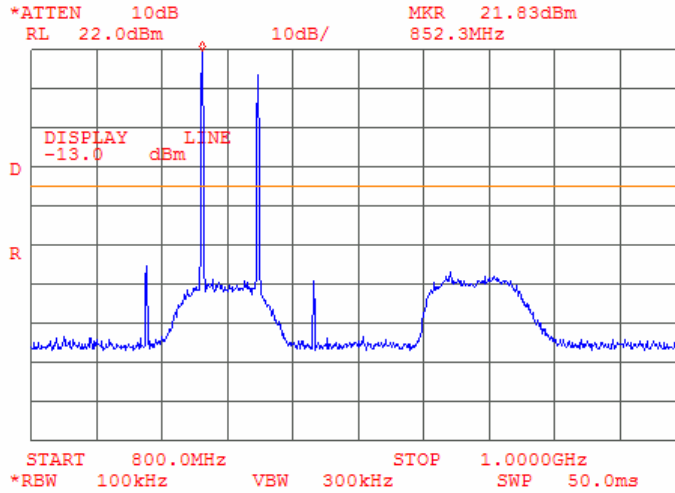

Plot 7.4.5 Conducted spurious emissions measurements from 1.0 to 10.0 GHz at port 1

OPERATIONAL MODE: iDEN downlink transmit
INPUT PORT: DUP
COMPOSITE INPUT POWER: 12.5 dBm

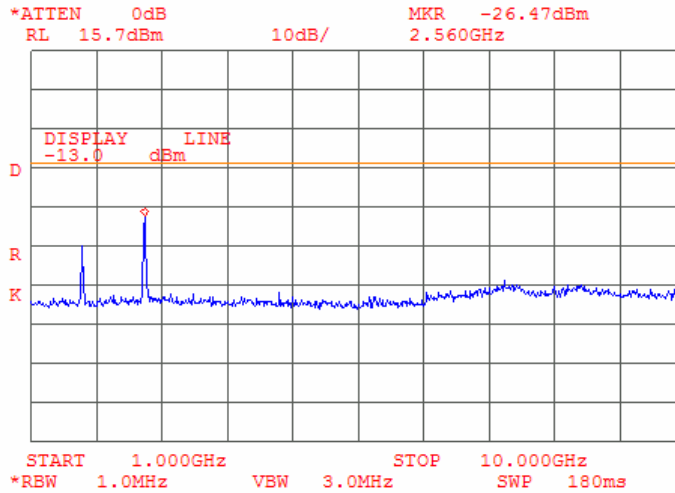



Plot 7.4.6 Conducted spurious emission measurements at 1.7 GHz at port 1

OPERATIONAL MODE: iDEN downlink transmit
INPUT PORT: DUP
COMPOSITE INPUT POWER: 12.5 dBm

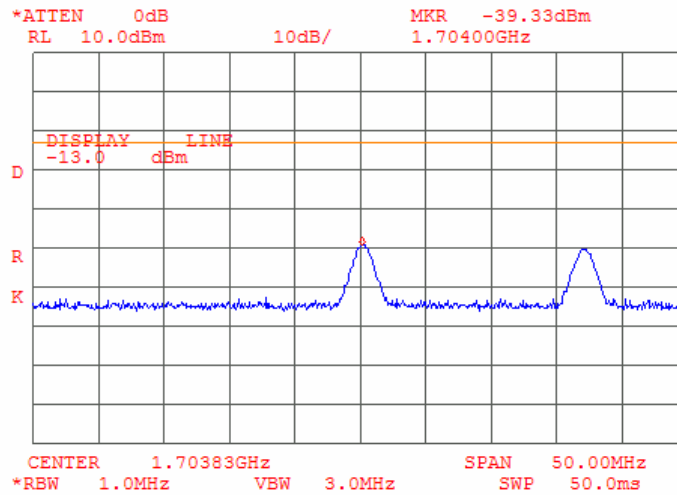

Plot 7.4.7 Conducted spurious emission measurements at 2.6 GHz at port 1

OPERATIONAL MODE: iDEN downlink transmit
INPUT PORT: DUP
COMPOSITE INPUT POWER: 12.5 dBm

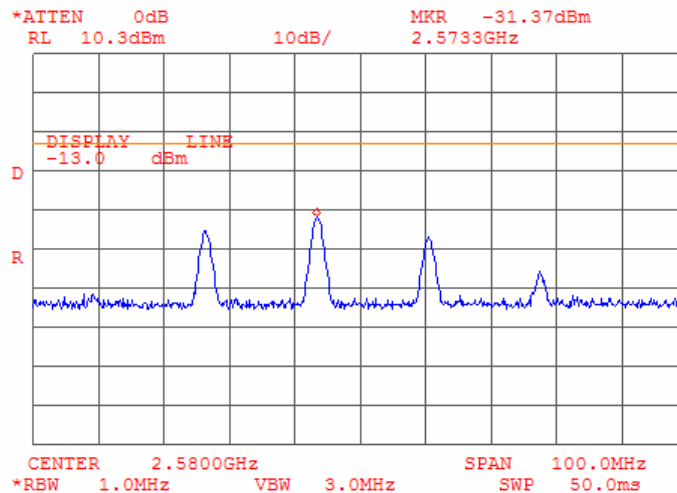



Plot 7.4.8 Conducted spurious emissions measurements from 9.0 to 150.0 kHz at port 1

OPERATIONAL MODE: SMR downlink transmit
INPUT PORT: DUP
COMPOSITE INPUT POWER: 12.5 dBm

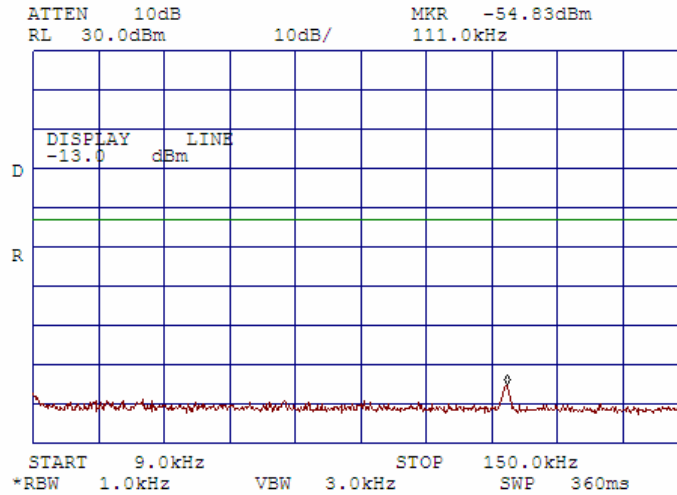

Plot 7.4.9 Conducted spurious emissions measurements from 0.15 to 30.0 MHz at port 1

OPERATIONAL MODE: SMR downlink transmit
INPUT PORT: DUP
COMPOSITE INPUT POWER: 12.5 dBm

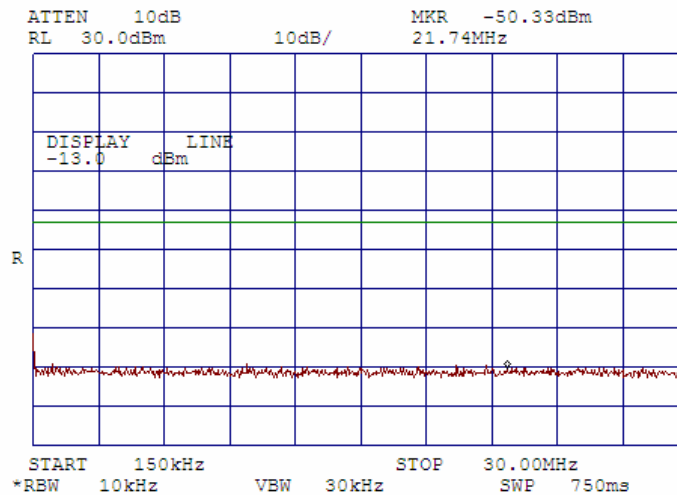



Plot 7.4.10 Conducted spurious emissions measurements from 30.0 to 928 MHz at port 1

OPERATIONAL MODE: SMR downlink transmit
INPUT PORT: DUP
COMPOSITE INPUT POWER: 12.5 dBm

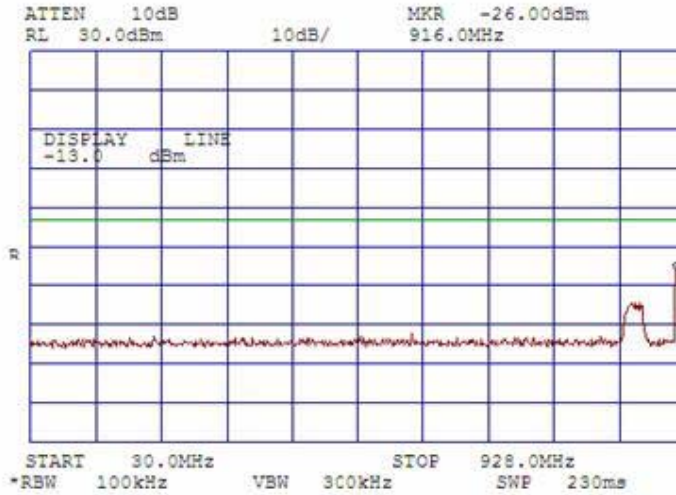

Plot 7.4.11 Conducted spurious emissions measurements from 928 to 942 MHz at port 1

OPERATIONAL MODE: SMR downlink transmit
INPUT PORT: DUP
COMPOSITE INPUT POWER: 12.5 dBm

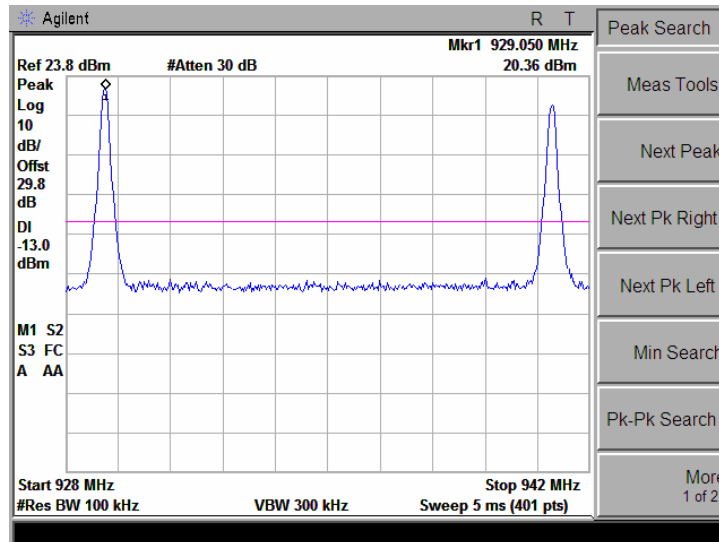



Plot 7.4.12 Conducted spurious emissions measurements from 942 MHz to 1000 MHz at port 1

OPERATIONAL MODE: SMR downlink transmit
INPUT PORT: DUP
COMPOSITE INPUT POWER: 12.5 dBm

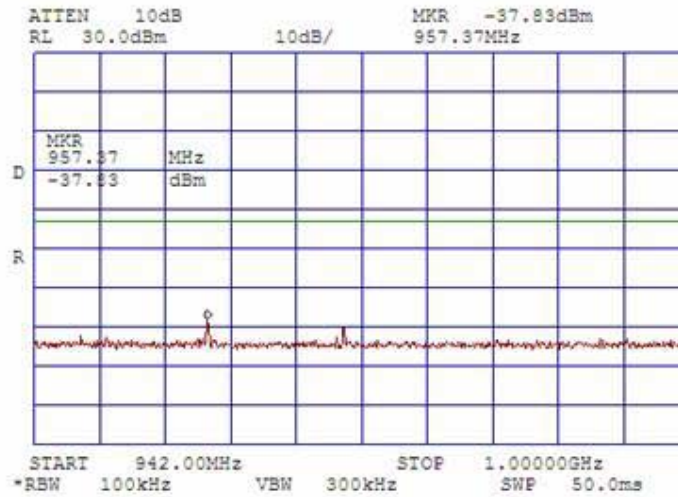



Plot 7.4.13 Conducted spurious emissions measurement from 1 GHz to 2 GHz at port 1

OPERATIONAL MODE: SMR downlink transmit
INPUT PORT: DUP
COMPOSITE INPUT POWER: 12.5 dBm

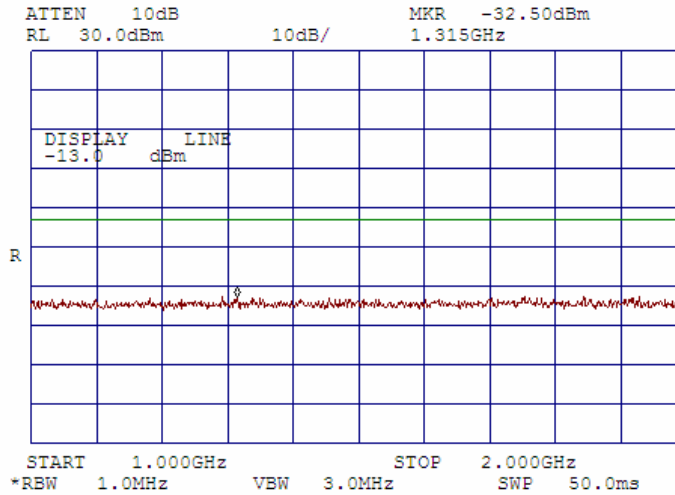

Plot 7.4.14 Conducted spurious emissions measurement from 2 GHz to 10 GHz at port 1

OPERATIONAL MODE: SMR downlink transmit
INPUT PORT: DUP
COMPOSITE INPUT POWER: 12.5 dBm

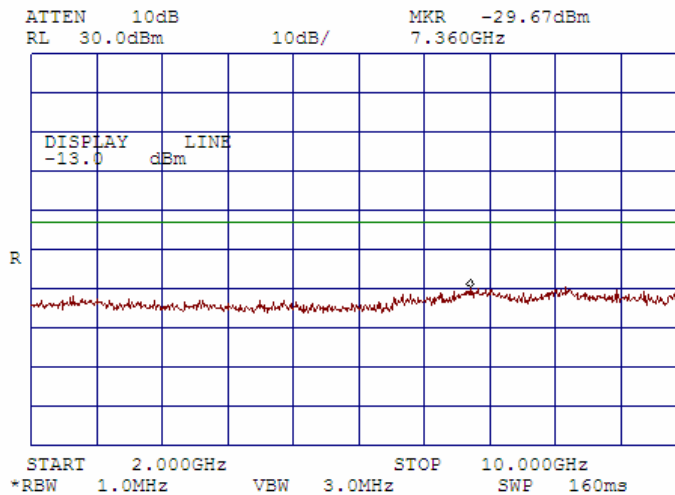



7.5 Radiated spurious emission measurements according to part 90 §§90.210(g), 90.210(j)

7.5.1 General

This test was performed to measure radiated spurious emissions from the EUT. Specification test limits are given in Table 7.5.1.

Table 7.5.1 Radiated spurious emission test limits

Frequency, MHz	Attenuation below carrier, dBc	ERP of spurious, dBm	Equivalent field strength limit @ 3m, dB(μV/m)***
0.009 – 10 th harmonic*	43+10logP**	-13	84.4
0.009 – 10th harmonic*	50+10logP**	-20	77.4

* - Excluding the in band emission within ± 250 % of the authorized bandwidth from the carrier

** - P is transmitter output power in Watts

*** - Equivalent field strength limit was calculated from maximum allowed ERP of spurious as follows:
 $E = \sqrt{(30 \times P \times 1.64) / r}$, where P is ERP in Watts, 1.64 is numeric gain of ideal dipole and r is antenna to EUT distance in meters

7.5.2 Test procedure for spurious emission field strength measurements in 9 kHz to 30 MHz band

7.5.2.1 The EUT was set up as shown in Figure 7.5.1, energized and the performance check was conducted.

7.5.2.2 The specified frequency range was investigated with antenna connected to spectrum analyzer. To find maximum radiation the turntable was rotated 360° and the measuring antenna was rotated around its vertical axis.

7.5.2.3 The worst test results (the lowest margins) were shown in the associated plots.

7.5.3 Test procedure for spurious emission field strength measurements above 30 MHz

7.5.3.1 The EUT was set up as shown in Figure 7.5.2, energized and the performance check was conducted.

7.5.3.2 The specified frequency range was investigated with antenna connected to spectrum analyzer. To find maximum radiation the turntable was rotated 360° and the measuring antenna height was swept from 1 to 4 m in both, vertical and horizontal, polarizations.

7.5.3.3 The worst test results (the lowest margins) were shown in the associated plots.

Reference numbers of test equipment used

HL 0446	HL 0521	HL 0589	HL 0593	HL 0594	HL 0604	HL 1004	HL 1424
HL 1942	HL 1947	HL 1984	HL 2009	HL 2259	HL 2399	HL 2432	HL 2499

Full description is given in Appendix A.



Figure 7.5.1 Setup for spurious emission field strength measurements in 9 kHz to 30 MHz band

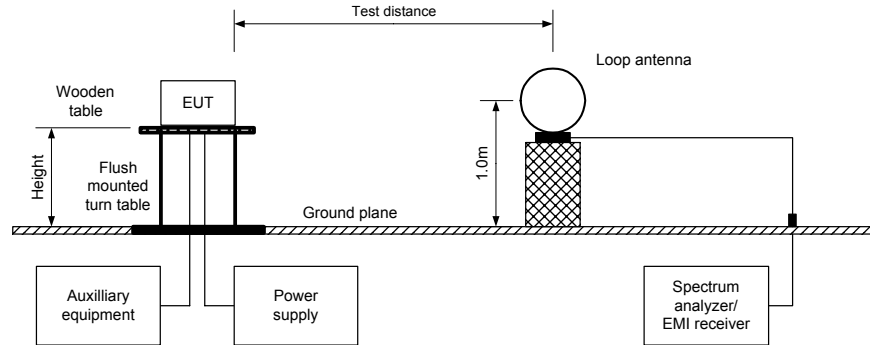
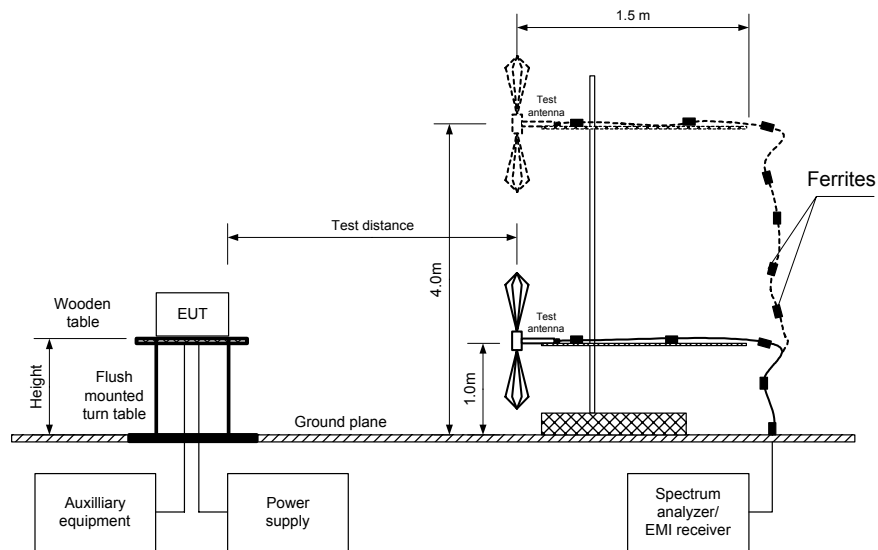

Figure 7.5.2 Setup for spurious emission field strength measurements above 30 MHz





Plot 7.5.1 Radiated emission measurements in 9 - 150 kHz range in downlink mode

TEST SITE:	Semi anechoic chamber
SMR downlink channels:	929.0125 MHz-modulated 929.0375 MHz-CW 940.9875 MHz-modulated
ANTENNA POLARIZATION:	Vertical
TEST DISTANCE:	3 m

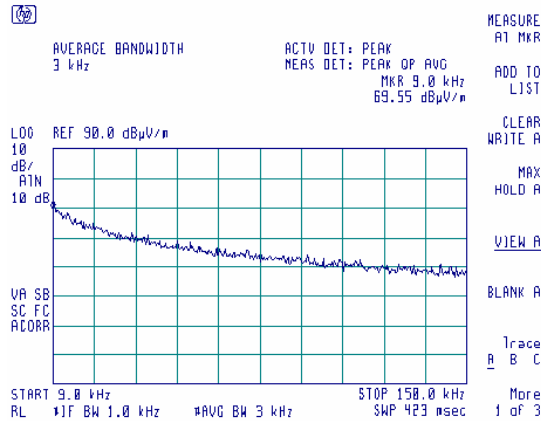

Plot 7.5.2 Radiated emission measurements in 0.15 - 30 MHz range in downlink mode

TEST SITE:	Semi anechoic chamber
SMR downlink channels:	929.0125 MHz-modulated 929.0375 MHz-CW 940.9875 MHz-modulated
ANTENNA POLARIZATION:	Vertical
TEST DISTANCE:	3 m

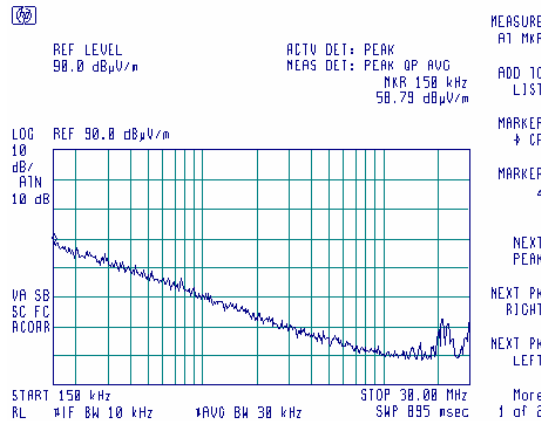



Plot 7.5.3 Radiated emission measurements in 30 - 1000 MHz range in downlink mode

TEST SITE:	Semi anechoic chamber
SMR downlink channels:	929.0125 MHz-modulated 929.0375 MHz-CW 940.9875 MHz-modulated
ANTENNA POLARIZATION:	Vertical and Horizontal
TEST DISTANCE:	3 m

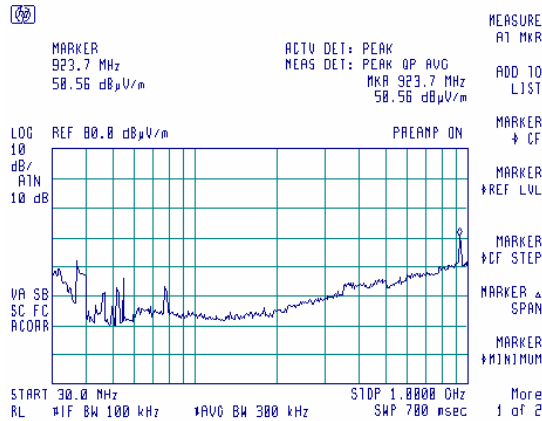

Plot 7.5.4 Radiated emission measurements in 1000 – 6500 MHz range in downlink mode

TEST SITE:	Semi anechoic chamber
SMR downlink channels:	929.0125 MHz-modulated 929.0375 MHz-CW 940.9875 MHz-modulated
ANTENNA POLARIZATION:	Vertical and Horizontal
TEST DISTANCE:	3 m

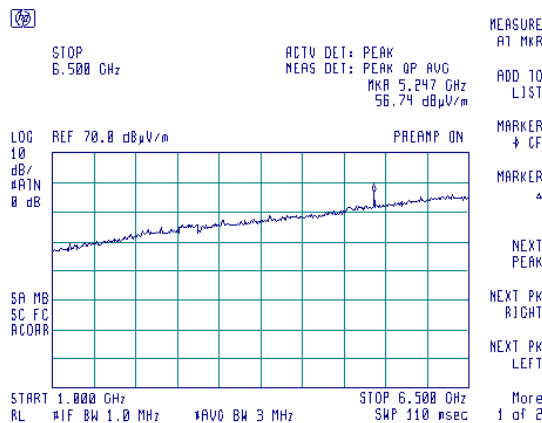



Plot 7.5.5 Radiated emission measurements in 5000 – 8000 MHz range in downlink mode

TEST SITE:	OATS
SMR downlink channels:	929.0125 MHz-modulated 929.0375 MHz-CW 940.9875 MHz-modulated
ANTENNA POLARIZATION:	Vertical and Horizontal
TEST DISTANCE:	3 m

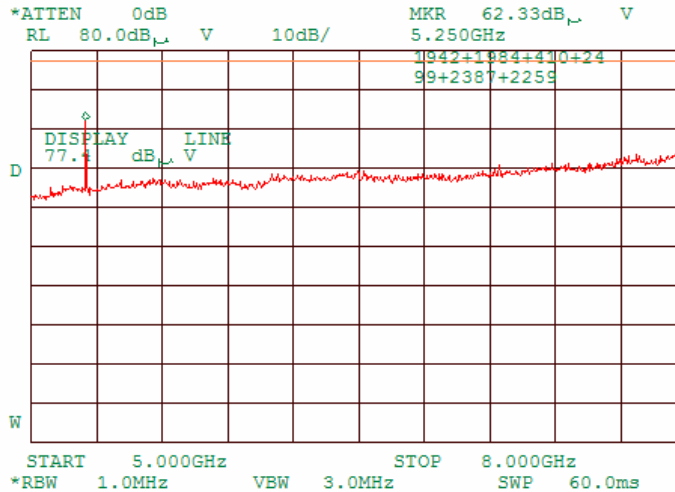

Refer to section 8.1, Table 8.1.2

Plot 7.5.6 Radiated emission measurements in 8000 – 12000 MHz range in downlink mode

TEST SITE:	OATS
SMR downlink channels:	929.0125 MHz-modulated 929.0375 MHz-CW 940.9875 MHz-modulated
ANTENNA POLARIZATION:	Vertical and Horizontal
TEST DISTANCE:	3 m

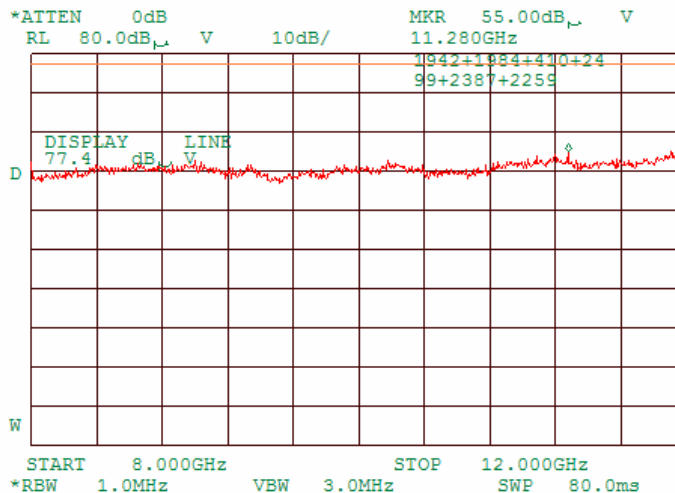



Plot 7.5.7 Radiated emission measurements in 9 - 150 kHz range in downlink mode

TEST SITE:	Semi anechoic chamber
iDEN downlink channels:	851.0125 MHz-modulated 851.0375 MHz-CW 868.9875 MHz-modulated
ANTENNA POLARIZATION:	Vertical and Horizontal
TEST DISTANCE:	3 m

14:19:10 APR 04, 2005

ACTV DET: PEAK
 MEAS DET: PEAK OP AVG
 MKR 10.0 kHz
 51.15 dBμV/m

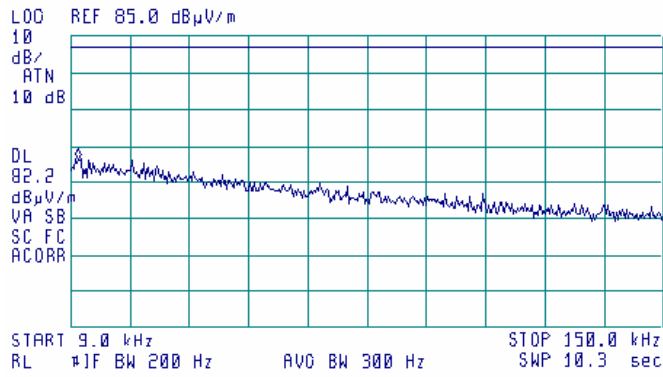

Plot 7.5.8 Radiated emission measurements in 150 kHz – 30 MHz range in downlink mode

TEST SITE:	Semi anechoic chamber
iDEN downlink channels:	851.0125 MHz-modulated 851.0375 MHz-CW 868.9875 MHz-modulated
ANTENNA POLARIZATION:	Vertical and Horizontal
TEST DISTANCE:	3 m

14:15:22 APR 04, 2005

ACTV DET: PEAK
 MEAS DET: PEAK OP AVG
 MKR 160 kHz
 54.41 dBμV/m

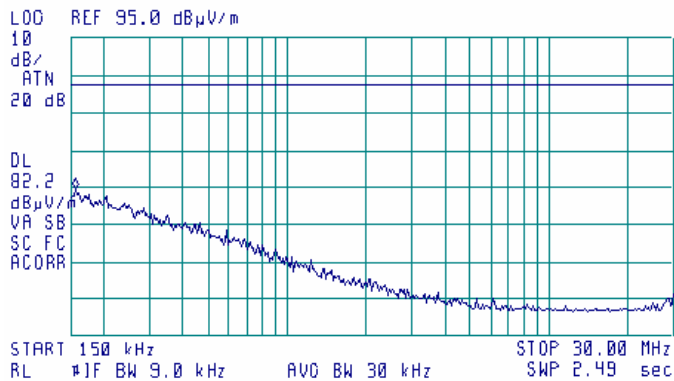



Plot 7.5.9 Radiated emission measurements in 30 - 850 MHz range in downlink mode

TEST SITE:	Semi anechoic chamber
iDEN downlink channels:	851.0125 MHz-modulated 851.0375 MHz-CW 868.9875 MHz-modulated
ANTENNA POLARIZATION:	Vertical and Horizontal
TEST DISTANCE:	3 m

12:49:45 APR 04, 2005

ACTV DET: PEAK
 MEAS DET: PEAK QP AVG
 MKR 421.0 MHz
 44.53 dB μ V/m

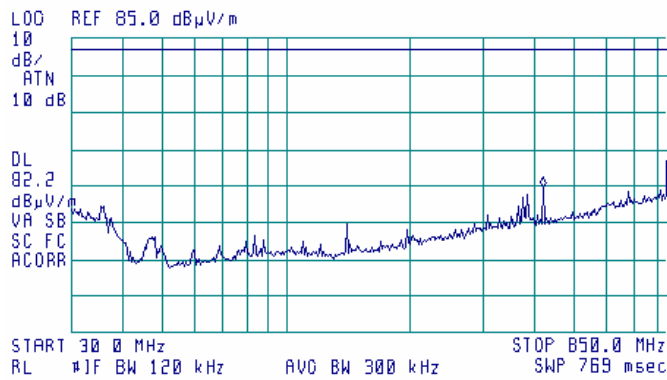

Plot 7.5.10 Radiated emission measurements in 850 MHz – 850.9875 MHz range in downlink mode

TEST SITE:	Semi anechoic chamber
iDEN downlink channels:	851.0125 MHz-modulated 851.0375 MHz-CW 868.9875 MHz-modulated
ANTENNA POLARIZATION:	Vertical and Horizontal
TEST DISTANCE:	3 m

13:31:42 APR 04, 2005

ACTV DET: PEAK
 MEAS DET: PEAK QP AVG
 MKR 850.9875 MHz
 34.15 dB μ V/m

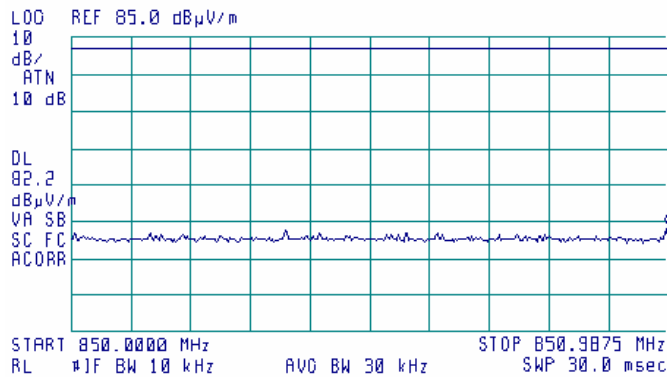



Plot 7.5.11 Radiated emission measurements in 869.0125 - 870 MHz range in downlink mode

TEST SITE:	Semi anechoic chamber
iDEN downlink channels:	851.0125 MHz-modulated 851.0375 MHz-CW 868.9875 MHz-modulated
ANTENNA POLARIZATION:	Vertical and Horizontal
TEST DISTANCE:	3 m

13:38:24 APR 04, 2005

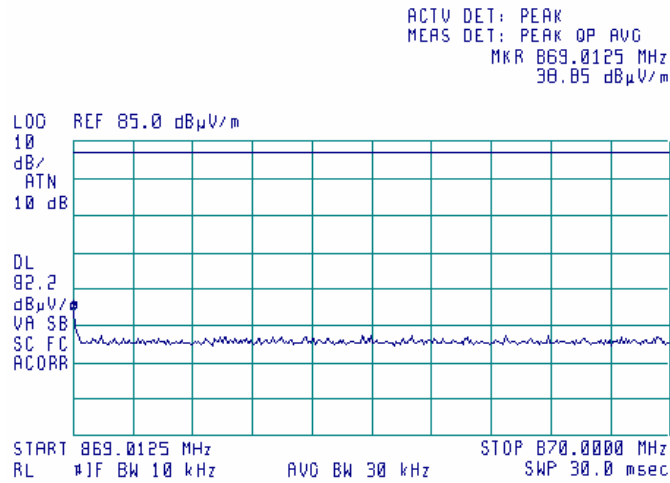

Plot 7.5.12 Radiated emission measurements in 870 MHz – 1000 MHz range in downlink mode

TEST SITE:	Semi anechoic chamber
iDEN downlink channels:	851.0125 MHz-modulated 851.0375 MHz-CW 868.9875 MHz-modulated
ANTENNA POLARIZATION:	Vertical and Horizontal
TEST DISTANCE:	3 m

13:11:44 APR 04, 2005

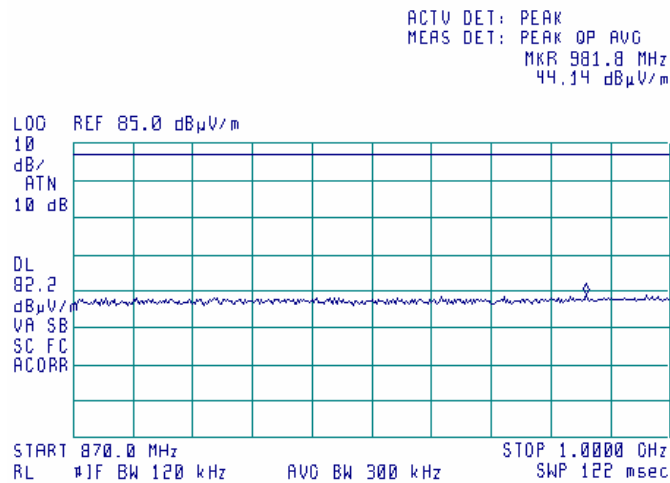



Plot 7.5.13 Radiated emission measurements in 1 GHz – 6.5 GHz range in downlink mode

TEST SITE: Semi anechoic chamber
iDEN downlink channels: 851.0125 MHz-modulated
851.0375 MHz-CW
868.9875 MHz-modulated
ANTENNA POLARIZATION: Vertical and Horizontal
TEST DISTANCE: 3 m

14:54:25 APR 04, 2005

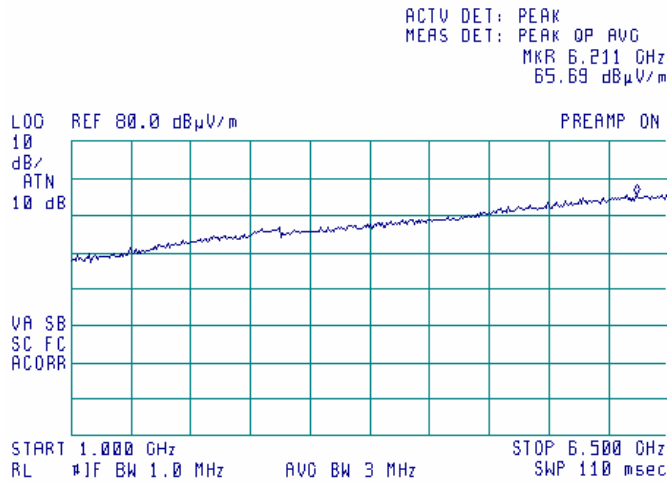

Plot 7.5.14 Radiated emission measurements in 6.5 GHz – 9 GHz range in downlink mode

TEST SITE: Semi anechoic chamber
iDEN downlink channels: 851.0125 MHz-modulated
851.0375 MHz-CW
868.9875 MHz-modulated
ANTENNA POLARIZATION: Vertical and Horizontal
TEST DISTANCE: 3 m

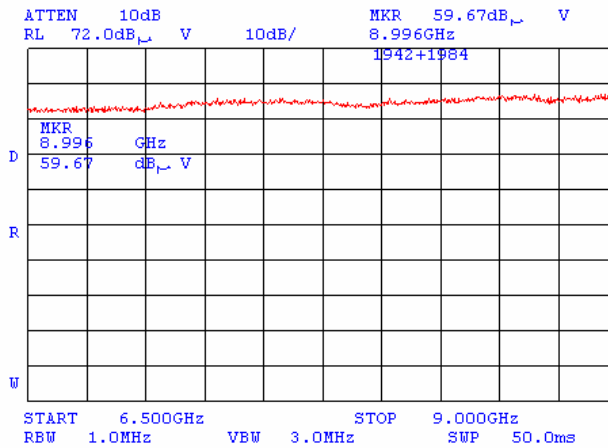



8 Emissions tests according to 47CFR part 15 subpart B requirements

8.1 Radiated emission measurements

8.1.1 General

This test was performed to measure radiated emissions from the EUT enclosure. Specification test limits are given in Table 8.1.1.

Table 8.1.1 Radiated emission test limits

Frequency, MHz	Class B limit, dB(μ V/m)		Class A limit, dB(μ V/m)	
	10 m distance	3 m distance	10 m distance	3 m distance
30 - 88	29.5*	40.0	39.0	49.5*
88 - 216	33.0*	43.5	43.5	54.0*
216 - 960	35.5*	46.0	46.4	56.9*
Above 960	43.5*	54.0	49.5	60.0*

* The limit for test distance other than specified was calculated using the inverse linear distance extrapolation factor as follows: $Lim_{S_2} = Lim_{S_1} + 20 \log(S_1/S_2)$, where S_1 and S_2 – standard defined and test distance respectively in meters.

8.1.2 Test procedure for measurements in semi-anechoic chamber

8.1.2.1 The EUT was set up as shown in Figure 8.1.1, energized and the performance check was conducted.

8.1.2.2 The specified frequency range was investigated with biconilog antenna connected to EMI receiver. To find maximum radiation the turntable was rotated 360° , the measuring antenna height was changed from 1 to 4 m, its polarization was switched from vertical to horizontal and the EUT cables position was varied.

8.1.2.3 The worst test results (the lowest margins) were recorded in Table 8.1.2 and shown in the associated plots.

8.1.3 Test procedure for measurements at OATS

8.1.3.1 The EUT was set up as shown in Figure 8.1.2, energized and the performance check was conducted.

8.1.3.2 The measurements were performed at the open area test site at 3 m test distance. The EUT wires and cables were arranged to produce maximum emission. To find maximum radiation the turntable was rotated 360° , the measuring antenna height was changed from 1 to 4 m and its polarization was changed from vertical to horizontal.

8.1.3.3 The worst test results (the lowest margins) were recorded in Table 8.1.2 and shown in the associated plots.



Figure 8.1.1 Setup for radiated emission measurements in anechoic chamber, table-top equipment

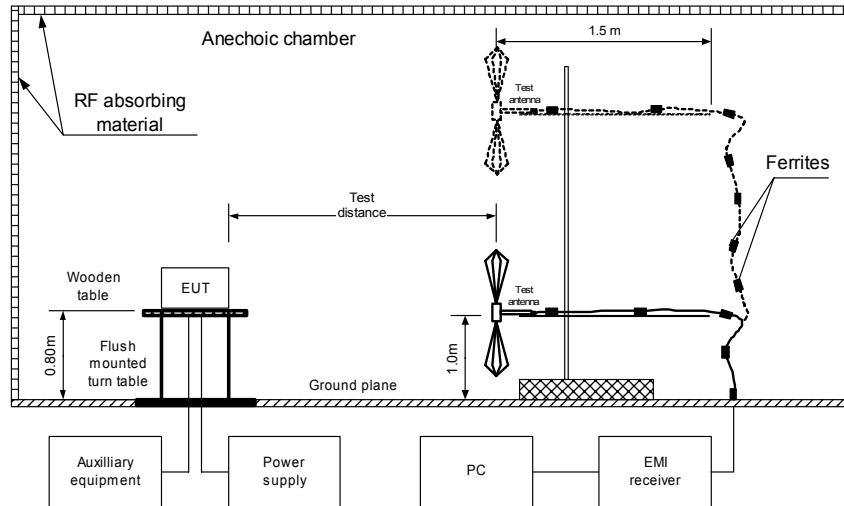

Figure 8.1.2 Setup for radiated emission measurements at OATS, table-top equipment

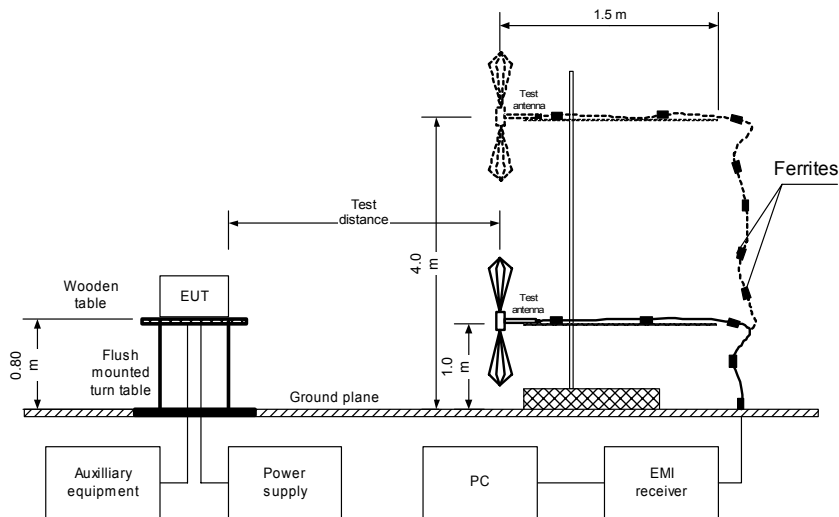



Table 8.1.2 Radiated emission test results, SMR uplink mode

EUT SET UP: TABLE-TOP
LIMIT: Class B
EUT OPERATING MODE: Receive
TEST SITE: SEMI ANECHOIC CHAMBER
TEST DISTANCE: 3 m
DETECTORS USED: PEAK / QUASI-PEAK
FREQUENCY RANGE: 30 MHz – 1000 MHz
RESOLUTION BANDWIDTH: 120 kHz

Frequency, MHz	Peak emission, dB(μ V/m)	Quasi-peak			Antenna polarization	Antenna height, m	Turn-table position**, degrees	Verdict
		Measured emission, dB(μ V/m)	Limit, dB(μ V/m)	Margin, dB*				
31.439767	40.36	32.26	40.00	-7.74	V	1.0	180	Pass
38.075633	37.76	35.45	40.00	-4.55	V	1.0	123	
41.707877	40.13	27.02	40.00	-12.98	V	1.1	169	
49.421945	39.76	26.80	40.00	-13.20	V	1.0	176	
62.235193	27.27	14.43	40.00	-25.57	V	1.0	39	
948.45736	36.30	33.40	46.00	-12.60	H	1.4	19	

TEST SITE: OATS
TEST DISTANCE: 3 m
LIMIT: Class A
DETECTORS USED: PEAK / AVERAGE
FREQUENCY RANGE: 1000 MHz – 12000 MHz
RESOLUTION BANDWIDTH: 1000 kHz

Frequency, MHz	Peak emission, dB(μ V/m)	Average			Antenna polarization	Antenna height, m	Turn-table position**, degrees	Verdict
		Measured emission, dB(μ V/m)	Limit, dB(μ V/m)	Margin, dB*				
5245.625	59.50	57.00	60	-3.00	V	1.3	278	Pass
5258.608	55.00	53.67	60	-6.33	H	1.0	140	

*- Margin = Measured emission - specification limit.

**- EUT front panel refer to 0 degrees position of turntable.

Reference numbers of test equipment used

HL 0410	HL 0521	HL 0589	HL 0593	HL 0594	HL 0604	HL 1004	HL 1424
HL 1942	HL 1947	HL 1984	HL 2009	HL 2259	HL 2399	HL 2432	HL 2499

Full description is given in Appendix A.



Plot 8.1.1 Radiated emission measurements in 30- 1000 MHz range, vertical antenna polarization, SMR uplink mode

TEST SITE: Semi anechoic chamber
LIMIT: Class B
TEST DISTANCE: 3 m
EUT OPERATING MODE: Receive

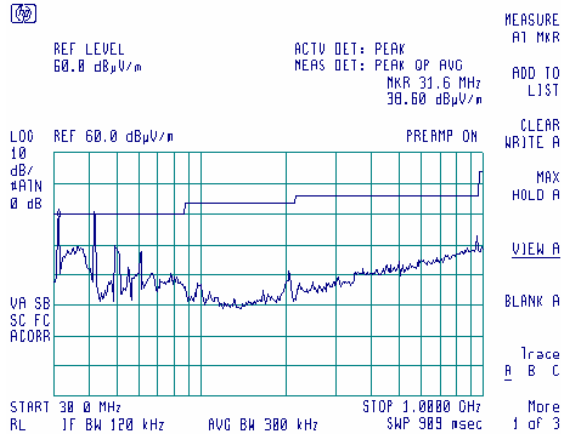

Plot 8.1.2 Radiated emission measurements in 30- 1000 MHz range, horizontal antenna polarization, SMR uplink mode

TEST SITE: Semi anechoic chamber
LIMIT: Class B
TEST DISTANCE: 3 m
EUT OPERATING MODE: Receive

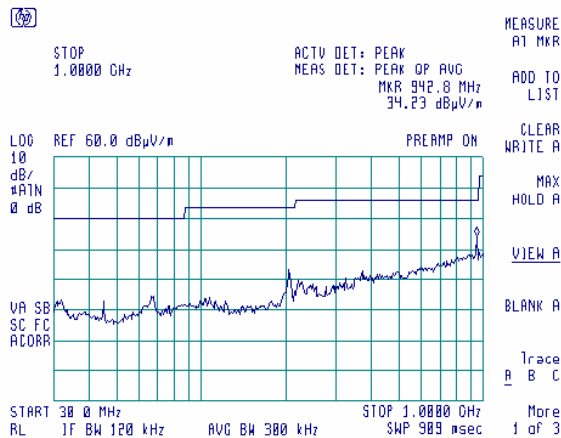



Plot 8.1.3 Radiated emission measurements in 1000- 6500 MHz range, vertical antenna polarization, SMR uplink mode

TEST SITE: Semi anechoic chamber
LIMIT: Class B
TEST DISTANCE: 3 m
EUT OPERATING MODE: Receive

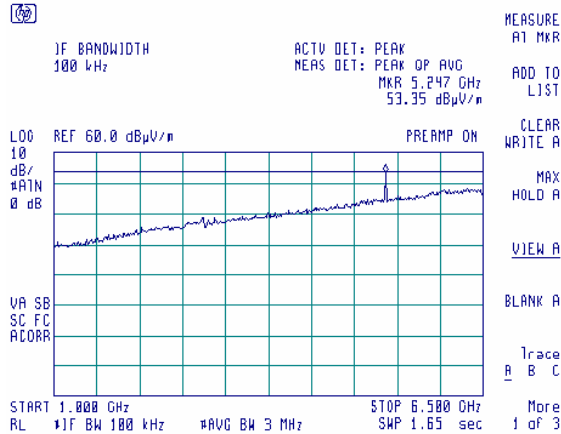

Plot 8.1.4 Radiated emission measurements in 1000- 6500 MHz range, horizontal antenna polarization, SMR uplink mode

TEST SITE: Semi anechoic chamber
LIMIT: Class B
TEST DISTANCE: 3 m
EUT OPERATING MODE: Receive

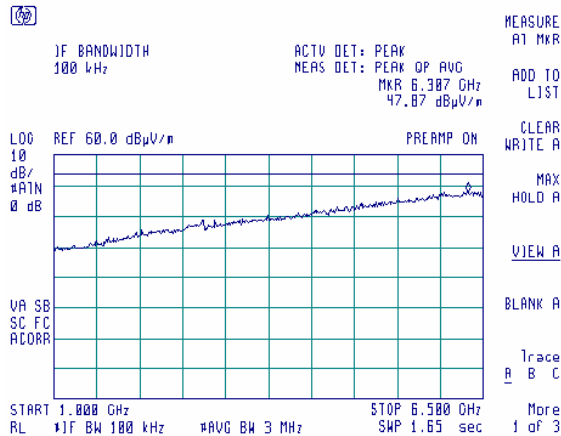



Plot 8.1.5 Radiated emission measurements in 6500- 8000 MHz range, vertical antenna polarization, SMR uplink mode

TEST SITE: OATS
LIMIT: Class B
TEST DISTANCE: 3 m
EUT OPERATING MODE: Receive

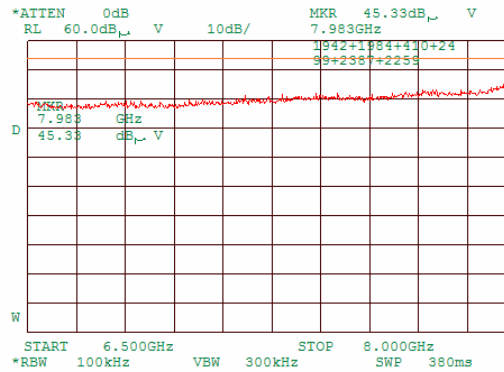

Plot 8.1.6 Radiated emission measurements in 6500- 8000 MHz range, horizontal antenna polarization, SMR uplink mode

TEST SITE: OATS
LIMIT: Class B
TEST DISTANCE: 3 m
EUT OPERATING MODE: Receive

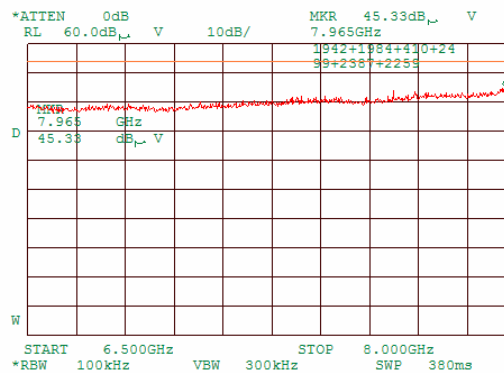



Plot 8.1.7 Radiated emission measurements in 8000- 12000 MHz range, vertical antenna polarization, SMR uplink mode

TEST SITE: OATS
LIMIT: Class B
TEST DISTANCE: 3 m
EUT OPERATING MODE: Receive

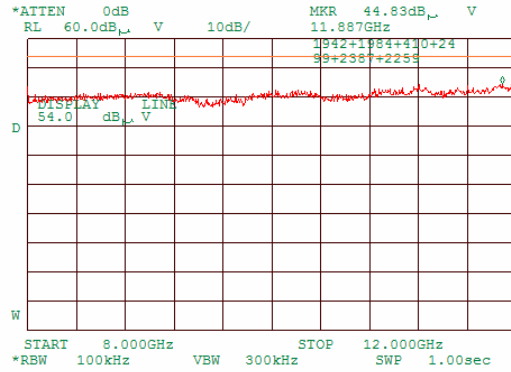

Plot 8.1.8 Radiated emission measurements in 8000- 12000 MHz range, horizontal antenna polarization, SMR uplink mode

TEST SITE: OATS
LIMIT: Class B
TEST DISTANCE: 3 m
EUT OPERATING MODE: Receive

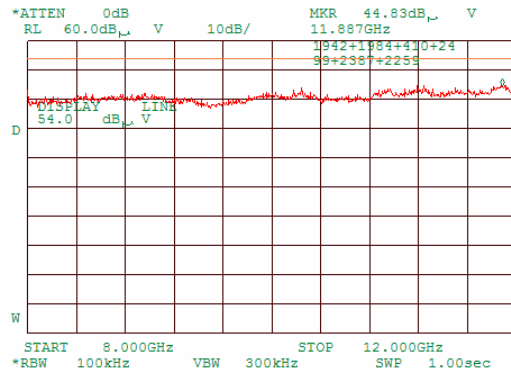



Plot 8.1.9 Radiated emission measurements, SMR uplink mode

TEST SITE:	Semi anechoic chamber
ANTENNA POLARIZATION:	Vertical
LIMIT:	Class A
TEST DISTANCE:	3 m
DETECTOR:	Peak

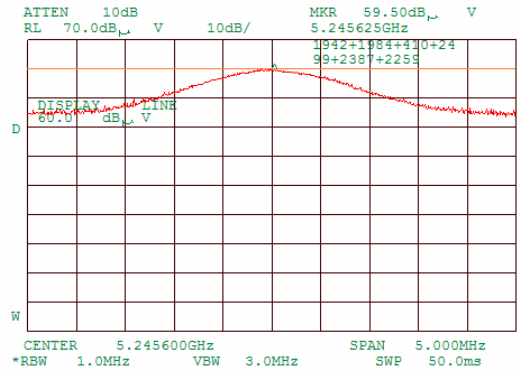

Plot 8.1.10 Radiated emission measurements, SMR uplink mode

TEST SITE:	Semi anechoic chamber
ANTENNA POLARIZATION:	Vertical
LIMIT:	Class A
TEST DISTANCE:	3 m
DETECTOR:	Average

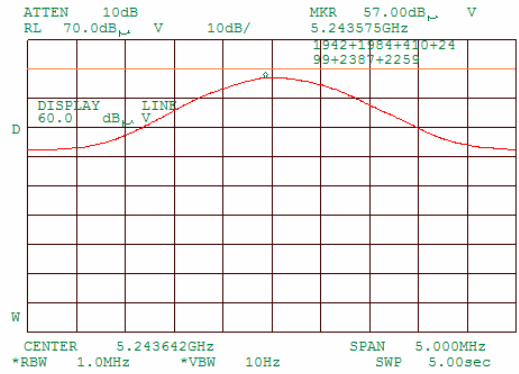



Plot 8.1.11 Radiated emission measurements, SMR uplink mode

TEST SITE:	Semi anechoic chamber
ANTENNA POLARIZATION:	Horizontal
LIMIT:	Class A
TEST DISTANCE:	3 m
DETECTOR:	Peak

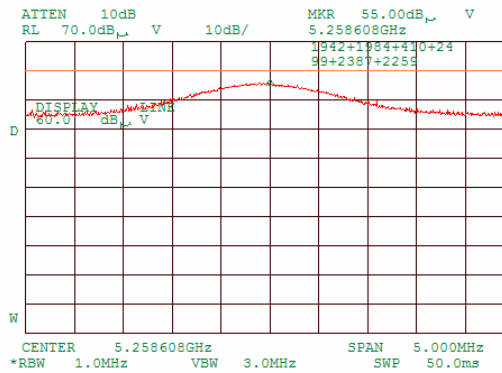

Plot 8.1.12 Radiated emission measurements, SMR uplink mode

TEST SITE:	Semi anechoic chamber
ANTENNA POLARIZATION:	Horizontal
LIMIT:	Class A
TEST DISTANCE:	3 m
DETECTOR:	Average

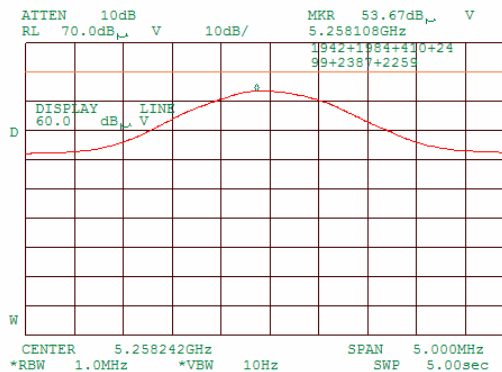



Table 8.1.3 Radiated emission test results, iDEN uplink mode

EUT SET UP:	TABLE-TOP
LIMIT:	Class B
EUT OPERATING MODE:	Receive
TEST SITE:	SEMI ANECHOIC CHAMBER
TEST DISTANCE:	3 m
DETECTORS USED:	PEAK / QUASI-PEAK
FREQUENCY RANGE:	30 MHz – 1000 MHz
RESOLUTION BANDWIDTH:	120 kHz

Frequency, MHz	Peak emission, dB(µV/m)	Quasi-peak			Antenna polarization	Antenna height, m	Turn-table position**, degrees	Verdict
		Measured emission, dB(µV/m)	Limit, dB(µV/m)	Margin, dB*				
33.894844	43.91	33.82	40.00	-6.18	V	1.0	165	Pass
34.899578	30.77	30.76	40.00	-9.24	V	1.0	128	
948.41971	34.70	33.60	46.00	-12.40	H	1.6	44	

TEST SITE:	OATS
TEST DISTANCE:	3 m
LIMIT:	Class A
DETECTORS USED:	PEAK / AVERAGE
FREQUENCY RANGE:	1000 MHz – 12000 MHz
RESOLUTION BANDWIDTH:	1000 kHz

Frequency, MHz	Peak emission, dB(µV/m)	Average			Antenna polarization	Antenna height, m	Turn-table position**, degrees	Verdict
		Measured emission, dB(µV/m)	Limit, dB(µV/m)	Margin, dB*				
5245.625	59.50	57.00	60	-3.00	V	1.3	278	Pass
5258.608	55.00	53.67	60	-6.33	H	1.0	140	

*- Margin = Measured emission – specification limit.
**- EUT front panel refer to 0 degrees position of turntable.

Reference numbers of test equipment used

HL 0410	HL 0521	HL 0589	HL 0593	HL 0594	HL 0604	HL 1004	HL 1424
HL 1942	HL 1947	HL 1984	HL 2009	HL 2259	HL 2399	HL 2432	HL 2499

Full description is given in Appendix A.



Plot 8.1.13 Radiated emission measurements in 30- 1000 MHz range, vertical antenna polarization, iDEN uplink mode

TEST SITE: Semi anechoic chamber
LIMIT: Class B
TEST DISTANCE: 3 m
EUT OPERATING MODE: Receive

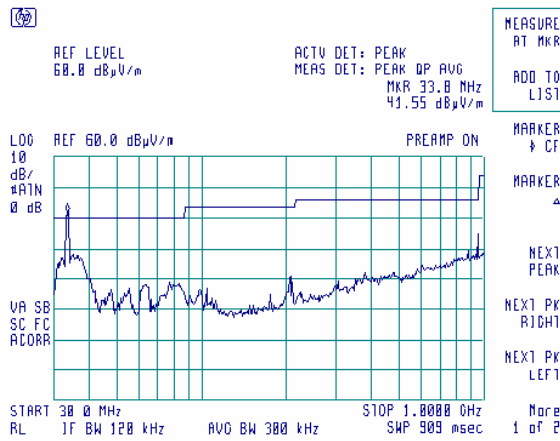

Plot 8.1.14 Radiated emission measurements in 30- 1000 MHz range, horizontal antenna polarization, iDEN uplink mode

TEST SITE: Semi anechoic chamber
LIMIT: Class B
TEST DISTANCE: 3 m
EUT OPERATING MODE: Receive

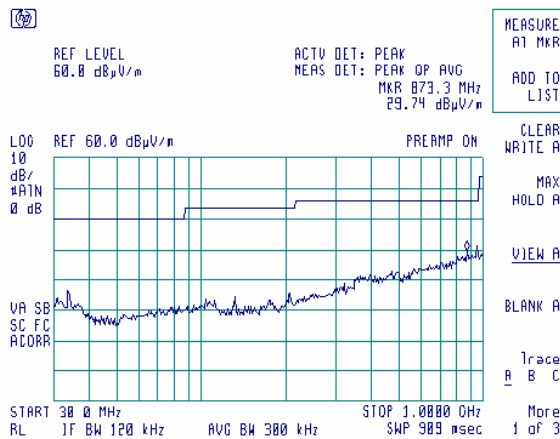



Plot 8.1.15 Radiated emission measurements in 1000- 6500 MHz range, vertical antenna polarization, iDEN uplink mode

TEST SITE: Semi anechoic chamber
LIMIT: Class B
TEST DISTANCE: 3 m
EUT OPERATING MODE: Receive

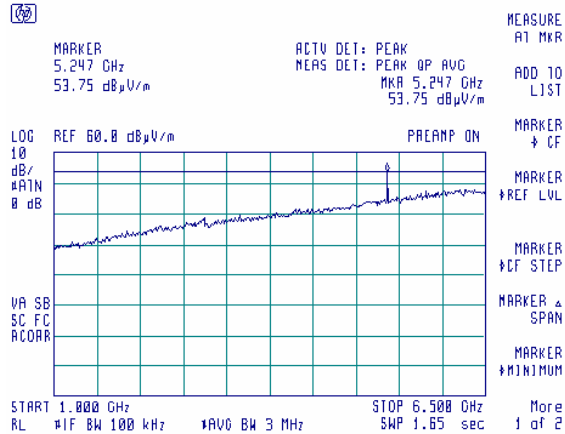

Plot 8.1.16 Radiated emission measurements in 1000- 6500 MHz range, horizontal antenna polarization, iDEN uplink mode

TEST SITE: Semi anechoic chamber
LIMIT: Class B
TEST DISTANCE: 3 m
EUT OPERATING MODE: Receive

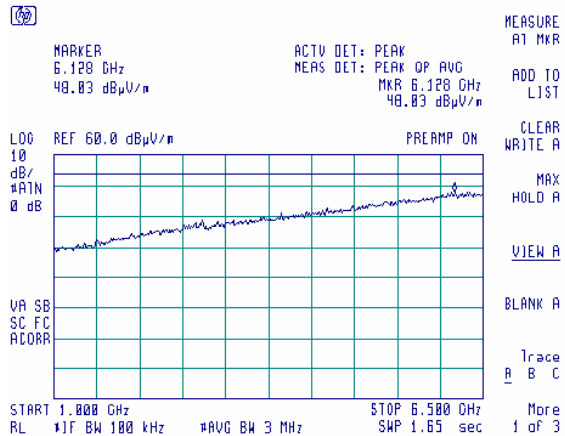



Plot 8.1.17 Radiated emission measurements in 6500- 8000 MHz range, vertical antenna polarization, iDEN uplink mode

TEST SITE: OATS
LIMIT: Class B
TEST DISTANCE: 3 m
EUT OPERATING MODE: Receive

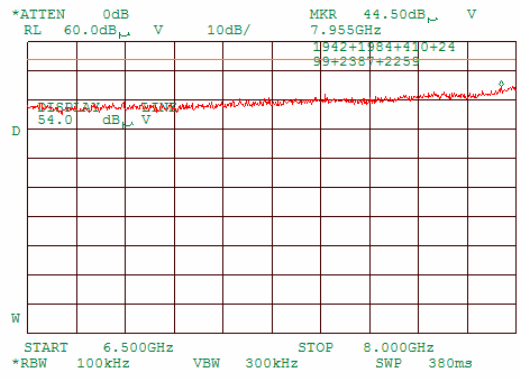

Plot 8.1.18 Radiated emission measurements in 6500- 8000 MHz range, horizontal antenna polarization, iDEN uplink mode

TEST SITE: OATS
LIMIT: Class B
TEST DISTANCE: 3 m
EUT OPERATING MODE: Receive

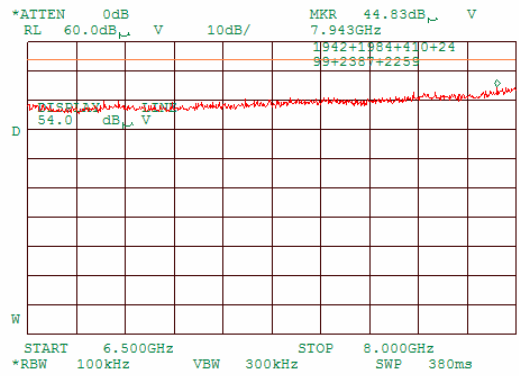



Plot 8.1.19 Radiated emission measurements in 8000- 12000 MHz range, vertical antenna polarization, iDEN uplink mode

TEST SITE: OATS
LIMIT: Class B
TEST DISTANCE: 3 m
EUT OPERATING MODE: Receive

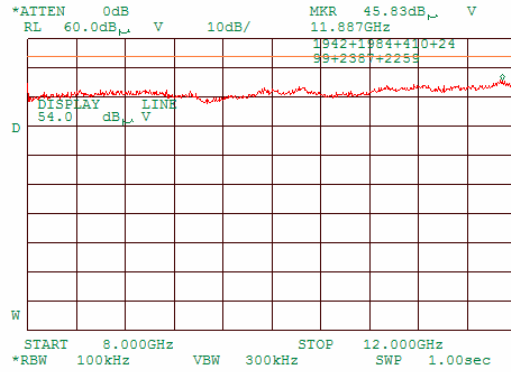

Plot 8.1.20 Radiated emission measurements in 8000- 12000 MHz range, horizontal antenna polarization, iDEN uplink mode

TEST SITE: OATS
LIMIT: Class B
TEST DISTANCE: 3 m
EUT OPERATING MODE: Receive

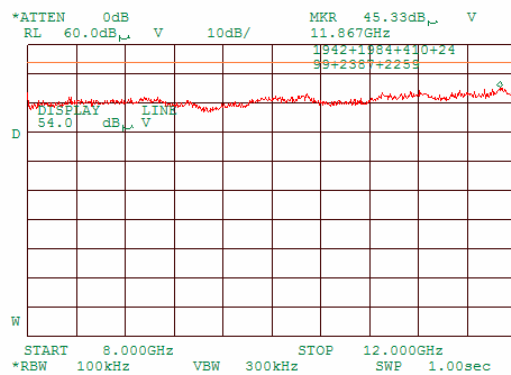



Plot 8.1.21 Radiated emission measurements, iDEN uplink mode

TEST SITE:	Semi anechoic chamber
ANTENNA POLARIZATION:	Vertical
LIMIT:	Class A
TEST DISTANCE:	3 m
DETECTOR:	Peak

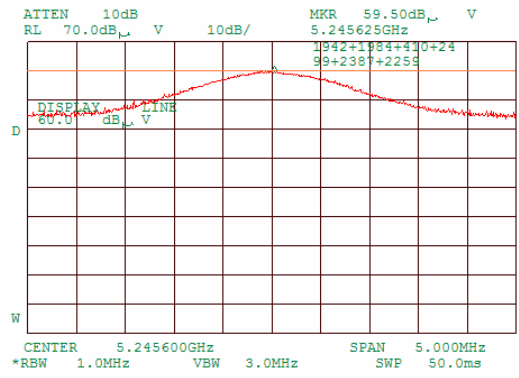

Plot 8.1.22 Radiated emission measurements, iDEN uplink mode

TEST SITE:	Semi anechoic chamber
ANTENNA POLARIZATION:	Vertical
LIMIT:	Class A
TEST DISTANCE:	3 m
DETECTOR:	Average

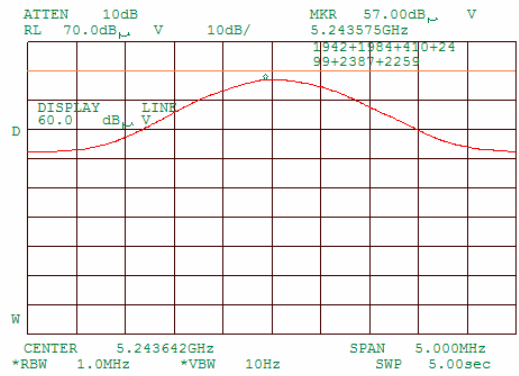



Plot 8.1.23 Radiated emission measurements, iDEN uplink mode

TEST SITE:	Semi anechoic chamber
ANTENNA POLARIZATION:	Horizontal
LIMIT:	Class A
TEST DISTANCE:	3 m
DETECTOR:	Peak

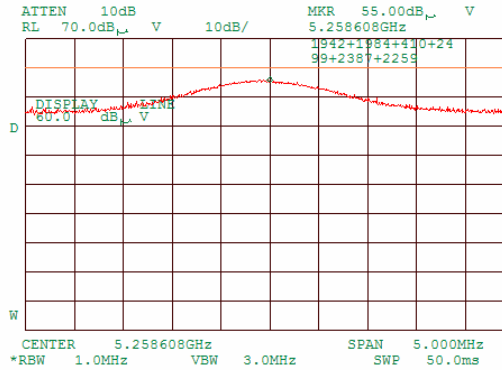

Plot 8.1.24 Radiated emission measurements, iDEN uplink mode

TEST SITE:	Semi anechoic chamber
ANTENNA POLARIZATION:	Horizontal
LIMIT:	Class A
TEST DISTANCE:	3 m
DETECTOR:	Average

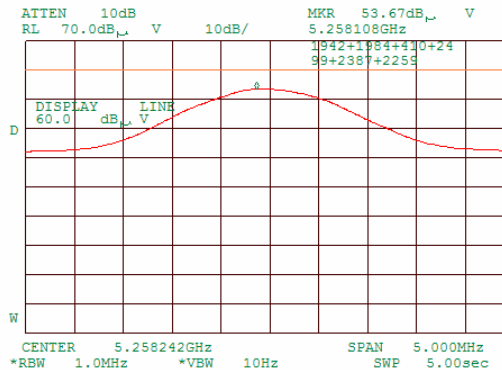



8.2 Spurious emissions at RF antenna connector

8.2.1 General

This test was performed to measure spurious emissions at RF antenna connector of receiver operated within 30 to 960 MHz band or a citizens band (CB) receiver which was tested for compliance with radiated emission limits with the antenna port connected to resistive termination. Specification test limits are given in Table 8.2.1. The test results are provided in Table 8.2.2 and associated plots.

Table 8.2.1 Spurious emission limits

Frequency, MHz	EUT type	Power of spurious	
		nW	dBm
30 MHz – 5 th harmonic*	Other receiver operates within 30 – 960 MHz	2.0	-57.0

* - harmonic of the highest frequency the EUT generates, uses, operates or tunes to.

** - harmonic of the highest local oscillator frequency.

8.2.2 Test procedure

8.2.2.1 The EUT was set up as shown in Figure 8.2.1, energized and its proper operation was checked.

8.2.2.2 The spurious emission was measured with spectrum analyzer as provided in Table 8.2.2 and associated plots.

Figure 8.2.1 Spurious emission test setup

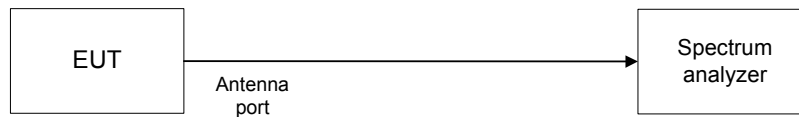



Table 8.2.2 Spurious emission test results

INVESTIGATED FREQUENCY RANGE:	30 – 6000 MHz
RECEIVER TYPE:	Other than CB or superheterodyne
EUT OPERATING MODE:	Receive
DETECTOR USED:	Peak
RESOLUTION BANDWIDTH:	120 kHz and 1000 kHz
VIDEO BANDWIDTH:	300 kHz and 3000 kHz

Frequency, MHz	Detector	Spurious emission, dBm	Limit, dBm	Margin, dB	Verdict
5265.457267	Average	-58.15	-57.0	-1.15	Pass

Reference numbers of test equipment used

HL 0521	HL 2399						
---------	---------	--	--	--	--	--	--

Full description is given in Appendix A.



Plot 8.2.1 Spurious emission test results at antenna port in range 30 – 1000 MHz

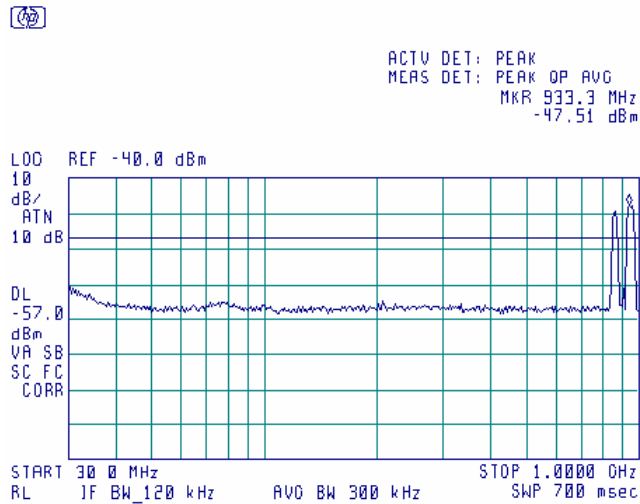

The emission is an amplifier noise floor within the intentional transmission band.

Plot 8.2.2 Spurious emission test results at antenna port in range 1000 – 6000 MHz

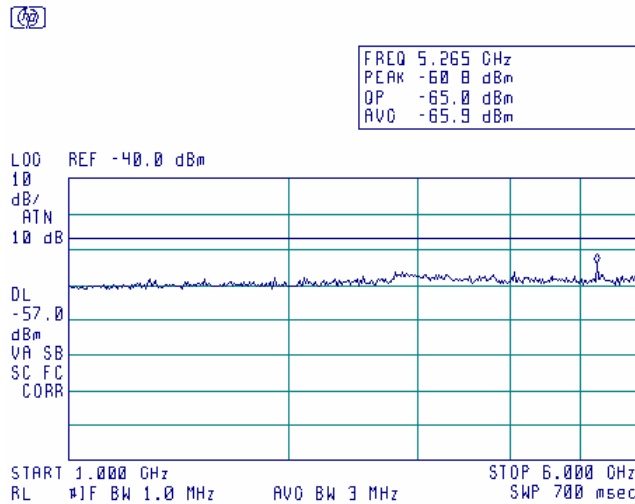



8.3 Conducted emissions

8.3.1 General

This test was performed to measure common mode conducted emissions at the mains power port. Specification test limits are given in Table 8.3.1. The worst test results (the lowest margins) were recorded in Table 8.3.2 and shown in the associated plots.

Table 8.3.1 Limits for conducted emissions

Frequency, MHz	Class B limit, dB(μ V)		Class A limit, dB(μ V)	
	QP	AVRG	QP	AVRG
0.15 - 0.5	66 - 56*	56 - 46*	79	66
0.5 - 5.0	56	46	73	60
5.0 - 30	60	50	73	60

* The limit decreases linearly with the logarithm of frequency.

8.3.2 Test procedure

8.3.2.1 The EUT was set up as shown in Figure 8.3.1 and associated photographs, energized and the performance check was conducted.

8.3.2.2 The measurements were performed at power terminals with the LISN, connected to a spectrum analyzer in the frequency range referred to in Table 8.3.2. Unused coaxial connector of the LISN was terminated with 50 Ohm. Quasi-peak and average detectors were used throughout the testing.

8.3.2.3 The position of the device cables was varied to determine maximum emission level.

Figure 8.3.1 Setup for conducted emission measurements, table-top equipment

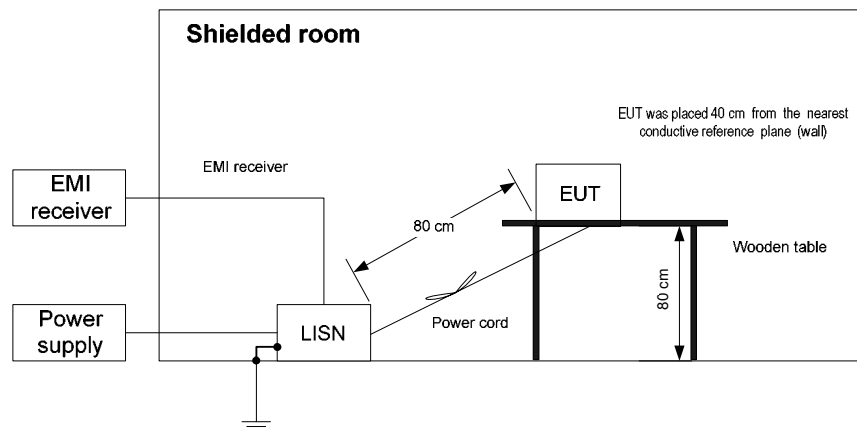

**Table 8.3.2 Conducted emission test results**

LINE: AC mains
LIMIT: Class B
EUT SET UP: TABLE-TOP
TEST SITE: SHIELDED ROOM
DETECTORS USED: PEAK / QUASI-PEAK / AVERAGE
FREQUENCY RANGE: 150 kHz - 30 MHz
RESOLUTION BANDWIDTH: 9 kHz

EUT OPERATING MODE: Transmit (iDEN downlink)

Frequency, MHz	Peak emission, dB(μV)	Quasi-peak			Average			Line ID	Verdict
		Measured emission, dB(μV)	Limit, dB(μV)	Margin, dB*	Measured emission, dB(μV)	Limit, dB(μV)	Margin, dB*		
0.188332	51.01	44.44	64.13	-19.69	11.73	54.13	-42.40	L1	Pass
0.198164	51.84	43.79	63.72	-19.93	11.05	53.72	-42.67		
0.394263	43.20	29.61	57.98	-28.37	0.22	47.98	-47.76		
0.593648	35.13	25.18	56.00	-30.82	-2.59	46.00	-48.59		
11.648673	32.16	28.53	60.00	-31.47	20.61	50.00	-29.39		
28.621320	35.97	32.22	60.00	-27.78	28.43	50.00	-21.57		
0.195183	51.45	43.43	63.84	-20.41	11.34	53.84	-42.50	L2	Pass
0.196802	52.05	43.53	63.78	-20.25	11.10	53.78	-42.68		
0.237451	45.52	37.38	62.21	-24.83	5.19	52.21	-47.02		
0.379156	39.53	30.24	58.33	-28.09	-0.28	48.33	-48.61		
0.649268	36.19	24.90	56.00	-31.10	-3.04	46.00	-49.04		
28.620544	36.53	34.22	60.00	-25.78	29.79	50.00	-20.21		

*- Margin = Measured emission - specification limit.

EUT OPERATING MODE: Receive (iDEN uplink)

Frequency, MHz	Peak emission, dB(μV)	Quasi-peak			Average			Line ID	Verdict
		Measured emission, dB(μV)	Limit, dB(μV)	Margin, dB*	Measured emission, dB(μV)	Limit, dB(μV)	Margin, dB*		
0.173531	51.37	42.52	64.85	-22.33	9.75	54.85	-44.10	L1	Pass
0.191509	50.47	41.24	63.98	-22.74	8.45	53.98	-45.53		
0.316020	37.10	25.14	59.83	-34.69	-3.70	49.83	-53.53		
6.378087	29.09	27.41	60.00	-32.59	21.24	50.00	-28.76		
18.164440	31.15	29.02	60.00	-30.98	27.34	50.00	-22.66		
0.167507	51.44	42.81	65.15	-22.34	9.80	55.15	-45.35		
0.171007	51.98	42.38	64.98	-22.60	9.85	54.98	-45.13	L2	Pass
0.200319	50.05	40.02	63.64	-23.62	7.10	53.64	-46.54		
0.255889	40.99	26.66	61.61	-34.95	5.22	51.61	-46.39		
6.281714	33.38	30.40	60.00	-29.60	23.96	50.00	-26.04		

*- Margin = Measured emission - specification limit.



EUT OPERATING MODE: Transmit (SMR downlink)

Frequency, MHz	Peak emission, dB(μV)	Quasi-peak			Average			Line ID	Verdict
		Measured emission, dB(μV)	Limit, dB(μV)	Margin, dB*	Measured emission, dB(μV)	Limit, dB(μV)	Margin, dB*		
0.15-30		All emissions were found at least 20 dB below specified limit						L1	Pass
0.15-30		All emissions were found at least 20 dB below specified limit						L2	Pass

*- Margin = Measured emission - specification limit.

EUT OPERATING MODE: Transmit (SMR uplink)

Frequency, MHz	Peak emission, dB(μV)	Quasi-peak			Average			Line ID	Verdict
		Measured emission, dB(μV)	Limit, dB(μV)	Margin, dB*	Measured emission, dB(μV)	Limit, dB(μV)	Margin, dB*		
0.15-30		All emissions were found at least 20 dB below specified limit						L1	Pass
0.15-30		All emissions were found at least 20 dB below specified limit						L2	Pass

*- Margin = Measured emission - specification limit.

Reference numbers of test equipment used

HL 0163	HL 0466	HL 0521	HL 0787	HL 1502	HL 1510		
---------	---------	---------	---------	---------	---------	--	--

Full description is given in Appendix A.



Plot 8.3.1 Conducted emission measurements

LINE: L1
LIMIT: Class B
EUT OPERATING MODE: Transmit (iDEN downlink)
LIMIT: QUASI-PEAK, AVERAGE
DETECTOR: PEAK

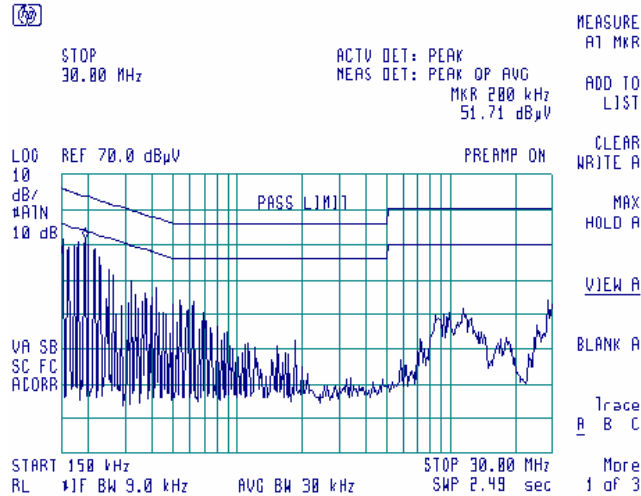

Plot 8.3.2 Conducted emission measurements

LINE: L2
LIMIT: Class B
EUT OPERATING MODE: Transmit (iDEN downlink)
LIMIT: QUASI-PEAK, AVERAGE
DETECTOR: PEAK

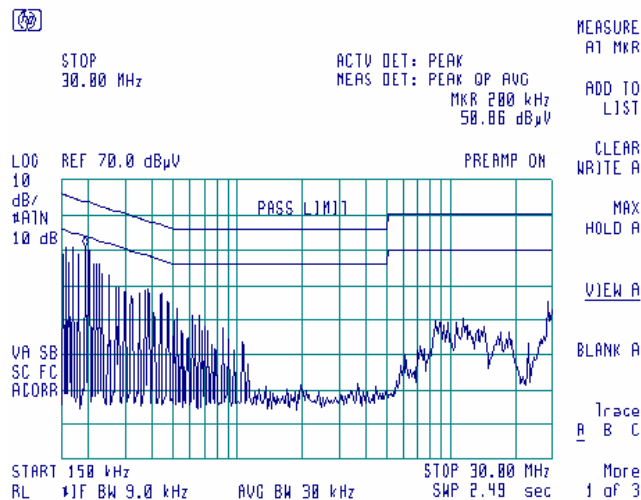



Plot 8.3.3 Conducted emission measurements

LINE: L1
LIMIT: Class B
EUT OPERATING MODE: Receive (iDEN uplink)
LIMIT: QUASI-PEAK, AVERAGE
DETECTOR: PEAK

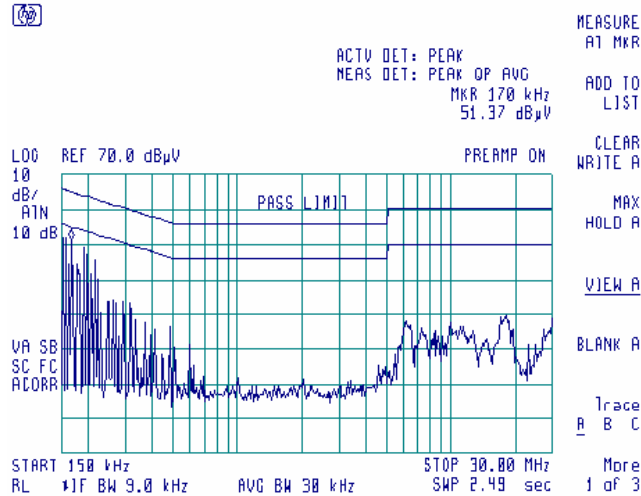

Plot 8.3.4 Conducted emission measurements

LINE: L2
LIMIT: Class B
EUT OPERATING MODE: Receive (iDEN uplink)
LIMIT: QUASI-PEAK, AVERAGE
DETECTOR: PEAK

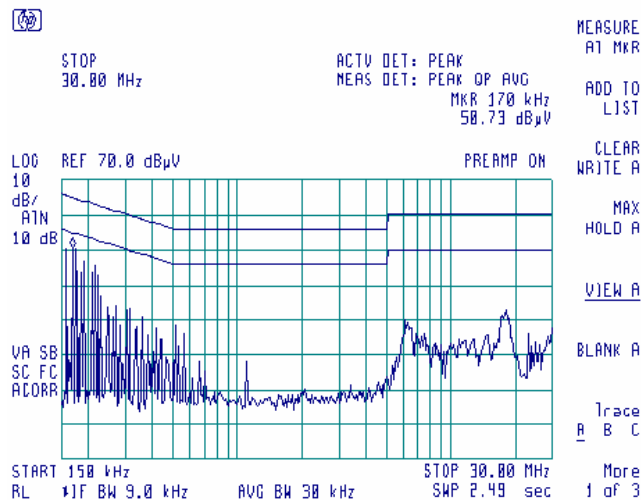



Plot 8.3.5 Conducted emission measurements

LINE: L1
LIMIT: Class B
EUT OPERATING MODE: Transmit (SMR downlink)
LIMIT: QUASI-PEAK, AVERAGE
DETECTOR: PEAK

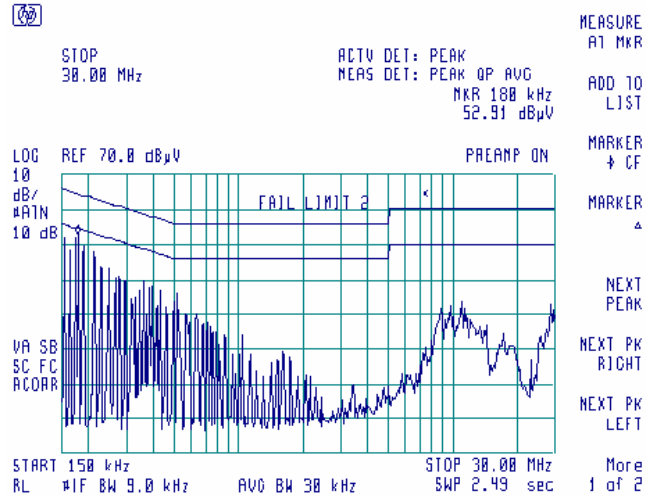

Plot 8.3.6 Conducted emission measurements

LINE: L2
LIMIT: Class B
EUT OPERATING MODE: Transmit (SMR downlink)
LIMIT: QUASI-PEAK, AVERAGE
DETECTOR: PEAK

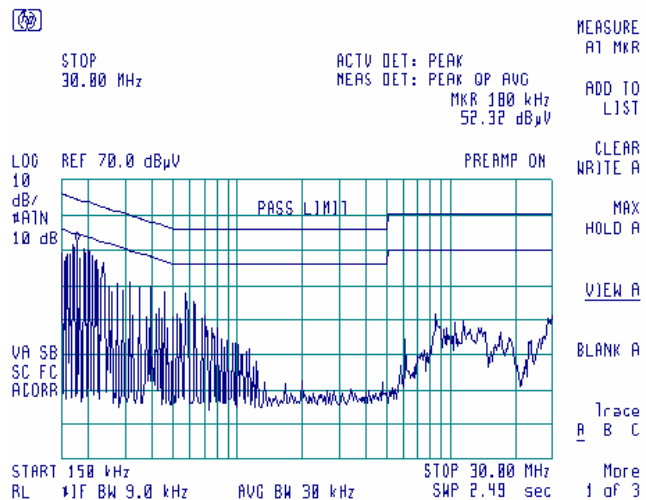



Plot 8.3.7 Conducted emission measurements

LINE: L1
LIMIT: Class B
EUT OPERATING MODE: Receive (SMR uplink)
LIMIT: QUASI-PEAK, AVERAGE
DETECTOR: PEAK

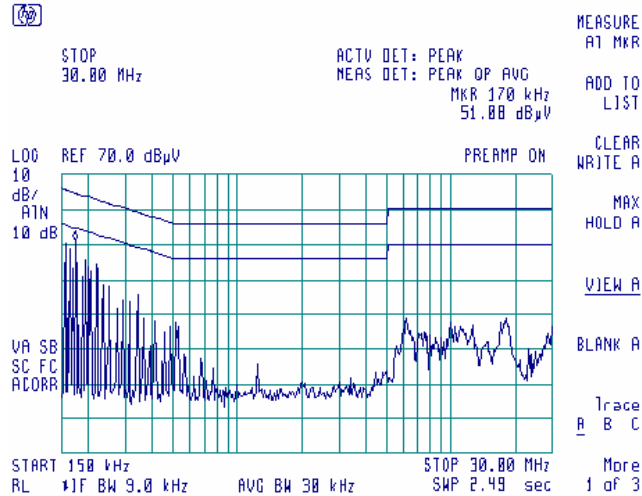

Plot 8.3.8 Conducted emission measurements

LINE: L2
LIMIT: Class B
EUT OPERATING MODE: Receive (SMR uplink)
LIMIT: QUASI-PEAK, AVERAGE
DETECTOR: PEAK

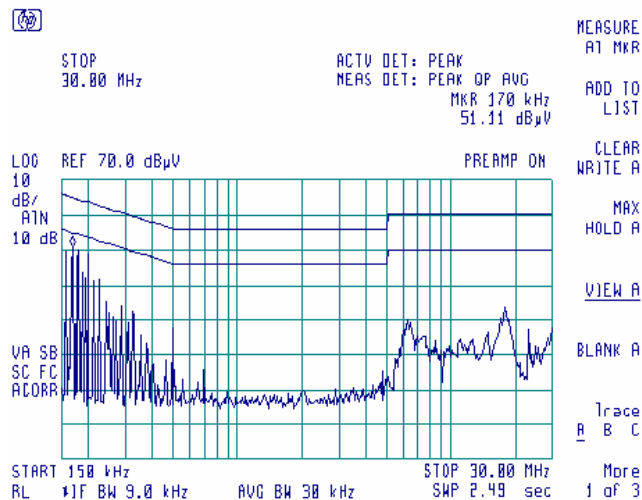



Appendix A Test equipment used for tests

HL No	Description	Manufacturer	Model	Ser. No.	Last Cal.	Due Cal.
0053	Attenuator, 50 Ohm, 2 W, 0 - 18 GHz, 10 dB	Hewlett Packard	8492A	7538	03-Mar-05	03-Mar-06
0056	Attenuator, 50 Ohm, 2 W, 0 - 18 GHz, 30 dB	Hewlett Packard	8492A	2627	03-Mar-05	03-Mar-06
0163	LISN FCC/VDE/MIL-STD	Electro-Metrics	ANS 25/2	1314	01-Oct-04	01-Oct-05
0410	Cable, Coax, Microwave, DC-18 GHz, N-N, 1 m	Gore	PFP01P0 1039.4	9338767	17-Oct-04	17-Oct-05
0446	Antenna, Loop active, 10kHz-30MHz	EMCO	6502	2857	28-Jun-04	28-Jun-05
0466	Shielded Room 3(L) x 3(W) x 2,4(H) m	HL	SR - 1	024	11-Nov-04	11-Nov-05
0521	EMI Receiver (Spectrum Analyzer) with RF filter section 9 kHz-6.5 GHz	Hewlett Packard	8546A	3617A 00319, 3448A002 53	11-Nov-04	11-Nov-05
0589	Cable Coaxial, GORE A2P01POL118, 2.3 m	HL	GORE-3	176	02-Dec-04	02-Dec-05
0592	Position Controller	HL	L2-SR3000 (HL CRL-3)	100	02-Dec-04	02-Dec-05
0593	Antenna Mast, 1-4 m Pneumatic	Madgesh	AM-F1	101	03-Feb-05	03-Feb-06
0594	Turn Table FOR ANECHOIC CHAMBER flush mount d=1.2 m Pneumatic	HL	TT-WDC1	102	27-Jan-05	27-Jan-06
0604	Antenna BiconiLog Log-Periodic/T Bow-TIE 26 - 2000 MHz	EMCO	3141	9611-1011	27-Jan-05	27-Jan-06
0659	Amplifier 1 to 4 GHz, 55 W	Milmega	AS0104-55/55B	971386	10-Jan-05	10-Jan-06
0787	Transient Limiter	Hewlett Packard	11947A	3107A018 77	21-Nov-04	21-Nov-05
1004	Cable Coaxial , ANDREW PSWJ4 , 6m	HL	ANDREW-6	163	02-Dec-04	02-Dec-05
1424	Spectrum Analyzer, 30 Hz- 40 GHz	Agilent Technologies (HP)	8564EC	3946A002 19	30-Aug-04	30-Aug-05
1453	Cable, 1 m	Harbour Industries	MIL 17/60-RG142	1453	23-Sep-04	23-Sep-05
1455	Cable, 1 m	Harbour Industries	MIL 17/60-RG142	1455	23-Sep-04	23-Sep-05
1463	Cable, 1 m	Harbour Industries	MIL 17/60-RG142	1463	23-Sep-04	23-Sep-05
1480	Cable, 1 m	Harbour Industries	MIL 17/60-RG142	1480	23-Sep-04	23-Sep-05
1481	Cable, 1 m	Harbour Industries	MIL 17/60-RG142	1481	23-Sep-04	23-Sep-05
1502	Cable RF, 6 m	Belden	M17/167 MIL-C-17	1502	12-Feb-05	12-Feb-06
1510	Cable RF, 8 m	Belden	M17/167 MIL-C-17	1510	02-Dec-04	02-Dec-05



HL No	Description	Manufacturer	Model	Ser. No.	Last Cal.	Due Cal.
1653	Analyzer EMC 9 kHz - 1.5 GHz	Agilent Technologies (HP)	E7401A	US39440281	06-Feb-05	06-Feb-06
1908	Power Splitter / Combiner 0.5-1 GHz	Mini-Circuits	ZAPD-1	1908	23-Sep-04	23-Sep-05
1942	Cable 18GHz, 4 m, blue	Rhophase Microwave Limited	SPS-1803A-4000-NPS	T4658	17-Oct-04	17-Oct-05
1947	Cable 18GHz, 6.5 m, blue	Rhophase Microwave Limited	NPS-1803A-6500-NPS	T4974	17-Oct-04	17-Oct-05
1984	Antenna, Double-Ridged Waveguide Horn, 1-18 GHz, 300 W, N-type	EMC Test Systems	3115	9911-5964	23-Sep-04	23-Sep-05
2009	Cable RF, 8 m	Alpha Wire	RG-214	C-56	02-Dec-04	02-Dec-05
2254	Cable 40GHz, 0.8 m, blue	Rhophase Microwave Limited	KPS-1503A-800-KPS	W4907	23-Sep-04	23-Sep-05
2259	Amplifier Low Noise 2-20 GHz	Sophia Wireless	LNA0220-C	0223	05-Nov-04	05-Nov-05
2399	Cable 40GHz, 1.5 m, blue	Rhophase Microwave Limited	KPS-1503A-1500-KPS	X2945	23-Sep-04	23-Sep-05
2432	Antenna, Double-Ridged Waveguide Horn 1-18 GHz	EMC Test Systems	3115	00027177	23-Sep-04	23-Sep-05
2499	Quadruplexer 1-12 GHz (1-2 GHz; 2-4GHz;4-8 GHz; 8-12GHz)	Elettronica S.p.A. - Roma	UE 84	D/00239	10-Feb-05	10-Feb-06
2524	Attenuator, 10 dB, DC-18 GHz	Midwest Microwave	263-10	2524	03-Jan-05	03-Jan-06



APPENDIX A Measurement uncertainties

Expanded uncertainty at 95% confidence in Hermon Labs EMC measurements

Test description	Expanded uncertainty
Transmitter tests	
Carrier power conducted at antenna connector	± 1.7 dB
Carrier power radiated (substitution method)	± 4.5 dB
Occupied bandwidth	±8%
Conducted emissions at RF antenna connector	9 kHz to 2.9 GHz: ± 2.6 dB 2.9 GHz to 6.46 GHz: ± 3.5 dB 6.46 GHz to 13.2 GHz: ± 4.3 dB 13.2 GHz to 22.0 GHz: ± 5.0 dB 22.0 GHz to 26.8 GHz: ± 5.5 dB 26.8 GHz to 40.0 GHz: ± 4.8 dB
Spurious emissions radiated 30 MHz – 40 GHz (substitution method)	± 4.5 dB
Frequency error	30 – 300 MHz: ± 50.5 Hz (1.68 ppm) 300 – 1000 MHz: ± 168 Hz (0.56 ppm)
Transient frequency behaviour	187 Hz ± 13.9 %
Duty cycle, timing (Tx ON / OFF) and average factor measurements	± 1.0 %
Unintentional radiator tests	
Conducted emissions with LISN	9 kHz to 150 kHz: ± 3.9 dB 150 kHz to 30 MHz: ± 3.8 dB
Radiated emissions at 3 m measuring distance Horizontal polarization	Biconilog antenna: ± 5.3 dB Biconical antenna: ± 5.0 dB Log periodic antenna: ± 5.3 dB Double ridged horn antenna: ± 5.3 dB
Vertical polarization	Biconilog antenna: ± 6.0 dB Biconical antenna: ± 5.7 dB Log periodic antenna: ± 6.0 dB Double ridged horn antenna: ± 6.0 dB

The test equipment has been calibrated according to its recommended procedures and is within the manufacturer's published limit of error. The standards and instruments used in the calibration system conform to the present requirements of ISO/IEC 17025 (or alternately ANSI/NCSL Z540-1).

The laboratory calibrates its measurement standards by a third party (traceable to NIST, USA) on a regular basis according to equipment manufacturer requirements. The Hermon Labs EMC measurements uncertainty is given in the table above.



Appendix C Test equipment correction factors

Correction factor
Line impedance stabilization network
Model ANS-25/2
Electro-Metrics

Frequency, kHz	Correction factor, dB
10	4.9
15	2.86
20	1.83
25	1.25
30	0.91
35	0.69
40	0.53
50	0.35
60	0.25
70	0.18
80	0.14
90	0.11
100	0.09
125	0.06
150	0.04

The correction factor in dB is to be added to meter readings of an interference analyzer or a spectrum analyzer.

Antenna factor
Active loop antenna
Model 6502, S/N 2857, HL 0446

Frequency, MHz	Magnetic antenna factor, dB	Electric antenna factor, dB
0.009	-32.8	18.7
0.010	-33.8	17.7
0.020	-38.3	13.2
0.050	-41.1	10.4
0.075	-41.3	10.2
0.100	-41.6	9.9
0.150	-41.7	9.8
0.250	-41.6	9.9
0.500	-41.8	9.8
0.750	-41.9	9.7
1.000	-41.4	10.1
2.000	-41.5	10.0
3.000	-41.4	10.2
4.000	-41.4	10.1
5.000	-41.5	10.1
10.000	-41.9	9.6
15.000	-41.9	9.6
20.000	-42.2	9.3
25.000	-42.8	8.7
30.000	-44.0	7.5

Antenna factor in dB(1/m) is to be added to receiver meter reading in dB(μ V) to convert it into field intensity in dB(μ V/m).



Antenna factor
Biconilog antenna EMCO Model 3141
Ser.No.1011

Frequency, MHz	Antenna Factor, dB(1/m)
26	7.8
28	7.8
30	7.8
40	7.2
60	7.1
70	8.5
80	9.4
90	9.8
100	9.7
110	9.3
120	8.8
130	8.7
140	9.2
150	9.8
160	10.2
170	10.4
180	10.4
190	10.3
200	10.6
220	11.6
240	12.4
260	12.8
280	13.7
300	14.7
320	15.2
340	15.4
360	16.1
380	16.4
400	16.6
420	16.7
440	17.0
460	17.7
480	18.1
500	18.5
520	19.1
540	19.5
560	19.8
580	20.6
600	21.3
620	21.5
640	21.2
660	21.4
680	21.9
700	22.2
720	22.2
740	22.1
760	22.3
780	22.6
800	22.7
820	22.9
840	23.1
860	23.4
880	23.8
900	24.1
920	24.1

Frequency, MHz	Antenna Factor, dB(1/m)
940	24.0
960	24.1
980	24.5
1000	24.9
1020	25.0
1040	25.2
1060	25.4
1080	25.6
1100	25.7
1120	26.0
1140	26.4
1160	27.0
1180	27.0
1200	26.7
1220	26.5
1240	26.5
1260	26.5
1280	26.6
1300	27.0
1320	27.8
1340	28.3
1360	28.2
1380	27.9
1400	27.9
1420	27.9
1440	27.8
1460	27.8
1480	28.0
1500	28.5
1520	28.9
1540	29.6
1560	29.8
1580	29.6
1600	29.5
1620	29.3
1640	29.2
1660	29.4
1680	29.6
1700	29.8
1720	30.3
1740	30.8
1760	31.1
1780	31.0
1800	30.9
1820	30.7
1840	30.6
1860	30.6
1880	30.6
1900	30.6
1920	30.7
1940	30.9
1960	31.2
1980	31.6
2000	32.0

Antenna factor in dB(1/m) is to be added to receiver meter reading in dB(μ V) to convert it into field intensity in dB(μ V/m).



Antenna factor
Double-ridged wave guide horn antenna
Model 3115, S/N 9911-5964, HL1984

Frequency, MHz	Antenna factor, dB(1/m)
1000.0	24.7
1500.0	25.7
2000.0	27.6
2500.0	28.9
3000.0	31.2
3500.0	32.0
4000.0	32.5
4500.0	32.7
5000.0	33.6
5500.0	35.1
6000.0	35.4
6500.0	34.9
7000.0	36.1
7500.0	37.8
8000.0	38.0
8500.0	38.1
9000.0	39.1
9500.0	38.3
10000.0	38.6
10500.0	38.2
11000.0	38.7
11500.0	39.5
12000.0	40.0
12500.0	40.4
13000.0	40.5
13500.0	41.1
14000.0	41.6
14500.0	41.7
15000.0	38.7
15500.0	38.2
16000.0	38.8
16500.0	40.5
17000.0	42.5
17500.0	45.9
18000.0	49.4

Antenna factor in dB(1/m) is to be added to receiver meter reading in dB(μ V) to convert it into field intensity in dB(μ V/m).



Antenna factor
Double-ridged guide horn antenna
Model 3115, serial number: 00027177, HL2432

Frequency, MHz	Antenna factor. dB(1/m)
1000.0	24.7
1500.0	25.7
2000.0	27.8
2500.0	28.9
3000.0	30.7
3500.0	31.8
4000.0	33.0
4500.0	32.8
5000.0	34.2
5500.0	34.9
6000.0	35.2
6500.0	35.4
7000.0	36.3
7500.0	37.3
8000.0	37.5
8500.0	38.0
9000.0	38.3
9500.0	38.3
10000.0	38.7
10500.0	38.7
11000.0	38.9
11500.0	39.5
12000.0	39.5
12500.0	39.4
13000.0	40.5
13500.0	40.8
14000.0	41.5
14500.0	41.3
15000.0	40.2
15500.0	38.7
16000.0	38.5
16500.0	39.8
17000.0	41.9
17500.0	45.8
18000.0	49.1

Antenna factor in dB(1/m) is to be added to receiver meter reading in dB(μ V) to convert it into field intensity in dB(μ V/m).



Cable loss
Cable GORE, HL 0410

No.	Frequency, GHz	Cable loss, dB
1	0.5	0.16
2	1	0.28
3	2	0.38
4	4	0.55
5	6	0.85
6	8	0.90
7	10	1.07
8	12	1.11
9	14	1.29
10	16	1.41
11	18	1.73



Cable loss
Cable Coaxial, GORE A2P01POL118, 2.3 m, model:GORE-3, HL 0589
+ Cable Coaxial, ANDREW PSWJ4, 6m, model: ANDREW-6, HL 1004

No.	Frequency, MHz	Cable loss, dB	Tolerance (Specification), dB	Measurement uncertainty, dB	
1	30	0.33	≤ 6.5	±0.12	
2	50	0.40			
3	100	0.57			
4	300	0.97			
5	500	1.25			
6	800	1.59			
7	1000	1.81			
8	1200	1.97			
9	1400	2.15			
10	1600	2.28			
11	1800	2.43			
12	2000	2.61			
13	2200	2.75			
14	2400	2.89			
15	2600	2.97			
16	2800	3.21	≤ 6.5	±0.12	
17	3000	3.32			
18	3300	3.47			
19	3600	3.62			
20	3900	3.84			
21	4200	3.92			±0.17
22	4500	4.07			
23	4800	4.36			
24	5100	4.62			
25	5400	4.78			
26	5700	5.16			
27	6000	5.67			
28	6500	5.99			



Cable loss
Cable MIL 17/60-RG142, HL 1481

Frequency, GHz	Cable loss, dB
2	1
2.2	1.1
2.4	1.1
2.6	1.2
2.8	1.2
3	1.2
3.2	1.3
3.4	1.3
3.6	1.5
3.8	1.5
4	1.6
4.2	1.7
4.4	1.8
4.6	1.9
4.8	2
5	2
5.2	2
5.4	2.1
5.6	2.1
5.8	2.2
6	2.2
6.2	2.2
6.4	2.3
6.6	2.3
6.8	2.3
7	2.4
7.2	2.4
7.4	2.5
7.6	2.5
7.8	2.6
8	2.7
8.2	2.8
8.4	3.1
8.6	3.3
8.8	3.5
9	4



Cable loss
Cable coaxial, 6 m, model: M17/167 MIL-C-17, HL 1502

Frequency, MHz	Cable loss, dB
0.1	0.02
1	0.07
3	0.15
5	0.17
10	0.26
30	0.43
50	0.57
80	0.72
100	0.81
300	1.48
500	2.00
800	2.70
1000	3.09

Cable loss
Cable M17/167 MIL-C-17, HL 1510

No.	Frequency, MHz	Cable loss, dB
1	0.1	0.05
2	1	0.09
3	3	0.16
4	5	0.18
5	10	0.27
6	30	0.44
7	50	0.58
8	80	0.69
9	100	0.82
10	300	1.48
11	500	2.01
12	800	2.65
13	1000	3.12



Cable loss
Cable 18 GHz, 4 m, blue, model: SPS-1803A-4000-NPS, S/N T4658, HL 1942

Frequency, GHz	Cable loss, dB
0.03	0.21
0.05	0.26
0.10	0.36
0.20	0.50
0.30	0.61
0.40	0.70
0.50	0.78
0.60	0.85
0.70	0.93
0.80	0.99
0.90	1.04
1.00	1.10
1.10	1.16
1.20	1.22
1.30	1.26
1.40	1.31
1.50	1.35
1.60	1.41
1.70	1.45
1.80	1.49
1.90	1.53
2.00	1.57
2.10	1.61
2.20	1.65
2.30	1.69
2.40	1.72
2.50	1.76
2.60	1.79
2.70	1.83
2.80	1.87
2.90	1.90
3.10	1.97
3.30	2.04
3.50	2.11
3.70	2.18
3.90	2.24
4.10	2.31
4.30	2.38
4.50	2.43
4.70	2.53
4.90	2.53
5.10	2.63
5.30	2.65
5.50	2.72
5.70	2.76
5.90	2.79

Frequency, GHz	Cable loss, dB
6.10	2.88
6.30	2.90
6.50	2.97
6.70	3.02
6.90	3.04
7.10	3.07
7.30	3.12
7.50	3.13
7.70	3.19
7.90	3.24
8.10	3.30
8.30	3.36
8.50	3.45
8.70	3.41
8.90	3.45
9.10	3.42
9.30	3.55
9.50	3.48
9.70	3.58
9.90	3.61
10.10	3.66
10.30	3.68
10.50	3.70
10.70	3.70
10.90	3.75
11.10	3.78
11.30	3.86
11.50	3.98
11.70	4.10
11.90	4.12
12.10	4.09
12.40	4.13
13.00	4.23
13.50	4.35
14.00	4.40
14.50	4.44
15.00	4.57
15.50	4.66
16.00	4.64
16.50	4.66
17.00	4.75
17.50	4.85
18.00	4.93



Cable loss
Cable 18 GHz, 6.5 m, blue, model: NPS-1803A-6500-NPS, S/N T4974, HL 1947

Frequency, GHz	Cable loss, dB
0.03	0.30
0.05	0.38
0.10	0.53
0.20	0.74
0.30	0.91
0.40	1.05
0.50	1.18
0.60	1.29
0.70	1.40
0.80	1.50
0.90	1.59
1.00	1.68
1.10	1.77
1.20	1.86
1.30	1.94
1.40	2.01
1.50	2.08
1.60	2.16
1.70	2.22
1.80	2.29
1.90	2.36
2.00	2.42
2.10	2.48
2.20	2.54
2.30	2.60
2.40	2.66
2.50	2.71
2.60	2.77
2.70	2.83
2.80	2.89
2.90	2.95
3.10	3.06
3.30	3.17
3.50	3.28
3.70	3.39
3.90	3.51
4.10	3.62
4.30	3.76
4.50	3.87
4.70	4.01
4.90	4.10
5.10	4.21
5.30	4.31
5.50	4.43
5.70	4.56
5.90	4.71

Frequency, GHz	Cable loss, dB
6.10	4.87
6.30	4.95
6.50	4.94
6.70	4.88
6.90	4.87
7.10	4.83
7.30	4.85
7.50	4.86
7.70	4.91
7.90	4.96
8.10	5.03
8.30	5.08
8.50	5.13
8.70	5.21
8.90	5.22
9.10	5.34
9.30	5.35
9.50	5.52
9.70	5.51
9.90	5.66
10.10	5.70
10.30	5.78
10.50	5.79
10.70	5.82
10.90	5.86
11.10	5.94
11.30	6.06
11.50	6.21
11.70	6.44
11.90	6.61
12.10	6.76
12.40	6.68
13.00	6.66
13.50	6.81
14.00	6.90
14.50	6.90
15.00	6.97
15.50	7.17
16.00	7.28
16.50	7.27
17.00	7.38
17.50	7.68
18.00	7.92



Cable loss
RF cable 8 m, model RG-214, HL 2009

No.	Frequency, MHz	Cable loss, dB	Tolerance (Specification), dB	Measurement uncertainty, dB
1	1	0.10	NA	±0.12
2	10	0.14		
3	30	0.25		
4	50	0.34		
5	100	0.53		
6	300	0.99		
7	500	1.31		
8	800	1.73		
9	1000	1.98		
10	1100	2.11		
11	1200	2.21		
12	1300	2.35		
13	1400	2.46		
14	1500	2.55		
15	1600	2.68		
16	1700	2.78		
17	1800	2.88		
18	1900	2.98		
19	2000	3.09		



Cable loss
Cable 40 GHz, 0.8 m, blue, model: KPS-1503A-800-KPS, S/N W4907, HL 2254

Frequency, GHz	Cable loss, dB	Frequency, GHz	Cable loss, dB	Frequency, GHz	Cable loss, dB
0.03	0.04	5.10	0.80	15.00	1.49
0.05	0.07	5.30	0.83	15.50	1.49
0.10	0.09	5.50	0.83	16.00	1.46
0.20	0.15	5.70	0.84	16.50	1.47
0.30	0.19	5.90	0.87	17.00	1.50
0.40	0.25	6.10	0.86	17.50	1.57
0.50	0.29	6.30	0.89	18.00	1.63
0.60	0.33	6.50	0.90	18.50	1.57
0.70	0.37	6.70	0.89	19.00	1.63
0.80	0.41	6.90	0.93	19.50	1.65
0.90	0.44	7.10	0.92	20.00	1.64
1.00	0.45	7.30	0.95	20.50	1.75
1.10	0.48	7.50	0.96	21.00	1.72
1.20	0.51	7.70	0.97	21.50	1.78
1.30	0.53	7.90	1.01	22.00	1.76
1.40	0.54	8.10	1.00	22.50	1.72
1.50	0.57	8.30	1.05	23.00	1.83
1.60	0.59	8.50	1.04	23.50	1.80
1.70	0.64	8.70	1.07	24.00	1.90
1.80	0.67	8.90	1.11	24.50	1.81
1.90	0.69	9.10	1.09	25.00	1.98
2.00	0.71	9.30	1.14	25.50	1.91
2.10	0.73	9.50	1.12	26.00	2.02
2.20	0.75	9.70	1.15	26.50	1.92
2.30	0.77	9.90	1.16	27.00	1.97
2.40	0.79	10.10	1.16	28.00	2.02
2.50	0.81	10.30	1.19	29.00	1.95
2.60	0.83	10.50	1.14	30.00	1.94
2.70	0.85	10.70	1.19	31.00	2.11
2.80	0.87	10.90	1.17	32.00	2.17
2.90	0.89	11.10	1.13	33.00	2.27
3.10	0.91	11.30	1.20	34.00	2.27
3.30	0.93	11.50	1.13	35.00	2.29
3.50	0.95	11.70	1.20	36.00	2.35
3.70	0.97	11.90	1.18	37.00	2.37
3.90	0.99	12.10	1.14	38.00	2.40
4.10	1.01	12.40	1.19	39.00	2.57
4.30	1.03	13.00	1.34	40.00	2.36
4.50	1.05	13.50	1.33		
4.70	1.07	14.00	1.48		
4.90	1.09	14.50	1.45		



Cable loss
Cable coaxial, 40GHz, 1.5 m, Blue, RhoPhase Microwave Limited, model: KPS-1503A-1500-KPS, HL 2399

Frequency, GHz	Cable loss, dB	Frequency, GHz	Cable loss, dB	Frequency, GHz	Cable loss, dB
0.03	0.07	6.5	1.57	15.50	2.50
0.05	0.10	6.7	1.60	16.00	2.51
0.1	0.16	6.9	1.55	16.50	2.58
0.2	0.26	7.1	1.65	17.00	2.65
0.3	0.33	7.3	1.65	17.50	2.73
0.5	0.38	7.5	1.70	18.00	2.74
0.7	0.41	7.7	1.71	18.50	2.67
0.9	0.58	7.9	1.73	19.00	2.67
1.1	0.64	8.1	1.79	19.50	2.74
1.3	0.70	8.3	1.81	20.00	2.69
1.5	0.75	8.5	1.84	20.50	2.80
1.7	0.79	8.7	1.85	21.00	2.82
1.9	0.83	8.9	1.90	21.50	2.87
2.1	0.88	9.1	1.95	22.00	2.87
2.3	0.93	9.3	1.93	22.50	2.92
2.5	0.97	9.5	1.98	23.50	3.04
2.7	1.01	9.7	1.96	24.00	3.05
2.9	1.04	9.9	2.03	24.50	3.03
3.1	1.08	10.1	1.99	25.00	3.11
3.3	1.14	10.30	2.02	25.50	3.10
3.5	1.17	10.50	2.02	26.00	3.17
3.7	1.21	10.70	2.02	26.50	3.11
3.9	1.24	10.90	2.08	27.00	3.16
4.1	1.26	11.10	2.02	28.00	3.19
4.3	1.26	11.30	2.09	29.00	3.19
4.5	1.29	11.50	2.05	30.00	3.30
4.7	1.34	11.70	2.11	31.00	3.31
4.9	1.34	11.90	2.11	32.00	3.35
5.1	1.40	12.10	2.12	33.00	3.46
5.3	1.43	12.40	2.17	34.00	3.45
5.5	1.45	13.00	2.29	35.00	3.49
5.7	1.47	13.50	2.31	36.00	3.54
5.9	1.40	14.00	2.43	37.00	3.62
6.1	1.53	14.50	2.43	39.00	3.69
6.3	1.55	15.00	2.46	40.00	3.75



Appendix D General information

Test facility description

Tests were performed at Hermon Laboratories Ltd., which is a fully independent, private, EMC, safety, environmental and telecommunication testing facility. Hermon Laboratories is listed by the Federal Communications Commission (USA) for all parts of Code of Federal Regulations 47 (CFR 47) and by Industry Canada for electromagnetic emissions (file numbers IC 2186-1 for OATS and IC 2186-2 for anechoic chamber), certified by VCCI, Japan (the registration numbers are R-808 for OATS, R-1082 for anechoic chamber, C-845 for conducted emissions site), assessed by TNO Certification EP&S (Netherlands) for a number of EMC, telecommunications, environmental, safety standards, and by AMTAC (UK) for safety of medical devices. The laboratory is accredited by American Association for Laboratory Accreditation (USA) according to ISO/IEC 17025 for electromagnetic compatibility, product safety, telecommunications testing and environmental simulation (for exact scope please refer to Certificate No. 839.01) and approved by Israel Ministry of environmental protection, radiation hazards department (Permit number 1158).

Address: PO Box 23, Binyamina 30500, Israel.

Telephone: +972 4628 8001

Fax: +972 4628 8277

e-mail: mail@hermonlabs.com

website: www.hermonlabs.com

Person for contact: Mr. Alex Usoskin, CEO.

Abbreviations and acronyms

The following abbreviations and acronyms are applicable to this test report:

AC	alternating current
cm	centimeter
dB	decibel
dBm	decibel referred to one milliwatt
dB(μ V)	decibel referred to one microvolt
dB(μ V/m)	decibel referred to one microvolt per meter
EMC	electromagnetic compatibility
EUT	equipment under test
GHz	gigahertz
H	height
HL	Hermon Laboratories
Hz	hertz
kHz	kilohertz
kV	kilovolt
L	length
LNA	low noise amplifier
m	meter
MHz	megahertz
NA	not applicable
QP	quasi-peak
RF	radio frequency
rms	root mean square
s	second
V	volt
W	width

Specification references

47CFR part 90: 2004	Private land mobile radio services
47CFR part 15: 2004	Radio Frequency Devices
ANSI C63.2:1996	American National Standard for Instrumentation-Electromagnetic Noise and Field Strength, 10 kHz to 40 GHz-Specifications.
ANSI C63.4:2001	American National Standard for Methods of Measurement of Radio-Noise Emissions from Low-Voltage Electrical and Electronic Equipment in the Range of 9 kHz to 40 GHz.