



DATE: 30 July 2014

I.T.L. (PRODUCT TESTING) LTD.
FCC Radio Test Report
for
Corning Optical Communication
Wireless

Equipment under test:

Remote Hub Unit

1000-CELL-PCS4E-HLN

Written by: 
R. Pinchuck, Documentation

Approved by: 
A. Sharabi, Test Engineer

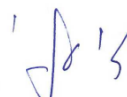
Approved by: 
I. Raz, EMC Laboratory Manager

This report must not be reproduced, except in full, without the written permission of I.T.L. (Product Testing) Ltd.

This report relates only to items tested.



Measurement/Technical Report for Corning Optical Communication Wireless Remote Hub Unit

FCC ID: OJFMA1K-CP-HLN

This report concerns:

Original Grant:

Class II change: X

Class I change:

Equipment type:

PCS Licensed Transmitter

Limits used:

47CFR Parts 22, 24

Measurement procedure used is ANSI C63.4-2003.

Substitution Method used as in ANSI/TIA-603-C: 2004

Application for Certification

prepared by:

R. Pinchuck

ITL (Product Testing) Ltd.

1 Bat Sheva St.

Lod 7120101

Israel

e-mail rpinchuck@itl.co.il

Applicant for this device:

(different from "prepared by")

Habib Riazi

Corning Optical Communication Wireless

13221 Woodland Park Rd., Suite #400

Herndon, VA. 20171

U.S.A.

Tel: +1-541-758-2880

Fax: +1-703-848-0260

e-mail: RiaziH@corning.com



TABLE OF CONTENTS

1.	GENERAL INFORMATION	5
1.1	Administrative Information	5
1.2	List of Accreditations	6
1.3	Product Description	7
1.4	Test Methodology	7
1.5	Test Facility	7
1.6	Measurement Uncertainty	7
2.	SYSTEM TEST CONFIGURATION	8
2.1	Justification	8
2.2	EUT Exercise Software	8
2.3	Special Accessories	8
2.4	Equipment Modifications	8
2.5	Configuration of Tested System	9
3.	CONDUCTED MEASUREMENT TEST SET-UP PHOTO	10
4.	PEAK OUTPUT POWER CELL	11
4.1	Test Specification	11
4.2	Test procedure	11
4.3	Test Results	11
4.4	Test Equipment Used, Peak Output Power CELL	17
5.	OCCUPIED BANDWIDTH CELL	18
5.1	Test Specification	18
5.2	Test Procedure	18
5.3	Test Results	19
5.4	Test Equipment Used, Occupied Bandwidth, CELL	29
6.	OUT OF BAND EMISSIONS AT ANTENNA TERMINALS CELL	30
6.1	Test Specification	30
6.2	Test procedure	30
6.3	Test Results	30
6.4	Test Equipment Used, Out of Band Emission at Antenna Terminals, CELL	34
7.	BAND EDGE SPECTRUM CELL	35
7.1	Test Specification	35
7.2	Test procedure	35
7.3	Test Results	36
7.4	Test Equipment Used, Band Edge Spectrum, CELL	39
8.	PEAK OUTPUT POWER PCS	40
8.1	Test Specification	40
8.2	Test procedure	40
8.3	Test Results	40
8.4	Test Equipment Used, Peak Output Power, PCS	44
9.	OCCUPIED BANDWIDTH PCS	45
9.1	Test Specification	45
9.2	Test Procedure	45
9.3	Results Table	46
9.4	Test Equipment Used, Occupied Bandwidth, PCS	53
10.	OUT OF BAND EMISSIONS AT ANTENNA TERMINALS PCS	54
10.1	Test Specification	54
10.2	Test procedure	54
10.3	Test Results	54
10.4	Test Equipment Used, Out of Band Emissions at Antenna Terminals, PCS	58
11.	BAND EDGE SPECTRUM PCS	59
11.1	Test Specification	59
11.2	Test procedure	59
11.3	Test Results	59



11.4	Test Equipment Used, Band Edge Spectrum, PCS	62
13.	APPENDIX A - CORRECTION FACTORS -----	63
13.1	Correction factors for CABLE	63
13.2	Correction factors for CABLE	64
13.3	Correction factors for CABLE	65
13.4	Correction factors for LOG PERIODIC ANTENNA	66
13.5	Correction factors for LOG PERIODIC ANTENNA	67
13.6	Correction factors for BICONICAL ANTENNA	68
13.7	Correction factors for Double-Ridged Waveguide Horn.....	69
13.8	Correction factors for ACTIVE LOOP ANTENNA	70



1. General Information

1.1 Administrative Information

Manufacturer:	Corning Optical Communication Wireless
Manufacturer's Address:	13221 Woodland Park Rd., Suite #400 Herndon, VA. 20171 Vienna, VA 22182 U.S.A. Tel: +1-541-758-2880 Fax: +1-703-848-0260
Manufacturer's Representative:	Habib Riazi
Equipment Under Test (E.U.T):	Remote Hub Unit
Equipment Model No.:	1000-CELL-PCS4E-HLN
Equipment Serial No.:	0B42028
Date of Receipt of E.U.T:	25.05.14
Start of Test:	26.05.14
End of Test:	29.05.14
Test Laboratory Location:	I.T.L (Product Testing) Ltd. Kfar Bin Nun, ISRAEL 99780
Test Specifications:	FCC Parts 22H, 24E



1.2 List of Accreditations

The EMC laboratory of I.T.L. is accredited by the following bodies:

1. The American Association for Laboratory Accreditation (A2LA) (U.S.A.), Certificate No. 1152.01.
2. The Federal Communications Commission (FCC) (U.S.A.), Registration No. 90715.
3. The Israel Ministry of the Environment (Israel), Registration No. 1104/01.
4. The Voluntary Control Council for Interference by Information Technology Equipment (VCCI) (Japan), Registration Numbers: C-1350, R-1285.
5. Industry Canada (Canada), IC File No.: 46405-4025; Site No. IC 4025B-1.

I.T.L. Product Testing Ltd. is accredited by the American Association for Laboratory Accreditation (A2LA) and the results shown in this test report have been determined in accordance with I.T.L.'s terms of accreditation unless stated otherwise in the report.



1.3 Product Description

The Wireless Network System provides coverage by routing RF signals from BTS (base transmit station) units, through optic fibers to remote areas where the signals are converted back to RF and interfaced to antennas covering the remote area. All system elements can be remotely controlled and monitored from a single location.

The system consists of the following elements:

Base Unit (BU):

Converts the RF signal received from the RIU to an optic signal that is then split and routed via optic fiber to Remote Hub Units located in remote locations.

Remote Hub Units (RHUs):

Converts the optic signal to an RF signal and feeds it to the antennas in the remote areas in order to provide the required coverage. The RHU provides coax connections to up to four antennas. The RHU filters and amplifies the optic signal received from the BU according to the service it supports.

1.4 Test Methodology

Both conducted and radiated testing were performed according to the procedures in ANSI C63.4: 2003. Radiated testing was performed at an antenna to EUT distance of 3 meters.

1.5 Test Facility

Both conducted and radiated emissions tests were performed at I.T.L.'s testing facility at Kfar Bin-Nun, Israel. This site is a FCC listed test laboratory (FCC Registration No. 90715, date of listing November 21, 2012). I.T.L.'s EMC Laboratory is also accredited by A2LA, certificate No. 1152.01.

1.6 Measurement Uncertainty

Radiated Emission (CISPR 11, EN 55011, CISPR 22, EN 55022, ANSI C63.4) for open site 30-1000MHz:

Expanded Uncertainty (95% Confidence, K=2):

± 4.96 dB



2. System Test Configuration

2.1 *Justification*

A FCC Grant was issued for the E.U.T. on 08/13/2012. The LTE modulation has been added to the CELL and PCS bands requiring a C2PC. The following tests were performed:

RF power output
Occupied bandwidth
Spurious emissions at antenna terminals
Band edge spectrum

2.2 *EUT Exercise Software*

The Element Management System EngGUI ver. 2.8 build 05 used for commands delivery.

These commands are used to enable / disable of RHU transmission.

RHU Embedded SW version 7.6 build 00

BU Embedded SW version 5.2 build 00

2.3 *Special Accessories*

No special accessories were needed in order to achieve compliance.

2.4 *Equipment Modifications*

No modifications were needed in order to achieve compliance.

2.5 Configuration of Tested System

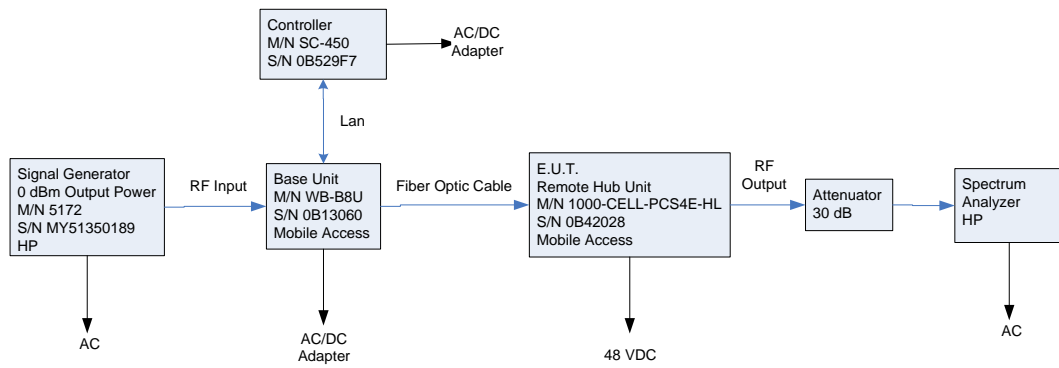

Figure 1. Conducted Tests Set-up

3. Conducted Measurement Test Set-Up Photo

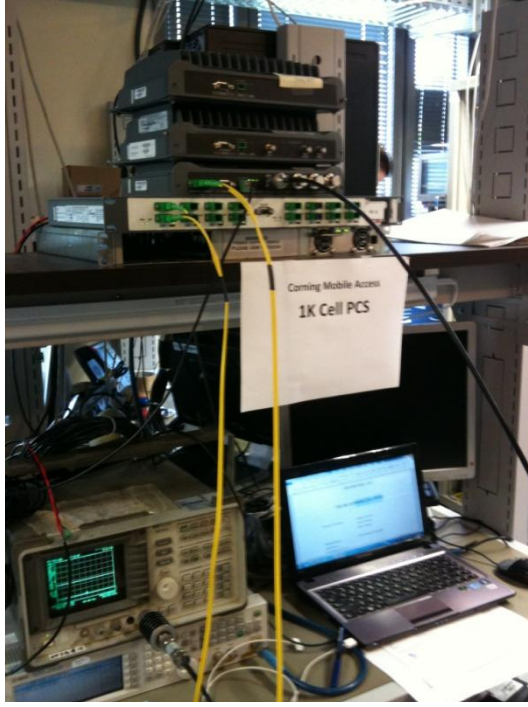

Figure 2. Conducted Emission From Antenna Ports Tests



4. Peak Output Power CELL

4.1 Test Specification

FCC Part 22.913

4.2 Test procedure

Peak Power Output must not exceed 500 Watts (57dBm).

The E.U.T. antenna terminal was connected to the Spectrum Analyzer through an external attenuator (30 dB) and an appropriate coaxial cable (0.5dB). The E.U.T. RF output was modulated. Special attention was taken to prevent Spectrum Analyzer RF input overload.

4.3 Test Results

Modulation	Channel	Reading (dBm)	Specification (dBm)	Margin (dB)
QPSK	874	24.16	57.0	-32.84
	881	24.60	57.0	-32.40
	889	24.34	57.0	-32.66
16QAM	874	24.74	57.0	-32.26
	881	24.58	57.0	-32.42
	889	24.14	57.0	-32.86
64QAM	874	24.25	57.0	-32.75
	881	24.52	57.0	-32.48
	889	24.78	57.0	-32.22

Figure 3 Peak Output Power CELL Test Results Table

See additional information in Figure 4 to Figure 12.

JUDGEMENT: Passed by 32.22 dB

TEST PERSONNEL:

Tester Signature: 

Date: 03.08.14

Typed/Printed Name: A. Sharabi



QPSK:

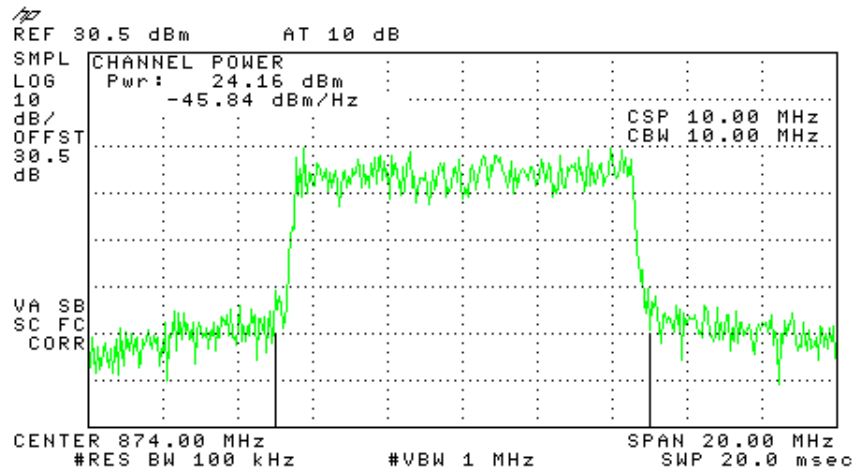

Figure 4 . 874MHz

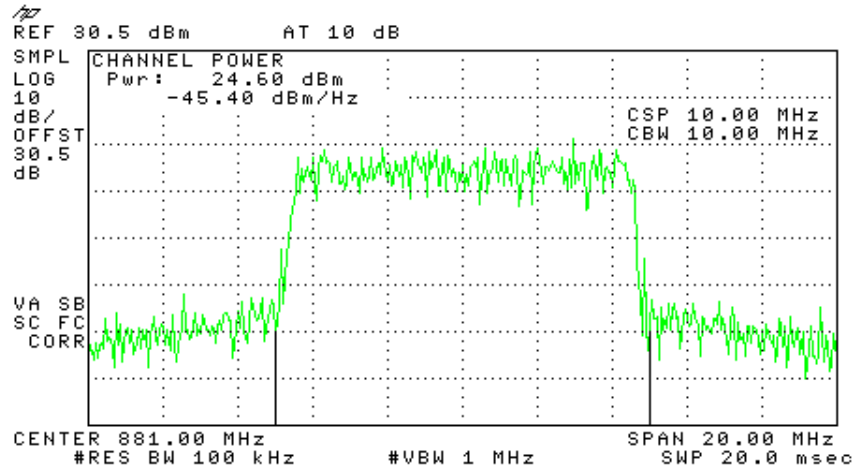

Figure 5 . 881MHz

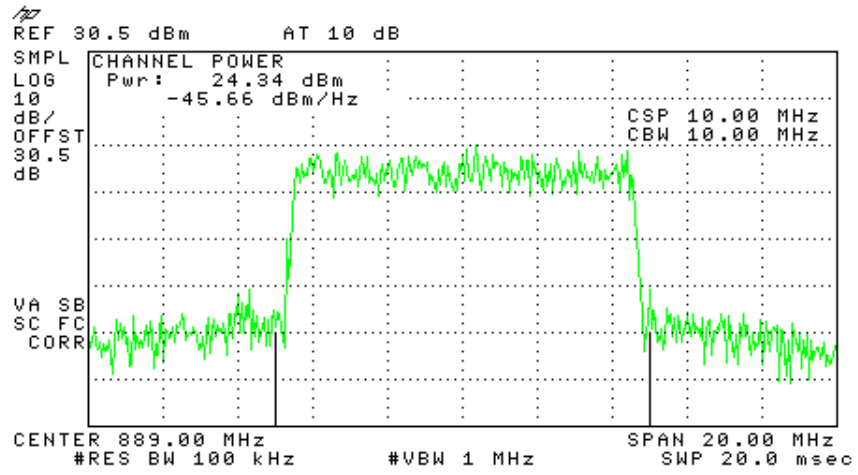

Figure 6 . 889MHz

16QAM:

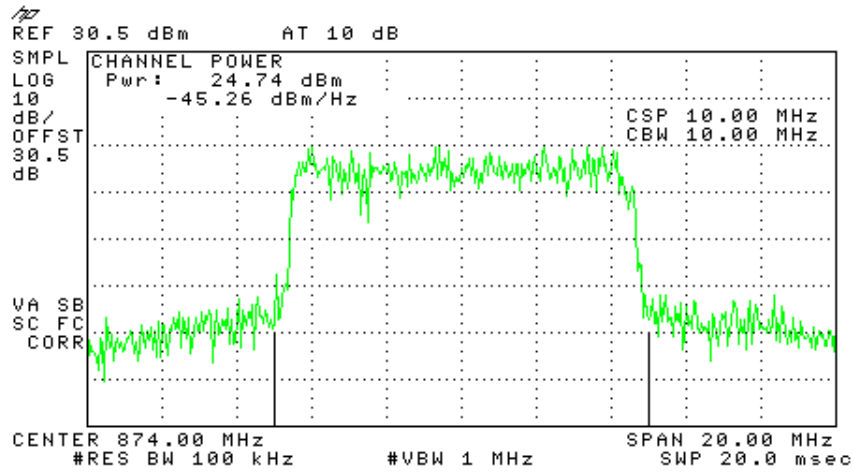

Figure 7 . 874MHz

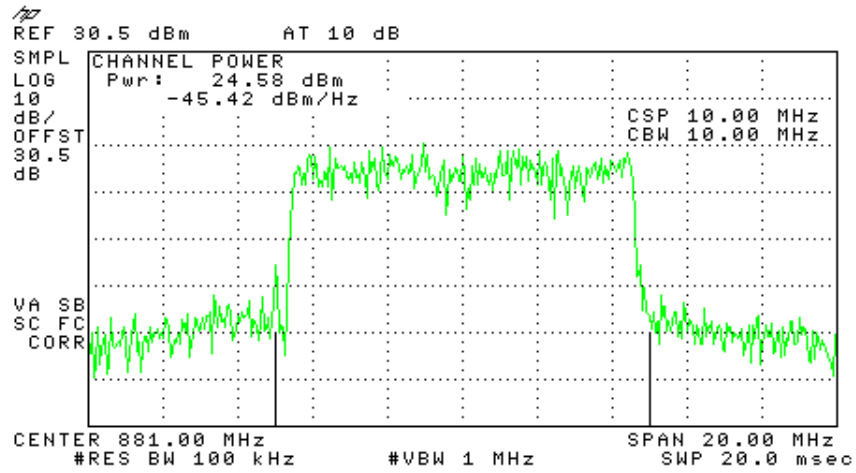

Figure 8 . 881MHz

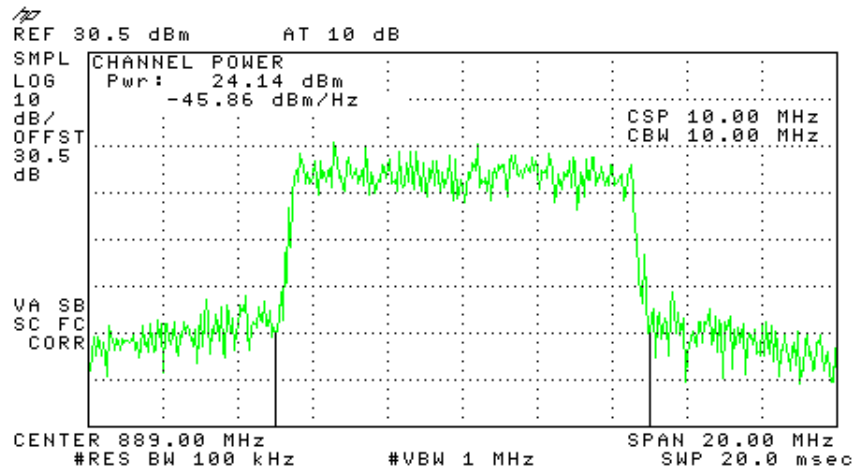

Figure 9 . 889MHz



64QAM:

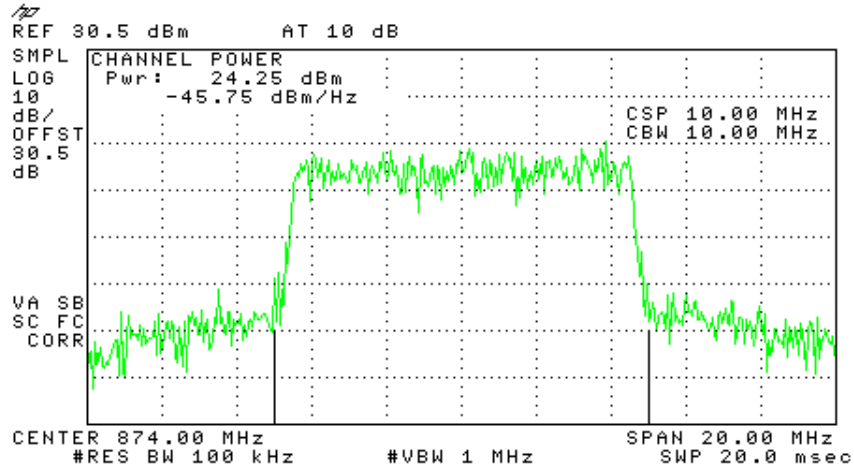

Figure 10 . 874MHz

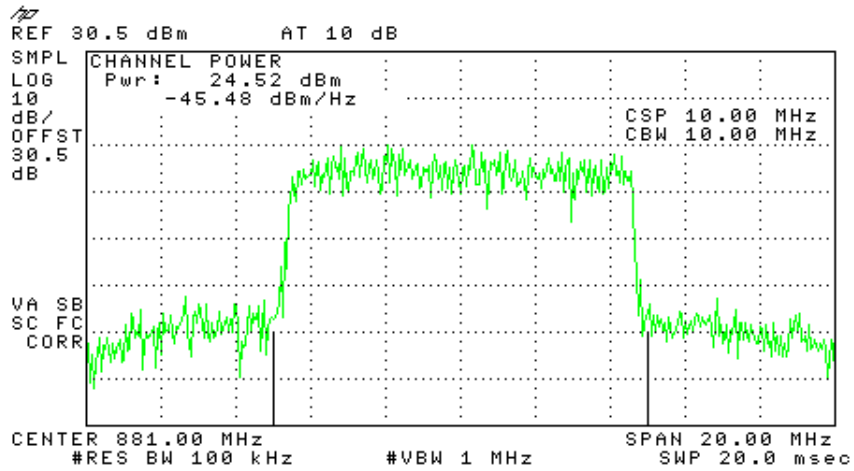

Figure 11 . 881MHz

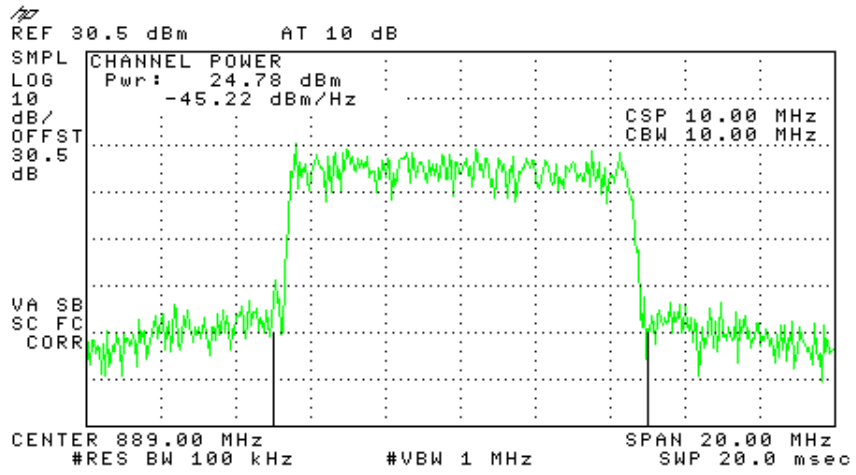

Figure 12 . 889MHz



4.4 Test Equipment Used, Peak Output Power CELL

Instrument	Manufacturer	Model	Serial Number	Calibration	
				Last Calibration	Period
Spectrum Analyzer	HP	8592L	3826A01204	February 28, 2014	1 year
Signal Generator	HP	N5182A	MY48180244	July 28, 2013	1 year
Attenuator	MCE	46-30-34	-	May 25, 2014	1 year
Cable	Rhophase	KPS-5000-KPS	A1674	May 25, 2014	1 year

Figure 13 Test Equipment Used



5. Occupied Bandwidth CELL

5.1 *Test Specification*

FCC Part 2, Section 1049

5.2 *Test Procedure*

The E.U.T. was set to the applicable test frequency with modulation. The E.U.T. antenna terminal was connected to the spectrum analyzer through an external attenuator (at the output test) and an appropriate coaxial cable. The spectrum analyzer was set to 100 kHz resolution B.W.

The occupied bandwidth, that is the frequency bandwidth such that, below its lower and above its upper frequency limit, the mean powers radiated are each equal to 0.5% of the total mean power radiated by a given emission.

The occupied bandwidth of the E.U.T. at the points of 20 dB below maximum peak power was measured and recorded.

Occupied bandwidth measured was repeated in the input terminal of the E.U.T.



5.3 Test Results

Modulation		Operating Frequency (MHz)	Reading (MHz)
QPSK	Input	874	9.38
	Input	881	9.34
	Input	889	9.38
16QAM	Input	874	9.38
	Input	881	9.38
	Input	889	9.38
64QAm	Input	874	9.34
	Input	881	9.34
	Input	889	9.34
QPSK	Output	874	9.45
	Output	881	9.55
	Output	889	9.50
16QAM	Output	874	9.70
	Output	881	9.65
	Output	889	9.50
64QAM	Output	874	9.70
	Output	881	9.65
	Output	889	9.60

Figure 14 Occupied Bandwidth CELL Test Results Table

See additional information in Figure 15 to Figure 32.

TEST PERSONNEL:

Tester Signature: 

Date: 03.08.14

Typed/Printed Name: A. Sharabi



INPUT QPSK:

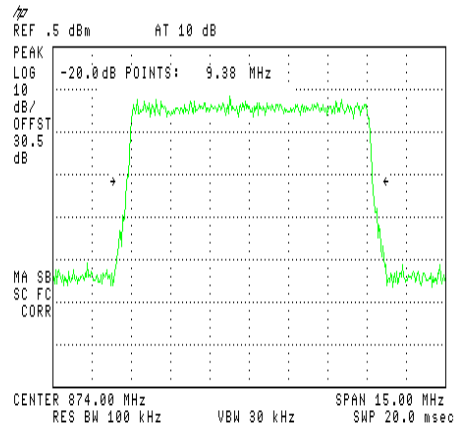

Figure 15.— 874 MHz

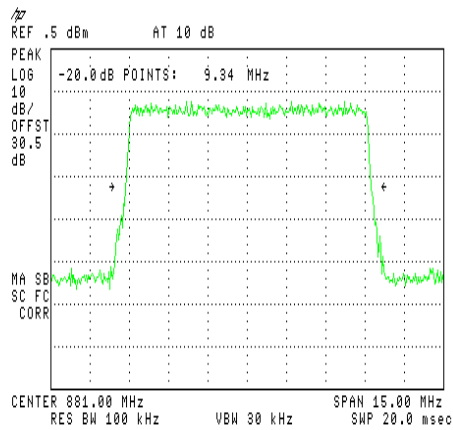

Figure 16.— 881 MHz

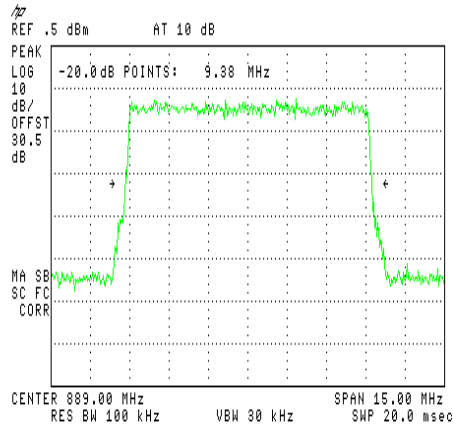

Figure 17.— 889 MHz

INPUT 16QAM:

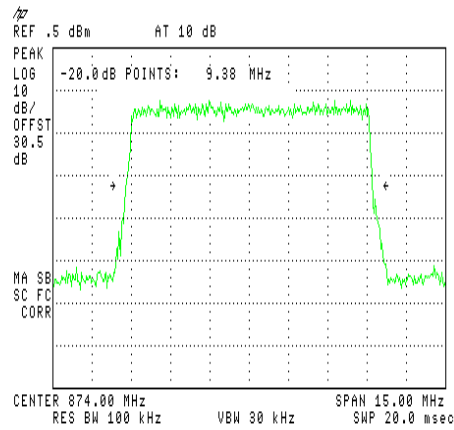

Figure 18.— 874 MHz

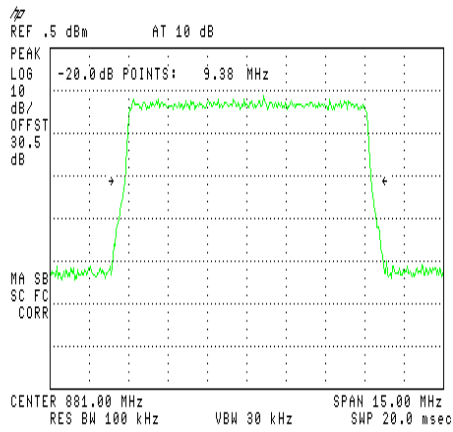

Figure 19.— 881 MHz

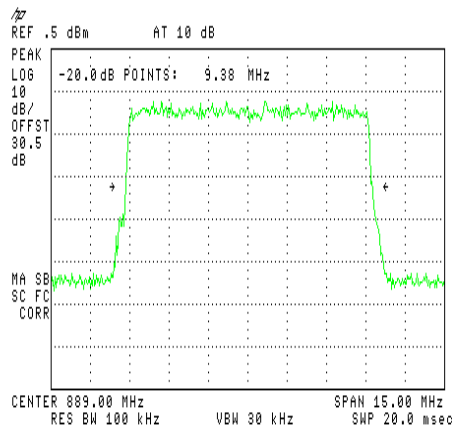

Figure 20.— 889 MHz



INPUT 64QAM:

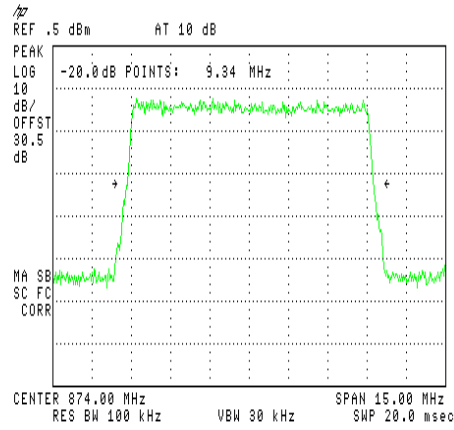

Figure 21.— 874 MHz

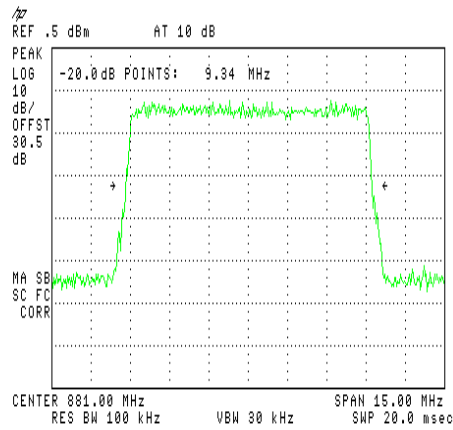

Figure 22.— 881 MHz

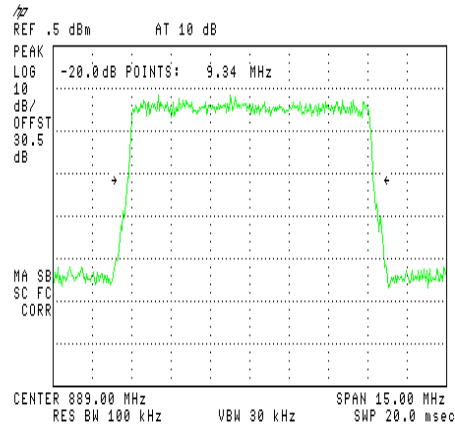

Figure 23.— 889 MHz

OUTPUT QPSK:

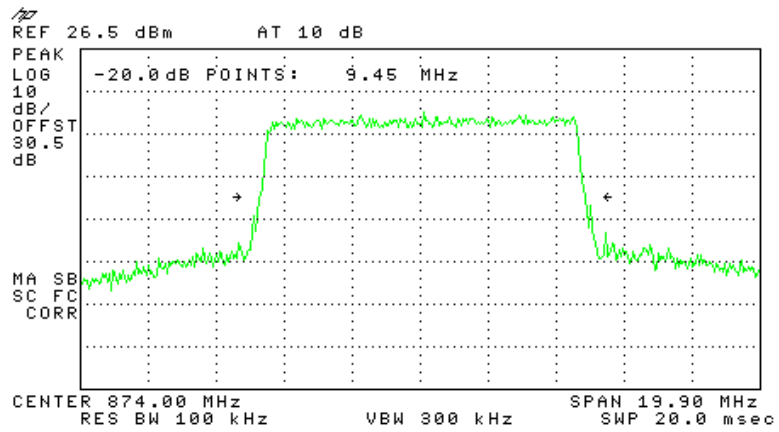

Figure 24.— 874 MHz

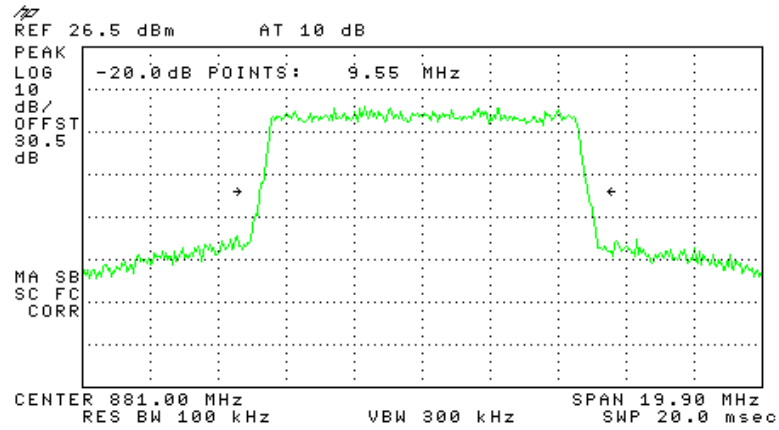

Figure 25.— 881 MHz

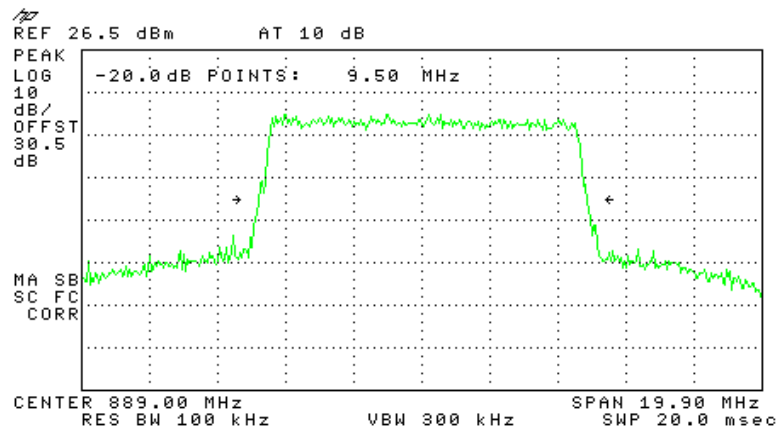

Figure 26.— 889 MHz



OUTPUT 16QAM:

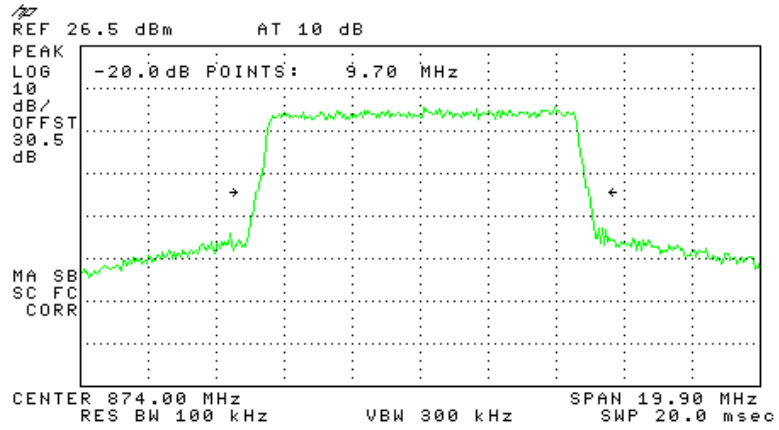

Figure 27.— 874 MHz

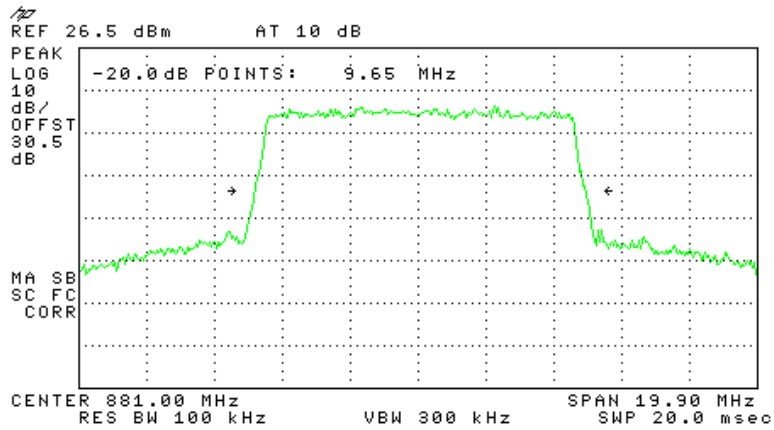

Figure 28.— 881 MHz

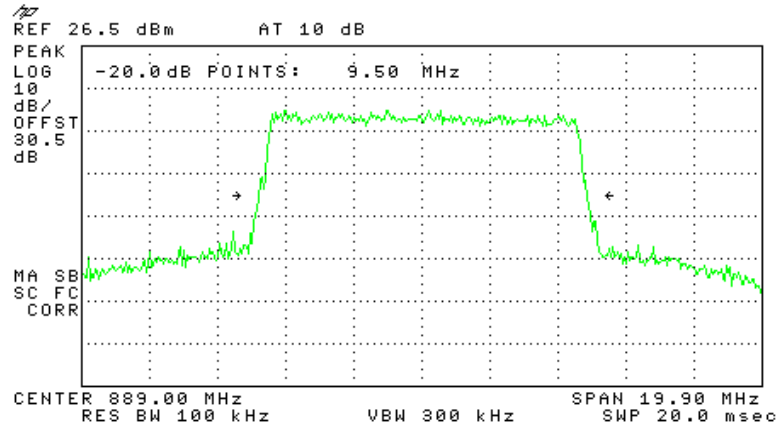

Figure 29.— 889 MHz

OUTPUT 64QAM:

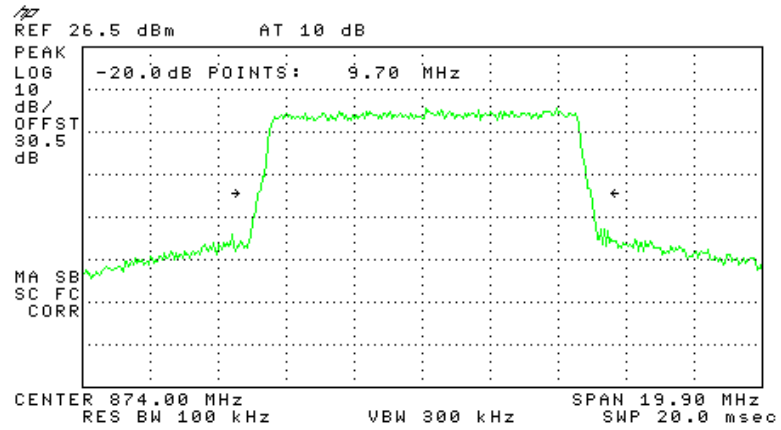

Figure 30.— 874 MHz

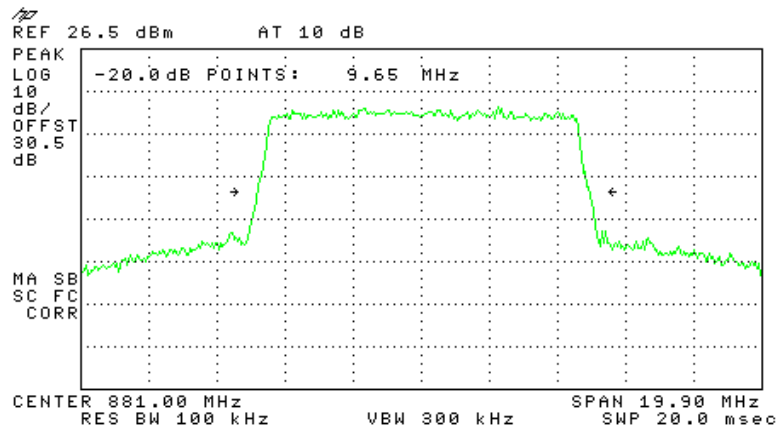

Figure 31.— 881 MHz

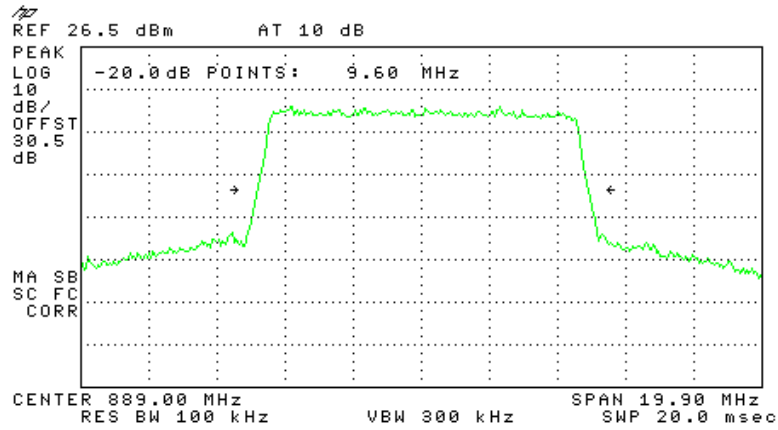

Figure 32.— 889 MHz



5.4 Test Equipment Used, Occupied Bandwidth, CELL

Instrument	Manufacturer	Model	Serial Number	Calibration	
				Last Calibration	Period
Spectrum Analyzer	HP	8592L	3826A01204	February 28, 2014	1 year
Signal Generator	HP	N5182A	MY48180244	July 28, 2013	1 year
Attenuator	MCE	46-30-34	-	May 25, 2014	1 year
Cable	Rhophase	KPS-5000-KPS	A1674	May 25, 2014	1 year

Figure 33 Test Equipment Used



6. Out of Band Emissions at Antenna Terminals CELL

6.1 Test Specification

FCC Part 22, Section 917; FCC Part 2.1051

6.2 Test procedure

The power of any emission outside of the authorized operating frequency ranges (869 - 894 MHz) must be attenuated below the transmitting power (P) by a factor of at least $43 + \log(P)$ dB, yielding -13dBm .

The E.U.T. antenna terminal was connected to the spectrum analyzer through an external attenuator and an appropriate coaxial cable (30.5 dB).

6.3 Test Results

The E.U.T. met the requirements of FCC Part 22, Section 22.219.
See plots in Figure 34 to Figure 42.

JUDGEMENT: Passed

TEST PERSONNEL:

Tester Signature: 

Date: 03.08.14

Typed/Printed Name: A. Sharabi



QPSK:

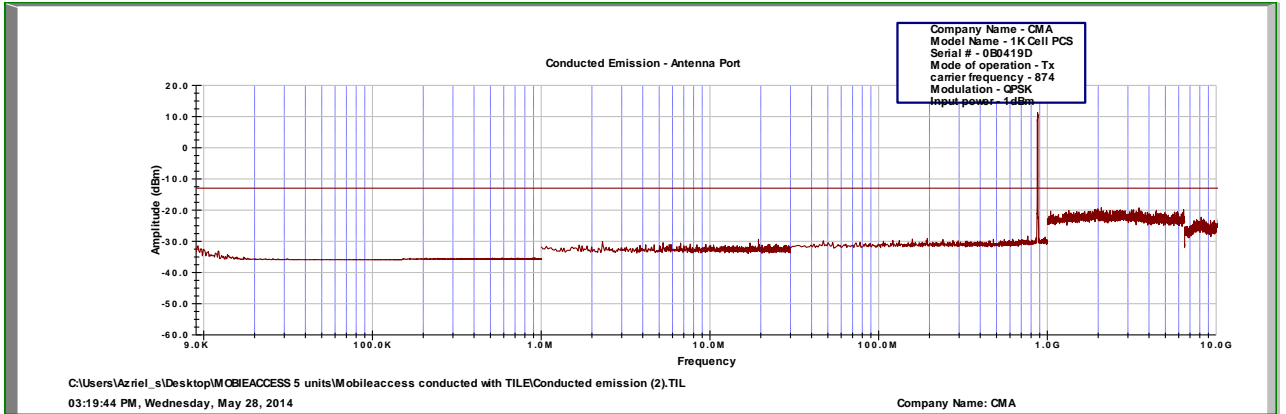

Figure 34 . 874MHz

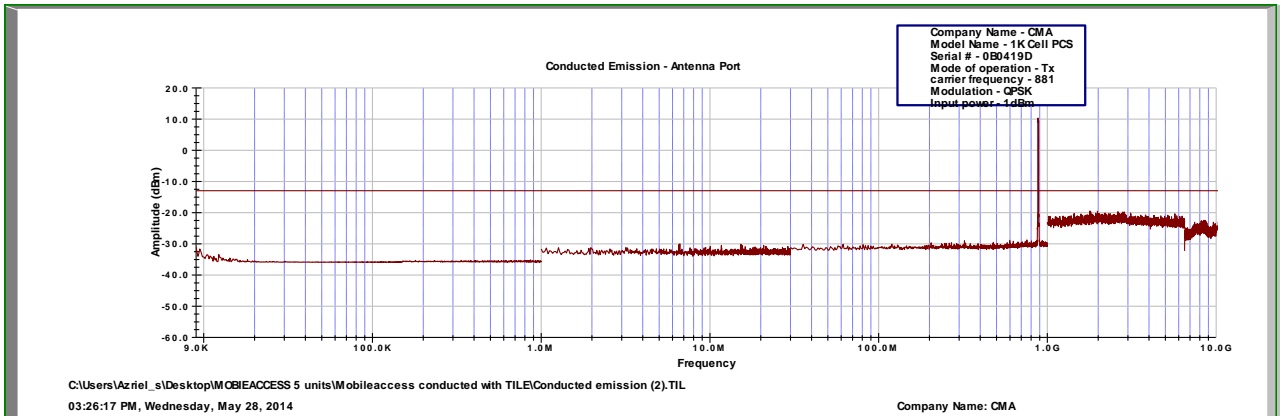

Figure 35 . 881MHz

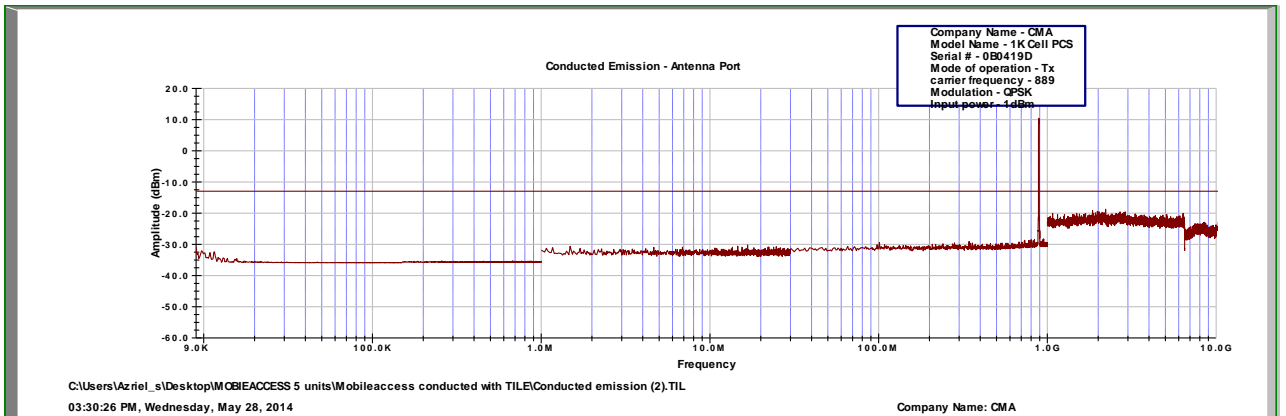

Figure 36 . 889MHz



16QAM:

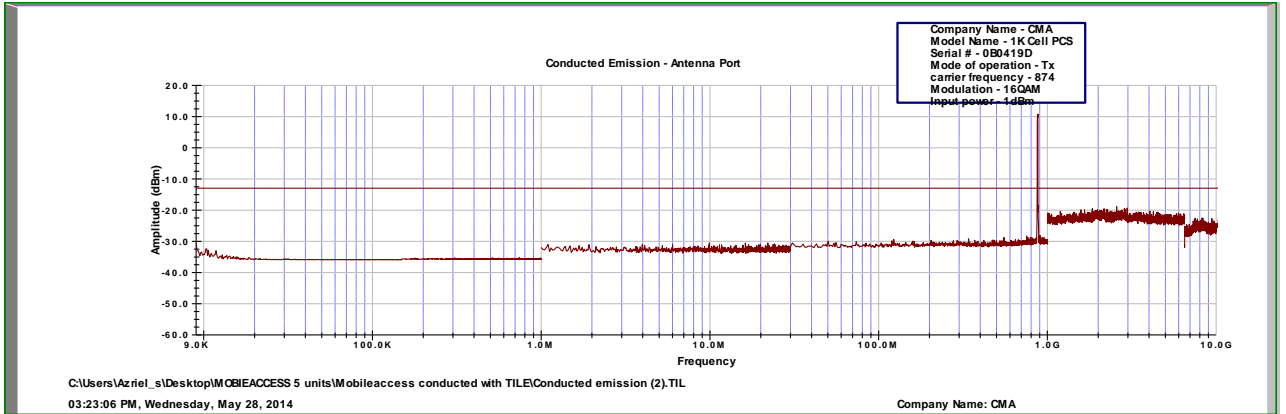

Figure 37 . 874MHz

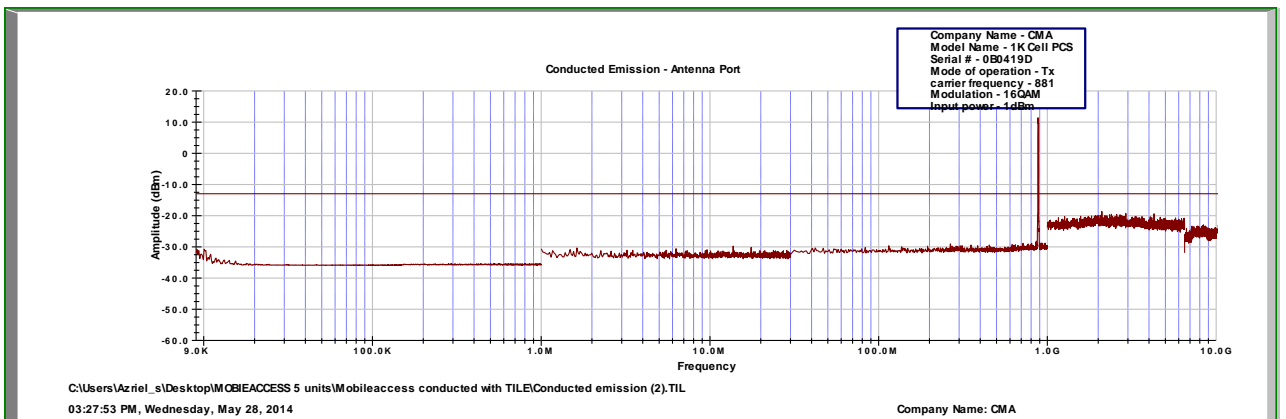

Figure 38 . 881MHz

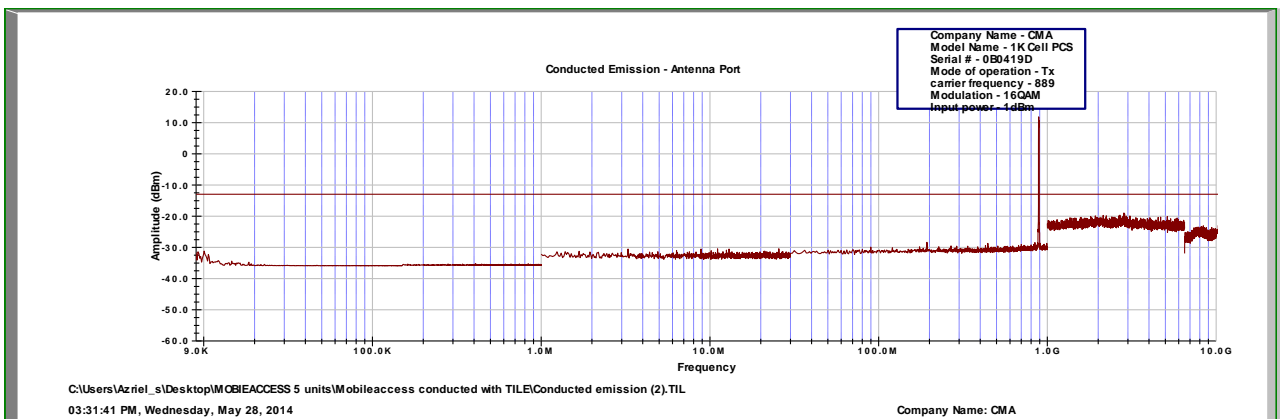

Figure 39 . 889MHz



64QAM:

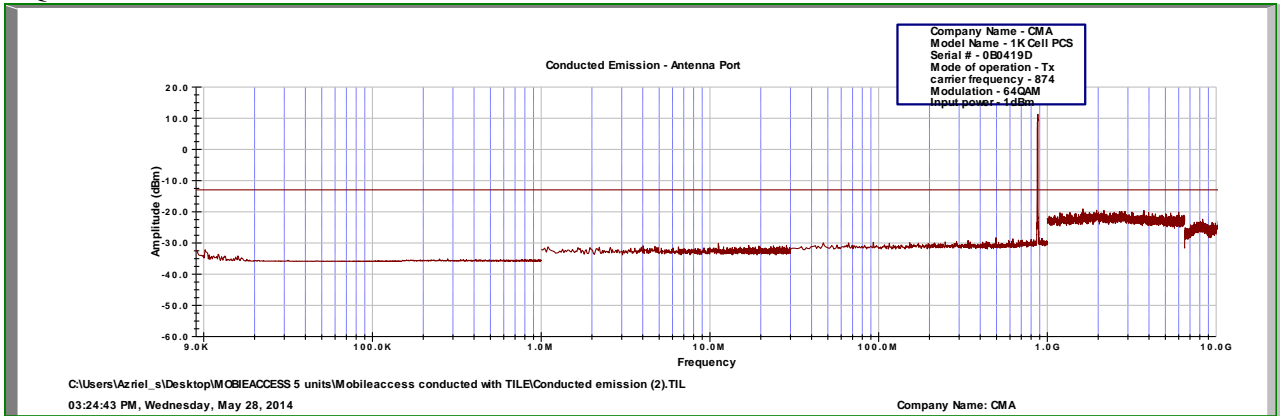

Figure 40 . 874MHz

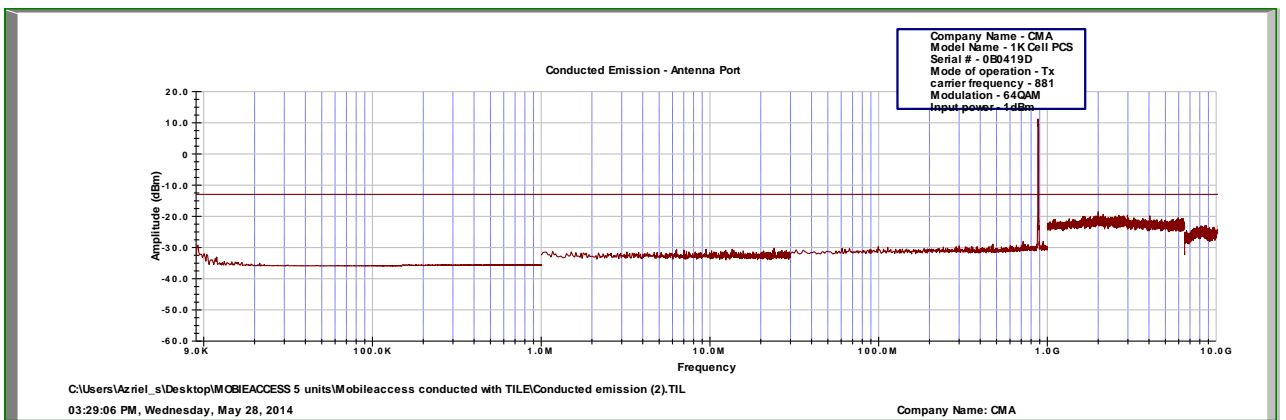

Figure 41 . 881MHz

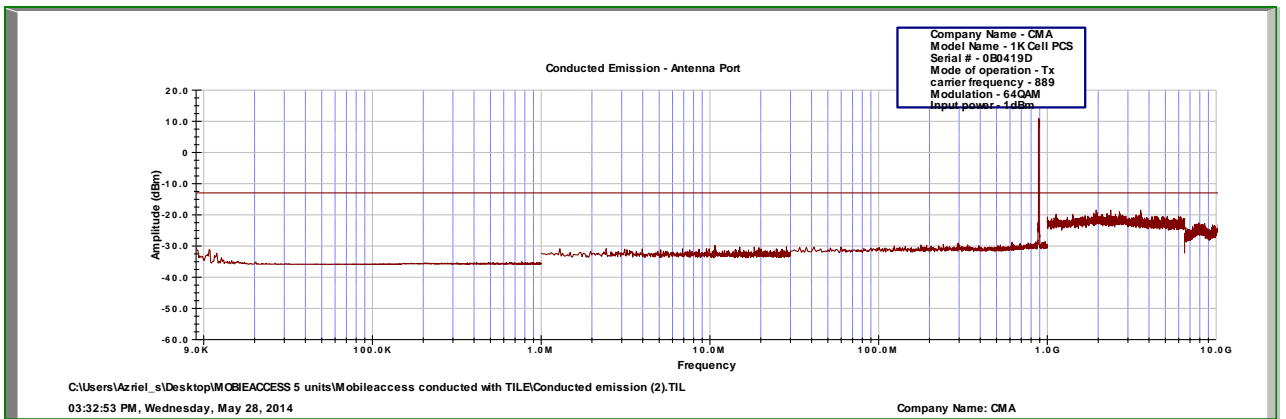

Figure 42 . 889MHz



6.4 Test Equipment Used, Out of Band Emission at Antenna Terminals, CELL

Instrument	Manufacturer	Model	Serial Number	Calibration	
				Last Calibration	Period
Spectrum Analyzer	HP	8592L	3826A01204	February 28, 2014	1 year
Signal Generator	HP	N5182A	MY48180244	July 28, 2013	1 year
Attenuator	MCE	46-30-34	-	May 25, 2014	1 year
Cable	Rhophase	KPS-5000-KPS	A1674	May 25, 2014	1 year

Figure 43 Test Equipment Used



7. Band Edge Spectrum CELL

7.1 Test Specification

FCC Part 22, FCC Part 2.1051

7.2 Test procedure

Enclosed are spectrum analyzer plots for the lowest operation frequency (874.0MHz) and the highest operation frequency (889MHz) in which the E.U.T. is planned to be used.

The power of any emission outside of the authorized operating frequency ranges (869 - 894 MHz) must be attenuated below the transmitting power (P) by a factor of at least $43 + \log(P)$ dB, yielding -13dBm .

The E.U.T. antenna terminal was connected to the spectrum analyzer through an external attenuator and an appropriate coaxial cable (30.5 dB).

The spectrum analyzer was set to 100 kHz R.B.W.



7.3 Test Results

Modulation	Operation Frequency (MHz)	Band Edge Frequency (MHz)	Reading (dBm)	Specification (dBm)	Margin (dB)
QPSK	874.00	869.00	-30.40	-13.0	-17.40
	889.00	894.00	-31.72	-13.0	-18.72
16QAM	874.00	869.00	-30.86	-13.0	-17.86
	889.00	894.00	-31.39	-13.0	-18.39
64QAM	874.00	869.00	-30.86	-13.0	-17.86
	889.00	894.00	-31.39	-13.0	-18.39

Figure 44 Band Edge Spectrum Test Results Table CELL

See additional information in Figure 45 to Figure 50.

JUDGEMENT: Passed by 17.86 dB

TEST PERSONNEL:

Tester Signature: 

Date: 03.08.14

Typed/Printed Name: A. Sharabi



QPSK:

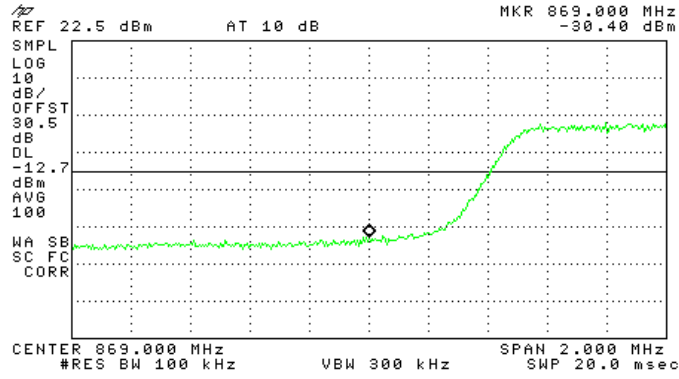

Figure 45 . 874MHz

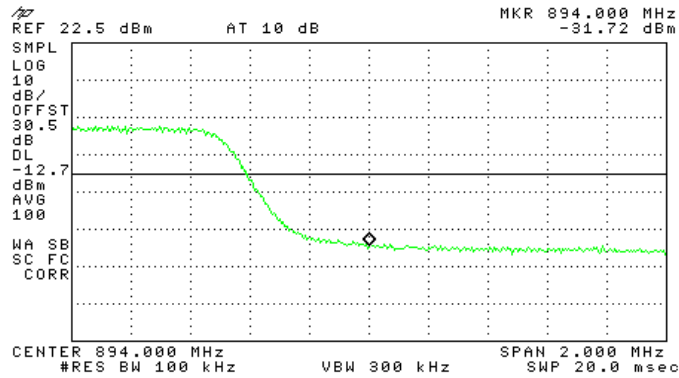

Figure 46 . 889MHz

16QAM:

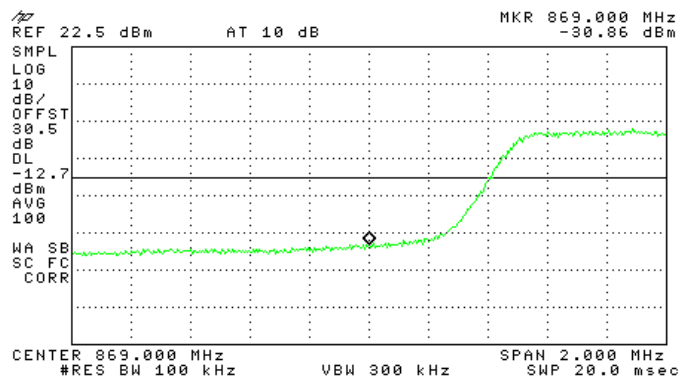

Figure 47 . 874MHz

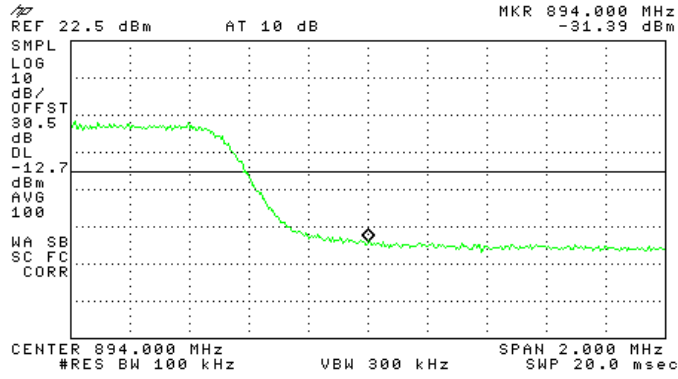

Figure 48 . 889MHz

64QAM:

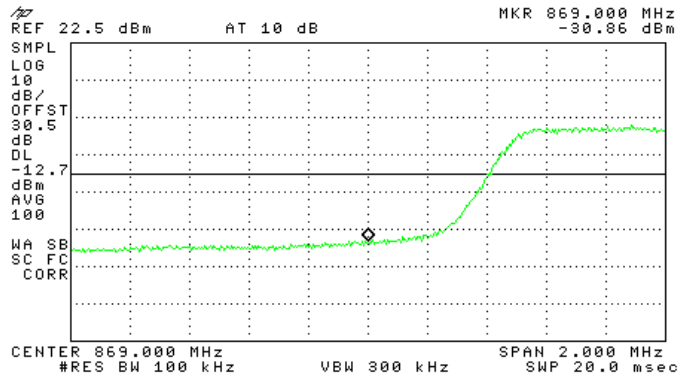

Figure 49 . 874MHz

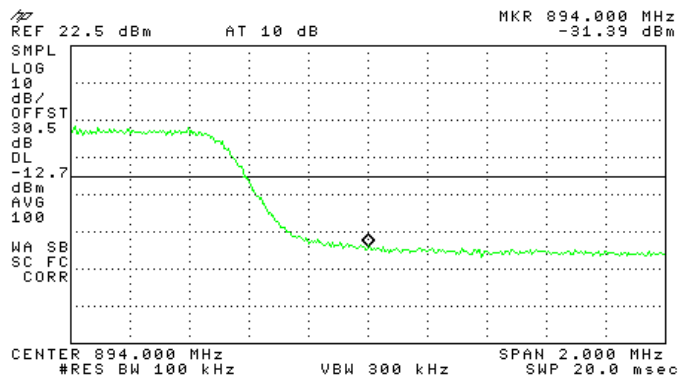

Figure 50 . 889MHz



7.4 Test Equipment Used, Band Edge Spectrum, CELL

Instrument	Manufacturer	Model	Serial Number	Calibration	
				Last Calibration	Period
Spectrum Analyzer	HP	8592L	3826A01204	February 28, 2014	1 year
Signal Generator	HP	N5182A	MY48180244	July 28, 2013	1 year
Attenuator	MCE	46-30-34	-	May 25, 2014	1 year
Cable	Rhophase	KPS-5000-KPS	A1674	May 25, 2014	1 year

Figure 51 Test Equipment Used



8. Peak Output Power PCS

8.1 Test Specification

FCC Part 24, Subpart E

8.2 Test procedure

Peak Power Output must not exceed 100 Watts (50dBm).

The E.U.T. antenna terminal was connected to the Spectrum Analyzer through an external attenuator (30 dB) and an appropriate coaxial cable (0.5dB). The E.U.T. RF output was LTE modulated. Special attention was taken to prevent Spectrum Analyzer RF input overload.

8.3 Test Results

Modulation	Operation Frequency (MHz)	Reading (dBm)	Specification (dBm)	Margin (dB)
QPSK	1935	27.70	50.0	-22.30
	1960	28.92	50.0	-23.92
	1985	28.37	50.0	-21.63
16QAM	1935	27.95	50.0	-22.05
	1960	28.98	50.0	-21.02
	1985	28.38	50.0	-21.62
64QAM	1935	28.04	50.0	-21.60
	1960	29.01	50.0	-20.99
	1985	28.42	50.0	-21.58

Figure 52 Peak Output Power Test Results Table, PCS

See additional information in Figure 53 to Figure 61.

JUDGEMENT: Passed by 20.99dB

TEST PERSONNEL:

Tester Signature: 

Date: 03.08.14

Typed/Printed Name: A. Sharabi



QPSK:

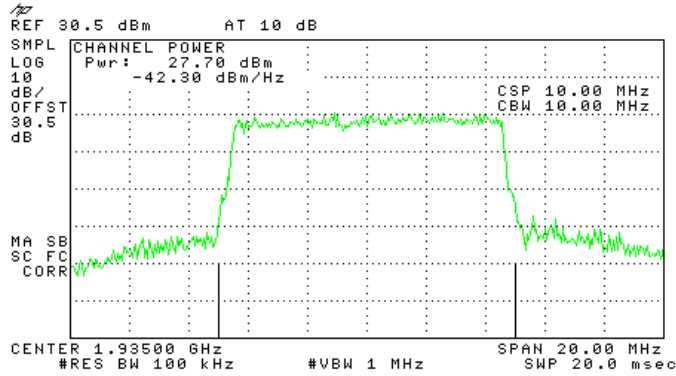

Figure 53.— 1935 MHz

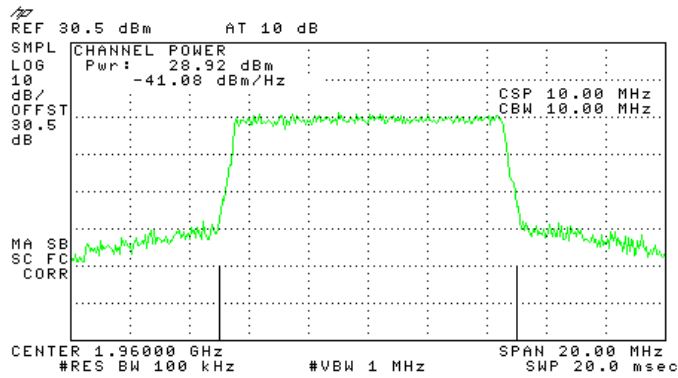

Figure 54.— 1960 MHz

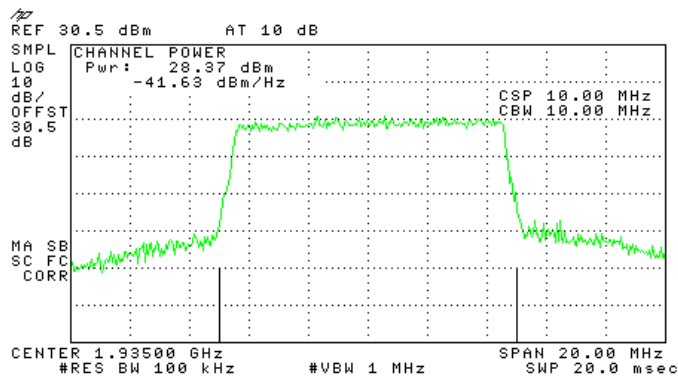

Figure 55.— 1985 MHz



16QAM:

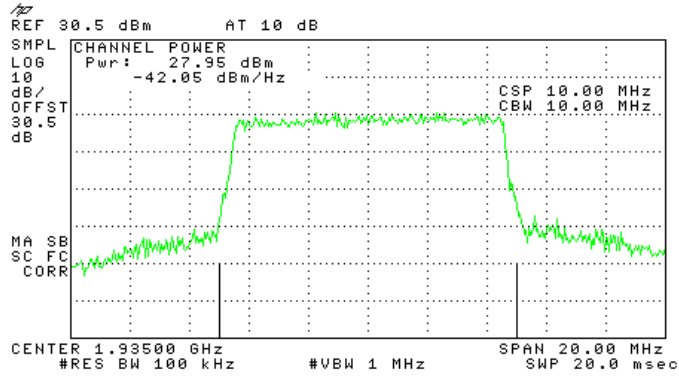

Figure 56.— 1935 MHz

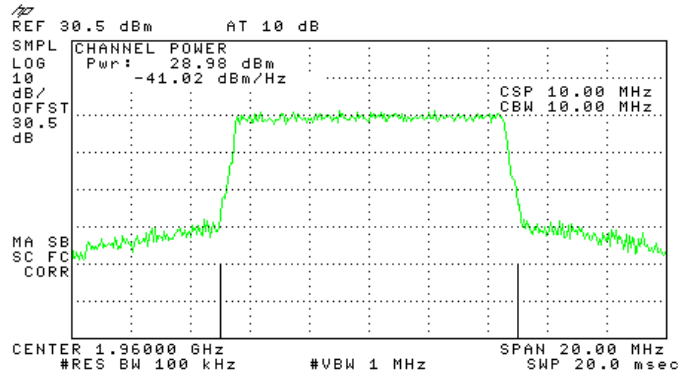

Figure 57.— 1960 MHz

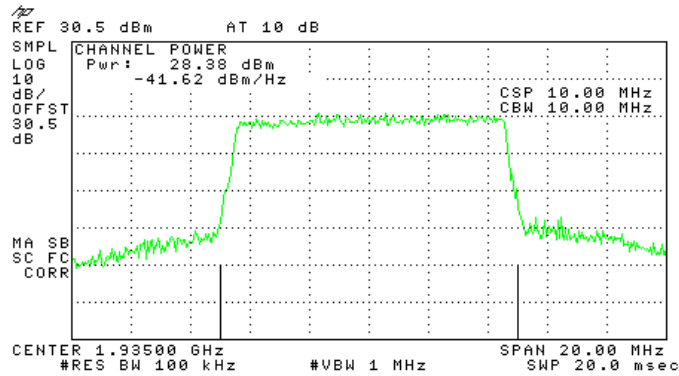

Figure 58.— 1985 MHz



64QAM:

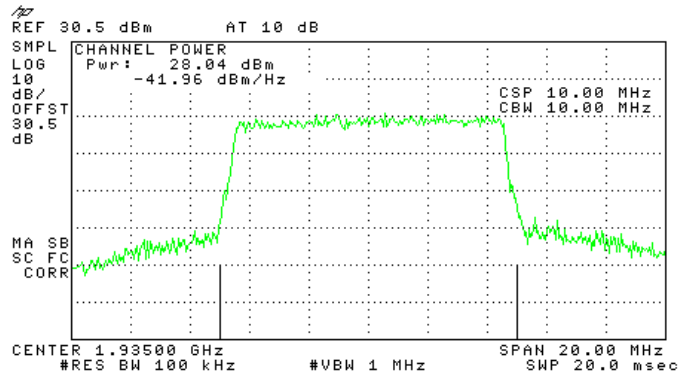

Figure 59.— 1935 MHz

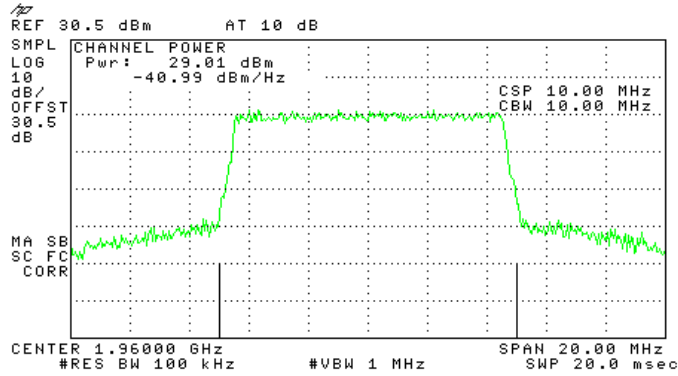

Figure 60.— 1960 MHz

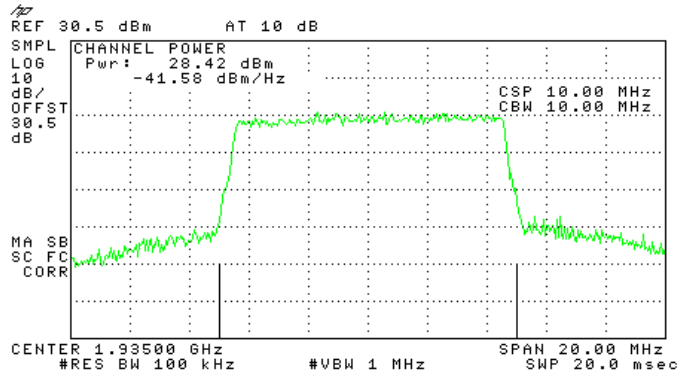

Figure 61.— 1985 MHz



8.4 Test Equipment Used, Peak Output Power, PCS

Instrument	Manufacturer	Model	Serial Number	Calibration	
				Last Calibration	Period
Spectrum Analyzer	HP	8592L	3826A01204	February 28, 2014	1 year
Signal Generator	HP	N5182A	MY48180244	July 28, 2013	1 year
Attenuator	MCE	46-30-34	-	May 25, 2014	1 year
Cable	Rhophase	KPS-5000-KPS	A1674	May 25, 2014	1 year

Figure 62 Test Equipment Used



9. Occupied Bandwidth PCS

9.1 *Test Specification*

FCC Part 2, Section 1049

9.2 *Test Procedure*

The E.U.T. was set to the applicable test frequency with LTE modulation. The E.U.T. antenna terminal was connected to the spectrum analyzer through an external attenuator (at the output test) and an appropriate coaxial cable. The spectrum analyzer was set to 100 kHz resolution B.W.

The occupied bandwidth, that is the frequency bandwidth such that, below its lower and above its upper frequency limit, the mean powers radiated are each equal to 0.5% of the total mean power radiated by a given emission.

The occupied bandwidth of the E.U.T. at the points of 20 dB below maximum peak power was measured and recorded.

Occupied bandwidth measured was repeated in the input terminal of the E.U.T.



9.3 Results Table

Modulation		Operating Frequency (MHz)	Reading (MHz)
QPSK	Input	1935	9.50
	Input	1960	9.75
	Input	1985	9.55
16QAM	Input	1935	9.50
	Input	1960	9.60
	Input	1985	9.60
64QAM	Input	1935	9.70
	Input	1960	9.60
	Input	1985	9.70
QPSK	Output	1935	9.70
	Output	1960	9.55
	Output	1985	9.60
16QAM	Output	1935	9.70
	Output	1960	9.60
	Output	1985	9.60
64QAM	Output	1935	9.70
	Output	1960	9.60
	Output	1985	9.70

Figure 63 Occupied Bandwidth Test Results Table PCS

See additional information in Figure 64 to Figure 81.

TEST PERSONNEL:

Tester Signature: 

Date: 03.08.14

Typed/Printed Name: A. Sharabi



INPUT QPSK:

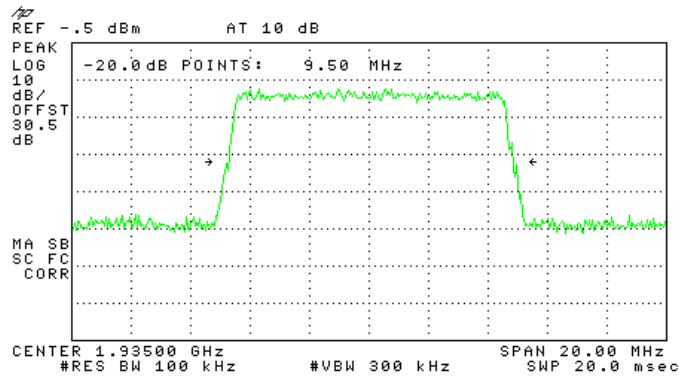

Figure 64.— 1935 MHz

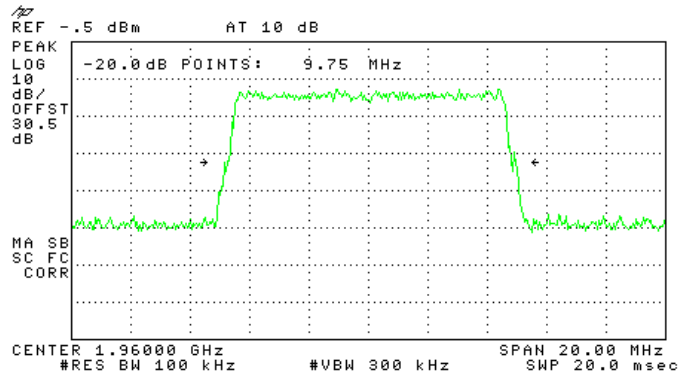

Figure 65.— 1960 MHz

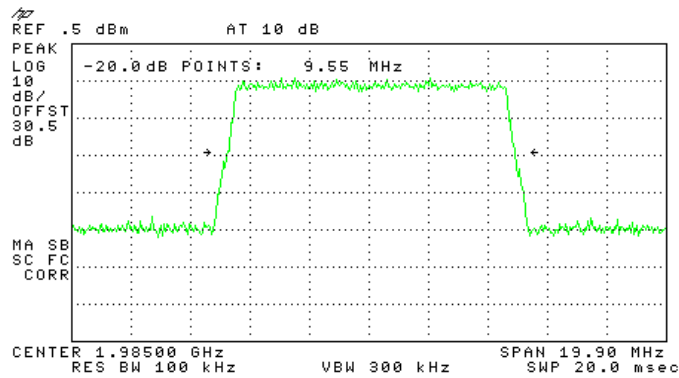

Figure 66.— 1985 MHz



INPUT 16QAM:

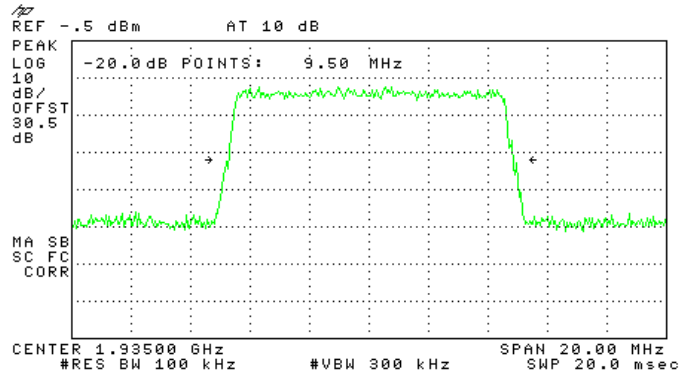

Figure 67.— 1935 MHz

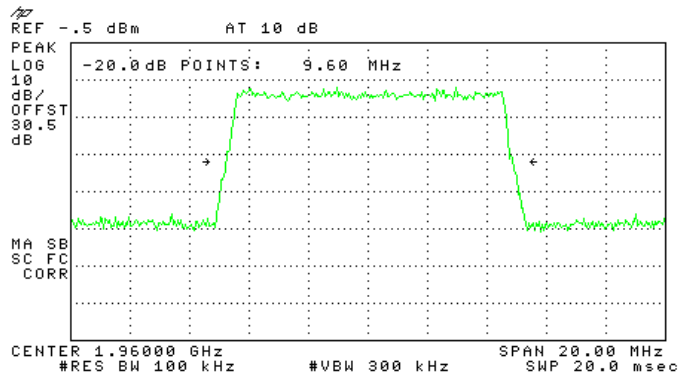

Figure 68.— 1960 MHz

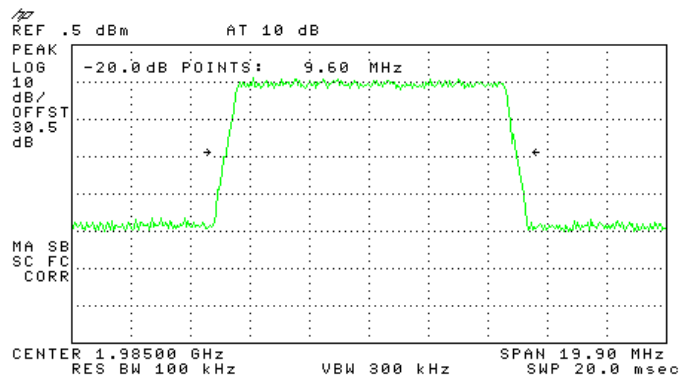

Figure 69.— 1985 MHz



INPUT 64QAM:

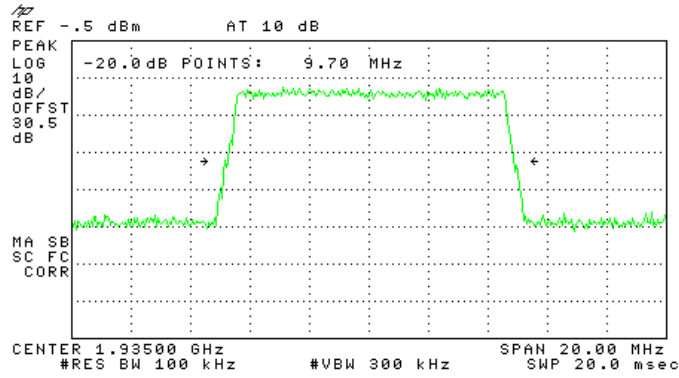

Figure 70.— 1935 MHz

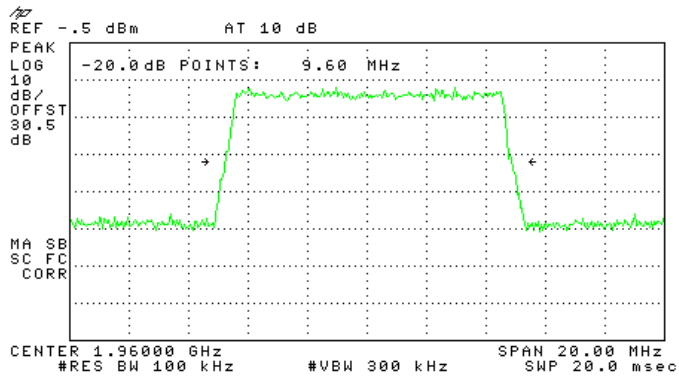

Figure 71.— 1960 MHz

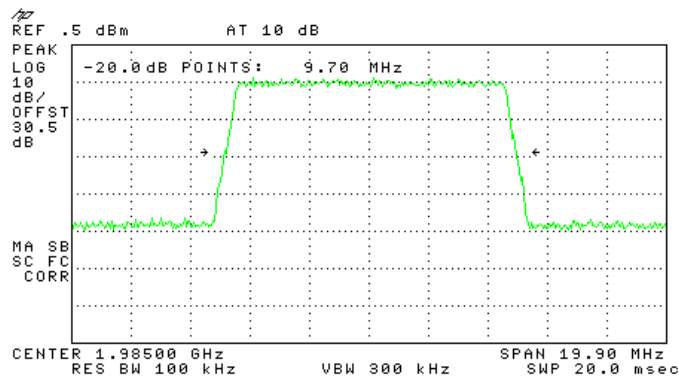

Figure 72.— 1985 MHz



OUTPUT QPSK:

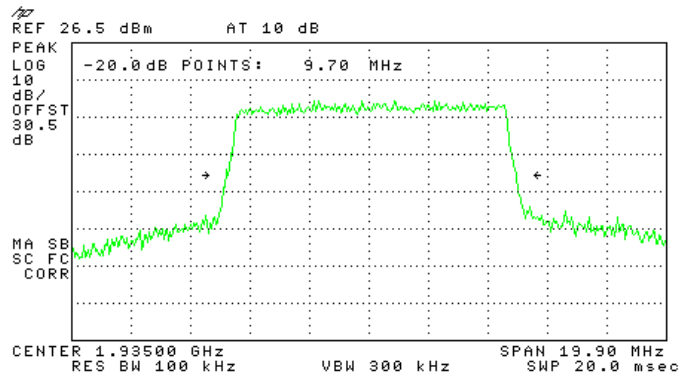

Figure 73.— 1935 MHz

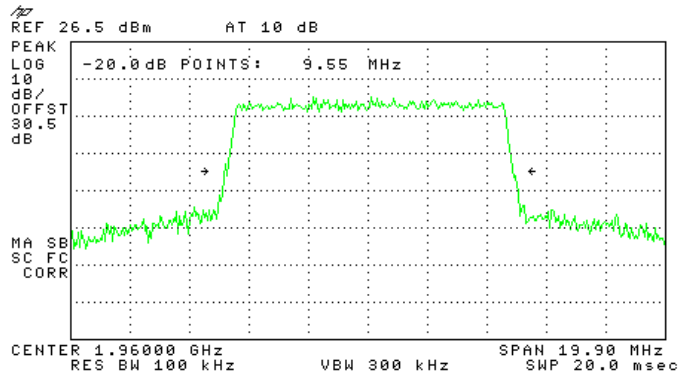

Figure 74.— 1960 MHz

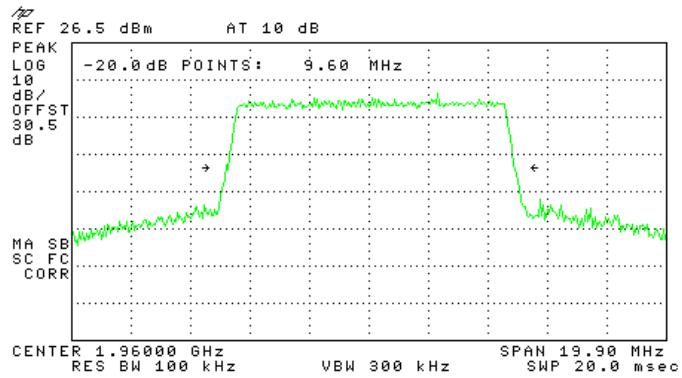

Figure 75.— 1985 MHz



OUTPUT 16QAM:

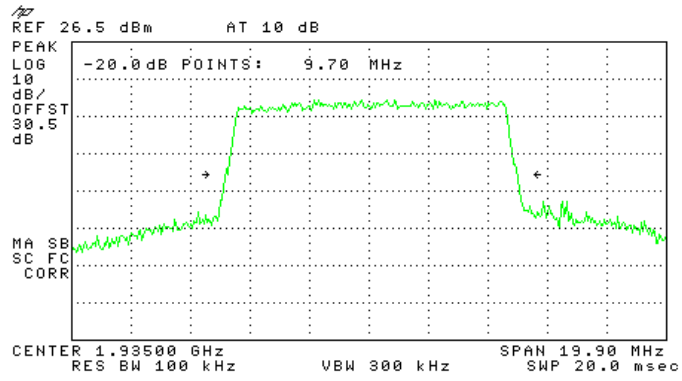

Figure 76.— 1935 MHz

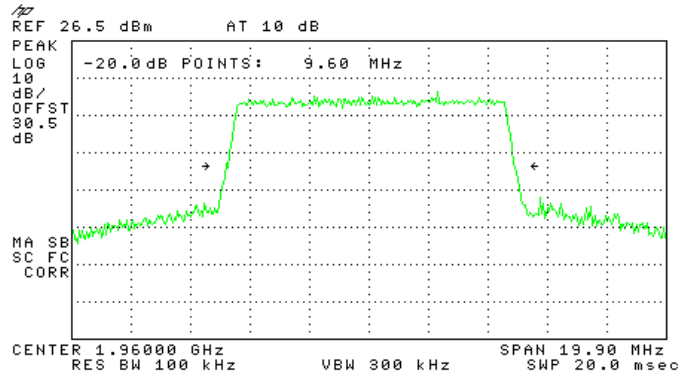

Figure 77.— 1960 MHz

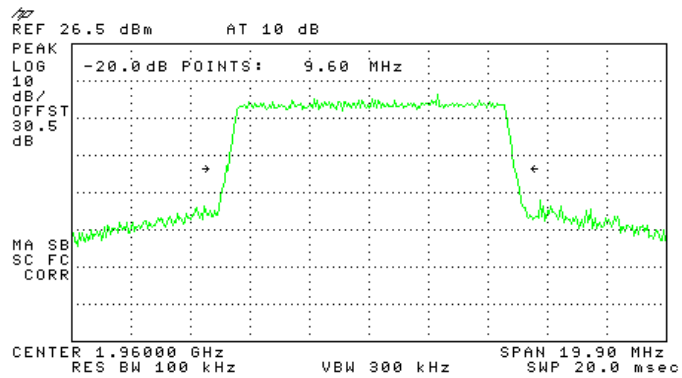

Figure 78.— 1985 MHz



OUTPUT 64QAM:

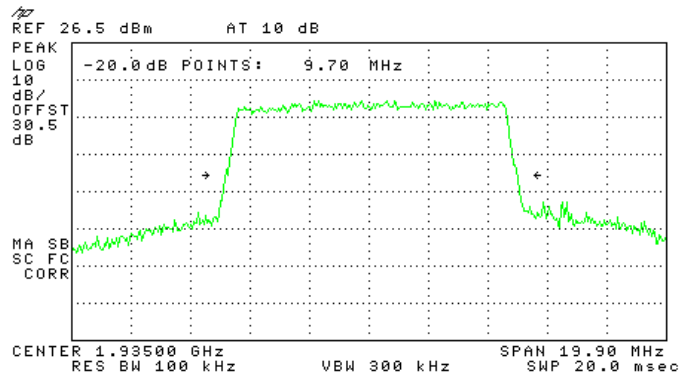

Figure 79.— 1935 MHz

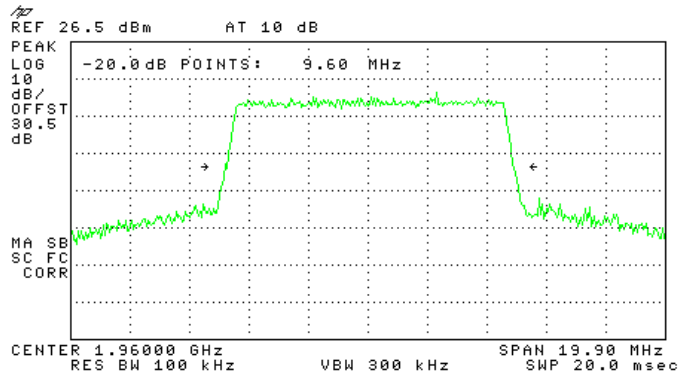

Figure 80.— 1960 MHz

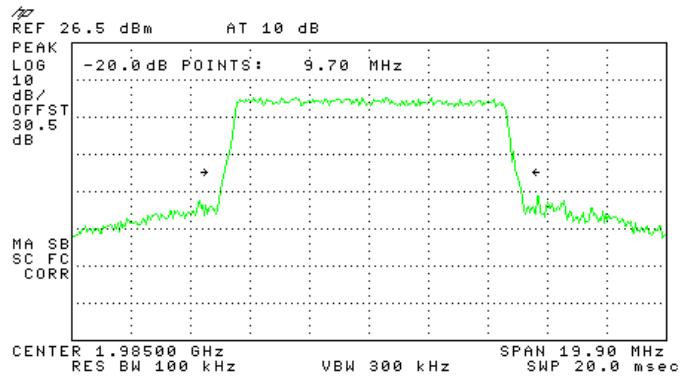

Figure 81.— 1985 MHz



9.4 Test Equipment Used, Occupied Bandwidth, PCS

Instrument	Manufacturer	Model	Serial Number	Calibration	
				Last Calibration	Period
Spectrum Analyzer	HP	8592L	3826A01204	February 28, 2014	1 year
Signal Generator	HP	N5182A	MY48180244	July 28, 2013	1 year
Attenuator	MCE	46-30-34	-	May 25, 2014	1 year
Cable	Rhophase	KPS-5000-KPS	A1674	May 25, 2014	1 year

Figure 82 Test Equipment Used



10. Out of Band Emissions at Antenna Terminals PCS

10.1 Test Specification

FCC Part 24, Subpart E, Section 238; FCC Part 2.1051

10.2 Test procedure

The power of any emission outside of the authorized operating frequency ranges (1930-1990 MHz) must be attenuated below the transmitting power (P) by a factor of at least $43 + \log(P)$ dB, yielding -13dBm .

The E.U.T. antenna terminal was connected to the spectrum analyzer through an external attenuator and an appropriate coaxial cable (30.5 dB).

Signal power was +1 dBm to EUT.

10.3 Test Results

See plots in Figure 83 to Figure 91.

JUDGEMENT: Passed

TEST PERSONNEL:

Tester Signature:  _____

Date: 03.08.14

Typed/Printed Name: A. Sharabi



QPSK:

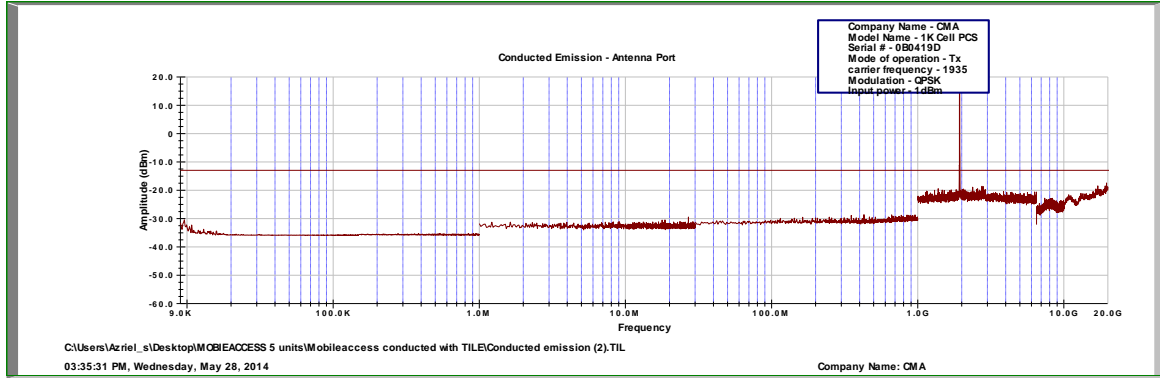

Figure 83.— 1935 MHz

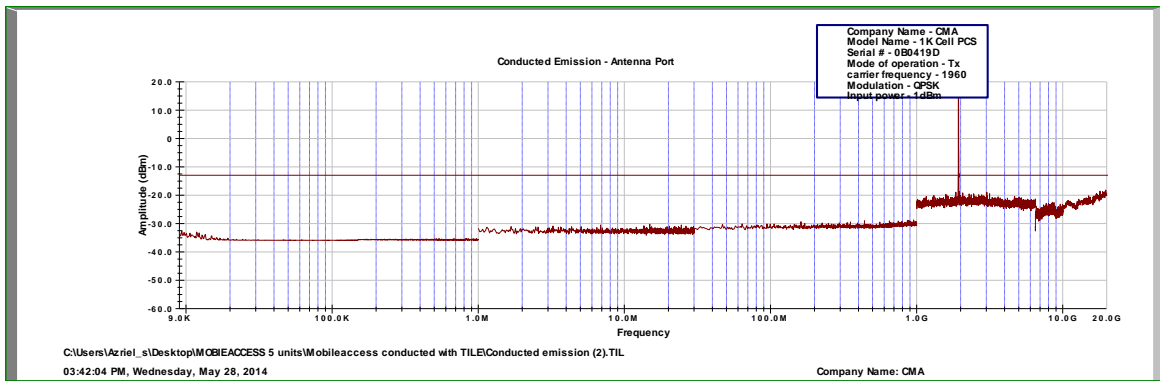

Figure 84.— 1960 MHz

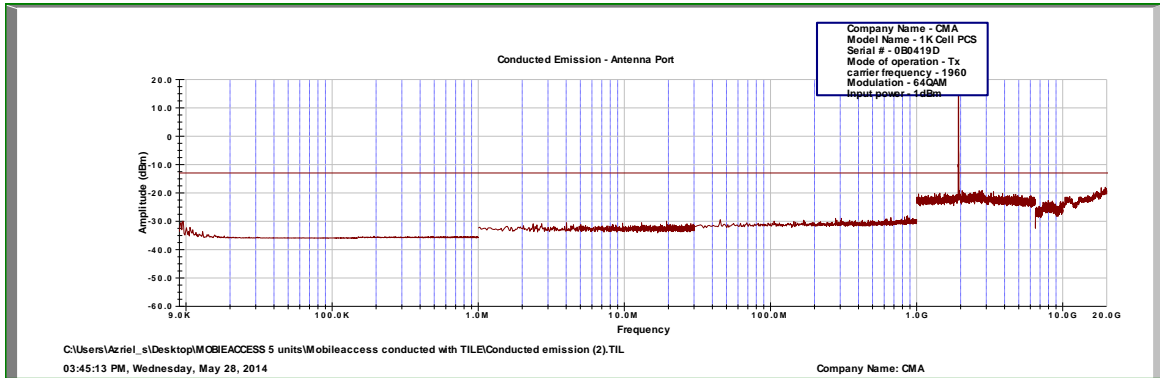

Figure 85.— 1985 MHz



16QAM:

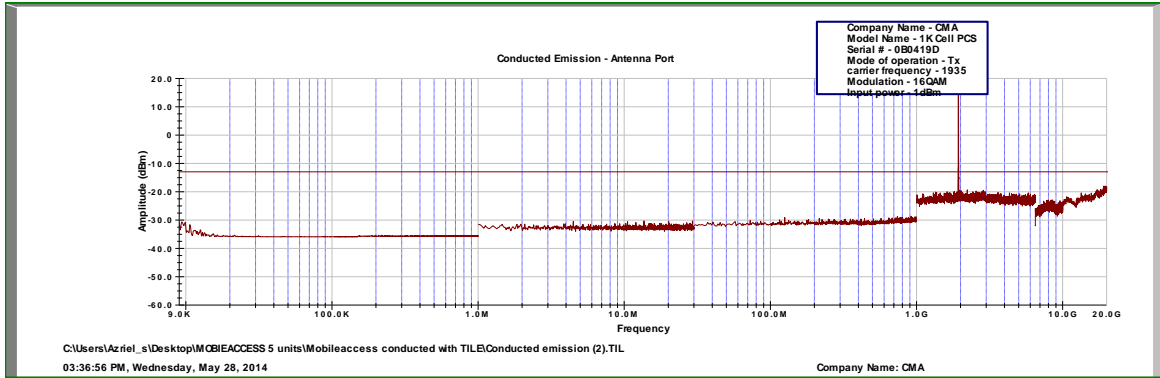

Figure 86.— 1935 MHz

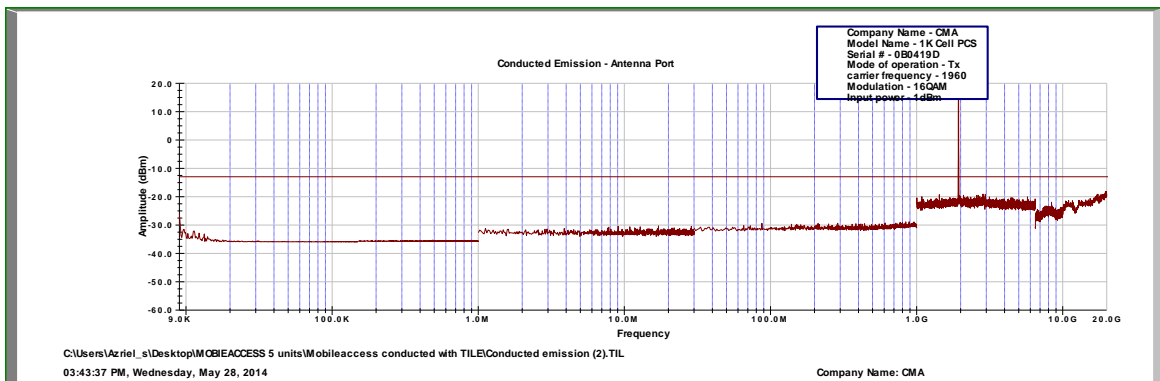

Figure 87.— 1960 MHz

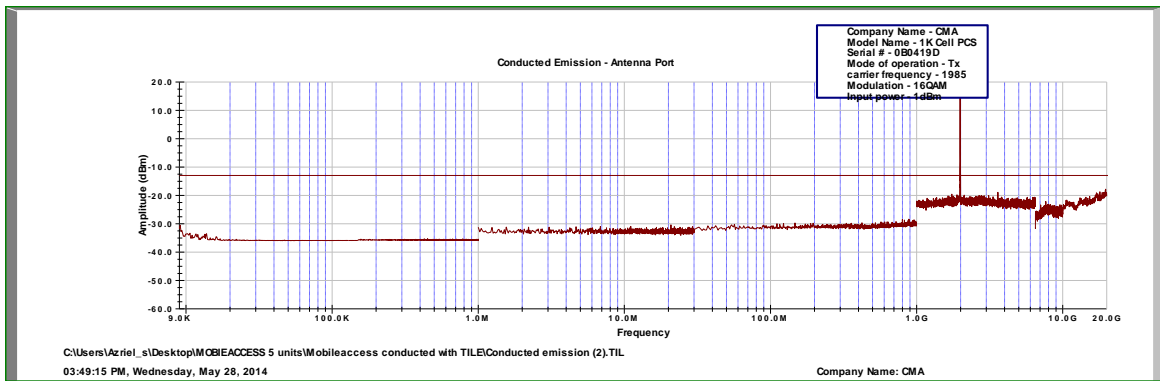

Figure 88.— 1985 MHz



64QAM:

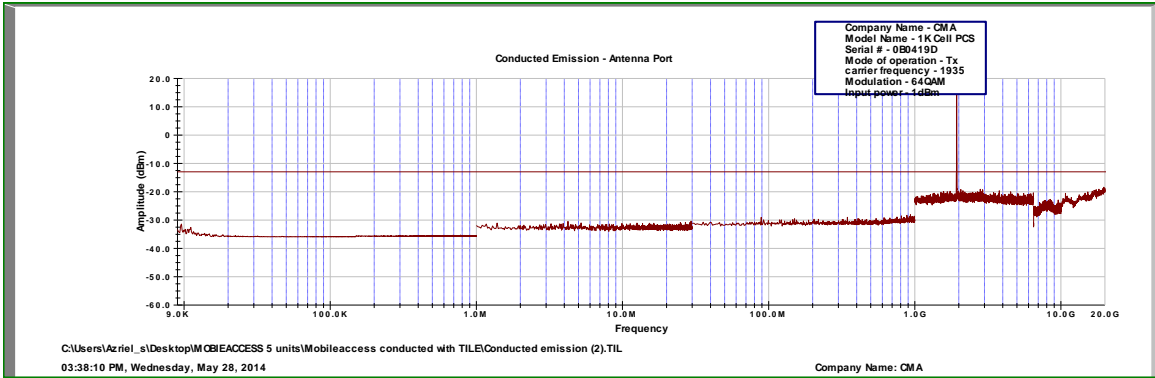

Figure 89.— 1985 MHz

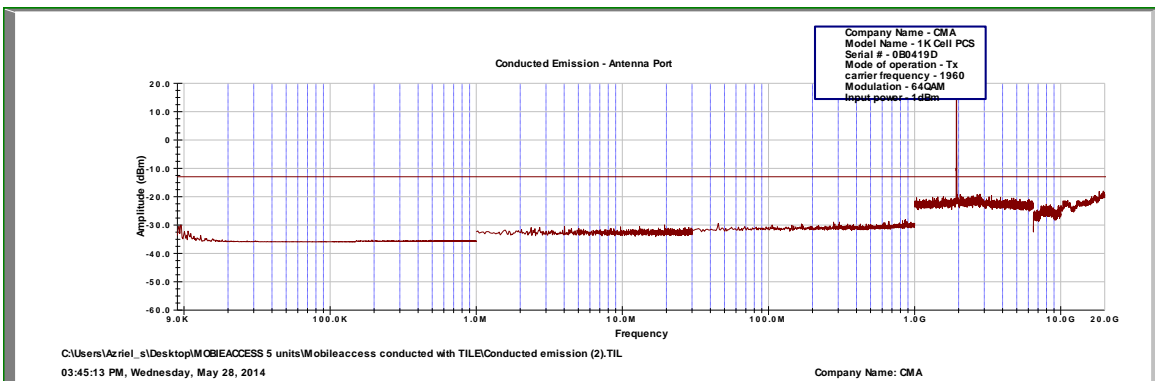

Figure 90.— 1960 MHz

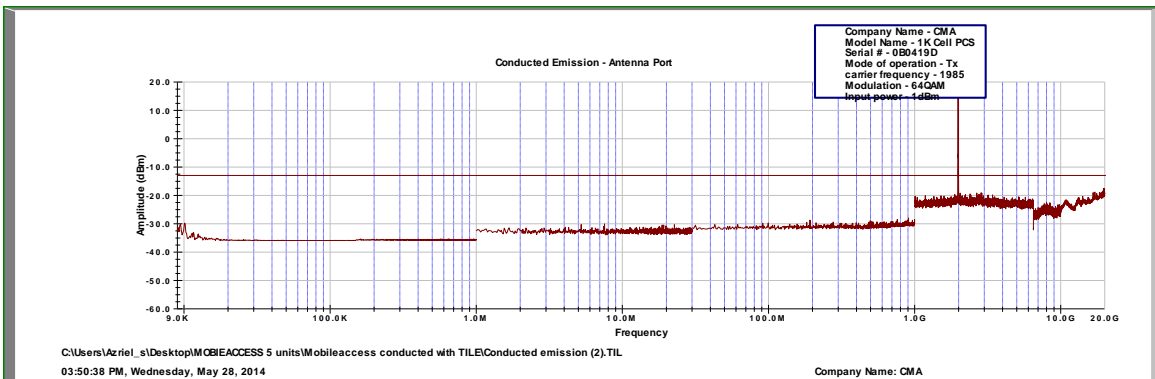

Figure 91.— 1985 MHz



10.4 Test Equipment Used, Out of Band Emissions at Antenna Terminals, PCS

Instrument	Manufacturer	Model	Serial Number	Calibration	
				Last Calibration	Period
Spectrum Analyzer	HP	8592L	3826A01204	February 28, 2014	1 year
Signal Generator	HP	N5182A	MY48180244	July 28, 2013	1 year
Attenuator	MCE	46-30-34	-	May 25, 2014	1 year
Cable	Rhophase	KPS-5000-KPS	A1674	May 25, 2014	1 year

Figure 92 Test Equipment Used



11. Band Edge Spectrum PCS

11.1 Test Specification

FCC Part 24, Subpart E, Section 238; FCC Part 2.1051

11.2 Test procedure

Enclosed are spectrum analyzer plots for the lowest operation frequency (1935 MHz) and the highest operation frequency (1985MHz) in which the E.U.T. is planned to be used.

The power of any emission outside of the authorized operating frequency ranges (1930.00-1990.00 MHz) must be attenuated below the transmitting power (P) by a factor of at least $43 + \log(P)$ dB, yielding -13dBm.

The E.U.T. antenna terminal was connected to the spectrum analyzer through an external attenuator and an appropriate coaxial cable (30.5 dB).

The spectrum analyzer was set to 100 kHz R.B.W.

11.3 Test Results

Modulation	Operation Frequency (MHz)	Band Edge Frequency (MHz)	Reading (dBm)	Specification (dBm)	Margin (dB)
QPSK	1935	1930	-36.37	-13.0	-23.37
	1985	1990	-34.58	-13.0	-21.58
16QAM	1935	1930	-36.40	-13.0	-23.40
	1985	1990	-34.51	-13.0	-21.51
64QAM	1935	1930	-36.40	-13.0	-23.40
	1985	1990	-34.51	-13.0	-21.51

Figure 93 Band Edge Spectrum Test Results Table PCS

See additional information in Figure 94 to Figure 99.

JUDGEMENT: Passed by 21.51 dB

TEST PERSONNEL:

Tester Signature: 
Typed/Printed Name: A. Sharabi

Date: 03.08.14



QPSK:

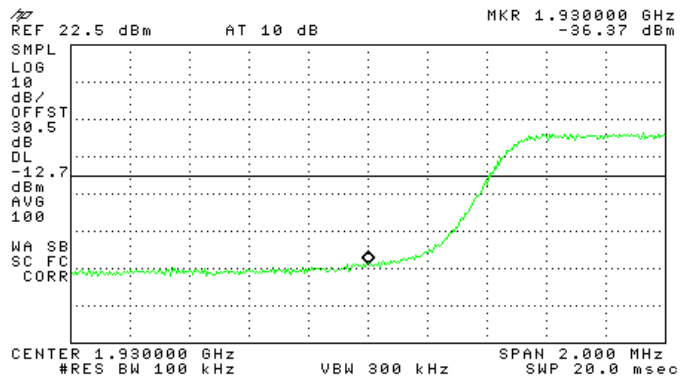

Figure 94.— 1935 MHz

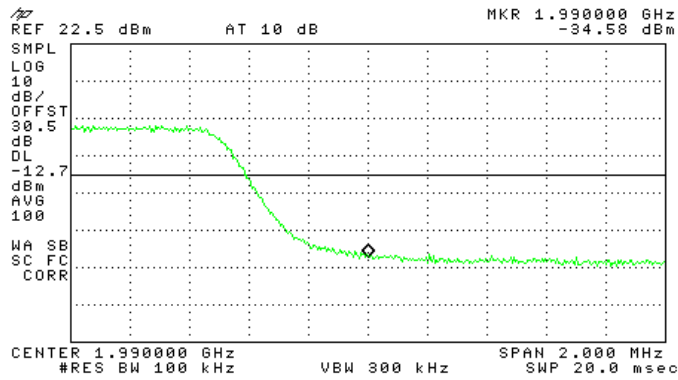

Figure 95.— 1985 MHz

16QAM:

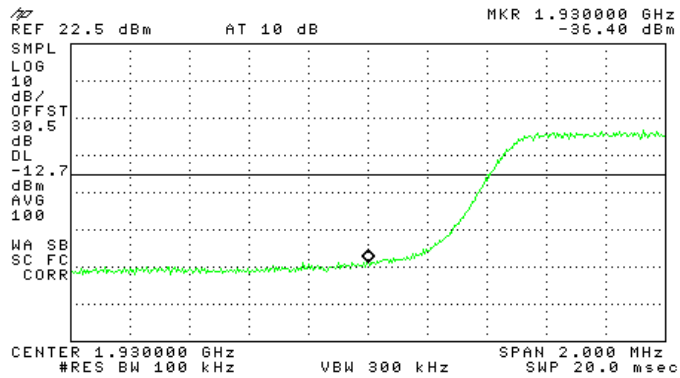

Figure 96.— 1935 MHz

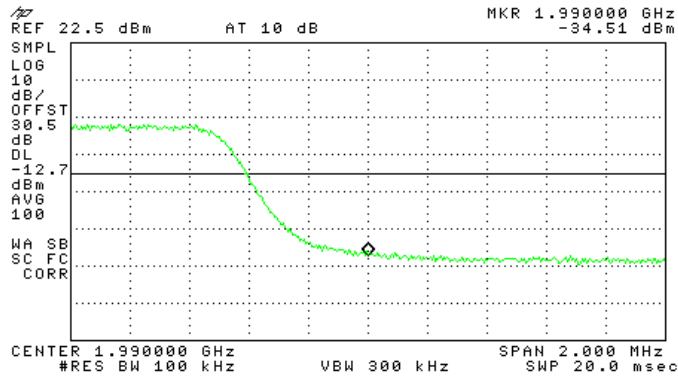

Figure 97.— 1985 MHz

64QAM:

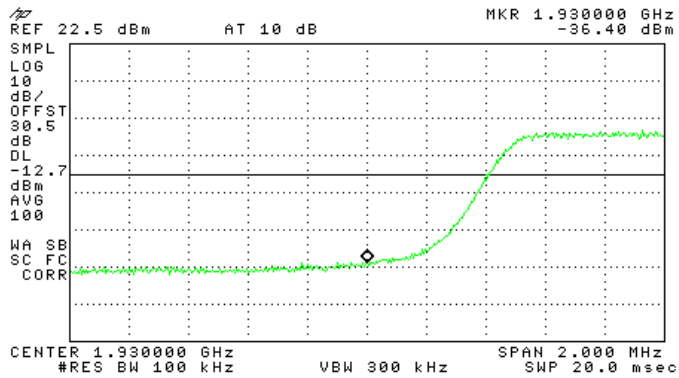

Figure 98.— 1935 MHz

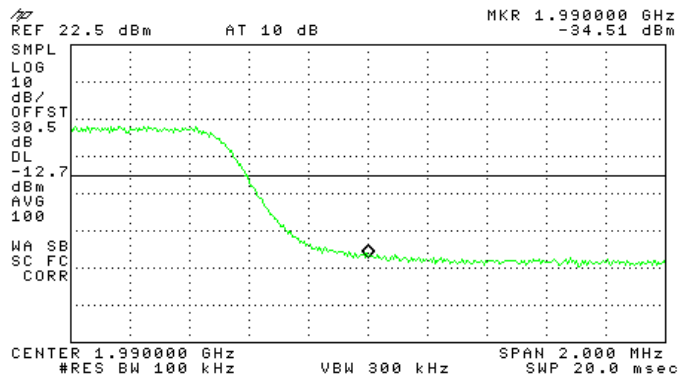

Figure 99.— 1985 MHz



11.4 Test Equipment Used, Band Edge Spectrum, PCS

Instrument	Manufacturer	Model	Serial Number	Calibration	
				Last Calibration	Period
Spectrum Analyzer	HP	8592L	3826A01204	February 28, 2014	1 year
Signal Generator	HP	N5182A	MY48180244	July 28, 2013	1 year
Attenuator	MCE	46-30-34	-	May 25, 2014	1 year
Cable	Rhophase	KPS-5000-KPS	A1674	May 25, 2014	1 year

Figure 100 Test Equipment Used



13. APPENDIX A - CORRECTION FACTORS

13.1 Correction factors for CABLE

from EMI receiver
to test antenna
at 3 meter range.

FREQUENCY (MHz)	CORRECTION FACTOR (dB)	FREQUENCY (MHz)	CORRECTION FACTOR (dB)
10.0	0.3	1200.0	7.3
20.0	0.6	1400.0	7.8
30.0	0.8	1600.0	8.4
40.0	0.9	1800.0	9.1
50.0	1.1	2000.0	9.9
60.0	1.2	2300.0	11.2
70.0	1.3	2600.0	12.2
80.0	1.4	2900.0	13.0
90.0	1.6		
100.0	1.7		
150.0	2.0		
200.0	2.3		
250.0	2.7		
300.0	3.1		
350.0	3.4		
400.0	3.7		
450.0	4.0		
500.0	4.3		
600.0	4.7		
700.0	5.3		
800.0	5.9		
900.0	6.3		
1000.0	6.7		

NOTES:

1. The cable type is RG-214.
2. The overall length of the cable is 27 meters.
3. The above data is located in file 27MO3MO.CBL on the disk marked "Radiated Emission Tests EMI Receiver".



13.2 Correction factors for

CABLE

**from EMI receiver
to test antenna
at 3 meter range.**

FREQUENCY (GHz)	CORRECTION FACTOR (dB)
1.0	1.2
2.0	1.6
3.0	2.0
4.0	2.4
5.0	3.0
6.0	3.4
7.0	3.8
8.0	4.2
9.0	4.6
10.0	5.0
12.0	5.8

NOTES:

- 1. The cable type is RG-8.*
- 2. The overall length of the cable is 10 meters.*



13.3 Correction factors for CABLE
from spectrum analyzer
to test antenna above 2.9 GHz

FREQUENCY (GHz)	CORRECTION FACTOR (dB)	FREQUENCY (GHz)	CORRECTION FACTOR (dB)
1.0	1.9	14.0	9.1
2.0	2.7	15.0	9.5
3.0	3.5	16.0	9.9
4.0	4.2	17.0	10.2
5.0	4.9	18.0	10.4
6.0	5.5	19.0	10.7
7.0	6.0	20.0	10.9
8.0	6.5	21.0	11.2
9.0	7.0	22.0	11.6
10.0	7.5	23.0	11.9
11.0	7.9	24.0	12.3
12.0	8.3	25.0	12.6
13.0	8.7	26.0	13.0

NOTES:

- 1. The cable type is SUCOFLEX 104 E manufactured by SUHNER.*
- 2. The cable is used for measurements above 2.9 GHz.*
- 3. The overall length of the cable is 10 meters.*



13.4 Correction factors for LOG PERIODIC ANTENNA

**Type LPD 2010/A
at 3 and 10 meter ranges.**

Distance of 3 meters

FREQUENCY (MHz)	AFE (dB/m)
200.0	9.1
250.0	10.2
300.0	12.5
400.0	15.4
500.0	16.1
600.0	19.2
700.0	19.4
800.0	19.9
900.0	21.2
1000.0	23.5

Distance of 10 meters

FREQUENCY (MHz)	AFE (dB/m)
200.0	9.0
250.0	10.1
300.0	11.8
400.0	15.3
500.0	15.6
600.0	18.7
700.0	19.1
800.0	20.2
900.0	21.1
1000.0	23.2

NOTES:

1. Antenna serial number is 1038.
2. The above lists are located in file number 38M30.ANT for a 3 meter range, and file number 38M100.ANT for a 10 meter range.
3. The files mentioned above are located on the disk marked "Radiated Emission Test EMI Receiver".



13.5 Correction factors for LOG PERIODIC ANTENNA

**Type SAS-200/511
at 3 meter range.**

FREQUENCY (GHz)	ANTENNA FACTOR (dB)
1.0	24.9
1.5	27.8
2.0	29.9
2.5	31.2
3.0	32.8
3.5	33.6
4.0	34.3
4.5	35.2
5.0	36.2
5.5	36.7
6.0	37.2
6.5	38.1

FREQUENCY (GHz)	ANTENNA FACTOR (dB)
7.0	38.6
7.5	39.2
8.0	39.9
8.5	40.4
9.0	40.8
9.5	41.1
10.0	41.7
10.5	42.4
11.0	42.5
11.5	43.1
12.0	43.4
12.5	44.4
13.0	44.6

NOTES:

- 1. Antenna serial number is 253.*
- 2. The above lists are located in file number SAS3M0.ANT for a 3 meter range.*
- 3. The files mentioned above are located on the disk marked "Antenna Factors".*



**13.6 Correction factors for BICONICAL ANTENNA
Type BCD-235/B,
at 3 meter range**

FREQUENCY (MHz)	APE (dB/m)
20.0	19.4
30.0	14.8
40.0	11.9
50.0	10.2
60.0	9.1
70.0	8.5
80.0	8.9
90.0	9.6
100.0	10.3
110.0	11.0
120.0	11.5
130.0	11.7
140.0	12.1
150.0	12.6
160.0	12.8
170.0	13.0
180.0	13.5
190.0	14.0
200.0	14.8
210.0	15.3
220.0	15.8
230.0	16.2
240.0	16.6
250.0	17.6
260.0	18.2
270.0	18.4
280.0	18.7
290.0	19.2
300.0	19.9
310	20.7
320	21.9
330	23.4
340	25.1
350	27.0

NOTES:

- 1. Antenna serial number is 1041.*
- 2. The above list is located in file 19BC10M1.ANT on the disk marked "Radiated Emissions Tests EMI Receiver".*



13.7 Correction factors for Double-Ridged Waveguide Horn

**Model: 3115, S/N 29845
at 3 meter range.**

FREQUENCY (GHz)	ANTENNA FACTOR (dB 1/m)	ANTENNA Gain (dBi)	FREQUENCY (GHz)	ANTENNA FACTOR (dB 1/m)	ANTENNA Gain (dBi)
1.0	24.8	5.4	10.0	38.8	11.4
1.5	26.1	7.6	10.5	38.9	11.8
2.0	28.6	7.7	11.0	39.0	12.1
2.5	29.8	8.4	11.5	39.6	11.8
3.0	31.4	8.4	12.0	39.8	12.0
3.5	32.4	8.7	12.5	39.6	12.5
4.0	33.7	8.6	13.0	40.0	12.5
4.5	33.4	9.9	13.5	39.8	13.0
5.0	34.5	9.7	14.0	40.2	13.0
5.5	35.1	9.9	14.5	40.6	12.9
6.0	35.4	10.4	15.0	41.3	12.4
6.5	35.6	10.8	15.5	39.5	14.6
7.0	36.2	10.9	16.0	38.8	15.5
7.5	37.3	10.4	16.5	40.0	14.6
8.0	37.7	10.6	17.0	41.4	13.4
8.5	38.3	10.5	17.5	44.8	10.3
9.0	38.5	10.8	18.0	47.2	8.1
9.5	38.7	11.1			



13.8 Correction factors for ACTIVE LOOP ANTENNA
Model 6502
S/N 9506-2950

FREQUENCY (MHz)	Magnetic Antenna Factor (dB)	Electric Antenna Factor (dB)
.009	-35.1	16.4
.010	-35.7	15.8
.020	-38.5	13.0
.050	-39.6	11.9
.075	-39.8	11.8
.100	-40.0	11.6
.150	-40.0	11.5
.250	-40.0	11.6
.500	-40.0	11.5
.750	-40.1	11.5
1.000	-39.9	11.7
2.000	-39.5	12.0
3.000	-39.4	12.1
4.000	-39.7	11.9
5.000	-39.7	11.8
10.000	40.2	11.3
15.000	-40.7	10.8
20.000	-40.5	11.0
25.000	-41.3	10.2
30.000	42.3	9.2