

EUT SETUP PHOTOS of Radiated Emission 15.109

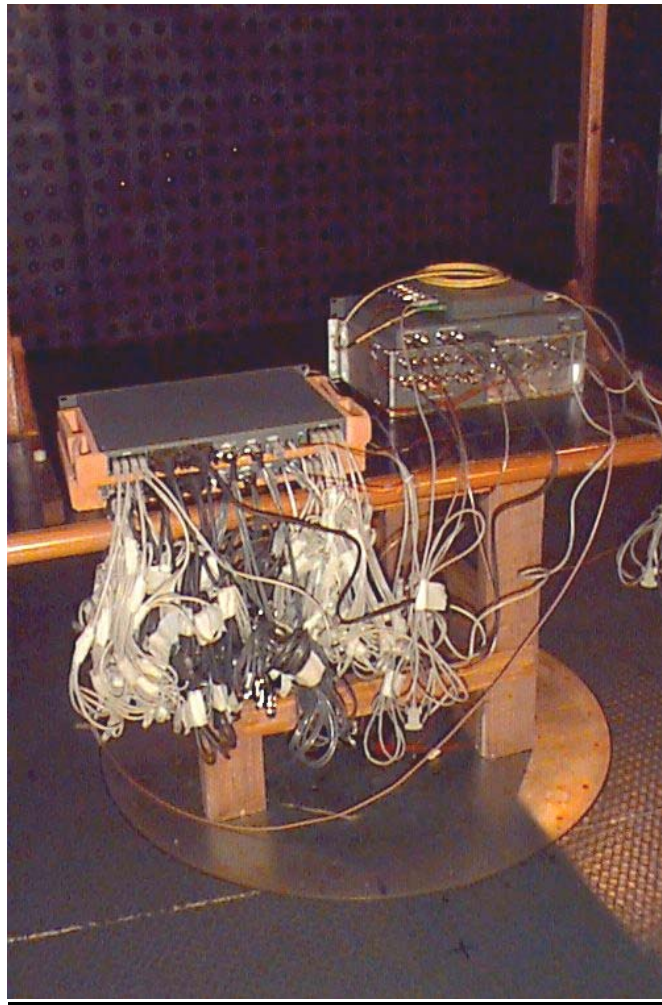

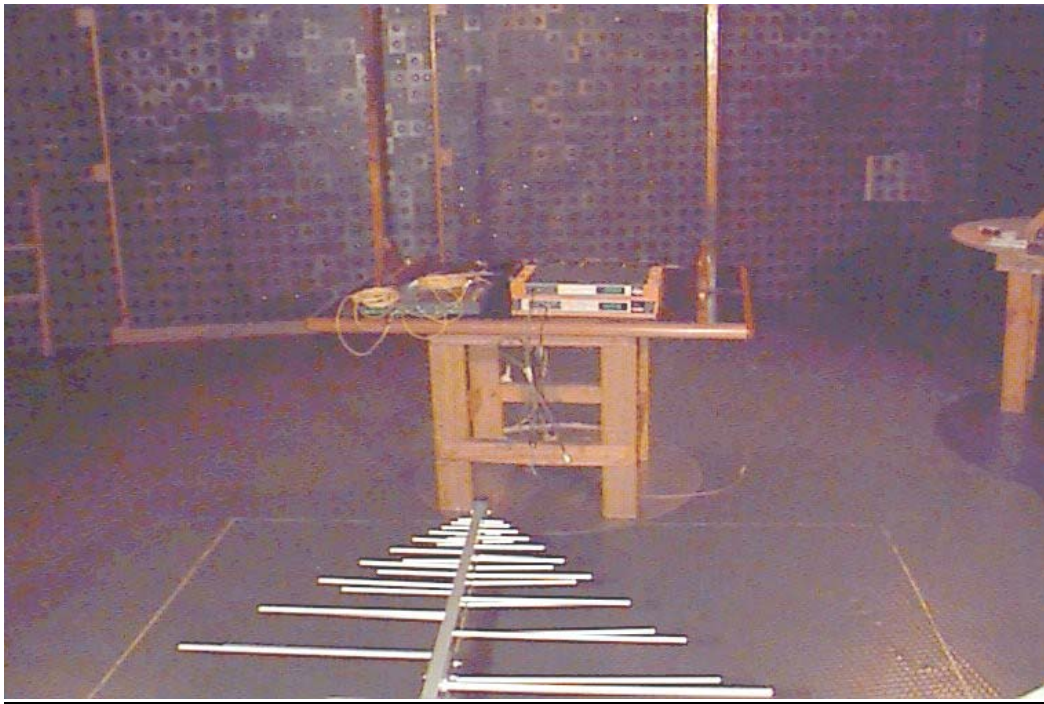

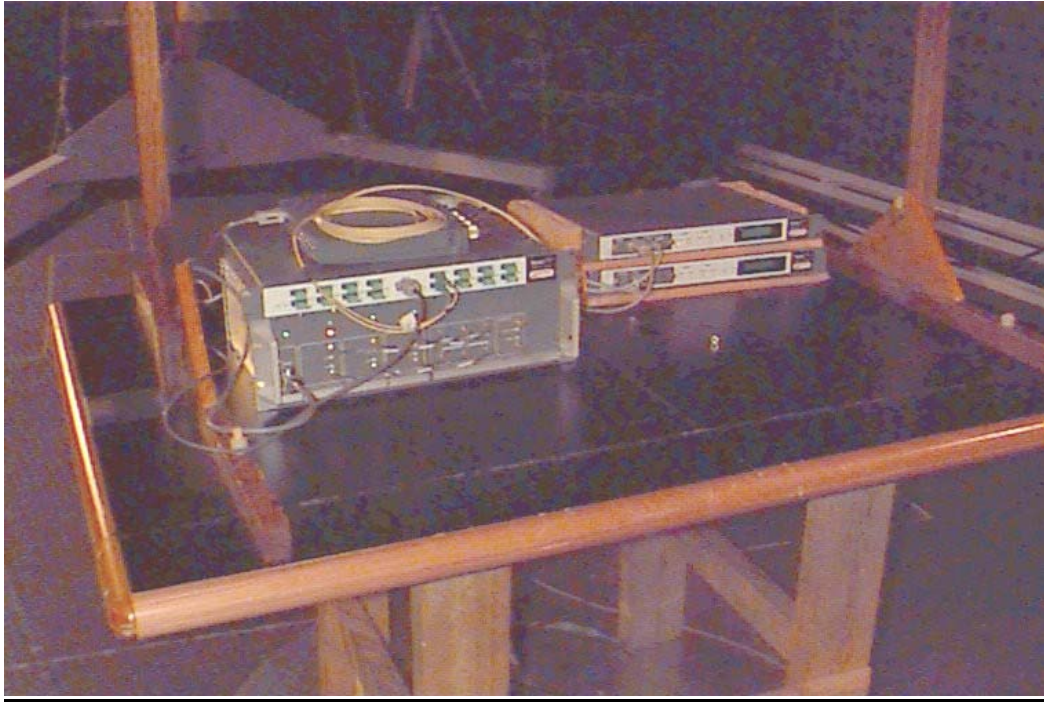

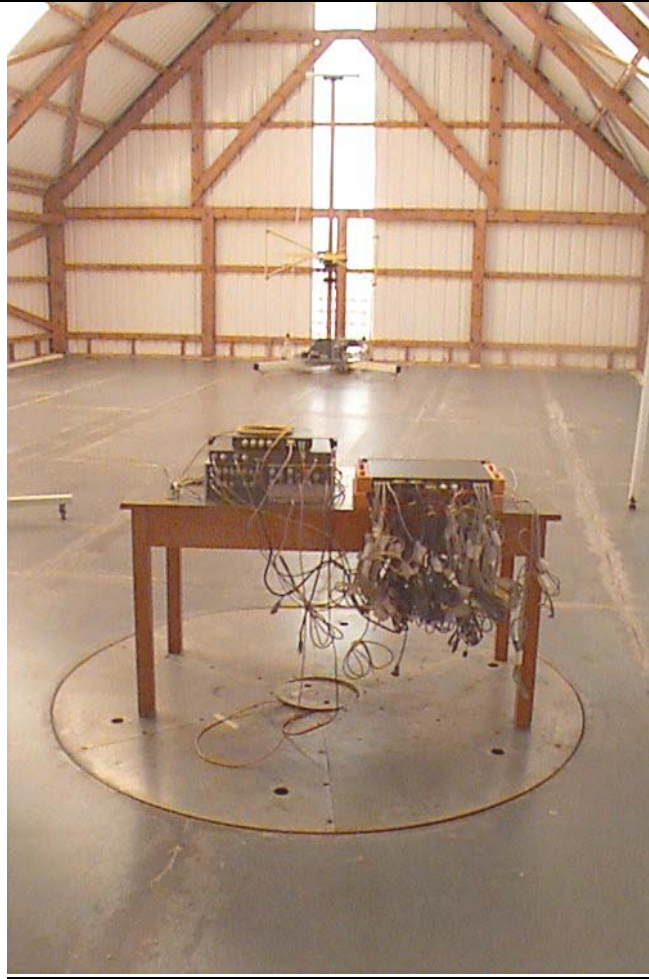
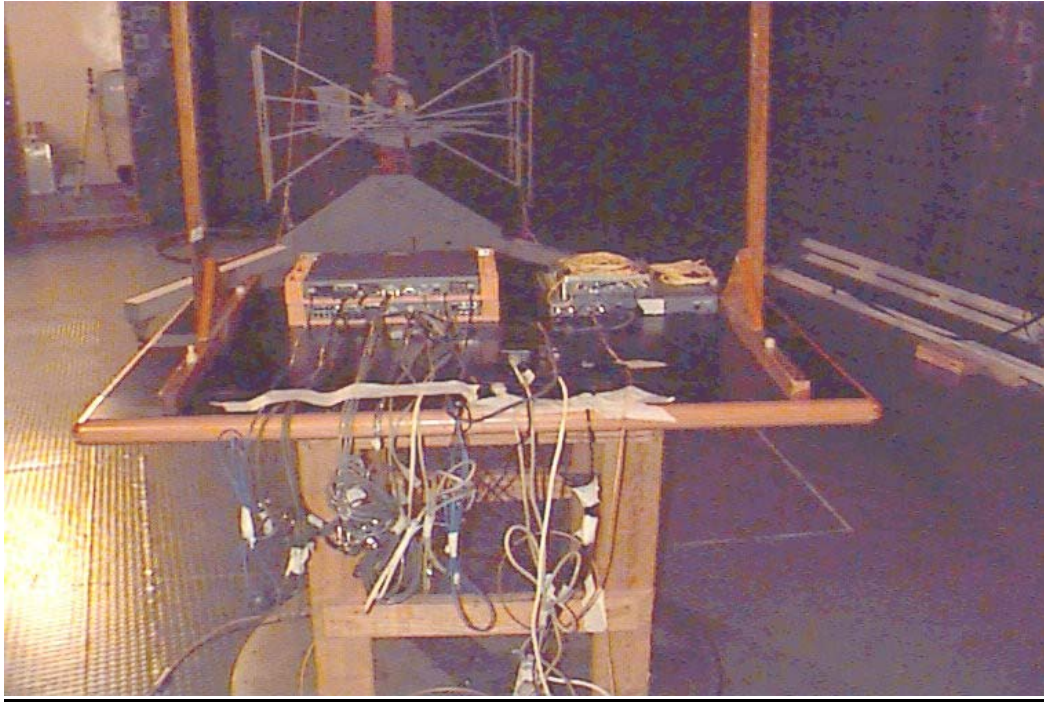
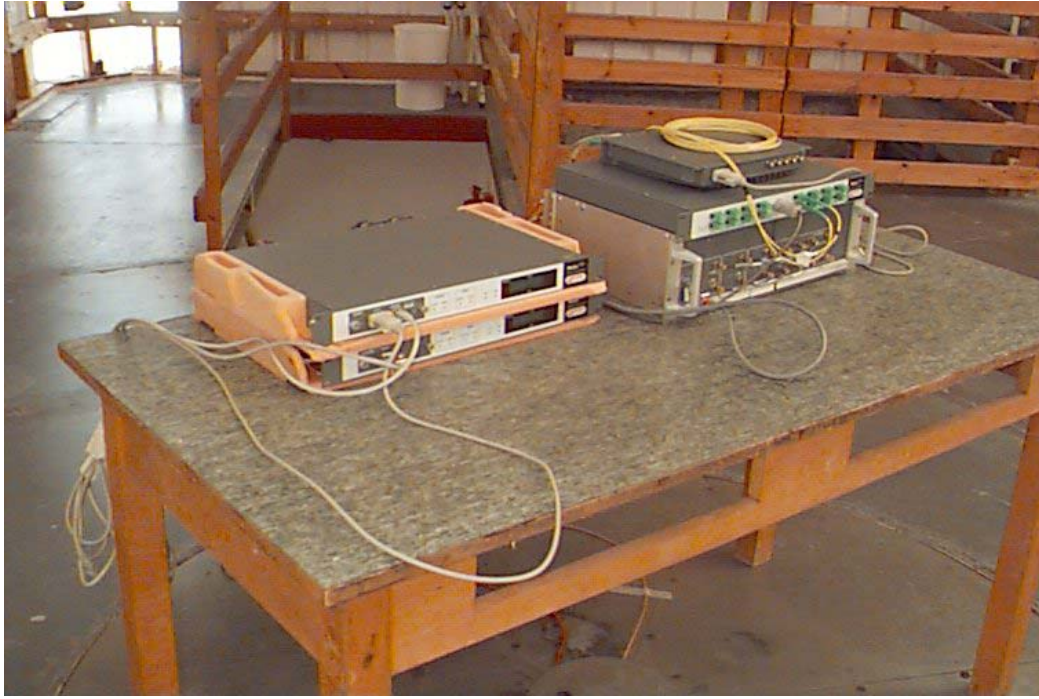

EUT SETUP PHOTOS of Conducted Emission 15.107

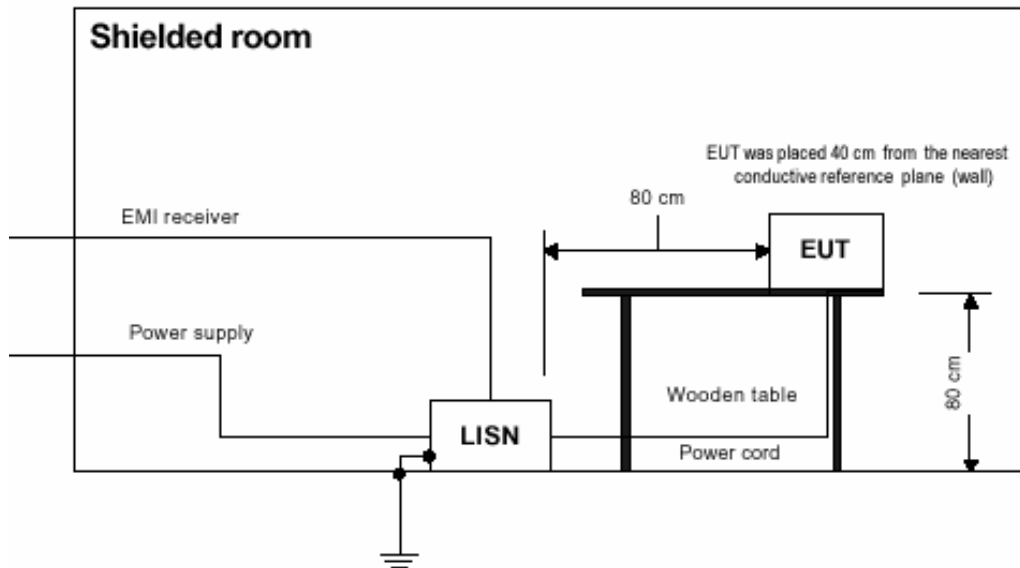

Setup for mains terminal radio interference voltage test, table-top equipment

