



**MobileAccessHX High Power
DAS System**
Installation and Configuration Guide

P/N: 709C006801
REV: A0
Date: 19-MAY-11

MobileAccess
8391 Old Courthouse Road, Suite 300, Vienna, VA 22182
Tel: +1(866)436-9266, +1(703)848-0200 TAC: +1(800)787-1266, Fax: +1(703)848-0280
<http://www.MobileAccess.com>

© COPYRIGHT 2011, MOBILEACCESS NETWORKS INC. ALL RIGHTS RESERVED.

MOBILEACCESS IS A REGISTERED TRADEMARK OF MOBILEACCESS. THIS DOCUMENT CONTAINS OTHER TRADEMARKS, TRADE NAMES AND SERVICE MARKS OF MOBILEACCESS AND OTHER ORGANIZATIONS, ALL OF WHICH ARE THE PROPERTY OF THEIR RESPECTIVE OWNERS.

THIS DOCUMENT CONTAINS CONFIDENTIAL AND PROPRIETARY INFORMATION OF MOBILEACCESS AND MAY NOT BE COPIED, TRANSMITTED, STORED IN A RETRIEVAL SYSTEM OR REPRODUCED IN ANY FORMAT OR MEDIA, IN WHOLE OR IN PART, WITHOUT THE PRIOR WRITTEN CONSENT OF MOBILEACCESS. INFORMATION CONTAINED IN THIS DOCUMENT SUPERSEDES ANY PREVIOUS MANUALS, GUIDES, SPECIFICATIONS, DATA SHEETS OR OTHER INFORMATION THAT MAY HAVE BEEN PROVIDED OR MADE AVAILABLE TO THE USER.

THIS DOCUMENT IS PROVIDED FOR INFORMATIONAL PURPOSES ONLY, AND MOBILEACCESS DOES NOT WARRANT OR GUARANTEE THE ACCURACY, ADEQUACY, QUALITY, VALIDITY, COMPLETENESS OR SUITABILITY FOR ANY PURPOSE OF THE INFORMATION CONTAINED IN THIS DOCUMENT. MOBILEACCESS RESERVES THE RIGHT TO MAKE UPDATES, IMPROVEMENTS AND ENHANCEMENTS TO THIS DOCUMENT AND THE PRODUCTS TO WHICH IT RELATES AT ANY TIME WITHOUT PRIOR NOTICE TO THE USER. MOBILEACCESS MAKES NO WARRANTIES, EXPRESS OR IMPLIED, INCLUDING, WITHOUT LIMITATION, THOSE OF MERCHANTABILITY AND FITNESS FOR A PARTICULAR PURPOSE, WITH RESPECT TO THIS DOCUMENT OR ANY INFORMATION CONTAINED HEREIN.

Policy for Warrantee and Repair

MOBILEACCESS TESTS AND INSPECTS ALL ITS PRODUCTS TO VERIFY THEIR QUALITY AND RELIABILITY. MOBILEACCESS USES EVERY REASONABLE PRECAUTION TO ENSURE THAT EACH UNIT MEETS THEIR DECLARED SPECIFICATIONS BEFORE SHIPMENT. CUSTOMERS SHOULD ADVISE THEIR INCOMING INSPECTION, ASSEMBLY, AND TEST PERSONNEL ABOUT THE PRECAUTIONS REQUIRED IN HANDLING AND TESTING OUR PRODUCTS. MANY OF THESE PRECAUTIONS CAN BE FOUND IN THIS MANUAL.

THE PRODUCTS ARE COVERED BY THE FOLLOWING WARRANTIES:

General Warranty

MOBILEACCESS WARRANTS TO THE ORIGINAL PURCHASER ALL STANDARD PRODUCTS SOLD BY MOBILEACCESS TO BE FREE OF DEFECTS IN MATERIAL AND WORKMANSHIP FOR ONE (1) YEAR FROM DATE OF SHIPMENT FROM MOBILEACCESS. DURING THE WARRANTY PERIOD, MOBILEACCESS WILL REPAIR OR REPLACE ANY PRODUCT THAT MOBILEACCESS PROVES TO BE DEFECTIVE. THIS WARRANTY DOES NOT APPLY TO ANY PRODUCT THAT HAS BEEN SUBJECT TO ALTERATION, ABUSE, IMPROPER INSTALLATION OR APPLICATION, ACCIDENT, ELECTRICAL OR ENVIRONMENTAL OVER-STRESS, NEGLIGENCE IN USE, STORAGE, TRANSPORTATION OR HANDLING.

Specific Product Warranty Instructions

ALL MOBILEACCESS PRODUCTS ARE WARRANTED AGAINST DEFECTS IN WORKMANSHIP, MATERIALS AND CONSTRUCTION, AND TO NO FURTHER EXTENT. ANY CLAIM FOR REPAIR OR REPLACEMENT OF UNITS FOUND TO BE DEFECTIVE ON INCOMING INSPECTION BY A CUSTOMER MUST BE MADE WITHIN 30 DAYS OF RECEIPT OF SHIPMENT, OR WITHIN 30 DAYS OF DISCOVERY OF A DEFECT WITHIN THE WARRANTY PERIOD.

THIS WARRANTY IS THE ONLY WARRANTY MADE BY MOBILEACCESS AND IS IN LIEU OF ALL OTHER WARRANTIES, EXPRESSED OR IMPLIED. MOBILEACCESS SALES AGENTS OR REPRESENTATIVES ARE NOT AUTHORIZED TO MAKE COMMITMENTS ON WARRANTY RETURNS.

Returns

IN THE EVENT THAT IT IS NECESSARY TO RETURN ANY PRODUCT AGAINST ABOVE WARRANTY, THE FOLLOWING PROCEDURE SHALL BE FOLLOWED:

1. RETURN AUTHORIZATION IS TO BE RECEIVED FROM MOBILEACCESS PRIOR TO RETURNING ANY UNIT. ADVISE MOBILEACCESS OF THE MODEL, SERIAL NUMBER, AND DISCREPANCY. THE UNIT MAY THEN BE FORWARDED TO MOBILEACCESS, TRANSPORTATION PREPAID. DEVICES RETURNED COLLECT OR WITHOUT AUTHORIZATION MAY NOT BE ACCEPTED.
2. PRIOR TO REPAIR, MOBILEACCESS WILL ADVISE THE CUSTOMER OF OUR TEST RESULTS AND ANY CHARGES FOR REPAIRING CUSTOMER-CAUSED PROBLEMS OR OUT-OF-WARRANTY CONDITIONS ETC.
3. REPAIRED PRODUCTS ARE WARRANTED FOR THE BALANCE OF THE ORIGINAL WARRANTY PERIOD, OR AT LEAST 90 DAYS FROM DATE OF SHIPMENT.

Limitations of Liabilities

MOBILEACCESS'S LIABILITY ON ANY CLAIM, OF ANY KIND, INCLUDING NEGLIGENCE FOR ANY LOSS OR DAMAGE ARISING FROM, CONNECTED WITH, OR RESULTING FROM THE PURCHASE ORDER, CONTRACT, QUOTATION, OR FROM THE PERFORMANCE OR BREACH THEREOF, OR FROM THE DESIGN, MANUFACTURE, SALE, DELIVERY, INSTALLATION, INSPECTION, OPERATION OR USE OF ANY EQUIPMENT COVERED BY OR FURNISHED UNDER THIS CONTACT, SHALL IN NO CASE EXCEED THE PURCHASE PRICE OF THE DEVICE WHICH GIVES RISE TO THE CLAIM.

EXCEPT AS EXPRESSLY PROVIDED HEREIN, MOBILEACCESS MAKES NO WARRANTY, EXPRESSED OR IMPLIED, WITH RESPECT TO ANY GOODS, PARTS AND SERVICES PROVIDED IN CONNECTION WITH THIS AGREEMENT INCLUDING, BUT NOT LIMITED TO, THE IMPLIED WARRANTIES OF MERCHANTABILITY AND FITNESS FOR A PARTICULAR PURPOSE. MOBILEACCESS SHALL NOT BE LIABLE FOR ANY OTHER DAMAGE INCLUDING, BUT NOT LIMITED TO, INDIRECT, SPECIAL OR CONSEQUENTIAL DAMAGES ARISING OUT OF OR IN CONNECTION WITH FURNISHING OF GOODS, PARTS AND SERVICE HEREUNDER, OR THE PERFORMANCE, USE OF, OR INABILITY TO USE THE GOODS, PARTS AND SERVICE.

Reporting Defects

THE UNITS WERE INSPECTED BEFORE SHIPMENT AND FOUND TO BE FREE OF MECHANICAL AND ELECTRICAL DEFECTS.

EXAMINE THE UNITS FOR ANY DAMAGE THAT MAY HAVE BEEN CAUSED IN TRANSIT. IF DAMAGE IS DISCOVERED, FILE A CLAIM WITH THE FREIGHT CARRIER IMMEDIATELY. NOTIFY MOBILEACCESS AS SOON AS POSSIBLE.

RF Safety

NOTE: KEEP ALL PACKING MATERIAL UNTIL YOU HAVE COMPLETED THE INSPECTION

WARNING: TO COMPLY WITH FCC RF EXPOSURE COMPLIANCE REQUIREMENTS, ANTENNAS USED FOR THIS PRODUCT MUST BE FIXED MOUNTED ON INDOOR PERMANENT STRUCTURES, PROVIDING A SEPARATION DISTANCE OF AT LEAST 80 CM FROM ALL PERSONS DURING NORMAL OPERATION.

WARNING: ANTENNA GAIN SHOULD NOT EXCEED 10 dBi.

WARNING: EACH INDIVIDUAL ANTENNA USED FOR THIS TRANSMITTER MUST BE INSTALLED TO PROVIDE A MINIMUM SEPARATION DISTANCE OF 80CM OR MORE FROM ALL PERSONS AND MUST NOT BE CO-LOCATED WITH ANY OTHER ANTENNA FOR MEETING RF EXPOSURE REQUIREMENTS.

WARNING: THE DESIGN OF THE ANTENNA INSTALLATION NEEDS TO BE IMPLEMENTED IN SUCH A WAY SO AS TO ENSURE RF RADIATION SAFETY LEVELS AND NON-ENVIRONMENTAL POLLUTION DURING OPERATION.

ATTENTION:

COMPLIANCE WITH RF SAFETY REQUIREMENTS:

MOBILEACCESS PRODUCTS HAVE NO INHERENT SIGNIFICANT RF RADIATION.

THE RF LEVEL ON THE DOWN LINK IS VERY LOW AT THE DOWNLINK PORTS. THEREFORE, THERE IS NO DANGEROUS RF RADIATION WHEN THE ANTENNA IS NOT CONNECTED.

Laser Safety

FIBER OPTIC PORTS OF THE MOBILEACCESSHX EMIT INVISIBLE LASER RADIATION AT THE 1310/1550 NM WAVELENGTH WINDOW.

TO AVOID EYE INJURY NEVER LOOK DIRECTLY INTO THE OPTICAL PORTS, PATCHCORDS OR OPTICAL CABLES. DO NOT STARE INTO BEAM OR VIEW DIRECTLY WITH OPTICAL INSTRUMENTS. ALWAYS ASSUME THAT OPTICAL OUTPUTS ARE ON.

ONLY TECHNICIANS FAMILIAR WITH FIBER OPTIC SAFETY PRACTICES AND PROCEDURES SHOULD PERFORM OPTICAL FIBER CONNECTIONS AND DISCONNECTIONS OF THE MOBILEACCESSHX MODULES AND THE ASSOCIATED CABLES.

THE MOBILEACCESS HX COMPLIES WITH CDRH21 CFR 1040.10 AND 1040.11 EXCEPT FOR DEVIATIONS PURSUANT TO LASER NOTICE NO. 50 (JULY 26, 2001) & IEC 60825-1, AMENDMENT 2 (JAN. 2001) & EN 60825-1.

Care of Fiber Optic Connectors

DO NOT REMOVE THE PROTECTIVE COVERS ON THE FIBER OPTIC CONNECTORS UNTIL A CONNECTION IS READY TO BE MADE.

DO NOT LEAVE CONNECTORS UNCOVERED WHEN NOT CONNECTED.

THE TIP OF THE FIBER OPTIC CONNECTOR SHOULD NOT COME INTO CONTACT WITH ANY OBJECT OR DUST.

REFER TO THE CLEANING PROCEDURE FOR INFORMATION ON THE CLEANING OF THE FIBER TIP.

Safety



WARNING! To comply with FCC RF exposure compliance requirements, antennas used for this product must be fixed mounted on indoor permanent structures, providing a separation distance of at least 80 cm from all persons during normal operation.

-
1. Each individual antenna used for this transmitter must be installed to provide a minimum separation distance of 80 cm or more from all persons and must not be co-located with any other antenna for meeting RF exposure requirements.
 2. The design of the antenna installation needs to be implemented in such a way so as to ensure RF radiation safety levels and non-environmental pollution during operation.
-

Compliance with RF safety requirements:

- MobileAccess products have no inherent significant RF radiation.
- The RF level on the downlink is very low at the downlink ports. Therefore, there is no dangerous RF radiation when the antenna is not connected.

Standards and Certification

MobileAccess products have met the approvals of the following certifying organizations:

Company Certification

ISO ISO 9001: 2000 and ISO 13485: 2003

Product Certifications

US

Radio Equipment and Systems

FCC 47 CFR part 22 – for CELL Frequency Band

FCC 47 CFR part 24 – for PCS Frequency Band

FCC 47 CFR part 27 – for 700 LTE and AWS Frequency Bands

EMC

FCC 47 CFR part 15 Subpart B

NOTE: This equipment has been tested and found to comply with the limits for a Class A digital device, pursuant to Part 15 of the FCC Rules. These limits are designed to provide reasonable protection against harmful interference in a residential installation. This equipment generates, uses and can radiate radio frequency energy and, if not installed and used in accordance with the instructions, may cause harmful interference to radio or television reception, which can be determined by turning the equipment off and on, the user is encouraged to try to correct the interference by one or more of the following measures:

- Reorient or relocate the receiving antenna.
- Increase the separation between the equipment and receiver.
- Connect the equipment into an outlet on a circuit different from that to which the receiver is connected.
- Consult the dealer or an experienced radio/TV technician for help.

Warning!

Changes or modifications to this equipment not expressly approved by Mobile Access could void the user's authority to operate the equipment.

Europe

Radio Equipment Systems

EN 301502 – for GSM/EGSM Frequency Bands

EN 300609 – for DCS Frequency Band

EN 301908 – for UMTS Frequency Band

EMC

EN 301 489

Safety

EN 60950; UL 60950

CAN/CSA-C22.2 No.60950

Laser Safety

CDRH 21 CFR 1040.10, 1040.11 (Except for deviations per notice No.50, July 26, 2001)

IEC 60825-1, Amendment 2 (January 2001)

EN 60825-1

About this Guide and Other Relevant Documentation

This user guide describes how to perform the physical installation of the MobileAccessHX system. The installation procedures of other units (e.g. RIU, SC-450) relevant to the system are detailed in their user manuals (see *Additional Relevant Documentation* below).

Additional Relevant Documents

The following documents are required if the corresponding units are included in your system.

Document Name
RIU Installation and Configuration Guide
SC-450 Installation and Configuration Guide
MA Software Version Update Tool

List of Acronyms

BDA	Bi-Directional Amplifier
BTS	Base Transceiver Station
BTSC	Base Transceiver Station Conditioner
BU	Base Unit
DL	Downlink
HX	High Power Transmission
RIU	Radio Interface Unit
UL	Uplink

Table of Contents

1	Introduction to HX System	1
1.1	System Architecture	3
1.2	Application Topologies	4
1.3	System Monitoring and Management	4
1.4	HX Unit Interfaces	4
2	System Installation	7
2.1	Unpacking and Inspection	7
2.2	Mounting	8
2.2.1	Wallmount Installation	8
2.2.2	Rack Mount Installation	9
	Rack Brackets (supplied screws)	9
2.3	Connections	10
3	Commissioning MA Head-End	12
3.1	Initial Controller Setup	12
3.1.1	Open a Session to the Controller	12
3.1.2	IP Address Configuration	14
3.2	Configure Controller Settings	16
3.3	Device Configuration and Preparation	16
3.4	RIU Configuration	19
3.4.1	Configuration for all BTSCs (other than LTE 700)	19
3.4.2	BTSC LTE 700 MHz	20
3.5	Base Unit Configuration Dialog	22
4	Provisioning the MobileAccessHX	24
4.1	Accessing HX Management Options	24
4.2	Basic Setup Procedure	25
	Appendix A: System Specifications	30
	RF Parameters	30
	Appendix B: Ordering Information	33
	Appendix C: Site Preparation	37

1 Introduction to HX System

The MobileAccess**HX** is a high power, Distributed Antenna System (DAS) solution for indoors or outdoors (future option). It is a fiber-fed, compact, scalable multi-service platform designed to provide complete RF open space coverage for large scale public venues, such as campuses, stadiums, convention centers, hotels, airports, and train stations.

HX supports multiple wireless technologies and operator services over a single broadband infrastructure. Using low loss fiber optic cabling remote units can cover distances of up to 2Km from the BTS signal sources at the head-end.

Front-end wireless RF services are routed, over optic fibers, to HX series remote units that are securely located at each remote location. These modular service aggregation platforms precisely combine multiple wireless service signals for simultaneous distribution over a common broadband infrastructure.

The solution can be deployed in new sites or alongside existing MobileAccess**1000** (MA1000) and/or MobileAccess**2000** (MA2000) systems, sharing a common head-end and element management system (EMS).

Alongside MA1000/MA2000 deployments, MobileAccess**HX** provides a comprehensive indoor and outdoor coverage solution for varying site requirements, supporting everything from high-rise buildings and campus topologies to stadiums and airports.

*HX Remote Unit –
Indoor Model*



*HX Remote Unit
– Outdoor Model
(FUTURE)*

Figure 1-1. HX Indoor Model and HX Outdoor Model (FUTURE)

Features and Capabilities

- **Multi-Service Platform:** Accommodates virtually any mix of wireless voice and data services, eliminating the need for separate overlay networks. Supported services and technologies include: GSM, UMTS, HSPA, LTE, EDGE, EV-DO, AWS, and more.
- **Cost-Effective High Power:** Optimizes and reduces the number of antennas required to cover open areas by offering up to 33dBm (2W) composite power per frequency band.
- **Available in both Indoor and outdoor models** – outdoor models are weather resistant in order to precisely meet various location requirements at the site
- **Pay-As-You-Grow Design:** Can initially be deployed in dual-band, where tri-band or quad-band configurations can be enabled as needed.
- **Carrier-Grade Operation:** Advanced signal handling and management ensures carrier-grade performance in multi-operator deployments.
- **Design and Deployment Flexibility:**
 - Remote unit supports both SM and MM fiber connections.
 - Supports two to four wireless frequencies.
 - Either remote DC power fed or local AC power fed units available
- **Compatible with Existing MA1000/MA2000 Deployment:** Shares a common head-end and EMS in a single deployment.

1.1 System Architecture

MobileAccess**HX** provides a complete solution consisting of HX remote units at the remote locations and head-end elements that are shared with any existing MA1000/MA2000 system that is either installed or being installed at the site.

In the downlink, at the head-end, the BTS or BDA signal is conditioned by the RIU, ensuring a constant RF level. The conditioned signal is then converted by the Base Unit to an optical signal for transport over single or multi-mode fiber to the HX remote units, which are located at the remote locations. In the uplink, the process is reversed.

The MobileAccess**HX** Remote Unit consists of a compact enclosure that houses the RF module (supporting up to four services), power elements, and the required interfaces. At the remote end, the optical signal is reconverted to RF, amplified, filtered and distributed over the broadband antenna infrastructure through a single antenna port.

The HX unit is remotely managed from the SC-450 Controller installed at the head-end. The SC-450 connection to the HX is indirect – via the (host) Base Unit to which the HX is connected. SC-450 provides a central point for management of MobileAccess**HX**, MA2000 and MA1000 systems.

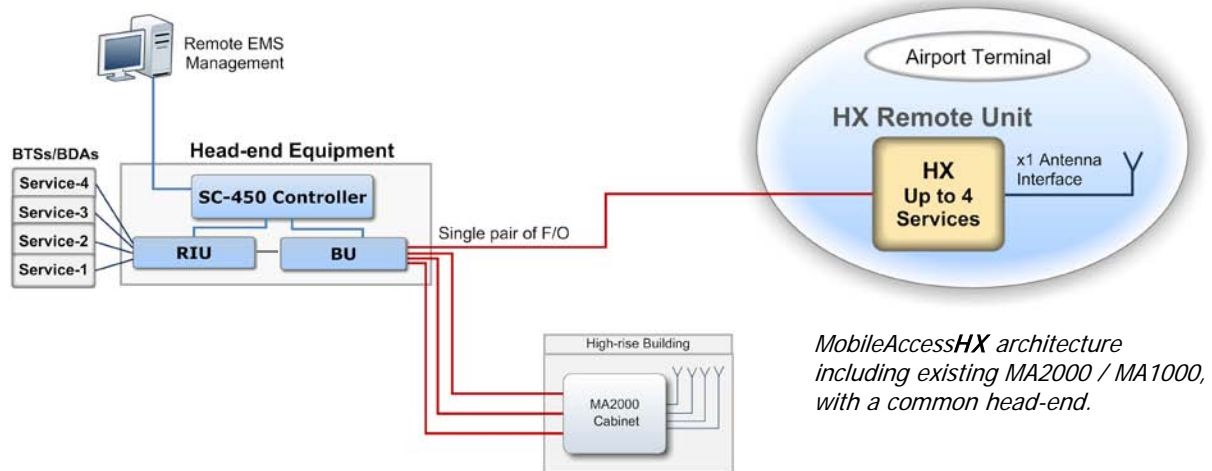

*MobileAccess**HX** architecture including existing MA2000 / MA1000, with a common head-end.*

Figure 1-2. System Architecture

1.2 Application Topologies

MobileAccessHX can be installed in various site topologies, where the setup procedure varies accordingly:

- High power coverage via a single antenna – installation is usually on pole or mast – used for open area, stadium, parking lots, etc.
- RF signal is distributed over several antennas via splitters
- Special coverage requirements using directional antennas

1.3 System Monitoring and Management

The MobileAccessHX Remote Unit is centrally managed via the MobileAccess SC-450 Controller. *Note that MobileAccessHX is not connected directly to the controller. It is connected to the Base Unit (that is connected to the controller). Thus, the controller monitors views and manages the HX via the Base Unit to which the HX is connected.*

The following shows the Config(uration) tab of the selected HX unit. The system configuration and management is described in Chapter 4.

The screenshot displays the MobileAccessHX web interface. The top navigation bar includes 'Monitor', 'Config', 'Events', 'Set-up', 'Management', and 'Help'. The left sidebar shows a tree view of the system hierarchy, including SC-450, CNTRL-M -HX_verification, P5-RIU, P6-RIU, P13-BASE UNIT, BU 1-4 -HX_VoD1, RHU3-P.SO, ADDON1 -aws, HX4 -HX_US_VoD1, BU 5-8 -VoD_HX_2, CNTRL16 -lor 8-----107, EHU -172.19.70.10, EHU -0.0.0.0, EHU -172.19.70.22, and EHU -172.19.1.15. The main content area shows a central image of the HX cabinet. Below the image are several configuration panels: 'HX Cabinet Alarms' with a list of alarms (HX General Alarm, Optical Link Alarm, Fans Alarm, Service 1 Cell800, Service 2 700LTE, Service 3 PCS1900, Service 4 AWS) and checkboxes; 'Module Info' with fields for Name (Building A 3rd Floor), Type (US), First Band (Cell800), Second Band (700LTE), Third Band (PCS1900), Fourth Band (AWS), and Location Index (0/13/1/4); and 'Service Alarms' with fields for Serial Number (0A380EF), Firmware Version (1.0B10), Product Revision (0.0), Laser and Optics, Link Status (NORMAL), and Link Level (193).

1.4 HX Unit Interfaces

The HX *antenna port* is located *externally*. All other interfaces such as F/O connections, power connections, etc. are located inside the cabinet and are accessed by opening the cabinet door.

The HX model consists of the following main components – open door view:

- Quad-band Service Module – connects to the Base Unit using a single fiber pair and supports up to four services
- External Amplifiers blade – 2 External Amplifiers are mounted on each of the 2 blades and provide the additional amplification on the DL signals coming from the Quad-band Service Module to the Multiplexer
- 8:1 Multiplexer – combines UL & DL signals of the 4 bands, while providing the proper filtering, into a single duplexed antenna port
- Power supply – local AC or Remote DC power feed (model depended)
- Duplexed antenna port – interface to RF antennas

Note: More information on the components and LEDs is provided in the tables in the next page.

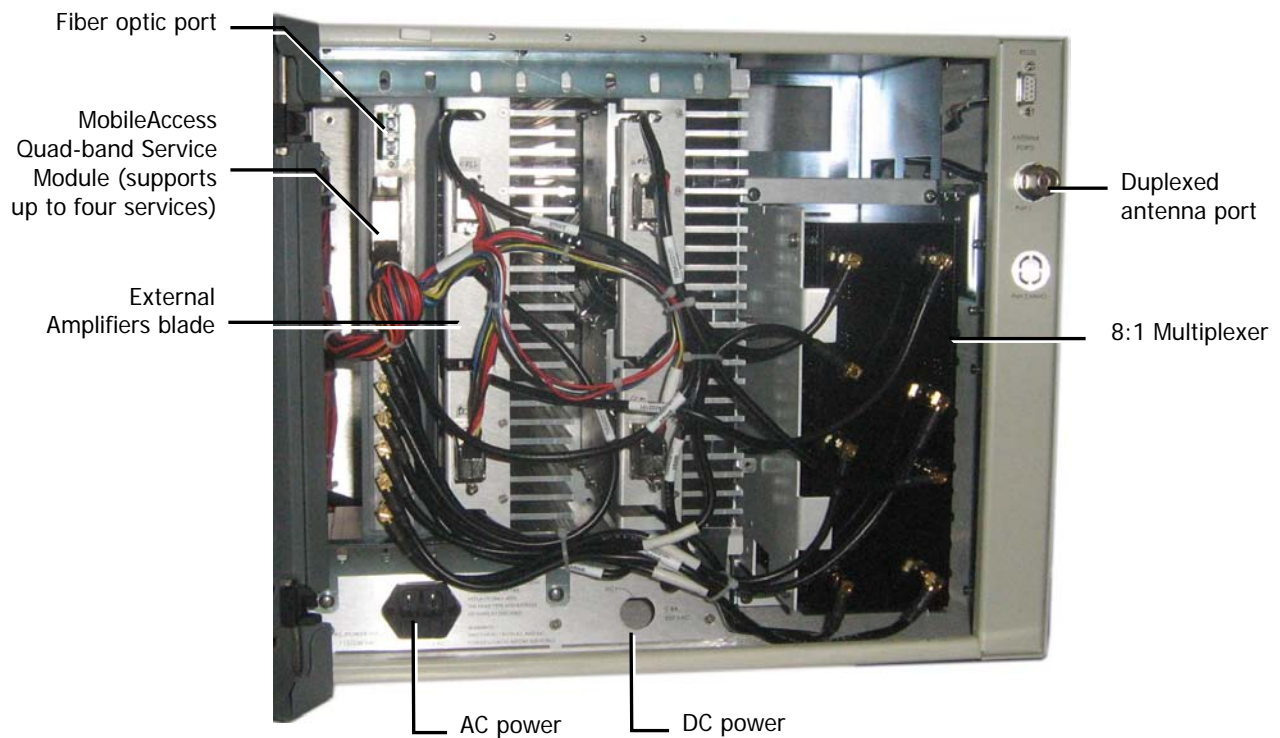

Figure 1-3. Example of Indoor HX Remote Unit Open front View



Figure 1-4. Example of Indoor HX Remote Unit rear View

The following tables provide a description of the HX indoor type connectors and LEDs.

Table 1-1. Connector Descriptions

Connector	Description
F/O	SC/APC fiber-optic connector for either SM or MM fibers
Antenna	N-Type female 50Ω duplexed connector for RF antenna
AC PWR	110/220 VAC power feed
DC	Direct 48VDC power feed
RS-232	Local craft connector
Grounding	Grounding lug

Table 1-2. LED Descriptions

Name	Description	Color	Status
Power	Device is powered	GREEN	Steady On
	Power not supplied to the unit	GREEN	Off
Comm	When connected and discovered by an OPTM (BU)	GREEN	Blink per communication attempt
	When device is powered on but no external communication is received	GREEN	Steady Slow Blink
Link	No Optical link is present	GREEN	Off
	Low optical link level from OPTM	GREEN	Blink
	Normal optical link level from OPTM	GREEN	Steady On





2 System Installation

This chapter describes the installation procedure for the MobileAccessHX Remote Unit. The installation procedure differs according to the type of enclosure –Indoor or Outdoor.

2.1 Unpacking and Inspection

Unpack and inspect the cartons according to the following procedure

1. Open the shipping carton and carefully unpack each unit from the protective packing material.
2. Verify that all the parts have been received:

Description	Qty	Item
HX Cabinet	1	
For AC power models - AC power cord <i>Note: Image shown here is for example only</i>	1	
For rack mount installations– 19" rack brackets (and cabinet assembly screws)	2 (R/L)	
For wall mount installations – wall bracket (and cabinet assembly screws).	2 (R/L)	

3. Check for signs of external damage. If there is any damage, call your MobileAccess service representative.

2.2 Mounting

The HX indoor model installation requires **two people** and can be installed in one of the following configurations:

- Wallmount - on the wall in the communication room
- Rackmount – in a 19" rack in the *communication room* allocated to that area.

General Installation Instructions

The Indoor type HX Remote Units unit should be installed in a communication room that provides access to authorized personnel only. The units are maintenance free. In the event of failure, only authorized personnel should handle the units.

- Environmental Data - Maximum ambient operating temperature: 50° C
- Maximum ambient temperature in a rack: 45° C

2.2.1 Wallmount Installation

The EXAMPLE is for CONCRETE walls (requires anchors McMaster-Carr catalogue number 92403A200, or equivalent).

To mount HX on wall

1. Assemble the WALL MOUNT BRACKETS (2) to the REAR PANEL of the HX cabinet using the supplied screws (4 for each bracket).
2. Using the bracket holes as a guide, drill four holes (2 for each bracket) for concrete anchors.
3. Insert the anchors in the wall and hang the HX cabinet.

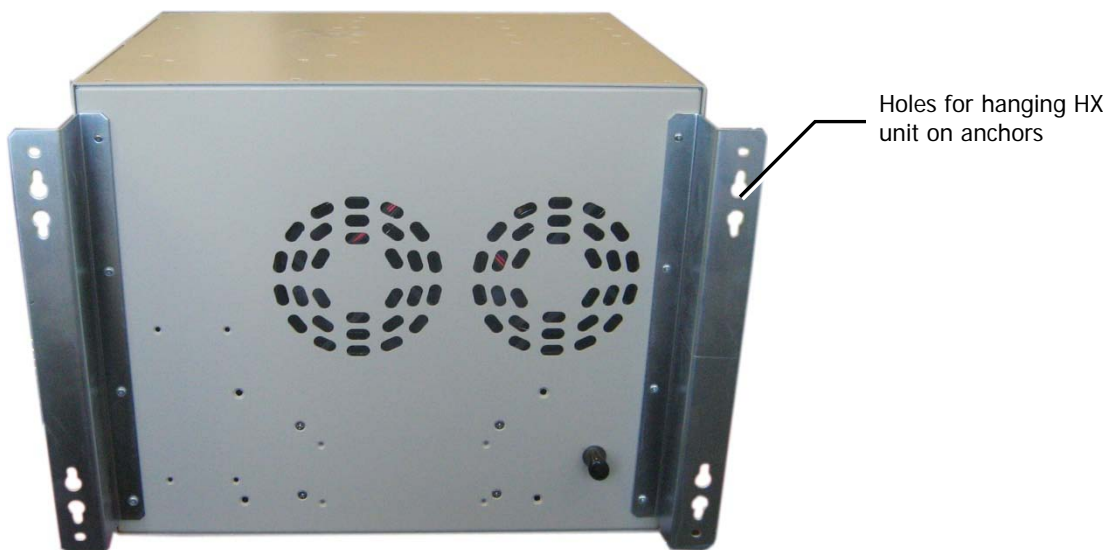

Figure 2-1. HX Indoor Unit with Assembled Wallmount Brackets

2.2.2 Rack Mount Installation

Rack Installation General Safety Instructions

Review the following guidelines to help ensure your safety and protect the equipment from damage during the installation.

- Only trained and qualified personnel should be allowed to install or replace this equipment.
- Verify that ambient temperature of the environment does not exceed 50°C (122°F)
- To maintain a low center of gravity, ensure that heavier equipment is installed near the bottom of the rack and load the rack from the bottom to the top.
- Ensure that adequate airflow and ventilation within the rack and around the installed components so that the safety of the equipment is not compromised. It is recommended to allow for at least about 2 cm of airspace between devices in the rack.

NOTE: The cabinet requires a clearance of 10 cm above the unit. If a heating source is installed beneath the HC cabinet, a buffer must be placed between the cabinet and the surface.

To install HX unit in rack

NOTE: Plan the location of the unit in the rack. If there is a heat emitting device located below the unit, place a heat absorbent buffer between the HX cabinet and heat emitting device.

1. Assemble the RACK MOUNT BRACKETS (2) to the SIDE PANELS of the HX cabinet using the supplied screws.
2. Mount in the 19" rack and secure with the supplied screws.

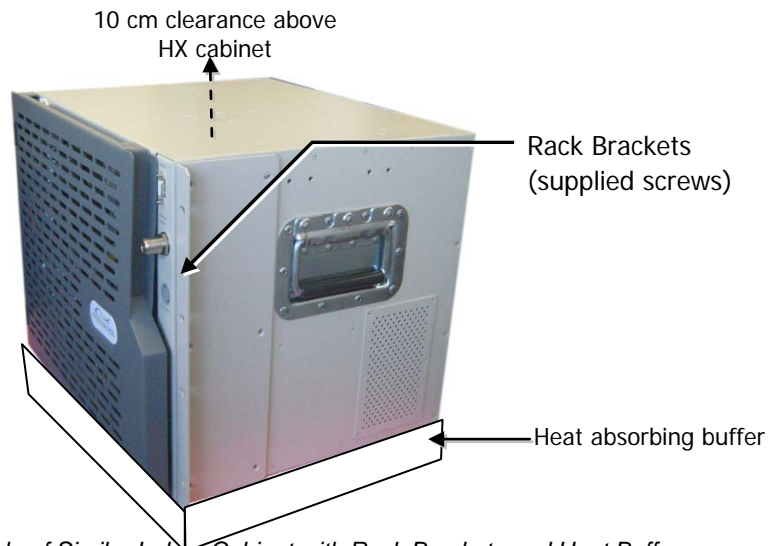

Figure 2-2. Example of Similar Indoor Cabinet with Rack Brackets and Heat Buffer

3. **Heat absorbing buffer** (not supplied) – in case of a heat emitting sources located below unit.

2.3 Connections

The HX main connections consist of the following:

- RF antenna
- Fiber Optic connection
- Power connections

Connect the HX Indoor unit as follows

1. Connect broadband ANTENNA coax to HX cabinet DUPLEXED ANTENNA port (external).
2. OPEN cabinet door.

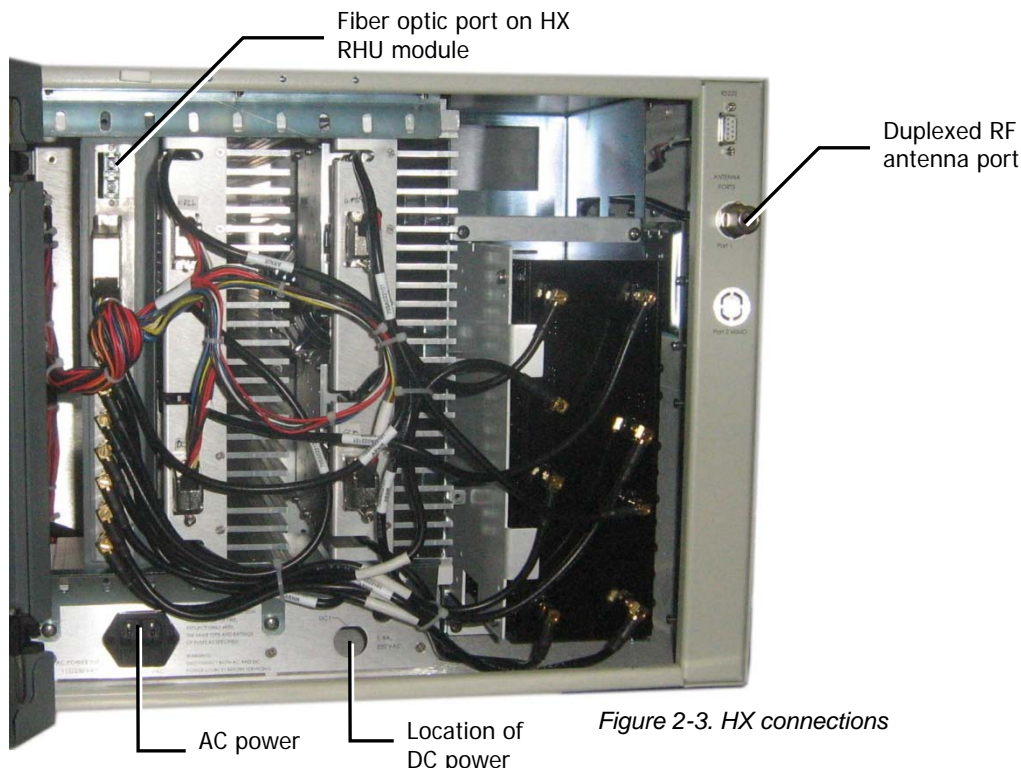

Figure 2-3. HX connections

3. Connect F/O cables to RHU optic port (internal).

NOTE: Keep in mind the rules for handling and connecting F/O cables. The F/O cables will be connected to the associated BU in the communication room at a later phase.

- Install splice box near Remote Cabinet.
- Connect fiber optic cable to splice box and the SC/APC pigtails to the HX RHU module.
- For the downlink, connect the fiber optic cable pigtails from splice box coming from the BU port to the corresponding RU port (routing the optic fibers so they will fit through the top opening in the door.)
- For the uplink, connect the fiber optic cable pigtails from splice box from the RU (routing the optic fibers so they will fit through the top opening in the door), to the uplink port that connects to the BU.

Note: The internal power connections and other connections should already be connected.

4. Connect AC (cable supplied) or DC power according to your MODEL. (Unit should power-ON).
5. Verify that the RHU LEDs are GREEN:
 - PWR and Link: Steady Green
 - COMM: Blinking GreenIf the LEDs are not as described above, refer to HX Unit Interfaces for troubleshooting.
6. Route the fiber optic cables toward the TOP of the cabinet and the power cable towards the bottom.

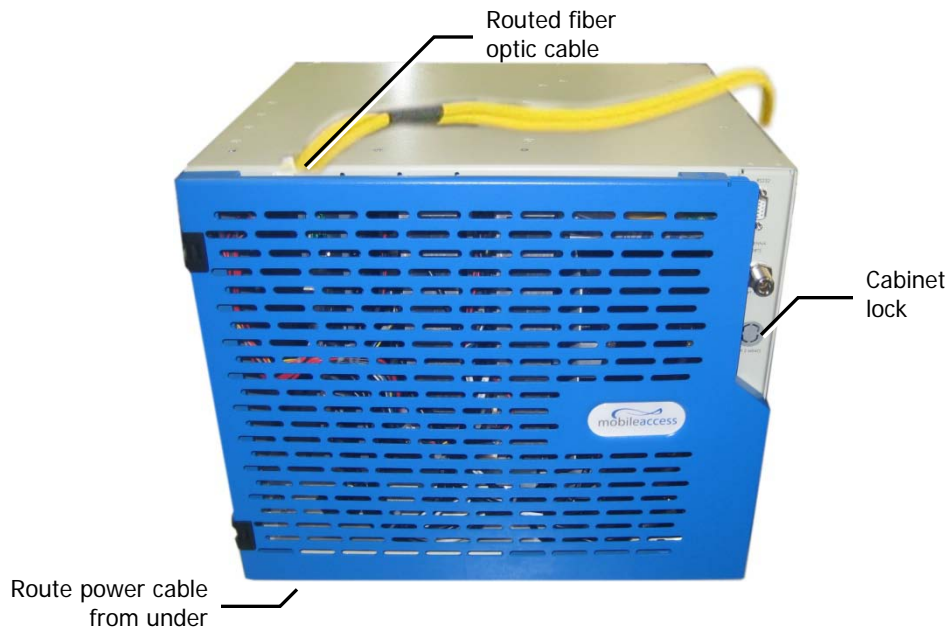

Figure 2-4. Closed HX Cabinet with Routed Cables

7. Close the cabinet door, routing the corresponding cables through the top and bottom openings and lock the door.

3 Commissioning MA Head-End

This section is relevant for installations in which an MA1000/2000 platform is NOT already installed at the site. This section provides a description of how to configure the head-end units required for HX operation which include the SC-450 Controller, RIU and Base Unit.

NOTE: This section does NOT describe the physical installation of the head-end units. The physical installation is described in the corresponding Quick Installation Sheets or User Manuals.

3.1 Initial Controller Setup

NOTE: The available tabs and options may vary depending on the access level used to open your session.

This section provides the details on the basic setup and configuration of the SC-450 management interface. It is to be completed after the physical installation of the controller and connections to the relevant devices has been completed.

3.1.1 Open a Session to the Controller

1. Verify your computer is configured for a DHCP server:

NOTE: The procedure may differ depending on your specific Windows OS.

- a. In the **Local Area Connections** choose **Properties**.
- b. Select **Internet Protocol (TCP/IP) Connection**, choose **Properties** and define for DHCP and automatic DNS server address acquisition as shown in following figure. Click **OK**.

2. Connect the PC directly to the **SC-450 LOCAL** port via the supplied cross-cable as illustrated below.

Warning!!! Do NOT connect the SC-450 LOCAL port to a network as its DHCP server can disrupt LAN IP addressing.

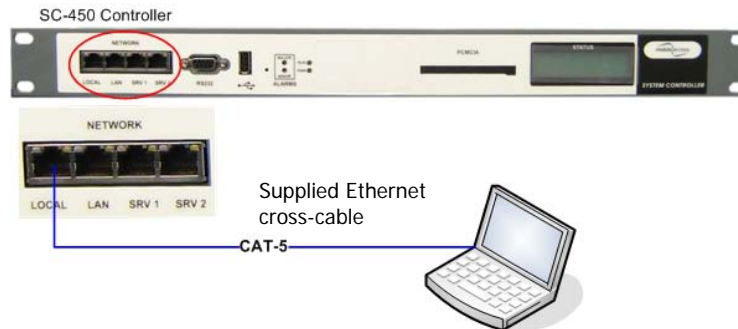
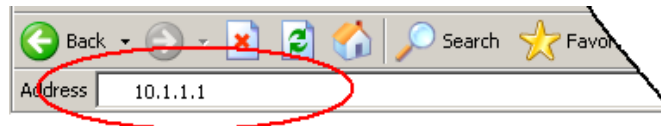

Figure 3-1. Connect PC to the SC-450 Local Port

3. Open a **Web browser** and enter the SC-450 default address: **10.1.1.1**.



The SC-450 has been optimized for use on IE 6.0 and Firefox 3.0 or higher. For proper display on IE 8.0 use compatibility mode by selecting Tools -> Compatibility View Options and Add the SC-450 website 10.1.1.1.

The Login dialog appears.



4. To open a session with configuration privileges, enter:
 - a. User Name: '**engineer**'
 - b. Default Password: '**eng**'

3.1.2 IP Address Configuration

Set the SC-450 **LAN port** for remote control via *static or dynamic IP address*.

NOTE: Local setup and troubleshooting is performed via the **SC-450 LOCAL** port. In addition, the Local port can be assigned *a static IP address* and connected to the customer LAN for remote access capability.

To Configure SC-450 for Remote or Local Management

1. Access the GUI interface of the SC-450.
2. Select the **Management** tab and then click **IP Settings** on the side bar menu.

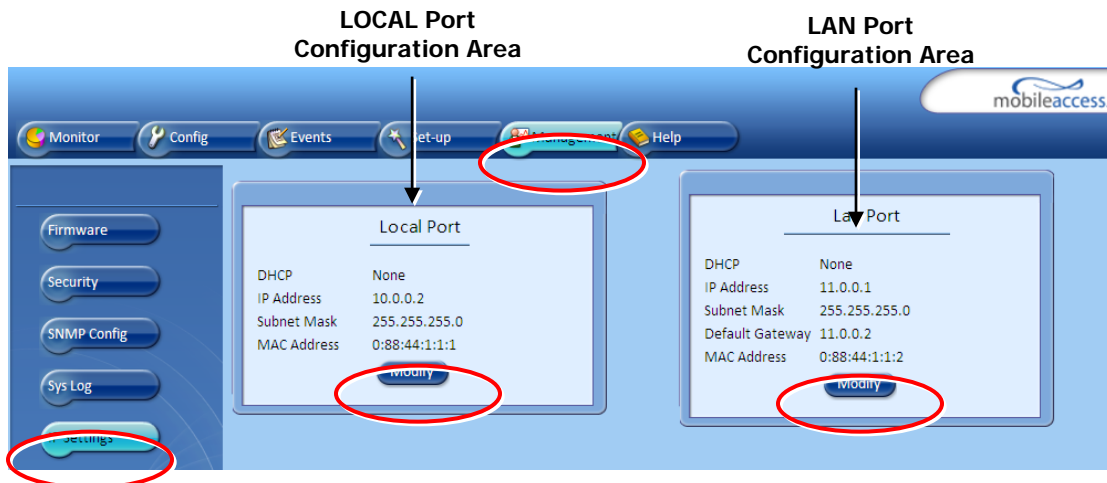

3. To change the LAN Port network settings, click the **Modify** button in the LAN Port Configuration Area. The following dialog appears.

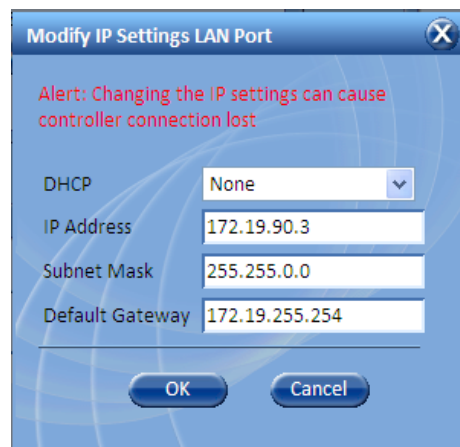

To Define...	Do This...
Static IP Address	Set DHCP as None . Enter the IP Address, Subnet and Gateway. Click OK .
Dynamic IP Address	Set DHCP as Client and click OK .

- To change the LOCAL Port network settings, click the **Modify** button in the LOCAL Port Configuration Area. The following dialog appears. The LOCAL Port configuration settings are displayed on the SC-450 LCD.



To Define...	Do This...
Static IP Address	Set DHCP as None . Enter the IP Address and Subnet. Click OK .
DHCP Server	Set DHCP as Server and click OK . WARNING!!! When using this setting, connect ONLY directly to the PC – NOT to a network.

3.2 Configure Controller Settings

In the **Network Topology**, double-click on the controller item. The controller *General* tab is displayed, where the **Controller Mode** is displayed as shown below.

The screenshot shows the 'General' tab of the controller settings. The interface is blue-themed. On the left, there are fields for 'Name' (Master13_19), 'Firmware Version' (4.6/5.6), 'Serial Number' (0533363), and 'Product Revision' (B51). A 'Modify' button is next to the Name field. Below these is a 'Controller Type' dropdown menu set to 'Heartbeat Enabled' and a 'Controller Mode' field set to 'Slave'. On the right, there are fields for 'Date' (03/Nov/10) and 'Time' (10:34:25), with a 'Modify' button below them. At the bottom right, there is a 'Baseline' field and a 'Set' button.

Configure as follows:

1. In the **General** tab:
 - Assign the controller a recognizable **Name** indicating its location or other.
 - Verify that the correct **Time and Date** are set for the controller since events for devices under this controller will be received with the set time and date.
 - Set the **Controller Type** according to your system.
 - Click the **Base Line** button. This sets *all* of the MobileAccess devices currently displayed in the Network Topology pane as a reference and will continue displaying them (in gray) even if communication is lost with a device.

3.3 Device Configuration and Preparation

This procedure consists of two phases: configuration and preparation phase and adjustment procedure.

NOTE: The available tabs and options in the SC-450 Web GUI may vary depending on the access level used to open your session.

Phase I

1. Log-in to the SC-450. Refer to section 3.1.1 for details.
2. Verify that the **Base Unit**, **RIU** and **HX** units are displayed in the Network Topology tree.

NOTE: HX units are hosted by the BU and are detected every time the BU is powered-up or reset from the Web GUI application.

Verify that all the elements are displayed in the Network Topology pane under their corresponding hosts, and are colored **green**, **red**, or **yellow**. Any of these colors are acceptable before the adjustment procedure has been performed (following sections).

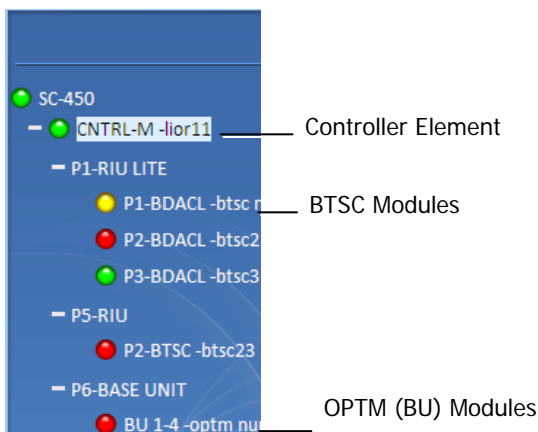

3. Verify that the BU is set to operate with RIU:
 - Click on the BU item in the **Network Topology Tree** → Select **RF Parameters Tab** from the Work Area → **Interface Type to MA RIU**
 - Optional: Assign the BU an identifiable name by Modifying the Name parameter in the Module Info tab
4. Using a Fiber Optic Tester, verify that the UL Optical Link Level of the fiber connected to the BU is >0
 - Set the Fiber Optic Tester to a wavelength of 1310nm
 - Unplug the UL fiber connection from the BU and test to make sure it is at a level >0
 - If the level is not >0, clean the fiber and retest
5. Set up CW signal to be connected to the signal conditioner (BTSC/BDAC). The 700 MHz LTE conditioner does not need an external CW signal (See Section 3.3.3).
 - BTSC acceptable input power range = +10 to +36dBm
 - BDAC acceptable input power range = -16 to +10 dBm
 - Acceptable frequency range depends upon the RF service
6. Adjust the signal conditioner (BTSC/BDAC) with the CW signal. The 700 MHz LTE conditioner does not need an external CW signal. (See Section 3.3.3).
 - Connect the CW signal to the BTSC/BDAC DL Port or Duplex port located on the rear of the RIU associated with the slot that the signal conditioner (BTSC/BDAC) is inserted into
 - Click on the conditioner in the Network Topology Tree → Select RF Parameters Tab from the Work Area → Adjust Max Input Power by clicking on the Adjust button in the DL Power section → Select Use Current Input Power
 - After a few moments, verify that the Target Max Input Power and the Current Input Power are equivalent
7. Repeat Step 6 for each signal conditioner
8. Perform a Quality and Integrity Check of the installed system as per the RF Design and Statement of Work. Contact a MobileAccess Project Manager for more instructions.

Phase II

These Phase II steps should only be performed after completing Phase I of the commissioning process.

NOTE: Please consult a MobileAccess certified installer on the details of these steps or access the MobileAccess Partner Portal for more information.

1. Perform an Emulated Adjustment
2. Perform UL Noise Mitigation

3.4 RIU Configuration

There are two types of RIU configuration procedures:

- Configuration for all BTSC modules except for LTE 700
- Configuration for BTSC 700 module

3.4.1 Configuration for all BTSCs (other than LTE 700)

Perform this procedure for each RIU module (BTSC/BDAC):

1. Double-click on the **BTSC** item in the **Network Topology**. The BTSC configuration dialog appears.

Module Info	
Name	UMTS <input type="button" value="Modify"/>
Type	BTSC
Band	UMTS
Serial Number	08242CB
Firmware Version	3.0
Product Revision	N/A
Location Index	0/1/1

2. Assign the BTSC an identifiable name (i.e. operator name), by clicking the **Modify** button and typing the name.
3. Click on the **RF Parameters** tab.

Module Info		RF Parameters	
DL Power			
Target Max Input Power	13 dBm	UL Atten. Control	
Current Input Power	Low	Atten. Value	17
Adjust Max Input Power	<input type="button" value="Adjust"/>	DL AGC control	
Adjustment Date/Time	12/Oct/09 02:20:09	AGC Status	OFF
Adjustment Result	Success	Atten. Value	26dB
Service Control	ON		

4. Verify that **Service Control** is **ON**.
5. Set **DL AGC Control** to ON. (OFF – Disables automatic gain control.)
6. (Do NOT modify the **UL Atten. Value** – this is factory set and should NOT be modified unless unique conditions exist.)

3.4.2 BTSC LTE 700 MHz

To Configure and Control the MobileAccess BTSC LTE 700 MHz

1. Double-click on the **LTE BTSC** item in the **Network Topology**. The LTE BTSC configuration dialog appears with the **Module Info** tab displayed by default.

Module Info		RF Parameters	Sup. Parameters
Name	LTE700		Modify
Type	BTSC		
Band	LTE 700		
Serial Number	09330EC		
Firmware Version	3.1		
Product Revision	A01		
Location Index	14/1/3		

This tab provides general information such as software and hardware versions, type and serial number of the LTE BTSC.

2. Assign the BTSC LTE 700 MHz an identifiable name (i.e. operator name), by clicking the **Modify** button and typing the name.
3. Click on the **RF Parameters** tab, the following tab is displayed.
This tab shows information on the RF parameters, and provides service and RF signal control options.

Module Info		RF Parameters	Sup. Parameters
DL Power			
Target Max Input Power	3 dBm		
Current Input Power	Low		
Adjust Max Input Power	Adjust		
Adjustment Date/Time	09/Nov/09 15:03:18		
Adjustment Result	Success		
Service Control	OFF		
UL Atten. Control			
Atten. Value	17		
DL AGC control			
AGC Status	ON		
Atten. Value	8dB		

4. To control the service supported by this BTSC choose an option in the **Service Control** field:
 - ON – Enables Service
 - OFF – Disables Service
5. Under **DL Power** section of the tab, click **Adjust** and select the required value (dBm) and click **OK**.

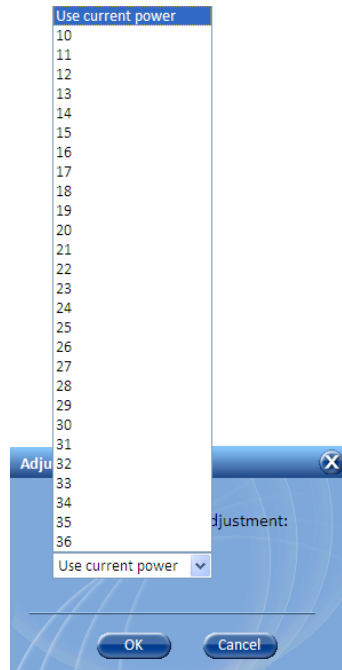

6. The DL power gain may be set automatically (AGC) or manually (DCA – Digital Control Attenuation). To control the **DL gain control**, set the **DL AGC Status**:
 - ON – Enables automatic gain control to compensate for input power variations. When enabled, gain control is performed automatically.
 - OFF – Disables automatic gain control and enables DCA to be set manually (**DL DCA Manual Override Value**).
7. **UL Atten. Value** – Controls attenuation on the uplink. This value is set during manufacturing and should be modified only under special circumstances.
8. **Sup. Parameters** tab – Relevant only for the initial adjustment procedure of the complete system (See LTE addendum document: *UMA_MA1000 MA2000_700MHz LTE AO*). Otherwise disregard.

This option provides an internal signal generation source that can be used during the adjustment procedure instead of connecting an external signal generator.



- ON – Internal signal source activated.
- OFF – Internal signal source disabled.

3.5 Base Unit Configuration Dialog

The configuration dialog consists of two tabs: Module Info and RF parameters. The main provided functions are:

- In the Module Info tab - Viewing basic information on the unit and assigning the unit an identifiable name.
- In the RF Parameters tab - Setting gain control, resetting the Base Unit (required when an RHU is added) and monitoring the downlink signal.

To Configure and Control the Base Unit:

1. Double-click on the **Base Unit** item in the **Network Topology**. The Base Unit configuration dialog appears.



2. In the **Module Info** tab click the **Modify** button and assign the BU an identifiable name that indicates the technology to which it interfaces.
3. Click the **RF Parameters** tab.



Set the following parameters:

- **Interface Type** – RF Source interface type (i.e. MA RIU, Other)
- **AGC Status** – Sets DL AGC mode:
 - ON – Automatic gain control to compensate for input power variations. When enabled, gain control is performed automatically.
 - OFF - DCA can be set manually (**DL DCA Manual Override Value**).
- **UL Atten. Value** – Controls attenuation on the uplink. This value is set during manufacturing and should be modified only under special circumstances.

4 Provisioning the MobileAccessHX

Once the required physical connections have been completed, the HX unit is automatically detected (auto-discover) by the SC-450 and can be remotely monitored and managed.

The MobileAccessHX Remote Unit is centrally managed via the MobileAccess SC-450 Controller. *Note that MobileAccessHX is not connected directly to the controller. It is connected to the Base Unit (that is connected to the controller). Thus, the controller monitors views and manages the HX via the Base Unit to which the HX is connected.*

Note: The provisioning procedure consists of two simple steps: assign the unit name (Module Info tab) and click the **Adjust** button (Adjustment tab). Additional configuration options are available as well.

Each HX unit can be managed via several dedicated panes that are accessed by clicking the relevant HX item in the SC-450 Topology Tree.

4.1 Accessing HX Management Options

To access the MobileAccessHX management options

In the **Network Topology** tree, expand the relevant **Controller** item, expand the relevant **Base Unit** (to which the HX is connected) and click on the **HX**. The HX alarms and management tabs appear.

The screenshot displays the MobileAccessHX management interface. On the left, the Network Topology tree is expanded to show the following structure:

- Controller: SC-450
 - CNTRL-M-HX_verification
 - P5-RIU
 - P6-RIU
 - P13-BASE UNIT
 - BU 1-4 -HX_VoD1
 - RHU3-P.50
 - ADDON1 -aws
 - HX4-HX_US_VoD1 (selected HX item)
 - BU 5-8-VoD_HX_2
 - CNTRL16-ilor 8-----107 (HX Alarm status)
 - EHU-0.0.0.0
 - EHU-172.19.70.22
 - EHU-172.19.1.15

On the right, the HX management interface is shown with four tabs: **Module Info**, **RF Parameters**, **DL Adjustment**, and **Service Alarms**. The **Module Info** tab is active, displaying the following information:

Name	Building A 3rd Floor	Modify	Serial Number	0A380EF
Type	US		Firmware Version	1.0B10
First Band	Cell800		Product Revision	0.0
Second Band	700LTE		Laser and Optics	
Third Band	PCS1900		Link Status	NORMAL
Fourth Band	AWS		Link Level	193
Location Index	0/13/1/4			

Below the tabs, the **HX Cabinet Alarms** section shows a list of alarms with their status:

- HX General Alarm (checked)
- Optical Link Alarm (checked)
- Fans Alarm (checked)
- Service 1 Cell800 (checked)
- Service 2 700LTE (checked)
- Service 3 PCS1900 (checked)
- Service 4 AWS (checked)

The overall status is shown as green with a checkmark and a 'Modify' button.

The **HX Cabinet Alarms** are continuously displayed (to the left of the tabs). The monitoring and configuration options are distributed over four tabs:

- Module Info - device version and identification definitions
- RF Parameters – service control options.

- RF Adjustment – provides the adjustment options.
- Service Alarms – used for masking redundant alarms

4.2 Basic Setup Procedure

To perform basic setup

1. Verify that the alarms show green in the following tabs:
 - **HX Cabinet Alarms** – displays system level alarms

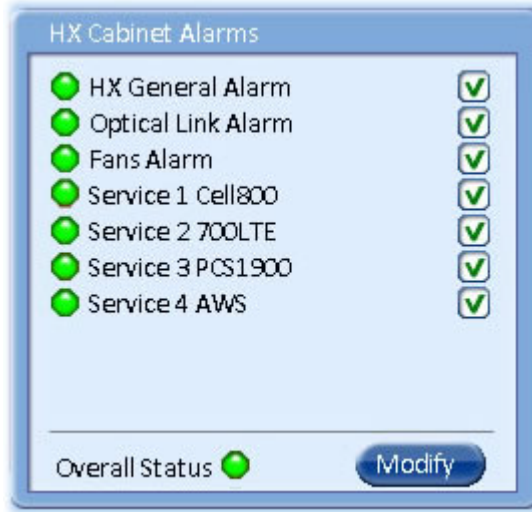

The following table provides a description of the device alarms shown above.

Table 4-1. HX Alarms Description

Alarm	Description
HX General Alarm	N/A
Optical Link Alarm	Low optical level from BU (link level < 56)
Fans Alarm	Faulty fans
Service 1/2/3/4	Summary of all port x / PA x monitored parameters displayed in the <i>Service Alarms</i> sub-tab
Overall status	Calculated according to its active alarms – corresponds to highest alarm level detected.

- **Service Alarms** – displays specific alarms for each supported service.

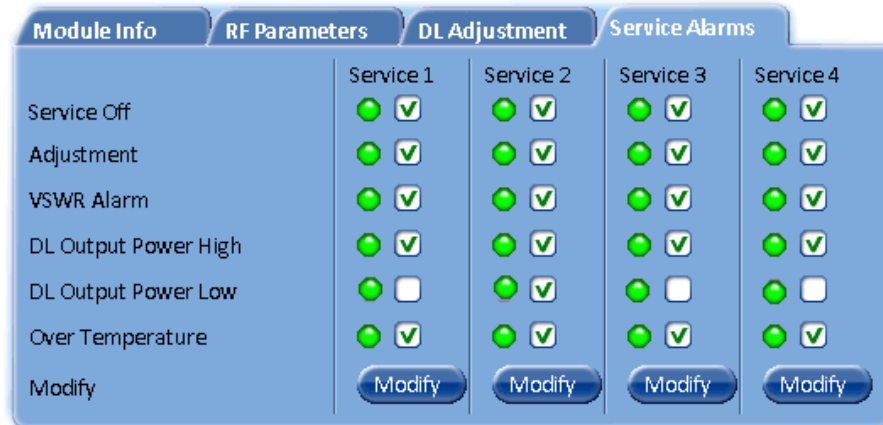

Table 4-2. HX Service Alarms Description

Alarm	Description
Service Off	Service disabled by the User
Adjustment	Adjustment for target DL Output Power
VSWR Alarm	Antenna disconnected (VSWR > 5:1)
DL Output Power High	DL Output Power > "Target Adjustment value" + 2dB
DL Output Power Low	DL Output Power < "Target Adjustment value" - 15dB
Over Temperature	Ambient temperature inside the HX unit >65°C

2. Mask irrelevant alarm conditions, in both tabs via the **Modify** button, to avoid having them reflected overall status of the HX unit (displayed in the *HX Alarms* area).

For Example

In the example below, the *HX Cabinet Alarms* dialog shows the alarm response if the Service 2 **DL Output Power Low** alarm is **NOT masked** (enabled). In that case the *Service 2* and *Overall Status* will be RED indicating a fault.

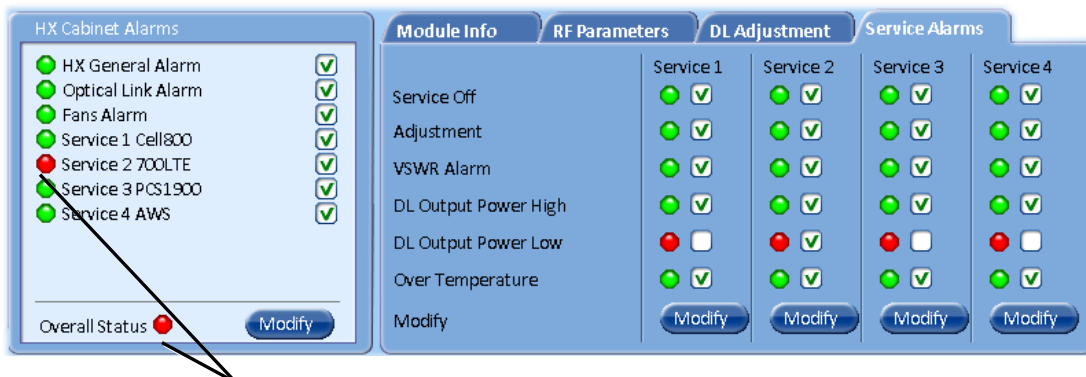

RED - Unmasked alarm reflects on corresponding Service alarm and Overall Status

Unmasked alarm

If the **Service 1** alarm is **MASKED** (Disabled), then the LED for the alarm will be RED; but, the corresponding Service alarm in *HX Cabinet Alarms* area will be GREEN – showing NO Fault.

Note: The Overall Status alarm will only show green if all of the generated alarms are masked (or if all alarms are green).

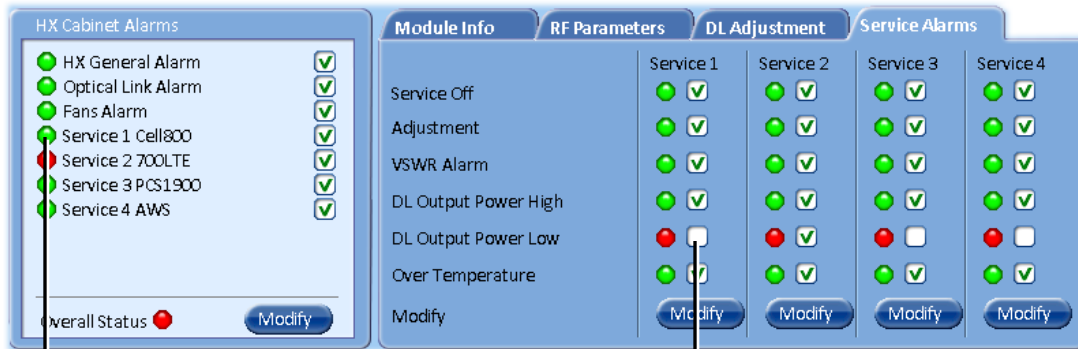

GREEN - Masked DL Output Power Low alarm (for Service 1) alarm does not reflect on corresponding Service alarm in *HX Cabinet Alarms* area.

Masked alarm

In the figure above the alarm condition for (Service 1) "DL Output Power Low" actually exists, while the masking prevents this condition from affecting the overall status of the service and therefore the Service 1 led in *HX Cabinet Alarms* area is green.

3. Assign the unit a recognizable name (i.e. corresponding to its location):

In the **Module Info** tab, click the **Modify** button, enter the required text and click **OK**. The assigned name will be displayed.

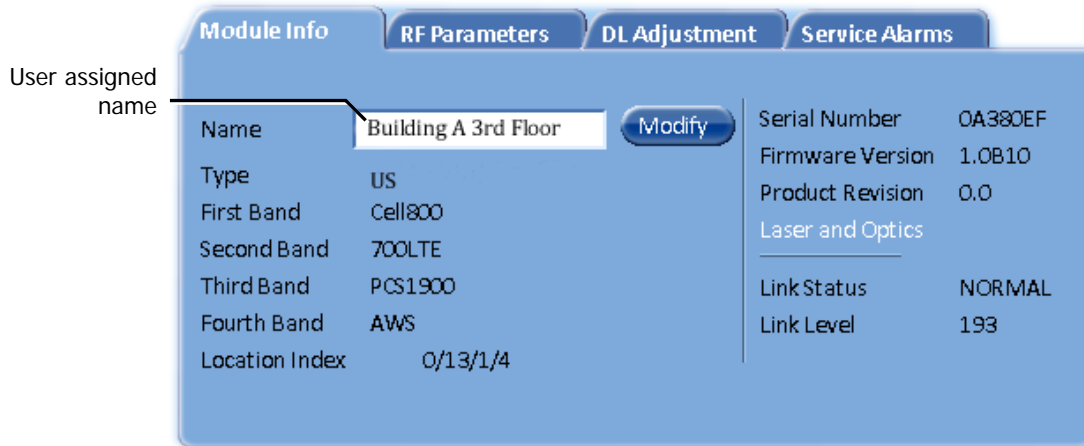

4. Click the **RF Paramaters** tab.

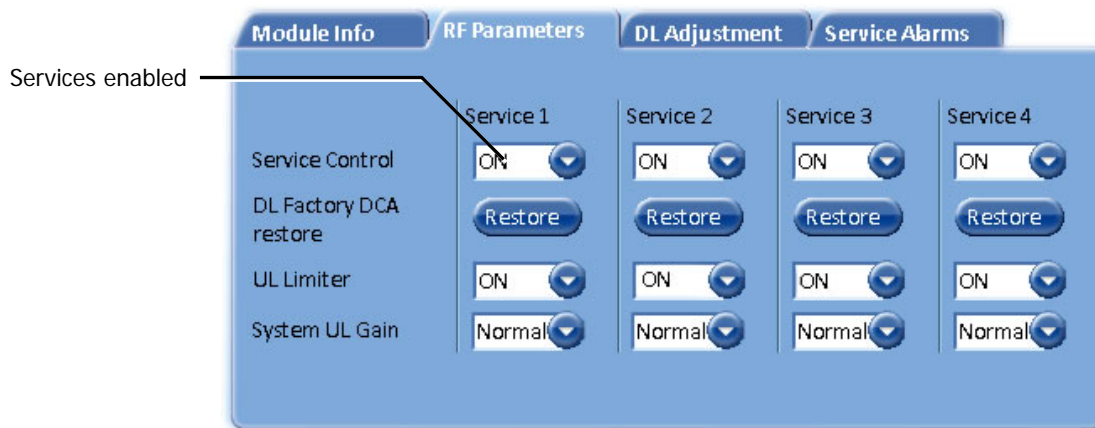

5. In the **DL Adjustment** tab:

Verify the following:

- All required services (e.g. Cell 800, 700 LTE, etc.) are enabled (Default = On)
- UL Limiter is enabled (Default = On)

NOTE: DL Factory DCA Restore – DO NOT click Restore button unless DL adjustment fails.

6. Verify that the System UL Gain is set to default configuration (i.e. Normal). See following table for Description of System UL Gain values.

Field Value	UL Gain (dB)	UL Limiter Threshold (dBm)	NF Type (dB)	Case Scenario
-------------	--------------	----------------------------	--------------	---------------

Low	1	-30	13	Set in cases where mobile stations are very near to the HX antenna (e.g. in cases where HX unit antenna port is splitted to multiple lower power antennas to cover standard office building)
Normal	11	-40	10	Default – for standard HX installations
High	21	-50	7	Set in cases where mobile stations are located far from the HX antenna (e.g. in a parking lot, where the HX unit is mounted high on a pole).

* $Max. NF = Typical NF + 4dB$

- In the **DL Adjustment** tab, perform DL adjustment manually to complete the commissioning procedure.
 - Set the **Target Max Pwr** (Target Pout) value according to site planning requirements. *Default Target Max Power value is the maximum value per each band (e.g. 33 dBm for 700LTE band).*
 - DL Output Power can be adjusted to a lower level (up to 10dB lower) as required.
 - Click the **Adjust** button.
 - Confirm that the adjustment procedure is successful (**Adjust Result** shows "Success") and verify actual readings of Adj. Date and DL Output Pwr .

If adjustment procedure fails, refer to the **RF Parameters** tab, click the **Restore** button and perform adjustment again.

The screenshot shows the 'DL Adjustment' tab with four service columns. Annotations indicate: 'Click to select Target Max Power' pointing to the dropdown menu for Service 1; 'Click to perform RF adjustment according to Target Max Power' pointing to the 'Adjust' button for Service 1; and 'Verify successful results' pointing to the 'Adj. Result' row. A bracket groups the 'Adj. Date' and 'DL Output Pwr' rows with the annotation 'Adjustment Date and Actual DL Pwr reading'.

	Service 1	Service 2	Service 3	Service 4
Target Max Pwr	31	25	33	33
Perform Adj.	Adjust	Adjust	Adjust	Adjust
Adj. Result	Success	Not Done	Success	Success
Adj. Date	16/Jan/11	N/A	24/Jan/11	04/Jan/11
DL Output Pwr	Low	Low	Low	Low

THE HX SETUP PROCEDURE IS NOW COMPLETE

Appendix A: System Specifications

RF Parameters

RF Frequency Range

Services	Band	Frequency Range	
		Uplink	Downlink
CDMA / WCDMA** / TDMA / GSM	CELL800	824-849	869-894
CDMA / WCDMA** / TDMA / GSM	PCS1900	1850-1915	1930-1995
WCDMA** / HSPA	AWS2100	1710-1755	2110-2155
LTE	700 MHz	698-716 and 776-787	728-757
GSM / GPRS / WCDMA / HSPA / LTE *	EGSM900	880-915	925-960
GSM / GPRS / WCDMA / HSPA / LTE*	DCS1800	1710-1785	1805-1880
WCDMA / HSPA / LTE*	UMTS2100	1920-1980	2110-2170

(*) WCDMA service is based on 3GPP standards, LTE service may be deployed in the future due to frequencies re-farming planned by the Carriers

(**) WCDMA service is based on 3GPP2 CDMA2000 standards.

RF Parameters per Service

MobileAccessHX RF Parameters														
MobileAccessHX RF Parameter	LTE 700 MHz		CELL TDMA / CDMA / WCDMA 800 MHz		PCS CDMA / WCDMA 1900 MHz		UMTS and AWS CDMA/ WCDMA 2100 MHz		GSM / E-GSM 900 MHz		DCS 1800 MHz		UMTS 2100 MHz	
	DL	UL	DL	UL	DL	UL	DL	UL	DL	UL	DL	UL	DL	UL
Max Output Power: 1 Carrier (Composite)	33		33		33		33		29		32		33	
2 Carriers	30		30		30		30		26		29		30	
4 Carriers	27		27		27		27		23		26		27	
8 Carriers	-		24		24		24		20		23		24	
12 Carriers	-		22		22		22		17		21		22	
24 Carriers	-		19		19		19		14		18		-	
Mean Gain (dB) ¹	33	11	33	11	33	11	33	11	29	11	32	11	33	11
Pin (dBm) ¹	0		0		0		0		0		0		0	
Input IP3 (dBm) AGC ON		16		16		16		16		16		16		16
Input IP3 (dBm) AGC OFF Typical		-10		-10		-10		-10		-10		-10		-10
Max Intermod Distortion (dBm)	-13**		-13*		-13*		-13*		-36*		-30*		-13*	
NF (dB) Typical		10		10		10		10		10		10		10
VSWR	1.5:1													
Gain Flatness/Ripple (dB) ²	+/-1.0 ³				+/-1.5				+/-2.0		+/-1.5			

* WCDMA complies with 3GPP TS 25.106 V5.0.0 (2002-03) table 9.4 spectrum emission mask.

** Out of band and spurious emissions compliant to FCC.

¹Factory set mean gain BU-HX without RIU. May be field adjusted using controller system.

²Gain Flatness/Ripple is specified for the non-duplexed port of the system.

³Gain Flatness/Ripple at any block of the spectrum.

Optical Specifications

Optical Output Power	<3.0mW
Max. Optical Budget	2 dB for fiber + 1 dB for connectors (assumed) = 3 dB total. 300 m Multi-mode
Optical Loss per Mated-pair Connectors	0.5dB (max)
Optical Connector	SC/APC
Fiber Type	Single-mode: 9/125um Multi-mode: 50/125 um or 62.5/125um (Minimum qualifications with ANSI/TIA/EIA-568-B series, EN50173-1 or ISO/IEC 11801)
Wavelength	1310±10nm
Maximum Distance Between Base Unit and Remote Cabinet	2km for SMF 300m for MMF

Physical Specifications – MobileAccessHX Remote Unit

	Indoor Remote Unit	Outdoor Remote Unit
Ports	(1) SC/APC fiber-optic pair connector (1) N-Type female 50Ω connector for antenna (1) Power connector for 110/220VAC power feed or (4) Power connectors for up to (4) direct 48VDC power feeds (1) D-Type 9 pins RS-232 connector for local craft	(1) SC/APC fiber-optic pair connector (1) N-Type female 50Ω connector for antenna (1) Power connector for 110/220VAC power feed or (4) Power connectors for up to 4 direct 48VDC power feeds (1) D-Type 9 pins RS-232 connector for local craft
Power	Local Power (AC) or Remote DC power feed options: 90-264 V AC or 36-75V DC Max Power Consumption: 350W	Local Power (AC) or Remote DC Power feed options: 90-264 V AC or 36-75V DC Max Power Consumption: 350W
Physical Dimensions	Mounting: Wall or Rack Dimensions: 43cm x 38cm x 35cm (16.9" x 14.9" x 13.8") [X,Y,Z] Weight (4 Services configuration): 32Kg (71 lb)	Mounting: Wall or Poll Dimensions: 43cm x 63cm x 30cm (16.9" x 24.8" x 11.8") [X,Y,Z] Weight (4 Services configuration): 52Kg (114 lb)

Environmental Specifications

	Indoor Remote Unit	Outdoor Remote Unit
Operating Temperature	0°C to +50°C (32°F to 122°F)	-10°C to +50°C (14°F to 122°F)
Storage Temperature	-20°C to 85°C (-4°F to 185°F)	-20°C to 85°C (-4°F to 185°F)
Humidity	10% to 95%, non-condensing	-
Ingress Protection	-	IP65

Appendix B: Ordering Information

NOTE: The information listed below is updated up to the document publishing date. Refer to the MobileAccessHX datasheet for the most updated ordering information.

MobileAccessHX Remote Units **US Services, Indoor Units**

Service Supported	Part Number	Description
CELL/PCS/700LTE/AWS	HX-C85P19L70A17-AC-A	MobileAccessHX Quad-service indoor CELL, PCS, AWS, and 700 MHz LTE solution supporting local AC power, SMF and MMF.
	HX-C85P19L70A17-DC-A	MobileAccessHX Quad-service indoor CELL, PCS, AWS, and 700 MHz LTE solution supporting remote DC power, SMF and MMF.
CELL/PCS/700LTE	HX-C85P19L70-AC-A	MobileAccessHX Tri-service indoor CELL, PCS, and 700 MHz LTE solution supporting local AC power, SMF and MMF.
	HX-C85P19L70-DC-A	MobileAccessHX Tri-service indoor CELL, PCS, and 700 MHz LTE solution supporting remote DC power, SMF and MMF.
CELL/PCS/AWS	HX-C85P19A17-AC-A	MobileAccessHX Tri-service indoor CELL, PCS, and AWS solution supporting local AC power, SMF and MMF.
	HX-C85P19A17-DC-A	MobileAccessHX Tri-service indoor CELL, PCS, and AWS solution supporting remote DC power, SMF and MMF.
CELL/PCS	HX-C85P19-AC-A	MobileAccessHX Dual-service indoor CELL and PCS solution supporting local AC power, SMF and MMF.
	HX-C85P19-DC-A	MobileAccessHX Dual-service indoor CELL and PCS solution supporting remote DC power, SMF and MMF.
AWS/700LTE	HX-A17L70-AC-A	MobileAccessHX Dual-service indoor AWS and 700 MHz LTE solution supporting local AC power, SMF and MMF.
	HX-A17L70-DC-A	MobileAccessHX Dual-service indoor AWS and 700 MHz LTE solution supporting remote DC power, SMF and MMF.
PCS/AWS	HX-P19A17-AC-A	MobileAccessHX Dual-service indoor PCS and AWS solution supporting local AC power, SMF and MMF.
	HX-P19A17-DC-A	MobileAccessHX Dual-service indoor PCS and AWS solution supporting remote DC power, SMF and MMF.

MobileAccessHX Remote Units**US Services, Outdoor units**

Service Supported	Part Number	Description
CELL/PCS/700LTE/AWS	HX-C85P19L70A17-AC-B	MobileAccessHX Quad-service outdoor CELL, PCS, AWS, and 700 MHz LTE solution supporting local AC power, SMF and MMF.
	HX-C85P19L70A17-DC-B	MobileAccessHX Quad-service outdoor CELL, PCS, AWS, and 700 MHz LTE solution supporting remote DC power, SMF and MMF.
CELL/PCS/700LTE	HX-C85P19L70-AC-B	MobileAccessHX Tri-service outdoor CELL, PCS, and 700 MHz LTE solution supporting local AC power, SMF and MMF.
	HX-C85P19L70-DC-B	MobileAccessHX Tri-service outdoor CELL, PCS, and 700 MHz LTE solution supporting remote DC power, SMF and MMF.
CELL/PCS/AWS	HX-C85P19A17-AC-B	MobileAccessHX Tri-service outdoor CELL, PCS, and AWS solution supporting local AC power, SMF and MMF.
	HX-C85P19A17-DC-B	MobileAccessHX Tri-service outdoor CELL, PCS, and AWS solution supporting remote DC power, SMF and MMF.
CELL/PCS	HX-C85P19-AC-B	MobileAccessHX Dual-service outdoor CELL and PCS solution supporting local AC power, SMF and MMF.
	HX-C85P19-DC-B	MobileAccessHX Dual-service outdoor CELL and PCS solution supporting remote DC power, SMF and MMF.
AWS/700LTE	HX-A17L70-AC-B	MobileAccessHX Dual-service outdoor AWS and 700 MHz LTE solution supporting local AC power, SMF and MMF.
	HX-A17L70-DC-B	MobileAccessHX Dual-service outdoor AWS and 700 MHz LTE solution supporting remote DC power, SMF and MMF.
PCS/AWS	HX-P19A17-AC-B	MobileAccessHX Dual-service outdoor PCS and AWS solution supporting local AC power, SMF and MMF.
	HX-P19A17-DC-B	MobileAccessHX Dual-service outdoor PCS and AWS solution supporting remote DC power, SMF and MMF.

MobileAccess HX Remote Units**Non-US Services, Indoor units**

Service Supported	Part Number	Description
CELL/GSM/DCS/UMTS	HX-C85G91D18U21-AC-A	MobileAccess HX Quad-service indoor CELL, GSM Partner, DCS, and UMTS solution supporting local AC power, SMF and MMF.
	HX-C85G91D18U21-DC-A	MobileAccess HX Quad-service indoor CELL, GSM Partner, DCS, and UMTS solution supporting remote DC power, SMF and MMF.
GSM/DCS/UMTS	HX-G90D18U21-AC-A	MobileAccess HX Tri-service indoor GSM, DCS, and UMTS solution supporting local AC power, SMF and MMF.
	HX-G90D18U21-DC-A	MobileAccess HX Tri-service indoor GSM, DCS, and UMTS solution supporting remote DC power, SMF and MMF.
GSM/DCS	HX-G90D18-AC-A	MobileAccess HX Dual-service indoor GSM and DCS solution supporting local AC power, SMF and MMF.
	HX-G90D18-DC-A	MobileAccess HX Dual-service indoor GSM and DCS solution supporting remote DC power, SMF and MMF.
DCS/UMTS	HX-D18U21-AC-A	MobileAccess HX Dual-service indoor DCS and UMTS solution supporting local AC power, SMF and MMF.
	HX-D18U21-DC-A	MobileAccess HX Dual-service indoor DCS and UMTS solution supporting remote DC power, SMF and MMF.
GSM/UMTS	HX-G90U21-AC-A	MobileAccess HX Dual-service indoor GSM and UMTS solution supporting local AC power, SMF and MMF.
	HX-G90U21-DC-A	MobileAccess HX Dual-service indoor GSM and UMTS solution supporting remote DC power, SMF and MMF.

Non-US Services, Outdoor units

Service Supported	Part Number	Description
CELL/GSM/DCS/UMTS	HX-C85G91D18U21-AC-B	MobileAccess HX Quad-service outdoor CELL, GSM Partner, DCS, and UMTS solution supporting local AC power, SMF and MMF.
	HX-C85G91D18U21-DC-B	MobileAccess HX Quad-service outdoor CELL, GSM Partner, DCS, and UMTS solution supporting remote DC power, SMF and MMF.
GSM/DCS/UMTS	HX-G90D18U21-AC-B	MobileAccess HX Tri-service outdoor GSM, DCS, and UMTS solution supporting local AC power, SMF and MMF.
	HX-G90D18U21-DC-B	MobileAccess HX Tri-service outdoor GSM, DCS, and UMTS solution supporting remote DC power, SMF and MMF.
GSM/DCS	HX-G90D18-AC-B	MobileAccess HX Dual-service outdoor GSM and DCS solution supporting local AC power, SMF and MMF.
	HX-G90D18-DC-B	MobileAccess HX Dual-service outdoor GSM and DCS solution supporting remote DC power, SMF and MMF.

Service Supported	Part Number	Description
DCS/UMTS	HX-D18U21-AC-B	MobileAccessHX Dual-service outdoor DCS and UMTS solution supporting local AC power, SMF and MMF.
	HX-D18U21-DC-B	MobileAccessHX Dual-service outdoor DCS and UMTS solution supporting remote DC power, SMF and MMF.
GSM/UMTS	HX-G90U21-AC-B	MobileAccessHX Dual-service outdoor GSM and UMTS solution supporting local AC power, SMF and MMF.
	HX-G90U21-DC-B	MobileAccessHX Dual-service outdoor GSM and UMTS solution supporting remote DC power, SMF and MMF.

Accessories

MobileAccessHX Expansion Kits

Part Number	Description
AK-HX-A17-EXP	MobileAccessHX accessory kit supporting AWS service expansion. Compatible with CELL/PCS and CELL/PCS/700LTE remote units.
AK-HX-L70-EXP	MobileAccessHX accessory kit supporting 700 MHz LTE service expansion. Compatible with CELL/PCS and CELL/PCS/AWS remote units.
AK-HX-A17L70-EXP	MobileAccessHX accessory kit supporting AWS and 700 MHz LTE services expansion. Compatible with CELL/PCS remote units.
AK-HX-C85P19-EXP	MobileAccessHX accessory kit supporting CELL and PCS services expansion. Compatible with AWS/700LTE remote units.
AK-HX-C85L70-EXP	MobileAccessHX accessory kit supporting CELL and 700 MHz LTE services expansion. Compatible with PCS/AWS remote units.
AK-HX-U21-EXP	MobileAccessHX accessory kit supporting UMTS service expansion. Compatible with GSM/DCS remote units.
AK-HX-D18-EXP	MobileAccessHX accessory kit supporting DCS service expansion. Compatible with GSM/UMTS remote units.
AK-HX-G90-EXP	MobileAccessHX accessory kit supporting GSM service expansion. Compatible with DCS/UMTS remote units.

Appendix C: Site Preparation

This following installation rules are based on the assumption that site survey and installation planning (*including power requirements*) have been completed.

Installation Requirements

The infrastructure preparation consists of two main phases:

- A. **Floor Planning:** Planning the distribution of the antennas on each floor to provide the required coverage.
- B. **Telecom Closet Planning:** Planning the layout of the devices and cables in the telecom closet or shaft.

Coaxial Cable Connections

General Cable Installation Procedures

Observe the general cable installation procedures that meet with the building codes in your area. The building code requires that all cabling be installed above ceiling level (where applicable). The length of cable from the risers to each antenna must be concealed above the ceiling.

The cable must be properly supported and maintained straight using tie-wraps, cable trays and clamps or hangers every 10 feet (where practical above ceiling level). Where this is not practical, the following should be observed:

- The minimum bending radius of the supplied 1/2" coax cable should be 7".
- Cable that is kinked or has a bending radius smaller than 7" must be replaced.
- Cable runs that span less than two floors should be secured to suitably located mechanical structures.
- The cables should be supported only from the building structure.

Fiber Optic Rules

- Either single mode or multimode fiber can be used with MobileAccess**2000M** products, while MobileAccess**2000** products can only be used with single mode fiber.
- Only Multimode fiber, 50/125 or 62.5/125um complying with ANSI/TIA/EIA-568-B series, EN50173-1 or ISO/IEC 11801 can be used. The fiber length can be up to 300 meters assuming the following qualifications:
 - All fiber in a given length of fiber must be of the same core diameter.
 - All Bulkhead adapters must be Single mode SC/APC (Green) adapters.
 - All terminations cross connections or patches must be direct fusion splice or MobileAccess specified patch cords listed below.

900 microns pathcord for splicing, 2 Meters, 2xSC/APC		
Diamond p/n ENC/1045341	Beige boots, 62.5/125/900	MA# 500001057
Diamond p/n ENC/1045340	Black boots, 50/125/900	MA# 500001058

Zipcord patchcord, 4xSC/APC, 50/125/900/2000/4500 micron		
Diamond p/n ENC/1045342	Black/Brown boots, 1Meter	MA# 50000105
Diamond p/n ENC/1045343	Black/Brown boots, 3 Meter	MA# 500001060

Zipcord patchcord, 4xSC/APC, 62.5/125/900/2000/4500 micron		
Diamond p/n ENC/1045344	Beige/Brown boots, 1 Meter	MA# 500001061
Diamond p/n ENC/1045345	Beige/Brown boots, 3 Meter	MA# 500001062

- **Use only 8-degree SC/APC connectors (green color).**
- Use **only** fusion splice for connecting two fibers.
- Use minimum splicing/connectors to achieve minimum losses on the fibers (<0.5dB).
- Use precaution while installing, bending, or connecting fiber optic cables.
- Use an optical power meter and OTDR for checking the fiber optic cables.
- Make sure the environment is **clean** while connecting/splicing fiber optic cables.
- All fiber optic connections should be cleaned prior to attaching to termination points using a dry cleaning device (i.e. Cletop or equivalent).
- Fiber connector protective caps should be installed on all non-terminated fibers and removed just before they are terminated.
- Verify the Fiber Optic connections. You may use the Optical Test Procedure described at the end of this manual.
- Pay special attention while connecting the SC/APC connectors - you must hear the "click" when the connection is made.

RF Rules

- Use coax RG223, 50ohm, male-to-male N-type for RF connections from the BUs to the BTS/RBS and to the RIU.

- When using the MobileAccess system in an environment in which other indoor coverage systems are installed, it is recommended (where possible) that the antennas are placed at least two meters apart
- When bending coax cables, verify that the bending radius does not exceed the coax specifications.
- Use wideband antennas supporting a range of 800Mhz to 2500Mhz
- Use a VSWR meter (i.e. Site Master or equivalent) for checking coax cables, including the antennas. (<2). The VSWR must be measured prior to terminating the RUs in the remote communication rooms
- Terminate all unused **RU** and **RIU** ports with a 50 ohm load

Power Consumption, Connections and Power Supplies

Power Safety Instructions



SAFETY WARNINGS

- When installing or selecting the power supplies:
- Be sure to disconnect all power sources before servicing.
- SC-450 Controller lithium type battery should only be replaced by MobileAccess service personnel. **Risk of exploding if battery is replaced by an incorrect type.** Dispose of used batteries according to the instructions.
- Calculate the required power according to the requirements of the specific installation and then determine the configuration of the power supplies. The required DC cables will then be determined by the selected PS configuration.
- Use only **UL** approved power supplies
- **AC and DC power supply cables** – only use the power cords supplied with the units
- **Battery replacement in units** - only the SC-450 controller has batteries. These should be replaced (when necessary) only by MA Service Personnel.
- Install external over-current protective devices for the system according to the requirements.

Power Consumption of Units

Table 4-2. MobileAccess Power Requirements

Unit Type	Voltage Input	Power Consumption	Maximum Current Consumption
HX Remote Unit – Indoor Model	Local: 90-264V AC or Remote: 36 to 75V DC	350W (max)	-
HX Remote Unit – Outdoor Model	Local: 90-264V AC or Remote: 36 to 75V DC	350W (max)	-
Base Unit	20 to 48V DC	14W	0.7A
SC-450 Controller	36 to 60 V DC	10W	0.2A

Circuit Breakers

Install fuse protections for the system according to the following criteria:

- The following system elements require external fuse protection: **RIUs, BUs, and SC-450 Controllers**.
- Referring to Table 4-2, calculate the required fuse protection.
- **Example:** a set of three elements consisting of a BU, RIU and SC-450 controller requires a 2A circuit breaker.

Types of Power Supplies

MobileAccess supplies various power supplies that can be installed in a rack or mounted on a wall, depending on your configuration.

Installation Conventions

Some of the basic installation conventions are listed below for the MA 2000 system:

- **Base Units** – are usually concentrated in the same location, most often in the main communication room.
- **Remote Cabinet/Lite** – usually placed in the communication shaft or closet of a corresponding floor so they can be easily located. Each cabinet (or MA2000-Lite) can typically cover a floor of up to 30,000 sq ft.
- **Fiber optic cable** - bundled fibers are terminated into the Base Units in the main communication room. The fibers are then routed to each coverage locations where individual fibers terminate into splice boxes. The splice box couples the installed fiber into the remote units. Enough spare fibers should be installed to take into account future expansion of the system.

For example, for three remote units, six fibers are required. However, to allow for future expansion, it is recommended to install additional optic fibers to be connected to additional RUs.

Continued on the following page...

The following figure illustrates fiber optic routing to Remote Cabinets.

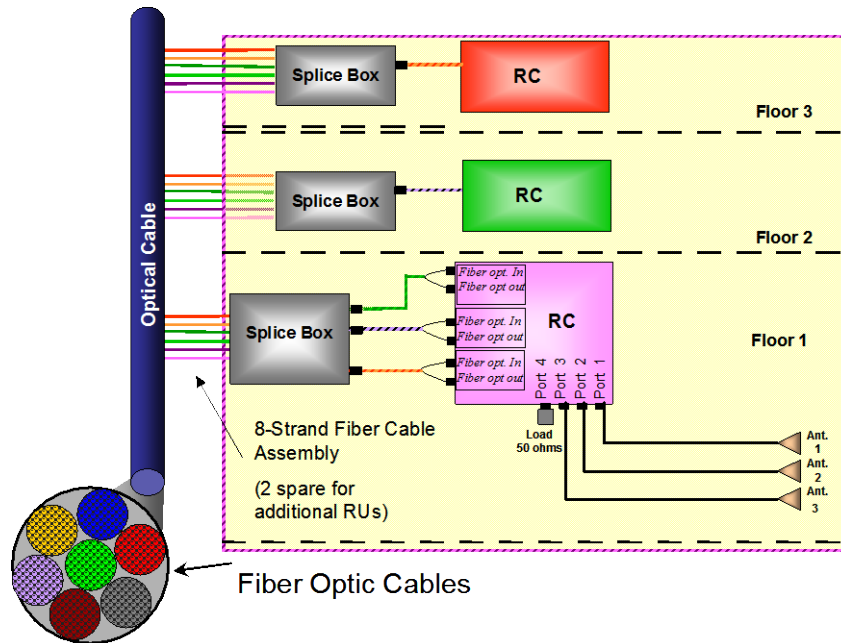

Figure 4-1. Illustration of Fiber Optic Routing

- **For remote power supply configuration** - cable bundles are routed from the main communication room and individual wire pairs are terminated into the power feed of individual units.

By providing power from a single distribution point, maintenance can be reduced and UPS backup can be easily provided. The maximum distance from the source to the termination spot is 1000 feet using 18 gauge wires.

In many locations local codes do not require power to be run through conduit if 100 watts or less is used. Please consult the regulations in your local jurisdiction prior to deploying remote power. When power cables require distances greater than 1000 feet 14 or 16 gauge wire may be used.

- **On each floor** - the antennas are connected to the Remote Cabinet or MA2000-Lite system using coax cables.