



Hermon Laboratories Ltd.
Harakevet Industrial Zone, Binyamina 30500,
Israel
Tel. +972-4-6288001
Fax. +972-4-6288277
E-mail: mail@hermonlabs.com

TEST REPORT

ACCORDING TO: FCC 47CFR part 27

FOR:

**Corning Optical Communication Wireless
HX-4 MIMO Remote Unit
Model: HX-4 MIMO
FCC ID:OJFHXCPL70MAM**

This report is in conformity with ISO/ IEC 17025. The "A2LA Accredited" symbol endorsement applies only to the tests and calibrations that are listed in the scope of Hermon Laboratories accreditation. The test results relate only to the items tested. This test report shall not be reproduced in any form except in full with the written approval of Hermon Laboratories Ltd.

Table of contents

1	Applicant information.....	3
2	Equipment under test attributes	3
3	Manufacturer information	3
4	Test details.....	3
5	Tests summary.....	4
6	EUT description.....	5
6.1	General information.....	5
6.2	Transmitter characteristics	5
7	Transmitter tests according to 47CFR part 27.....	6
7.1	AGC Threshold level test	6
7.2	Occupied bandwidth test.....	12
7.3	Mean output power and booster gain test	17
7.4	Out-of-band rejection test.....	45
7.5	Out-of-band emissions at RF connector test.....	48
7.6	Spurious emissions at RF antenna connector test.....	62
7.7	Radiated spurious emission measurements.....	85
8	APPENDIX A Test equipment and ancillaries used for tests.....	99
9	APPENDIX B Measurement uncertainties.....	100
10	APPENDIX C Test facility description	101
11	APPENDIX D Specification references	101
12	APPENDIX E Test equipment correction factors.....	102
13	APPENDIX F Abbreviations and acronyms.....	113

1 Applicant information

Client name: Corning Optical Communication Wireless
Address: 13221 Woodland Park Rd Suite 400, VA, USA
Telephone: +001 (703) 714-7920
Fax: +001 (703) 848-0280
E-mail: riazih@corning.com
Contact name: Mr. Habib Riazi

2 Equipment under test attributes

Product name: HX-4 MIMO remote unit
Product type: Mid-Power Remote Unit
Model(s): HX-4 MIMO
Part number: KHW_3R5BT40A
Serial number: KRWH14050142
Software release: 7.4
Receipt date: 12-Sep-16

3 Manufacturer information

Manufacturer name: Corning Optical Communication Wireless
Address: 13221 Woodland Park Rd Suite 400, VA, USA
Telephone: +001 (703) 714-7920
Fax: +001 (703) 848-0280
E-Mail: riazih@corning.com
Contact name: Mr. Habib Riazi

4 Test details



Project ID: 28707
Location: Hermon Laboratories Ltd. Harakevet Industrial Zone, Binyamina 30500, Israel
Test started: 15-Sep-16
Test completed: 31-Oct-16
Test specification(s): FCC 47CFR part 27

5 Tests summary

Test	Status
Transmitter characteristics	
Section 27.50, Automatic gain control (AGC) threshold	Pass
Section 2.1049, Occupied bandwidth	Pass
Section 27.50(d), Mean output power and booster gain	Pass
Section 2.1049, Out-of-band rejection	Pass
Section 27.53, Out-of-band emissions at RF connector	Pass
Section 27.53, Conducted spurious emissions	Pass
Section 27.53, Radiated spurious emissions	Pass
Section 27.52, RF exposure	Pass, exhibit provided in Application for certification

Testing was completed against all relevant requirements of the test standard. The results obtained indicate that the product under test complies in full with the requirements tested.

The test results relate only to the items tested. Pass/ fail decision was based on nominal values.

	Name and Title	Date	Signature
Tested by:	Mr. S. Samokha, test engineer	October 31, 2016	
Reviewed by:	Mrs. M. Cherniavsky, certification engineer	November 14, 2016	
Approved by:	Mr. M. Nikishin, EMC and Radio group manager	December 5, 2016	



6 EUT description

6.1 General information

The EUT is a mid-power remote unit of industrial booster MA2000.

6.2 Transmitter characteristics

Type of equipment					
V	Stand-alone (Equipment with or without its own control provisions)				
	Combined equipment (Equipment where the radio part is fully integrated within another type of equipment)				
	Plug-in card (Equipment intended for a variety of host systems)				
Intended use		Condition of use			
V	fixed	Always at a distance more than 2 m from all people			
	mobile	Always at a distance more than 20 cm from all people			
	portable	May operate at a distance closer than 20 cm to human body			
Assigned frequency range		2110.0 – 2180.0 MHz			
Operating frequency		2110.0 – 2180.0 MHz DL 1710-1780 MHz UL			
Maximum rated output power		At maximum gain, output port	33 dBm		
		Aggregate power from two RF chains	36.55 dBm		
Is transmitter output power variable?		No			
		V	Yes	continuous variable	
				stepped variable with stepsize	1 dB
				minimum RF power	NA
		maximum RF power at antenna connector	33 dBm		
Antenna connection					
unique coupling	V	standard connector	Integral		
			with temporary RF connector without temporary RF connector		
Antenna/s technical characteristics					
Type	Manufacturer	Model number	Gain		
External	Any	Any	12.5 dBi		
Transmitter aggregate data rate/s, MBps					
Transmitter 99% power bandwidth		Type of modulation			
		AWGN	GSM	WCDMA	
		NA	NA	NA	
Transmitter power source					
		Nominal rated voltage	Battery type		
V	DC	Nominal rated voltage	48 VDC		
	AC mains	Nominal rated voltage	Frequency		
Common power source for transmitter and receiver		V	yes	no	



Test specification: Section 27.50, AGC threshold test			
Test procedure: KDB 935210 D05 v01r01, section 3			
Test mode: Compliance		Verdict: PASS	
Date(s): 15-Sep-16			
Temperature: 27 °C	Relative Humidity: 47 %	Air Pressure: 1009 hPa	Power: 48 VDC
Remarks:			

7 Transmitter tests according to 47CFR part 27

7.1 AGC Threshold level test

7.1.1 General

This test was performed to measure the AGC threshold of the EUT.

7.1.2 Test procedure

7.1.2.1 The EUT was set up as shown in Figure 7.1.1, energized and its proper operation was checked.

7.1.2.2 The signal generator output was raised until 1 dB increase in the input signal power no longer caused a 1 dB increase in the output power.

7.1.2.3 The mean input and output power was measured with spectrum analyzer as provided in Table 7.1.2.

7.1.2.4 The test results are provided in the table below and the associated plots.

Figure 7.1.1 AGC Threshold level test setup

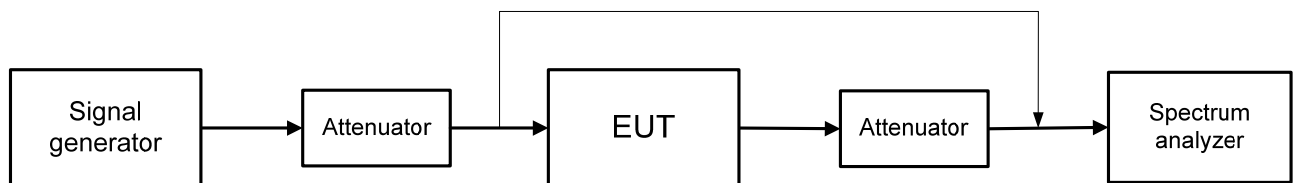



Test specification: Section 27.50, AGC threshold test			
Test procedure: KDB 935210 D05 v01r01, section 3			
Test mode: Compliance		Verdict: PASS	
Date(s): 15-Sep-16			
Temperature: 27 °C	Relative Humidity: 47 %	Air Pressure: 1009 hPa	Power: 48 VDC
Remarks:			

Table 7.1.1 AGC Threshold level test results

ASSIGNED FREQUENCY RANGE: 2110 – 2180 MHz
DETECTOR USED: Average
MODULATING SIGNAL: PRBS
MEASUREMENT METHOD: Spectrum Analyzer

CONFIGURATION: Downlink transmit mode Chain 1

Frequency, MHz	Input level, dBm	SA reading, dBm	AGC threshold level, dBm	Margin*, dB	Verdict
MODULATING SIGNAL: AWGN					
2145.0	-21.53	33.18	-21.53	NA	Pass
MODULATING SIGNAL: GSM					
2145.0	-21.29	33.12	-21.29	NA	Pass
MODULATING SIGNAL: WCDMA					
2145.0	-21.25	32.60	-21.25	NA	Pass

ASSIGNED FREQUENCY RANGE: 2110 – 2180 MHz
DETECTOR USED: Average
MODULATING SIGNAL: PRBS
MEASUREMENT METHOD: Spectrum Analyzer

CONFIGURATION: Downlink transmit mode Chain 2

Frequency, MHz	Input level, dBm	SA reading, dBm	AGC threshold level, dBm	Margin*, dB	Verdict
MODULATING SIGNAL: AWGN					
2145.0	-20.76	33.15	-20.76	NA	Pass
MODULATING SIGNAL: GSM					
2145.0	-20.53	33.36	-20.53	NA	Pass
MODULATING SIGNAL: WCDMA					
2145.0	-20.53	33.47	-20.53	NA	Pass

Reference numbers of test equipment used

HL 2909	HL 3433	HL 3787	HL 3788	HL 3901	HL 4354		
---------	---------	---------	---------	---------	---------	--	--

Full description is given in Appendix A.



HERMON LABORATORIES

Test specification: Section 27.50, AGC threshold test			
Test procedure: KDB 935210 D05 v01r01, section 3			
Test mode: Compliance	Verdict: PASS		
Date(s): 15-Sep-16			
Temperature: 27 °C	Relative Humidity: 47 %	Air Pressure: 1009 hPa	Power: 48 VDC
Remarks:			

Plot 7.1.1 AGC Threshold test results at mid frequency carrier

FREQUENCY RANGE:
OPERATIONAL MODE:
CONFIGURATION:
INPUT SIGNAL

2110.0 – 2180.0 MHz
AWGN downlink transmit
Chain 1
OUTPUT SIGNAL

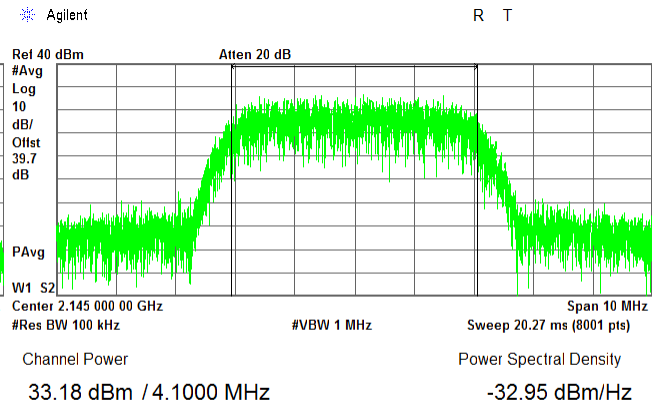
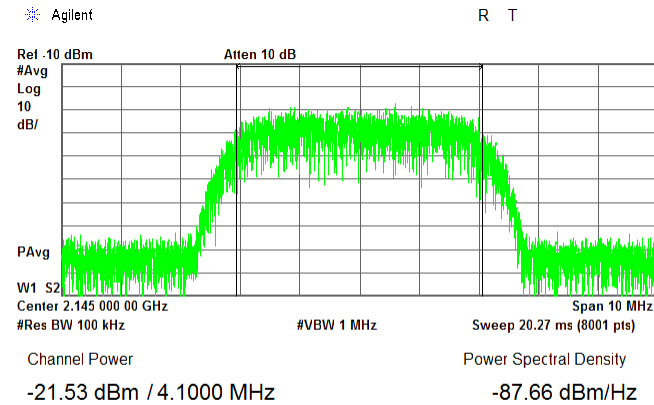

Plot 7.1.2 AGC Threshold test results at mid frequency carrier

FREQUENCY RANGE:
OPERATIONAL MODE:
CONFIGURATION:
INPUT SIGNAL

2110.0 – 2180.0 MHz
GSM downlink transmit
Chain 1
OUTPUT SIGNAL

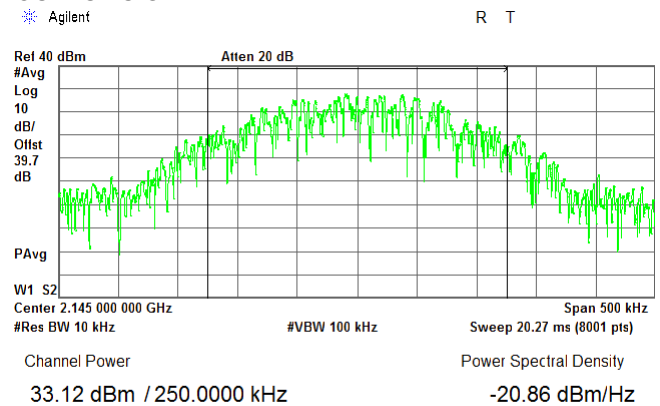
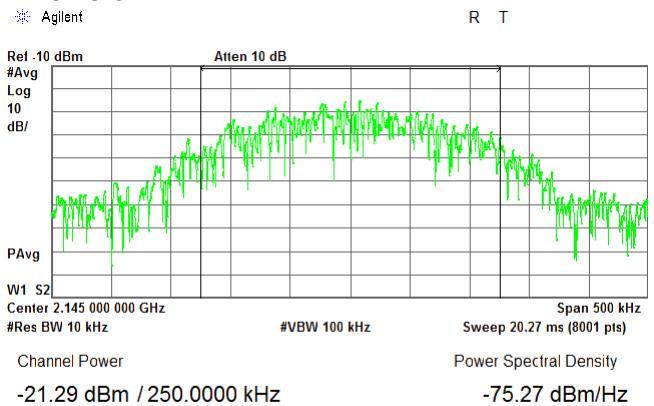



HERMON LABORATORIES

Test specification: Section 27.50, AGC threshold test			
Test procedure: KDB 935210 D05 v01r01, section 3			
Test mode: Compliance		Verdict: PASS	
Date(s): 15-Sep-16			
Temperature: 27 °C	Relative Humidity: 47 %	Air Pressure: 1009 hPa	Power: 48 VDC
Remarks:			

Plot 7.1.3 AGC Threshold test results at mid frequency carrier

FREQUENCY RANGE:
OPERATIONAL MODE:
CONFIGURATION:
INPUT SIGNAL

2110.0 – 2180.0 MHz
WCDMA downlink transmit
Chain 1
OUTPUT SIGNAL

* Agilent

R T

* Agilent

R T

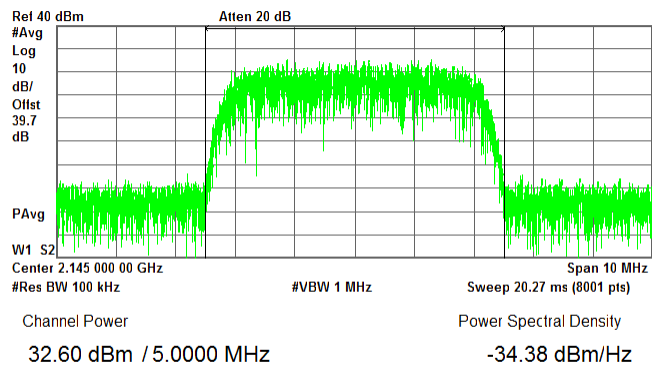
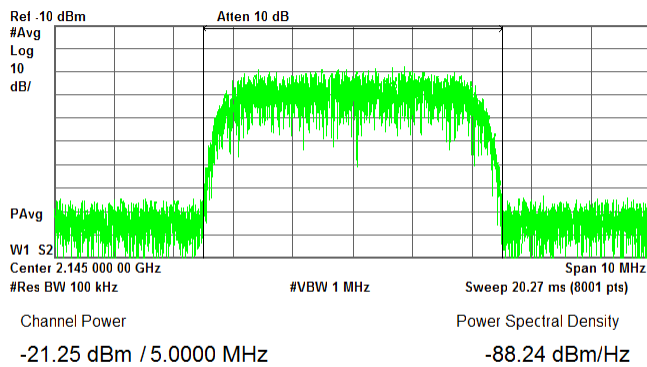



HERMON LABORATORIES

Test specification: Section 27.50, AGC threshold test			
Test procedure: KDB 935210 D05 v01r01, section 3			
Test mode: Compliance		Verdict: PASS	
Date(s): 15-Sep-16			
Temperature: 27 °C	Relative Humidity: 47 %	Air Pressure: 1009 hPa	Power: 48 VDC
Remarks:			

Plot 7.1.4 AGC Threshold test results at mid frequency carrier

FREQUENCY RANGE:
OPERATIONAL MODE:
CONFIGURATION:
INPUT SIGNAL

2110.0 – 2180.0 MHz
AWGN downlink transmit
Chain 2
OUTPUT SIGNAL

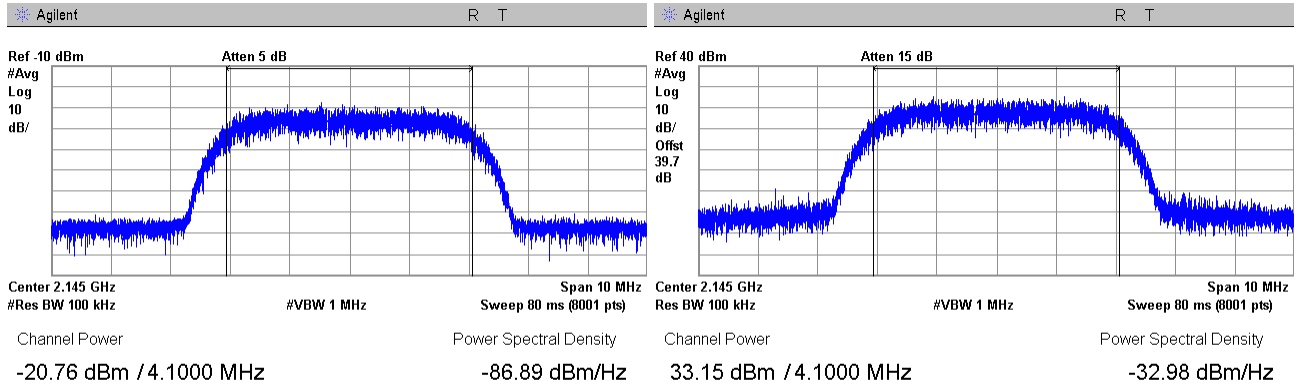

Plot 7.1.5 AGC Threshold test results at mid frequency carrier

FREQUENCY RANGE:
OPERATIONAL MODE:
CONFIGURATION:
INPUT SIGNAL

2110.0 – 2180.0 MHz
GSM downlink transmit
Chain 2
OUTPUT SIGNAL

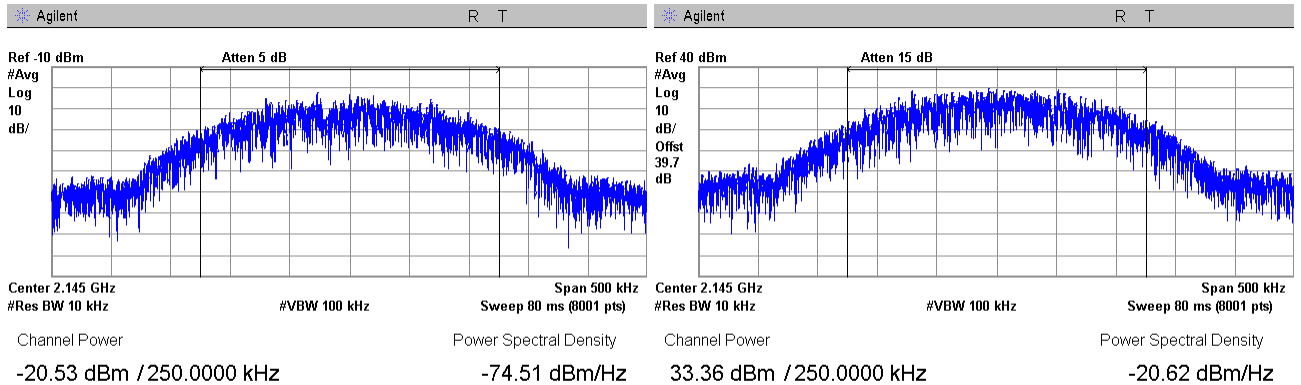



HERMON LABORATORIES

Test specification: Section 27.50, AGC threshold test			
Test procedure: KDB 935210 D05 v01r01, section 3			
Test mode: Compliance		Verdict: PASS	
Date(s): 15-Sep-16			
Temperature: 27 °C	Relative Humidity: 47 %	Air Pressure: 1009 hPa	Power: 48 VDC
Remarks:			

Plot 7.1.6 AGC Threshold test results at mid frequency carrier

FREQUENCY RANGE:	2110.0 – 2180.0 MHz
OPERATIONAL MODE:	WCDMA downlink transmit
CONFIGURATION:	Chain 2
INPUT SIGNAL	OUTPUT SIGNAL

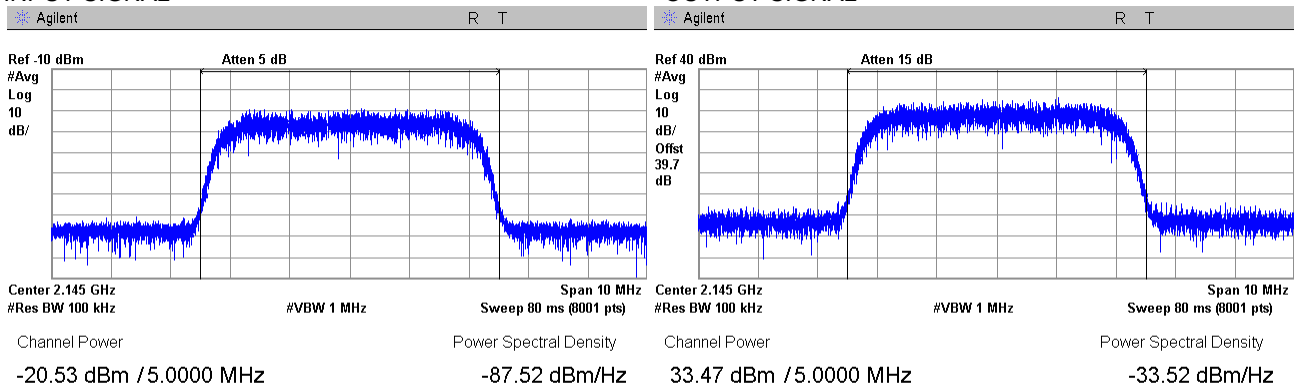



Test specification: Section 2.1049, Occupied bandwidth			
Test procedure: KDB 935210 D05 v01r01, section 3.4			
Test mode: Compliance		Verdict: PASS	
Date(s): 27-Sep-16			
Temperature: 28 °C	Relative Humidity: 43 %	Air Pressure: 1012 hPa	Power: 48 VDC
Remarks:			

7.2 Occupied bandwidth test

7.2.1 General

This test was performed to measure transmitter occupied bandwidth. Specification test limits are given in Table 7.2.1.

Table 7.2.1 Occupied bandwidth limits

Assigned frequency, MHz	Modulation envelope reference points, %	Maximum allowed bandwidth, kHz
2110.0 – 2180.0	99	NA

7.2.2 Test procedure

7.2.2.1 The EUT was set up as shown in Figure 7.2.1, energized and its proper operation was checked.

7.2.2.2 The EUT was set to transmit the normally modulated carrier.

7.2.2.3 The transmitter occupied bandwidth was measured with power bandwidth function of the spectrum analyzer as a frequency delta between the reference points on modulation envelope and provided in Table 7.2.2 and the associated plots.

Figure 7.2.1 Occupied bandwidth test setup





Test specification: Section 2.1049, Occupied bandwidth			
Test procedure: KDB 935210 D05 v01r01, section 3.4			
Test mode: Compliance		Verdict: PASS	
Date(s): 27-Sep-16			
Temperature: 28 °C	Relative Humidity: 43 %	Air Pressure: 1012 hPa	Power: 48 VDC
Remarks:			

Table 7.2.2 Occupied bandwidth test results

DETECTOR USED: Peak hold
MODULATION ENVELOPE REFERENCE POINTS: 99%

RESOLUTION BANDWIDTH: 100 kHz (0.5-2% of OBW)
VIDEO BANDWIDTH: 1000 kHz

Carrier frequency, MHz	99% Occupied bandwidth, kHz		Limit, kHz	Margin, kHz	Verdict
	Below AGC	Above AGC			
MODULATION: AWGN					
2145.0	4160.1	4147.1	NA	NA	Pass
MODULATION: WCDMA					
2145.0	4193.7	4194.9	NA	NA	Pass

RESOLUTION BANDWIDTH: 3 kHz (0.5-2% of OBW)
VIDEO BANDWIDTH: 30 kHz

Carrier frequency, MHz	Occupied bandwidth, kHz		Limit, kHz	Margin, kHz	Verdict
	Below AGC	Above AGC			
MODULATION: GSM					
2145.0	244.991	245.709	NA	NA	Pass

Reference numbers of test equipment used

HL 2909	HL 3433	HL 3787	HL 3788	HL 3901	HL 4354		
---------	---------	---------	---------	---------	---------	--	--

Full description is given in Appendix A.



HERMON LABORATORIES

Test specification: Section 2.1049, Occupied bandwidth			
Test procedure: KDB 935210 D05 v01r01, section 3.4			
Test mode: Compliance		Verdict: PASS	
Date(s): 27-Sep-16			
Temperature: 28 °C	Relative Humidity: 43 %	Air Pressure: 1012 hPa	Power: 48 VDC
Remarks:			

Plot 7.2.1 Occupied bandwidth test result at mid frequency carrier

FREQUENCY RANGE:
OPERATIONAL MODE:
CONFIGURATION:
INPUT SIGNAL

2110.0 – 2180.0 MHz
AWGN uplink transmit
Below AGC threshold
OUTPUT SIGNAL

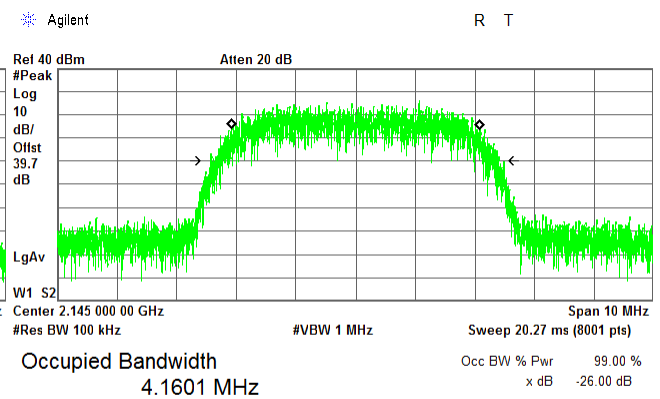
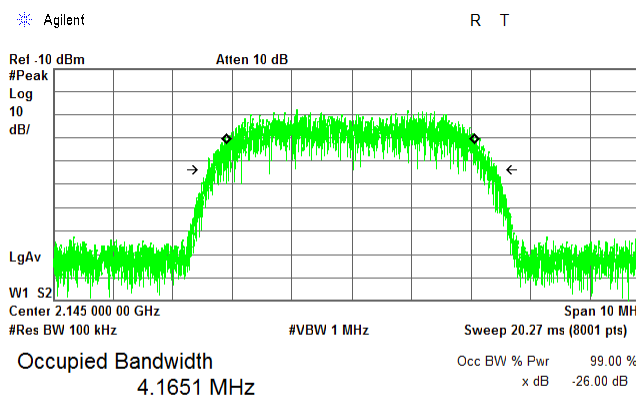

Transmit Freq Error -7.012 kHz
Occupied Bandwidth 4.820 MHz*

CONFIGURATION:
INPUT SIGNAL

Transmit Freq Error -7.769 kHz
Occupied Bandwidth 4.826 MHz*

Above AGC threshold +3 dB
OUTPUT SIGNAL

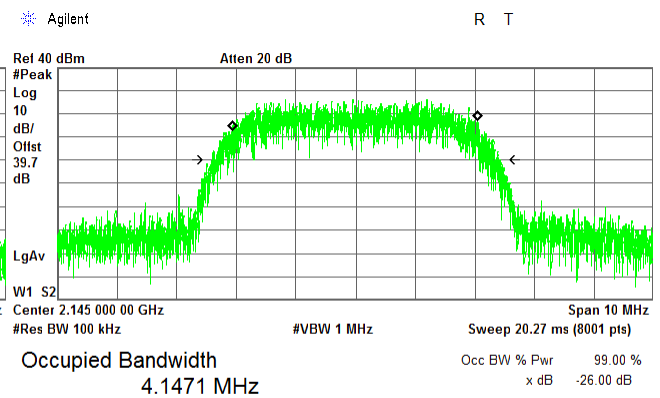
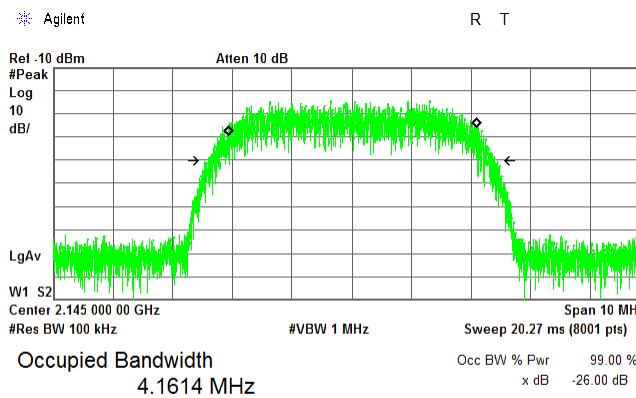

Transmit Freq Error 2.053 kHz
Occupied Bandwidth 4.825 MHz*

Transmit Freq Error -3.017 kHz
Occupied Bandwidth 4.817 MHz*



HERMON LABORATORIES

Test specification: Section 2.1049, Occupied bandwidth			
Test procedure: KDB 935210 D05 v01r01, section 3.4			
Test mode: Compliance		Verdict: PASS	
Date(s): 27-Sep-16			
Temperature: 28 °C	Relative Humidity: 43 %	Air Pressure: 1012 hPa	Power: 48 VDC
Remarks:			

Plot 7.2.2 Occupied bandwidth test result at mid frequency carrier

FREQUENCY RANGE:
OPERATIONAL MODE:
CONFIGURATION:
INPUT SIGNAL

2110.0 – 2180.0 MHz
GSM uplink transmit
Single Channel
OUTPUT SIGNAL

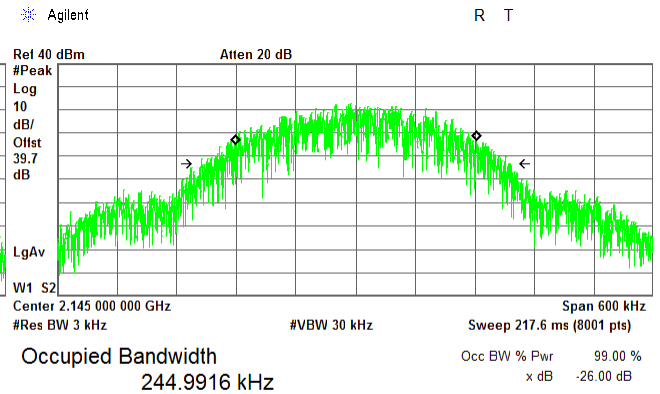
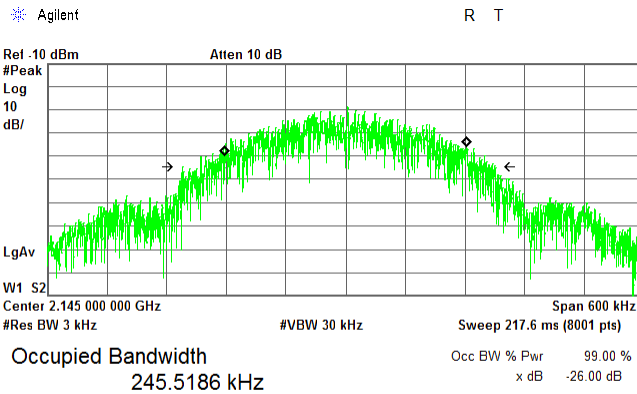

Transmit Freq Error -307.200 Hz
Occupied Bandwidth 308.536 kHz*

Transmit Freq Error 639.887 Hz
Occupied Bandwidth 302.314 kHz*

CONFIGURATION:
INPUT SIGNAL

Single Channel
OUTPUT SIGNAL

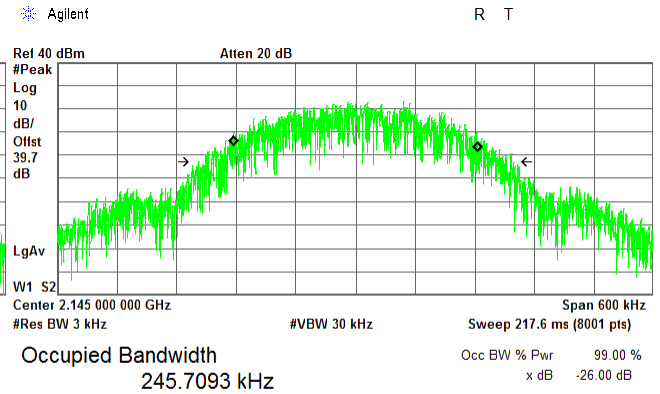
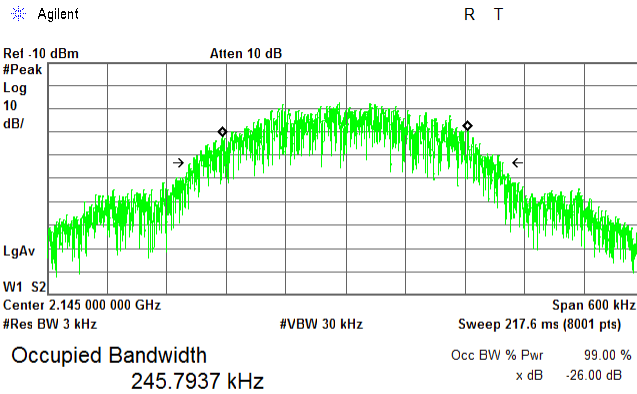

Transmit Freq Error -139.522 Hz
Occupied Bandwidth 307.101 kHz*

Transmit Freq Error -561.501 Hz
Occupied Bandwidth 305.005 kHz*



HERMON LABORATORIES

Test specification: Section 2.1049, Occupied bandwidth			
Test procedure: KDB 935210 D05 v01r01, section 3.4			
Test mode: Compliance		Verdict: PASS	
Date(s): 27-Sep-16			
Temperature: 28 °C	Relative Humidity: 43 %	Air Pressure: 1012 hPa	Power: 48 VDC
Remarks:			

Plot 7.2.3 Occupied bandwidth test result at mid frequency carrier

FREQUENCY RANGE:
OPERATIONAL MODE:
CONFIGURATION:
INPUT SIGNAL

2110.0 – 2180.0 MHz
WCDMA uplink transmit
Below AGC threshold
OUTPUT SIGNAL

Agilent

R T

Agilent

R T

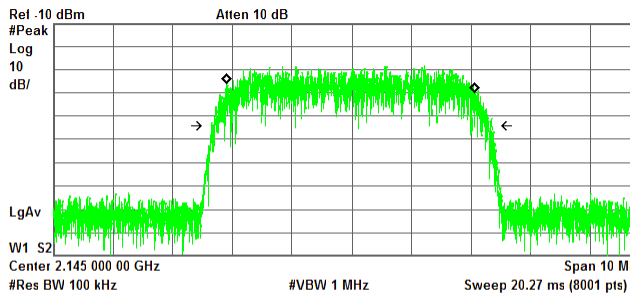

Occupied Bandwidth
4.1782 MHz

Occ BW % Pwr 99.00 %
x dB -26.00 dB

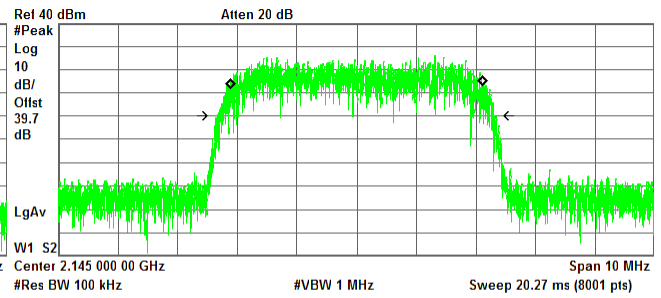

Occupied Bandwidth
4.1937 MHz

Occ BW % Pwr 99.00 %
x dB -26.00 dB

Transmit Freq Error -3.783 kHz
Occupied Bandwidth 4.651 MHz*

Transmit Freq Error 3.558 kHz
Occupied Bandwidth 4.652 MHz*

CONFIGURATION:
INPUT SIGNAL

Above AGC threshold +3 dB
OUTPUT SIGNAL

Agilent

R T

Agilent

R T

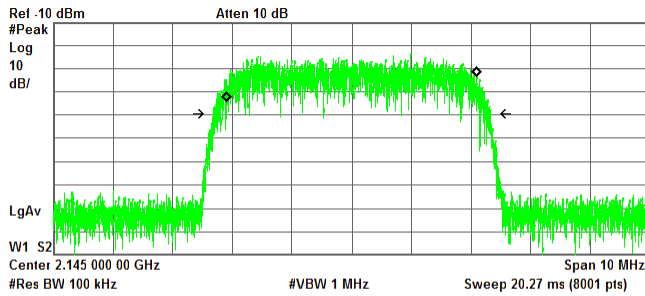

Occupied Bandwidth
4.1893 MHz

Occ BW % Pwr 99.00 %
x dB -26.00 dB

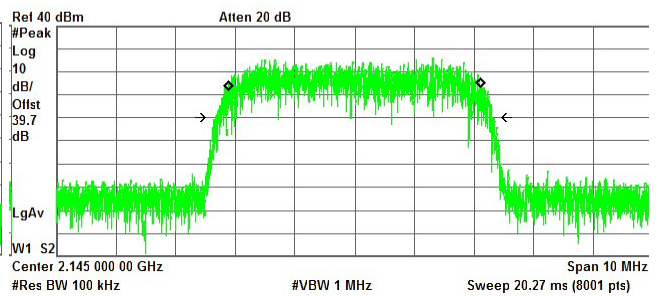

Occupied Bandwidth
4.1949 MHz

Occ BW % Pwr 99.00 %
x dB -26.00 dB

Transmit Freq Error 444.393 Hz
Occupied Bandwidth 4.643 MHz*

Transmit Freq Error 3.558 kHz
Occupied Bandwidth 4.652 MHz*



Test specification: Section 27.50(d), Mean input and output power and booster gain test			
Test procedure: KDB 935210 D05 v01r01, section 3.5			
Test mode: Compliance		Verdict: PASS	
Date(s): 27-Sep-16			
Temperature: 28 °C	Relative Humidity: 43 %	Air Pressure: 1012 hPa	Power: 48 VDC
Remarks:			

7.3 Mean nput and output power and booster gain test

7.3.1 General

This test was performed to measure the mean input and output power at RF antenna connector and to calculate corresponding EUT gain. Specification test limits are given in Table 7.3.1.

Table 7.3.1 Mean output power and booster gain test limits

Transmitter type	Assigned frequency range, MHz	Maximum peak output power, ERP	
		W	dBm
Base and fixed stations	2110 – 2180	1640.0	62.4

Assigned frequency range, MHz	Tested frequency range	Maximum allowed Gain versus frequency response, dB
2110.0 – 2180.0	$F_0 \pm 250\% BW$	Output power (dBm) – input power (dBm)

7.3.2 Test procedure

- 7.3.2.1 The EUT was set up as shown in Figure 7.3.1, energized and its proper operation was checked.
- 7.3.2.2 The signal generator power was adjusted to a level just below the AGC threshold but not more than 0.5 dB below.
- 7.3.2.3 The mean output power was measured with the spectrum analyzer as provided in Table 7.3.2, Table 7.3.3 and the associated plots.
- 7.3.2.4 The corresponding input power was measured with the same settings of the spectrum analyzer.
- 7.3.2.5 The above measurements were repeated with input signal adjusted to be 3 dB above the AGC threshold.
- 7.3.2.6 The EUT gain was calculated as a difference between output and input signal levels.

Figure 7.3.1 Mean output power and booster gain test test setup

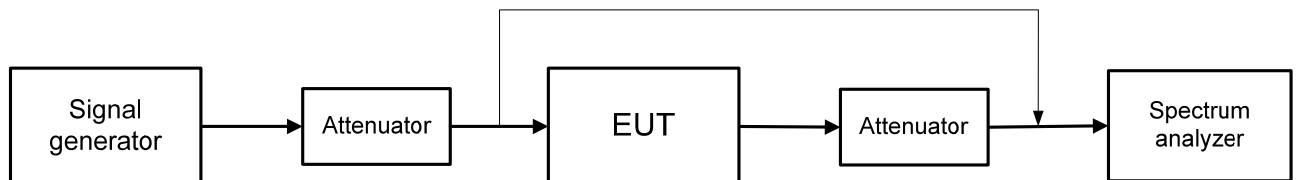



Test specification: Section 27.50(d), Mean input and output power and booster gain test			
Test procedure: KDB 935210 D05 v01r01, section 3.5			
Test mode: Compliance		Verdict: PASS	
Date(s): 27-Sep-16			
Temperature: 28 °C	Relative Humidity: 43 %	Air Pressure: 1012 hPa	Power: 48 VDC
Remarks:			

Table 7.3.2 Mean output power and booster gain test results, Chain 1

ASSIGNED FREQUENCY RANGE: 2110.0 – 2180.0 MHz
 DETECTOR USED: Average
 MODULATING SIGNAL: PRBS
 TRANSMITTER OUTPUT POWER SETTINGS: Maximum

Carrier frequency, MHz	Input signal	SA reading, dBm		Booster gain**, dB	Antenna gain, dBi	EIRP***, dBm	Limit, dBm	Margin*, dB	Verdict
		Input	Output						
MODULATION: AWGN									
2133.5	Below AGC	-20.93	33.07	54.00	12.50	45.57	62.40	-16.83	Pass
	Above AGC	-16.71	33.27	49.98	12.50	45.77	62.40	-16.63	Pass
2112.5	Below AGC	-20.92	33.00	53.92	12.50	45.50	62.40	-16.90	Pass
	Above AGC	-16.92	33.24	50.16	12.50	45.74	62.40	-16.66	Pass
2145.0	Below AGC	-21.53	33.18	54.71	12.50	45.68	62.40	-16.72	Pass
	Above AGC	-17.40	33.26	50.66	12.50	45.76	62.40	-16.64	Pass
2177.5	Below AGC	-19.75	33.41	53.16	12.50	45.91	62.40	-16.49	Pass
	Above AGC	-15.77	33.61	49.38	12.50	46.11	62.40	-16.29	Pass
MODULATION: GSM									
2133.5	Below AGC	-22.00	33.25	55.25	12.50	45.75	62.40	-16.65	Pass
	Above AGC	-18.13	33.44	51.57	12.50	45.94	62.40	-16.46	Pass
2110.0	Below AGC	-20.38	32.53	52.91	12.50	45.03	62.40	-17.37	Pass
	Above AGC	-16.54	33.29	49.83	12.50	45.79	62.40	-16.61	Pass
2145.0	Below AGC	-21.29	33.12	54.41	12.50	45.62	62.40	-16.78	Pass
	Above AGC	-17.00	33.15	50.15	12.50	45.65	62.40	-16.75	Pass
2180.0	Below AGC	-19.75	33.25	53.00	12.50	45.75	62.40	-16.65	Pass
	Above AGC	-15.80	33.34	49.14	12.50	45.84	62.40	-16.56	Pass
MODULATION: WCDMA									
2133.5	Below AGC	-21.63	33.21	54.84	12.50	45.71	62.40	-16.69	Pass
	Above AGC	-17.78	33.39	51.17	12.50	45.89	62.40	-16.51	Pass
2112.5	Below AGC	-19.42	32.38	51.80	12.50	44.88	62.40	-17.52	Pass
	Above AGC	-15.48	32.39	47.87	12.50	44.89	62.40	-17.51	Pass
2145.0	Below AGC	-21.25	32.60	53.85	12.50	45.10	62.40	-17.30	Pass
	Above AGC	-17.14	32.61	49.75	12.50	45.11	62.40	-17.29	Pass
2177.5	Below AGC	-19.39	33.04	52.43	12.50	45.54	62.40	-16.86	Pass
	Above AGC	-15.42	33.22	48.64	12.50	45.72	62.40	-16.68	Pass

* - Margin, dB = Limit EIRP, dBm - RF output power EIRP*, dBm
 ** - Booster Gain = Output SA reading – Input SA reading
 *** - EIRP, dBm = SA reading average, dBm + Antenna gain, dBi



Test specification: Section 27.50(d), Mean input and output power and booster gain test			
Test procedure: KDB 935210 D05 v01r01, section 3.5			
Test mode: Compliance		Verdict: PASS	
Date(s): 27-Sep-16			
Temperature: 28 °C	Relative Humidity: 43 %	Air Pressure: 1012 hPa	Power: 48 VDC
Remarks:			

Table 7.3.3 Mean output power and booster gain test results, Chain 2

ASSIGNED FREQUENCY RANGE: 2110.0 – 2180.0 MHz
 DETECTOR USED: Average
 MODULATING SIGNAL: PRBS
 TRANSMITTER OUTPUT POWER SETTINGS: Maximum

Carrier frequency, MHz	Input signal	SA reading, dBm		Booster gain**, dB	Antenna gain, dBi	EIRP,*** dBm	Limit, dBm	Margin*, dB	Verdict
		Input	Output						
MODULATION: AWGN									
2113.0	Below AGC	-20.86	32.98	53.84	12.50	45.48	62.40	-16.92	Pass
	Above AGC	-16.91	32.82	49.73	12.50	45.32	62.40	-17.08	Pass
2112.5	Below AGC	-21.49	32.95	54.44	12.50	45.45	62.40	-16.95	Pass
	Above AGC	-17.56	33.03	50.59	12.50	45.53	62.40	-16.87	Pass
2145.0	Below AGC	-20.76	33.15	53.91	12.50	45.65	62.40	-16.75	Pass
	Above AGC	-16.70	33.19	49.89	12.50	45.69	62.40	-16.71	Pass
2177.5	Below AGC	-19.21	33.24	52.45	12.50	45.74	62.40	-16.66	Pass
	Above AGC	-15.09	33.46	48.55	12.50	45.96	62.40	-16.44	Pass
MODULATION: GSM									
2113.0	Below AGC	-21.55	33.22	54.77	12.50	45.72	62.40	-16.68	Pass
	Above AGC	-17.55	33.20	50.75	12.50	45.70	62.40	-16.70	Pass
2110.0	Below AGC	-20.37	32.90	53.27	12.50	45.40	62.40	-17.00	Pass
	Above AGC	-16.23	32.84	49.07	12.50	45.34	62.40	-17.06	Pass
2145.0	Below AGC	-20.53	33.36	53.89	12.50	45.86	62.40	-16.54	Pass
	Above AGC	-16.59	33.15	49.74	12.50	45.65	62.40	-16.75	Pass
2180.0	Below AGC	-18.15	33.43	51.58	12.50	45.93	62.40	-16.47	Pass
	Above AGC	-14.59	33.40	47.99	12.50	45.90	62.40	-16.50	Pass
MODULATION: WCDMA									
2113.0	Below AGC	-20.57	33.12	53.69	12.50	45.62	62.40	-16.78	Pass
	Above AGC	-16.65	33.01	49.66	12.50	45.51	62.40	-16.89	Pass
2112.5	Below AGC	-21.48	33.09	54.57	12.50	45.59	62.40	-16.81	Pass
	Above AGC	-17.46	33.15	50.61	12.50	45.65	62.40	-16.75	Pass
2145.0	Below AGC	-20.53	33.47	54.00	12.50	45.97	62.40	-16.43	Pass
	Above AGC	-16.64	33.46	50.10	12.50	45.96	62.40	-16.44	Pass
2177.5	Below AGC	-18.73	33.70	52.43	12.50	46.20	62.40	-16.20	Pass
	Above AGC	-14.70	33.76	48.46	12.50	46.26	62.40	-16.14	Pass

* - Margin, dB = Limit EIRP, dBm - RF output power EIRP*, dBm
 ** - Booster Gain = Output SA reading – Input SA reading
 *** - EIRP, dBm = SA reading average, dBm + Antenna gain, dBi

Reference numbers of test equipment used

HL 2909	HL 3433	HL 3787	HL 3788	HL 3901	HL 4354		
---------	---------	---------	---------	---------	---------	--	--

Full description is given in Appendix A.



Test specification: Section 27.50(d), Mean input and output power and booster gain test			
Test procedure: KDB 935210 D05 v01r01, section 3.5			
Test mode: Compliance		Verdict: PASS	
Date(s): 27-Sep-16			
Temperature: 28 °C	Relative Humidity: 43 %	Air Pressure: 1012 hPa	Power: 48 VDC
Remarks:			

Table 7.3.4 Mean output power and booster gain test results, Chains 1 and 2

ASSIGNED FREQUENCY RANGE: 2110.0 – 2180.0 MHz
 DETECTOR USED: Average
 MODULATING SIGNAL: PRBS
 TRANSMITTER OUTPUT POWER SETTINGS: Maximum
 NUMBER OF CHAINS: N = 2

MODULATION: AWGN

Carrier frequency, MHz	Input signal	SA reading, dBm		Total power**, dBm	Antenna gain, dBi	EIRP, dBm***	Limit, dBm	Margin *, dB	Verdict
		Chain 1	Chain 2						
2112.5	Below AGC	33.00	32.95	35.99	12.50	48.49	62.4	-13.91	Pass
	Above AGC	33.24	33.03	36.15	12.50	48.65	62.4	-13.75	Pass
2145.0	Below AGC	33.18	33.15	36.18	12.50	48.68	62.4	-13.72	Pass
	Above AGC	33.26	33.19	36.24	12.50	48.75	62.4	-13.65	Pass
2177.5	Below AGC	33.41	33.24	36.34	12.50	48.84	62.4	-13.56	Pass
	Above AGC	33.61	33.46	36.55	12.50	49.06	62.4	-13.34	Pass

MODULATION: GSM

Carrier frequency, MHz	Input signal	SA reading, dBm		Total power**, dBm	Antenna gain, dBi	EIRP, dBm***	Limit, dBm	Margin *, dB	Verdict
		Chain 1	Chain 2						
2110.0	Below AGC	32.53	32.90	35.73	12.50	48.23	62.40	-14.17	Pass
	Above AGC	33.29	32.84	36.08	12.50	48.60	62.40	-13.80	Pass
2145.0	Below AGC	33.12	33.36	36.25	12.50	48.75	62.40	-13.65	Pass
	Above AGC	33.15	33.15	36.16	12.50	48.68	62.40	-13.72	Pass
2180.0	Below AGC	33.25	33.43	36.35	12.50	48.85	62.40	-13.55	Pass
	Above AGC	33.34	33.40	36.38	12.50	48.90	62.40	-13.50	Pass

MODULATION: W-CDMA

Carrier frequency, MHz	Input signal	SA reading, dBm		Total power**, dBm	Antenna gain, dBi	EIRP, dBm***	Limit, dBm	Margin *, dB	Verdict
		Chain 1	Chain 2						
2112.5	Below AGC	32.38	33.09	35.76	12.50	48.26	62.40	-14.14	Pass
	Above AGC	32.39	33.15	35.80	12.50	48.31	62.40	-14.09	Pass
2145.0	Below AGC	32.60	33.47	36.07	12.50	48.57	62.40	-13.83	Pass
	Above AGC	32.61	33.46	36.07	12.50	48.58	62.40	-13.82	Pass
2177.5	Below AGC	33.04	33.70	36.39	12.50	48.89	62.40	-13.51	Pass
	Above AGC	33.22	33.76	36.51	12.50	49.02	62.40	-13.38	Pass

* - Margin, dB = EIRP, dBm - Limit, dBm

** - Total power = 10 log{10^{[(P(dBm,Ant1)/10)] + 10^[(P(dBm,Ant2)/10)]}, dBm}

*** - EIRP, dBm = Total power, dBm + Antenna gain, dBi

Reference numbers of test equipment used

HL 2909	HL 3433	HL 3787	HL 3788	HL 3901	HL 4354		
---------	---------	---------	---------	---------	---------	--	--

Full description is given in Appendix A.



HERMON LABORATORIES

Test specification: Section 27.50(d), Mean input and output power and booster gain test			
Test procedure: KDB 935210 D05 v01r01, section 3.5			
Test mode: Compliance		Verdict: PASS	
Date(s): 27-Sep-16			
Temperature: 28 °C	Relative Humidity: 43 %	Air Pressure: 1012 hPa	Power: 48 VDC
Remarks:			

Plot 7.3.1 Mean output power and booster gain test results at low frequency, Chain1

FRQUENCY RANGE:
OPERATIONAL MODE:
CONFIGURATION:
INPUT SIGNAL

2110 – 2180 MHz
AWGN downlink transmit
Below AGC threshold
OUTPUT SIGNAL

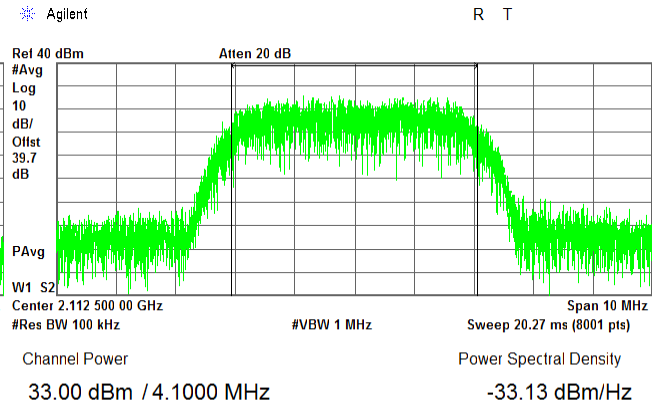
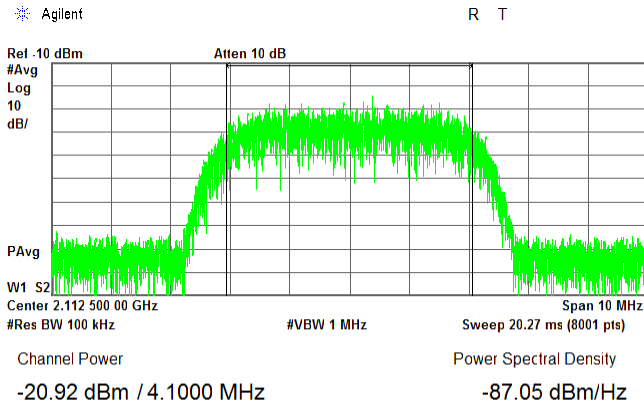

CONFIGURATION:
INPUT SIGNAL

Above AGC threshold +3dB
OUTPUT SIGNAL

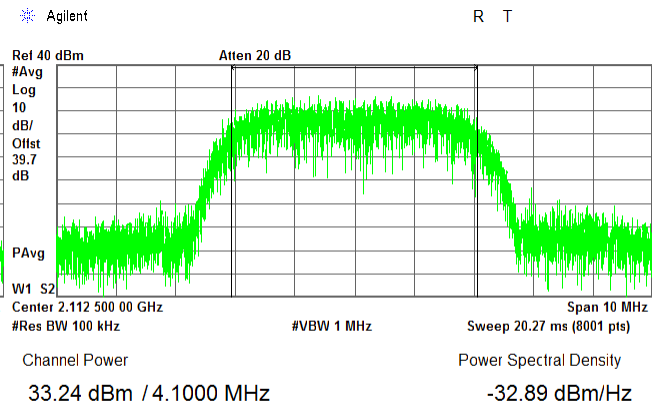
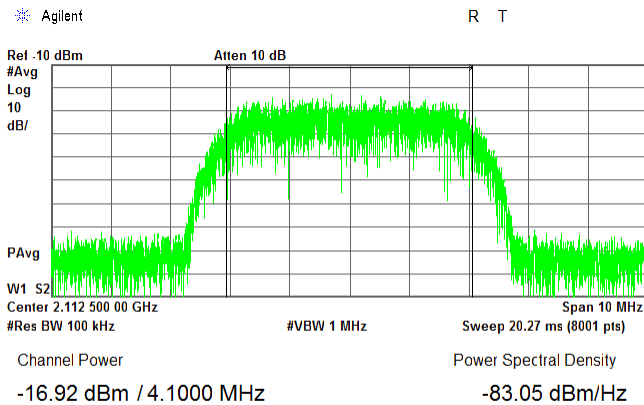



HERMON LABORATORIES

Test specification: Section 27.50(d), Mean input and output power and booster gain test			
Test procedure: KDB 935210 D05 v01r01, section 3.5			
Test mode: Compliance		Verdict: PASS	
Date(s): 27-Sep-16			
Temperature: 28 °C	Relative Humidity: 43 %	Air Pressure: 1012 hPa	Power: 48 VDC
Remarks:			

Plot 7.3.2 Mean output power and booster gain test results at mid frequency, Chain1

FRQUENCY RANGE:
OPERATIONAL MODE:
CONFIGURATION:
INPUT SIGNAL

2110 – 2180 MHz
AWGN downlink transmit
Below AGC threshold
OUTPUT SIGNAL

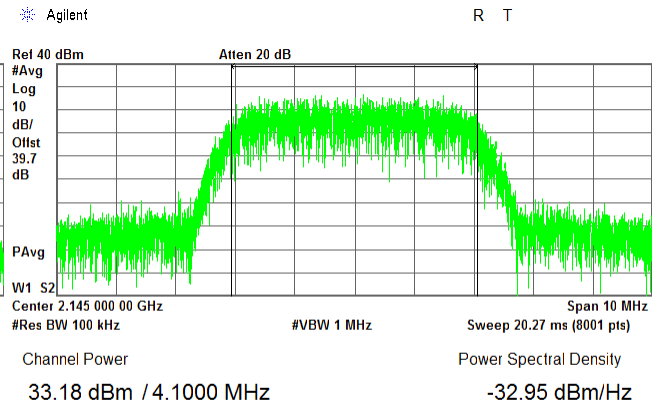
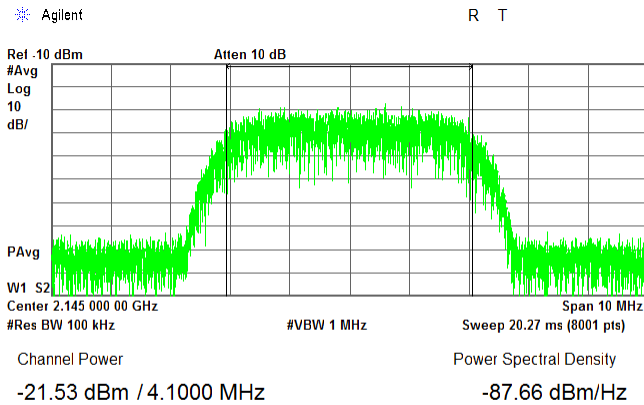

CONFIGURATION:
INPUT SIGNAL

Above AGC threshold +3dB
OUTPUT SIGNAL

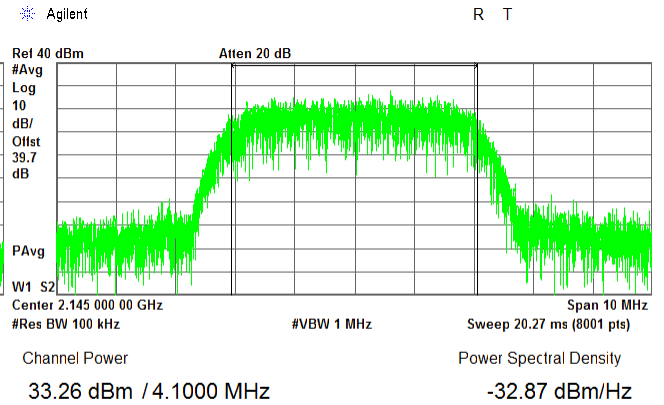
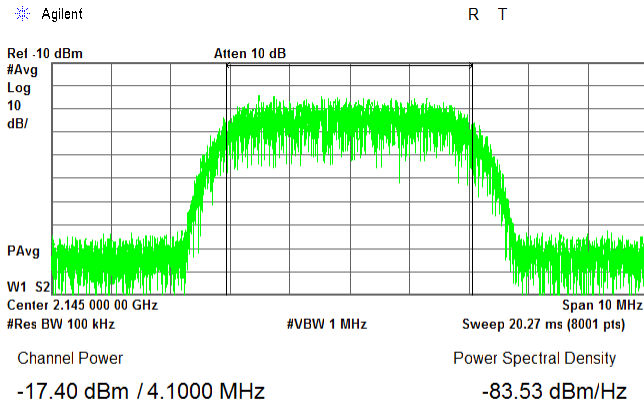



HERMON LABORATORIES

Test specification: Section 27.50(d), Mean input and output power and booster gain test			
Test procedure: KDB 935210 D05 v01r01, section 3.5			
Test mode: Compliance		Verdict: PASS	
Date(s): 27-Sep-16			
Temperature: 28 °C	Relative Humidity: 43 %	Air Pressure: 1012 hPa	Power: 48 VDC
Remarks:			

Plot 7.3.3 Mean output power and booster gain test results at f0 frequency, Chain1

FRQUENCY RANGE:
OPERATIONAL MODE:
CONFIGURATION:
INPUT SIGNAL

2110 – 2180 MHz
AWGN downlink transmit
Below AGC threshold
OUTPUT SIGNAL

Agilent

R T

Agilent

R T

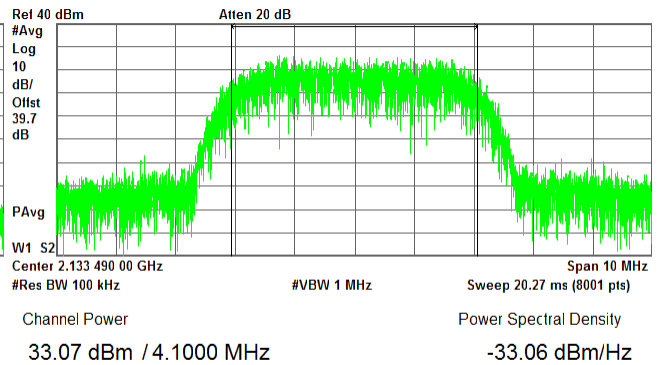
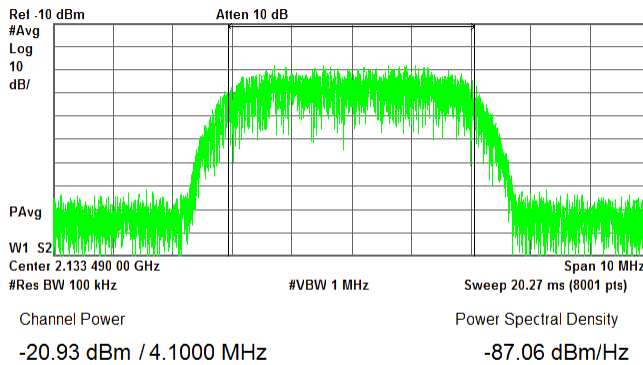

CONFIGURATION:
INPUT SIGNAL

Above AGC threshold +3dB
OUTPUT SIGNAL

Agilent

R T

Agilent

R T

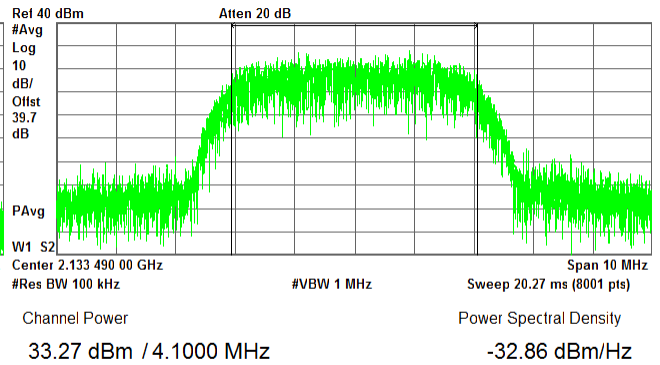
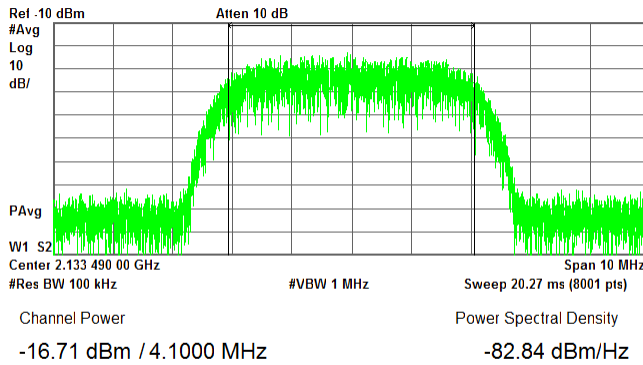



HERMON LABORATORIES

Test specification: Section 27.50(d), Mean input and output power and booster gain test			
Test procedure: KDB 935210 D05 v01r01, section 3.5			
Test mode: Compliance		Verdict: PASS	
Date(s): 27-Sep-16			
Temperature: 28 °C	Relative Humidity: 43 %	Air Pressure: 1012 hPa	Power: 48 VDC
Remarks:			

Plot 7.3.4 Mean output power and booster gain test results at high frequency, Chain1

FRQUENCY RANGE:
OPERATIONAL MODE:
CONFIGURATION:
INPUT SIGNAL

2110 – 2180 MHz
AWGN downlink transmit
Below AGC threshold
OUTPUT SIGNAL

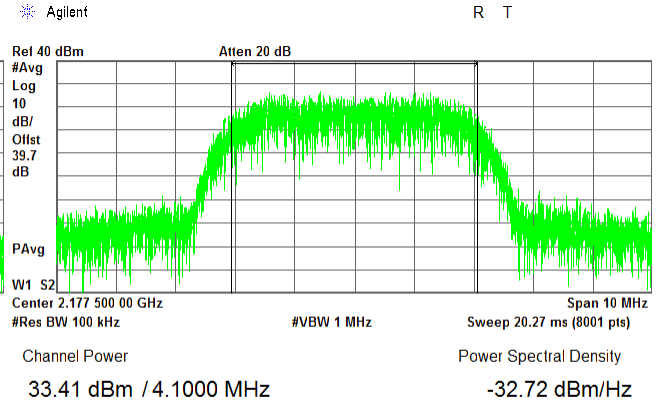
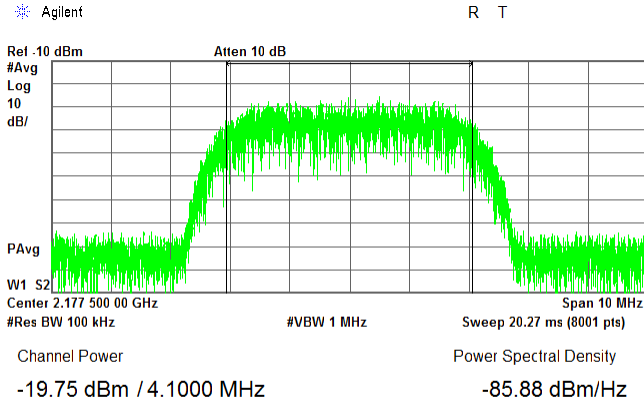

CONFIGURATION:
INPUT SIGNAL

Above AGC threshold +3dB
OUTPUT SIGNAL

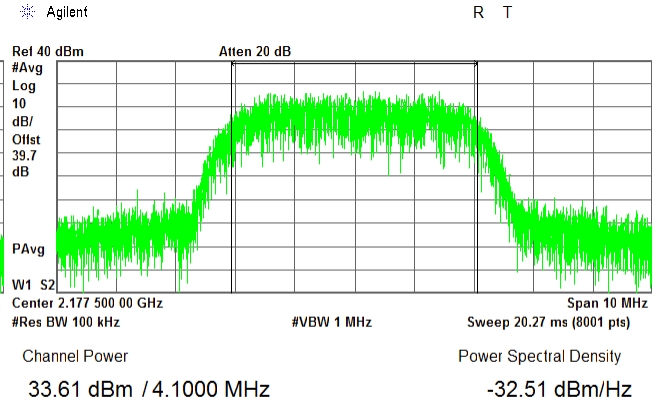
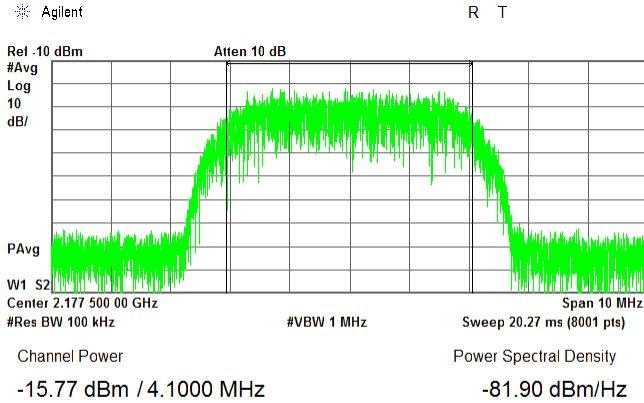



HERMON LABORATORIES

Test specification: Section 27.50(d), Mean input and output power and booster gain test			
Test procedure: KDB 935210 D05 v01r01, section 3.5			
Test mode: Compliance		Verdict: PASS	
Date(s): 27-Sep-16			
Temperature: 28 °C	Relative Humidity: 43 %	Air Pressure: 1012 hPa	Power: 48 VDC
Remarks:			

Plot 7.3.5 Mean output power and booster gain test results at low frequency, Chain1

FRQUENCY RANGE:
OPERATIONAL MODE:
CONFIGURATION:
INPUT SIGNAL

2110 – 2180 MHz
GSM downlink transmit
Below AGC threshold
OUTPUT SIGNAL

Agilent

R T

Agilent

R T

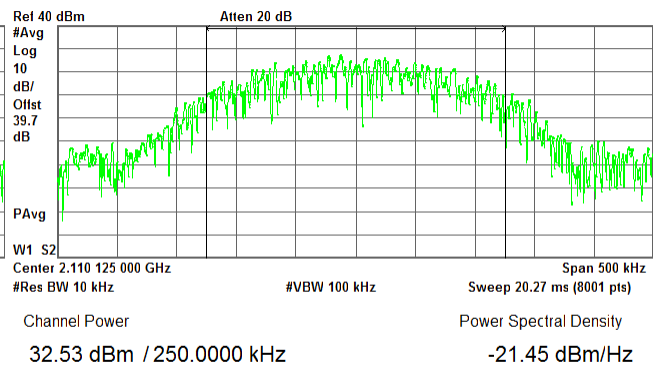
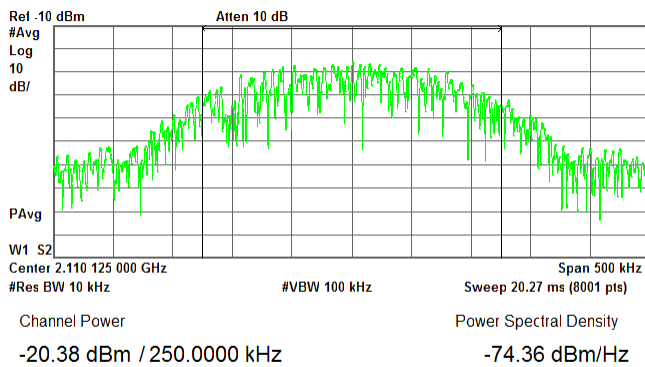

CONFIGURATION:
INPUT SIGNAL

Above AGC threshold +3dB
OUTPUT SIGNAL

Agilent

R T

Agilent

R T

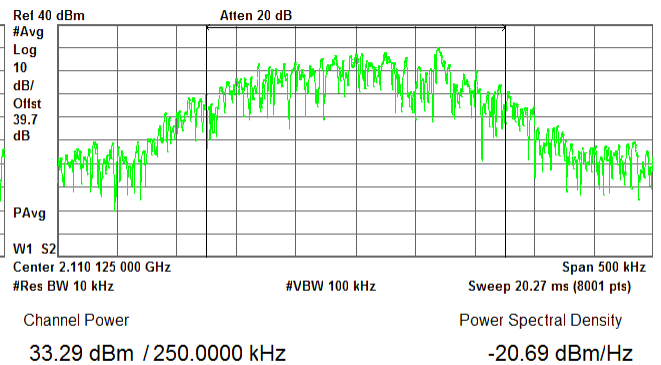
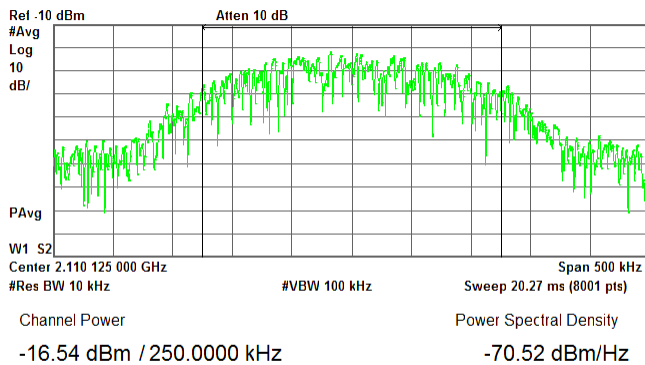



HERMON LABORATORIES

Test specification: Section 27.50(d), Mean input and output power and booster gain test			
Test procedure: KDB 935210 D05 v01r01, section 3.5			
Test mode: Compliance		Verdict: PASS	
Date(s): 27-Sep-16			
Temperature: 28 °C	Relative Humidity: 43 %	Air Pressure: 1012 hPa	Power: 48 VDC
Remarks:			

Plot 7.3.6 Mean output power and booster gain test results at mid frequency, Chain1

FRQUENCY RANGE:
OPERATIONAL MODE:
CONFIGURATION:
INPUT SIGNAL

2110 – 2180 MHz
GSM downlink transmit
Below AGC threshold
OUTPUT SIGNAL

Agilent

R T

Agilent

R T

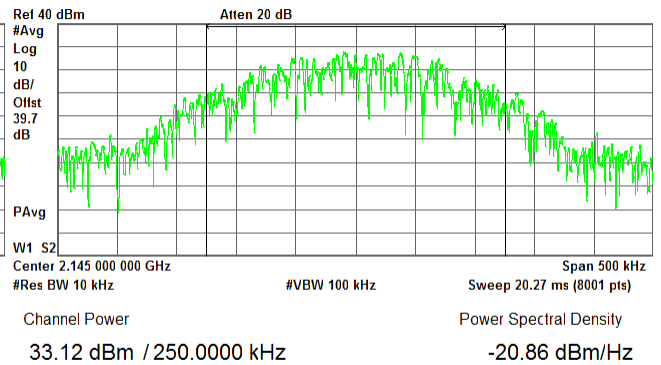
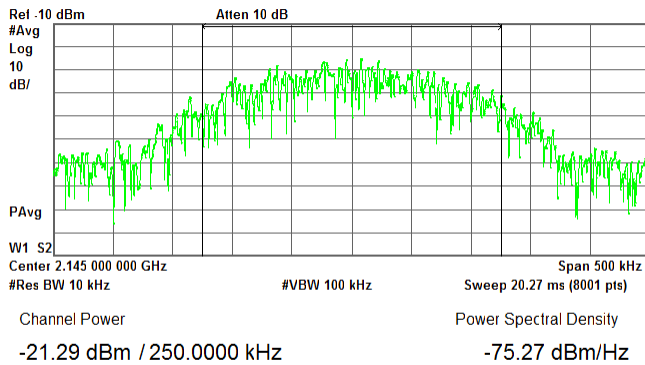

CONFIGURATION:
INPUT SIGNAL

Above AGC threshold +3dB
OUTPUT SIGNAL

Agilent

R T

Agilent

R T

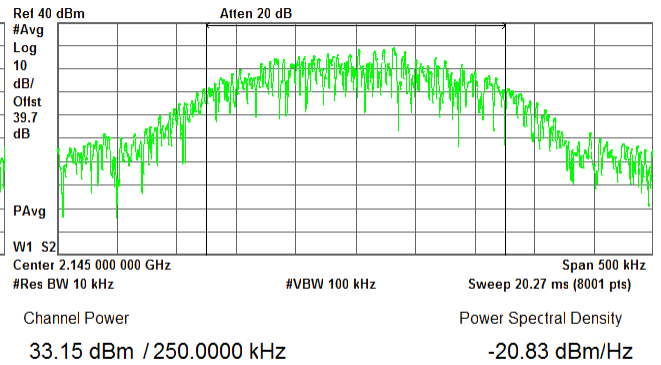
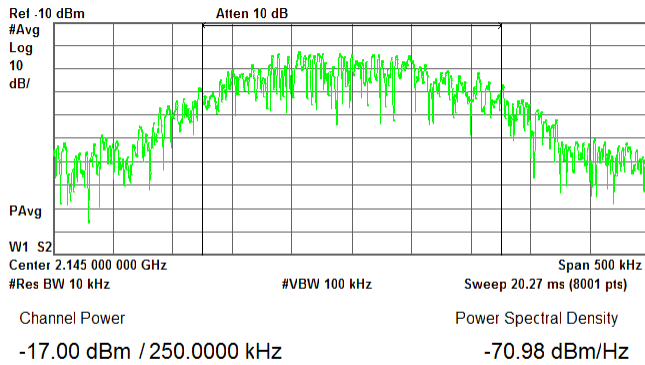



HERMON LABORATORIES

Test specification: Section 27.50(d), Mean input and output power and booster gain test			
Test procedure: KDB 935210 D05 v01r01, section 3.5			
Test mode: Compliance		Verdict: PASS	
Date(s): 27-Sep-16			
Temperature: 28 °C	Relative Humidity: 43 %	Air Pressure: 1012 hPa	Power: 48 VDC
Remarks:			

Plot 7.3.7 Mean output power and booster gain test results at f0 frequency, Chain1

FRQUENCY RANGE:
OPERATIONAL MODE:
CONFIGURATION:
INPUT SIGNAL

2110 – 2180 MHz
GSM downlink transmit
Below AGC threshold
OUTPUT SIGNAL

Agilent

R T

Agilent

R T

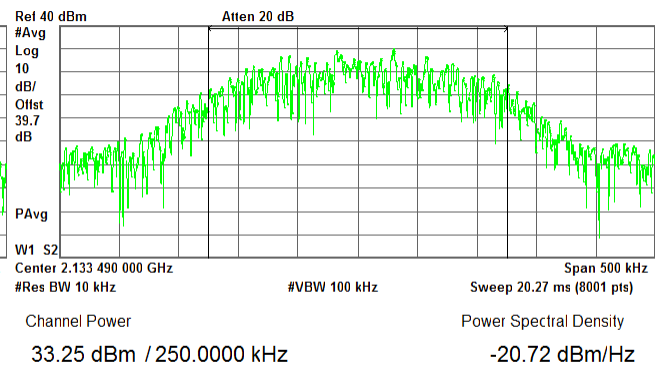
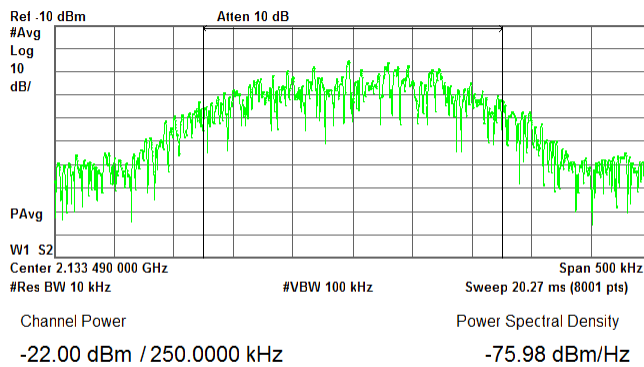

CONFIGURATION:
INPUT SIGNAL

Above AGC threshold +3dB
OUTPUT SIGNAL

Agilent

R T

Agilent

R T

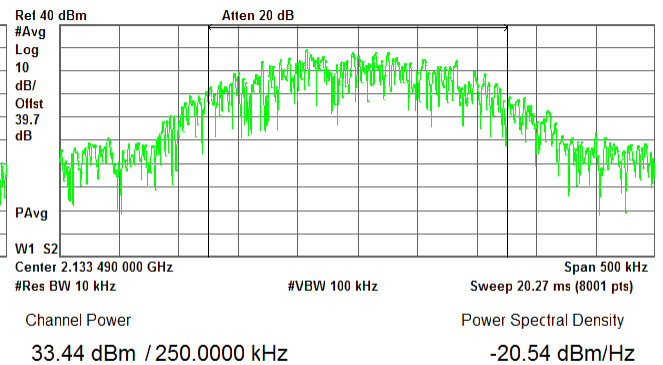
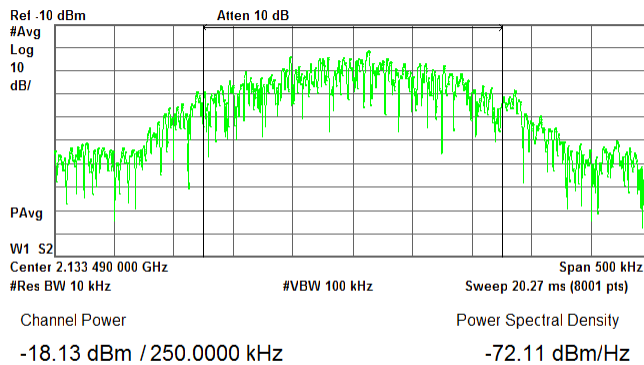



HERMON LABORATORIES

Test specification: Section 27.50(d), Mean input and output power and booster gain test			
Test procedure: KDB 935210 D05 v01r01, section 3.5			
Test mode: Compliance		Verdict: PASS	
Date(s): 27-Sep-16			
Temperature: 28 °C	Relative Humidity: 43 %	Air Pressure: 1012 hPa	Power: 48 VDC
Remarks:			

Plot 7.3.8 Mean output power and booster gain test results at high frequency, Chain1

FRQUENCY RANGE:
OPERATIONAL MODE:
CONFIGURATION:
INPUT SIGNAL

2110 – 2180 MHz
GSM downlink transmit
Below AGC threshold
OUTPUT SIGNAL

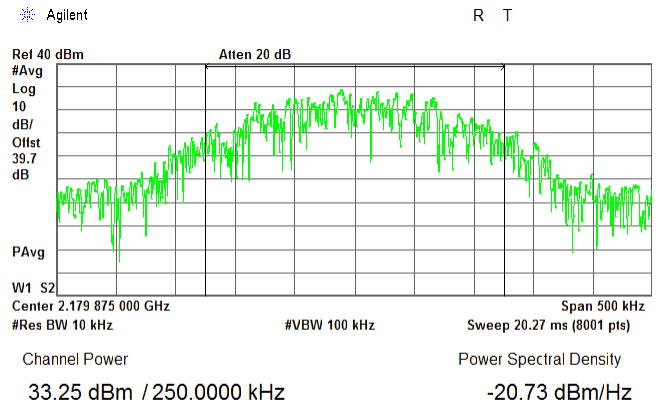
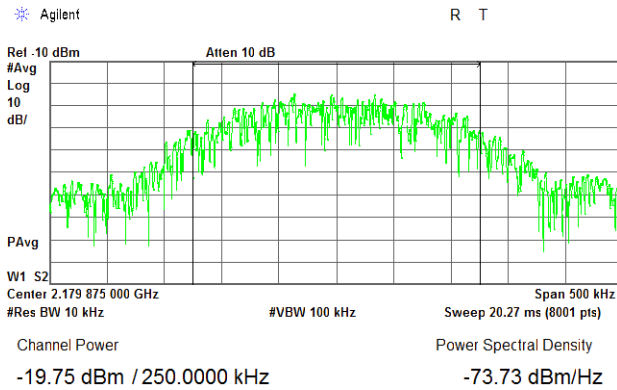

CONFIGURATION:
INPUT SIGNAL

Above AGC threshold +3dB
OUTPUT SIGNAL

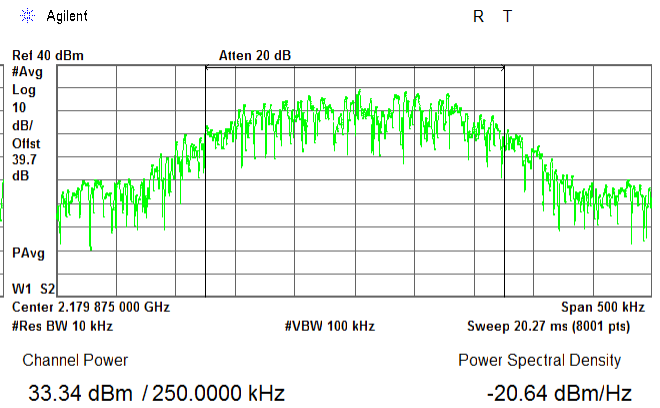
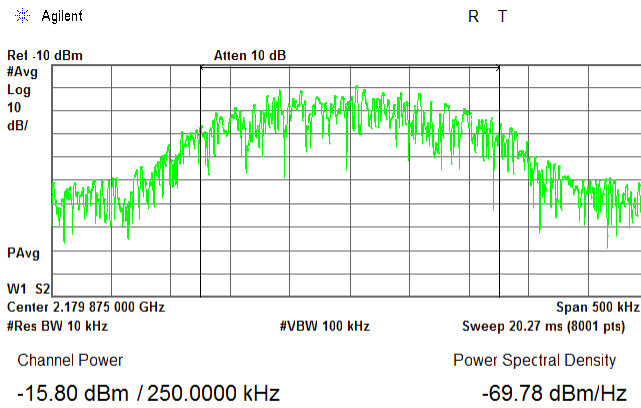



HERMON LABORATORIES

Test specification: Section 27.50(d), Mean input and output power and booster gain test			
Test procedure: KDB 935210 D05 v01r01, section 3.5			
Test mode: Compliance		Verdict: PASS	
Date(s): 27-Sep-16			
Temperature: 28 °C	Relative Humidity: 43 %	Air Pressure: 1012 hPa	Power: 48 VDC
Remarks:			

Plot 7.3.9 Mean output power and booster gain test results at low frequency, Chain1

FRQUENCY RANGE:
OPERATIONAL MODE:
CONFIGURATION:
INPUT SIGNAL

2110 – 2180 MHz
WCDMA downlink transmit
Below AGC threshold
OUTPUT SIGNAL

Agilent

R T

Agilent

R T

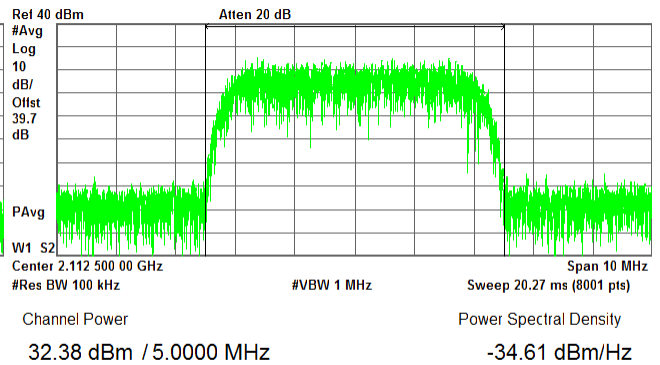
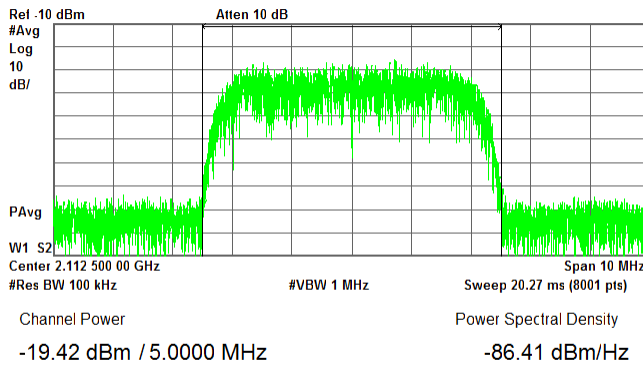

CONFIGURATION:
INPUT SIGNAL

Above AGC threshold +3dB
OUTPUT SIGNAL

Agilent

R T

Agilent

R T

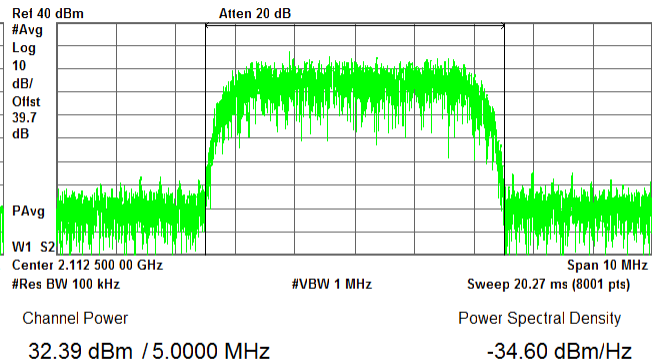
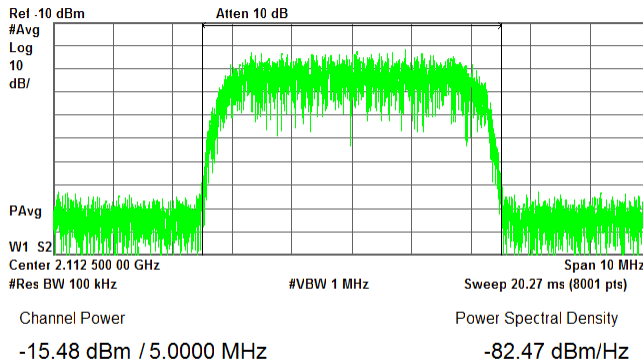



HERMON LABORATORIES

Test specification: Section 27.50(d), Mean input and output power and booster gain test			
Test procedure: KDB 935210 D05 v01r01, section 3.5			
Test mode: Compliance		Verdict: PASS	
Date(s): 27-Sep-16			
Temperature: 28 °C	Relative Humidity: 43 %	Air Pressure: 1012 hPa	Power: 48 VDC
Remarks:			

Plot 7.3.10 Mean output power and booster gain test results at mid frequency, Chain1

FRQUENCY RANGE:
OPERATIONAL MODE:
CONFIGURATION:
INPUT SIGNAL

2110 – 2180 MHz
WCDMA downlink transmit
Below AGC threshold
OUTPUT SIGNAL

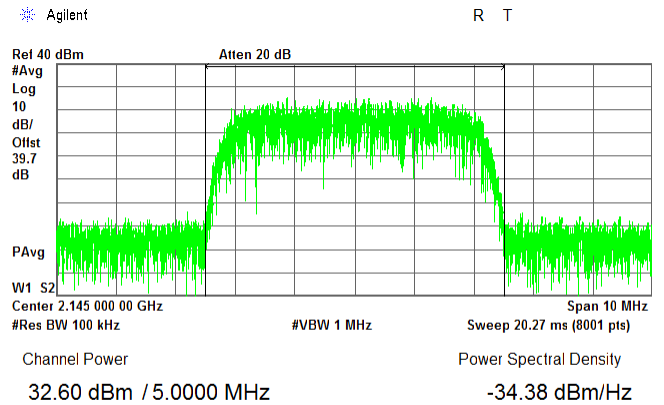
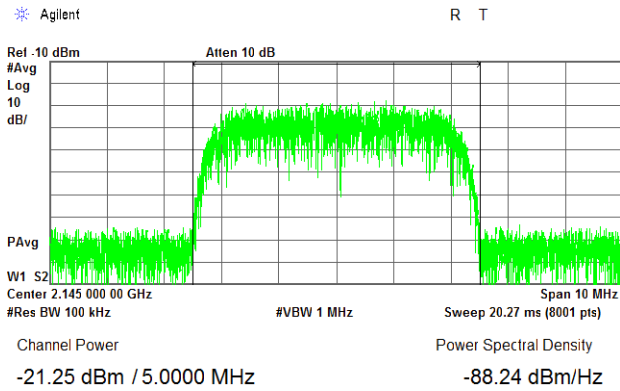

CONFIGURATION:
INPUT SIGNAL

Above AGC threshold +3dB
OUTPUT SIGNAL

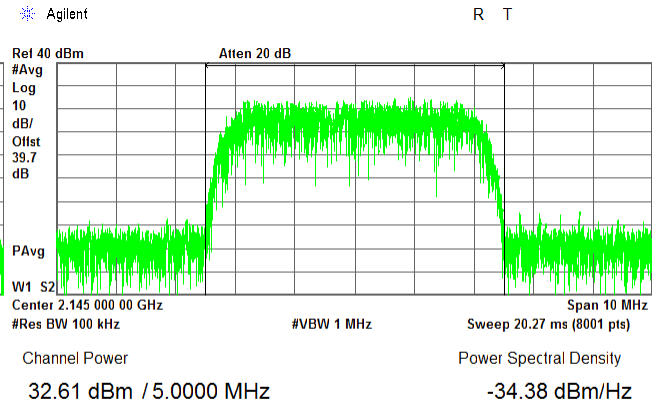
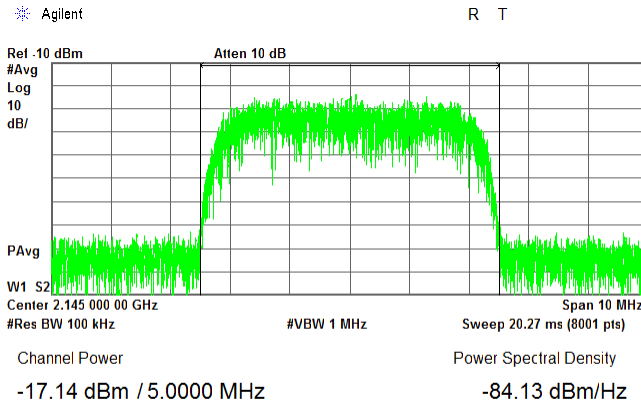



HERMON LABORATORIES

Test specification: Section 27.50(d), Mean input and output power and booster gain test			
Test procedure: KDB 935210 D05 v01r01, section 3.5			
Test mode: Compliance		Verdict: PASS	
Date(s): 27-Sep-16			
Temperature: 28 °C	Relative Humidity: 43 %	Air Pressure: 1012 hPa	Power: 48 VDC
Remarks:			

Plot 7.3.11 Mean output power and booster gain test results at f0 frequency, Chain1

FRQUENCY RANGE:
OPERATIONAL MODE:
CONFIGURATION:
INPUT SIGNAL

2110 – 2180 MHz
WCDMA downlink transmit
Below AGC threshold
OUTPUT SIGNAL

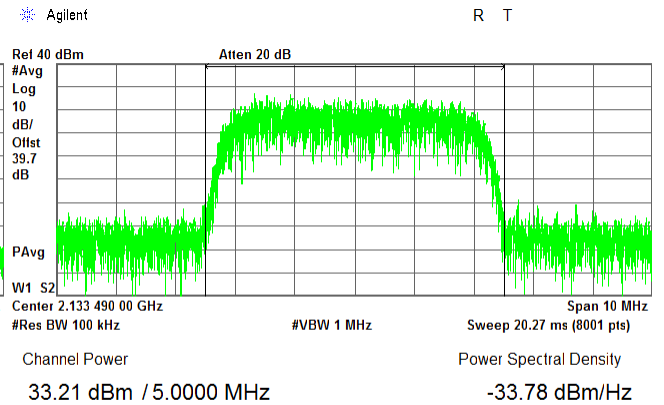
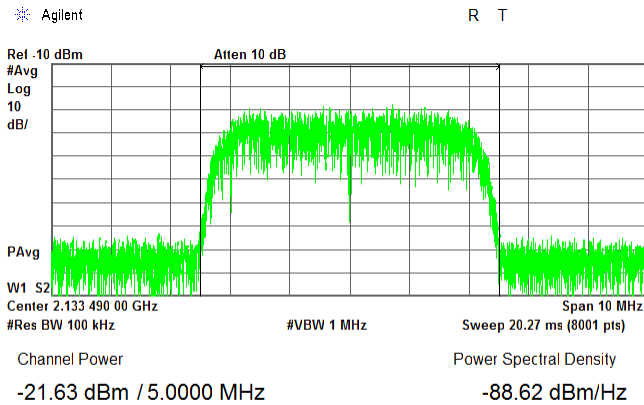

CONFIGURATION:
INPUT SIGNAL

Above AGC threshold +3dB
OUTPUT SIGNAL

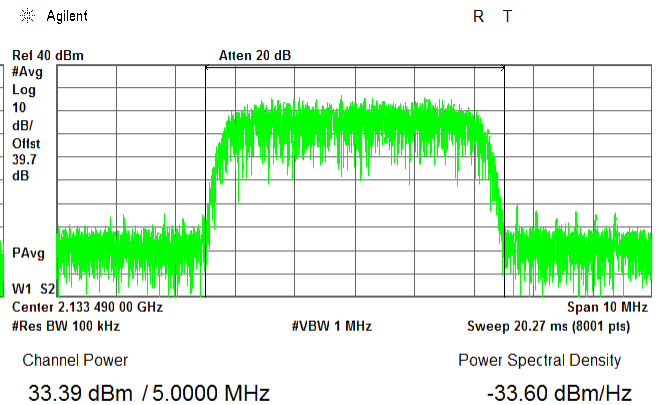
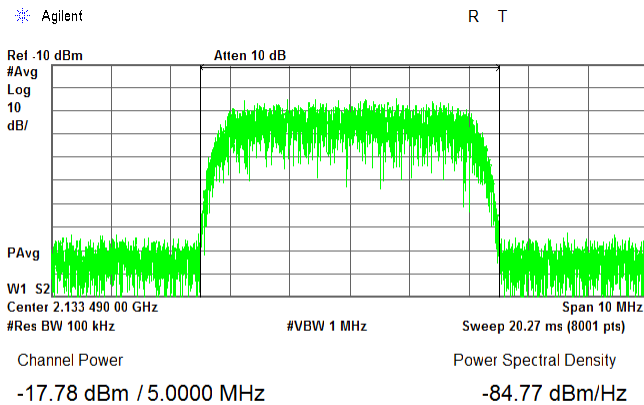



HERMON LABORATORIES

Test specification: Section 27.50(d), Mean input and output power and booster gain test			
Test procedure: KDB 935210 D05 v01r01, section 3.5			
Test mode: Compliance		Verdict: PASS	
Date(s): 27-Sep-16			
Temperature: 28 °C	Relative Humidity: 43 %	Air Pressure: 1012 hPa	Power: 48 VDC
Remarks:			

Plot 7.3.12 Mean output power and booster gain test results at high frequency, Chain1

FRQUENCY RANGE:
OPERATIONAL MODE:
CONFIGURATION:
INPUT SIGNAL

2110 – 2180 MHz
WCDMA downlink transmit
Below AGC threshold
OUTPUT SIGNAL

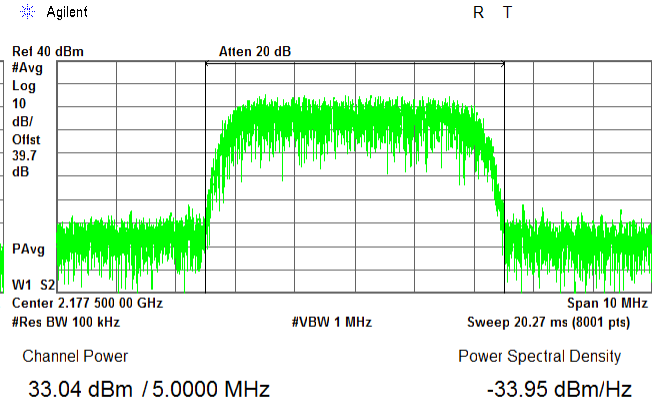
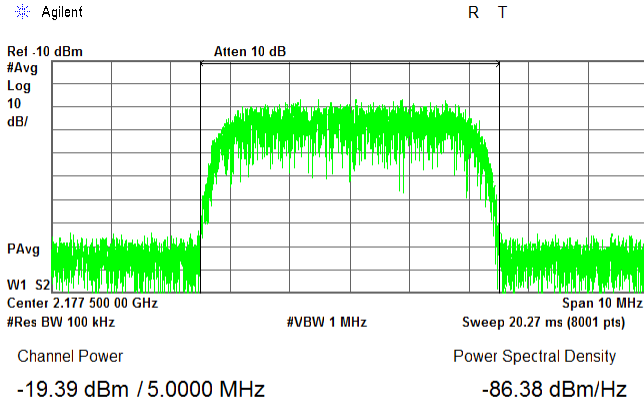

CONFIGURATION:
INPUT SIGNAL

Above AGC threshold +3dB
OUTPUT SIGNAL

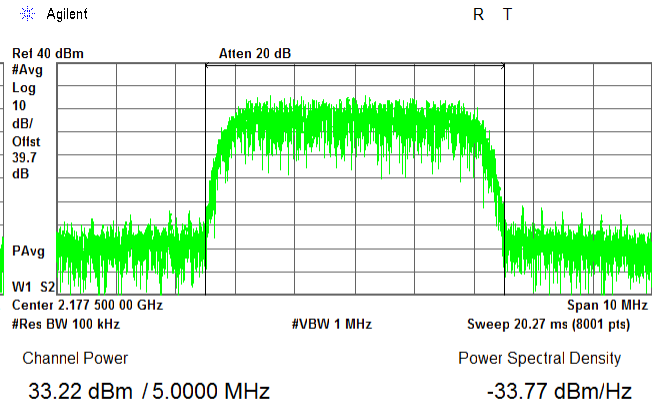
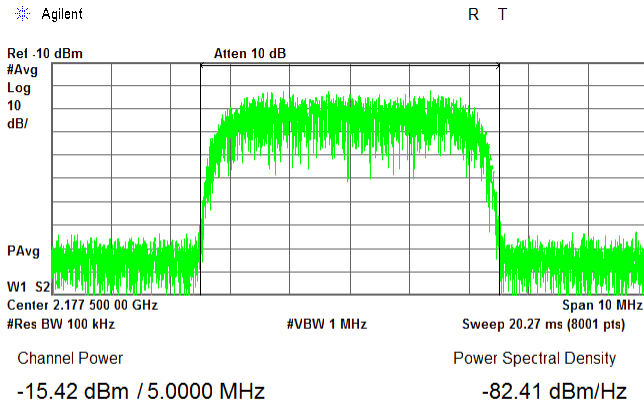



HERMON LABORATORIES

Test specification: Section 27.50(d), Mean input and output power and booster gain test			
Test procedure: KDB 935210 D05 v01r01, section 3.5			
Test mode: Compliance		Verdict: PASS	
Date(s): 27-Sep-16			
Temperature: 28 °C	Relative Humidity: 43 %	Air Pressure: 1012 hPa	Power: 48 VDC
Remarks:			

Plot 7.3.13 Mean output power and booster gain test results at low frequency, Chain 2

FRQUENCY RANGE:
OPERATIONAL MODE:
CONFIGURATION:
INPUT SIGNAL

2110 – 2180 MHz
AWGN downlink transmit
Below AGC threshold
OUTPUT SIGNAL

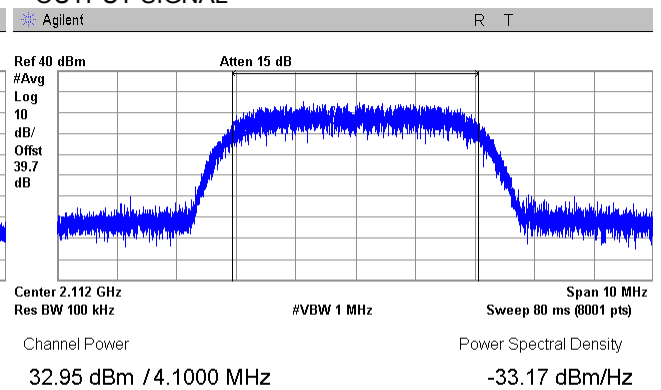
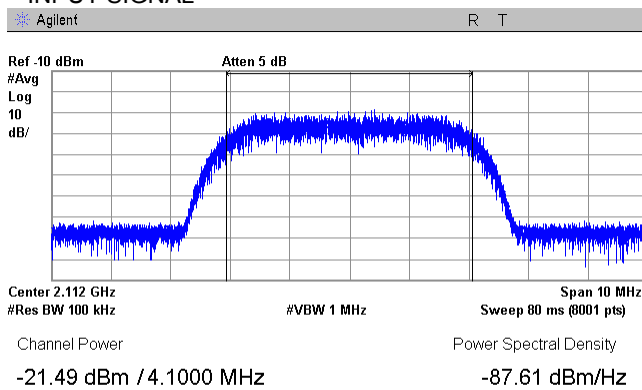

CONFIGURATION:
INPUT SIGNAL

Above AGC threshold +3dB
OUTPUT SIGNAL

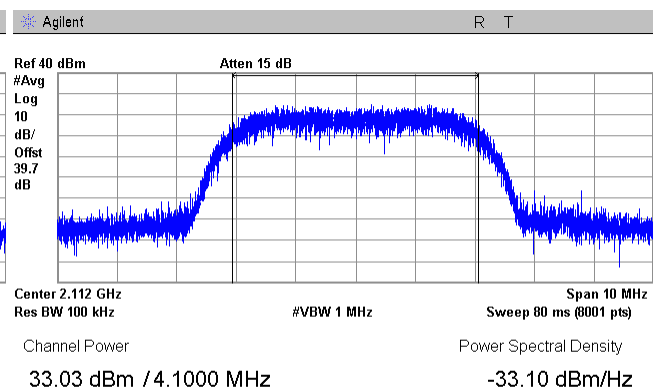
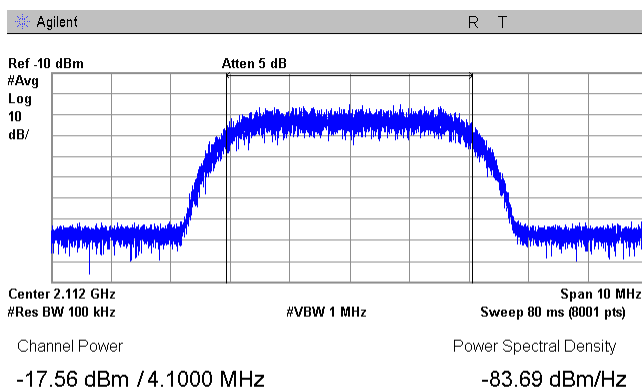



HERMON LABORATORIES

Test specification: Section 27.50(d), Mean input and output power and booster gain test			
Test procedure: KDB 935210 D05 v01r01, section 3.5			
Test mode: Compliance		Verdict: PASS	
Date(s): 27-Sep-16			
Temperature: 28 °C	Relative Humidity: 43 %	Air Pressure: 1012 hPa	Power: 48 VDC
Remarks:			

Plot 7.3.14 Mean output power and booster gain test results at mid frequency, Chain 2

FRQUENCY RANGE:
OPERATIONAL MODE:
CONFIGURATION:
INPUT SIGNAL

2110 – 2180 MHz
AWGN downlink transmit
Below AGC threshold
OUTPUT SIGNAL

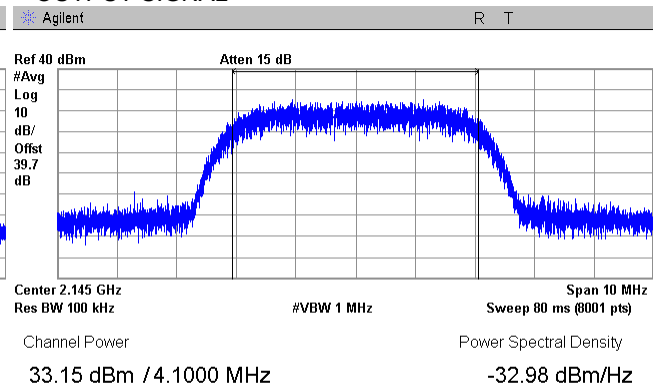
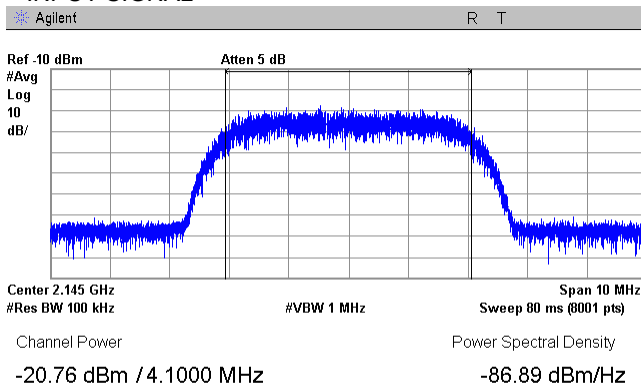

CONFIGURATION:
INPUT SIGNAL

Above AGC threshold +3dB
OUTPUT SIGNAL

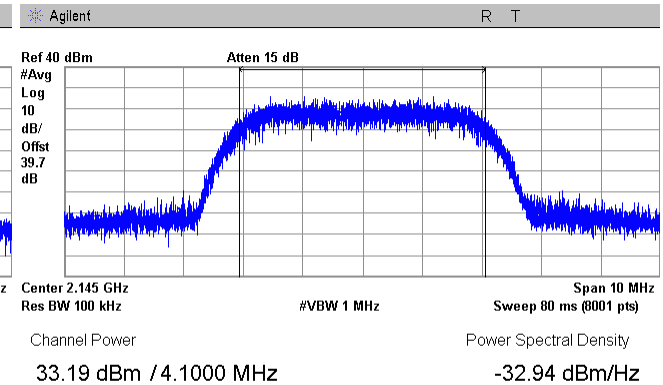
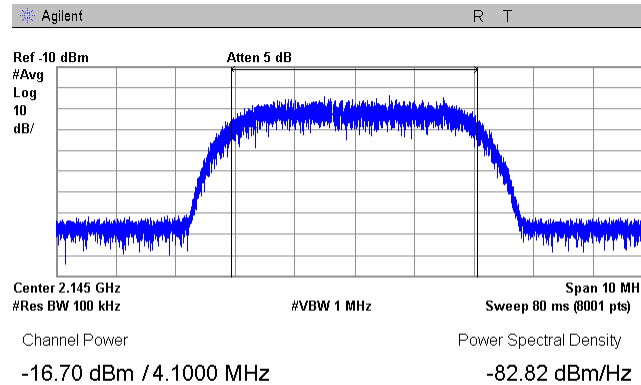



HERMON LABORATORIES

Test specification: Section 27.50(d), Mean input and output power and booster gain test			
Test procedure: KDB 935210 D05 v01r01, section 3.5			
Test mode: Compliance		Verdict: PASS	
Date(s): 27-Sep-16			
Temperature: 28 °C	Relative Humidity: 43 %	Air Pressure: 1012 hPa	Power: 48 VDC
Remarks:			

Plot 7.3.15 Mean output power and booster gain test results at f0 frequency, Chain 2

FRQUENCY RANGE:
OPERATIONAL MODE:
CONFIGURATION:
INPUT SIGNAL

2110 – 2180 MHz
AWGN downlink transmit
Below AGC threshold
OUTPUT SIGNAL

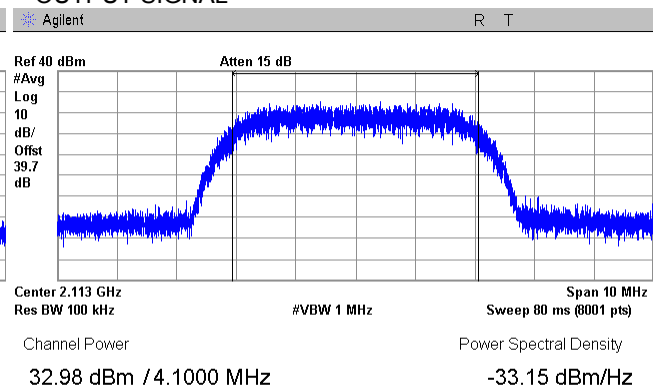
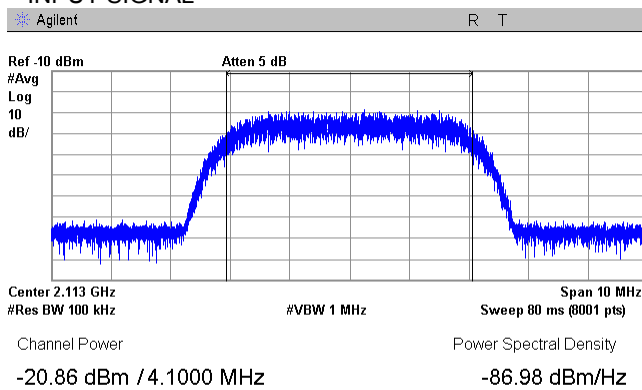

CONFIGURATION:
INPUT SIGNAL

Above AGC threshold +3dB
OUTPUT SIGNAL

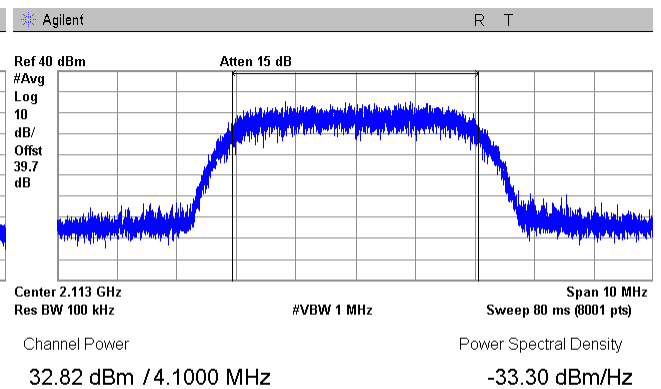
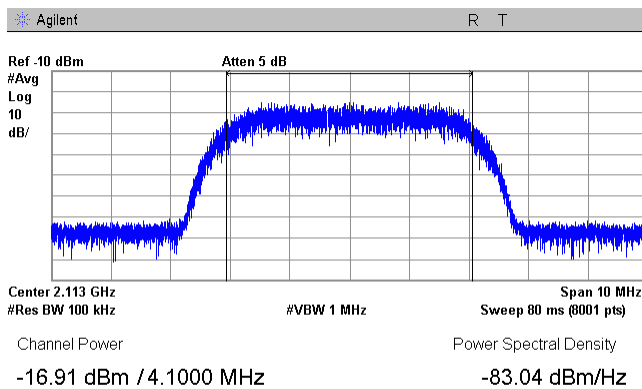



HERMON LABORATORIES

Test specification: Section 27.50(d), Mean input and output power and booster gain test			
Test procedure: KDB 935210 D05 v01r01, section 3.5			
Test mode: Compliance		Verdict: PASS	
Date(s): 27-Sep-16			
Temperature: 28 °C	Relative Humidity: 43 %	Air Pressure: 1012 hPa	Power: 48 VDC
Remarks:			

Plot 7.3.16 Mean output power and booster gain test results at high frequency, Chain 2

FRQUENCY RANGE:
OPERATIONAL MODE:
CONFIGURATION:
INPUT SIGNAL

2110 – 2180 MHz
AWGN downlink transmit
Below AGC threshold
OUTPUT SIGNAL

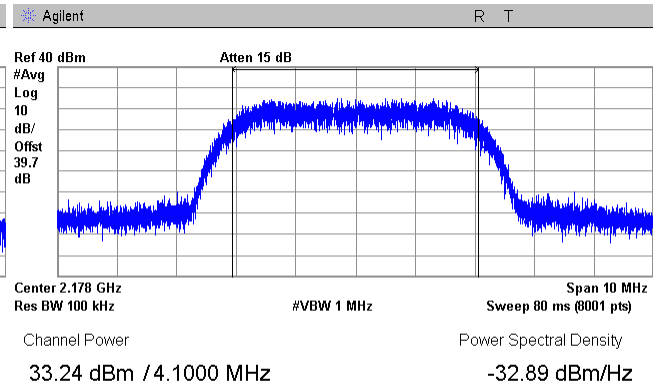
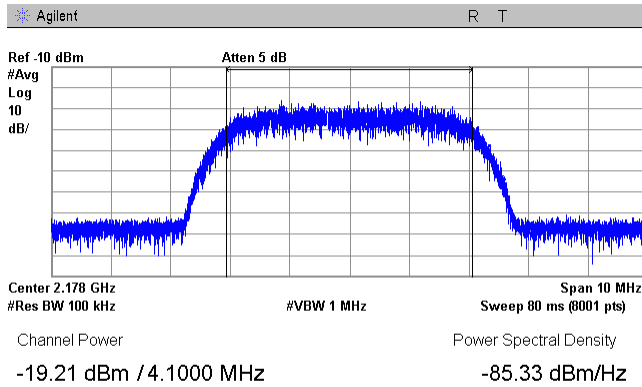

CONFIGURATION:
INPUT SIGNAL

Above AGC threshold +3dB
OUTPUT SIGNAL

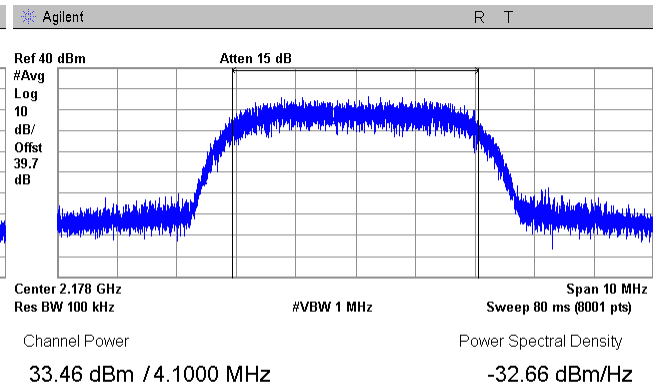
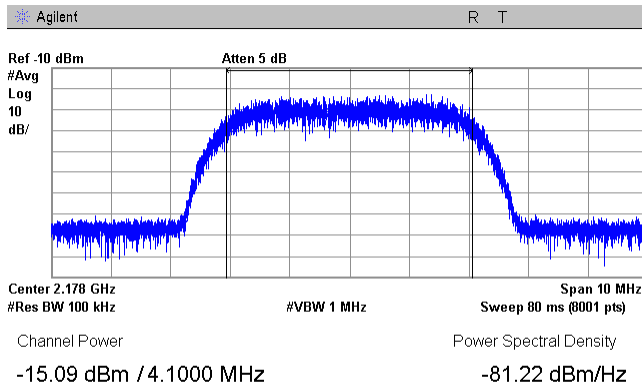



HERMON LABORATORIES

Test specification: Section 27.50(d), Mean input and output power and booster gain test			
Test procedure: KDB 935210 D05 v01r01, section 3.5			
Test mode: Compliance		Verdict: PASS	
Date(s): 27-Sep-16			
Temperature: 28 °C	Relative Humidity: 43 %	Air Pressure: 1012 hPa	Power: 48 VDC
Remarks:			

Plot 7.3.17 Mean output power and booster gain test results at low frequency, Chain 2

FRQUENCY RANGE:	2110 – 2180 MHz
OPERATIONAL MODE:	GSM downlink transmit
CONFIGURATION:	Below AGC threshold
INPUT SIGNAL	OUTPUT SIGNAL

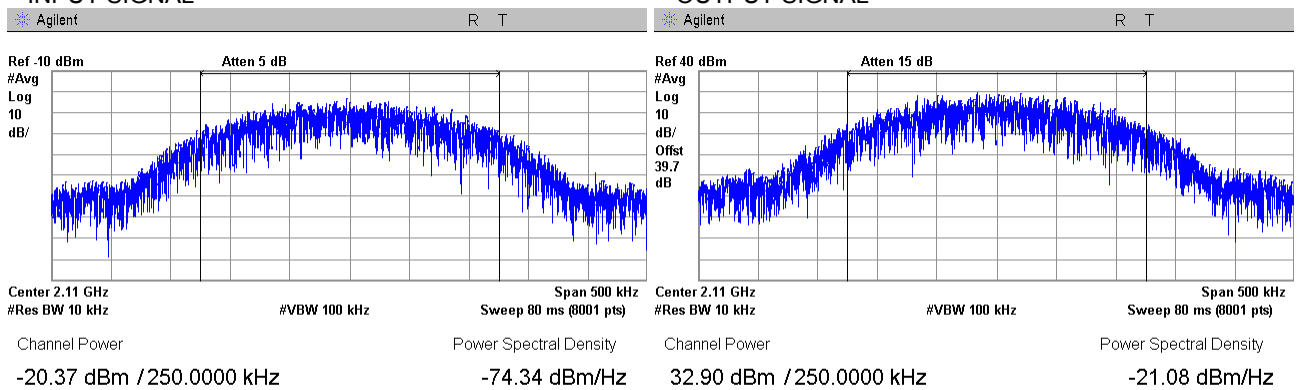

CONFIGURATION:	Above AGC threshold +3dB
INPUT SIGNAL	OUTPUT SIGNAL

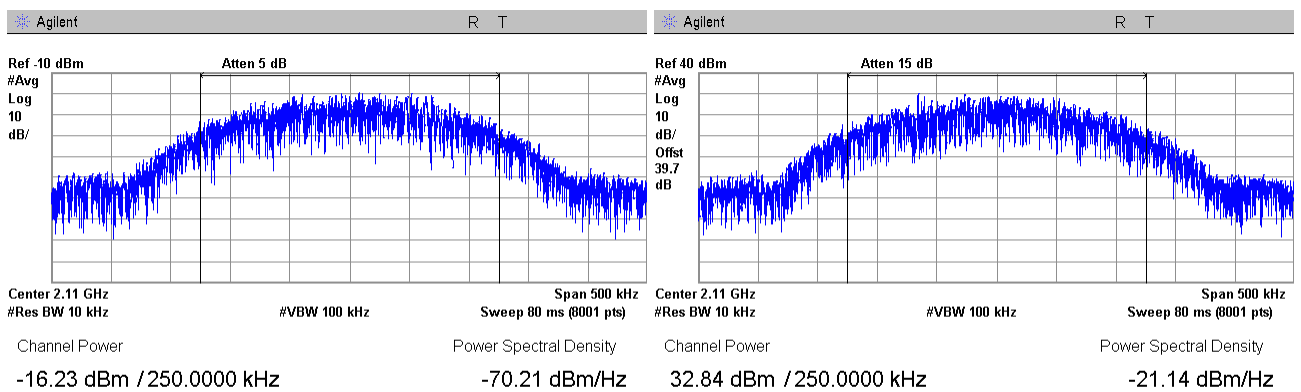



HERMON LABORATORIES

Test specification: Section 27.50(d), Mean input and output power and booster gain test			
Test procedure: KDB 935210 D05 v01r01, section 3.5			
Test mode: Compliance		Verdict: PASS	
Date(s): 27-Sep-16			
Temperature: 28 °C	Relative Humidity: 43 %	Air Pressure: 1012 hPa	Power: 48 VDC
Remarks:			

Plot 7.3.18 Mean output power and booster gain test results at mid frequency, Chain 2

FRQUENCY RANGE:
OPERATIONAL MODE:
CONFIGURATION:
INPUT SIGNAL

2110 – 2180 MHz
GSM downlink transmit
Below AGC threshold
OUTPUT SIGNAL

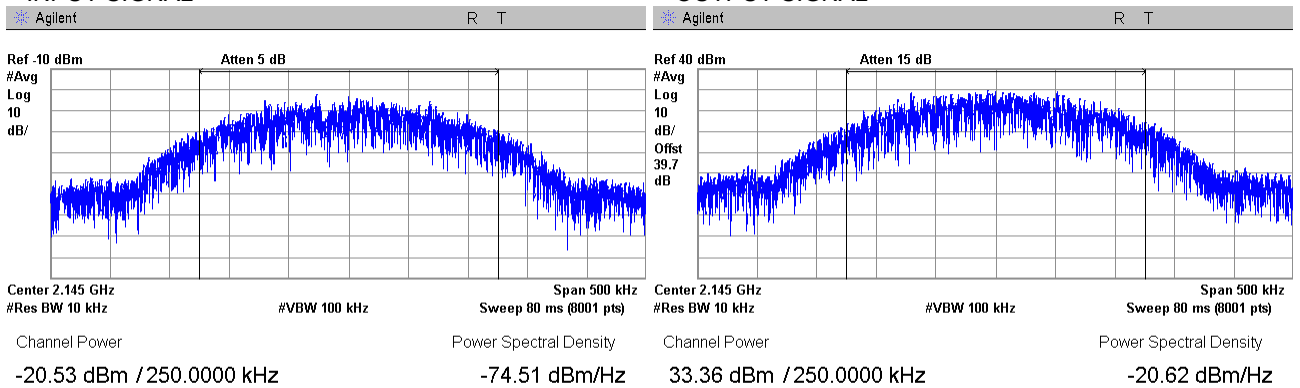

CONFIGURATION:
INPUT SIGNAL

Above AGC threshold +3dB
OUTPUT SIGNAL

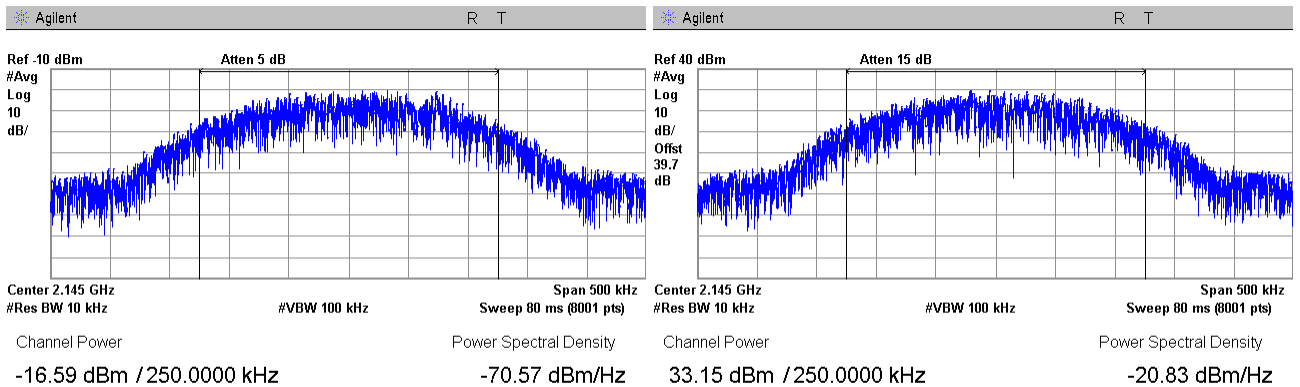



HERMON LABORATORIES

Test specification: Section 27.50(d), Mean input and output power and booster gain test			
Test procedure: KDB 935210 D05 v01r01, section 3.5			
Test mode: Compliance		Verdict: PASS	
Date(s): 27-Sep-16			
Temperature: 28 °C	Relative Humidity: 43 %	Air Pressure: 1012 hPa	Power: 48 VDC
Remarks:			

Plot 7.3.19 Mean output power and booster gain test results at f0 frequency, Chain 2

FRQUENCY RANGE:
OPERATIONAL MODE:
CONFIGURATION:
INPUT SIGNAL

2110 – 2180 MHz
GSM downlink transmit
Below AGC threshold
OUTPUT SIGNAL

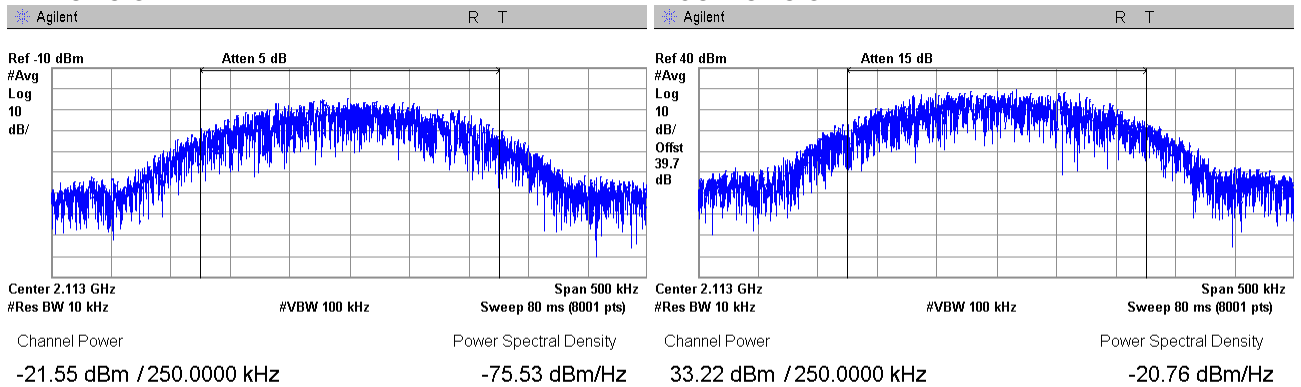

CONFIGURATION:
INPUT SIGNAL

Above AGC threshold +3dB
OUTPUT SIGNAL

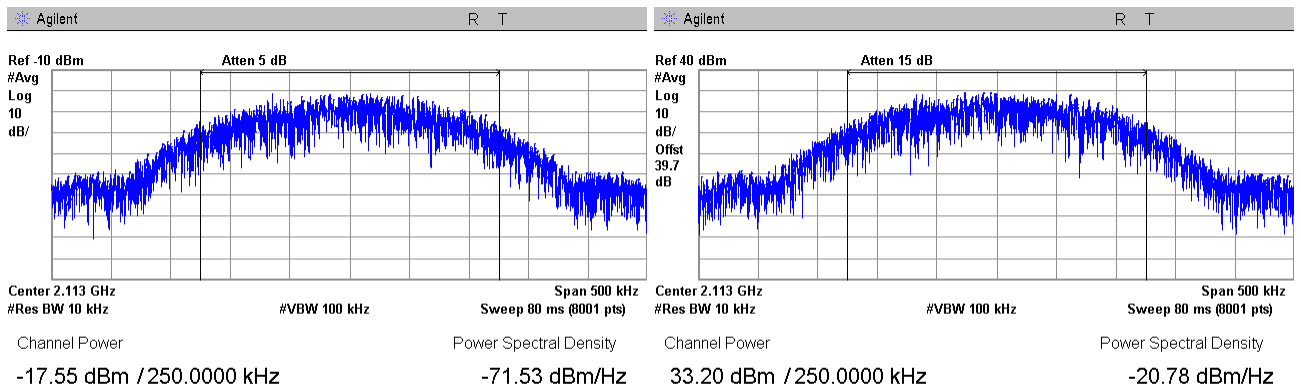



HERMON LABORATORIES

Test specification: Section 27.50(d), Mean input and output power and booster gain test			
Test procedure: KDB 935210 D05 v01r01, section 3.5			
Test mode: Compliance		Verdict: PASS	
Date(s): 27-Sep-16			
Temperature: 28 °C	Relative Humidity: 43 %	Air Pressure: 1012 hPa	Power: 48 VDC
Remarks:			

Plot 7.3.20 Mean output power and booster gain test results at high frequency, Chain 2

FRQUENCY RANGE:	2110 – 2180 MHz
OPERATIONAL MODE:	GSM downlink transmit
CONFIGURATION:	Below AGC threshold
INPUT SIGNAL	OUTPUT SIGNAL

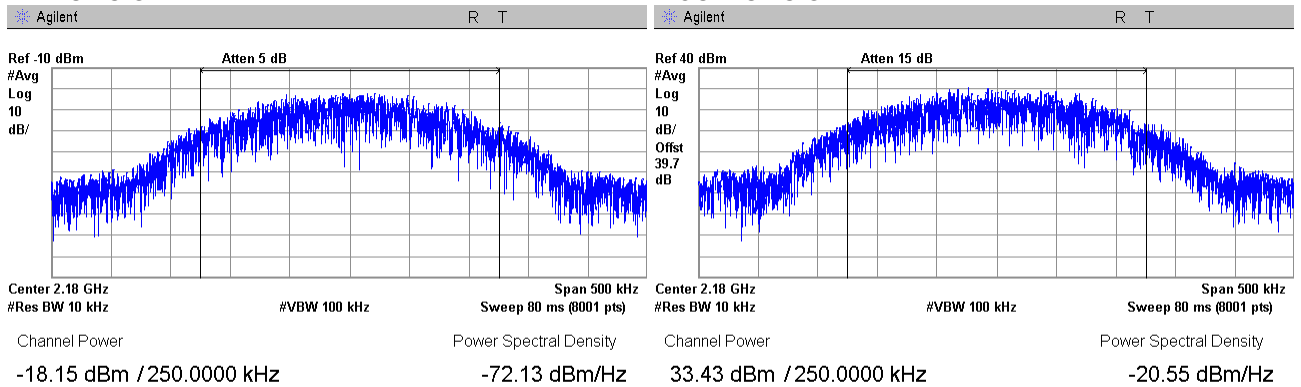

CONFIGURATION:	Above AGC threshold +3dB
INPUT SIGNAL	OUTPUT SIGNAL

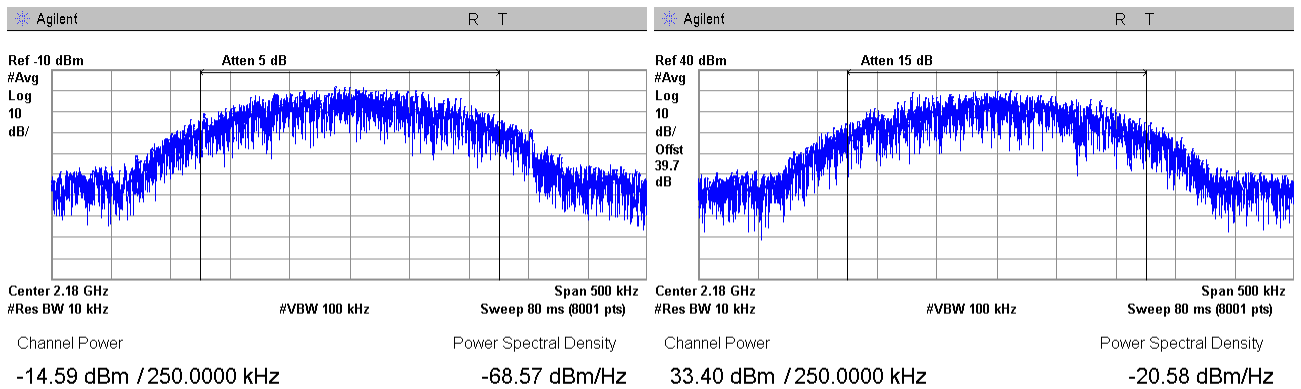



HERMON LABORATORIES

Test specification: Section 27.50(d), Mean input and output power and booster gain test			
Test procedure: KDB 935210 D05 v01r01, section 3.5			
Test mode: Compliance		Verdict: PASS	
Date(s): 27-Sep-16			
Temperature: 28 °C	Relative Humidity: 43 %	Air Pressure: 1012 hPa	Power: 48 VDC
Remarks:			

Plot 7.3.21 Mean output power and booster gain test results at low frequency, Chain 2

FRQUENCY RANGE:
OPERATIONAL MODE:
CONFIGURATION:
INPUT SIGNAL

2110 – 2180 MHz
WCDMA downlink transmit
Below AGC threshold
OUTPUT SIGNAL

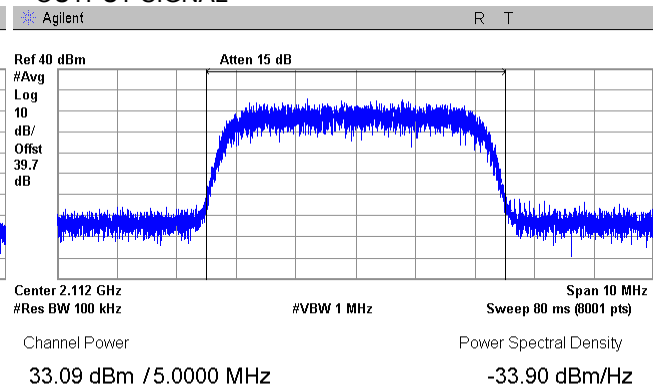
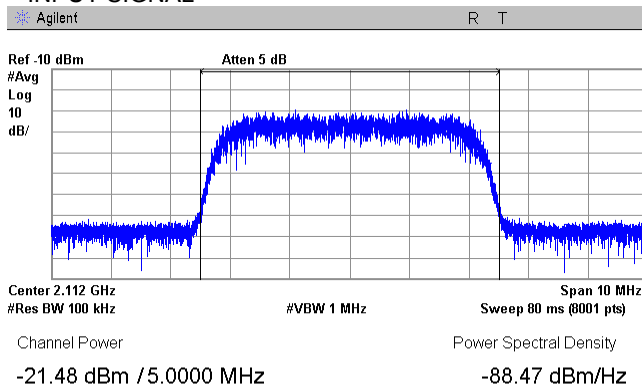

CONFIGURATION:
INPUT SIGNAL

Above AGC threshold +3dB
OUTPUT SIGNAL

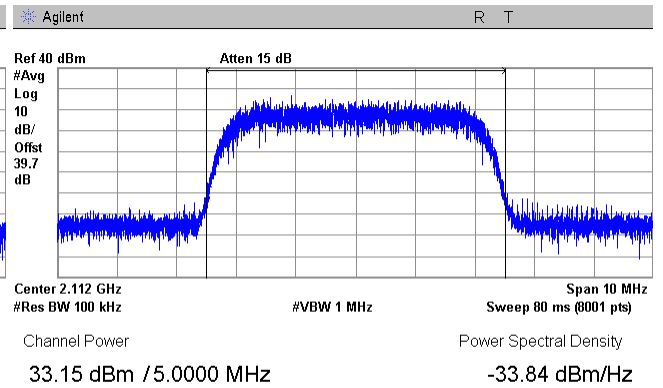
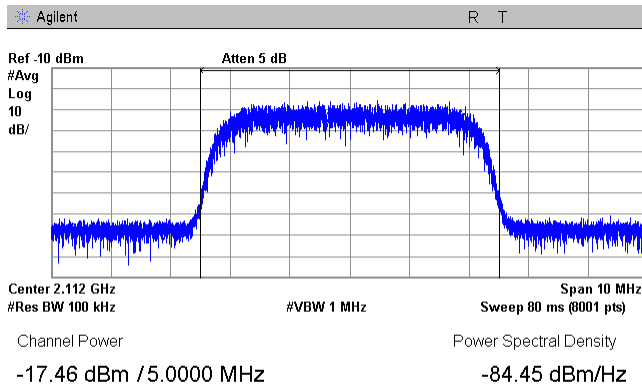



HERMON LABORATORIES

Test specification: Section 27.50(d), Mean input and output power and booster gain test			
Test procedure: KDB 935210 D05 v01r01, section 3.5			
Test mode: Compliance		Verdict: PASS	
Date(s): 27-Sep-16			
Temperature: 28 °C	Relative Humidity: 43 %	Air Pressure: 1012 hPa	Power: 48 VDC
Remarks:			

Plot 7.3.22 Mean output power and booster gain test results at mid frequency, Chain 2

FRQUENCY RANGE:
OPERATIONAL MODE:
CONFIGURATION:
INPUT SIGNAL

2110 – 2180 MHz
WCDMA downlink transmit
Below AGC threshold
OUTPUT SIGNAL

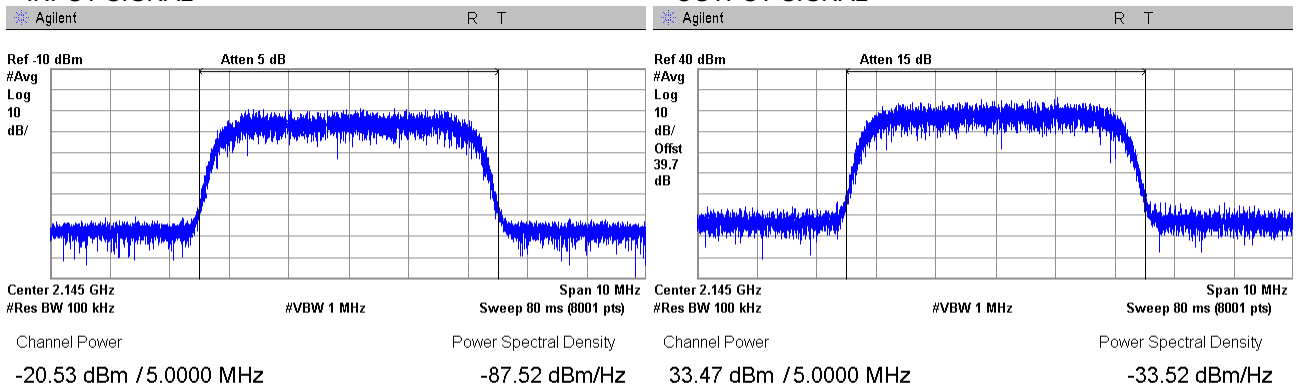

CONFIGURATION:
INPUT SIGNAL

Above AGC threshold +3dB
OUTPUT SIGNAL

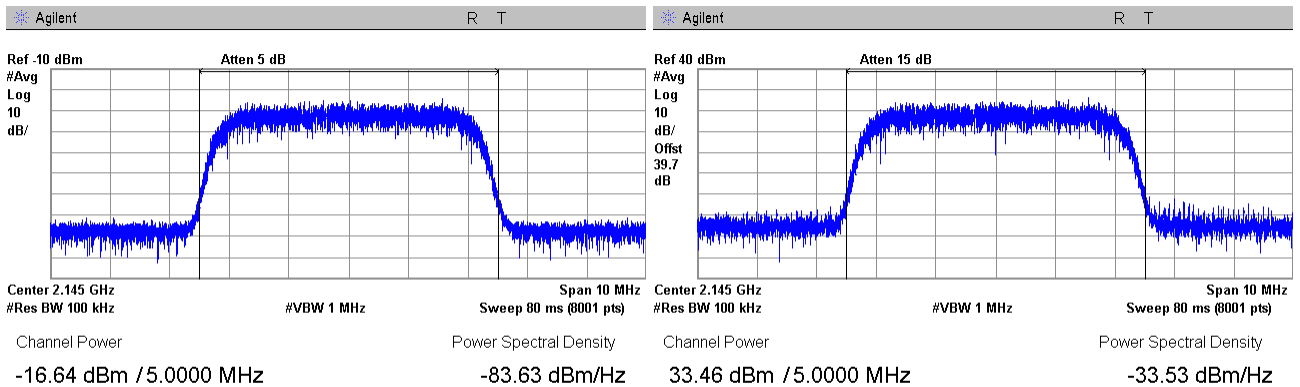



HERMON LABORATORIES

Test specification: Section 27.50(d), Mean input and output power and booster gain test			
Test procedure: KDB 935210 D05 v01r01, section 3.5			
Test mode: Compliance		Verdict: PASS	
Date(s): 27-Sep-16			
Temperature: 28 °C	Relative Humidity: 43 %	Air Pressure: 1012 hPa	Power: 48 VDC
Remarks:			

Plot 7.3.23 Mean output power and booster gain test results at f0 frequency, Chain 2

FRQUENCY RANGE:
OPERATIONAL MODE:
CONFIGURATION:
INPUT SIGNAL

2110 – 2180 MHz
WCDMA downlink transmit
Below AGC threshold
OUTPUT SIGNAL

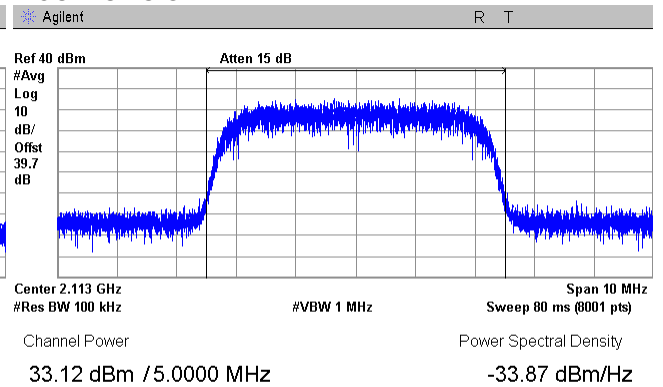
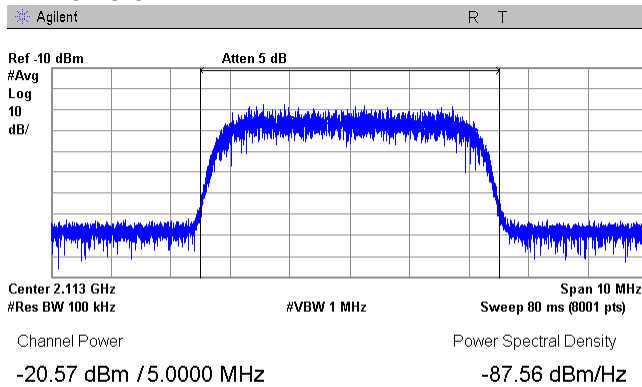

CONFIGURATION:
INPUT SIGNAL

Above AGC threshold +3dB
OUTPUT SIGNAL

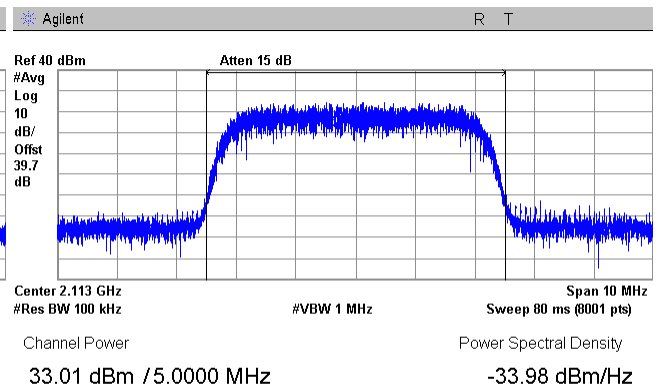
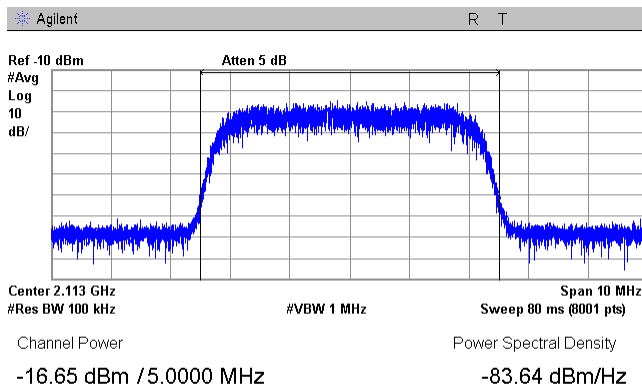



HERMON LABORATORIES

Test specification: Section 27.50(d), Mean input and output power and booster gain test			
Test procedure: KDB 935210 D05 v01r01, section 3.5			
Test mode: Compliance		Verdict: PASS	
Date(s): 27-Sep-16			
Temperature: 28 °C	Relative Humidity: 43 %	Air Pressure: 1012 hPa	Power: 48 VDC
Remarks:			

Plot 7.3.24 Mean output power and booster gain test results at high frequency, Chain 2

FRQUENCY RANGE:
OPERATIONAL MODE:
CONFIGURATION:
INPUT SIGNAL

2110 – 2180 MHz
WCDMA downlink transmit
Below AGC threshold
OUTPUT SIGNAL

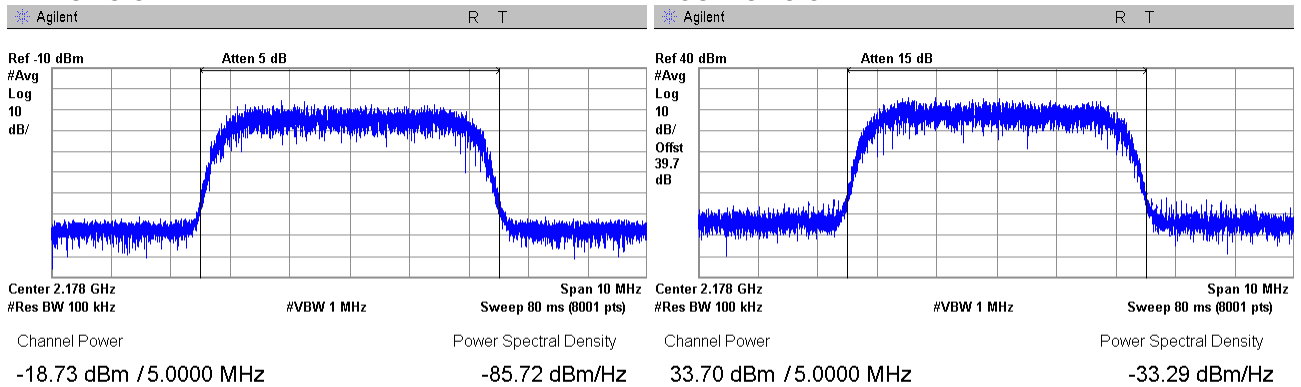

CONFIGURATION:
INPUT SIGNAL

Above AGC threshold +3dB
OUTPUT SIGNAL

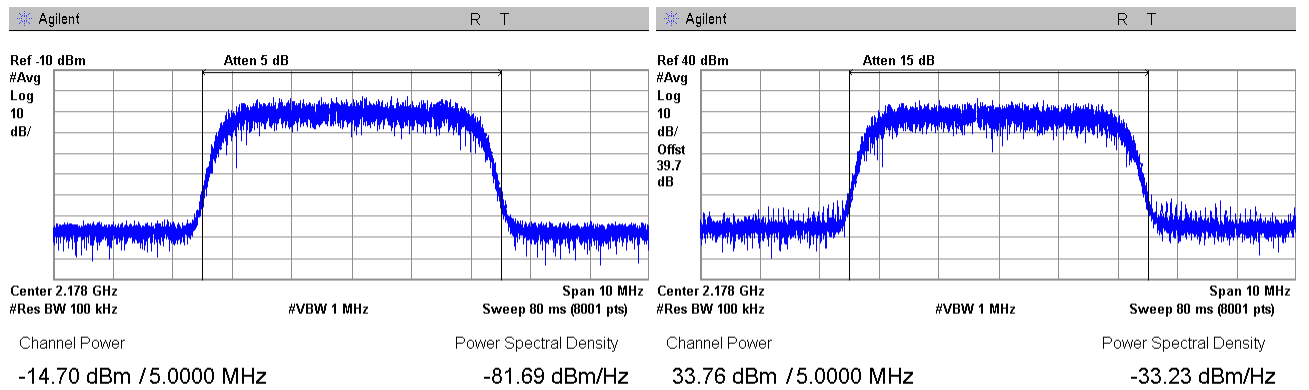



Test specification: Section 2.1049, Out-of-band rejection test			
Test procedure: KDB 935210 D05 v01r01, section 3.3			
Test mode: Compliance		Verdict: PASS	
Date(s): 18-Sep-16			
Temperature: 28 °C	Relative Humidity: 36 %	Air Pressure: 1011 hPa	Power: 48 VDC
Remarks:			

7.4 Out-of-band rejection test

7.4.1 General

This test was performed to measure amplifier pass bandwidth. Specification test limits are given in Table 7.4.1.

Table 7.4.1 Out-of-band rejection limits

Assigned frequency range, MHz	Tested frequency range	Modulation envelope reference points*, dBc
2110.0 – 2180.0	$F_0 \pm 250\% BW$	20

* - Modulation envelope reference points are provided in terms of attenuation below the unmodulated carrier.

7.4.2 Test procedure

7.4.2.1 The EUT was set up as shown in Figure 7.4.1, energized and its proper operation was checked.

7.4.2.2 The EUT was set to amplify the unmodulated carrier and the reference peak power level was measured.

7.4.2.3 The tested frequency range was swept with the signal generator and the amplifier 20 dB bandwidth was measured with spectrum analyzer as a frequency delta between the reference points on power envelope and provided in Table 7.4.2 and the associated plots.

Figure 7.4.1 Out-of-band rejection test setup





Test specification: Section 2.1049, Out-of-band rejection test			
Test procedure: KDB 935210 D05 v01r01, section 3.3			
Test mode: Compliance		Verdict: PASS	
Date(s): 18-Sep-16			
Temperature: 28 °C	Relative Humidity: 36 %	Air Pressure: 1011 hPa	Power: 48 VDC
Remarks:			

Table 7.4.2 Out-of-band rejection test results

FRQUENCY RANGE: 2110.0 – 2180.0 MHz Downlink
MIDBAND FREQUENCY: 2145.0 MHz
SWEEP FREQUENCY RANGE: 1970.0 – 2320.0 MHz
DETECTOR USED: Peak hold
RESOLUTION BANDWIDTH: 1 MHz
VIDEO BANDWIDTH: 3 MHz
MODULATION ENVELOPE REFERENCE POINTS: 20 dBc

Input Power, dBm	Start Band frequency, MHz	Stop Band frequency, MHz	Occupied bandwidth, MHz	Limit, MHz	Verdict
Chain 1					
-24.00	2089.39	2196.52	107.42	NA	Comply
Chain 2					
-23.55	2085.83	2190.96	105.15	NA	Comply

Reference numbers of test equipment used

HL 2909	HL 3433	HL 3787	HL 3788	HL 3901	HL 4354		
---------	---------	---------	---------	---------	---------	--	--

Full description is given in Appendix A.



HERMON LABORATORIES

Test specification: Section 2.1049, Out-of-band rejection test			
Test procedure: KDB 935210 D05 v01r01, section 3.3			
Test mode: Compliance		Verdict: PASS	
Date(s): 18-Sep-16			
Temperature: 28 °C	Relative Humidity: 36 %	Air Pressure: 1011 hPa	Power: 48 VDC
Remarks:			

Plot 7.4.1 Out-of-band rejection test result Chain 1

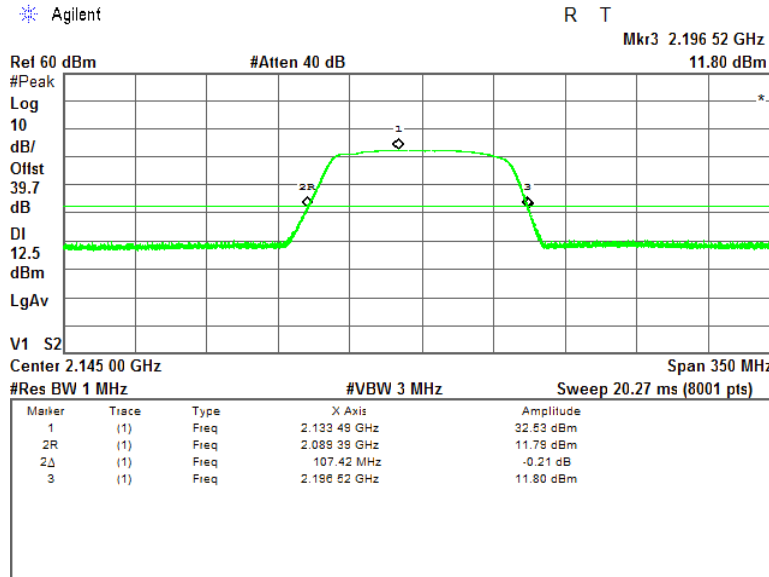

Plot 7.4.2 Out-of-band rejection test result Chain 2

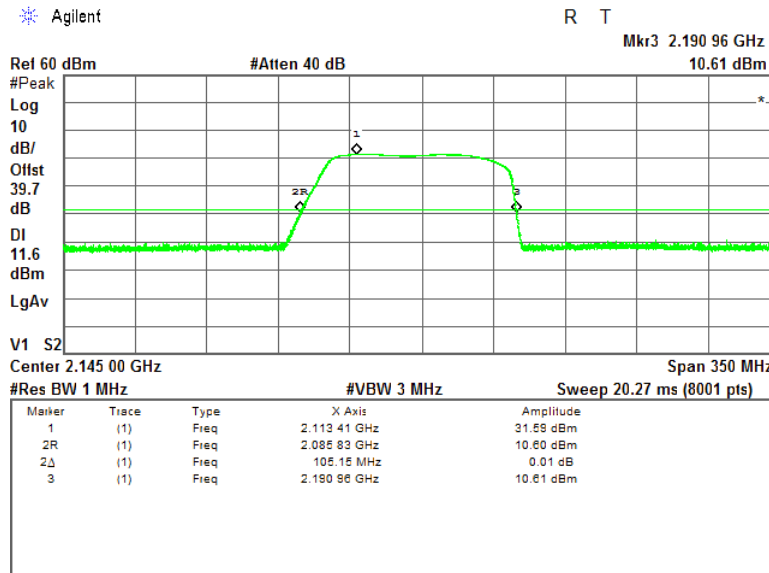



Test specification: Section 27.53, Out-of-band emissions conducted measurements			
Test procedure: 47 CFR, Sections 2.1051; KDB 935210 D05 v01r01, section 3.6.2			
Test mode: Compliance		Verdict: PASS	
Date(s): 11-Oct-16			
Temperature: 25 °C	Relative Humidity: 42 %	Air Pressure: 1014 hPa	Power: 48 VDC
Remarks:			

7.5 Out-of-band emissions at RF connector test

7.5.1 General

This test was performed to measure out-of-band spurious emissions at the channel edge at the RF antenna connector. Specification test limits are given in Table 7.5.1.

Table 7.5.1 Out-of-band spurious emission limits

Channel	Frequency range	Attenuation below carrier, dBc	RBW	Limit, dBm
Modulation AWGN/WCDMA				
Low	2109 - 2110	43+ 10*Log (P*)	100 kHz	-13.0
	2107 - 2109	43+ 10*Log (P*)	1 MHz	-13.0
High	2180 - 2181	43+ 10*Log (P*)	100 kHz	-13.0
	2181 - 2183	43+ 10*Log (P*)	1 MHz	-13.0
Modulation GSM				
Low	2109 - 2110	43+ 10*Log (P*)	3 kHz	-13.0
	2107 - 2109	43+ 10*Log (P*)	1 MHz	-13.0
High	2180 - 2181	43+ 10*Log (P*)	3 kHz	-13.0
	2181 - 2183	43+ 10*Log (P*)	1 MHz	-13.0

* - P is transmitter output power in Watts

7.5.2 Test procedure

7.5.2.1 The EUT was set up as shown in Figure 7.5.1, energized and its proper operation was checked.

7.5.2.2 The spurious emission was measured with spectrum analyzer as provided in Table 7.5.2 and the associated plots.

Figure 7.5.1 Out-of-band spurious emission test setup

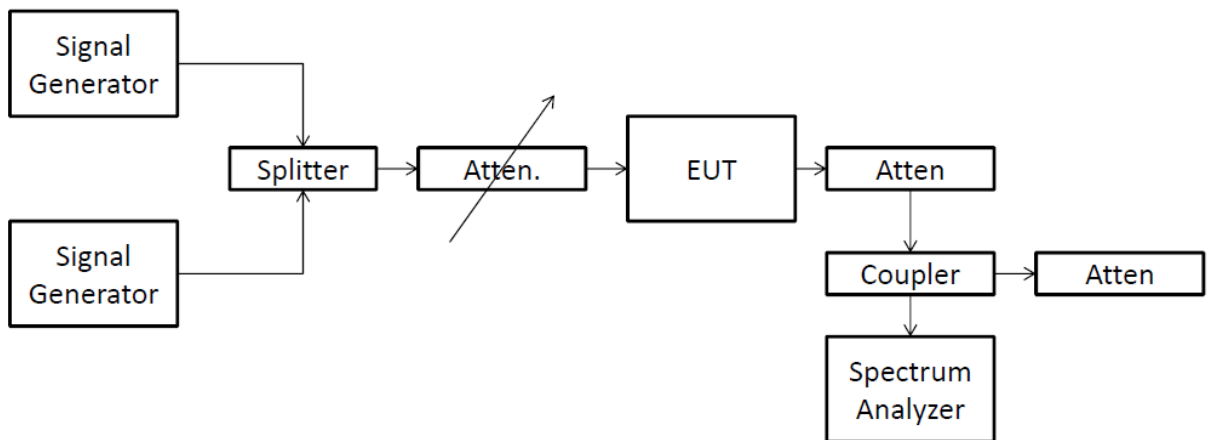



Test specification: Section 27.53, Out-of-band emissions conducted measurements			
Test procedure: 47 CFR, Sections 2.1051; KDB 935210 D05 v01r01, section 3.6.2			
Test mode: Compliance		Verdict: PASS	
Date(s): 11-Oct-16			
Temperature: 25 °C	Relative Humidity: 42 %	Air Pressure: 1014 hPa	Power: 48 VDC
Remarks:			

Table 7.5.2 Out-of-band spurious emission Modulation test results

ASSIGNED FREQUENCY RANGE: 2110 – 2180 MHz
 DETECTOR USED: Average
 VIDEO BANDWIDTH: ≥ Resolution bandwidth
 MODULATING SIGNAL: PRBS
 TRANSMITTER OUTPUT POWER SETTINGS: Maximum

Frequency, MHz	SA reading, dBm		RBW, kHz	Integrated over bandwidth, kHz	Spurious emission, dBm	Spurious emission with two channels, dBm	Limit, dBm	Margin, dB*	Verdict
	Below AGC	Above AGC							
Composite Test Signal									
Modulation AWGN									
2108.50	-24.18	-21.53	100	1000	-21.53	-18.53	-13.0	-5.53	Pass
2110.00	-19.51	-19.00	100	1000	-19.00	-16.00	-13.0	-3.00	Pass
2180.00	-16.78	-17.17	100	1000	-16.78	-13.78	-13.0	-0.78	Pass
2181.50	-23.84	-19.09	100	1000	-19.09	-16.09	-13.0	-3.09	Pass
Modulation GSM									
2108.50	-24.85	-26.10	100	1000	-24.85	-21.85	-13.0	-8.85	Pass
2110.00	-17.18	-16.45	3	NA	-16.45	-13.45	-13.0	-0.45	Pass
2180.00	-16.58	-16.75	3	NA	-16.58	-13.58	-13.0	-0.58	Pass
2181.50	-24.94	-26.45	100	1000	-24.94	-21.94	-13.0	-8.94	Pass
Modulation WCDMA									
2109.500	-22.79	-23.87	100	1000	-22.79	-19.79	-13.0	-6.79	Pass
2180.500	-20.41	-20.79	100	1000	-20.41	-17.41	-13.0	-4.41	Pass
Single Test Signal									
Modulation AWGN									
2108.50	-23.29	-23.78	100	1000	-23.29	-20.29	-13.0	-7.29	Pass
2110.00	-16.53	-16.56	100	1000	-16.53	-13.53	-13.0	-0.53	Pass
2180.00	-18.40	-18.47	100	1000	-18.40	-15.40	-13.0	-2.40	Pass
2181.50	-21.34	-21.86	100	1000	-21.34	-18.34	-13.0	-5.37	Pass
Modulation GSM									
2108.50	-25.46	-26.76	100	1000	-25.46	-22.46	-13.0	-9.46	Pass
2110.00	-16.58	-16.24	3	NA	-16.24	-13.24	-13.0	-0.24	Pass
2180.00	-16.29	-16.27	3	NA	-16.27	-13.27	-13.0	-0.27	Pass
2181.50	-24.84	-26.32	100	1000	-24.84	-21.84	-13.0	-8.84	Pass
Modulation WCDMA									
2109.500	-23.32	-24.00	100	1000	-23.32	-20.32	-13.0	-7.32	Pass
2180.500	-21.19	-21.84	100	1000	-21.19	-18.19	-13.0	-5.19	Pass

Reference numbers of test equipment used

HL 2011	HL 2909	HL 3433	HL 3472	HL 3474	HL 3787	HL 3788	HL3901
HL 4354							

Full description is given in Appendix A.



HERMON LABORATORIES

Test specification: Section 27.53, Out-of-band emissions conducted measurements			
Test procedure: 47 CFR, Sections 2.1051; KDB 935210 D05 v01r01, section 3.6.2			
Test mode: Compliance		Verdict: PASS	
Date(s): 11-Oct-16			
Temperature: 25 °C	Relative Humidity: 42 %	Air Pressure: 1014 hPa	Power: 48 VDC
Remarks:			

Plot 7.5.1 Out-of-band spurious emission test results at low carrier frequency, Lower band Edge

OPERATING FREQUENCY RANGE:

2110 – 2180 MHz

DETECTOR USED:

Average

CONFIGURATION:

Downlink

MODULATION:

AWGN/AWGN

COMPOSITE INPUT SIGNAL:

-19.4 dBm

CONFIGURATION: Below AGC threshold

CONFIGURATION: Above AGC threshold +3dB

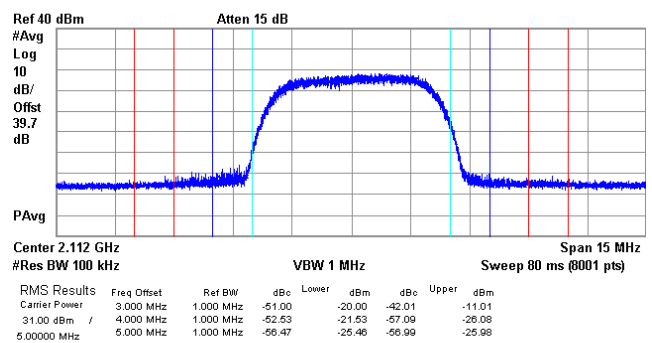
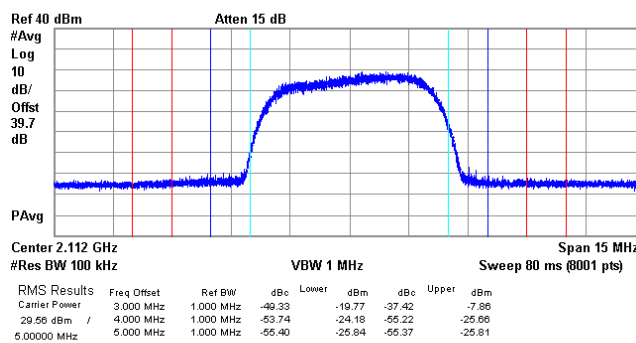
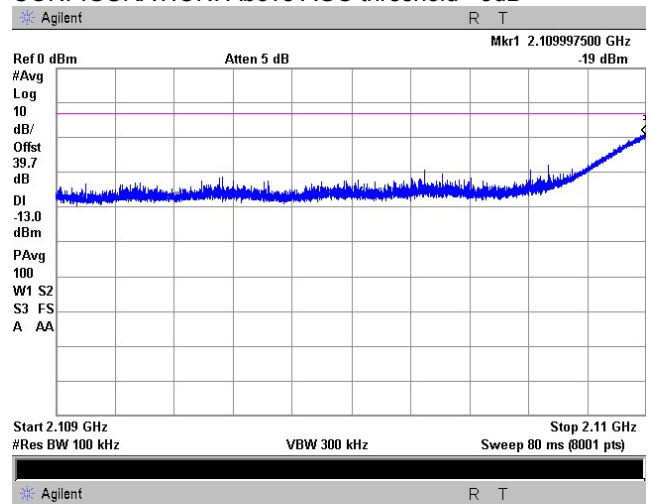
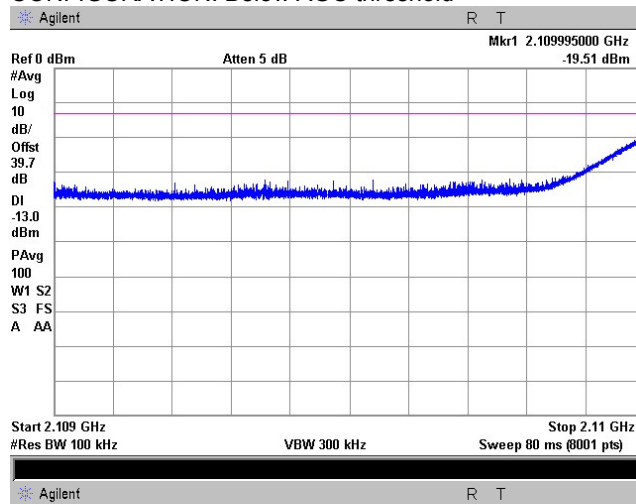



HERMON LABORATORIES

Test specification: Section 27.53, Out-of-band emissions conducted measurements			
Test procedure: 47 CFR, Sections 2.1051; KDB 935210 D05 v01r01, section 3.6.2			
Test mode: Compliance		Verdict: PASS	
Date(s): 11-Oct-16			
Temperature: 25 °C	Relative Humidity: 42 %	Air Pressure: 1014 hPa	Power: 48 VDC
Remarks:			

Plot 7.5.2 Out-of-band spurious emission test results at low carrier frequency, Lower band Edge

OPERATING FREQUENCY RANGE:
DETECTOR USED:
CONFIGURATION:
MODULATION:

2110 – 2180 MHz
Average
Downlink
AWGN/AWGN

SINGLE TEST SIGNAL INPUT:
CONFIGURATION: Below AGC threshold

-19.4 dBm
CONFIGURATION: Above AGC threshold +3dB

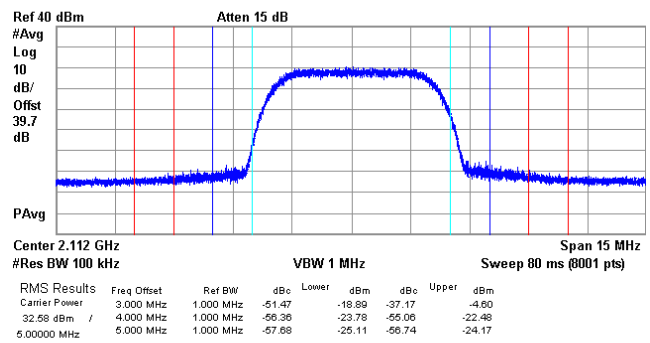
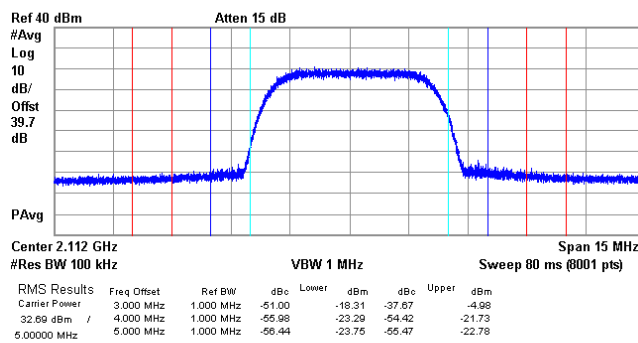
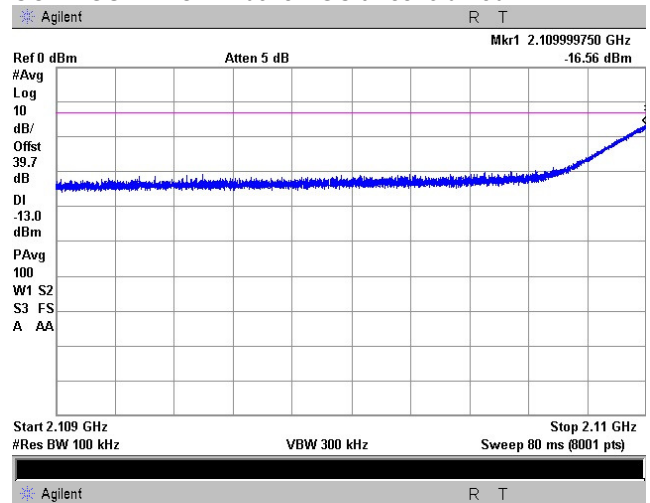
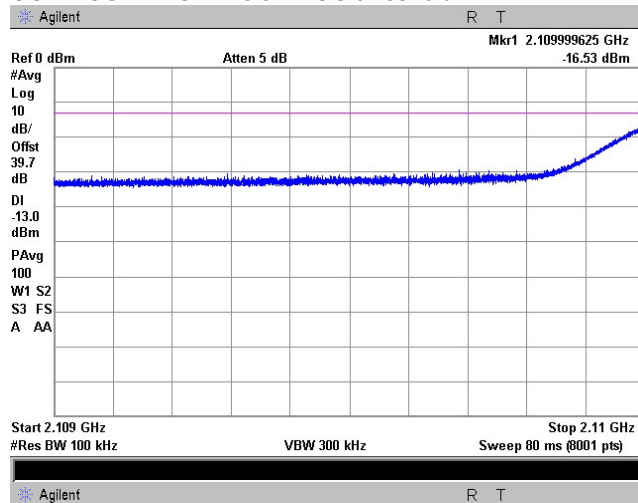



HERMON LABORATORIES

Test specification: Section 27.53, Out-of-band emissions conducted measurements			
Test procedure: 47 CFR, Sections 2.1051; KDB 935210 D05 v01r01, section 3.6.2			
Test mode: Compliance		Verdict: PASS	
Date(s): 11-Oct-16			
Temperature: 25 °C	Relative Humidity: 42 %	Air Pressure: 1014 hPa	Power: 48 VDC
Remarks:			

Plot 7.5.3 Out-of-band spurious emission test results at high carrier frequency, Upper band Edge

OPERATING FREQUENCY RANGE:

2110 – 2180 MHz

DETECTOR USED:

Average

CONFIGURATION:

Downlink

MODULATION:

AWGN/AWGN

COMPOSITE INPUT SIGNAL:

-19.4 dBm

CONFIGURATION: Below AGC threshold

CONFIGURATION: Above AGC threshold +3dB

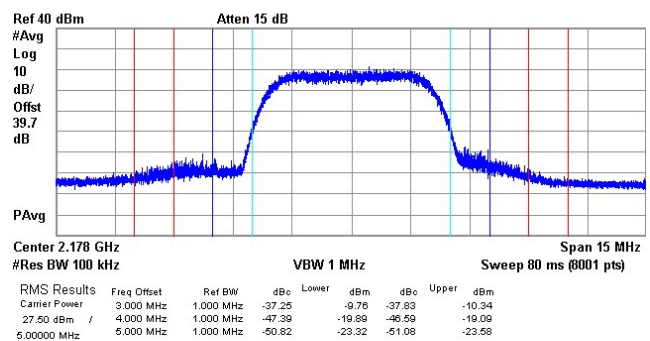
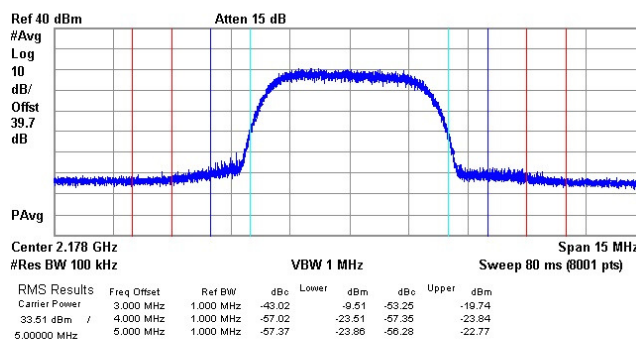
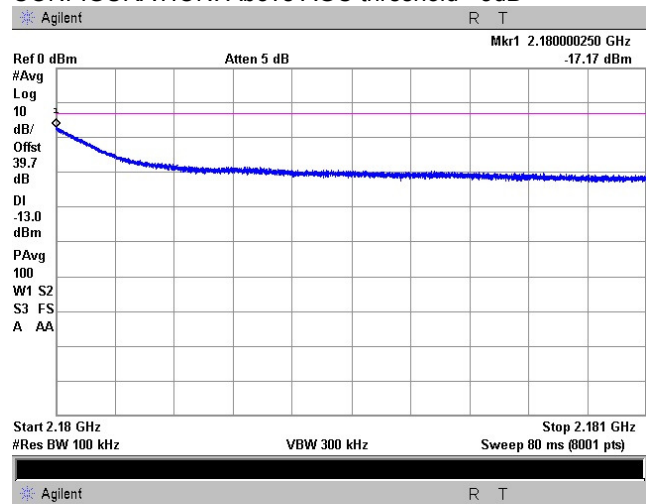
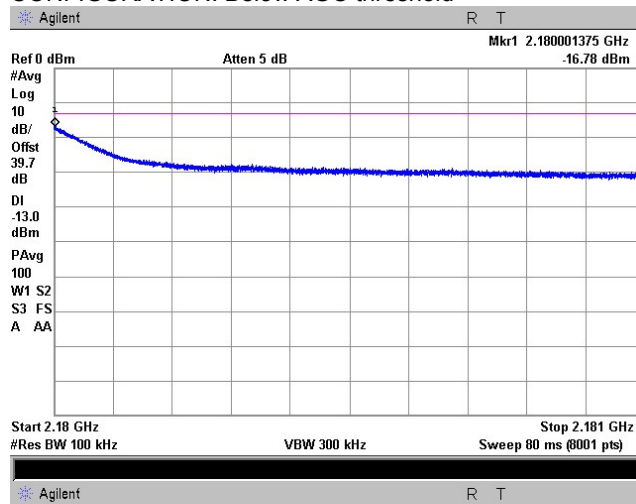



HERMON LABORATORIES

Test specification: Section 27.53, Out-of-band emissions conducted measurements			
Test procedure: 47 CFR, Sections 2.1051; KDB 935210 D05 v01r01, section 3.6.2			
Test mode: Compliance		Verdict: PASS	
Date(s): 11-Oct-16			
Temperature: 25 °C	Relative Humidity: 42 %	Air Pressure: 1014 hPa	Power: 48 VDC
Remarks:			

Plot 7.5.4 Out-of-band spurious emission test results at high carrier frequency, Upper band Edge

OPERATING FREQUENCY RANGE:
DETECTOR USED:
CONFIGURATION:
MODULATION:

2110 – 2180 MHz
Average
Downlink
AWGN/AWGN

SINGLE TEST SIGNAL INPUT:
CONFIGURATION: Below AGC threshold

-19.4 dBm
CONFIGURATION: Above AGC threshold +3dB

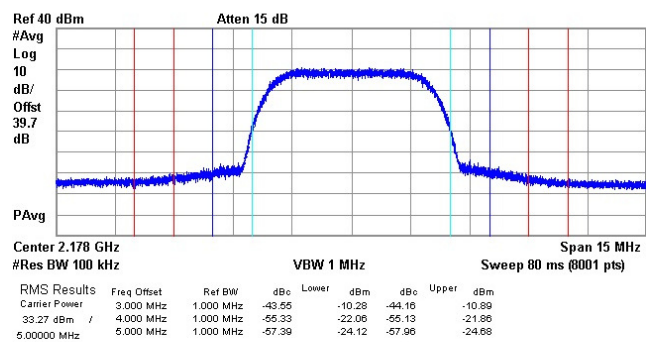
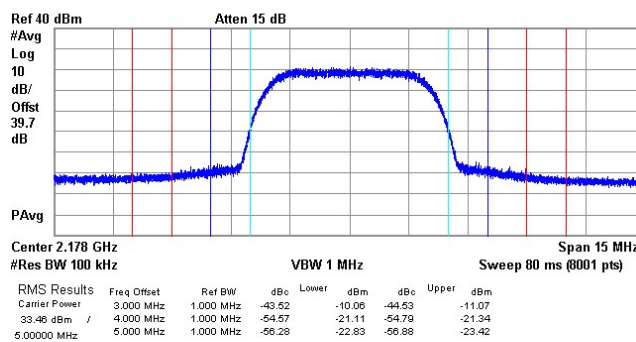
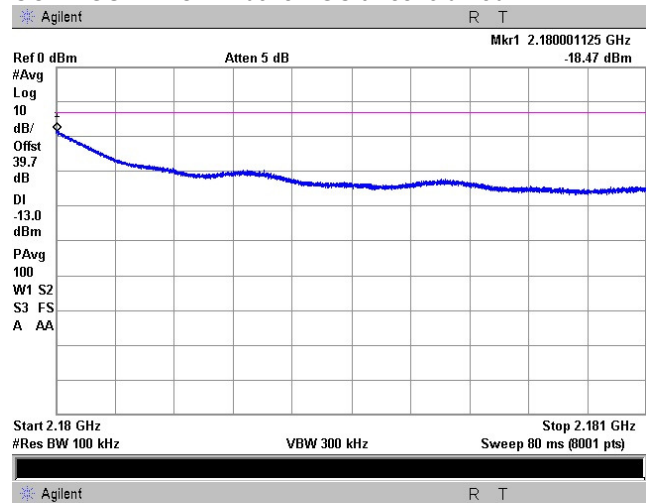
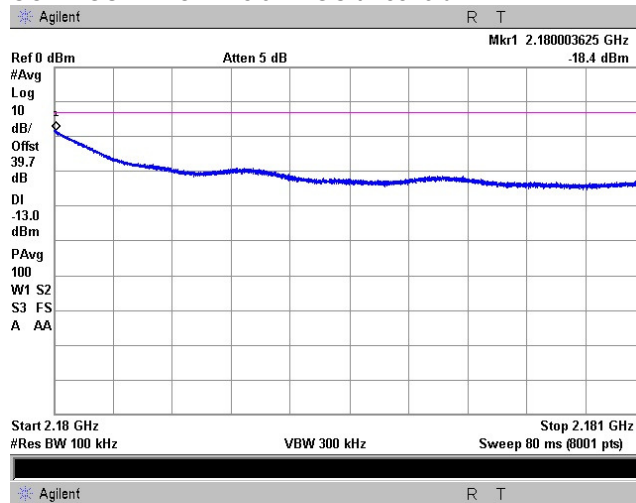



HERMON LABORATORIES

Test specification: Section 27.53, Out-of-band emissions conducted measurements			
Test procedure: 47 CFR, Sections 2.1051; KDB 935210 D05 v01r01, section 3.6.2			
Test mode: Compliance		Verdict: PASS	
Date(s): 11-Oct-16			
Temperature: 25 °C	Relative Humidity: 42 %	Air Pressure: 1014 hPa	Power: 48 VDC
Remarks:			

Plot 7.5.5 Out-of-band spurious emission test results at low carrier frequency, Lower band Edge

OPERATING FREQUENCY RANGE: 2110 – 2180 MHz
 DETECTOR USED: Average
 CONFIGURATION: Downlink
 MODULATION: GSM/GSM
 COMPOSITE INPUT SIGNAL: -19.4 dBm
 CONFIGURATION: Below AGC threshold
 CONFIGURATION: Above AGC threshold +3dB

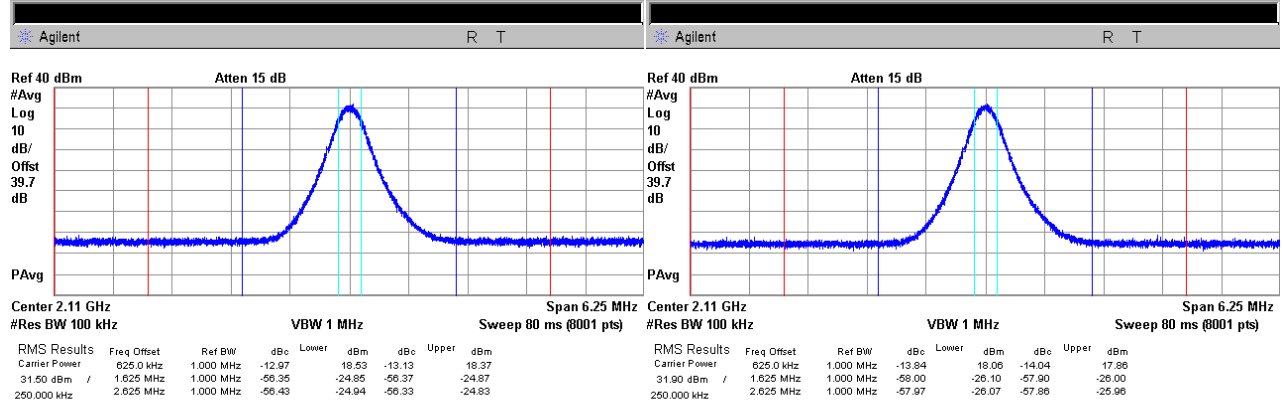
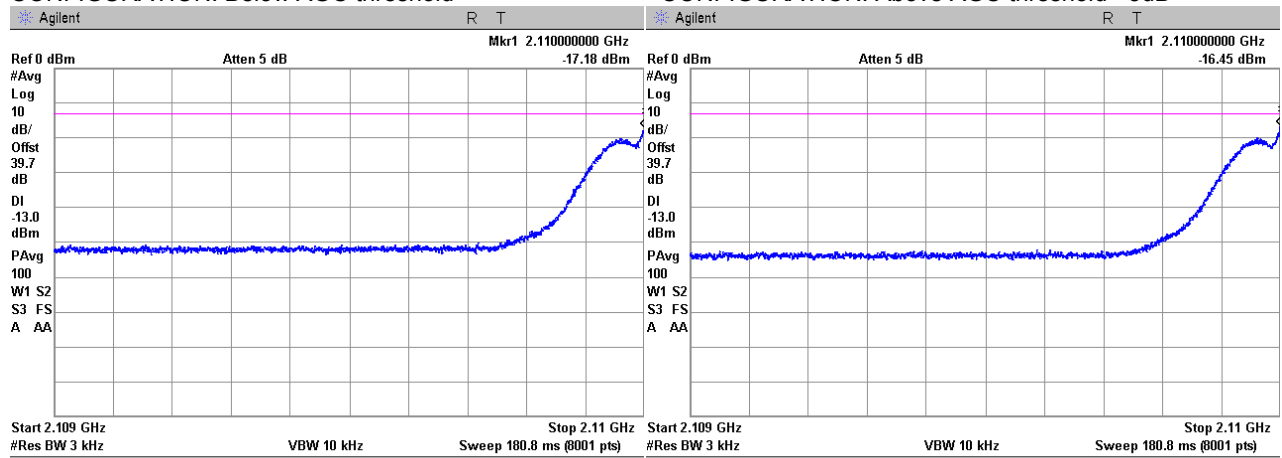



HERMON LABORATORIES

Test specification: Section 27.53, Out-of-band emissions conducted measurements			
Test procedure: 47 CFR, Sections 2.1051; KDB 935210 D05 v01r01, section 3.6.2			
Test mode: Compliance		Verdict: PASS	
Date(s): 11-Oct-16			
Temperature: 25 °C	Relative Humidity: 42 %	Air Pressure: 1014 hPa	Power: 48 VDC
Remarks:			

Plot 7.5.6 Out-of-band spurious emission test results at low carrier frequency, Lower band Edge

OPERATING FREQUENCY RANGE:
DETECTOR USED:
CONFIGURATION:
MODULATION:

2110 – 2180 MHz
Average
Downlink
GSM/GSM

SINGLE TEST SIGNAL INPUT:
CONFIGURATION: Below AGC threshold

-19.4 dBm
CONFIGURATION: Above AGC threshold +3dB

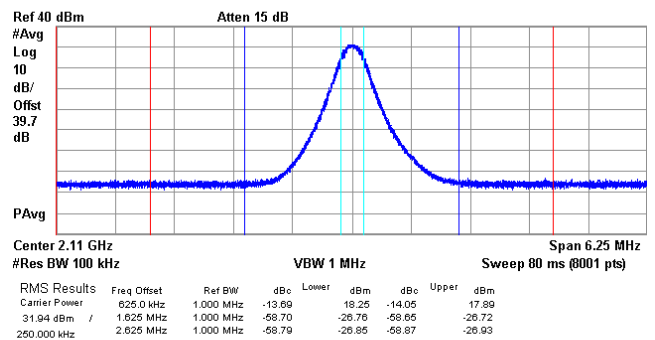
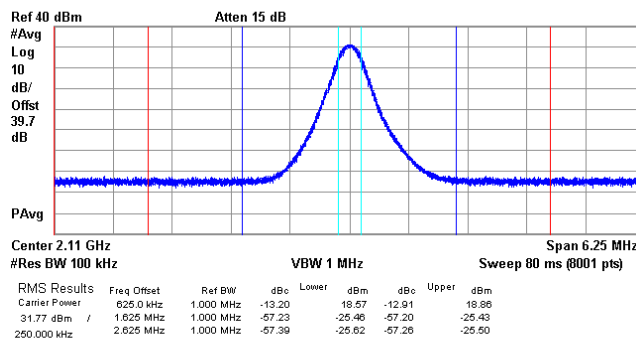
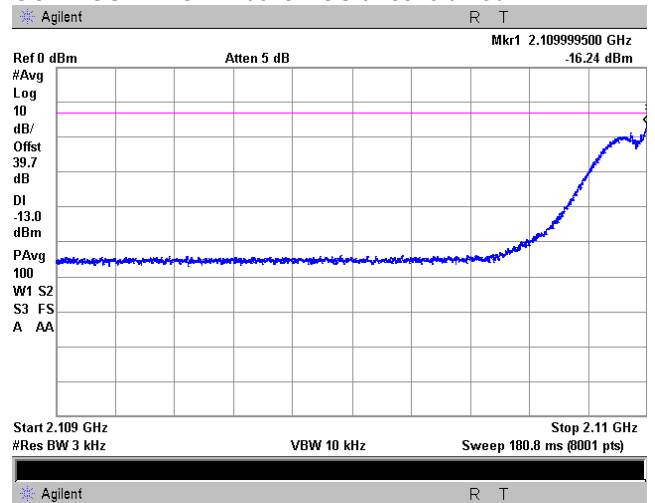
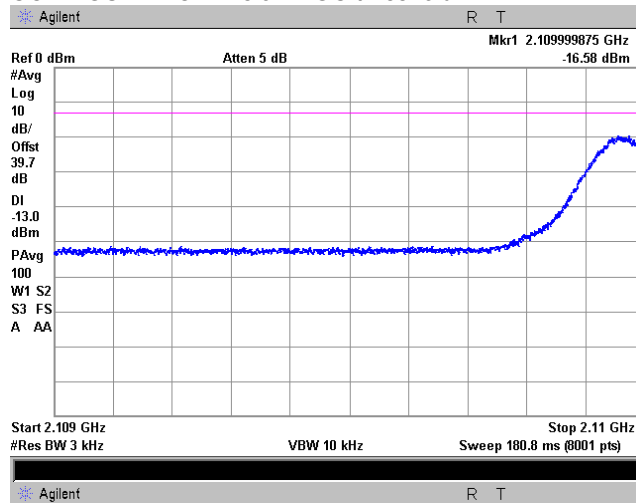



HERMON LABORATORIES

Test specification: Section 27.53, Out-of-band emissions conducted measurements			
Test procedure: 47 CFR, Sections 2.1051; KDB 935210 D05 v01r01, section 3.6.2			
Test mode: Compliance		Verdict: PASS	
Date(s): 11-Oct-16			
Temperature: 25 °C	Relative Humidity: 42 %	Air Pressure: 1014 hPa	Power: 48 VDC
Remarks:			

Plot 7.5.7 Out-of-band spurious emission test results at high carrier frequency, Upper band Edge

OPERATING FREQUENCY RANGE:

2110 – 2180 MHz

DETECTOR USED:

Average

CONFIGURATION:

Downlink

MODULATION:

GSM/GSM

COMPOSITE INPUT SIGNAL:

-19.4 dBm

CONFIGURATION: Below AGC threshold

CONFIGURATION: Above AGC threshold +3dB

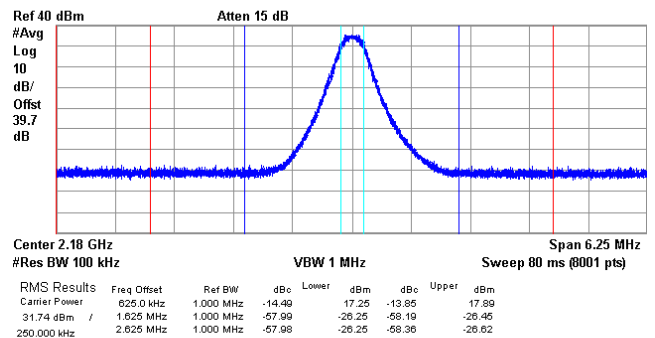
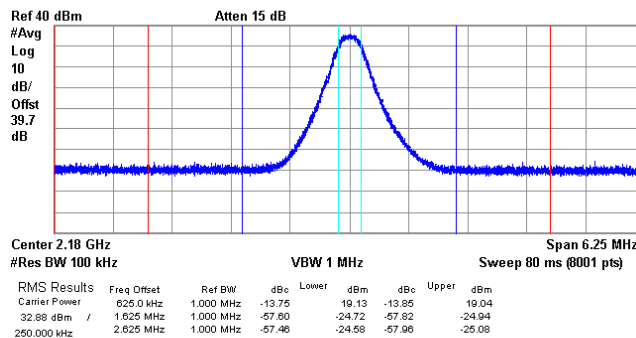
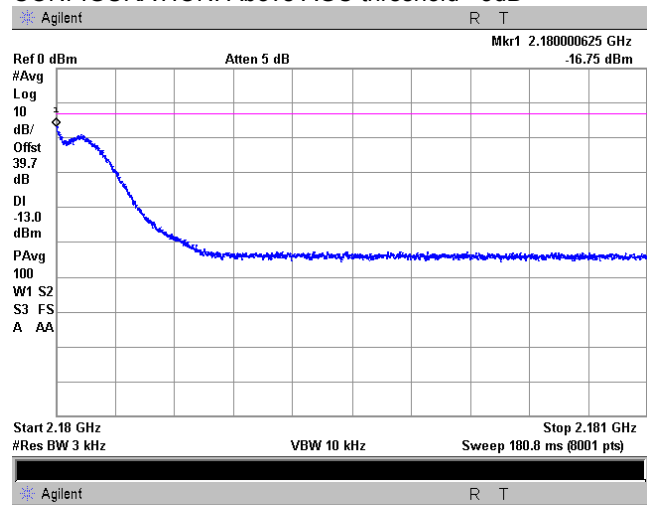
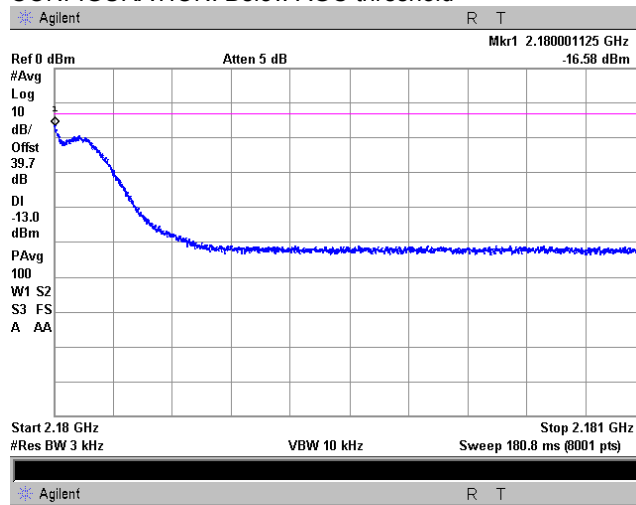



HERMON LABORATORIES

Test specification: Section 27.53, Out-of-band emissions conducted measurements			
Test procedure: 47 CFR, Sections 2.1051; KDB 935210 D05 v01r01, section 3.6.2			
Test mode: Compliance		Verdict: PASS	
Date(s): 11-Oct-16			
Temperature: 25 °C	Relative Humidity: 42 %	Air Pressure: 1014 hPa	Power: 48 VDC
Remarks:			

Plot 7.5.8 Out-of-band spurious emission test results at high carrier frequency, Upper band Edge

OPERATING FREQUENCY RANGE:
DETECTOR USED:
CONFIGURATION:
MODULATION:

2110 – 2180 MHz
Average
Downlink
GSM/GSM

SINGLE TEST SIGNAL INPUT:
CONFIGURATION: Below AGC threshold

-19.4 dBm
CONFIGURATION: Above AGC threshold +3dB

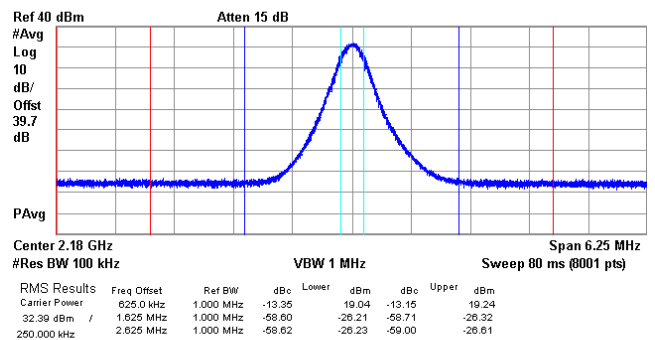
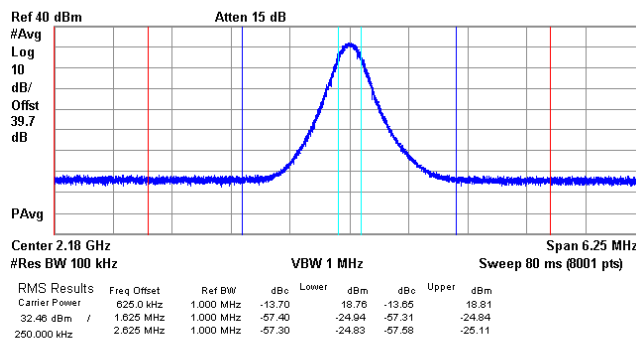
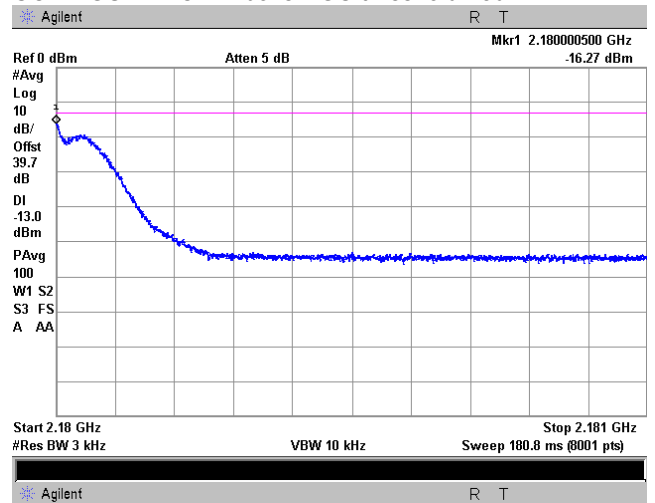
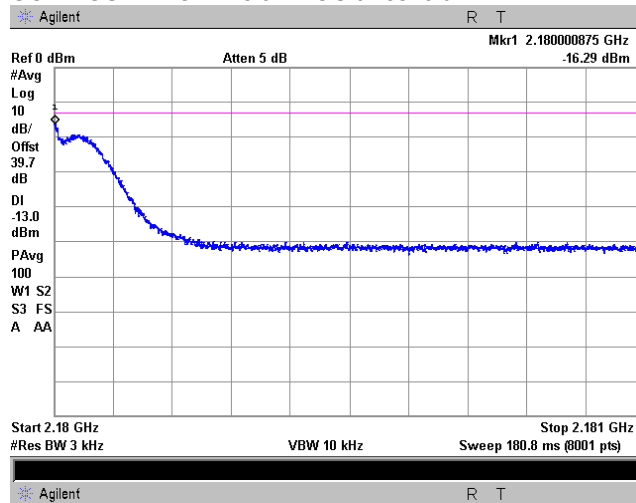



HERMON LABORATORIES

Test specification: Section 27.53, Out-of-band emissions conducted measurements			
Test procedure: 47 CFR, Sections 2.1051; KDB 935210 D05 v01r01, section 3.6.2			
Test mode: Compliance		Verdict: PASS	
Date(s): 11-Oct-16			
Temperature: 25 °C	Relative Humidity: 42 %	Air Pressure: 1014 hPa	Power: 48 VDC
Remarks:			

Plot 7.5.9 Out-of-band spurious emission test results at low carrier frequency, Lower band Edge

OPERATING FREQUENCY RANGE:

2110 – 2180 MHz

DETECTOR USED:

Average

CONFIGURATION:

Downlink

MODULATION:

WCDMA/WCDMA

COMPOSITE INPUT SIGNAL:

-19.4 dBm

CONFIGURATION: Below AGC threshold

CONFIGURATION: Above AGC threshold +3dB

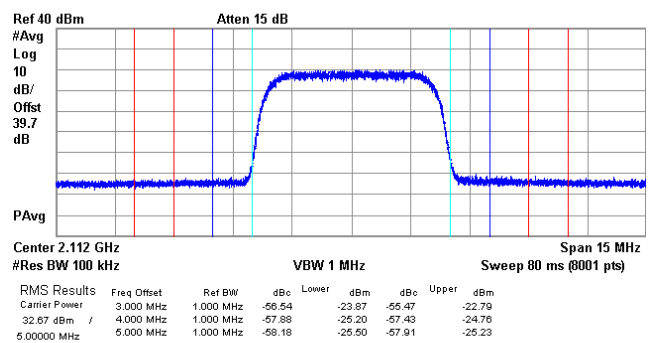
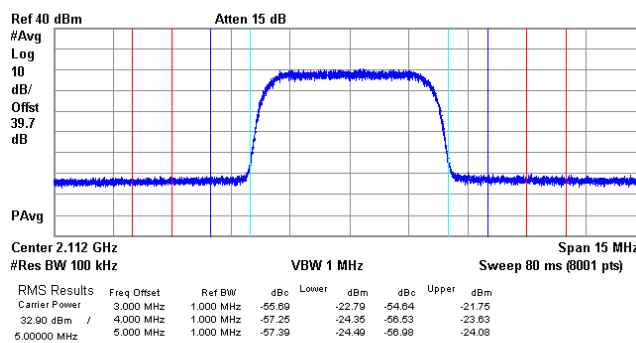
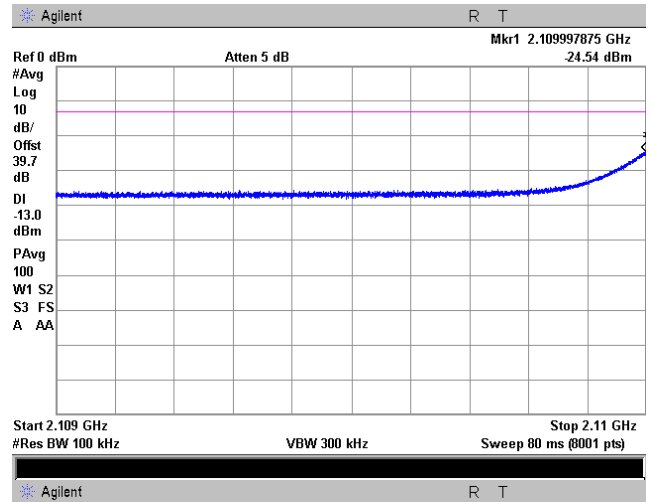
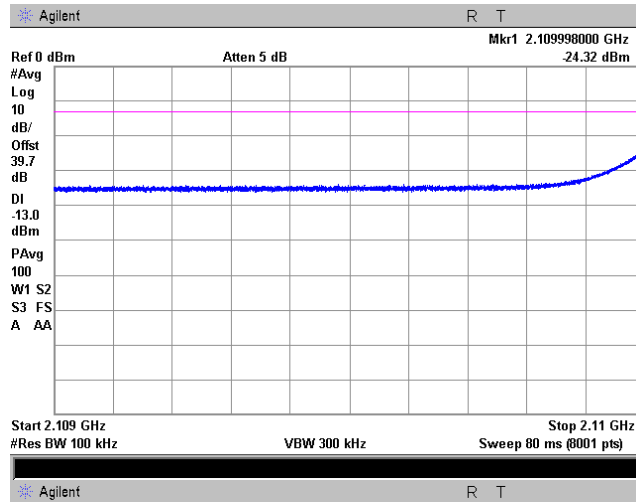



HERMON LABORATORIES

Test specification: Section 27.53, Out-of-band emissions conducted measurements			
Test procedure: 47 CFR, Sections 2.1051; KDB 935210 D05 v01r01, section 3.6.2			
Test mode: Compliance		Verdict: PASS	
Date(s): 11-Oct-16			
Temperature: 25 °C	Relative Humidity: 42 %	Air Pressure: 1014 hPa	Power: 48 VDC
Remarks:			

Plot 7.5.10 Out-of-band spurious emission test results at low carrier frequency, Lower band Edge

OPERATING FREQUENCY RANGE:

2110 – 2180 MHz

DETECTOR USED:

Average

CONFIGURATION:

Downlink

MODULATION:

WCDMA/WCDMA

SINGLE TEST SIGNAL INPUT:

-19.4 dBm

CONFIGURATION: Below AGC threshold

CONFIGURATION: Above AGC threshold +3dB

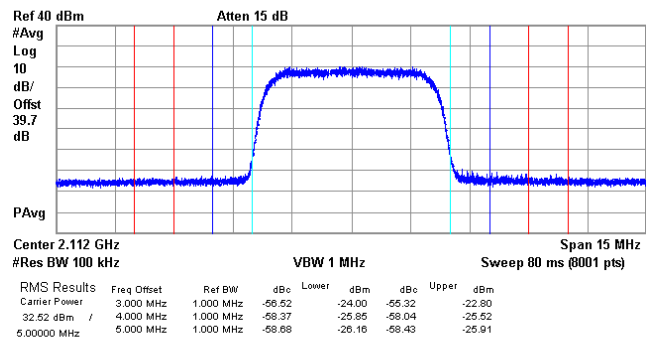
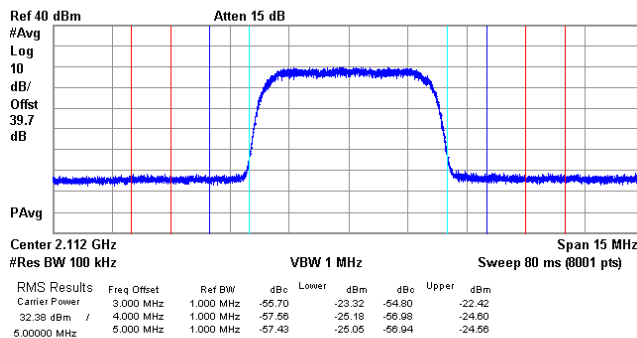
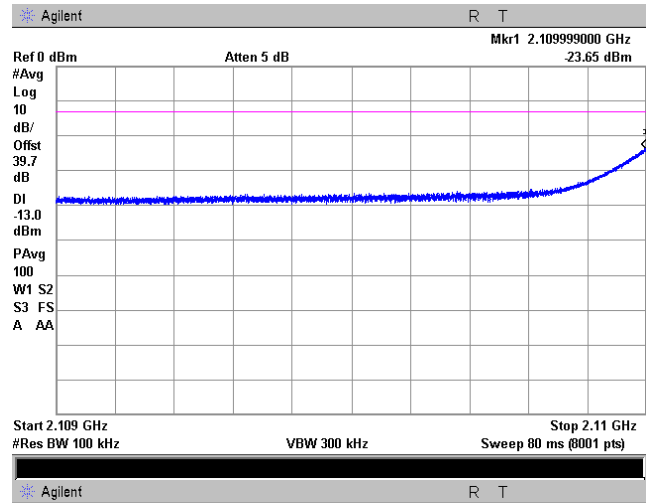
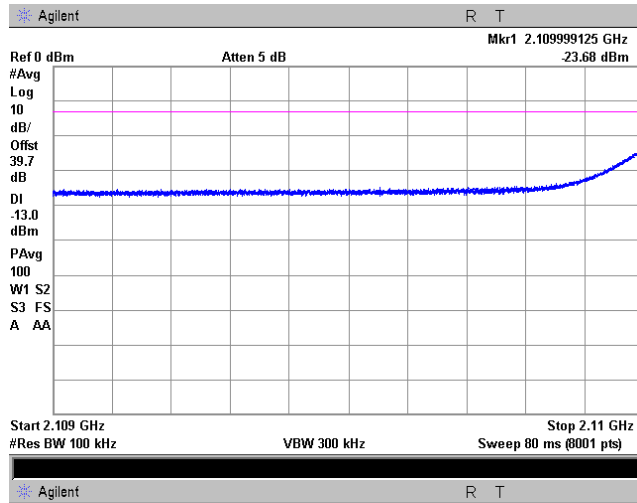



HERMON LABORATORIES

Test specification: Section 27.53, Out-of-band emissions conducted measurements			
Test procedure: 47 CFR, Sections 2.1051; KDB 935210 D05 v01r01, section 3.6.2			
Test mode: Compliance		Verdict: PASS	
Date(s): 11-Oct-16			
Temperature: 25 °C	Relative Humidity: 42 %	Air Pressure: 1014 hPa	Power: 48 VDC
Remarks:			

Plot 7.5.11 Intermodulation test results in the 2110.0 – 2180.0 MHz frequency range, Upper band Edge

OPERATING FREQUENCY RANGE:

DETECTOR USED:

CONFIGURATION:

MODULATION:

COMPOSITE INPUT SIGNAL:

CONFIGURATION: Below AGC threshold

2110 – 2180 MHz

Average

Downlink

WCDMA/WCDMA

-19.4 dBm

CONFIGURATION: Above AGC threshold +3dB

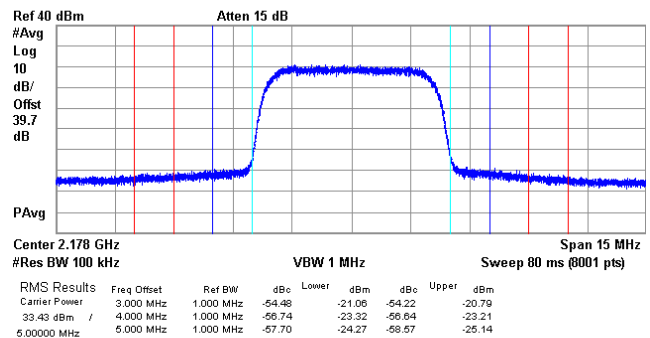
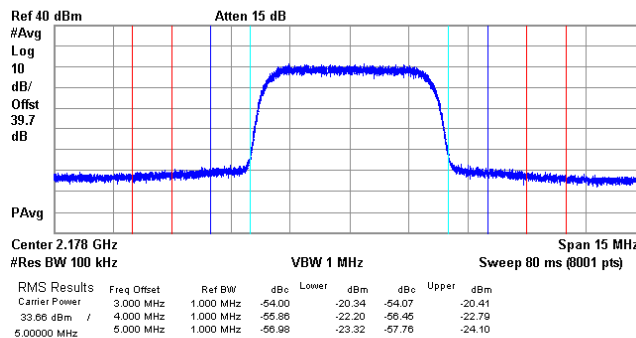
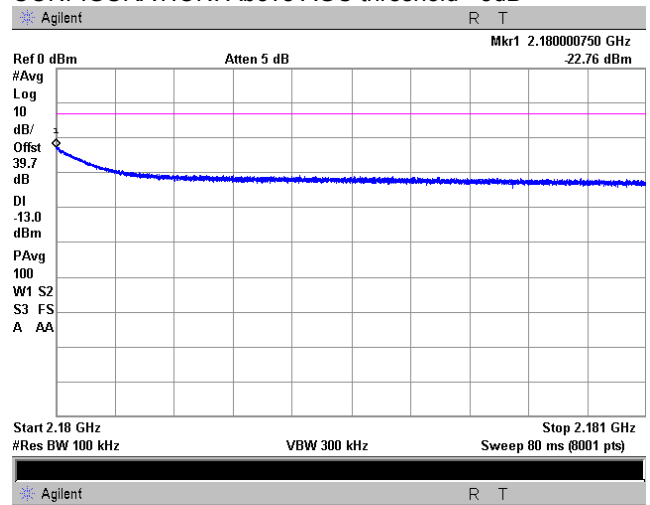
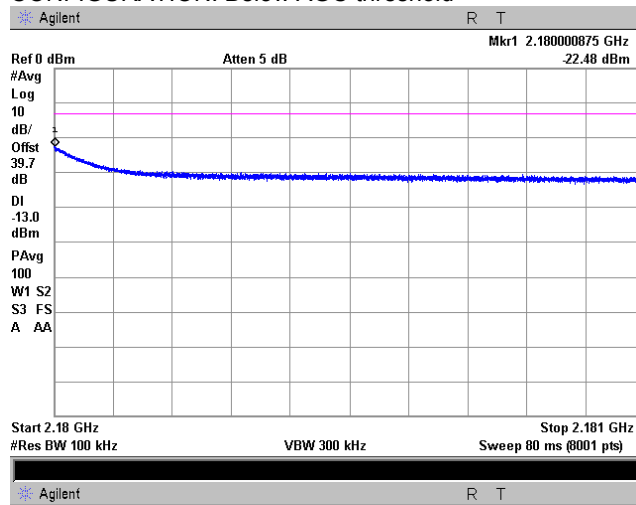



HERMON LABORATORIES

Test specification: Section 27.53, Out-of-band emissions conducted measurements			
Test procedure: 47 CFR, Sections 2.1051; KDB 935210 D05 v01r01, section 3.6.2			
Test mode: Compliance		Verdict: PASS	
Date(s): 11-Oct-16			
Temperature: 25 °C	Relative Humidity: 42 %	Air Pressure: 1014 hPa	Power: 48 VDC
Remarks:			

Plot 7.5.12 Intermodulation test results in the 2110.0 – 2180.0 MHz frequency range, Upper band Edge

OPERATING FREQUENCY RANGE:
DETECTOR USED:
CONFIGURATION:
MODULATION:

2110 – 2180 MHz
Average
Downlink
WCDMA/WCDMA

SINGLE TEST SIGNAL INPUT:
CONFIGURATION: Below AGC threshold

-19.4 dBm
CONFIGURATION: Above AGC threshold +3dB

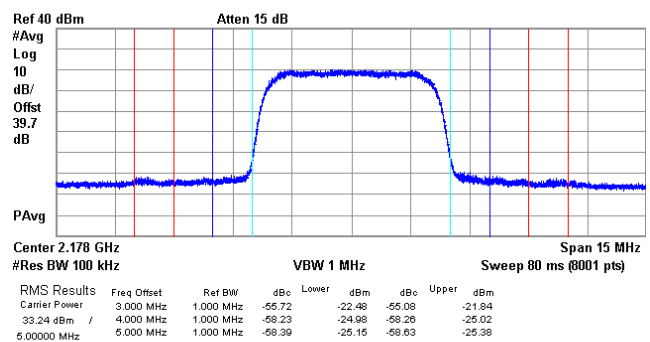
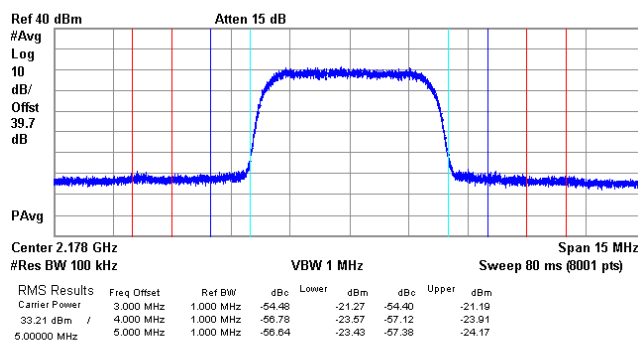
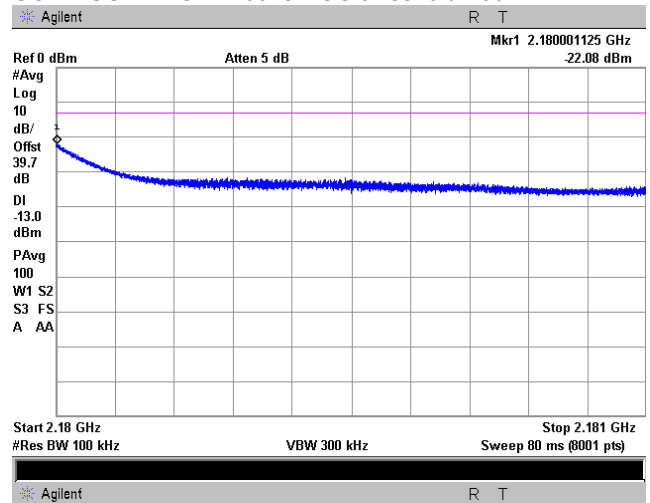
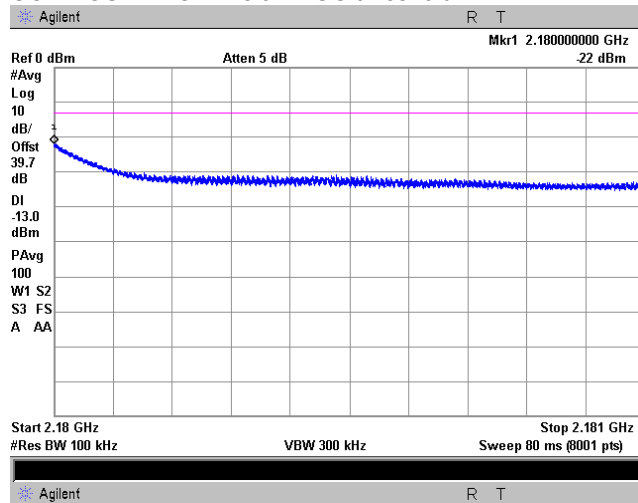



Test specification: Section 27.53, Spurious emissions conducted measurements			
Test procedure: 47 CFR, Sections 2.1051; KDB 935210 D05 v01r01 section 3.6.3			
Test mode: Compliance		Verdict: PASS	
Date(s): 27-Sep-16			
Temperature: 28 °C	Relative Humidity: 43 %	Air Pressure: 1012 hPa	Power: 48 VDC
Remarks:			

7.6 Spurious emissions at RF antenna connector test

7.6.1 General

This test was performed to measure spurious emissions at RF antenna connector. Specification test limits are given in Table 7.6.1.

Table 7.6.1 Spurious emission limits

Frequency, MHz	Attenuation below carrier, dBc	Spurious emissions, dBm
0.009 – 10th harmonic*	43+10logP**	-13.0

* - spurious emission limits do not apply to the in band emission within ± 250 % of the authorized bandwidth from the carrier; investigated in course of emission mask testing

** - P is a transmitter output power in watts.

7.6.2 Test procedure

7.6.2.1 The EUT was set up as shown in Figure 7.6.1, energized and its proper operation was checked.

7.6.2.2 The EUT was adjusted to produce maximum available for end user RF output power.

7.6.2.3 The spurious emission was measured with spectrum analyzer as provided in Table 7.6.2 and associated plots.

Figure 7.6.1 Spurious emission test setup, single output

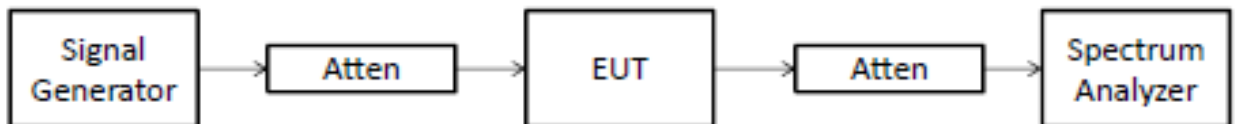



Test specification: Section 27.53, Spurious emissions conducted measurements			
Test procedure: 47 CFR, Sections 2.1051; KDB 935210 D05 v01r01 section 3.6.3			
Test mode: Compliance		Verdict: PASS	
Date(s): 27-Sep-16			
Temperature: 28 °C	Relative Humidity: 43 %	Air Pressure: 1012 hPa	Power: 48 VDC
Remarks:			

Table 7.6.2 Spurious emission test results

ASSIGNED FREQUENCY RANGE: 2110.0 – 2180.0 MHz
 INVESTIGATED FREQUENCY RANGE: 0.009 – 22000 MHz
 DETECTOR USED: Peak
 VIDEO BANDWIDTH: ≥ Resolution bandwidth
 TRANSMITTER OUTPUT POWER SETTINGS: Maximum
 NUMBER OF CHAINS: N = 2

MODULATION: AWGN

Frequency, MHz	SA reading, dBm	Attenuation, dB	Cable loss, dB	RBW, kHz	Spurious emission, dBm*	Limit, dBm	Margin, dB**	Verdict
Low carrier frequency								
2106.72	-17.39	Included	Included	1000	-14.39	-13.0	-1.39	Pass
2183.10	-17.54	Included	Included	1000	-14.54	-13.0	-1.54	Pass
Mid carrier frequency								
2106.03	-16.49	Included	Included	1000	-13.49	-13.0	-0.49	Pass
2183.31	-16.34	Included	Included	1000	-13.34	-13.0	-0.34	Pass
High carrier frequency								
2104.51	-16.06	Included	Included	1000	-13.06	-13.0	-0.06	Pass
2183.31	-16.66	Included	Included	1000	-13.66	-13.0	-0.66	Pass

MODULATION: GSM

Frequency, MHz	SA reading, dBm	Attenuation, dB	Cable loss, dB	RBW, kHz	Spurious emission, dBm*	Limit, dBm	Margin, dB**	Verdict
Low carrier frequency								
2103.68	-17.11	Included	Included	1000	-14.11	-13.0	-1.11	Pass
2185.96	-18.57	Included	Included	1000	-15.87	-13.0	-2.87	Pass
Mid carrier frequency								
2106.45	-17.32	Included	Included	1000	-14.32	-13.0	-1.32	Pass
2184.63	-17.53	Included	Included	1000	-14.53	-13.0	-1.53	Pass
High carrier frequency								
2105.89	-17.99	Included	Included	1000	-14.99	-13.0	-1.99	Pass
2183.10	-16.29	Included	Included	1000	-3.29	-13.0	-0.29	Pass

MODULATION: WCDMA

Frequency, MHz	SA reading, dBm	Attenuation, dB	Cable loss, dB	RBW, kHz	Spurious emission, dBm*	Limit, dBm	Margin, dB**	Verdict
Low carrier frequency								
2106.86	-17.01	Included	Included	1000	-14.01	-13.0	-1.01	Pass
2184.43	-18.90	Included	Included	1000	-15.90	-13.0	-2.90	Pass
Mid carrier frequency								
2106.17	-16.25	Included	Included	1000	-13.25	-13.0	-0.25	Pass
2183.71	-17.32	Included	Included	1000	-14.32	-13.0	-1.	Pass
High carrier frequency								
2107.00	-18.82	Included	Included	1000	-15.82	-13.0	-2.82	Pass
2183.31	-16.62	Included	Included	1000	-13.62	-13.0	-0.62	Pass

*- Margin = Spurious emission – specification limit.

**- Spurious emission = SA reading + 10*log(N)

Reference numbers of test equipment used

HL 2909	HL 3433	HL 3787	HL 3788	HL 3901	HL 4354		
---------	---------	---------	---------	---------	---------	--	--

Full description is given in Appendix A.



HERMON LABORATORIES

Test specification: Section 27.53, Spurious emissions conducted measurements			
Test procedure: 47 CFR, Sections 2.1051; KDB 935210 D05 v01r01 section 3.6.3			
Test mode: Compliance		Verdict: PASS	
Date(s): 27-Sep-16			
Temperature: 28 °C	Relative Humidity: 43 %	Air Pressure: 1012 hPa	Power: 48 VDC
Remarks:			

Plot 7.6.1 Spurious emission measurements in 9 - 150 kHz range at low carrier frequency

FREQUENCY RANGE:
OPERATIONAL MODE:
CONFIGURATION:

2110 – 2180 MHz
AWGN downlink transmit
Below AGC level

CARRIER FREQUENCY: Low

CARRIER FREQUENCY: Mid

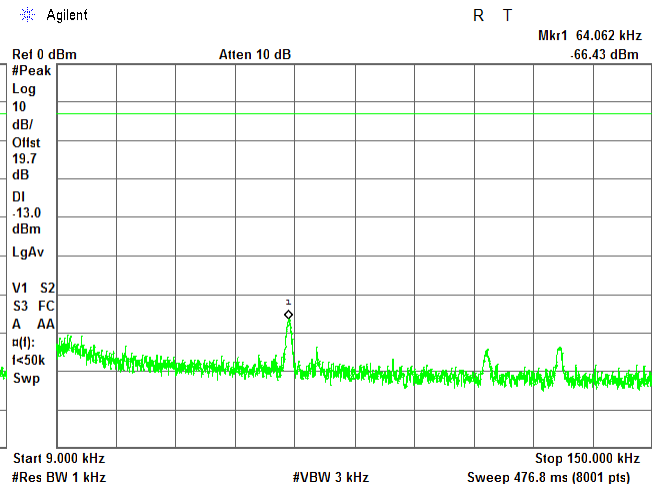
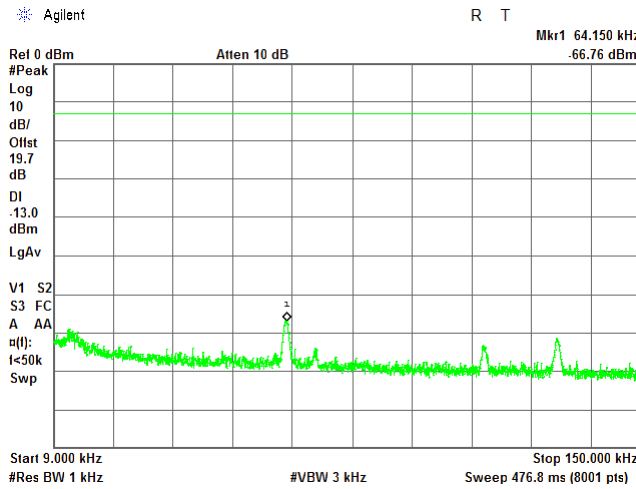

CARRIER FREQUENCY: High

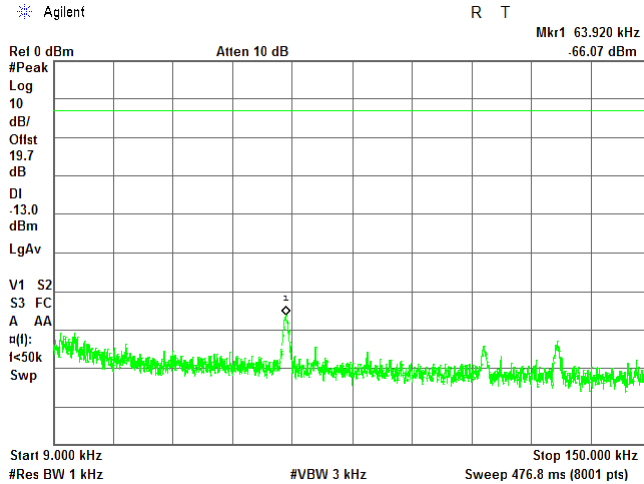



HERMON LABORATORIES

Test specification: Section 27.53, Spurious emissions conducted measurements			
Test procedure: 47 CFR, Sections 2.1051; KDB 935210 D05 v01r01 section 3.6.3			
Test mode: Compliance		Verdict: PASS	
Date(s): 27-Sep-16			
Temperature: 28 °C	Relative Humidity: 43 %	Air Pressure: 1012 hPa	Power: 48 VDC
Remarks:			

Plot 7.6.2 Spurious emission measurements in 0.15 - 30.0 MHz range at low carrier frequency

FREQUENCY RANGE: 2110 – 2180 MHz
 OPERATIONAL MODE: AWGN downlink transmit
 CONFIGURATION: Below AGC level

CARRIER FREQUENCY: Low

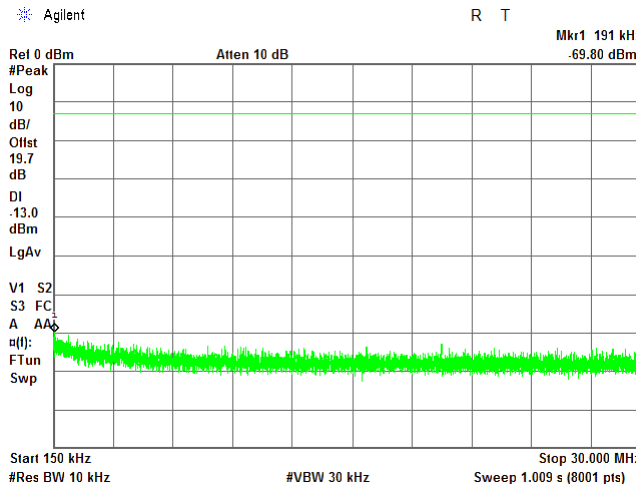

CARRIER FREQUENCY: Mid

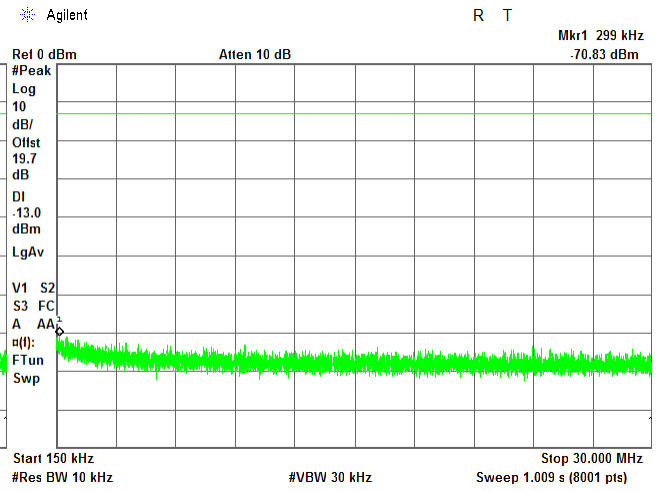

CARRIER FREQUENCY: High

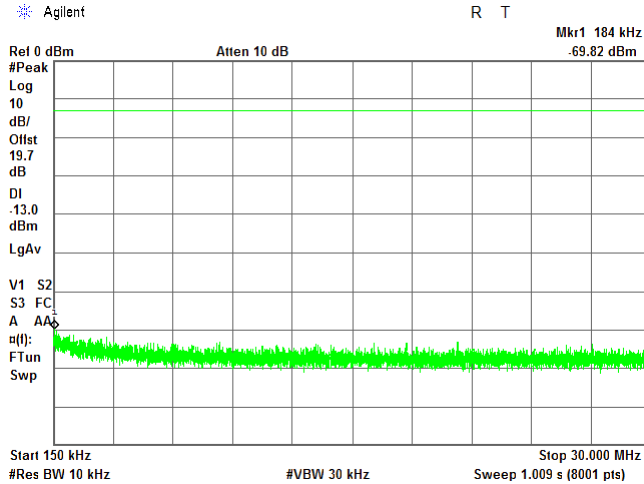



HERMON LABORATORIES

Test specification: Section 27.53, Spurious emissions conducted measurements			
Test procedure: 47 CFR, Sections 2.1051; KDB 935210 D05 v01r01 section 3.6.3			
Test mode: Compliance		Verdict: PASS	
Date(s): 27-Sep-16			
Temperature: 28 °C	Relative Humidity: 43 %	Air Pressure: 1012 hPa	Power: 48 VDC
Remarks:			

Plot 7.6.3 Spurious emission measurements in 30.0 - 1000 MHz range at low carrier frequency

FREQUENCY RANGE: 2110 – 2180 MHz
 OPERATIONAL MODE: AWGN downlink transmit
 CONFIGURATION: Below AGC level

CARRIER FREQUENCY: Low

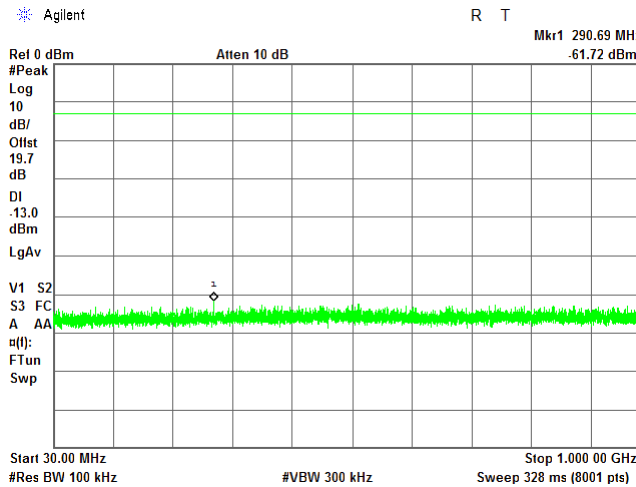

CARRIER FREQUENCY: Mid

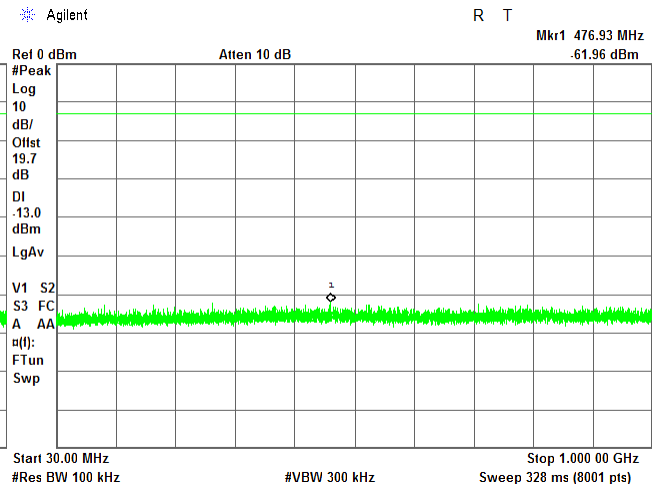

CARRIER FREQUENCY: High

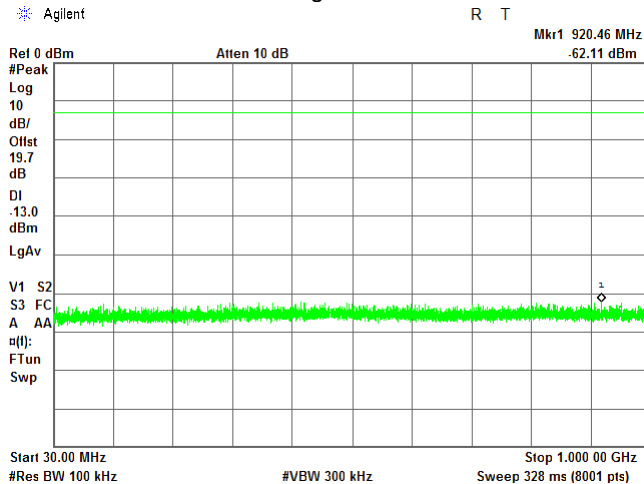



HERMON LABORATORIES

Test specification: Section 27.53, Spurious emissions conducted measurements			
Test procedure: 47 CFR, Sections 2.1051; KDB 935210 D05 v01r01 section 3.6.3			
Test mode: Compliance		Verdict: PASS	
Date(s): 27-Sep-16			
Temperature: 28 °C	Relative Humidity: 43 %	Air Pressure: 1012 hPa	Power: 48 VDC
Remarks:			

Plot 7.6.4 Spurious emission measurements in 1000 - 2107 MHz range at low carrier frequency

FREQUENCY RANGE:
OPERATIONAL MODE:
CONFIGURATION:

2110 – 2180 MHz
AWGN downlink transmit
Below AGC level

CARRIER FREQUENCY: Low

CARRIER FREQUENCY: Mid

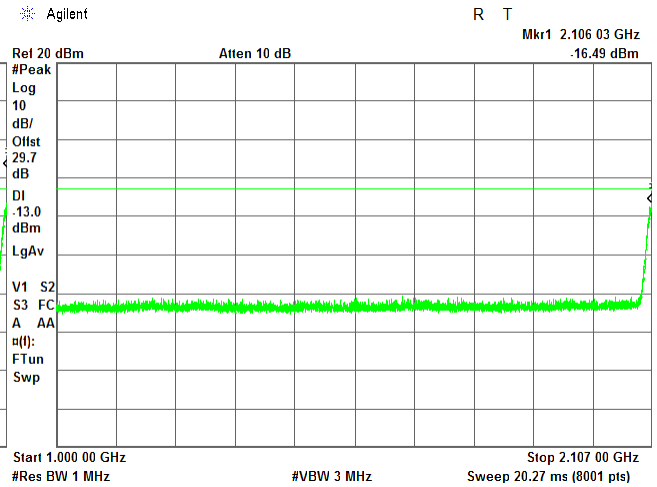
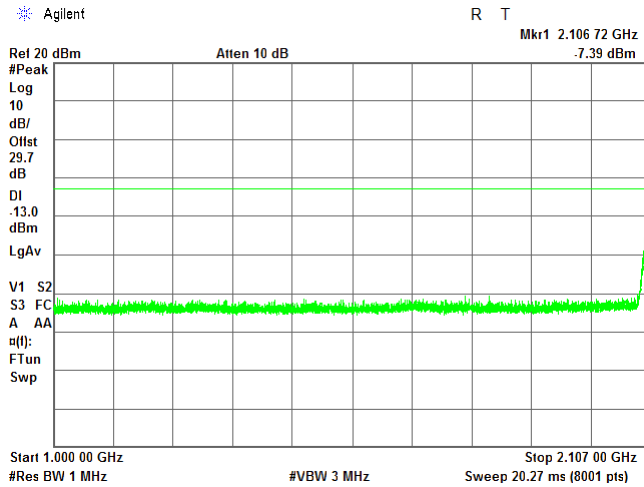

CARRIER FREQUENCY: High

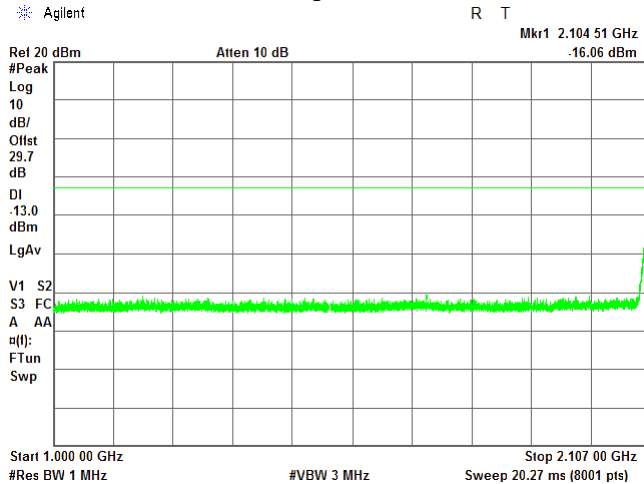



HERMON LABORATORIES

Test specification: Section 27.53, Spurious emissions conducted measurements			
Test procedure: 47 CFR, Sections 2.1051; KDB 935210 D05 v01r01 section 3.6.3			
Test mode: Compliance		Verdict: PASS	
Date(s): 27-Sep-16			
Temperature: 28 °C	Relative Humidity: 43 %	Air Pressure: 1012 hPa	Power: 48 VDC
Remarks:			

Plot 7.6.5 Spurious emission measurements in 2183 - 3000 MHz range at low carrier frequency

FREQUENCY RANGE:
OPERATIONAL MODE:
CONFIGURATION:

2110 – 2180 MHz
AWGN downlink transmit
Below AGC level

CARRIER FREQUENCY: Low

CARRIER FREQUENCY: Mid

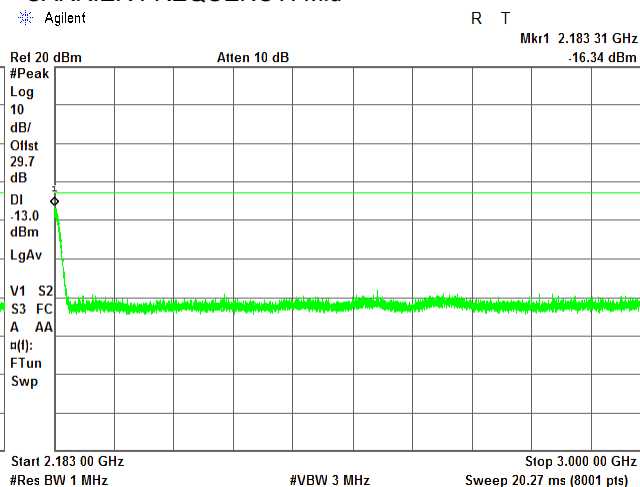
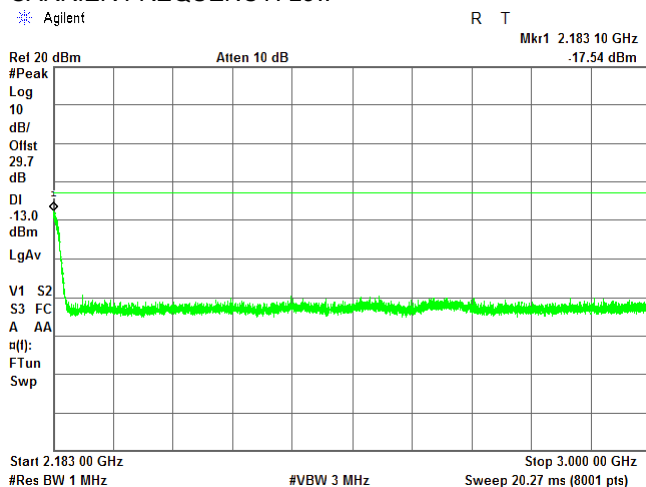

CARRIER FREQUENCY: High

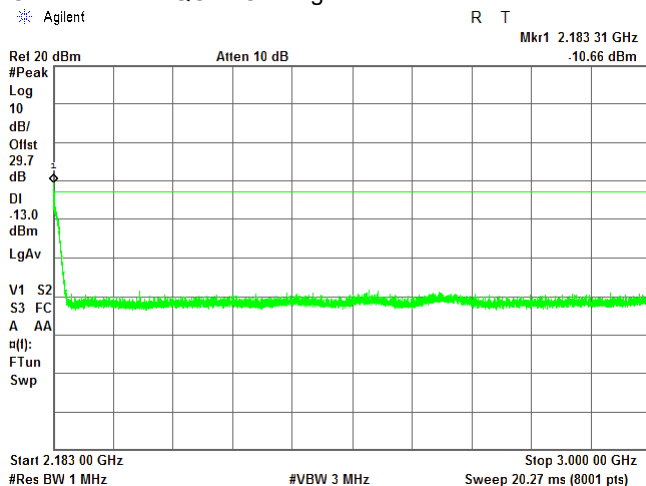



HERMON LABORATORIES

Test specification: Section 27.53, Spurious emissions conducted measurements			
Test procedure: 47 CFR, Sections 2.1051; KDB 935210 D05 v01r01 section 3.6.3			
Test mode: Compliance		Verdict: PASS	
Date(s): 27-Sep-16			
Temperature: 28 °C	Relative Humidity: 43 %	Air Pressure: 1012 hPa	Power: 48 VDC
Remarks:			

Plot 7.6.6 Spurious emission measurements in 3000 - 10000 MHz range at carrier frequency

FREQUENCY RANGE:
OPERATIONAL MODE:
CONFIGURATION:

2110 – 2180 MHz
AWGN downlink transmit
Below AGC level

CARRIER FREQUENCY: Low

CARRIER FREQUENCY: Mid

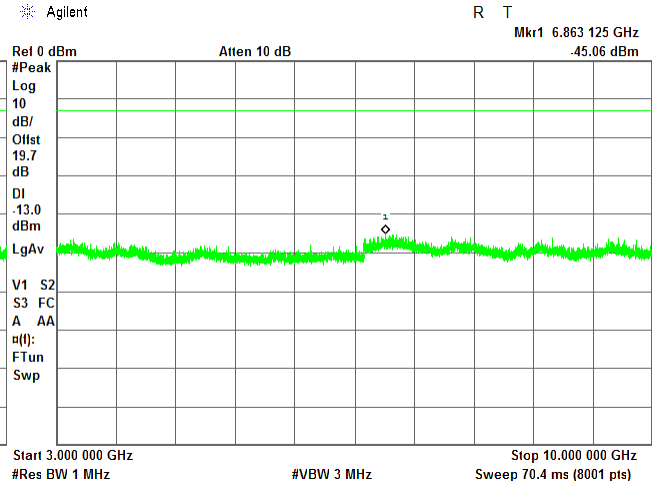
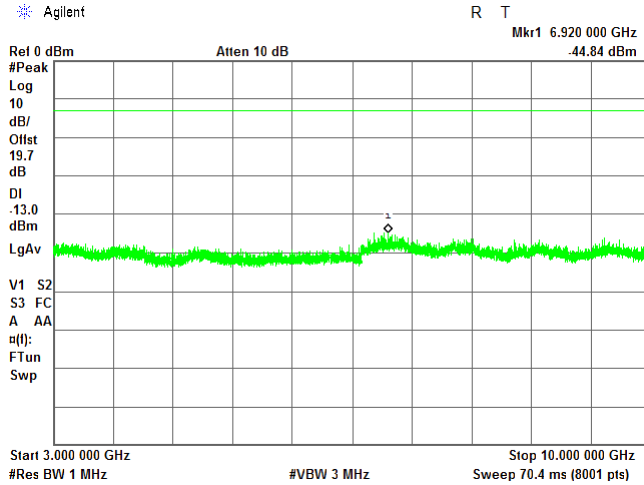

CARRIER FREQUENCY: High

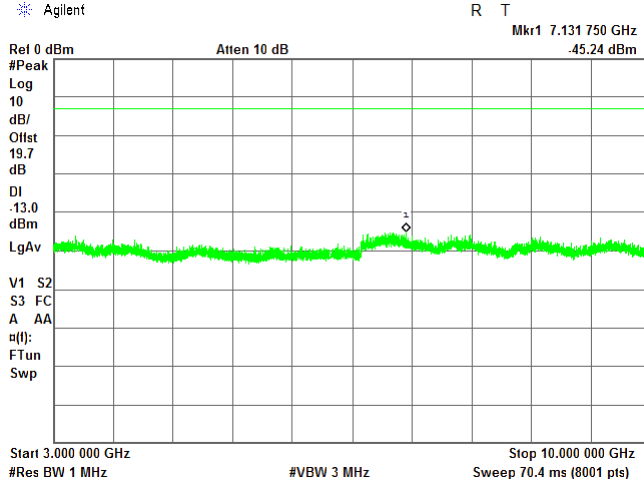



HERMON LABORATORIES

Test specification: Section 27.53, Spurious emissions conducted measurements			
Test procedure: 47 CFR, Sections 2.1051; KDB 935210 D05 v01r01 section 3.6.3			
Test mode: Compliance		Verdict: PASS	
Date(s): 27-Sep-16			
Temperature: 28 °C	Relative Humidity: 43 %	Air Pressure: 1012 hPa	Power: 48 VDC
Remarks:			

Plot 7.6.7 Spurious emission measurements in 10000 - 22000 MHz range at carrier frequency

FREQUENCY RANGE:
OPERATIONAL MODE:
CONFIGURATION:

2110 – 2180 MHz
AWGN downlink transmit
Below AGC level

CARRIER FREQUENCY: Low

CARRIER FREQUENCY: Mid

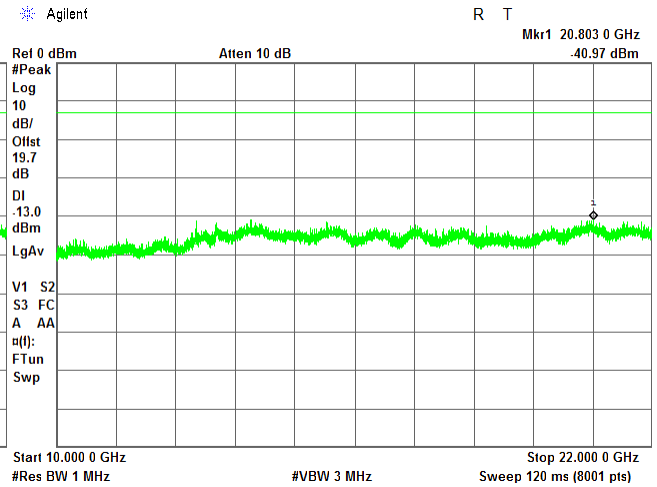
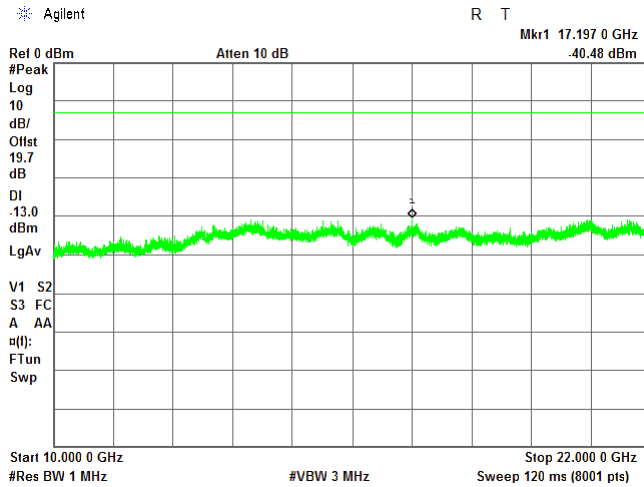

CARRIER FREQUENCY: High

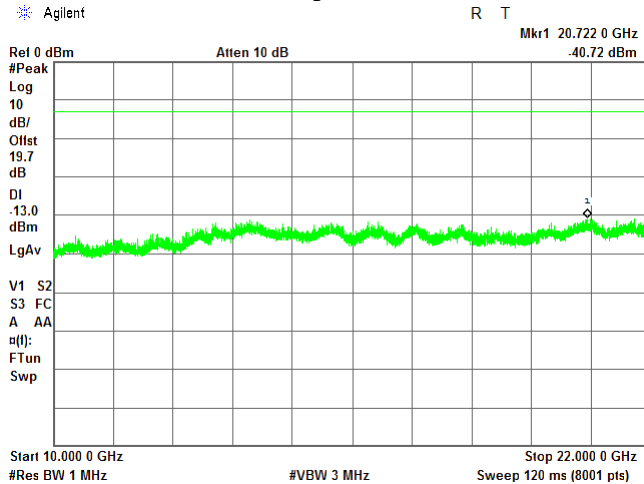



HERMON LABORATORIES

Test specification: Section 27.53, Spurious emissions conducted measurements			
Test procedure: 47 CFR, Sections 2.1051; KDB 935210 D05 v01r01 section 3.6.3			
Test mode: Compliance		Verdict: PASS	
Date(s): 27-Sep-16			
Temperature: 28 °C	Relative Humidity: 43 %	Air Pressure: 1012 hPa	Power: 48 VDC
Remarks:			

Plot 7.6.8 Spurious emission measurements in 9 - 150 kHz range at carrier frequency

FREQUENCY RANGE:
OPERATIONAL MODE:
CONFIGURATION:

2110 – 2180 MHz
GSM downlink transmit
Below AGC level

CARRIER FREQUENCY: Low

CARRIER FREQUENCY: Mid

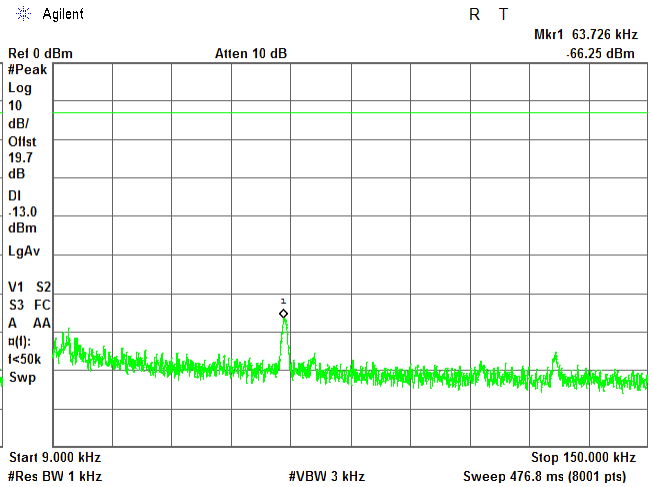
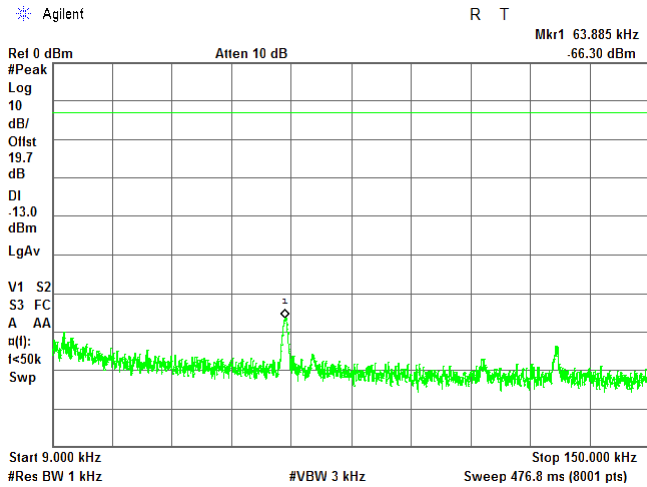

CARRIER FREQUENCY: High

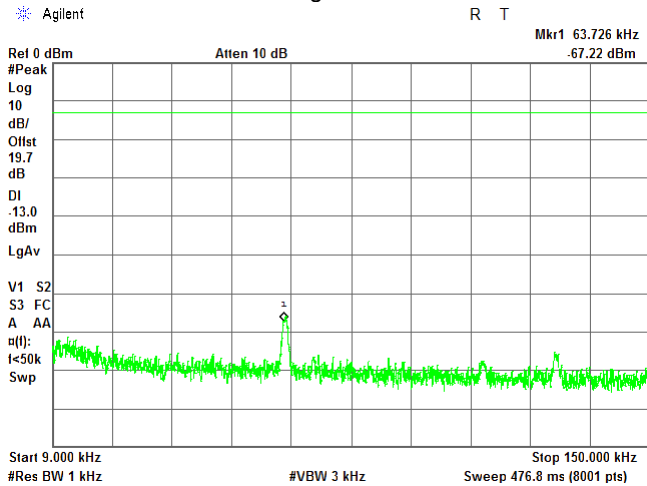



HERMON LABORATORIES

Test specification: Section 27.53, Spurious emissions conducted measurements			
Test procedure: 47 CFR, Sections 2.1051; KDB 935210 D05 v01r01 section 3.6.3			
Test mode: Compliance		Verdict: PASS	
Date(s): 27-Sep-16			
Temperature: 28 °C	Relative Humidity: 43 %	Air Pressure: 1012 hPa	Power: 48 VDC
Remarks:			

Plot 7.6.9 Spurious emission measurements in 0.15 - 30.0 MHz range at carrier frequency

FREQUENCY RANGE:
OPERATIONAL MODE:
CONFIGURATION:

2110 – 2180 MHz
GSM downlink transmit
Below AGC level

CARRIER FREQUENCY: Low

CARRIER FREQUENCY: Mid

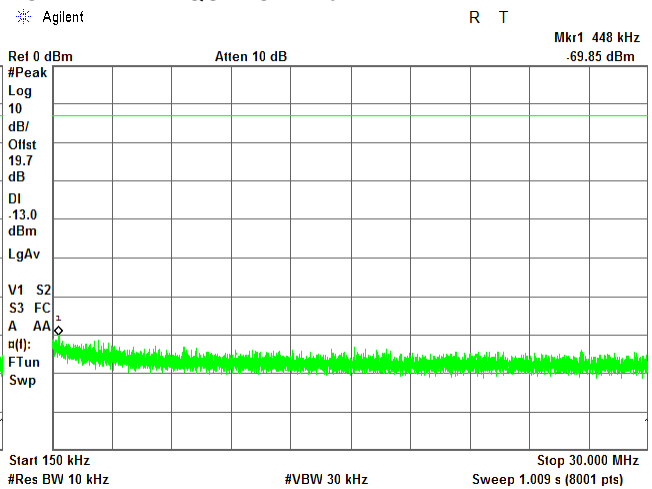
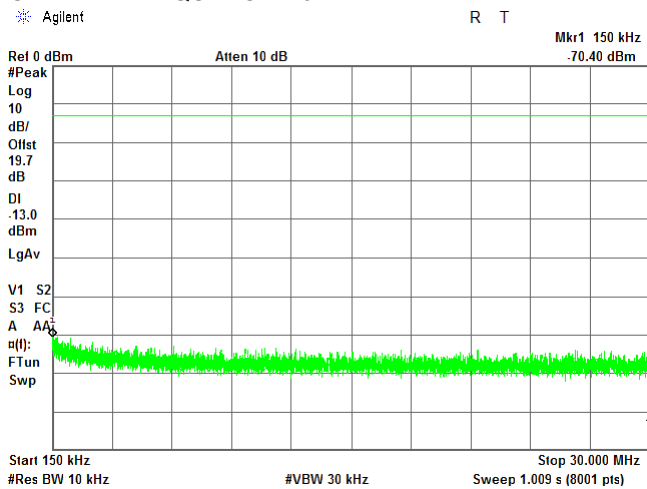

CARRIER FREQUENCY: High

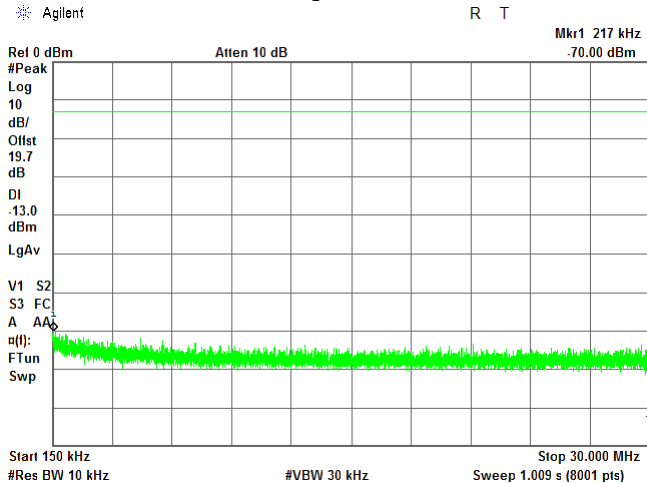



HERMON LABORATORIES

Test specification: Section 27.53, Spurious emissions conducted measurements			
Test procedure: 47 CFR, Sections 2.1051; KDB 935210 D05 v01r01 section 3.6.3			
Test mode: Compliance		Verdict: PASS	
Date(s): 27-Sep-16			
Temperature: 28 °C	Relative Humidity: 43 %	Air Pressure: 1012 hPa	Power: 48 VDC
Remarks:			

Plot 7.6.10 Spurious emission measurements in 30.0 - 1000 MHz range at carrier frequency

FREQUENCY RANGE:
OPERATIONAL MODE:
CONFIGURATION:

2110 – 2180 MHz
GSM downlink transmit
Below AGC level

CARRIER FREQUENCY: Low

CARRIER FREQUENCY: Mid

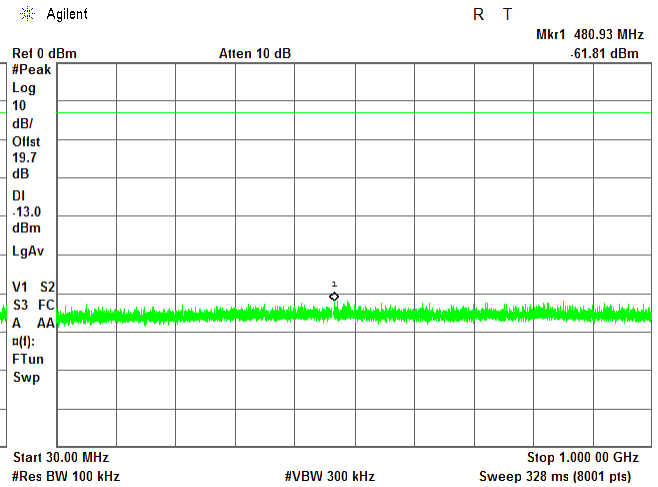
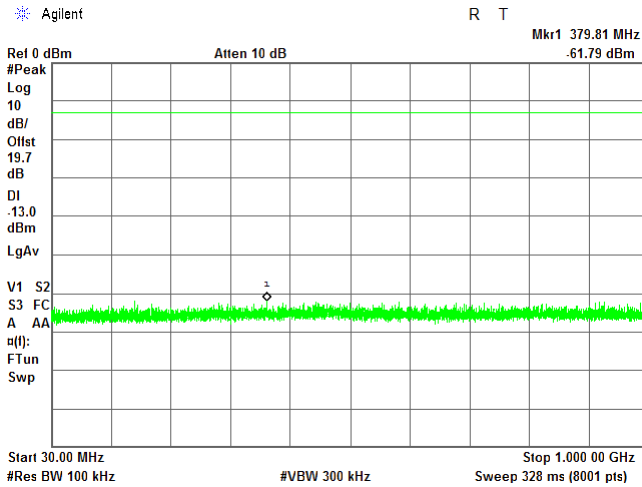

CARRIER FREQUENCY: High

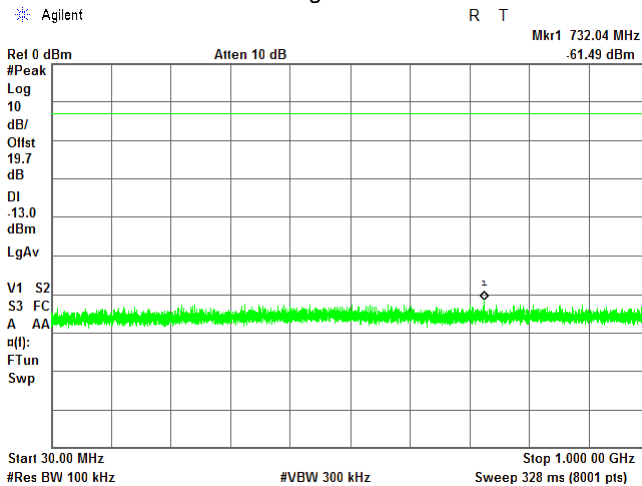



HERMON LABORATORIES

Test specification: Section 27.53, Spurious emissions conducted measurements			
Test procedure: 47 CFR, Sections 2.1051; KDB 935210 D05 v01r01 section 3.6.3			
Test mode: Compliance		Verdict: PASS	
Date(s): 27-Sep-16			
Temperature: 28 °C	Relative Humidity: 43 %	Air Pressure: 1012 hPa	Power: 48 VDC
Remarks:			

Plot 7.6.11 Spurious emission measurements in 1000 - 2107 MHz range at carrier frequency

FREQUENCY RANGE:
OPERATIONAL MODE:
CONFIGURATION:

2110 – 2180 MHz
GSM downlink transmit
Below AGC level

CARRIER FREQUENCY: Low

CARRIER FREQUENCY: Mid

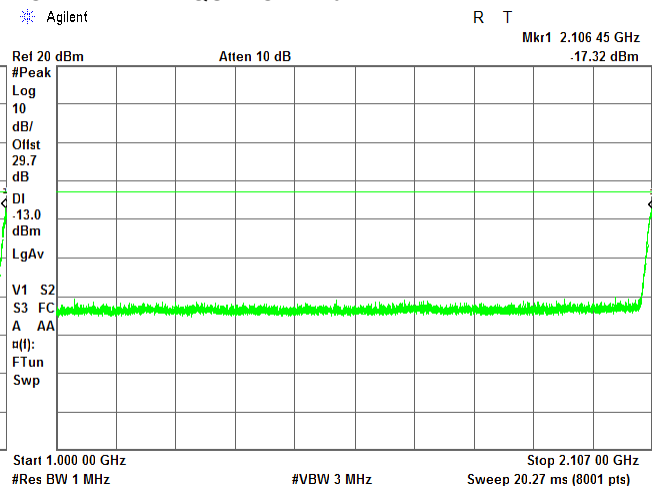
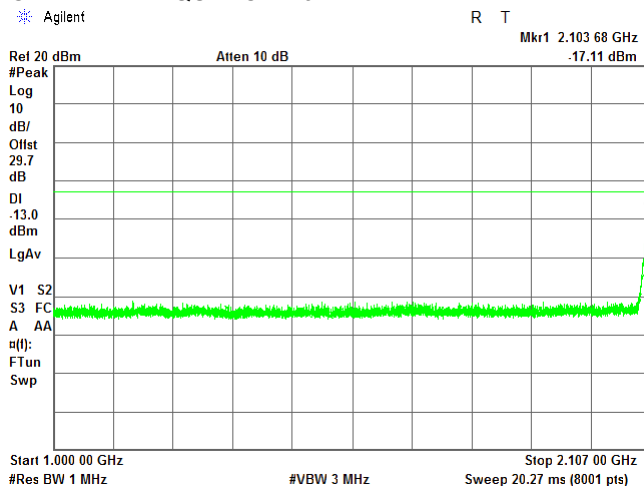

CARRIER FREQUENCY: High

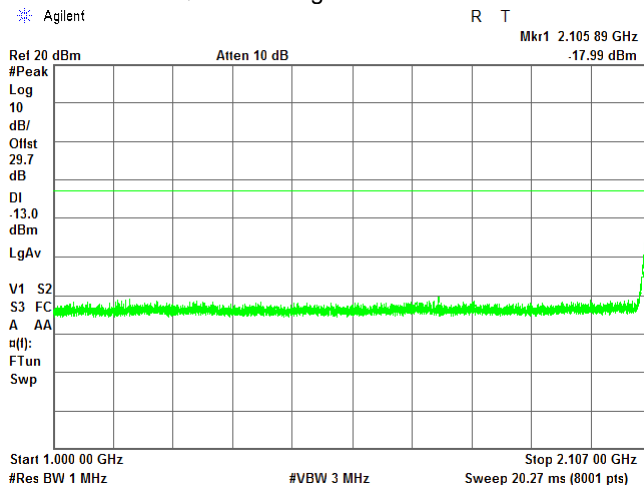



HERMON LABORATORIES

Test specification: Section 27.53, Spurious emissions conducted measurements			
Test procedure: 47 CFR, Sections 2.1051; KDB 935210 D05 v01r01 section 3.6.3			
Test mode: Compliance		Verdict: PASS	
Date(s): 27-Sep-16			
Temperature: 28 °C	Relative Humidity: 43 %	Air Pressure: 1012 hPa	Power: 48 VDC
Remarks:			

Plot 7.6.12 Spurious emission measurements in 2183 - 3000 MHz range at carrier frequency

FREQUENCY RANGE:
OPERATIONAL MODE:
CONFIGURATION:

2110 – 2180 MHz
GSM downlink transmit
Below AGC level

CARRIER FREQUENCY: Low

CARRIER FREQUENCY: Mid

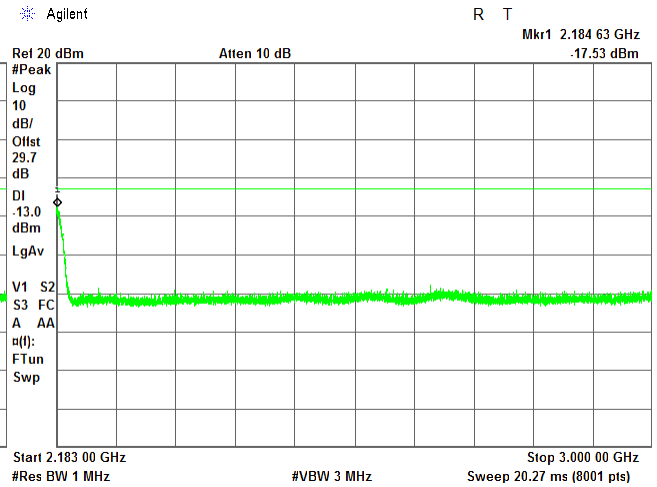
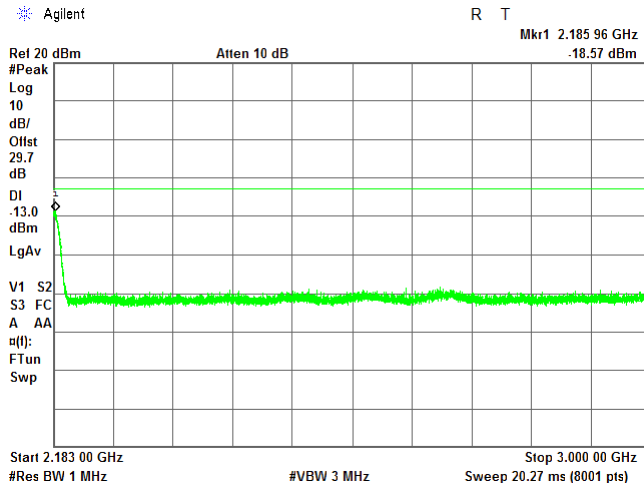

CARRIER FREQUENCY: High

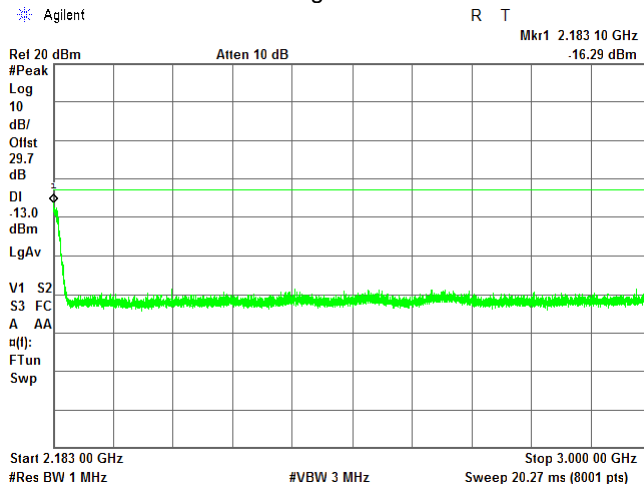



HERMON LABORATORIES

Test specification: Section 27.53, Spurious emissions conducted measurements			
Test procedure: 47 CFR, Sections 2.1051; KDB 935210 D05 v01r01 section 3.6.3			
Test mode: Compliance		Verdict: PASS	
Date(s): 27-Sep-16			
Temperature: 28 °C	Relative Humidity: 43 %	Air Pressure: 1012 hPa	Power: 48 VDC
Remarks:			

Plot 7.6.13 Spurious emission measurements in 3000 - 10000 MHz range at carrier frequency

FREQUENCY RANGE:
OPERATIONAL MODE:
CONFIGURATION:

2110 – 2180 MHz
GSM downlink transmit
Below AGC level

CARRIER FREQUENCY: Low

CARRIER FREQUENCY: Mid

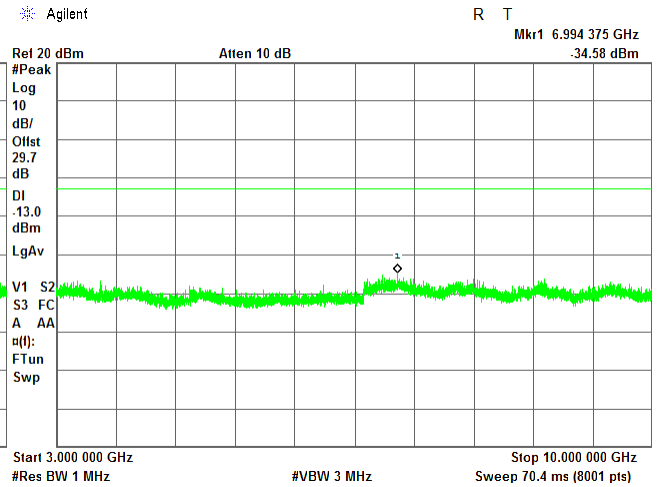
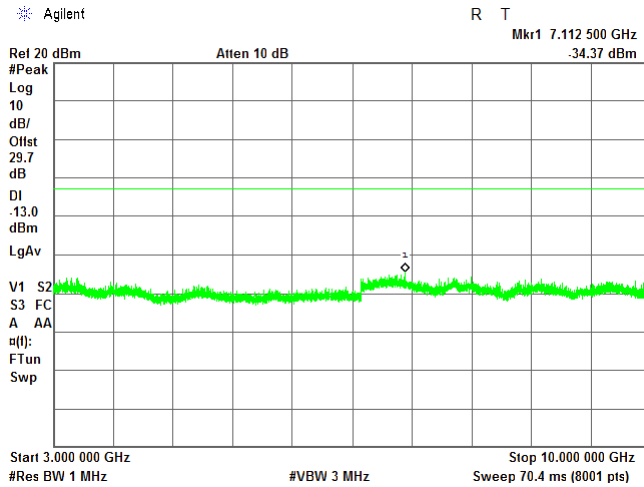

CARRIER FREQUENCY: High

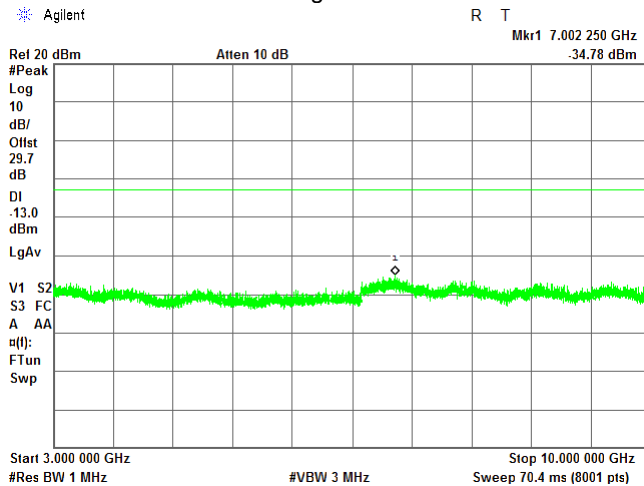



HERMON LABORATORIES

Test specification: Section 27.53, Spurious emissions conducted measurements			
Test procedure: 47 CFR, Sections 2.1051; KDB 935210 D05 v01r01 section 3.6.3			
Test mode: Compliance		Verdict: PASS	
Date(s): 27-Sep-16			
Temperature: 28 °C	Relative Humidity: 43 %	Air Pressure: 1012 hPa	Power: 48 VDC
Remarks:			

Plot 7.6.14 Spurious emission measurements in 10000 - 22000 MHz range at carrier frequency

FREQUENCY RANGE:
OPERATIONAL MODE:
CONFIGURATION:

2110 – 2180 MHz
GSM downlink transmit
Below AGC level

CARRIER FREQUENCY: Low

CARRIER FREQUENCY: Mid

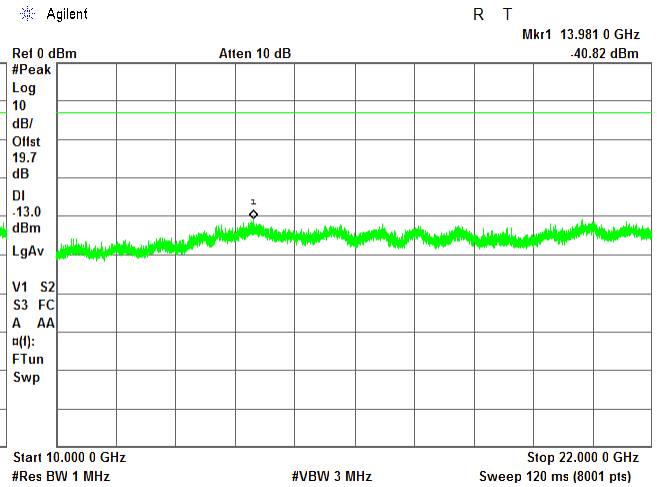
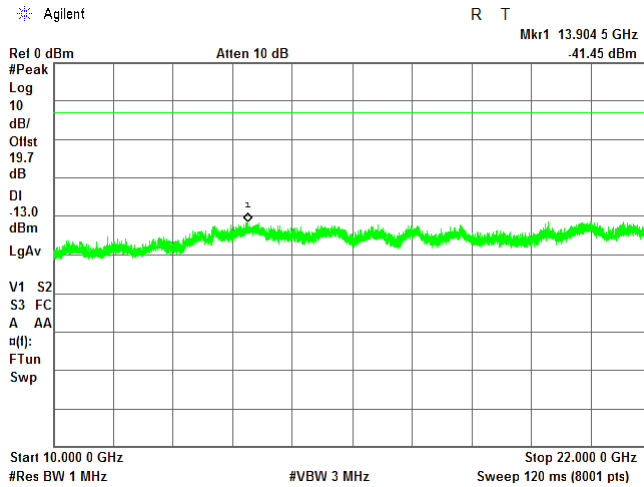

CARRIER FREQUENCY: High

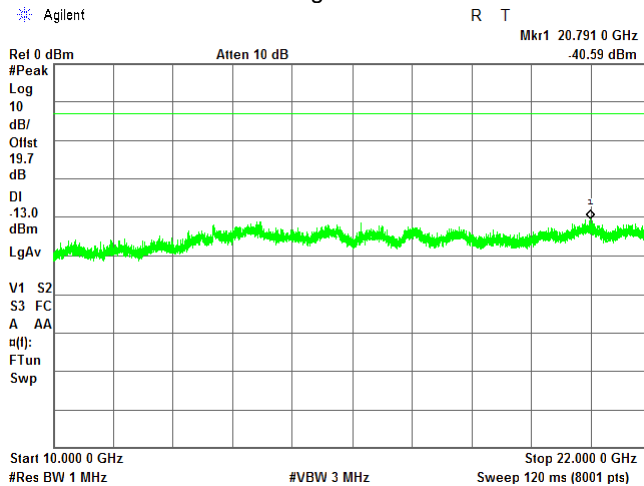



HERMON LABORATORIES

Test specification: Section 27.53, Spurious emissions conducted measurements			
Test procedure: 47 CFR, Sections 2.1051; KDB 935210 D05 v01r01 section 3.6.3			
Test mode: Compliance		Verdict: PASS	
Date(s): 27-Sep-16			
Temperature: 28 °C	Relative Humidity: 43 %	Air Pressure: 1012 hPa	Power: 48 VDC
Remarks:			

Plot 7.6.15 Spurious emission measurements in 9 - 150 kHz range at carrier frequency

FREQUENCY RANGE:
OPERATIONAL MODE:
CONFIGURATION:

2110 – 2180 MHz
WCDMA downlink transmit
Below AGC level

CARRIER FREQUENCY: Low

CARRIER FREQUENCY: Mid

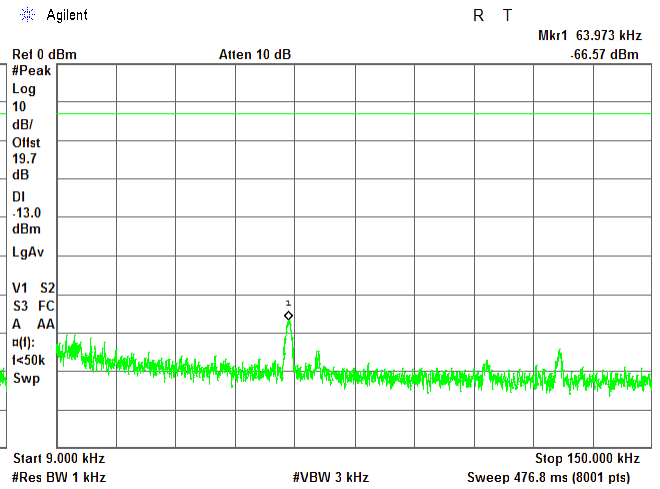
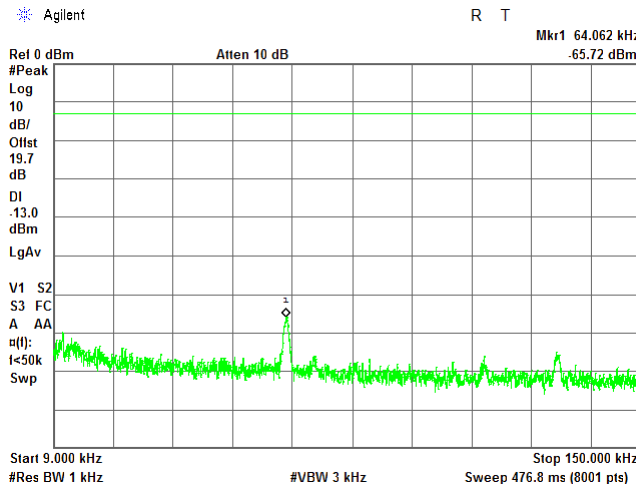

CARRIER FREQUENCY: High

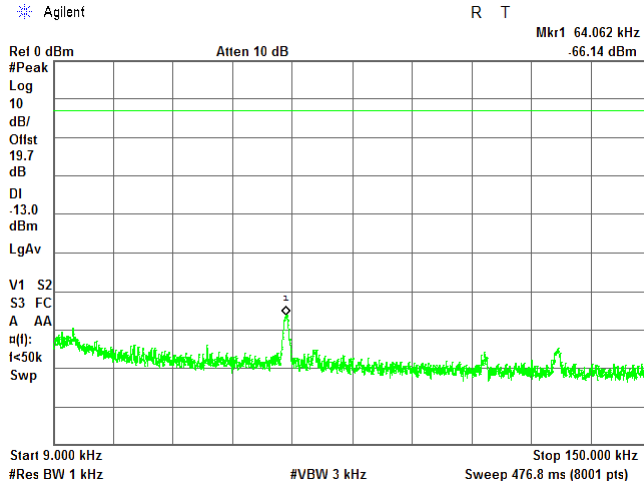



HERMON LABORATORIES

Test specification: Section 27.53, Spurious emissions conducted measurements			
Test procedure: 47 CFR, Sections 2.1051; KDB 935210 D05 v01r01 section 3.6.3			
Test mode: Compliance		Verdict: PASS	
Date(s): 27-Sep-16			
Temperature: 28 °C	Relative Humidity: 43 %	Air Pressure: 1012 hPa	Power: 48 VDC
Remarks:			

Plot 7.6.16 Spurious emission measurements in 0.15 - 30.0 MHz range at carrier frequency

FREQUENCY RANGE:
OPERATIONAL MODE:
CONFIGURATION:

2110 – 2180 MHz
WCDMA downlink transmit
Below AGC level

CARRIER FREQUENCY: Low

CARRIER FREQUENCY: Mid

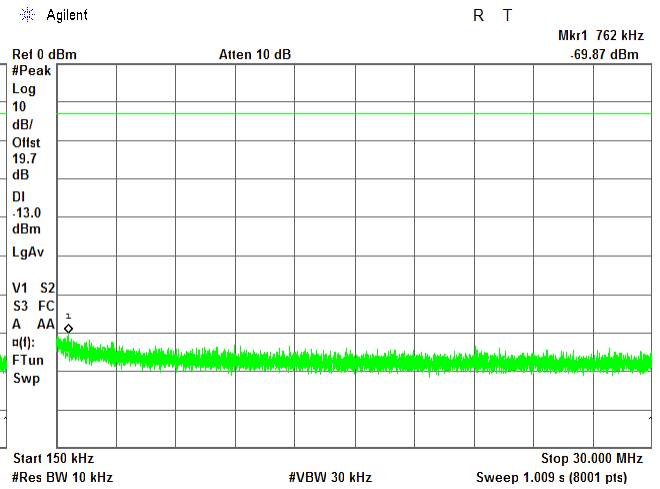
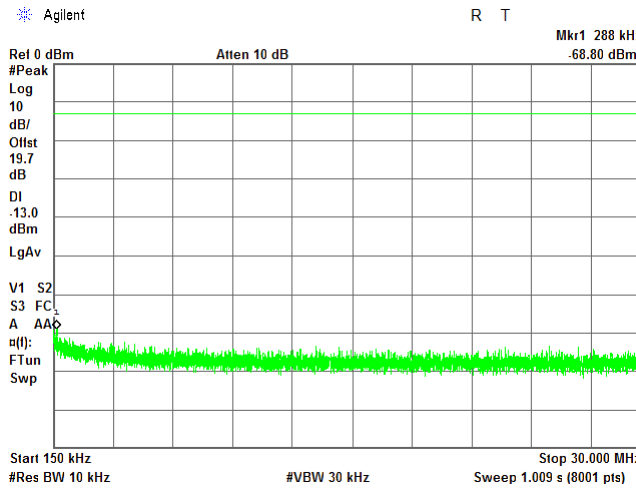

CARRIER FREQUENCY: High

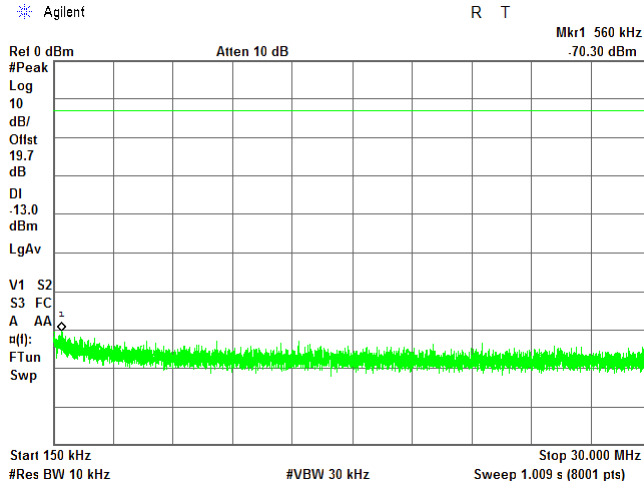



HERMON LABORATORIES

Test specification: Section 27.53, Spurious emissions conducted measurements			
Test procedure: 47 CFR, Sections 2.1051; KDB 935210 D05 v01r01 section 3.6.3			
Test mode: Compliance		Verdict: PASS	
Date(s): 27-Sep-16			
Temperature: 28 °C	Relative Humidity: 43 %	Air Pressure: 1012 hPa	Power: 48 VDC
Remarks:			

Plot 7.6.17 Spurious emission measurements in 30.0 - 1000 MHz range at carrier frequency

FREQUENCY RANGE:
OPERATIONAL MODE:
CONFIGURATION:

2110 – 2180 MHz
WCDMA downlink transmit
Below AGC level

CARRIER FREQUENCY: Low

CARRIER FREQUENCY: Mid

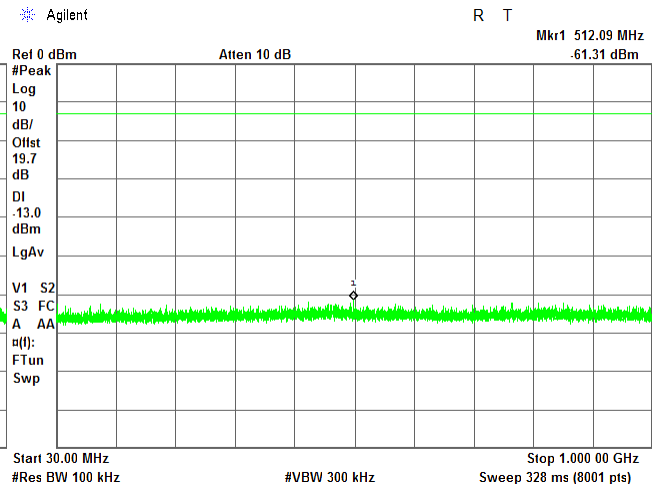
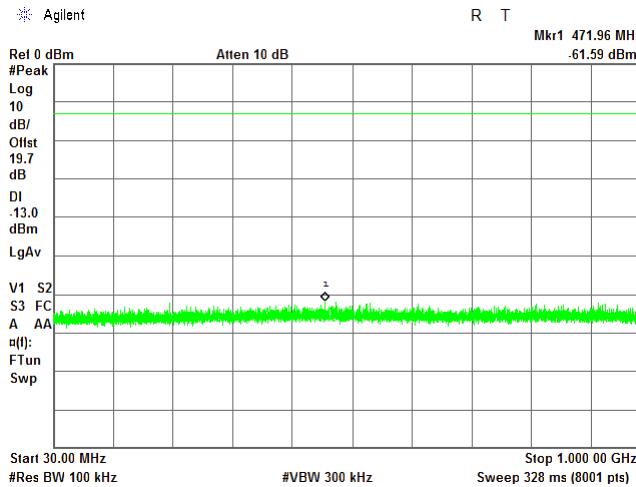

CARRIER FREQUENCY: High

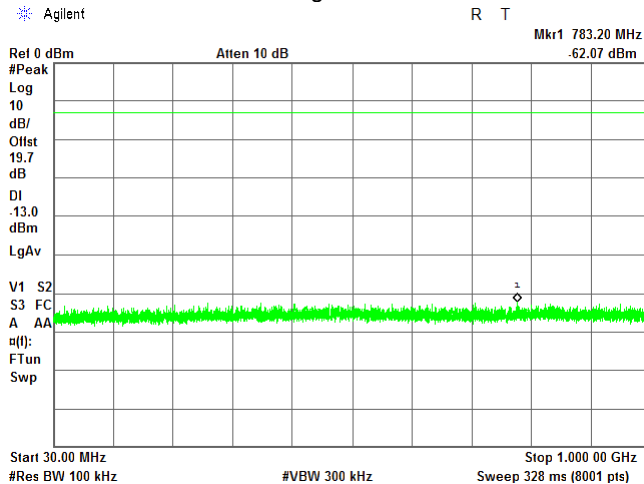



HERMON LABORATORIES

Test specification: Section 27.53, Spurious emissions conducted measurements			
Test procedure: 47 CFR, Sections 2.1051; KDB 935210 D05 v01r01 section 3.6.3			
Test mode: Compliance		Verdict: PASS	
Date(s): 27-Sep-16			
Temperature: 28 °C	Relative Humidity: 43 %	Air Pressure: 1012 hPa	Power: 48 VDC
Remarks:			

Plot 7.6.18 Spurious emission measurements in 1000 - 2107 MHz range at carrier frequency

FREQUENCY RANGE: 2110 – 2180 MHz
 OPERATIONAL MODE: WCDMA downlink transmit
 CONFIGURATION: Below AGC level

CARRIER FREQUENCY: Low

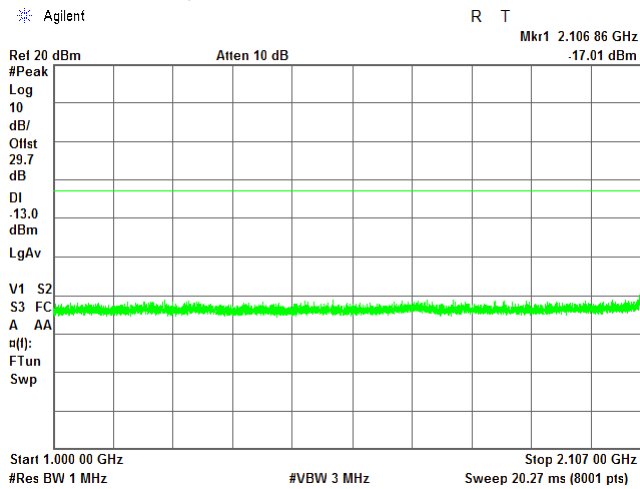

CARRIER FREQUENCY: Mid

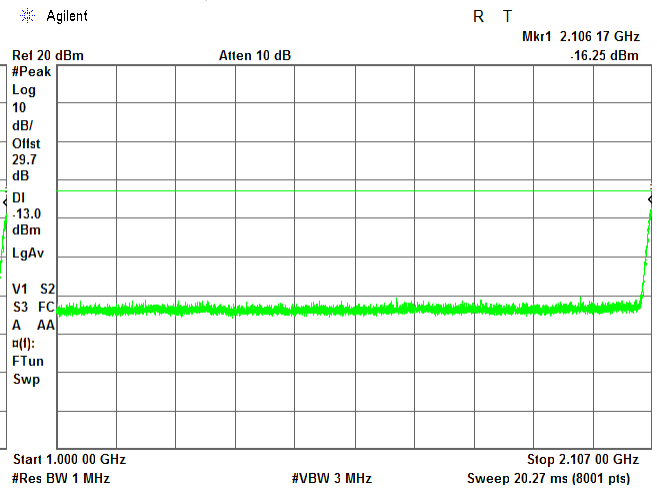

CARRIER FREQUENCY: High

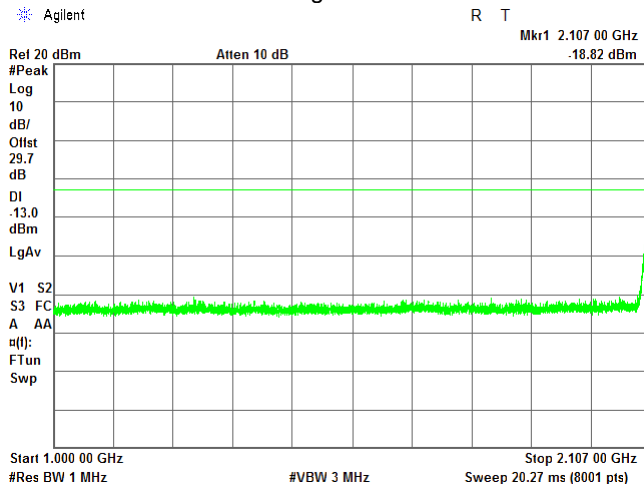



HERMON LABORATORIES

Test specification: Section 27.53, Spurious emissions conducted measurements			
Test procedure: 47 CFR, Sections 2.1051; KDB 935210 D05 v01r01 section 3.6.3			
Test mode: Compliance		Verdict: PASS	
Date(s): 27-Sep-16			
Temperature: 28 °C	Relative Humidity: 43 %	Air Pressure: 1012 hPa	Power: 48 VDC
Remarks:			

Plot 7.6.19 Spurious emission measurements in 2183 - 3000 MHz range at carrier frequency

FREQUENCY RANGE:
OPERATIONAL MODE:
CONFIGURATION:

2110 – 2180 MHz
WCDMA downlink transmit
Below AGC level

CARRIER FREQUENCY: Low

CARRIER FREQUENCY: Mid

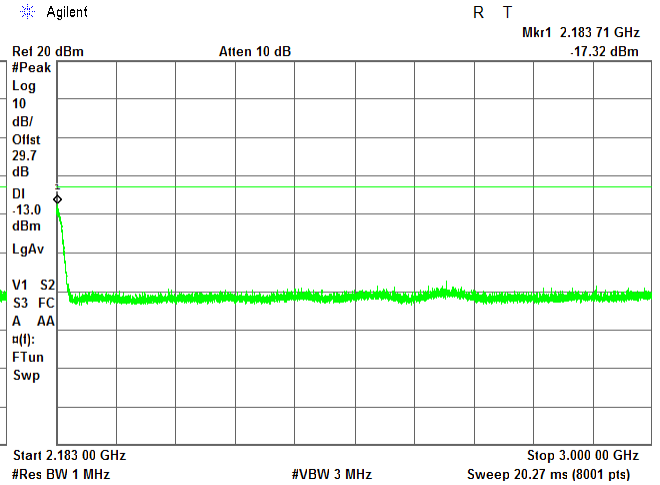
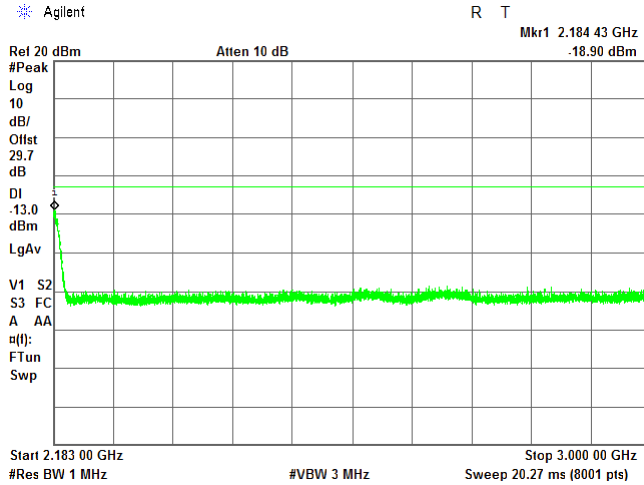

CARRIER FREQUENCY: High

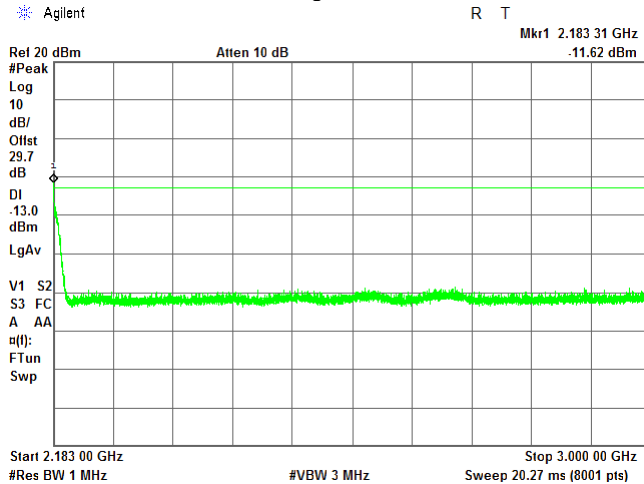



HERMON LABORATORIES

Test specification: Section 27.53, Spurious emissions conducted measurements			
Test procedure: 47 CFR, Sections 2.1051; KDB 935210 D05 v01r01 section 3.6.3			
Test mode: Compliance		Verdict: PASS	
Date(s): 27-Sep-16			
Temperature: 28 °C	Relative Humidity: 43 %	Air Pressure: 1012 hPa	Power: 48 VDC
Remarks:			

Plot 7.6.20 Spurious emission measurements in 3000 - 10000 MHz range at carrier frequency

FREQUENCY RANGE:
OPERATIONAL MODE:
CONFIGURATION:

2110 – 2180 MHz
WCDMA downlink transmit
Below AGC level

CARRIER FREQUENCY: Low

CARRIER FREQUENCY: Mid

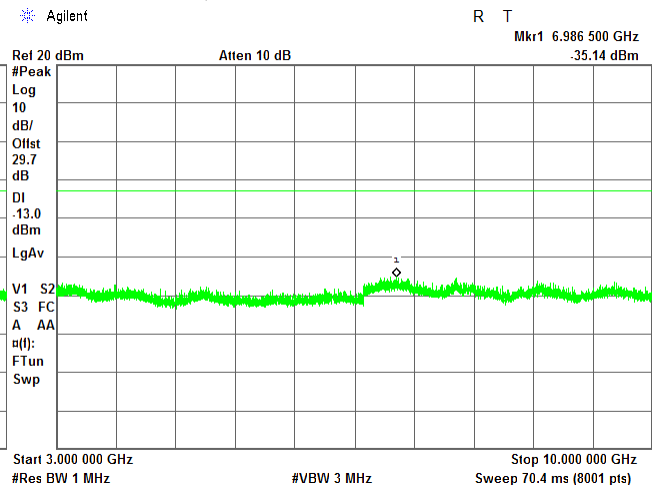
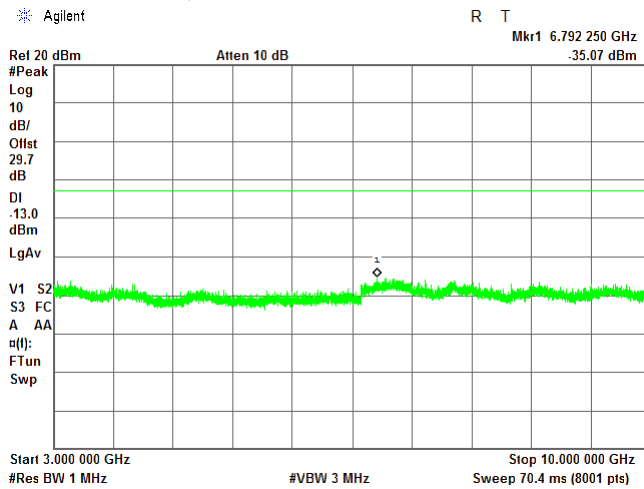

CARRIER FREQUENCY: High

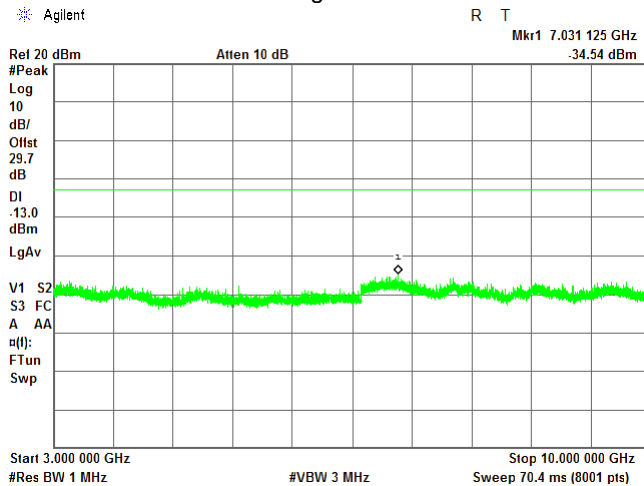



HERMON LABORATORIES

Test specification: Section 27.53, Spurious emissions conducted measurements			
Test procedure: 47 CFR, Sections 2.1051; KDB 935210 D05 v01r01 section 3.6.3			
Test mode: Compliance		Verdict: PASS	
Date(s): 27-Sep-16			
Temperature: 28 °C	Relative Humidity: 43 %	Air Pressure: 1012 hPa	Power: 48 VDC
Remarks:			

Plot 7.6.21 Spurious emission measurements in 10000 - 22000 MHz range at carrier frequency

FREQUENCY RANGE:
OPERATIONAL MODE:
CONFIGURATION:

2110 – 2180 MHz
WCDMA downlink transmit
Below AGC level

CARRIER FREQUENCY: Low

CARRIER FREQUENCY: Mid

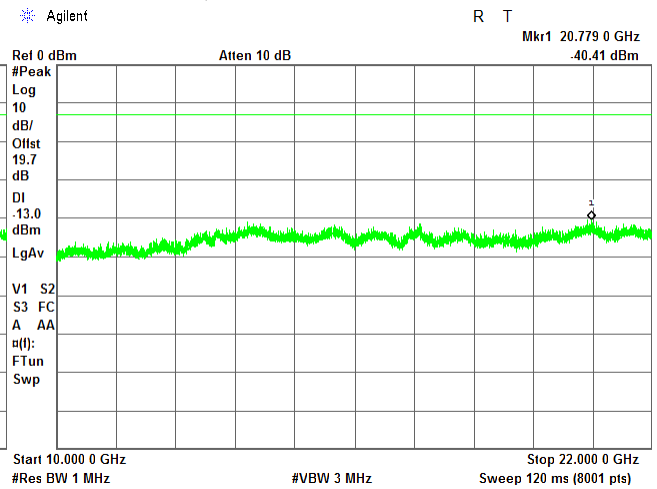
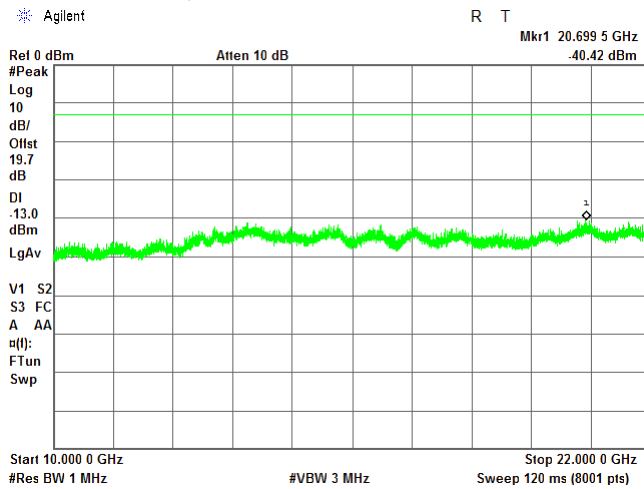

CARRIER FREQUENCY: High

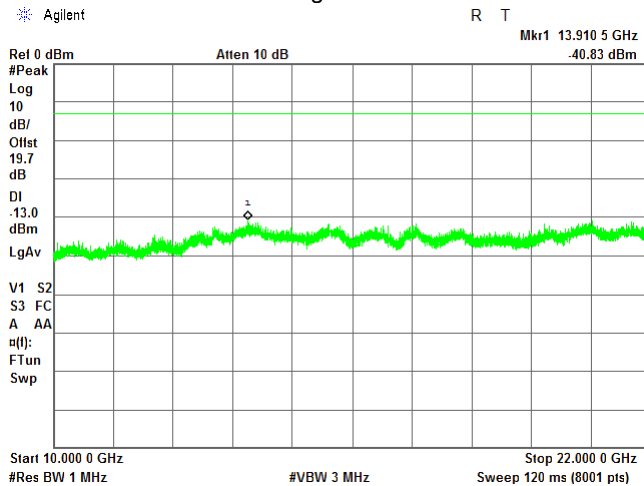



Test specification: Section 27.53, Radiated spurious emissions			
Test procedure: 47 CFR, Sections 2.1053; KDB 935210 D05 v01r01 section 3.6.3			
Test mode: Compliance		Verdict: PASS	
Date(s): 19-Sep-16 - 21-Sep-16			
Temperature: 31 °C	Relative Humidity: 48 %	Air Pressure: 1009 hPa	Power: 48 VDC
Remarks:			

7.7 Radiated spurious emission measurements

7.7.1 General

This test was performed to measure radiated spurious emissions from the EUT. Specification test limits are given in Table 7.7.1.

Table 7.7.1 Radiated spurious emission test limits

Frequency, MHz	Attenuation below carrier, dBc	ERP of spurious, dBm	Equivalent field strength limit @ 3m, dB(μ V/m) ^{***}
0.009 – 10 th harmonic*	43+10logP ^{**}	-13	84.4

* - Excluding the band emission

** - P is transmitter output power in Watts

*** - Equivalent field strength limit was calculated from maximum allowed ERP of spurious as follows: $E = \sqrt{30 \times P \times 1.64} / r$, where P is ERP in Watts, 1.64 is numeric gain of ideal dipole and r is antenna to EUT distance in meters

7.7.2 Test procedure for spurious emission field strength measurements in 9 kHz to 30 MHz band

7.7.2.1 The EUT was set up as shown in Figure 7.7.1, energized and the performance check was conducted.

7.7.2.2 The specified frequency range was investigated with antenna connected to spectrum analyzer. To find maximum radiation the turntable was rotated 360° and the measuring antenna was rotated around its vertical axis.

7.7.2.3 The worst test results (the lowest margins) were recorded in Table 7.7.2 and shown in the associated plots.

7.7.3 Test procedure for spurious emission field strength measurements above 30 MHz

7.7.3.1 The EUT was set up as shown in Figure 7.7.2, energized and the performance check was conducted.

7.7.3.2 The specified frequency range was investigated with antenna connected to spectrum analyzer. To find maximum radiation the turntable was rotated 360° and the measuring antenna height was swept from 1 to 4 m in both, vertical and horizontal, polarizations.

7.7.3.3 The worst test results (the lowest margins) were recorded in Table 7.7.2 and shown in the associated plots.



Test specification: Section 27.53, Radiated spurious emissions			
Test procedure: 47 CFR, Sections 2.1053; KDB 935210 D05 v01r01 section 3.6.3			
Test mode: Compliance		Verdict: PASS	
Date(s): 19-Sep-16 - 21-Sep-16			
Temperature: 31 °C	Relative Humidity: 48 %	Air Pressure: 1009 hPa	Power: 48 VDC
Remarks:			

Figure 7.7.1 Setup for spurious emission field strength measurements in 9 kHz to 30 MHz band

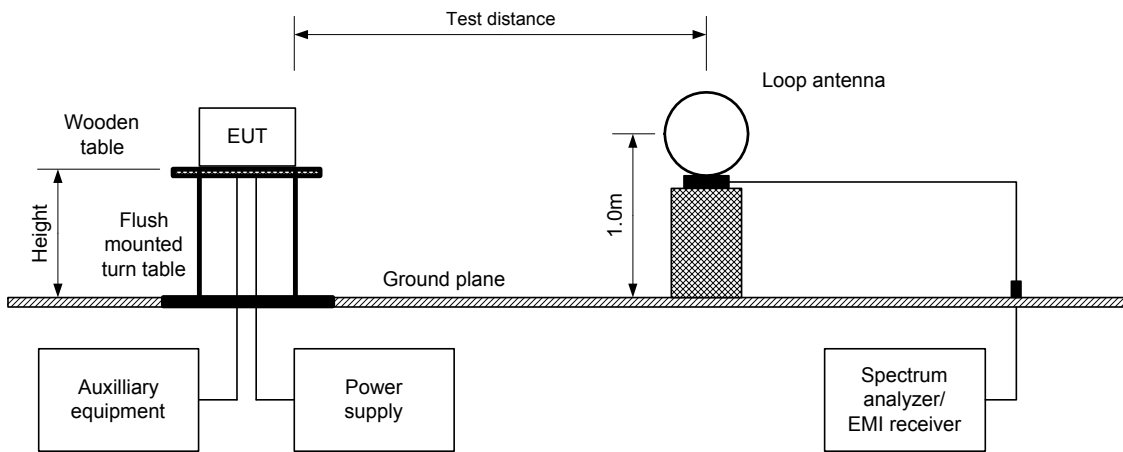
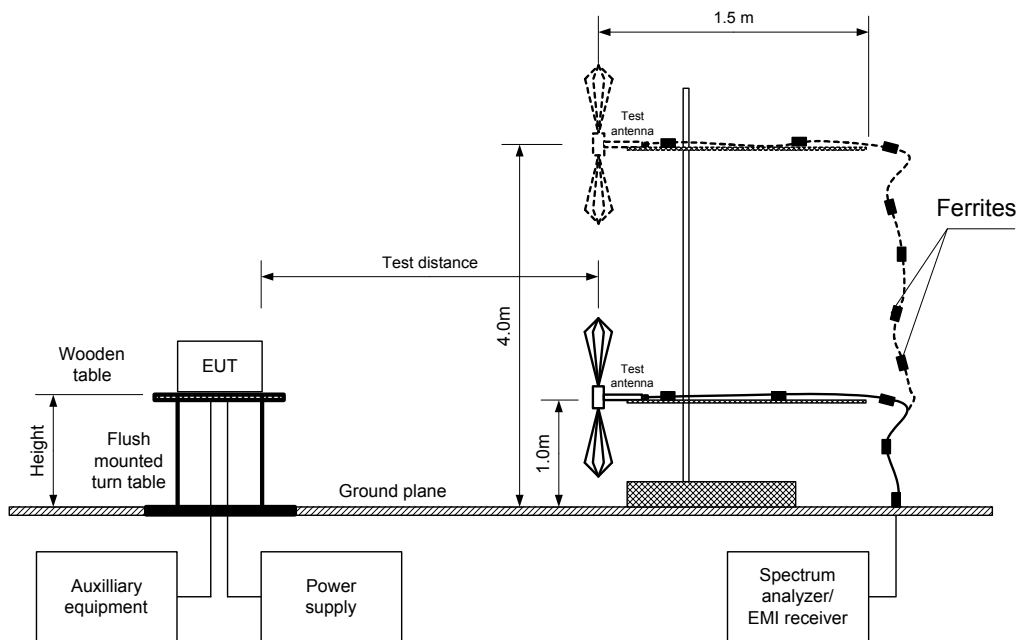

Figure 7.7.2 Setup for spurious emission field strength measurements above 30 MHz





Test specification: Section 27.53, Radiated spurious emissions			
Test procedure: 47 CFR, Sections 2.1053; KDB 935210 D05 v01r01 section 3.6.3			
Test mode: Compliance		Verdict: PASS	
Date(s): 19-Sep-16 - 21-Sep-16			
Temperature: 31 °C	Relative Humidity: 48 %	Air Pressure: 1009 hPa	Power: 48 VDC
Remarks:			

Table 7.7.2 Spurious emission field strength test results

ASSIGNED FREQUENCY RANGE: 2110.0 – 2180 MHz
 TEST DISTANCE: 3 m
 TEST SITE: Semi anechoic chamber / OATS
 EUT HEIGHT: 0.8 m
 INVESTIGATED FREQUENCY RANGE: 0.009 – 22 000 MHz
 DETECTOR USED: Peak
 VIDEO BANDWIDTH: > Resolution bandwidth
 TEST ANTENNA TYPE: Active loop (9 kHz – 30 MHz)
 Biconilog (30 MHz – 1000 MHz)
 Horn (above 1000 MHz)
 MODULATION: Unmodulated
 TRANSMITTER OUTPUT POWER SETTINGS: Maximum

Frequency, MHz	Field strength, dB(µV/m)	Limit, dB(µV/m)	Margin, dB*	RBW, kHz	Antenna polarization	Antenna height, m	Turn-table position**, degrees	Verdict
Low carrier frequency MHz								
4219.98	61.35	84.4	-23.05	1000	Vertical	1.0	150	Pass
6330.03	51.16	84.4	-33.24	1000	Vertical	1.1	10	Pass
Mid carrier frequency MHz								
4289.98	61.53	84.4	-22.87	1000	Vertical	1.0	180	Pass
6435.06	57.34	84.4	-27.06	1000	Vertical	1.1	15	Pass
High carrier frequency MHz								
4360.00	64.50	84.4	-19.90	1000	Vertical	1.0	185	Pass
6539.94	58.28	84.4	-26.12	1000	Vertical	1.2	10	Pass

*- Margin = Field strength of spurious – calculated field strength limit.

** - EUT front panel refers to 0 degrees position of turntable.

Reference numbers of test equipment used

HL 0446	HL 0521	HL 0604	HL 2909	HL 4222	HL 4278	HL 4353	HL 4372
HL 4933	HL 4956	HL 5112					

Full description is given in Appendix A.



HERMON LABORATORIES

Test specification: Section 27.53, Radiated spurious emissions			
Test procedure: 47 CFR, Sections 2.1053; KDB 935210 D05 v01r01 section 3.6.3			
Test mode: Compliance		Verdict: PASS	
Date(s): 19-Sep-16 - 21-Sep-16			
Temperature: 31 °C	Relative Humidity: 48 %	Air Pressure: 1009 hPa	Power: 48 VDC
Remarks:			

Plot 7.7.1 Radiated emission measurements in 9 - 150 kHz range

TEST SITE:
ANTENNA POLARIZATION:
TEST DISTANCE:
CARRIER FREQUENCY: Low

Semi anechoic chamber
Vertical and Horizontal
3 m
CARRIER FREQUENCY: Mid

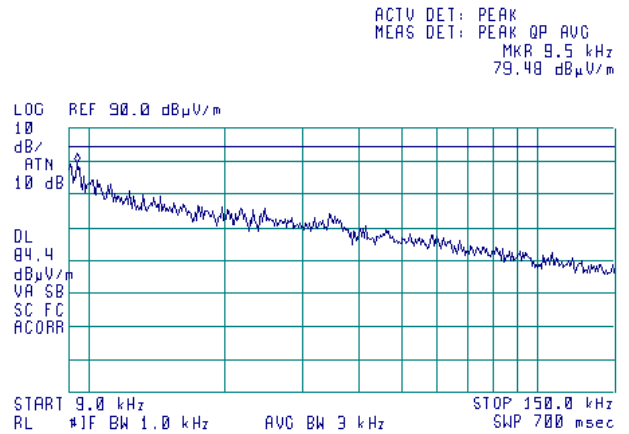
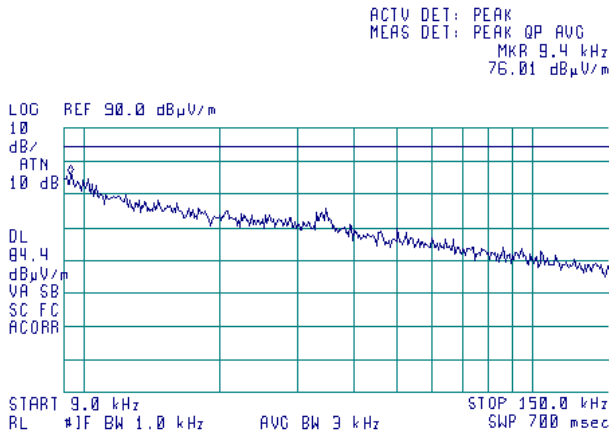

CARRIER FREQUENCY: High

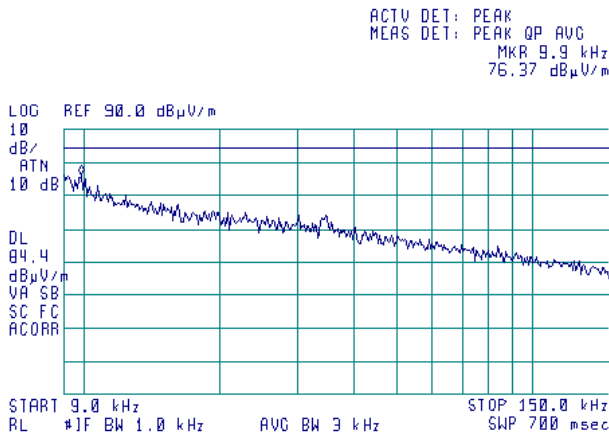



HERMON LABORATORIES

Test specification: Section 27.53, Radiated spurious emissions			
Test procedure: 47 CFR, Sections 2.1053; KDB 935210 D05 v01r01 section 3.6.3			
Test mode: Compliance		Verdict: PASS	
Date(s): 19-Sep-16 - 21-Sep-16			
Temperature: 31 °C	Relative Humidity: 48 %	Air Pressure: 1009 hPa	Power: 48 VDC
Remarks:			

Plot 7.7.2 Radiated emission measurements in 0.15 - 30 MHz range

TEST SITE:
ANTENNA POLARIZATION:
TEST DISTANCE:
CARRIER FREQUENCY: Low

Semi anechoic chamber
Vertical and Horizontal
3 m
CARRIER FREQUENCY: Mid

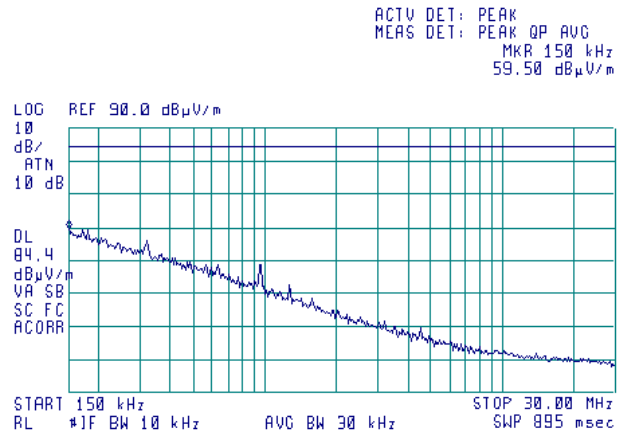
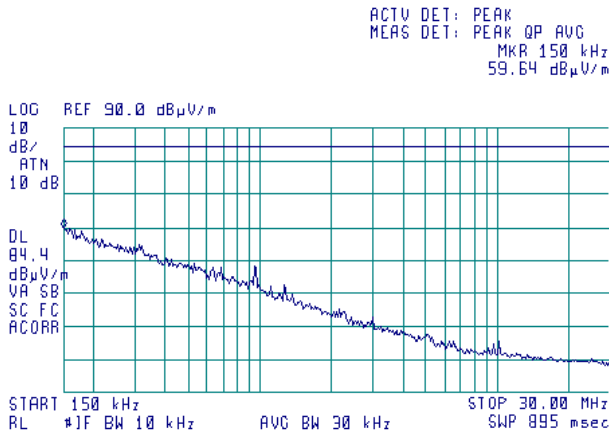

CARRIER FREQUENCY: High

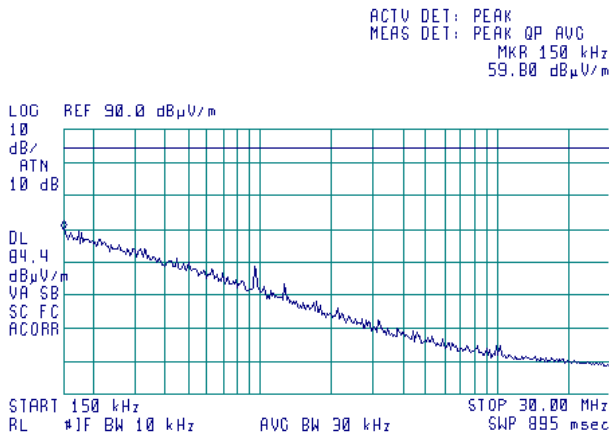



HERMON LABORATORIES

Test specification: Section 27.53, Radiated spurious emissions			
Test procedure: 47 CFR, Sections 2.1053; KDB 935210 D05 v01r01 section 3.6.3			
Test mode: Compliance		Verdict: PASS	
Date(s): 19-Sep-16 - 21-Sep-16			
Temperature: 31 °C	Relative Humidity: 48 %	Air Pressure: 1009 hPa	Power: 48 VDC
Remarks:			

Plot 7.7.3 Radiated emission measurements in 30 - 1000 MHz range

TEST SITE:
ANTENNA POLARIZATION:
TEST DISTANCE:
CARRIER FREQUENCY: Low

Semi anechoic chamber
Vertical and Horizontal
3 m
CARRIER FREQUENCY: Mid



ACTV DET: PEAK
MEAS DET: PEAK QP AVG
MKR 1.0000 GHz
46.02 dBµV/m

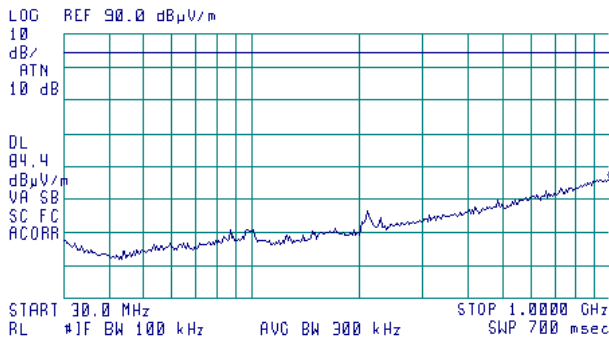

ACTV DET: PEAK
MEAS DET: PEAK QP AVG
MKR 990.5 MHz
46.86 dBµV/m

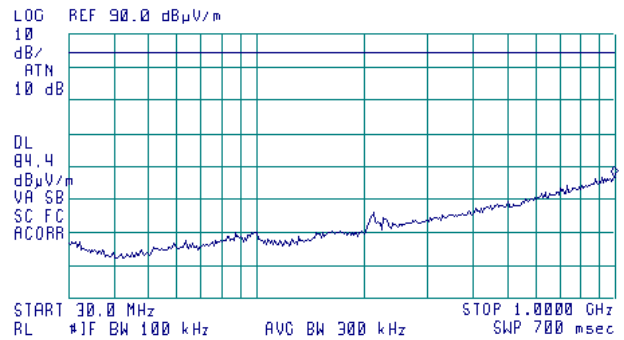

CARRIER FREQUENCY: High



ACTV DET: PEAK
MEAS DET: PEAK QP AVG
MKR 990.9 MHz
46.23 dBµV/m

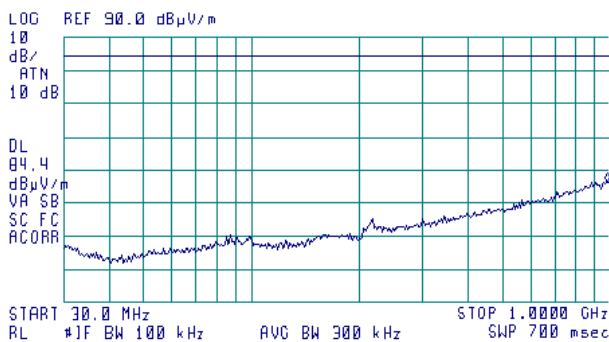



HERMON LABORATORIES

Test specification: Section 27.53, Radiated spurious emissions			
Test procedure: 47 CFR, Sections 2.1053; KDB 935210 D05 v01r01 section 3.6.3			
Test mode: Compliance		Verdict: PASS	
Date(s): 19-Sep-16 - 21-Sep-16			
Temperature: 31 °C	Relative Humidity: 48 %	Air Pressure: 1009 hPa	Power: 48 VDC
Remarks:			

Plot 7.7.4 Radiated emission measurements in 1000 – 3000 MHz range

TEST SITE:
ANTENNA POLARIZATION:
TEST DISTANCE:
CARRIER FREQUENCY: Low

Semi anechoic chamber
Vertical and Horizontal
3 m
CARRIER FREQUENCY: Mid



ACTV DET: PEAK
MEAS DET: PEAK QP AVG
MKR 2.116 GHz
71.74 dBµV/m

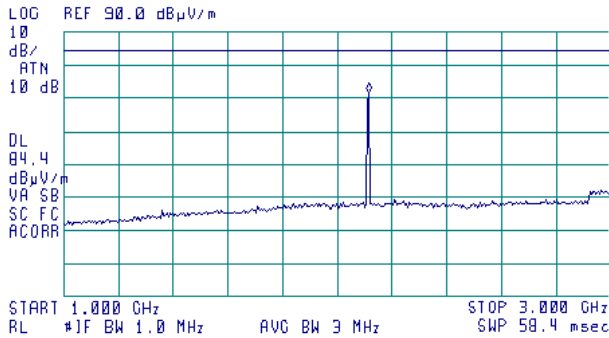

ACTV DET: PEAK
MEAS DET: PEAK QP AVG
MKR 2.151 GHz
70.46 dBµV/m

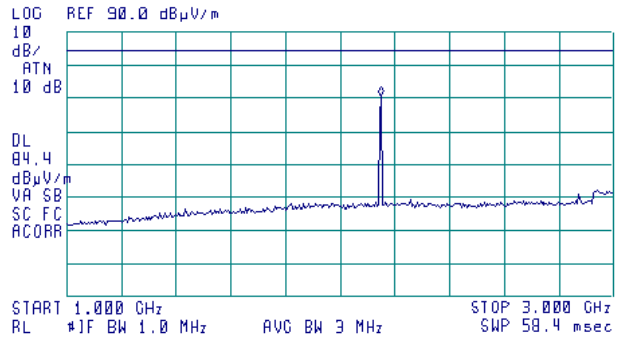

CARRIER FREQUENCY: High



ACTV DET: PEAK
MEAS DET: PEAK QP AVG
MKR 2.186 GHz
71.22 dBµV/m

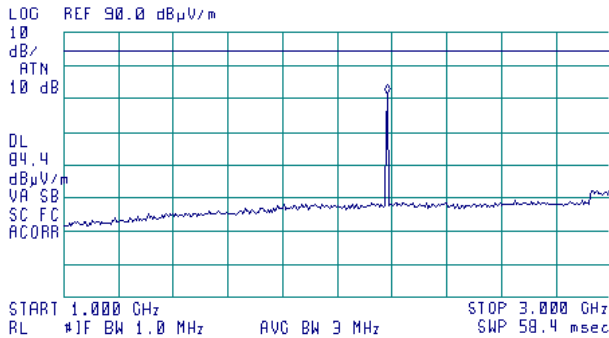



HERMON LABORATORIES

Test specification: Section 27.53, Radiated spurious emissions			
Test procedure: 47 CFR, Sections 2.1053; KDB 935210 D05 v01r01 section 3.6.3			
Test mode: Compliance		Verdict: PASS	
Date(s): 19-Sep-16 - 21-Sep-16			
Temperature: 31 °C	Relative Humidity: 48 %	Air Pressure: 1009 hPa	Power: 48 VDC
Remarks:			

Plot 7.7.5 Radiated emission measurements in 3000 – 6000 MHz range

TEST SITE:
ANTENNA POLARIZATION:
TEST DISTANCE:
CARRIER FREQUENCY: Low

Semi anechoic chamber
Vertical and Horizontal
3 m
CARRIER FREQUENCY: Mid

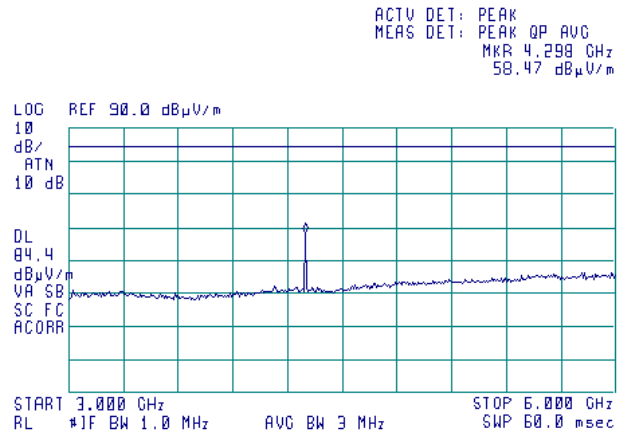
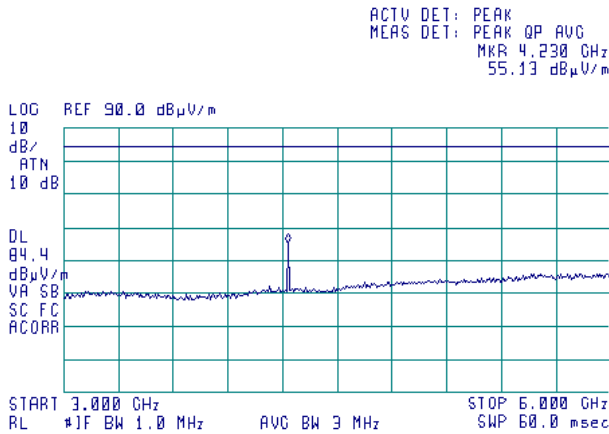

CARRIER FREQUENCY: High

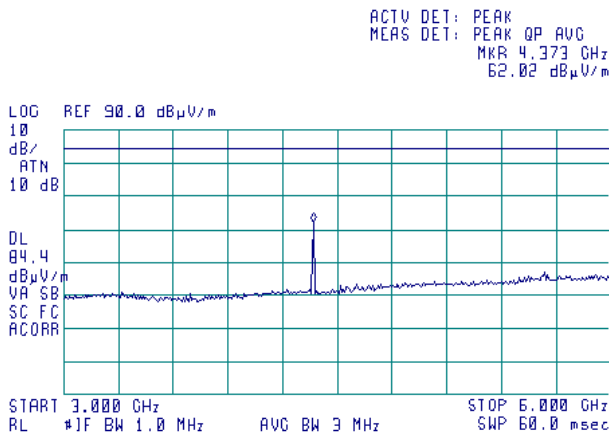



HERMON LABORATORIES

Test specification: Section 27.53, Radiated spurious emissions			
Test procedure: 47 CFR, Sections 2.1053; KDB 935210 D05 v01r01 section 3.6.3			
Test mode: Compliance		Verdict: PASS	
Date(s): 19-Sep-16 - 21-Sep-16			
Temperature: 31 °C	Relative Humidity: 48 %	Air Pressure: 1009 hPa	Power: 48 VDC
Remarks:			

Plot 7.7.6 Radiated emission measurements in 6000 – 18000 MHz range

TEST SITE:
ANTENNA POLARIZATION:
TEST DISTANCE:
CARRIER FREQUENCY: Low

Semi anechoic chamber
Vertical and Horizontal
3 m
CARRIER FREQUENCY: Mid

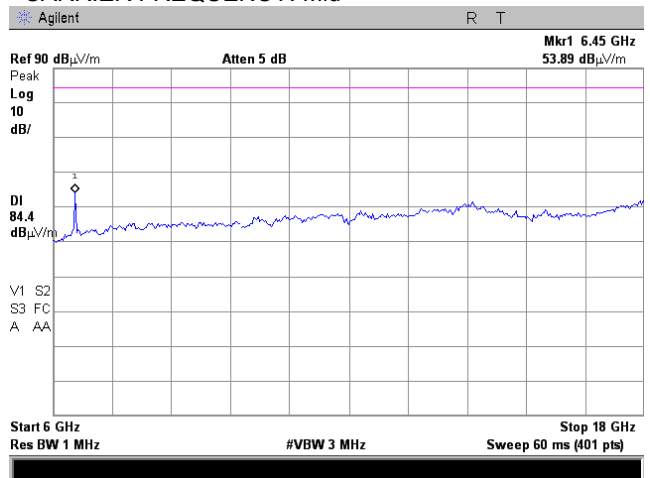
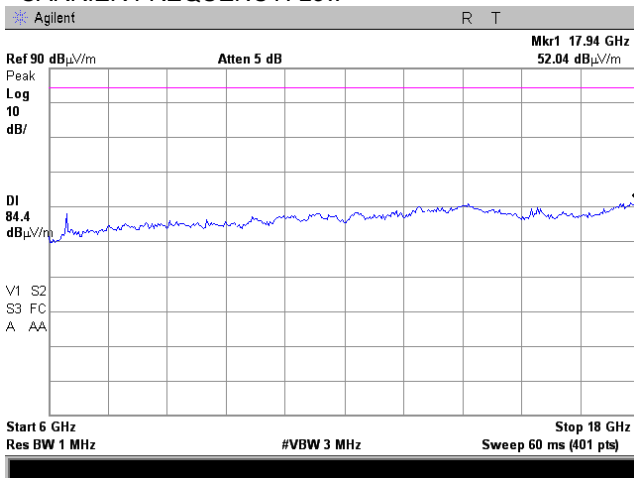

CARRIER FREQUENCY: High

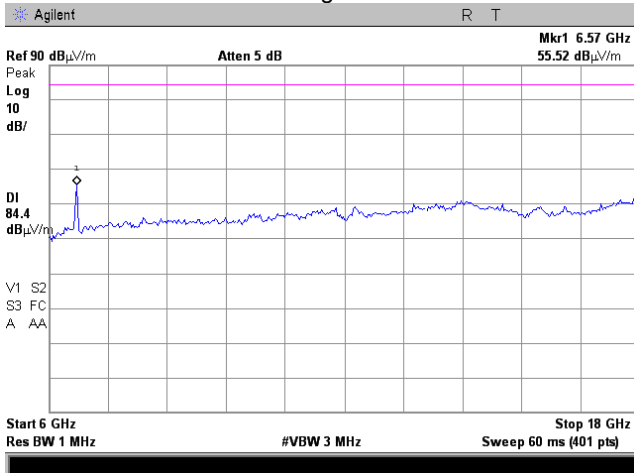



HERMON LABORATORIES

Test specification: Section 27.53, Radiated spurious emissions			
Test procedure: 47 CFR, Sections 2.1053; KDB 935210 D05 v01r01 section 3.6.3			
Test mode: Compliance		Verdict: PASS	
Date(s): 19-Sep-16 - 21-Sep-16			
Temperature: 31 °C	Relative Humidity: 48 %	Air Pressure: 1009 hPa	Power: 48 VDC
Remarks:			

Plot 7.7.7 Radiated emission measurements in 18000 – 22000 MHz range

TEST SITE:
ANTENNA POLARIZATION:
TEST DISTANCE:
CARRIER FREQUENCY: Low

Semi anechoic chamber
Vertical and Horizontal
3 m
CARRIER FREQUENCY: Mid

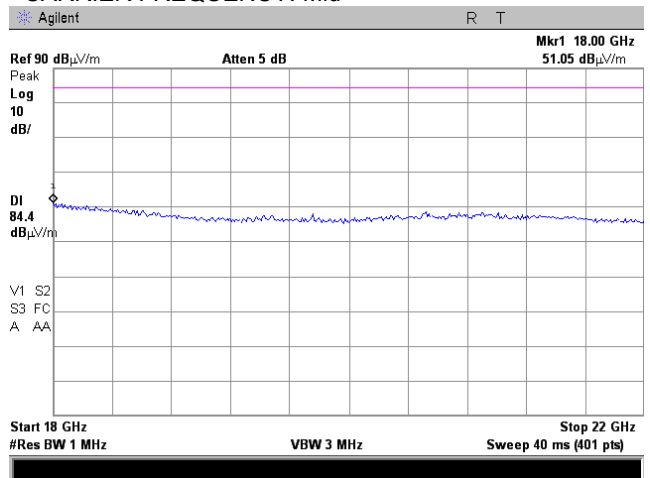
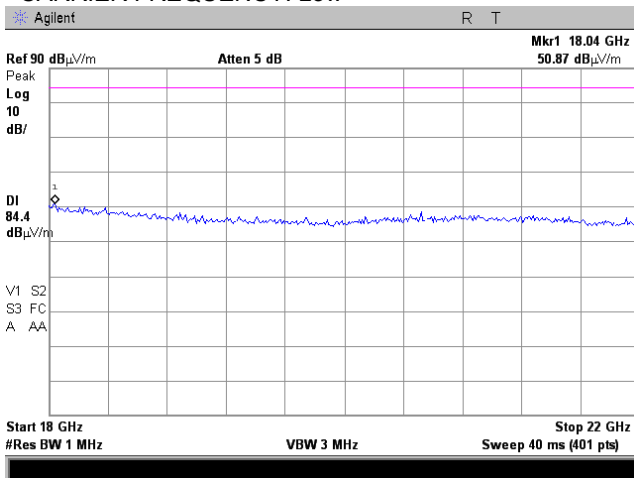

CARRIER FREQUENCY: High

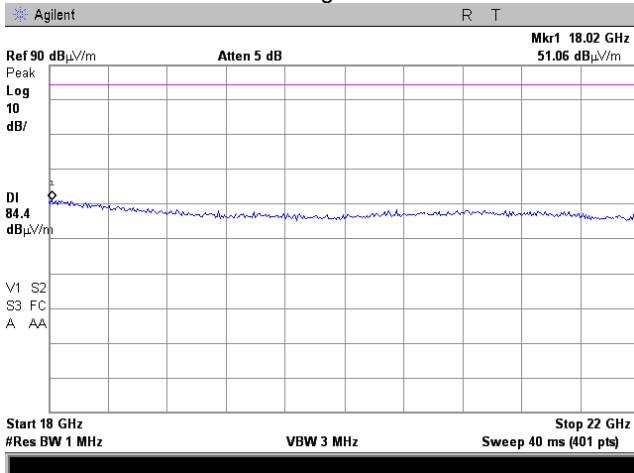



HERMON LABORATORIES

Test specification: Section 27.53, Radiated spurious emissions			
Test procedure: 47 CFR, Sections 2.1053; KDB 935210 D05 v01r01 section 3.6.3			
Test mode: Compliance		Verdict: PASS	
Date(s): 19-Sep-16 - 21-Sep-16			
Temperature: 31 °C	Relative Humidity: 48 %	Air Pressure: 1009 hPa	Power: 48 VDC
Remarks:			

Plot 7.7.8 Radiated emission measurements at the 2nd harmonic

TEST SITE:
CARRIER FREQUENCY:
TEST DISTANCE:
ANTENNA POLARIZATION: Vertical

OATS
Low
3 m
ANTENNA POLARIZATION: Horizontal

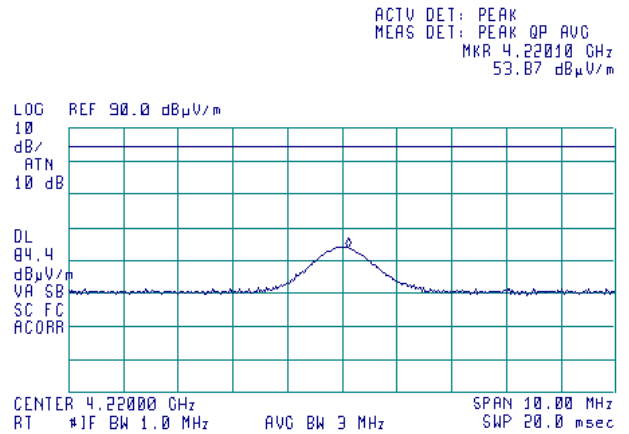
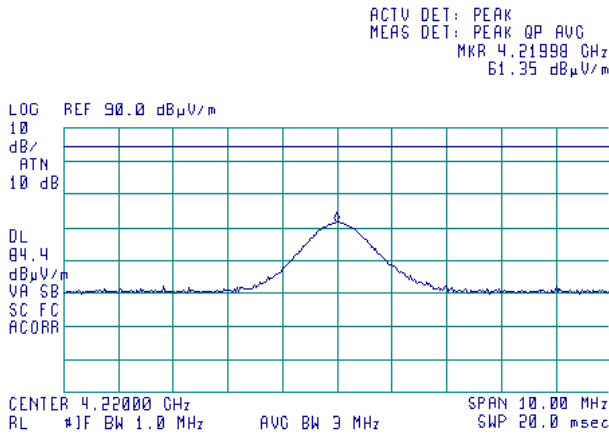

Plot 7.7.9 Radiated emission measurements at the 2nd harmonic

TEST SITE:
CARRIER FREQUENCY:
TEST DISTANCE:
ANTENNA POLARIZATION: Vertical

OATS
Mid
3 m
ANTENNA POLARIZATION: Horizontal

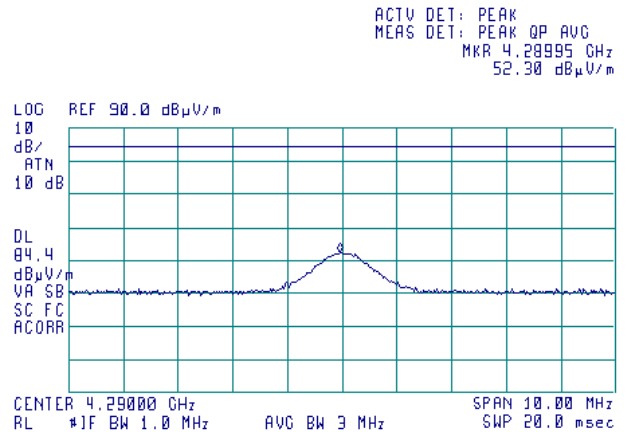
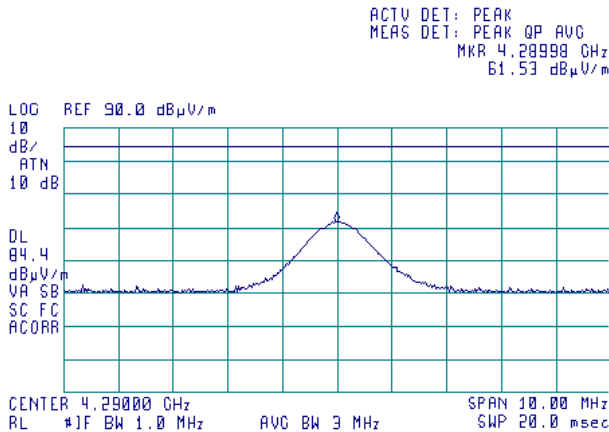



HERMON LABORATORIES

Test specification: Section 27.53, Radiated spurious emissions			
Test procedure: 47 CFR, Sections 2.1053; KDB 935210 D05 v01r01 section 3.6.3			
Test mode: Compliance		Verdict: PASS	
Date(s): 19-Sep-16 - 21-Sep-16			
Temperature: 31 °C	Relative Humidity: 48 %	Air Pressure: 1009 hPa	Power: 48 VDC
Remarks:			

Plot 7.7.10 Radiated emission measurements at the 2nd harmonic

TEST SITE:
CARRIER FREQUENCY:
ANTENNA POLARIZATION:
TEST DISTANCE:
ANTENNA POLARIZATION: Vertical

OATS
High
Vertical
3 m
ANTENNA POLARIZATION: Horizontal

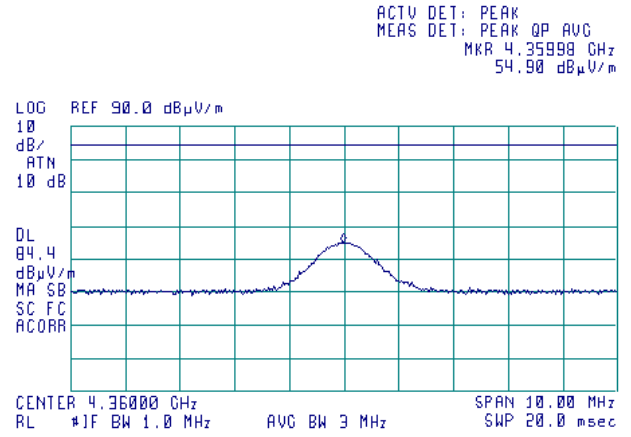
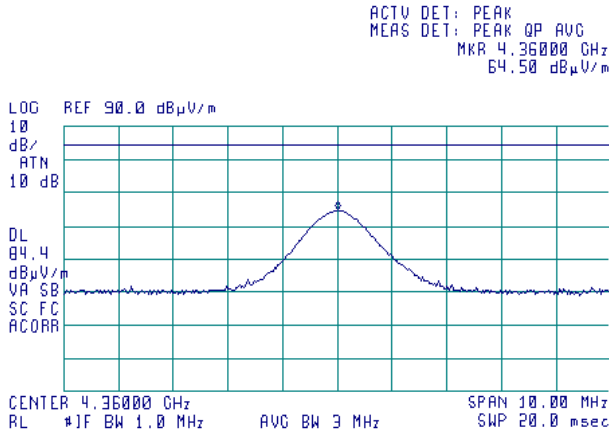



HERMON LABORATORIES

Test specification: Section 27.53, Radiated spurious emissions			
Test procedure: 47 CFR, Sections 2.1053; KDB 935210 D05 v01r01 section 3.6.3			
Test mode: Compliance		Verdict: PASS	
Date(s): 19-Sep-16 - 21-Sep-16			
Temperature: 31 °C	Relative Humidity: 48 %	Air Pressure: 1009 hPa	Power: 48 VDC
Remarks:			

Plot 7.7.11 Radiated emission measurements at the 3rd harmonic

TEST SITE:
CARRIER FREQUENCY:
TEST DISTANCE:
ANTENNA POLARIZATION: Vertical

OATS
Low
3 m
ANTENNA POLARIZATION: Horizontal

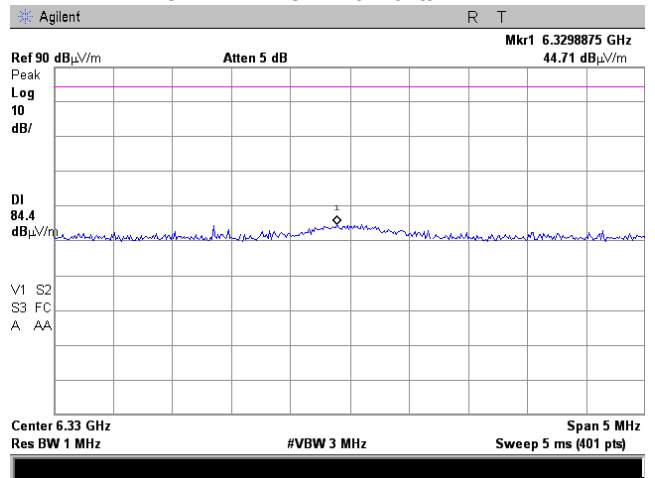
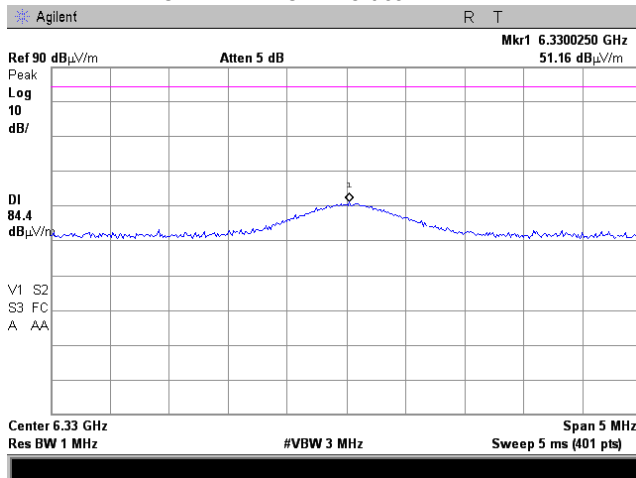

Plot 7.7.12 Radiated emission measurements at the 3rd harmonic

TEST SITE:
CARRIER FREQUENCY:
TEST DISTANCE:
ANTENNA POLARIZATION: Vertical

OATS
Mid
3 m
ANTENNA POLARIZATION: Horizontal

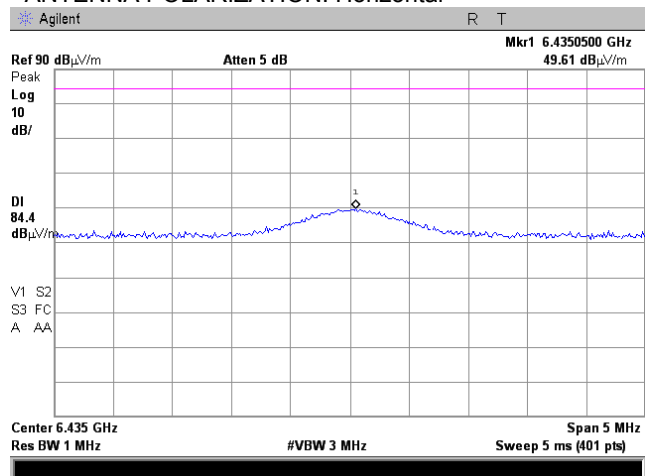
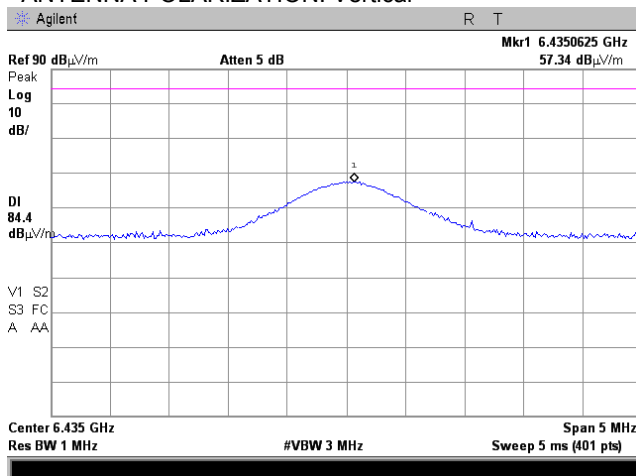



HERMON LABORATORIES

Test specification: Section 27.53, Radiated spurious emissions			
Test procedure: 47 CFR, Sections 2.1053; KDB 935210 D05 v01r01 section 3.6.3			
Test mode: Compliance		Verdict: PASS	
Date(s): 19-Sep-16 - 21-Sep-16			
Temperature: 31 °C	Relative Humidity: 48 %	Air Pressure: 1009 hPa	Power: 48 VDC
Remarks:			

Plot 7.7.13 Radiated emission measurements at the 3rd harmonic

TEST SITE:
CARRIER FREQUENCY:
ANTENNA POLARIZATION:
TEST DISTANCE:
ANTENNA POLARIZATION: Vertical

OATS
High
Vertical
3 m
ANTENNA POLARIZATION: Horizontal

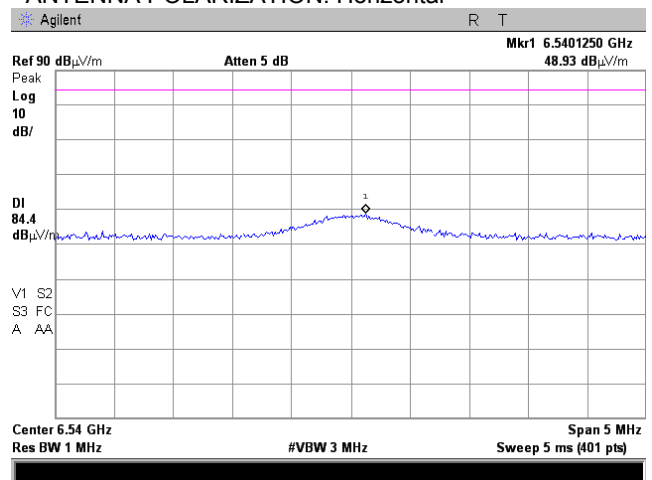
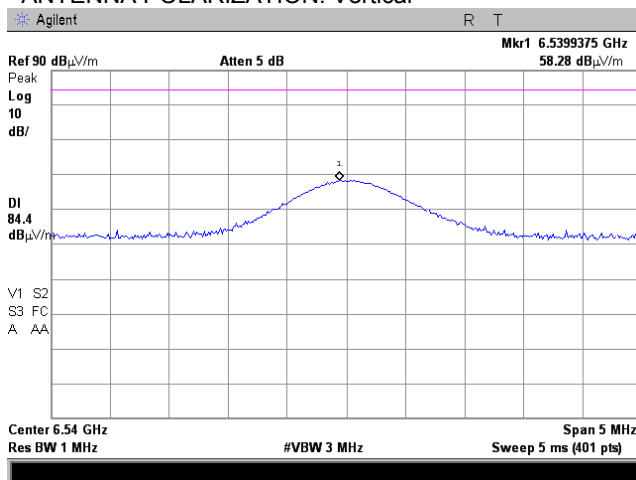

**8 APPENDIX A Test equipment and ancillaries used for tests**

HL No	Description	Manufacturer	Model	Ser. No.	Last Cal./ Check	Due Cal./ Check
0446	Antenna, Loop, Active, 10 kHz - 30 MHz	EMCO	6502	2857	18-Jan-16	18-Jan-17
0521	EMI Receiver (Spectrum Analyzer) with RF filter section 9 kHz-6.5 GHz	Hewlett Packard	8546A	3617A 00319, 3448A002 53	27-Oct-16	27-Oct-17
0604	Antenna BiconiLog Log-Periodic/T Bow-TIE, 26 - 2000 MHz	EMCO	3141	9611-1011	10-May-16	10-May-17
2011	Power Divider, 0.5-18.0 GHz, 80 W	Omni Spectra	2090-6204-00	NA	01-Dec-14	01-Dec-16
2909	Spectrum analyzer, ESA-E, 100 Hz to 26.5 GHz	Agilent Technologies	E4407B	MY414447 62	21-Feb-16	21-Feb-17
3433	Test Cable , DC-18 GHz, 1.5 m, SMA - SMA	Mini-Circuits	CBL-5FT-SMSM+	25679	20-Mar-16	20-Mar-17
3472	Cable, Coax, Microwave, DC-18 GHz, SMA-SMA, 0.6 m	Gore	GORE 65474	1003478	30-May-16	30-May-17
3474	Cable, Coax, Microwave, DC-18 GHz, SMA-SMA, 0.6 m	Gore	GORE 65475	1640102	30-May-16	30-May-17
3787	Precision Fixed Attenuator, 50 Ohm, 5 W, 10 dB, DC to 18 GHz	Mini-Circuits	BW-S10W5+	NA	01-Dec-15	01-Dec-16
3788	Precision Fixed Attenuator, 50 Ohm, 5 W, 10 dB, DC to 18 GHz	Mini-Circuits	BW-S10W5+	NA	01-Dec-15	01-Dec-16
3901	Microwave Cable Assembly, 40.0 GHz, 3.5 m, SMA/SMA	Huber-Suhner	SUCOFLE X 102A	1225/2A	15-Feb-16	15-Feb-17
4222	High Pass Filter, 50 Ohm, 3150 to 6500 MHz	Mini-Circuits	VHF-2700+	NA	01-Oct-15	01-Oct-17
4278	Test Cable , DC-18 GHz, 4.6 m, N/M - N/M	Mini-Circuits	APC-15FT-NMNM+	0755A	26-Sep-16	26-Sep-17
4353	Low Loss Armored Test Cable, DC - 18 GHz, 6.2 m, N type-M/N type-M	MegaPhase	NC29-N1N1-244	12025101 003	15-Mar-16	15-Mar-17
4354	Vector Signal Generator, 100 kHz to 6.0 GHz	Rohde & Schwarz	SMJ 100A	1403.4507 K02- 101777-rc	27-Jun-14	27-Jun-17
4372	High Pass Filter, 50 Ohm, 8.0 to 18.0 GHz, SMA-FM / SMA-FM	Tiger Micro-Electronics Institute	TGF-A2118-001	r- JSFG308-001	08-May-16	08-May-17
4933	Active Horn Antenna, 1 GHz to 18 GHz	Com-Power Corporation	AHA-118	701046	14-Oct-16	14-Oct-17
4956	Active horn antenna, 18 to 40 GHz	Com-Power Corporation	AHA-840	105004	09-Nov-16	09-Nov-17
5112	RF cable, 40 GHz, 5.5 m, K-type	Huber-Suhner	SF102EA/ 11SK/11S K/5500M M	502494/2E A	26-Jul-16	26-Jul-17

**9 APPENDIX B Measurement uncertainties****Expanded uncertainty at 95% confidence in Hermon Labs EMC measurements**

Test description	Expanded uncertainty
Transmitter tests	
Carrier power conducted at antenna connector	± 1.7 dB
Carrier power radiated (substitution method)	± 4.5 dB
Occupied bandwidth	±8%
Conducted emissions at RF antenna connector	9 kHz to 2.9 GHz: ± 2.6 dB 2.9 GHz to 6.46 GHz: ± 3.5 dB 6.46 GHz to 13.2 GHz: ± 4.3 dB 13.2 GHz to 22.0 GHz: ± 5.0 dB 22.0 GHz to 26.8 GHz: ± 5.5 dB 26.8 GHz to 40.0 GHz: ± 4.8 dB
Spurious emissions radiated 30 MHz – 40 GHz (substitution method)	± 4.5 dB
Frequency error	30 – 300 MHz: ± 50.5 Hz (1.68 ppm) 300 – 1000 MHz: ± 168 Hz (0.56 ppm)
Transient frequency behaviour	187 Hz ± 13.9 %
Duty cycle, timing (Tx ON / OFF) and average factor measurements	± 1.0 %
Unintentional radiator tests	
Conducted emissions with LISN	9 kHz to 150 kHz: ± 3.9 dB 150 kHz to 30 MHz: ± 3.8 dB
Radiated emissions at 3 m measuring distance Horizontal polarization	Biconilog antenna: ± 5.3 dB Biconical antenna: ± 5.0 dB Log periodic antenna: ± 5.3 dB Double ridged horn antenna: ± 5.3 dB
Vertical polarization	Biconilog antenna: ± 6.0 dB Biconical antenna: ± 5.7 dB Log periodic antenna: ± 6.0 dB Double ridged horn antenna: ± 6.0 dB

Hermon Laboratories is accredited by A2LA for calibration according to present requirements of ISO/IEC 17025 and NCSL Z540-1. The accreditation is granted to perform calibration of parameters that are listed in the Scope of Hermon Laboratories Accreditation.

Hermon Laboratories calibrates its reference and transfer standards by calibration laboratories accredited to ISO/IEC 17025 by a mutually recognized Accreditation Body or by a recognized national metrology institute. All reference and transfer standards used in the calibration system are traceable to national or international standards.

In-house calibration of all test and measurement equipment is performed on a regular basis according to Hermon Laboratories calibration procedures, manufacturer calibration/verification procedures or procedures defined in the relevant standards. The Hermon Laboratories test and measurement equipment is calibrated within the tolerances specified by the manufacturers and/or by the relevant standards.

10 APPENDIX C Test facility description

Tests were performed at Hermon Laboratories Ltd., which is a fully independent, private, EMC, safety, environmental and telecommunication testing facility.

Hermon Laboratories is recognized and accredited by the Federal Communications Commission (USA) for 1, 2, 15, 18 parts of Code of Federal Regulations 47 (CFR 47), Test Firm Registration Number is 927748, Designation Number is IL1001; registered by Industry Canada for electromagnetic emissions, file number IC 2186A-1 for OATS, certified by VCCI, Japan (the registration numbers are R-808 for OATS, R-1082 for anechoic chamber, G-869 for RE measurements above 1 GHz, C-845 for conducted emissions site, T-1606 for conducted emissions at telecommunication ports). The laboratory is accredited by American Association for Laboratory Accreditation (USA) according to ISO/IEC 17025 for electromagnetic compatibility, product safety, telecommunications testing and environmental simulation (for exact scope please refer to Certificate No. 839.01).

Address: P.O. Box 23, Binyamina 30500, Israel.
Telephone: +972 4628 8001
Fax: +972 4628 8277
e-mail: mail@hermonlabs.com
website: www.hermonlabs.com

Person for contact: Mr. Alex Usoskin, CEO.

11 APPENDIX D Specification references

47CFR part 27: 2015	Private land mobile radio services
47CFR part 1: 2015	Practice and procedure
47CFR part 2: 2015	Frequency allocations and radio treaty matters; general rules and regulations
ANSI C63.2: 1996	American National Standard for Instrumentation-Electromagnetic Noise and Field Strength, 10 kHz to 40 GHz-Specifications.
ANSI/TIA/EIA-603-D:2010	Land Mobile FM or PM Communications Equipment Measurement and Performance Standards
KDB 935210 D05 v01r01:12.02.2016	Measurements Guidance for Industrial and Non-consumer Signal Booster, Repeater and Amplifier Devices



12 APPENDIX E Test equipment correction factors

Antenna factor
Active loop antenna
Model 6502, S/N 2857, HL 0446

Frequency, MHz	Magnetic antenna factor, dB	Electric antenna factor, dB
0.009	-32.8	18.7
0.010	-33.8	17.7
0.020	-38.3	13.2
0.050	-41.1	10.4
0.075	-41.3	10.2
0.100	-41.6	9.9
0.150	-41.7	9.8
0.250	-41.6	9.9
0.500	-41.8	9.8
0.750	-41.9	9.7
1.000	-41.4	10.1
2.000	-41.5	10.0
3.000	-41.4	10.2
4.000	-41.4	10.1
5.000	-41.5	10.1
10.000	-41.9	9.6
15.000	-41.9	9.6
20.000	-42.2	9.3
25.000	-42.8	8.7
30.000	-44.0	7.5

Antenna factor in dB(1/m) is to be added to receiver meter reading in dB(μ V) to convert it into field strength in dB(μ V/m).



Antenna factor
Biconilog antenna EMCO Model 3141
Ser.No.1011, HL 0604

Frequency, MHz	Antenna factor, dB(1/m)	Frequency, MHz	Antenna factor, dB(1/m)	Frequency, MHz	Antenna factor, dB(1/m)
26	7.8	580	20.6	1320	27.8
28	7.8	600	21.3	1340	28.3
30	7.8	620	21.5	1360	28.2
40	7.2	640	21.2	1380	27.9
60	7.1	660	21.4	1400	27.9
70	8.5	680	21.9	1420	27.9
80	9.4	700	22.2	1440	27.8
90	9.8	720	22.2	1460	27.8
100	9.7	740	22.1	1480	28.0
110	9.3	760	22.3	1500	28.5
120	8.8	780	22.6	1520	28.9
130	8.7	800	22.7	1540	29.6
140	9.2	820	22.9	1560	29.8
150	9.8	840	23.1	1580	29.6
160	10.2	860	23.4	1600	29.5
170	10.4	880	23.8	1620	29.3
180	10.4	900	24.1	1640	29.2
190	10.3	920	24.1	1660	29.4
200	10.6	940	24.0	1680	29.6
220	11.6	960	24.1	1700	29.8
240	12.4	980	24.5	1720	30.3
260	12.8	1000	24.9	1740	30.8
280	13.7	1020	25.0	1760	31.1
300	14.7	1040	25.2	1780	31.0
320	15.2	1060	25.4	1800	30.9
340	15.4	1080	25.6	1820	30.7
360	16.1	1100	25.7	1840	30.6
380	16.4	1120	26.0	1860	30.6
400	16.6	1140	26.4	1880	30.6
420	16.7	1160	27.0	1900	30.6
440	17.0	1180	27.0	1920	30.7
460	17.7	1200	26.7	1940	30.9
480	18.1	1220	26.5	1960	31.2
500	18.5	1240	26.5	1980	31.6
520	19.1	1260	26.5	2000	32.0
540	19.5	1280	26.6		
560	19.8	1300	27.0		

Antenna factor in dB(1/m) is to be added to receiver meter reading in dB(μ V) to convert it into field strength in dB(μ V/m).



Antenna factor, HL 4933



Active Horn Antenna Factor Calibration

1 GHz to 18 GHz

Equipment:	ACTIVE HORN ANTENNA
Model:	AHA-118
Serial Number:	701046
Calibration Distance:	3 Meter
Polarization:	Horizontal
Calibration Date:	11/12/2014

Frequency (GHz)	Preamplifier Gain (dB)	Antenna Factor with pre-amp (dB/m)	Frequency (GHz)	Preamplifier Gain (dB)	Antenna Factor with pre-amp (dB/m)
1	40.96	-16.47	10	40.94	-1.97
1.5	41.21	-14.53	10.5	40.63	-1.06
2	41.44	-13.30	11	40.74	-1.50
2.5	41.71	-12.87	11.5	40.65	-0.52
3	41.96	-12.26	12	40.76	-0.15
3.5	42.14	-11.77	12.5	41.03	-0.85
4	42.13	-10.91	13	41.37	-0.81
4.5	41.79	-9.41	13.5	41.18	0.05
5	41.44	-7.54	14	40.98	0.36
5.5	40.91	-6.47	14.5	40.81	1.26
6	40.69	-5.48	15	40.65	0.25
6.5	40.64	-5.53	15.5	40.93	-1.05
7	40.76	-4.12	16	41.31	-1.44
7.5	40.94	-3.12	16.5	40.96	-0.80
8	40.68	-1.69	17	40.64	-0.02
8.5	40.08	-1.71	17.5	40.57	1.81
9	40.41	-1.86	18	40.08	3.63
9.5	41.21	-2.73			

Calibration according to ARP 958

Antenna Factor to be added to receiver reading:

Meter Reading (dBuV) + Antenna Factor (dB/m) = Corrected Reading (dBuV/m)



Antenna factor, HL 4956



Active Horn Antenna Calibration

18 GHz to 40 GHz

Equipment:	ACTIVE HORN ANTENNA
Model:	AHA-840
Serial Number:	105004
Calibration Distance:	3 meter
Polarization:	Horizontal
Calibration Date:	1/26/2015

Frequency (GHz)	Preamplifier Gain (dB)	Antenna Factor with pre-amp (dB/m)	Frequency (GHz)	Preamplifier Gain (dB)	Antenna Factor with pre-amp (dB/m)
18	38.83	-1.06	29.5	42.47	-5.33
18.5	39.34	-2.65	30	41.91	-4.86
19	39.71	-3.88	30.5	41.60	-4.64
19.5	39.87	-4.35	31	41.52	-4.60
20	39.98	-3.97	31.5	41.56	-4.79
20.5	40.42	-3.68	32	41.80	-5.21
21	41.12	-4.06	32.5	42.29	-5.54
21.5	41.74	-5.46	33	42.79	-5.63
22	42.14	-6.22	33.5	42.88	-5.38
22.5	42.35	-6.42	34	42.62	-4.76
23	42.50	-6.59	34.5	42.63	-4.84
23.5	42.65	-6.82	35	43.15	-5.13
24	42.81	-7.01	35.5	43.91	-5.83
24.5	42.86	-7.37	36	44.59	-6.39
25	42.73	-7.53	36.5	45.04	-6.64
25.5	42.77	-7.45	37	45.08	-6.40
26	42.85	-7.21	37.5	44.82	-5.75
26.5	42.98	-7.17	38	44.16	-4.58
27	43.14	-7.22	38.5	42.90	-2.66
27.5	43.18	-7.32	39	42.39	-1.71
28	43.04	-7.10	39.5	43.76	-2.49
28.5	43.01	-6.73	40	45.98	-5.21

Calibration per ANSI C63.5: 2006
Standard Site Method, Equations 1-6 (3-antenna)
 Corrected Reading (dBµV/m) = Meter Reading (dBµV) + AFE(dB/m)



Cable loss
Test Cable, Mini-Circuits, CBL-5FT-SMSM+, SMA-SMA, 18 GHz, 1.5 m, S/N 25679
Mini-Circuits, HL 3433

Frequency, MHz	Cable loss, dB	Frequency, MHz	Cable loss, dB
10.0	0.06	9000	2.01
100	0.17	9500	2.06
500	0.41	10000	2.05
1000	0.58	10500	2.18
1500	0.72	11000	2.26
2000	0.86	11500	2.28
2500	0.96	12000	2.43
3000	1.04	12500	2.53
3500	1.13	13000	2.52
4000	1.23	13500	2.56
4500	1.31	14000	2.60
5000	1.41	14500	2.59
5500	1.49	15000	2.67
6000	1.55	15500	2.76
6500	1.63	16000	2.86
7000	1.71	16500	2.91
7500	1.78	17000	2.95
8000	1.86	17500	3.02
8500	1.92	18000	3.07



Cable loss
Cable coaxial, Microwave, SMA-SMA, 18 GHz, 1.0 m
Gore, HL 3472

Frequency, MHz	Cable loss, dB	Frequency, MHz	Cable loss, dB	Frequency, MHz	Cable loss, dB	Frequency, MHz	Cable loss, dB
10	0.01	5000	0.47	10200	0.72	15500	0.75
30	0.03	5100	0.47	10300	0.67	15600	0.89
50	0.04	5200	0.47	10400	0.77	15700	0.82
100	0.04	5300	0.47	10500	0.67	15800	0.89
200	0.08	5400	0.49	10600	0.74	15900	0.89
300	0.11	5500	0.48	10700	0.81	16000	0.93
400	0.11	5600	0.49	10800	0.77	16100	0.90
500	0.12	5700	0.49	10900	0.82	16200	0.92
600	0.14	5800	0.51	11000	0.86	16300	0.90
700	0.15	5900	0.50	11100	0.78	16400	0.94
800	0.16	6000	0.51	11200	0.82	16500	0.93
900	0.18	6100	0.53	11300	0.77	16600	0.95
1000	0.17	6200	0.52	11400	0.84	16700	0.98
1100	0.19	6300	0.53	11500	0.74	16800	1.00
1200	0.22	6400	0.54	11600	0.81	16900	0.94
1300	0.21	6500	0.55	11700	0.73	17000	1.00
1400	0.22	6600	0.54	11800	0.75	17100	0.93
1500	0.23	6700	0.57	11900	0.73	17200	1.00
1600	0.24	6800	0.54	12000	0.75	17300	0.93
1700	0.24	6900	0.58	12100	0.66	17400	0.93
1800	0.25	7000	0.58	12200	0.66	17500	0.96
1900	0.26	7100	0.58	12300	0.72	17600	0.94
2000	0.28	7200	0.61	12400	0.64	17700	0.99
2100	0.27	7300	0.59	12500	0.75	17800	0.97
2200	0.29	7400	0.55	12600	0.67	17900	0.90
2300	0.29	7500	0.63	12700	0.75	18000	0.78
2400	0.30	7600	0.60	12800	0.66		
2500	0.30	7700	0.61	12900	0.81		
2600	0.32	7800	0.64	13000	0.75		
2700	0.32	7900	0.60	13100	0.80		
2800	0.33	8000	0.58	13200	0.80		
2900	0.34	8100	0.61	13300	0.81		
3000	0.34	8200	0.62	13400	0.88		
3100	0.35	8300	0.62	13500	0.82		
3200	0.35	8400	0.68	13600	1.00		
3300	0.36	8500	0.63	13700	0.93		
3400	0.37	8600	0.61	13800	0.86		
3500	0.38	8700	0.63	13900	0.84		
3600	0.38	8800	0.62	14000	1.00		
3700	0.40	8900	0.64	14100	0.86		
3800	0.40	9000	0.62	14200	0.98		
3900	0.40	9100	0.64	14300	0.99		
4000	0.40	9200	0.62	14400	0.82		
4100	0.43	9300	0.62	14600	0.89		
4200	0.43	9400	0.62	14700	0.84		
4300	0.43	9500	0.63	14800	0.90		
4400	0.44	9600	0.64	14900	0.89		
4500	0.45	9700	0.60	15000	0.89		
4600	0.45	9800	0.65	15100	0.86		
4700	0.46	9900	0.60	15200	0.87		
4800	0.46	10000	0.67	15300	0.86		
4900	0.46	10100	0.69	15400	0.87		



Cable loss
Cable coaxial, Microwave, SMA-SMA, 18 GHz, 0.6 m
Gore, HL 3474

Frequency, MHz	Cable loss, dB	Frequency, MHz	Cable loss, dB	Frequency, MHz	Cable loss, dB	Frequency, MHz	Cable loss, dB
10	0.00	4800	0.43	9800	0.63	14900	0.89
30	0.02	4900	0.44	9900	0.58	15000	0.96
50	0.03	5000	0.44	10000	0.67	15100	0.90
100	0.03	5100	0.44	10100	0.69	15200	0.96
200	0.07	5200	0.44	10200	0.72	15300	0.90
300	0.10	5300	0.44	10300	0.68	15400	0.95
400	0.11	5400	0.46	10400	0.75	15500	0.84
500	0.12	5500	0.45	10500	0.64	15600	0.95
600	0.14	5600	0.46	10600	0.75	15700	0.82
700	0.14	5700	0.47	10700	0.80	15800	0.94
800	0.15	5800	0.48	10800	0.77	15900	0.91
900	0.18	5900	0.48	10900	0.80	16000	0.91
1000	0.17	6000	0.49	11000	0.79	16100	0.86
1100	0.18	6100	0.51	11100	0.70	16200	0.86
1200	0.21	6200	0.50	11200	0.76	16300	0.86
1300	0.20	6300	0.50	11300	0.70	16400	0.84
1400	0.21	6400	0.51	11400	0.73	16500	0.83
1500	0.22	6500	0.51	11500	0.67	16600	0.87
1600	0.23	6600	0.52	11600	0.74	16700	0.90
1700	0.23	6700	0.54	11700	0.64	16800	0.91
1800	0.24	6800	0.51	11800	0.68	16900	0.90
1900	0.25	6900	0.55	11900	0.67	17000	0.97
2000	0.27	7000	0.54	12000	0.71	17100	0.94
2100	0.26	7100	0.55	12100	0.64	17200	1.01
2200	0.28	7200	0.55	12200	0.64	17300	0.97
2300	0.28	7300	0.54	12300	0.71	17400	1.02
2400	0.28	7400	0.52	12400	0.62	17500	1.06
2500	0.29	7500	0.58	12500	0.80	17600	1.01
2600	0.30	7600	0.56	12600	0.69	17700	1.10
2700	0.31	7700	0.57	12700	0.85	17800	1.16
2800	0.32	7800	0.62	12800	0.67	17900	1.12
2900	0.32	7900	0.57	12900	0.84	18000	1.00
3000	0.32	8000	0.55	13000	0.76		
3100	0.33	8100	0.59	13100	0.85		
3200	0.33	8200	0.59	13200	0.77		
3300	0.35	8300	0.60	13300	0.82		
3400	0.35	8400	0.66	13400	0.79		
3500	0.36	8500	0.60	13500	0.82		
3600	0.36	8600	0.59	13600	0.91		
3700	0.37	8700	0.59	13700	0.81		
3800	0.38	8800	0.58	13800	0.76		
3900	0.38	8900	0.60	13900	0.75		
4000	0.38	9000	0.60	14000	0.81		
4100	0.41	9100	0.60	14100	0.77		
4200	0.40	9200	0.57	14200	0.89		
4300	0.41	9300	0.57	14300	0.92		
4400	0.42	9400	0.58	14400	0.78		
4500	0.43	9500	0.60	14600	0.85		
4600	0.42	9600	0.62	14700	0.83		
4700	0.44	9700	0.58	14800	0.95		



Cable loss
Microwave Cable Assembly, Huber-Suhner, 40 GHz, 3.5 m, SMA-SMA, S/N 1225/2A
HL 3901

Frequency, MHz	Cable loss, dB	Frequency, MHz	Cable loss, dB	Frequency, MHz	Cable loss, dB
10	0.09	9500	4.29	21000	6.67
100	0.41	10000	4.40	22000	6.92
500	0.93	10500	4.52	23000	7.00
1000	1.33	11000	4.64	24000	7.18
1500	1.63	11500	4.76	25000	7.29
2000	1.90	12000	4.87	26000	7.55
2500	2.12	12500	4.99	27000	7.70
3000	2.33	13000	5.11	28000	7.88
3500	2.50	13500	5.20	29000	8.02
4000	2.67	14000	5.31	30000	8.15
4500	2.82	14500	5.42	31000	8.35
5000	2.99	15000	5.51	32000	8.40
5500	3.16	15500	5.58	33000	8.62
6000	3.32	16000	5.68	34000	8.73
6500	3.51	16500	5.78	35000	8.78
7000	3.65	17000	5.91	36000	8.94
7500	3.79	17500	5.99	37000	9.21
8000	3.92	18000	6.07	38000	9.37
8500	4.04	19000	6.36	39000	9.45
9000	4.18	20000	6.49	40000	9.52



Cable loss
Test cable, Mini-Circuits, S/N 0755A, 18 GHz, 4.6 m, N/M - N/M
APC-15FT-NMNM+, HL 4278

Frequency, MHz	Cable loss, dB	Frequency, MHz	Cable loss, dB	Frequency, MHz	Cable loss, dB	Frequency, MHz	Cable loss, dB
10	0.24	4900	4.19	10000	6.47	15100	8.33
30	0.26	5000	4.25	10100	6.50	15200	8.35
50	0.34	5100	4.29	10200	6.52	15300	8.37
100	0.50	5200	4.32	10300	6.57	15400	8.40
200	0.72	5300	4.38	10400	6.59	15500	8.42
300	0.90	5400	4.41	10500	6.61	15600	8.46
400	1.06	5500	4.46	10600	6.64	15700	8.50
500	1.20	5600	4.51	10700	6.64	15800	8.52
600	1.32	5700	4.56	10800	6.65	15900	8.56
700	1.44	5800	4.59	10900	6.68	16000	8.61
800	1.54	5900	4.64	11000	6.68	16100	8.64
900	1.64	6000	4.69	11100	6.69	16200	8.66
1000	1.74	6100	4.72	11200	6.70	16300	8.70
1100	1.83	6200	4.77	11300	6.74	16400	8.73
1200	1.92	6300	4.80	11400	6.78	16500	8.74
1300	2.01	6400	4.83	11500	6.81	16600	8.75
1400	2.09	6500	4.89	11600	6.84	16700	8.78
1500	2.18	6600	4.90	11700	6.87	16800	8.79
1600	2.25	6700	4.95	11800	6.92	16900	8.81
1700	2.33	6800	5.01	11900	6.98	17000	8.85
1800	2.39	6900	4.99	12000	7.02	17100	8.90
1900	2.47	7000	5.04	12100	7.08	17200	8.95
2000	2.53	7100	5.11	12200	7.15	17300	8.99
2100	2.60	7200	5.14	12300	7.20	17400	9.03
2200	2.67	7300	5.21	12400	7.26	17500	9.07
2300	2.73	7400	5.29	12500	7.31	17600	9.11
2400	2.80	7500	5.33	12600	7.36	17700	9.15
2500	2.87	7600	5.38	12700	7.41	17800	9.19
2600	2.93	7700	5.46	12800	7.46	17900	9.24
2700	3.00	7800	5.52	12900	7.51	18000	9.28
2800	3.06	7900	5.58	13000	7.55		
2900	3.12	8000	5.64	13100	7.59		
3000	3.18	8100	5.69	13200	7.65		
3100	3.24	8200	5.75	13300	7.69		
3200	3.30	8300	5.80	13400	7.72		
3300	3.35	8400	5.84	13500	7.78		
3400	3.42	8500	5.90	13600	7.82		
3500	3.46	8600	5.97	13700	7.86		
3600	3.52	8700	5.99	13800	7.91		
3700	3.57	8800	6.04	13900	7.96		
3800	3.61	8900	6.10	14000	8.01		
3900	3.67	9000	6.13	14100	8.06		
4000	3.71	9100	6.17	14200	8.10		
4100	3.77	9200	6.23	14300	8.13		
4200	3.83	9300	6.27	14400	8.16		
4300	3.89	9400	6.30	14500	8.19		
4400	3.94	9500	6.35	14600	8.21		
4500	4.00	9600	6.37	14700	8.23		
4600	4.05	9700	6.40	14800	8.26		
4700	4.10	9800	6.44	14900	8.28		
4800	4.16	9900	6.45	15000	8.30		



Cable loss
Low Loss Armored Test Cable, MegaPhase, 18 GHz, 6.2 m, N type-M/N type-M,
NC29-N1N1-244S/N 12025101 003,
HL 4353

Frequency, MHz	Cable loss, dB	Frequency, MHz	Cable loss, dB
50	0.20	9000	2.71
100	0.27	9500	2.81
300	0.47	10000	2.90
500	0.61	10500	2.97
1000	0.87	11000	3.06
1500	1.07	11500	3.13
2000	1.24	12000	3.20
2500	1.39	12500	3.26
3000	1.53	13000	3.34
3500	1.65	13500	3.39
4000	1.77	14000	3.47
4500	1.89	14500	3.54
5000	1.99	15000	3.62
5500	2.07	15500	3.69
6000	2.20	16000	3.76
6500	2.30	16500	3.83
7000	2.39	17000	3.86
7500	2.51	17500	3.94
8000	2.58	18000	4.02
8500	2.65		



Cable loss
RF Cable, Huber-Suhner, 40 GHz, 5.5 m, K type,
SF102EA/11SK/11SK/5500MM, S/N 502494/2EA
HL 5112

Frequency, MHz	Cable loss, dB	Frequency, MHz	Cable loss, dB
100	0.69	20500	10.18
200	0.97	21000	10.32
300	1.18	21500	10.47
500	1.52	22000	10.60
1000	2.14	22500	10.75
1500	2.62	23000	10.87
2000	3.03	23500	11.00
2500	3.40	24000	11.12
3000	3.73	24500	11.23
3500	4.04	25000	11.35
4000	4.33	25500	11.52
4500	4.60	26000	11.64
5000	4.86	26500	11.73
5500	5.10	27000	11.84
6000	5.34	27500	11.93
6500	5.57	28000	12.05
7000	5.79	28500	12.19
7500	6.00	29000	12.33
8000	6.21	29500	12.44
8500	6.43	30000	12.53
9000	6.62	30500	12.58
9500	6.82	31000	12.71
10000	7.01	31500	12.86
10500	7.17	32000	13.00
11000	7.34	32500	13.11
11500	7.51	33000	13.24
12000	7.68	33500	13.33
12500	7.84	34000	13.44
13000	8.00	34500	13.58
13500	8.16	35000	13.69
14000	8.32	35500	13.81
14500	8.48	36000	13.93
15000	8.63	36500	14.05
15500	8.77	37000	14.24
16000	8.92	37500	14.28
16500	9.08	38000	14.38
17000	9.23	38500	14.50
17500	9.37	39000	14.61
18000	9.51	39500	14.70
18500	9.66	40000	14.83
19000	9.78		
19500	9.92		
20000	10.07		



13 APPENDIX F Abbreviations and acronyms

A	ampere
AC	alternating current
AM	amplitude modulation
AVRG	average (detector)
BB	broad band
cm	centimeter
dB	decibel
dBm	decibel referred to one milliwatt
dB(μ V)	decibel referred to one microvolt
dB(μ V/m)	decibel referred to one microvolt per meter
dB(μ A)	decibel referred to one microampere
DC	direct current
EIRP	equivalent isotropically radiated power
ERP	effective radiated power
EUT	equipment under test
F	frequency
GHz	gigahertz
GND	ground
H	height
HL	Hermon laboratories
Hz	hertz
k	kilo
kHz	kilohertz
LO	local oscillator
m	meter
MHz	megahertz
min	minute
mm	millimeter
ms	millisecond
μ s	microsecond
NA	not applicable
NB	narrow band
OATS	open area test site
Ω	Ohm
QP	quasi-peak
RE	radiated emission
RF	radio frequency
rms	root mean square
Rx	receive
s	second
T	temperature
Tx	transmit
V	volt

END OF DOCUMENT