

• Port1 / LTE 5 MHz / 2 357.5 MHz / 64QAM

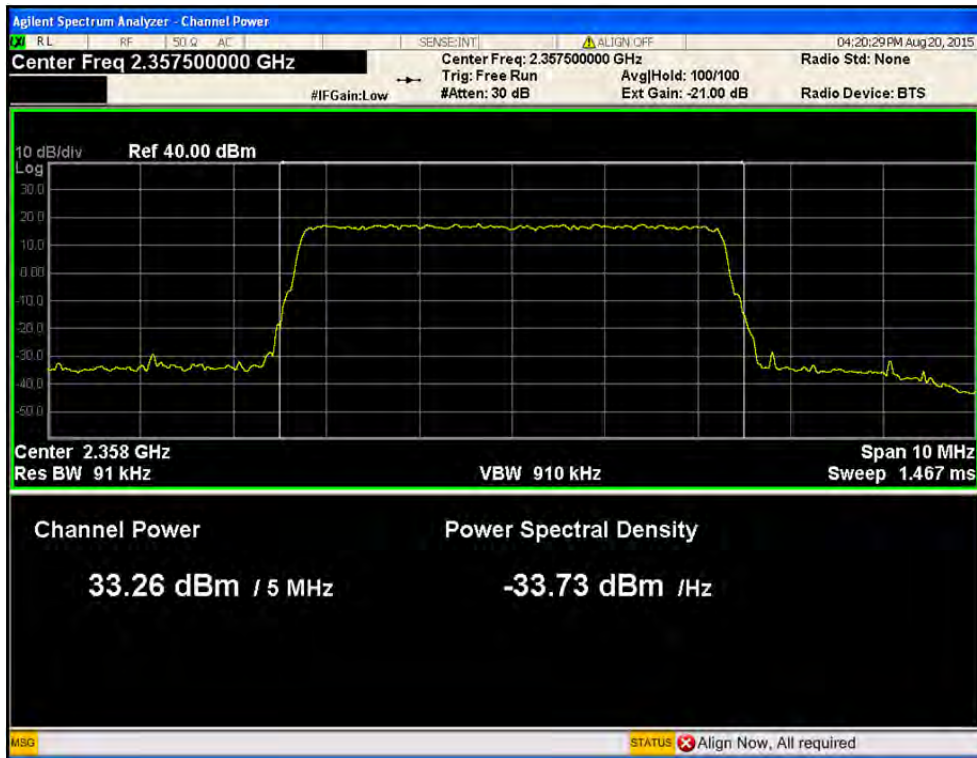

• Port2 / LTE 10 MHz / 2 355 MHz / QPSK

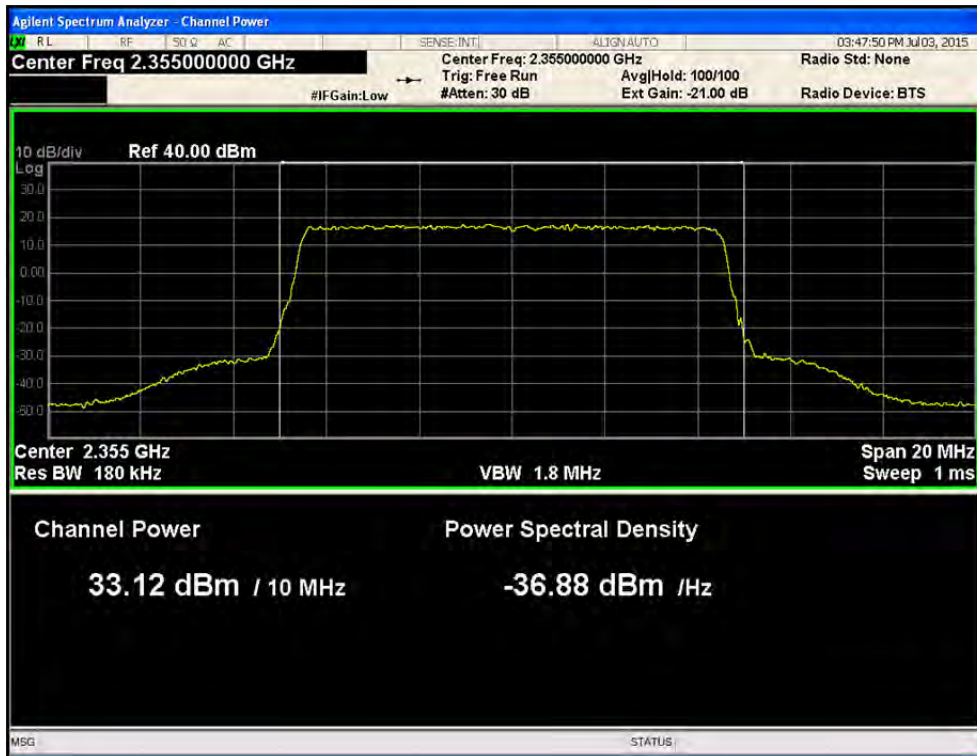

• Port2 / LTE 10 MHz / 2 355 MHz / 16QAM

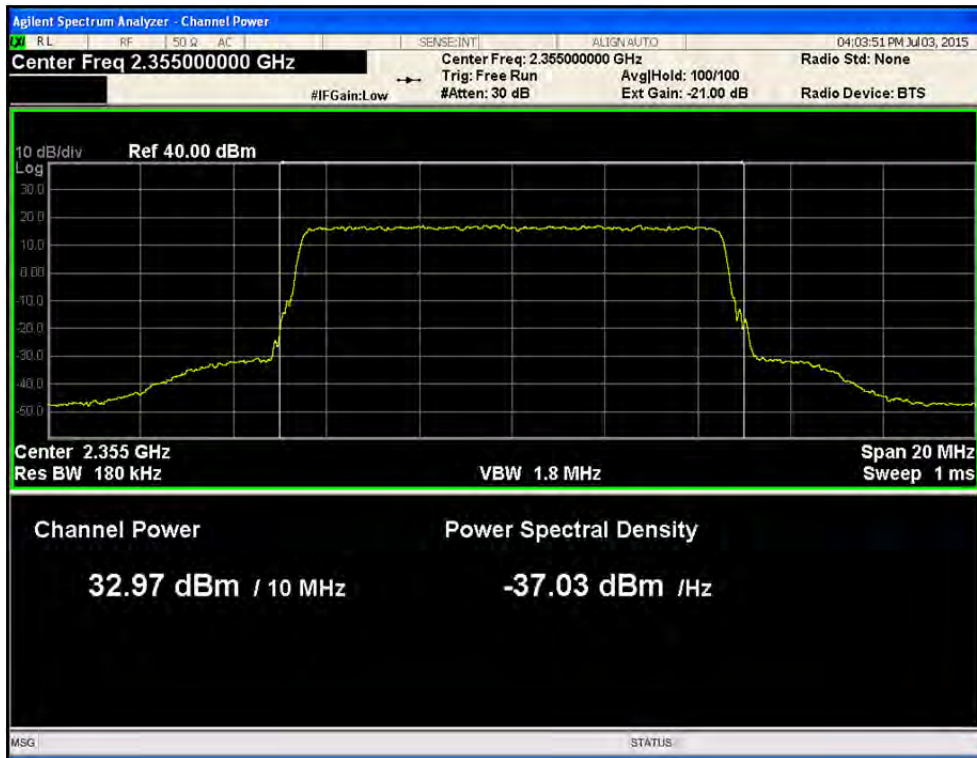

• Port2 / LTE 10 MHz / 2 355 MHz / 64QAM

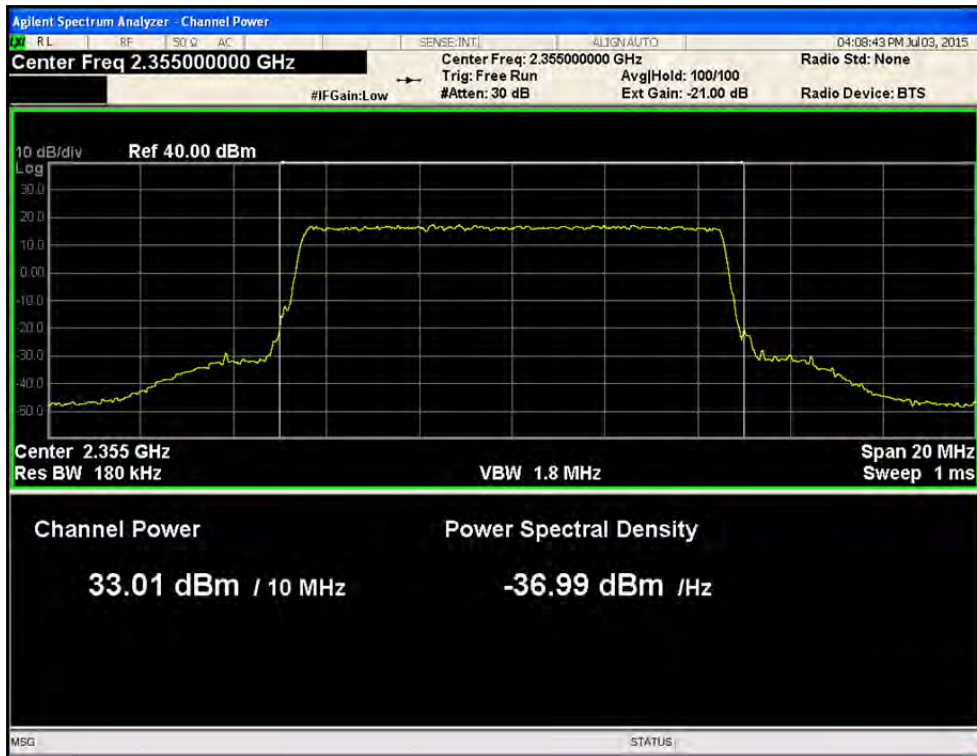

• Port2 / LTE 5 MHz / 2 352.5 MHz / QPSK

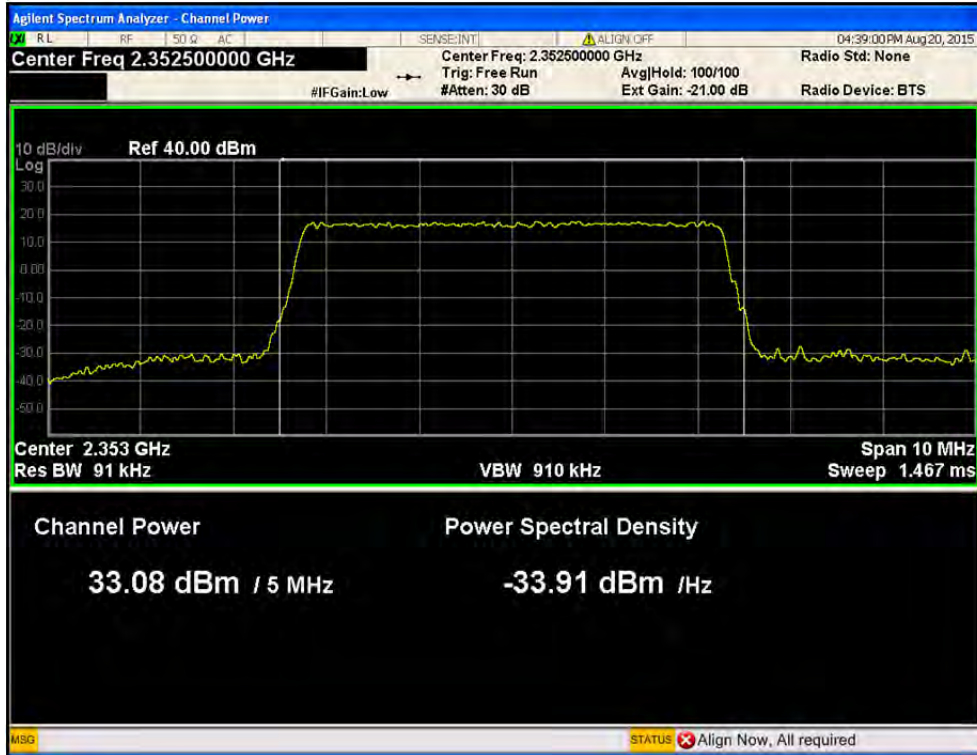

• Port2 / LTE 5 MHz / 2 352.5 MHz / 16QAM

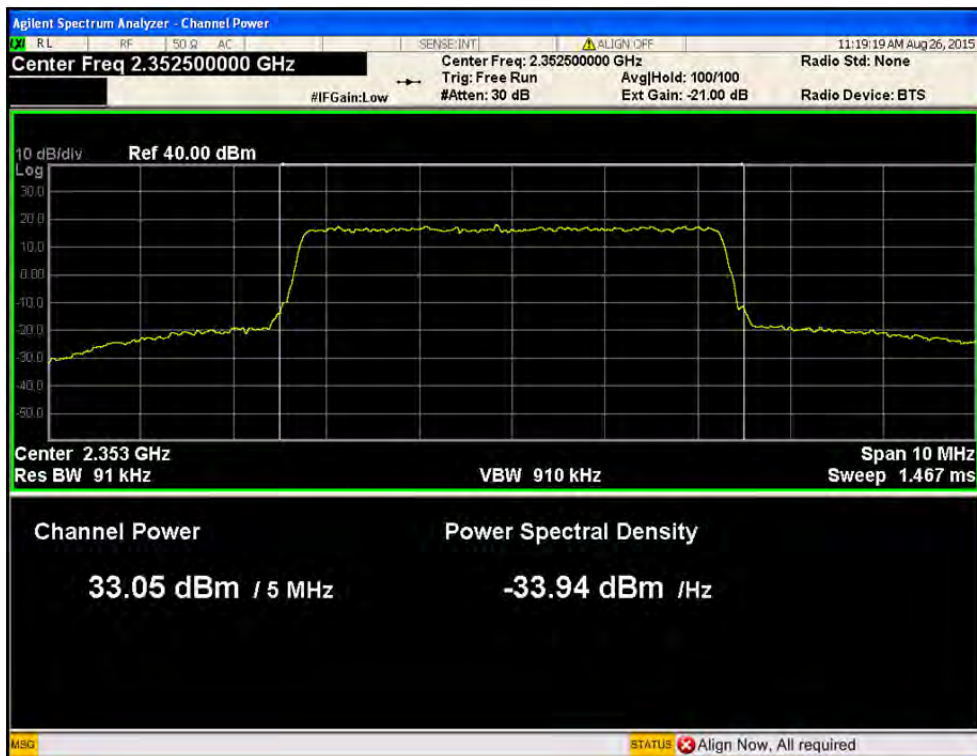

• Port2 / LTE 5 MHz / 2 352.5 MHz / 64QAM

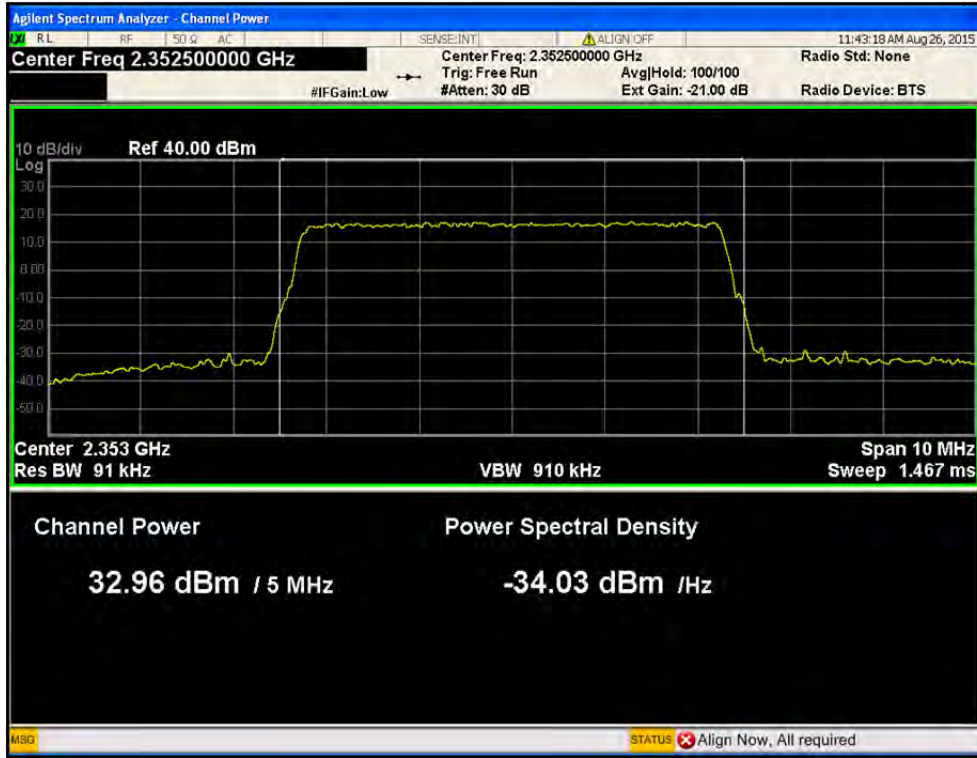

• Port2 / LTE 5 MHz / 2 357.5 MHz / QPSK

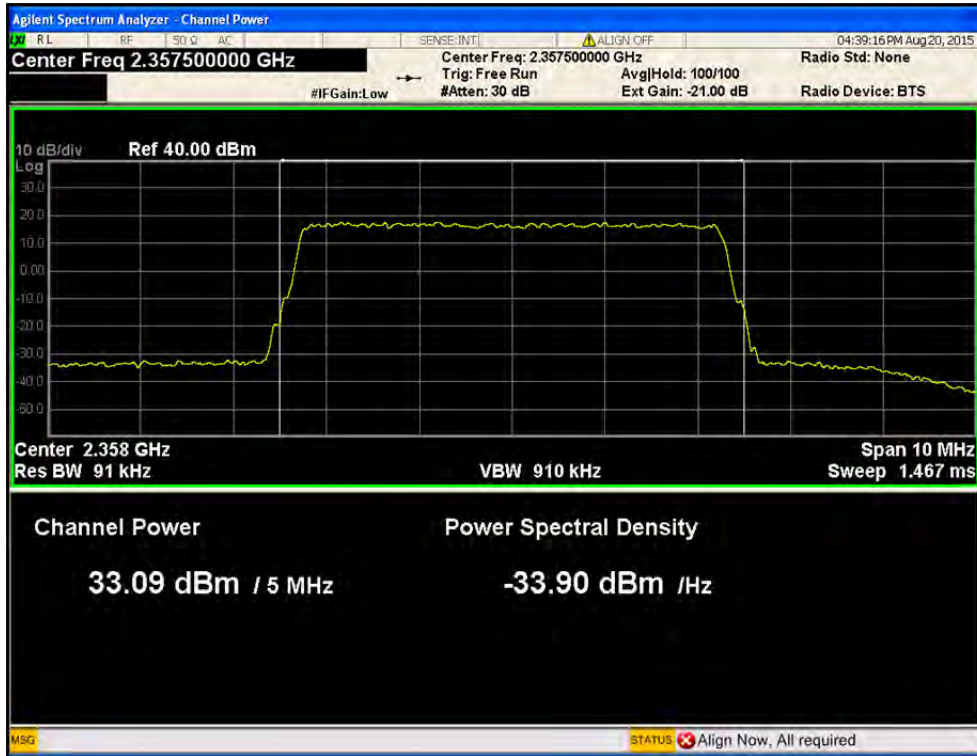

• Port2 / LTE 5 MHz / 2 357.5 MHz / 16QAM

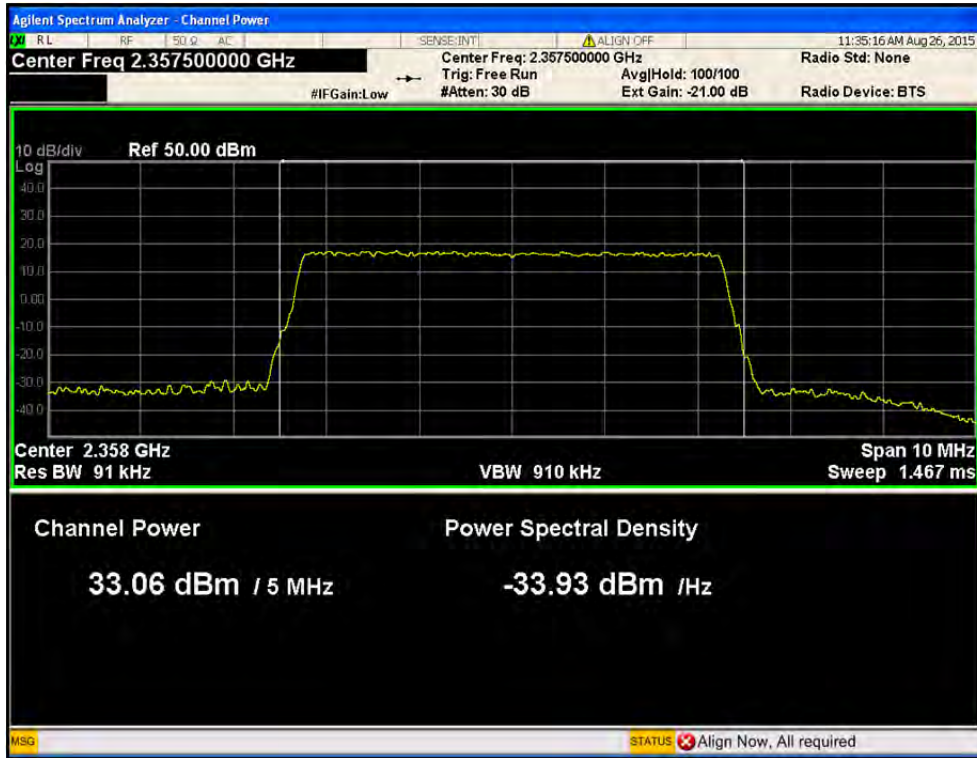

• Port2 / LTE 5 MHz / 2 357.5 MHz / 64QAM

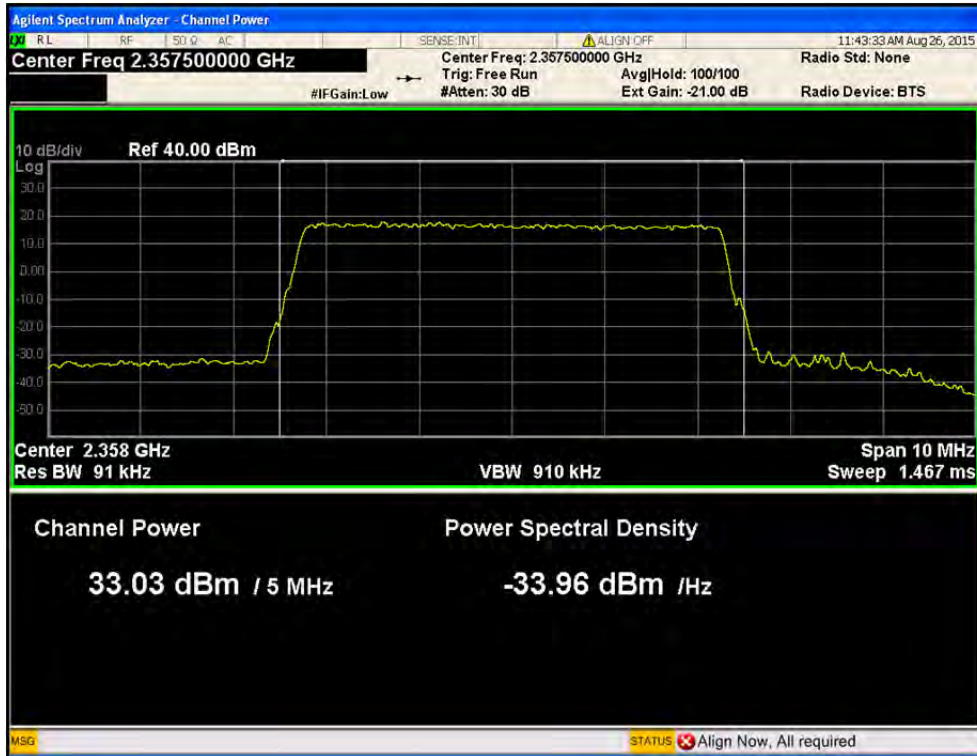

3.4.8 PAPR Test Plots

- Port1 / LTE 5 MHz / 2 352.5 MHz / 64QAM

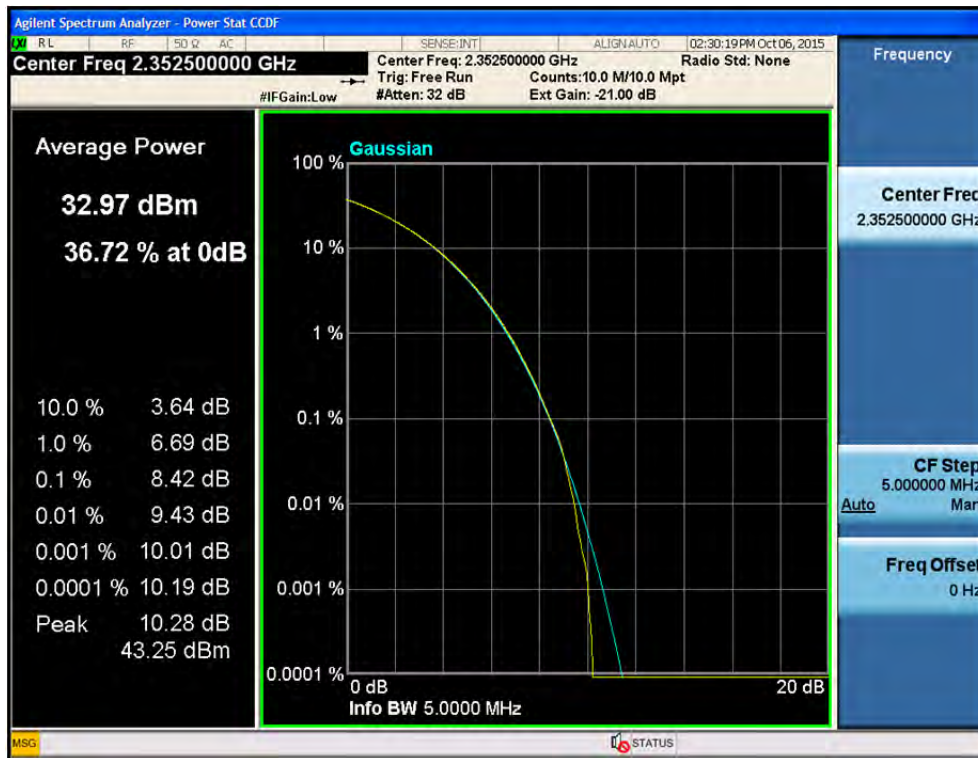

- Port1 / LTE 5 MHz / 2 357.5 MHz / 64QAM



• Port1 / LTE 10 MHz / 2 355 MHz / 64QAM

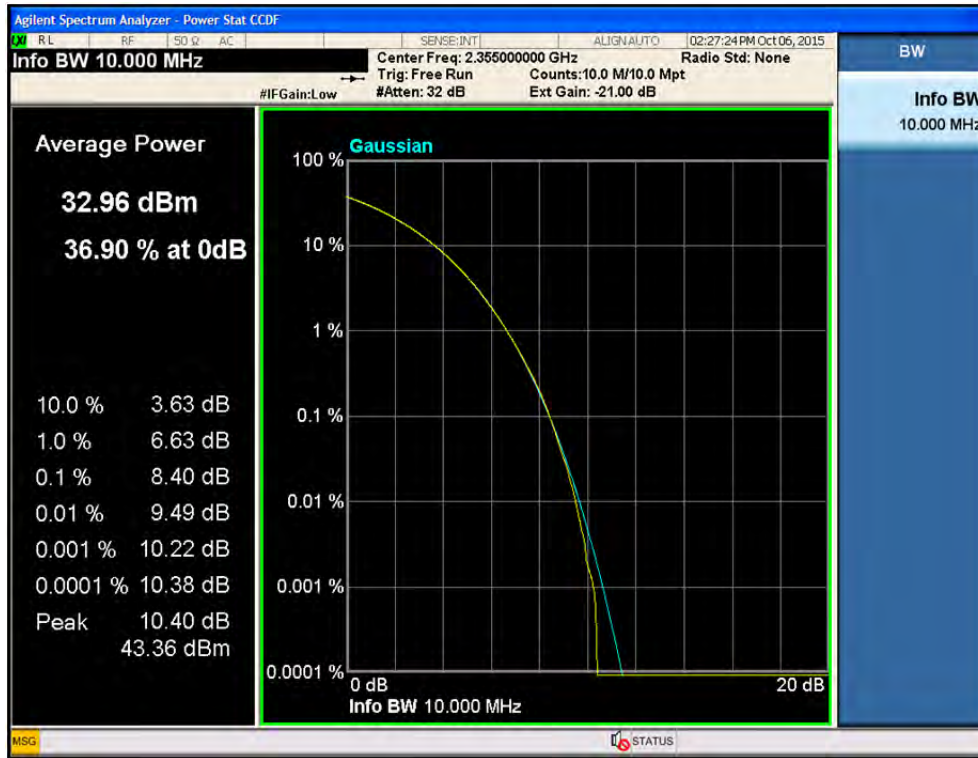

• Port2 / LTE 5 MHz / 2 352.5 MHz / 64QAM



• Port1 / LTE 5 MHz / 2 357.5 MHz / 64QAM

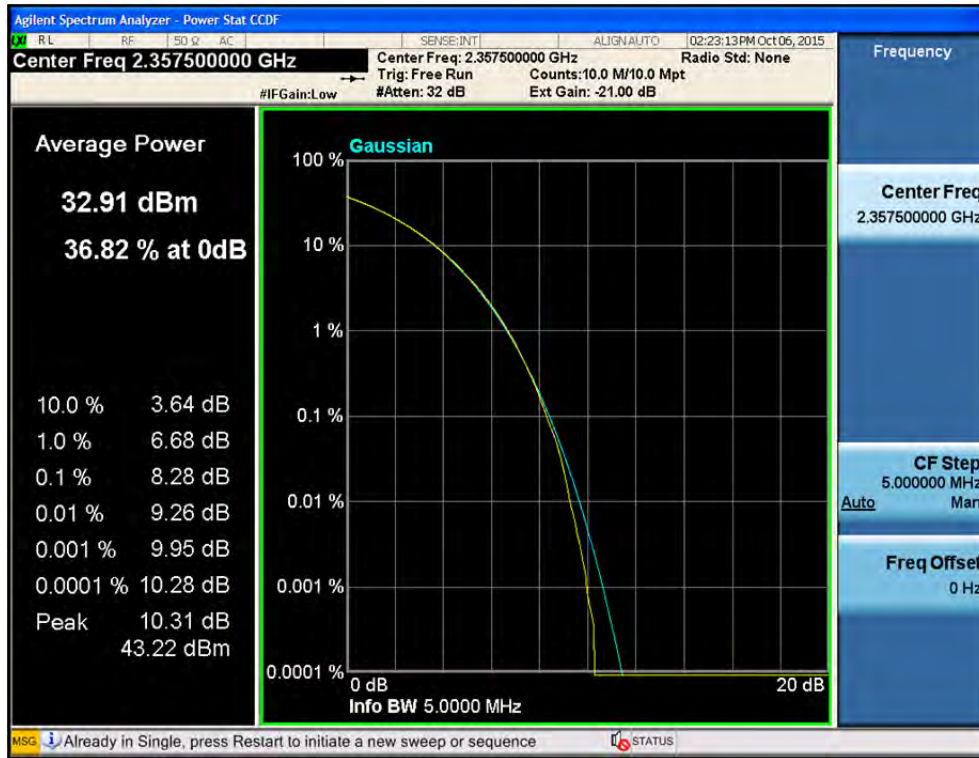

• Port2 / LTE 10 MHz / 2 355 MHz / 64QAM



3.5 Radiated spurious emission

3.5.1 Specification

- FCC Part 2.1053
- FCC Part 27.53

3.5.2 Test Description

The highest gain antenna to be used with the EUT was tested for final measurements. The EUT was configured for the lowest and the highest transmit frequency. For each configuration, the spectrum was scanned throughout the specified range. While scanning, emissions from the EUT were maximized by rotating the EUT on a turntable, adjusting the position of the EUT and EUT antenna in three orthogonal axis, and adjusting the measurement antenna height and polarization (per ANSI C63.10:2009). A preamp and high pass filter were used for this test in order to provide sufficient measured sensitivity.

For licensed transmitters, the FCC reference TIA/EIA-603 as the measurement procedure standard. TIA/EIA-603 Section 2.2.12 describes a method for measuring radiated spurious emission that utilizes an antenna substitution method:

At an approved test site, the transmitter is place on a remotely controlled turntable, and the measurement antenna is place 3 meters from the transmitter.

The transmitter is place on a remotely controlled turntable, and the measurement antenna is placed 3 meters from the transmitter. The turntable azimuth is varied to maximize the level of spurious emissions. The height of the measurement antenna is also varied from 1 to 4 meters. The amplitude and frequency of the highest emission are noted. The transmitter is then replaced with a 1/2 wave dipole that is successively tuned to each of the highest spurious emission for emissions below 1 GHz, and a horn antenna for emission above 1 GHz.

A signal generator is connected to the dipole (horn antenna for frequency above 1GHz), and its output is adjusted to match the level previously noted for each frequency. The output of the signal generator is recorded, and by factoring in the cable loss to the antenna and its gain; the power(dBm) into an ideal 1/2 wave dipole antenna is determined for each radiated emission.

Radiated spurious emission was measured under the three types of modulation mode which are QPSK, 16QAM and 64QAM, and resource block was 50.

3.5.3 Set-Up

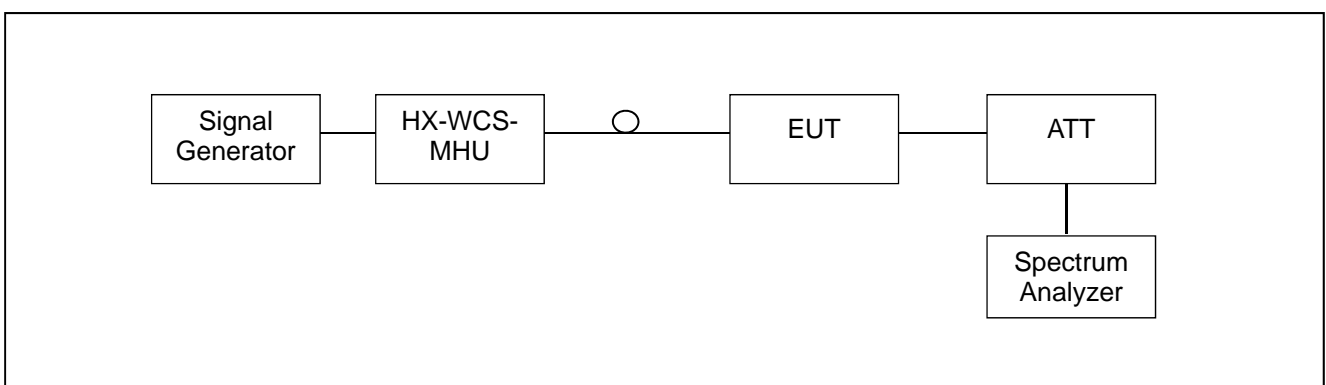

3.5.4 Test equipment list

Equipment	Model Name	Manufacturer
EUT	HX-WCS-MIMO	Corning Optical Communications Wireless, Inc.
MHU	HX-WCS-MHU	Corning Optical Communications Wireless Inc.
DC Power Supply	6674A	Agilent
Signal Generator	N5182A	Agilent
Spectrum Analyzer	N9020A	Agilent
EMI Test Receiver	ESS	R&S
Bi-conical Antenna	VHA9103	R&S
Spectrum Analyzer	FSP	R&S
Log Periodic Antenna	VULP9118A	R&S
Turn table	DS 1500 S-1t-O	Innco GmbH
Antenna mast	MA4000-O	Innco GmbH
Controller	CO 2000	Innco GmbH

3.5.5 Test condition

- Test place: Shield room
- Test environment: 23.0 °C, 43 % R.H.

3.5.6 Test results

• QPSK / SISO Mode

Frequency [MHz]	S/A [dBuV]	S/G [dBm]	Antenna gain [dBi]	Antenna polarity [H/V]	Cable loss [dB]	Total Level [dBm]	Limit [dBuV]	Margin [dB]
49.77	26.00	-65.77	1.37	H	1.13	-65.53	-13.00	52.53
141.32	18.10	-78.87	1.08	H	1.97	-79.76	-13.00	66.76
244.12	14.40	-81.45	0.79	H	2.46	-83.12	-13.00	70.12
268.45	14.50	-82.02	0.63	H	2.47	-83.86	-13.00	70.86
302.29	25.10	-60.66	0.40	H	2.80	-63.06	-13.00	50.06
309.63	16.70	-71.53	0.49	V	2.90	-73.94	-13.00	60.94
331.77	22.20	-64.65	0.73	H	2.77	-66.69	-13.00	53.69

• 16QAM / SISO Mode

Frequency [MHz]	Reading [dBuV]	Antenna polarity [H/V]	Antenna gain [dBi]	Cable loss [dB]	Level [dBuV]	Level [dBm]	Limit [dBuV]	Margin [dB]
49.77	26.20	-65.39	1.37	H	1.13	-65.15	-13.00	52.15
141.32	18.30	-77.56	1.08	H	1.97	-78.45	-13.00	65.45
244.11	14.30	-81.53	0.79	H	2.46	-83.20	-13.00	70.20
268.43	14.50	-82.04	0.63	H	2.47	-83.88	-13.00	70.88
302.28	25.00	-60.65	0.40	H	2.80	-63.05	-13.00	50.05
309.64	16.70	-71.52	0.49	V	2.90	-73.93	-13.00	60.93
331.78	22.00	-65.89	0.73	H	2.77	-67.93	-13.00	54.93

• 64QAM / SISO Mode

Frequency [MHz]	Reading [dBuV]	Antenna polarity [H/V]	Antenna gain [dBi]	Cable loss [dB]	Level [dBuV]	Level [dBm]	Limit [dBuV]	Margin [dB]
49.78	26.30	-65.48	1.37	H	1.13	-65.24	-13.00	52.24
141.31	18.20	-77.45	1.08	H	1.97	-78.34	-13.00	65.34
244.11	14.30	-81.53	0.79	H	2.46	-83.20	-13.00	70.20
268.44	14.40	-82.01	0.63	H	2.47	-83.85	-13.00	70.85
302.28	25.20	-60.46	0.40	H	2.80	-62.86	-13.00	49.86
331.75	16.80	-71.41	0.49	V	2.90	-73.82	-13.00	60.82
331.78	22.10	-64.76	0.73	H	2.77	-66.80	-13.00	53.80

• QPSK / MIMO Mode

Frequency [MHz]	Reading [dBuV]	Antenna polarity [H/V]	Antenna gain [dBi]	Cable loss [dB]	Level [dBuV]	Level [dBm]	Limit [dBuV]	Margin [dB]
49.77	26.20	-64.02	1.37	H	1.13	-63.78	-13.00	50.78
141.32	18.10	-78.87	1.08	H	1.97	-79.76	-13.00	66.76
244.12	14.40	-81.45	0.79	H	2.46	-83.12	-13.00	70.12
268.45	14.50	-82.02	0.63	H	2.47	-83.86	-13.00	70.86
302.29	25.10	-60.66	0.40	H	2.80	-63.06	-13.00	50.06
309.63	16.70	-71.53	0.49	V	2.90	-73.94	-13.00	60.94
331.71	22.20	-64.65	0.73	H	2.77	-66.69	-13.00	53.69

• 16QAM / MIMO Mode

Frequency [MHz]	Reading [dBuV]	Antenna polarity [H/V]	Antenna gain [dBi]	Cable loss [dB]	Level [dBuV]	Level [dBm]	Limit [dBuV]	Margin [dB]
49.77	26.30	-65.49	1.37	H	1.13	-65.25	-13.00	52.25
141.31	18.40	-76.45	1.08	H	1.97	-77.34	-13.00	64.34
244.13	14.50	-79.98	0.79	H	2.46	-81.65	-13.00	68.65
268.44	14.40	-82.15	0.63	H	2.47	-83.99	-13.00	70.99
302.29	25.10	-60.66	0.40	H	2.80	-63.06	-13.00	50.06
309.64	16.80	-71.41	0.49	V	2.90	-73.82	-13.00	60.82
331.71	22.10	-64.78	0.73	H	2.77	-66.82	-13.00	53.82

• 64QAM / MIMO Mode

Frequency [MHz]	Reading [dBuV]	Antenna polarity [H/V]	Antenna gain [dBi]	Cable loss [dB]	Level [dBuV]	Level [dBm]	Limit [dBuV]	Margin [dB]
49.78	26.10	-65.68	1.37	H	1.13	-65.44	-13.00	52.44
141.32	18.50	-78.47	1.08	H	1.97	-79.36	-13.00	66.36
244.12	14.40	-81.46	0.79	H	2.46	-83.13	-13.00	70.13
268.45	14.60	-81.79	0.63	H	2.47	-83.63	-13.00	70.63
302.28	24.90	-60.51	0.40	H	2.80	-62.91	-13.00	49.91
309.63	16.80	-71.62	0.49	V	2.90	-74.03	-13.00	61.03
331.76	22.30	-64.58	0.73	H	2.77	-66.62	-13.00	53.62

3.6 Frequency stability

3.6.1 Specification

- FCC Rules Part 2.1055
- FCC Rules Part 27.54

3.6.2 Test Description

A direct connect measurement was made between the EUT antenna cable and a spectrum analyzer. The spectrum analyzer is equipped with a precision frequency reference that exceeds the stability requirement of the EUT.

Measurements were made at the edges of the main transmit bands as called out on the data sheets. Testing was done with an absence of modulation in a CW mode of operation.

The primary supply voltage was varied from 85 % to 115 % of the nominal voltage using a temperature chamber, the transmit frequency was recorded at the extremes of the specified temperature (-30 °C to +50 °C)

3.6.3 Test Procedure

The EUT was set up to the applicable test frequency with modulation. The EUT antenna terminal was conducted to the spectrum analyzer through an external attenuator (at the output test) and an appropriate coaxial cable.

The MAKER function was using for these evaluation.

3.6.4 Test equipment list

Equipment	Model Name	Manufacturer
EUT	HX-WCS-MIMO	Corning Optical Communications Wireless Inc.
MHU	HX-WCS-MHU	Corning Optical Communications Wireless Inc.
Signal Generator	N5182A	Agilent
Spectrum Analyzer	N9020A	Agilent
Attenuator	PE7019-20	Pasternack
DC power supply	6674A	Agilent
Temp. / Humid. Chamber	SJ-1016-TH	Seo Jin

3.6.5 Test condition

- Test place: Temperature and Humidity Chamber
- Test environment: 30 °C to +50 °C

3.6.6 Test result

• Port1 / LTE 10 MHz / 2 355.0 MHz

Voltage [%]	Supplied power [Vdc]	Temperature [°C]	Frequency [MHz]	Deviation [ppm]	Limit [ppm]
85	40.8	-30	2 355.0	-0.007 400	1.50
		-20		0.016 200	
		-10		0.002 000	
		0		0.014 600	
		+10		0.008 500	
		+20 (ref.)		0.013 000	
		+30		0.003 300	
		+40		0.020 100	
		+50		0.002 000	
100	48.0	-30	2 355.0	0.001 700	1.50
		-20		0.004 400	
		-10		0.000 100	
		0		-0.000 500	
		+10		0.005 100	
		+20 (ref.)		-0.016 200	
		+30		0.011 300	
		+40		0.000 300	
		+50		-0.005 100	
115	55.2	-30	2 355.0	-0.005 200	1.50
		-20		-0.000 200	
		-10		0.011 400	
		0		-0.007 300	
		+10		-0.025 300	
		+20 (ref.)		0.019 299	
		+30		0.000 300	
		+40		-0.005 100	
		+50		-0.005 200	

• Port1 / LTE 5 MHz / 2 352.5 MHz

Voltage [%]	Supplied power [Vdc]	Temperature [°C]	Frequency [MHz]	Deviation [ppm]	Limit [ppm]
85	40.8	-30	2 352.5	0.012 499	1.50
		-20		0.007 500	
		-10		-0.000 299	
		0		0.005 599	
		+10		-0.003 900	
		+20 (ref.)		-0.008 999	
		+30		0.004 000	
		+40		0.001 599	
		+50		-0.007 900	
100	48.0	-30		-0.006 000	
		-20		-0.007 500	
		-10		0.015 900	
		0		-0.009 500	
		+10		0.002 500	
		+20 (ref.)		-0.000 400	
		+30		-0.007 800	
		+40		0.013 599	
		+50		0.028 299	
115	55.2	-30		-0.013 000	
		-20		0.000 199	
		-10		0.002 999	
		0		0.003 600	
		+10		0.014 299	
		+20 (ref.)		0.008 299	
		+30		-0.016 200	
		+40		0.008 699	
		+50		-0.002 699	

• Port1 / LTE 5 MHz / 2 357.5 MHz

Voltage [%]	Supplied power [Vdc]	Temperature [°C]	Frequency [MHz]	Deviation [ppm]	Limit [ppm]
85	40.8	-30	2 357.5	-0.003 600	1.50
		-20		-0.004 899	
		-10		-0.000 899	
		0		0.005 400	
		+10		0.011 799	
		+20 (ref.)		-0.000 199	
		+30		-0.000 500	
		+40		0.029 699	
		+50		0.011 000	
100	48.0	-30		-0.010 900	
		-20		0.038 400	
		-10		-0.008 100	
		0		0.015 799	
		+10		-0.011 700	
		+20 (ref.)		-0.013 500	
		+30		-0.014 100	
		+40		0.001 399	
		+50		-0.004 799	
115	55.2	-30		-0.007 299	
		-20		0.010 900	
		-10		-0.003 200	
		0		-0.030200	
		+10		0.014 400	
		+20 (ref.)		0.004 300	
		+30		0.016 799	
		+40		-0.006 499	
		+50		0.009 699	

• Port2 / LTE 10 MHz / 2 355.0 MHz

Voltage [%]	Supplied power [Vdc]	Temperature [°C]	Frequency [MHz]	Deviation [ppm]	Limit [ppm]
85	40.8	-30	2 355.0	0.011 700	1.50
		-20		-0.009 600	
		-10		0.023 000	
		0		0.001 600	
		+10		-0.006 200	
		+20 (ref.)		0.013 100	
		+30		-0.026 800	
		+40		-0.054 900	
		+50		0.002 200	
100	48.0	-30		-0.075 600	
		-20		-0.071 400	
		-10		-0.064 500	
		0		0.013 800	
		+10		0.011 700	
		+20 (ref.)		0.021 399	
		+30		0.005 700	
		+40		-0.018 300	
		+50		-0.040 900	
115	55.2	-30		-0.008 100	
		-20		-0.006 700	
		-10		-0.004 100	
		0		0.018 300	
		+10		0.005 300	
		+20 (ref.)		-0.008 900	
		+30		0.005 100	
		+40		0.013 400	
		+50		-0.005 700	

• Port2 / LTE 5 MHz / 2 352.5 MHz

Voltage [%]	Supplied power [Vdc]	Temperature [°C]	Frequency [MHz]	Deviation [ppm]	Limit [ppm]
85	40.8	-30	2 352.5	-0.024 799	1.50
		-20		-0.000 400	
		-10		0.014 900	
		0		0.001 200	
		+10		0.009 799	
		+20 (ref.)		-0.011 700	
		+30		-0.009 300	
		+40		0.000 800	
		+50		0.005 099	
100	48.0	-30		0.012 899	
		-20		0.000 299	
		-10		-0.033 800	
		0		0.019 999	
		+10		0.013 999	
		+20 (ref.)		-0.004 600	
		+30		-0.001 999	
		+40		-0.023 399	
		+50		-0.008 900	
115	55.2	-30		0.013 400	
		-20		0.011 700	
		-10		-0.021 900	
		0		-0.000 500	
		+10		-0.003 600	
		+20 (ref.)		0.001 500	
		+30		-0.001 999	
		+40		0.007 100	
		+50		0.009 300	

• Port1 / LTE 5 MHz / 2 357.5 MHz

Voltage [%]	Supplied power [Vdc]	Temperature [°C]	Frequency [MHz]	Deviation [ppm]	Limit [ppm]
85	40.8	-30	2 357.5	0.000 699	1.50
		-20		0.018 400	
		-10		-0.006 999	
		0		0.017 799	
		+10		0.001 200	
		+20 (ref.)		0.014 100	
		+30		-0.032 000	
		+40		-0.017 000	
		+50		0.005 499	
100	48.0	-30		-0.010 399	
		-20		-0.000 100	
		-10		0.011 099	
		0		-0.003 799	
		+10		-0.010 900	
		+20 (ref.)		-0.016 399	
		+30		0.013 899	
		+40		-0.009 900	
		+50		0.000 000	
115	55.2	-30		0.014999	
		-20		-0.001 299	
		-10		0.008 699	
		0		0.022 600	
		+10		-0.014 800	
		+20 (ref.)		0.027 100	
		+30		0.001 299	
		+40		0.007 500	
		+50		0.023 900	

3.6.7 Test Plots

- Port1 / LTE 10 MHz / 2 355 MHz / 85 % of nominal voltage

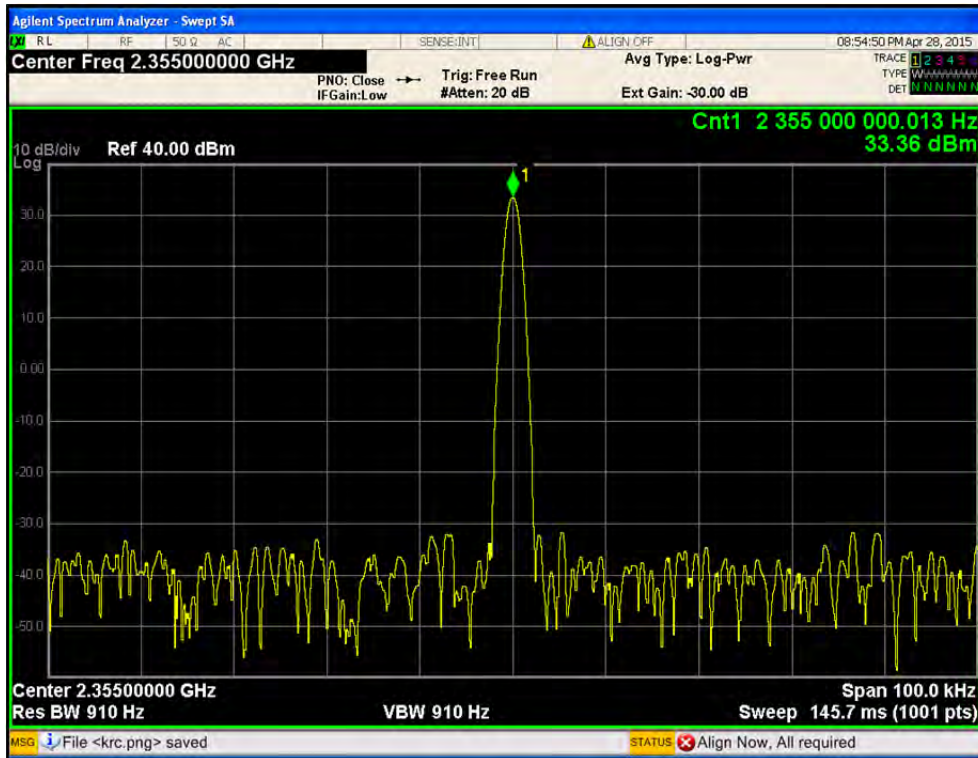

- Port1 / LTE 10 MHz / 2 355 MHz / 100 % of nominal voltage

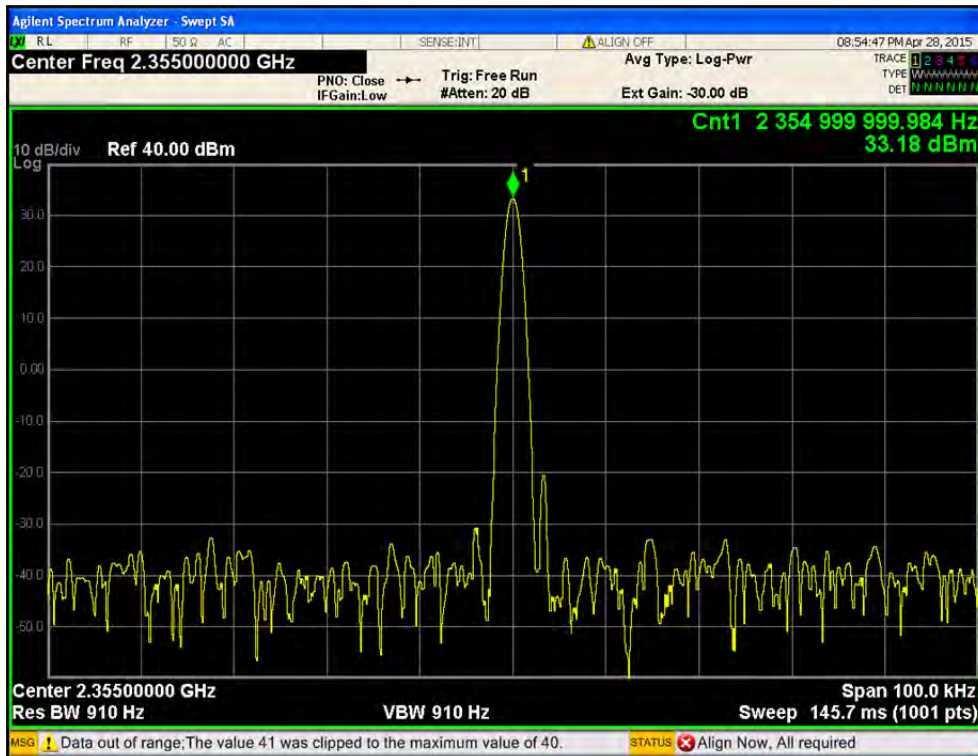

- Port1 / LTE 10 MHz / 2 355 MHz / 115 % of nominal voltage

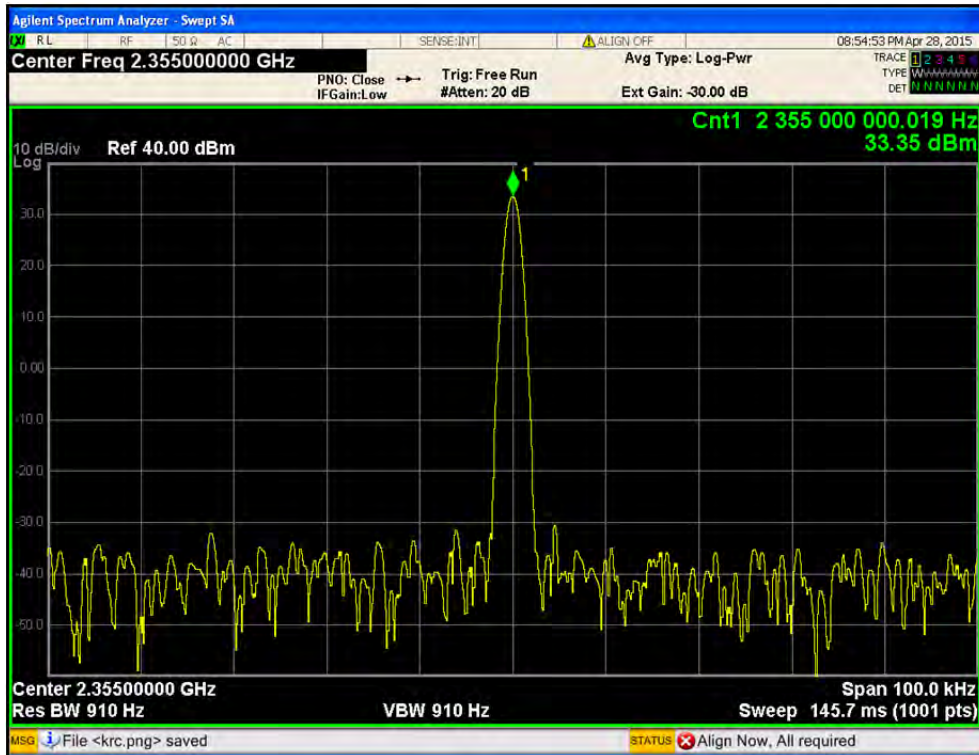

- Port1 / LTE 5 MHz / 2 352.5 MHz / 85 % of nominal voltage

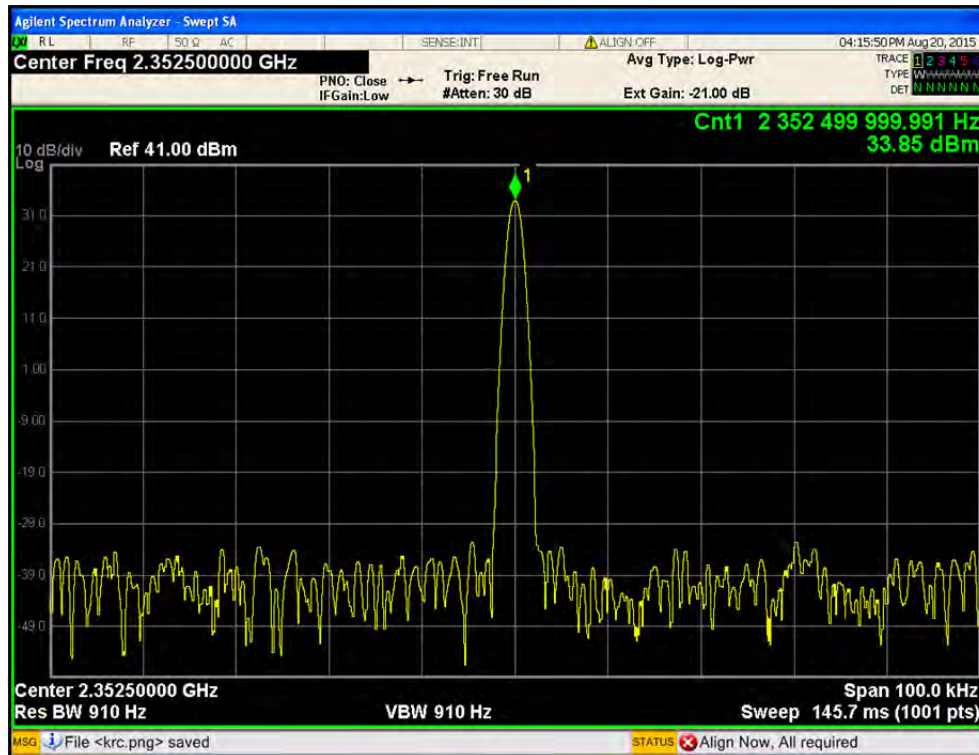

- Port1 / LTE 5 MHz / 2 352.5 MHz / 100 % of nominal voltage

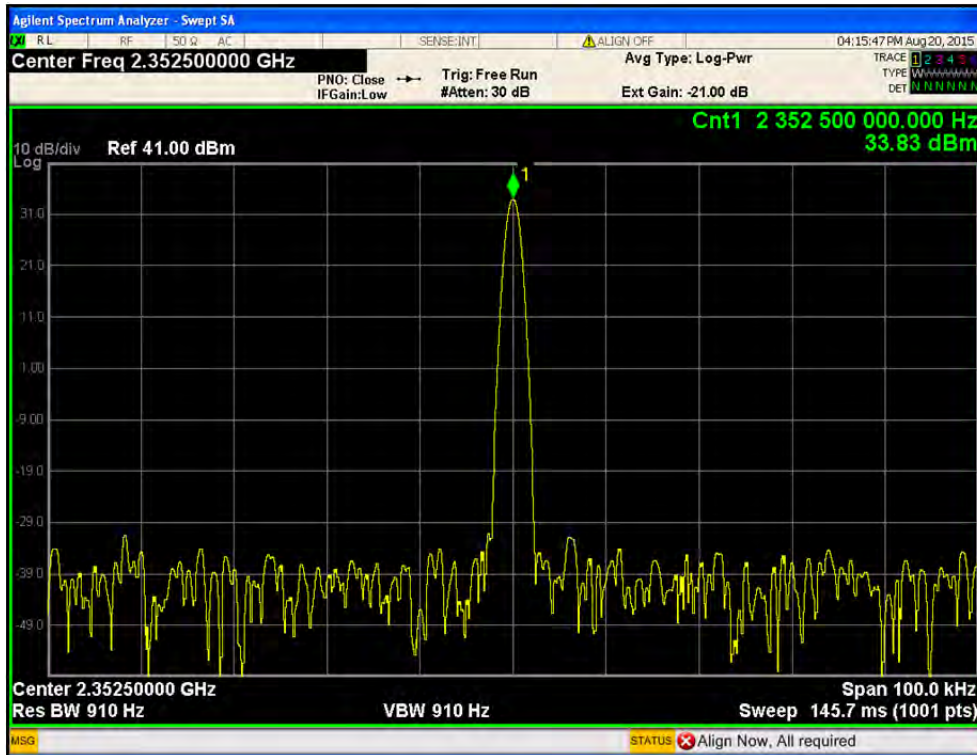

- Port1 / LTE 5 MHz / 2 352.5 MHz / 115 % of nominal voltage

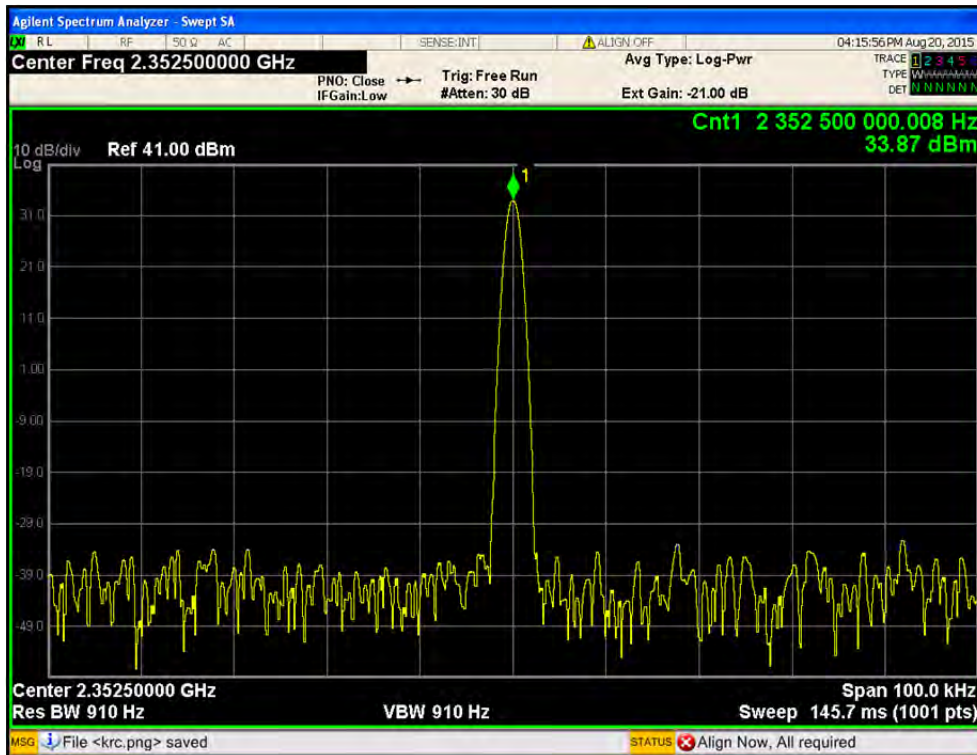

- Port1 / LTE 5 MHz / 2 357.5 MHz / 85 % of nominal voltage

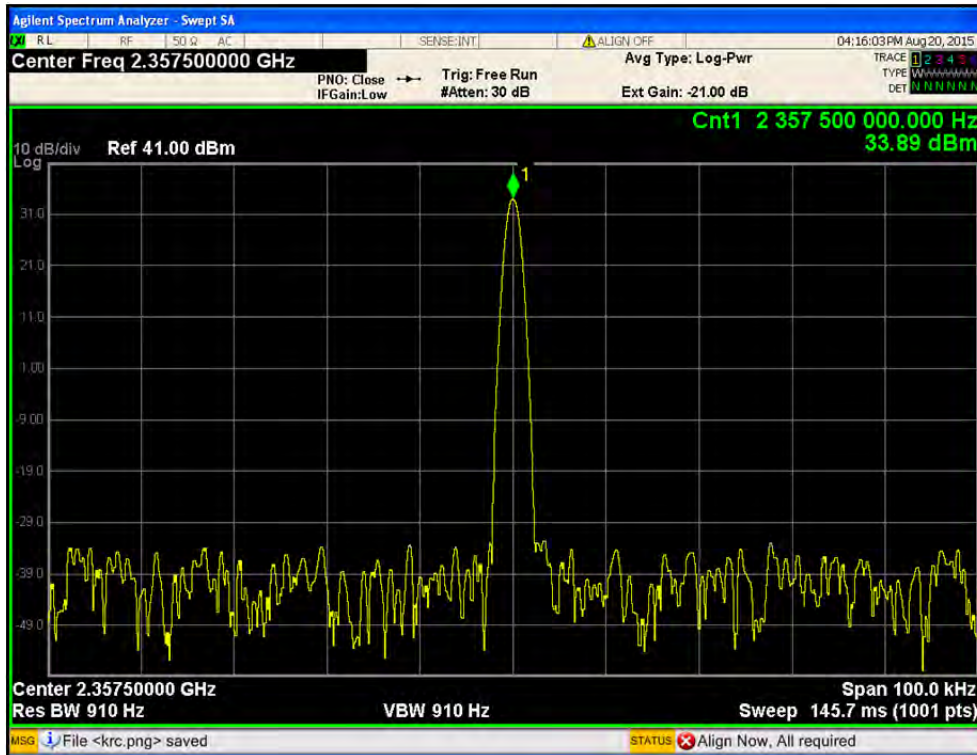

- Port1 / LTE 5 MHz / 2 357.5 MHz / 100 % of nominal voltage

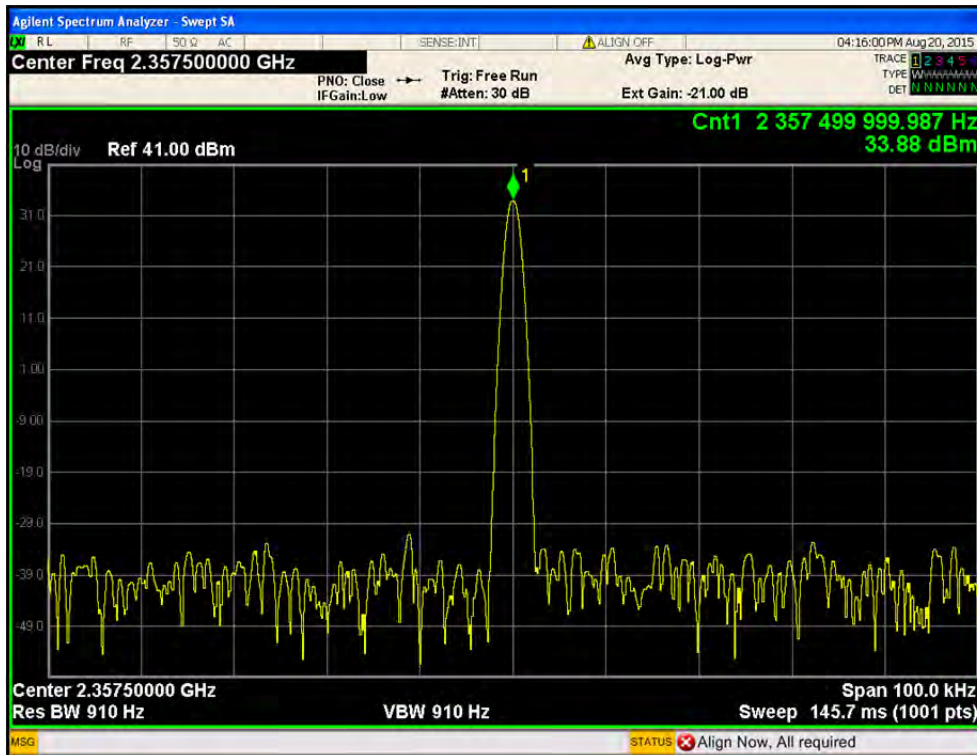

- Port1 / LTE 5 MHz / 2 357.5 MHz / 115 % of nominal voltage

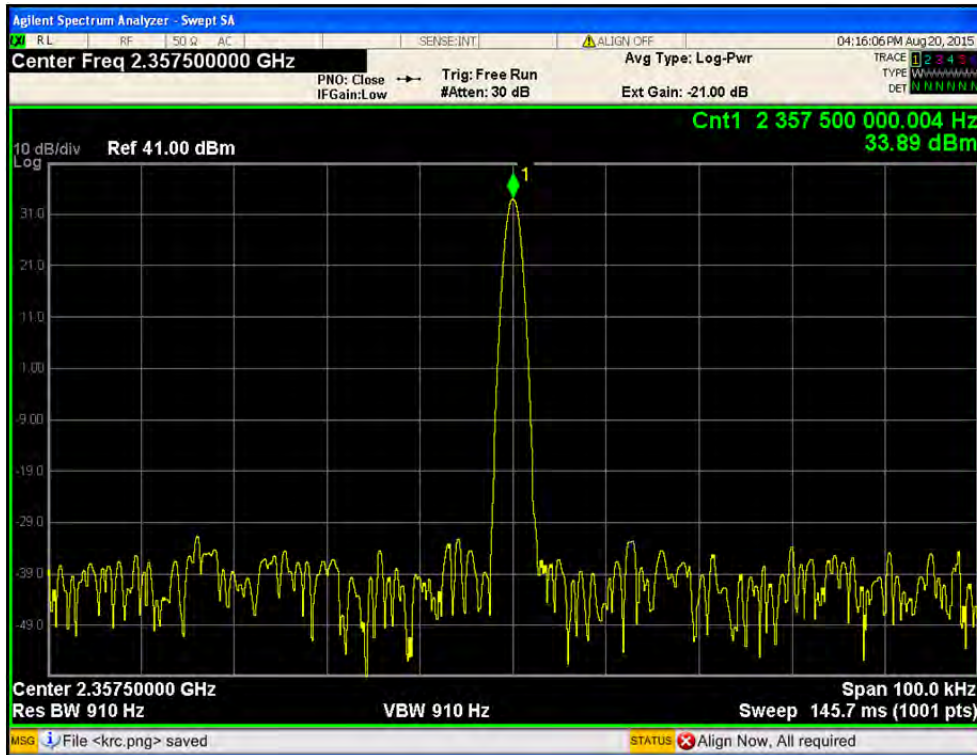

- Port2 / LTE 10 MHz / 2 355 MHz / 85 % of nominal voltage

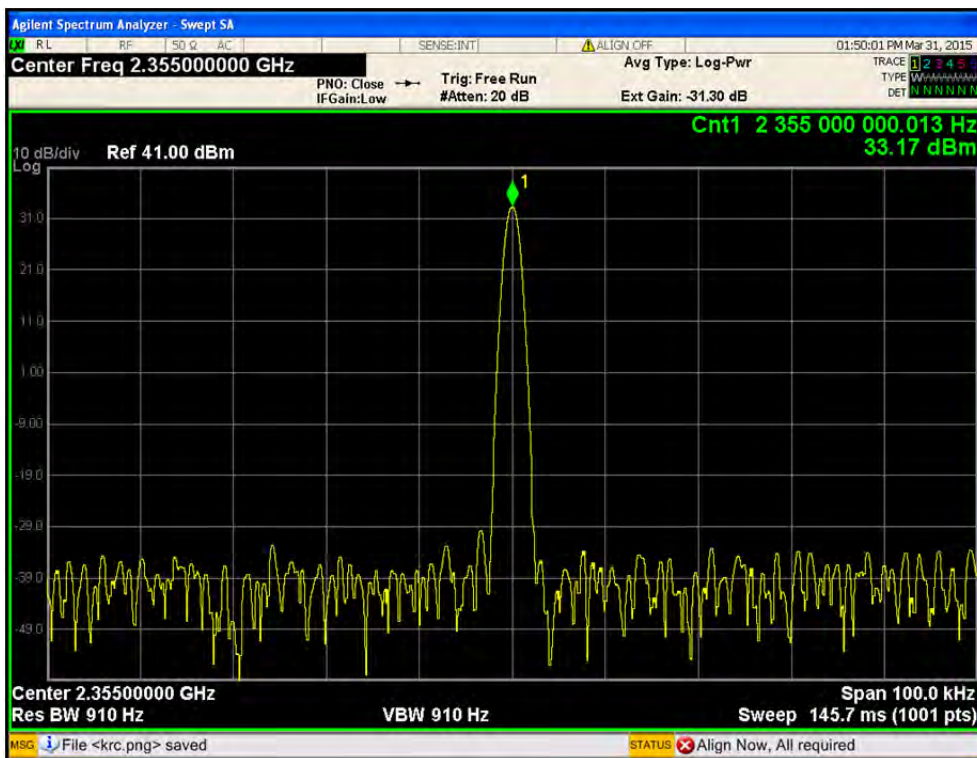

- Port2 / LTE 10 MHz / 2 355 MHz / 100 % of nominal voltage

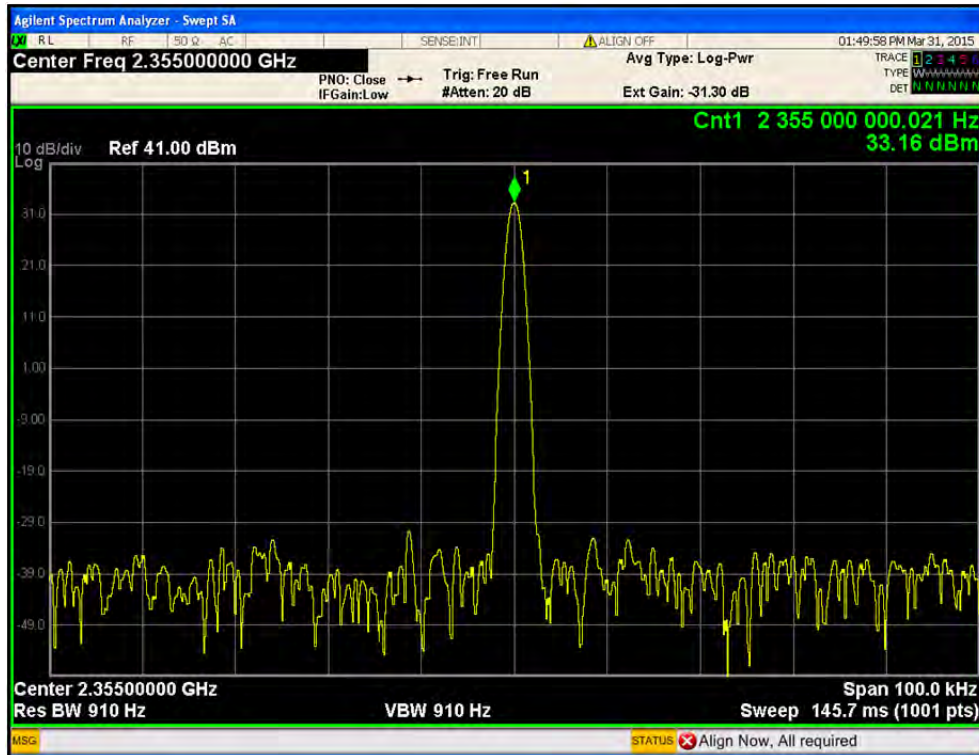

- Port2 / LTE 10 MHz / 2 355 MHz / 115 % of nominal voltage

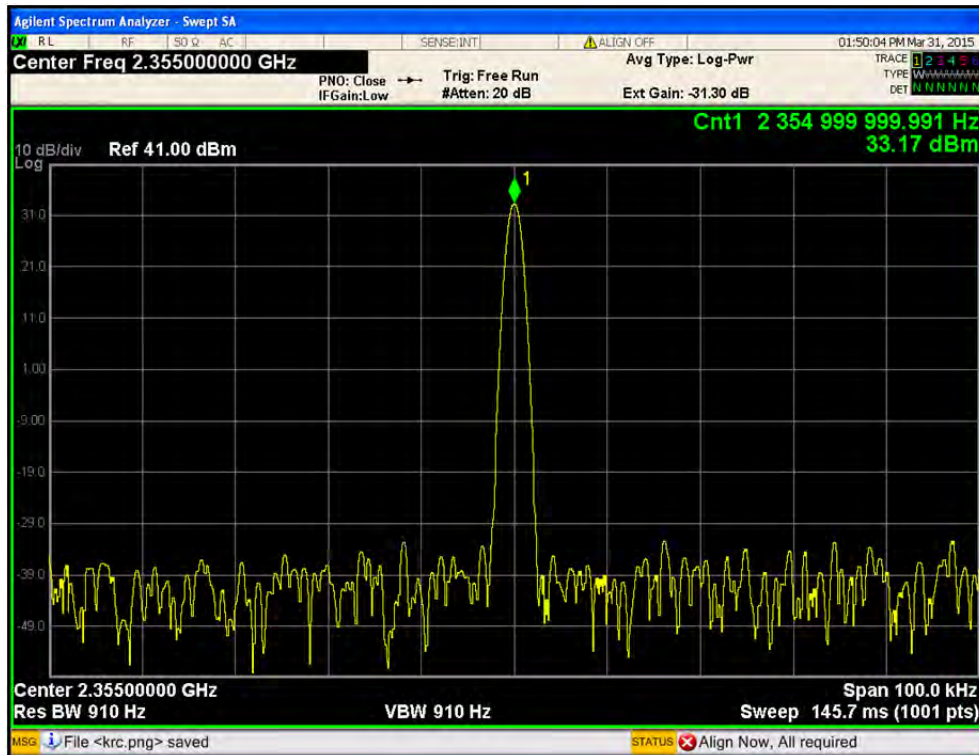

- Port2 / LTE 5 MHz / 2 352.5 MHz / 85 % of nominal voltage

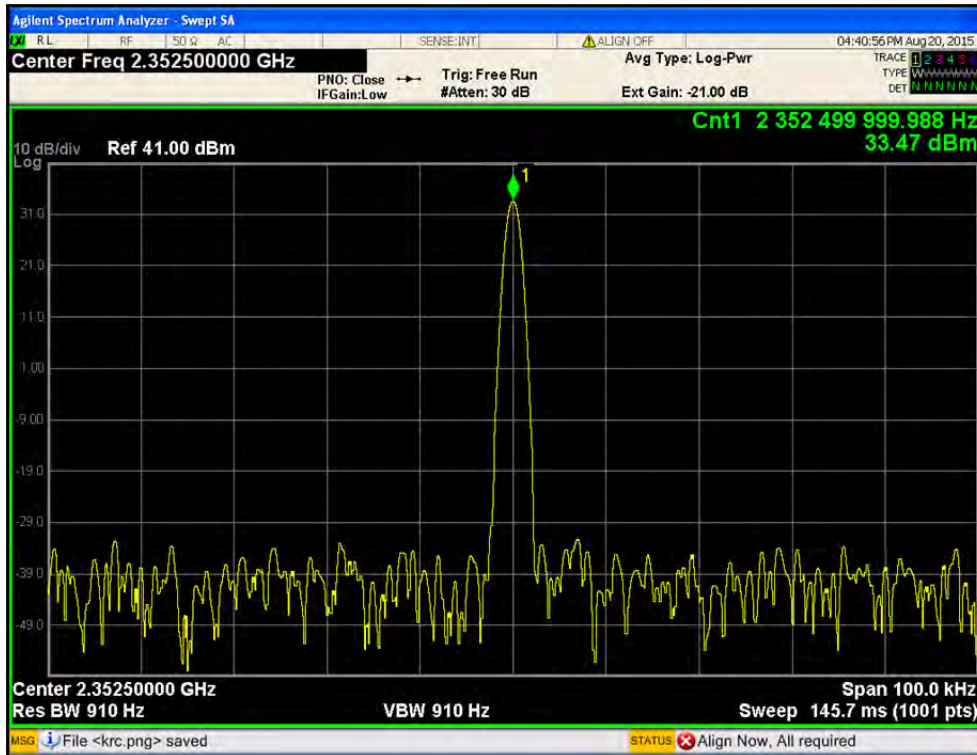

- Port2 / LTE 5 MHz / 2 352.5 MHz / 100 % of nominal voltage

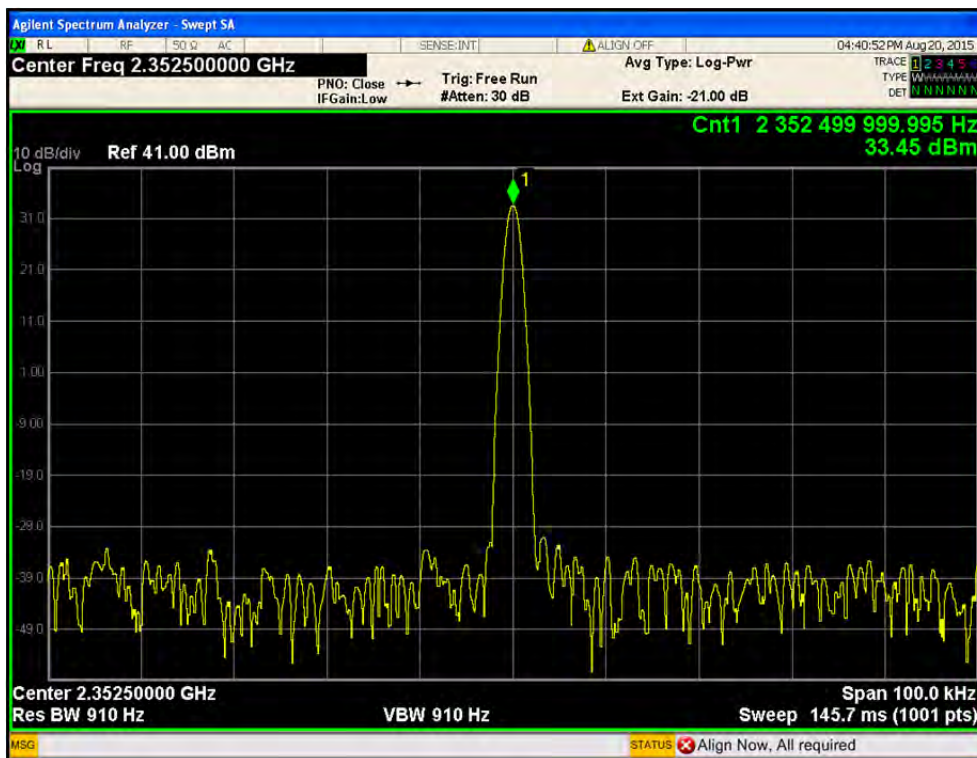

- Port2 / LTE 5 MHz / 2 352.5 MHz / 115 % of nominal voltage

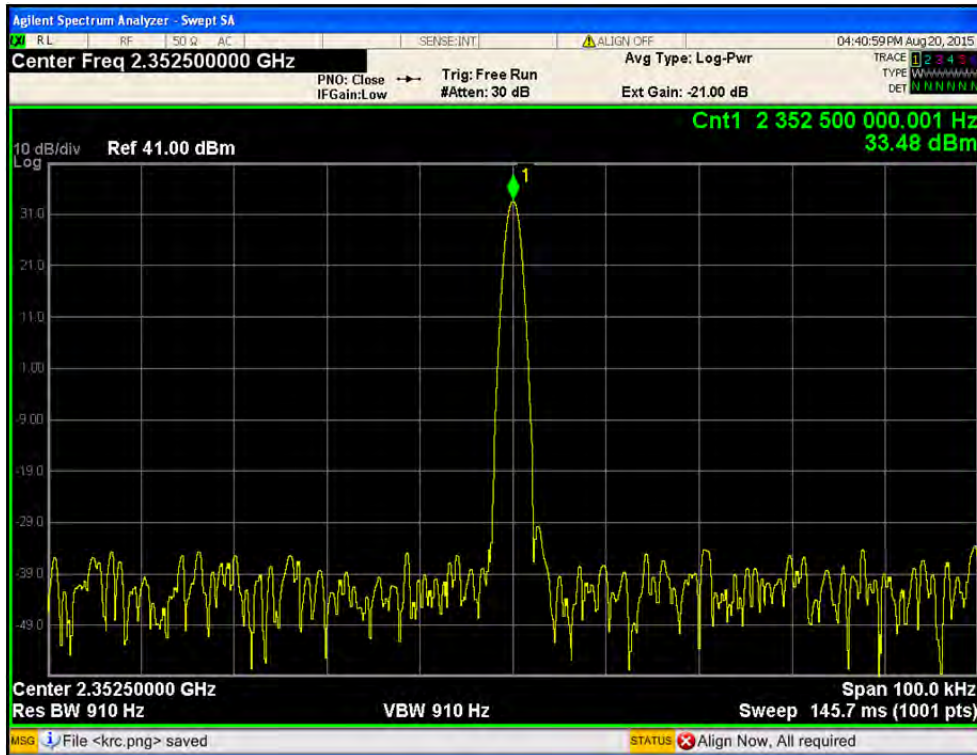

- Port2 / LTE 5 MHz / 2 357.5 MHz / 85 % of nominal voltage

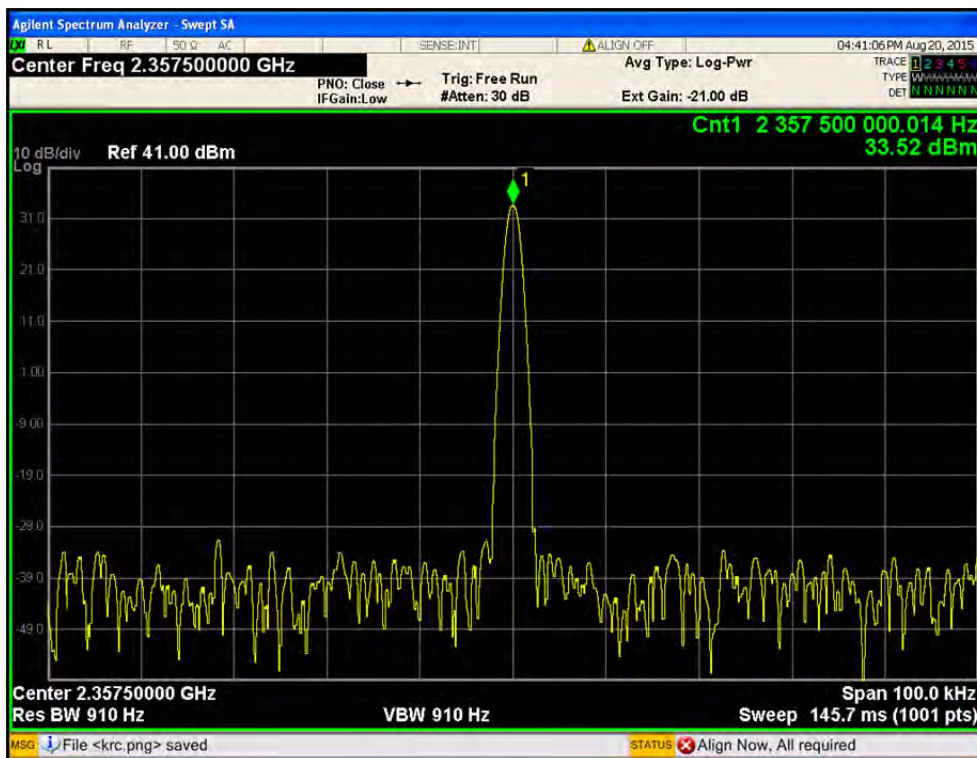

- Port2 / LTE 5 MHz / 2 357.5 MHz / 100 % of nominal voltage

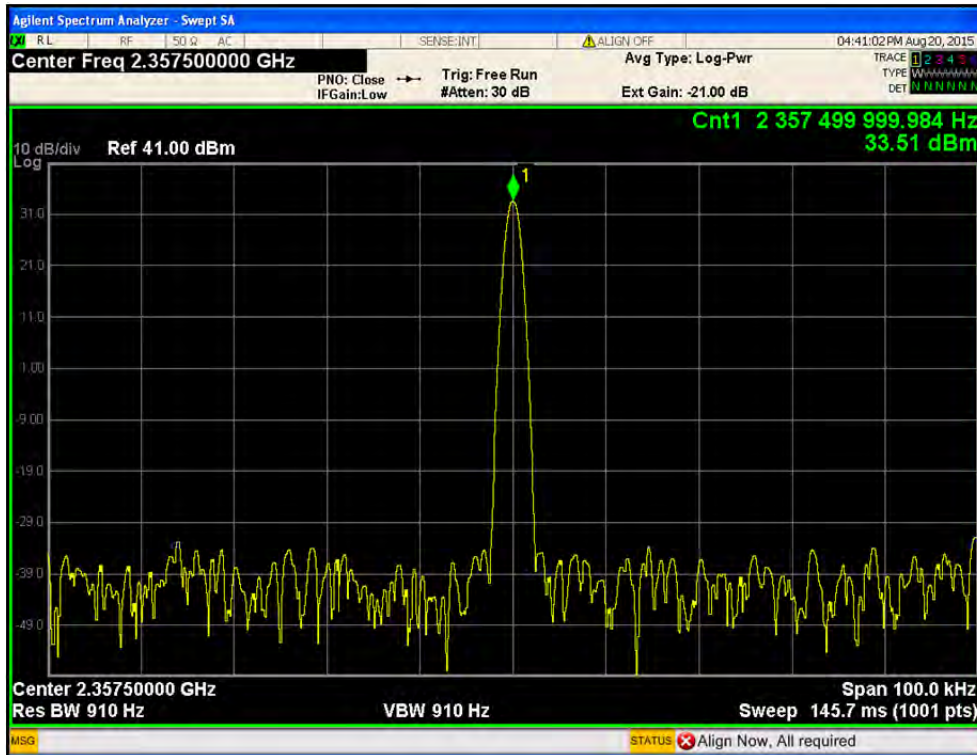

- Port2 / LTE 5 MHz / 2 357.5 MHz / 115 % of nominal voltage

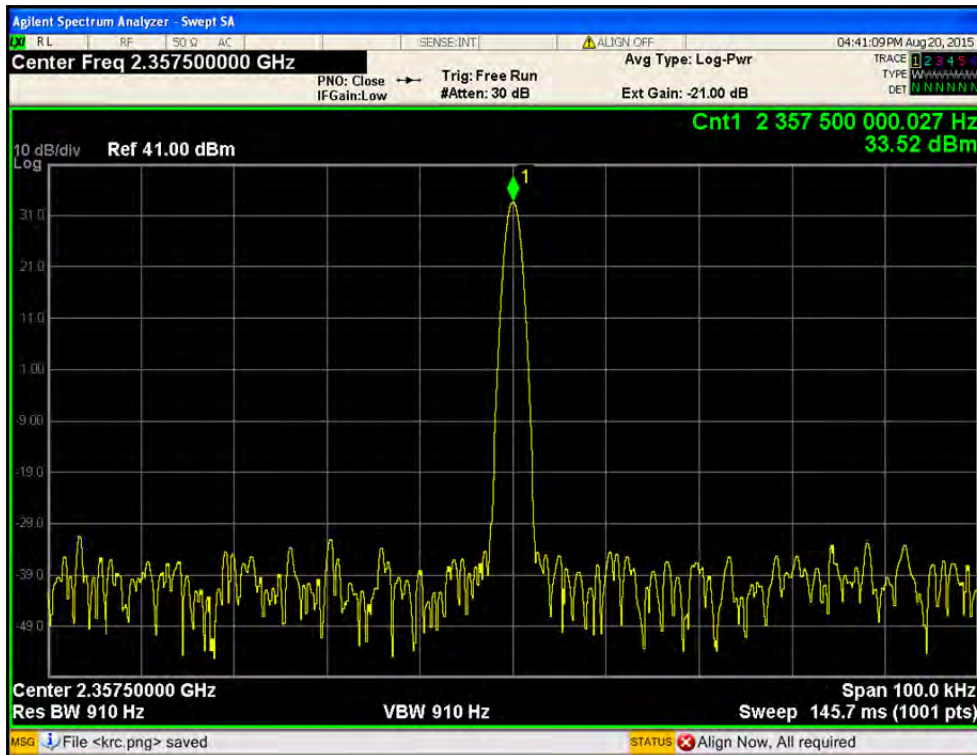

3.7 Out of band rejection

3.7.1 Specification

- KDB935210 D02 V03

3.7.2 Test Description

The method used is as detailed in FCC KDB 935210 D03 V03

A direct connect measurement was made between the EUT antenna cable and a spectrum

Testing was done with an absence of modulation in a sweep CW mode of operation.

3.7.3 Test Procedure

The EUT was set up to the applicable test frequency. The EUT antenna terminal was conducted to the spectrum analyzer through an external attenuator (at the output test) and an appropriate coaxial cable.

The MAKER function and Trace MAX HOLD was using for these evaluation.

3.7.4 Test equipment list

Equipment	Model Name	Manufacturer
EUT	HX-WCS-MIMO	Corning Optical Communications Wireless Inc.
MHU	HX-WCS-MHU	Corning Optical Communications Wireless Inc.
Signal Generator	N5182A	Agilent
Spectrum Analyzer	N9020A	Agilent
Attenuator	PE7019-20	Pasternack
DC power supply	6674A	Agilent
Divider	1580-1	Weinschel

3.7.5 Test condition

- Test place: Temperature and Humidity Chamber
- Test environment: 30°C to +50°C

3.7.6 Test Plots

- Port1

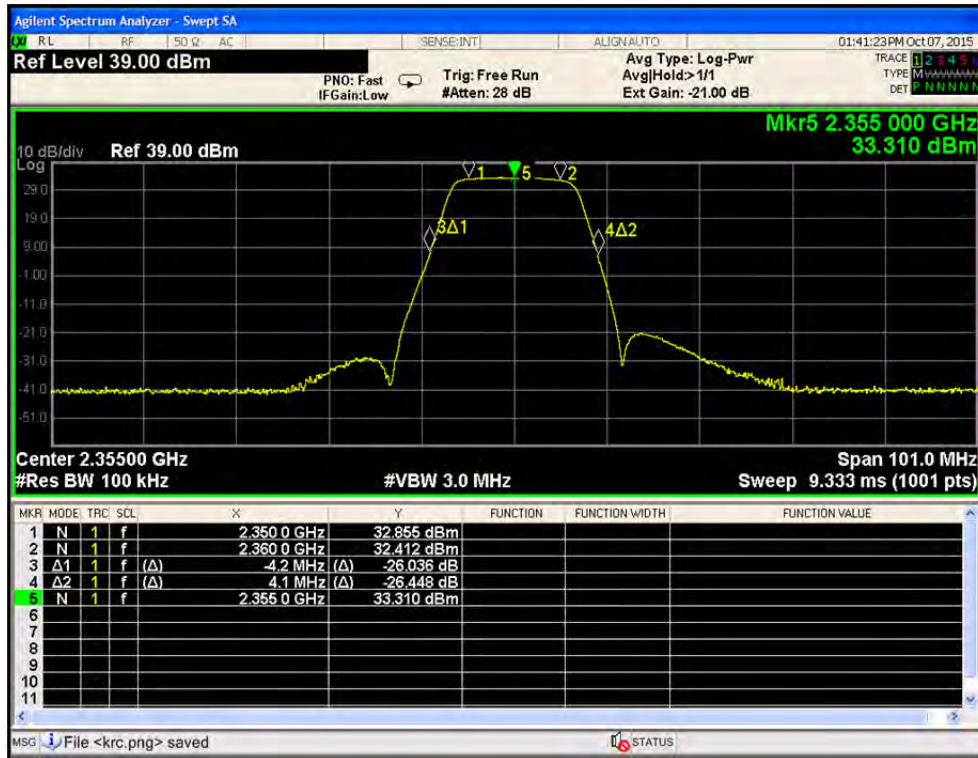

- Port2

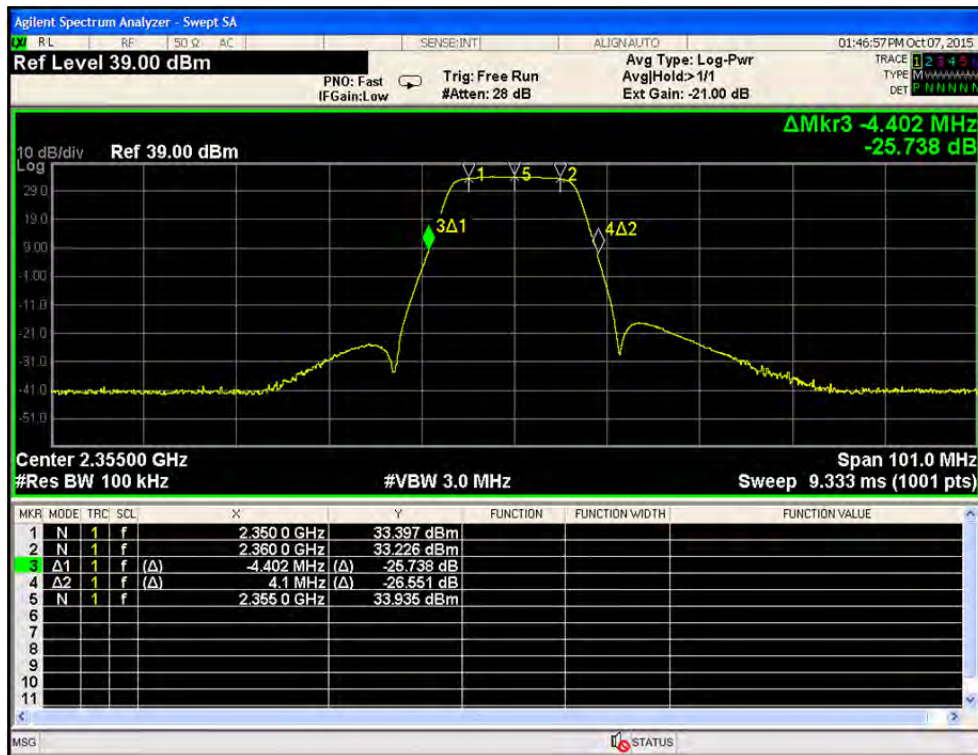

4. RF exposure statement

According to FCC Part1 Section 1.1307~1.1310, systems operating under the provisions of this section shall be operated in a manner that ensures that the public is not exposed to radio frequency energy level in excess of the Commission's guidelines.

Frequency Range [MHz]	Electric Field Strength [V/m]	Magnetic Field Strength [A/m]	Power Density [mW/cm ²]	Averaging Time [minute]
Limits for General Population/Uncontrolled Exposure				
0.3 – 1.34	614	1.63	100	30
1.34 – 30	824/f	2.19/f	180/f ²	30
30 – 300	27.5	0.073	0.2	30
300 – 1500	-	-	f/1500	30
1500 – 100 000	-	-	1.0	30

Limits for General Population/Uncontrolled Exposure

Here, f = frequency in MHz

4.1 Friis transmission formula

$$P_d = (P_{out} \times G) / (4\pi r^2)$$

P_d = Power density

P_{out} = power input to antenna

G = power gain

r = distance to the center of radiation of the antenna

4.2 Information of Antenna

- Service antenna model name: D5777i / Galtronics Corporation Ltd.

Electrical Specification		
Frequency Range	2360 MHz ~ 2700 MHz	
Polarization	Dual slant 45°	
Band Width	910 MHz	
Gain	≥ 15 dBi	
Beam width	Horizontal	27°
	Vertical	27°
VSWR	≤ 1.7:1	
Impedance	50 Ω	
IMD (3 rd)	-150dBc (@ 2x43dBm)	
Maximum input power	250 W	

Mechanical Specification	
Operating Temperature	-40° ~ +70°
Weight	~10 kg
Length	787 mm
Width	627 mm
Height	145 mm
RoHS	compliant
Ingress Protection	IP65(Outdoor)
Radome Color	White
Wind Survival Rating	241 km/h



4.3 Calculation of MPE at 115 cm

Port	WCS Block	Frequency [MHz]	Output power [dBm]	Antenna gain [dBi]	EIRP		Power density [mW/cm ²]	Limit [mW/cm ²]
					[dBm]	[W]		
1	A+B	2 355.0	33.10	15.00	48.10	64.56	0.388 700	1
			32.98	15.00	47.98	62.80	0.378 107	
			33.06	15.00	48.06	63.97	0.385 136	
	A	2 352.5	32.97	15.00	47.97	62.66	0.377 237	
			33.03	15.00	48.03	63.53	0.382 485	
			33.20	15.00	48.20	66.06	0.397 754	
	B	2 357.5	33.04	15.00	48.04	63.67	0.383 367	
			32.96	15.00	47.96	62.51	0.376 639	
			33.26	15.00	48.26	66.98	0.403 287	
2	A+B	2 355.0	33.12	15.00	48.12	64.86	0.390 494	1
			32.97	15.00	47.97	62.66	0.377 237	
			33.01	15.00	48.01	63.24	0.380 727	
	A	2 352.5	33.08	15.00	48.08	64.26	0.386 914	
			33.05	15.00	48.05	63.82	0.384 250	
			32.96	15.00	47.96	62.51	0.376 639	
	B	2 357.5	33.09	15.00	48.09	64.41	0.387 806	
			33.06	15.00	48.06	63.97	0.385 136	
			33.03	15.00	48.03	63.53	0.382 485	
1+2 (MIMO)	A+B	2 355.0	36.10	15.00	51.10	128.82	0.775 558	1
	A	2 352.5	36.20	15.00	51.20	131.82	0.793 623	
	B	2 357.5	36.26	15.00	51.26	133.65	0.804 664	

5. Test equipment list

The listing below denotes the test equipment for the test(s).

No.	Equipment	Model	Manufacturer	Serial Number	Calibration Due date
1	Spectrum analyzer	N9020A	Agilent	MY48010456	2016.01.20
2	Spectrum analyzer	FSP	R&S	10060	2016.08.28
3	Signal generator	N5182A	Agilent	MY49060695	2016.01.19
4	Attenuator	AF115A-09-34	Weinschel	18405	2016.01.20
5	Attenuator	PE7019-20	PASTERNAK	TEMP_4	2015.08.21
6	Biconical antenna	VHA9103	Schwarzbeck	2217	2015.11.15
7	Log-Periodic antenna	VULP9118A	Schwarzbeck	382	2015.11.15
8	Horn antenna	BBHA-9120D	Schwarzbeck	395	2016.08.06
9	Horn antenna	FR6517	Orbit Technology	0511106	2016.08.07
10	EMI Test Receiver	ESS	R&S	833776/011	2016.08.26
11	Preamp	8449B	Agilent	3008A02013	2016.04.16
12	RF Amplifier	SCU01	R&S	10020	2016.08.26
13	Turn table	DS 1500 S-1t-O	Innco GmbH	N/A	N/A
14	Turn table	ALL1.5TT	AIRLINK LAB	N/A	N/A
15	Antenna mast	MA4000-O	Innco GmbH	N/A	N/A
16	Antenna mast	ALL2.2MA	AIRLINK LAB	N/A	N/A
17	Controller	CO 2000	Innco GmbH	N/A	N/A
18	Controller	ALL-TC-V1.0	AIRLINK LAB	N/A	N/A
19	DC power supply	6674A	Agilent	3537A01582	2016.01.19
20	Divider	1503	Weinschel	QS033	2016.01.28