

TEST REPORT

Report number		RAPA15-O-035
Applicant	Name	Corning Optical Communications Wireless Inc.
	Logo	CORNING
	Address	13221 Woodland Park Rd, Suite 400 Herndon, Virginia 20171 USA
Manufacturer	Name	Corning Optical Communications Wireless Inc.
	Address	13221 Woodland Park Rd, Suite 400 Herndon, Virginia 20171 USA
Type of equipment		Optical Repeater
Basic model name		HX-WCS-MIMO
Multi model name		N/A
Serial number		N/A
FCC ID		OJFHX-WCS-MIMO
Test duration		June 19, 2015 to October 12, 2015
Date of issue		November 11, 2015
Total page		221 pages (including this page)

SUMMARY

The equipment complies with the requirements of FCC CFR 47 Part 27 Subpart C.

This test report only contains the result of a single test of the sample supplied for the examination. It is not a general valid assessment of the features of the respective products of the mass-production.

November 11, 2015



Tested by Hyun Soo Lee
Manager

November 11, 2015



Reviewed by Sukil Park
Executive Managing Director

Test Report Version History

Version	Date	Revised by	Reason for revision
1.0	September 16, 2015	Hyun Soo Lee	Original Document
2.0	October 01, 2015	Hyun Soo Lee	Revision - Measurement Uncertain - Test procedure
3.0	October 07, 2015	Hyun Soo Lee	Measurement data insertion and revision - PAPR - Out of band rejection - Spurious emission
4.0	October 12, 2015	Hyun Soo Lee	Update measurement and test plots - Output power test procedure - Spurious emission
5.0	November 11, 2015	Hyun Soo Lee	Test result plots revision -page 16 , 32 ,33 34

CONTENTS

1. General description of EUT	4
1.1 Applicant.....	4
1.2 Manufacturer	4
1.3 Basic description of EUT.....	4
1.4 Alternative type(s)/model(s)	4
1.5 Electrical specification.....	5
2. General information of test	11
2.1 Test standards and results	11
2.2 Description of EUT modification.....	11
2.3 Test configuration	11
2.4 Test setup.....	12
2.5 Measurement Uncertainty	12
3. Measurement data	13
3.1 Occupied Bandwidth / 26 dB Emission Bandwidth	13
3.2 Band Edge	24
3.3 Conducted spurious emission	35
3.4 Transmitter Conducted Output power	181
3.5 Radiated spurious emission.....	196
3.6 Frequency stability	200
3.7 Out of band rejection.....	216
4. RF exposure statement	218
4.1 Friis transmission formula	218
4.2 Information of Antenna.....	219
4.3 Calculation of MPE at 115 cm.....	220
5. Test equipment list	221

1. General description of EUT

1.1 Applicant

- Company name : Corning Optical Communications Wireless Inc.
- Address : 13221 Woodland Park Rd, Suite 400 Herndon, Virginia 20171 USA
- Contact person : Habib Riazi / Product Manager
- Phone/Fax : 541-758-2880

1.2 Manufacturer

- Company name : Corning Optical Communications Wireless Inc.
- Address : 13221 Woodland Park Rd, Suite 400 Herndon, Virginia 20171 USA
- Phone/Fax : 541-758-2880

1.3 Basic description of EUT

- Product name : Optical Repeater
- Basic model name : HX-WCS-MIMO
- Alternative model name : N/A
- Output power : Downlink: +33 dBm(2 W)

Max. composite output power based on one carrier per path	+33 dBm (2 W)
MIMO max. composite output power based on one carrier per path	+36 dBm (3.98 W)

- Frequency Range : 2 350 MHz ~ 2 360 MHz
- Emission Designators : LTE(G7D,W7D)
- FCC Rule Part(s) : FCC CFR47 Part 2 and FCC CFR47 Part 27 Subpart C
- Place of test : Head office
#101 & B104 Anyang Megavalley, 268, Hagui-ro, Dongan-gu, Anyang-si, Gyeonggi-do, 431-767, Korea

Open area test site
103, Anseok-gil, 138beon-gil, Hwaseong-si, Gyeonggi-Do, Korea

(FCC Registration Number: 931589)
(IC Company address code: 9355B)
(RRA Designation Number: KR0027)

1.4 Alternative type(s)/model(s)

There is no alternative type(s) and/or model(s).

1.5 Electrical specification

Item	Specification	Comment
1. General		
RF Output Port Impedance	50 ohm	
DL/UL Return loss	16 dB	Design goal 18 dB, all RF ports
DL to UL Out of band max Gain (cross-band Isolation)	Requirement: Gain max of +20 dB @ DC-2305, 2315-2350, 2360-4000 MHz Conditions: System includes BU connected to HX2300. Test the Gain from BU DL Input to BU UL Output, at max DL/UL Gain (53/41 dB). Tested frequencies: On the cross-band (on the gap between DL to UL), and outside the DL and UL bands. Tested with small signal input power (-50 dBm).	With max DL/UL Gain (54/41 dB), the total DPLX isolation should be equivalent to >75dB (54+41-20=75 dB) (manufacturing units should be tested up to 3 GHz)
Delay absolute	Signal Delay <2.0 microseconds (Excluding the Optic link delay)	
Optical Connector Type	SC/APC	
Regulatory	FCC certificated, 3GPP 36.846, 3GPP 36.106, RoHS	See regulatory chapter
2. Downlink		
Frequency Range	2350 MHz – 2360 MHz	
Nominal System Output Power	33 dBm	Linear power
Gain nominal	53 dB	With BU in RIU mode, With up to 2 km fiber (3 dBo)
Gain Max setting	55 dB	To enable 2 dB loss on BU at WCS band (margin for BU loss and manufacturing tolerance compensation)
Gain variation over temperature	+/-1 dB max	reference for gain variation is gain @ room temperature
Output power control Range	19 dBm – 34 dBm min	For commissioning
Output power control step	1 dB	
Pass Band Ripple	3 dB peak to peak Max 2 dB p-p desired	Tested with BU
DL Test Port coupling	-40 dB +/- 1.0 dB relative to DL output	
OIP3	Not specified (need to meet IMD3 requirement)	

Item	Specification	Comment
IMD3 for two modulated signals of BW 1.4 MHz, at any in-band frequency	-15 dBm/MHz max	at any composite output power 21 dBm – 33 dBm, should be met at full production units
Spurious emission	Per 3GPP 36 106, 3GPP 36 846	
LTE spectrum emission mask	Per 3GPP 36 106 (category A)	
LTE EVM	3 %, frequency error $\leq \pm 0.01$ ppm	
Group delay variation	0.250 μ sec p-p max 0.200 μ sec p-p desired	
DL detector type	Two detector type shall be used: 1. Average, 2. Peak	
DL Average detector	Shall use RMS detector and shall represent the average level (the same level measured by spectrum analyzer channel power)	The detector shall represent the average level for LTE signal for Max or Min resource block (equivalent to signal rise/fall time of 50 μ sec)
DL Peak detector	Shall use post detection peak detector following the RMS detector, and shall represent the max level (for LTE signal, this is the level equivalent to using maximum resource block allocation).	
DL detector range	At least -1 to +37 dBm	For AVG reading
DL detector step	1 dB	
DL detector calibration accuracy	1 dB With CW 1.5 dB modulated	
	The Engineering GUI shall present levels of both detectors	
	The limiter shall be based on either the Average or Peak detector. The detector to be used for the limiter, shall be selected on the engineering GUI.	The detector implementation method shall be presented and agreed by COCW SE
	The measured level of the selected detector shall be send to the management through the BU.	
3. Uplink		
Frequency Range	2305 MHz – 2315 MHz	
Maximum Gain	41 dB	HX + fiber (1m, 2km) + BU
Gain setting range	High Gain : 41 dB Normal Gain : 31 dB (default setting) Low Gain : 21 dB	HX + fiber (1m, 2km) + BU
Gain setting accuracy	± 1 dB	
Gain variation over temperature	+/- 1 dB max	reference for gain variation is gain @ room temperature

Item	Specification	Comment
NF	10 dB max at Normal gain 6 dB max at High gain 5 dB max at High gain desired	Tested with BU
Pass Band Ripple	2 dB peak to peak Max 1.5 dB p-p desired	Tested with BU
Limiter threshold	-50 dBm @ High Gain -40 dBm @ Normal Gain -30 dBm @ Low Gain	Above this level limiting starts, in order to prevent high level to BS and at BU
High level notification	10 dB above limiter threshold	Notification message shall be sent to BU
Max input Power for limiter operation	-5 dBm @ Nominal & Low Gain -15 dBm @ High Gain	@ Nominal & Low Gain
IIP3	>-10 dBm at nominal gain	For Normal gain and max input level, IMD3 should be below noise floor at BW 1.4 MHz (-103 dBm)
LTE EVM	3 %	At max UL signal level for each gain setting
Detector Sensitivity to external RF in signals	No change of detector accuracy for all external services occupied with 33 dBm per service (total power 40 dBm).	Requires high Isolation from 698 MHz-2170 MHz
UL EVM Sensitivity to external RF in signals	No change of EVM for all external services occupied with 33 dBm per service (total power 40 dBm).	Requires high Isolation from 698 MHz-2170 MHz
Interference from satellite repeater	Expected at antenna port up to 0 dBm at frequency 2324.54 MHz – 2327.96 MHz and 2336.225 MHz – 2341.285 MHz	
Detector sensitivity to interference	No change of detector accuracy and limiter operation, for satellite repeater interference of up to 0 dBm at frequency 2324.54 MHz – 2327.96 MHz and 2336.225 MHz – 2341.285 MHz.	
Detector range	at least: -5 dB below limiter threshold to -5 dBm	
4. Combiner External RF		
Frequency range	698 MHz – 2170 MHz	
Optional DL bands	728 MHz – 757 MHz , 862 MHz – 894 MHz 1930 MHz – 1995 MHz , 2110 MHz – 2155 MHz	
Optional UL bands	698 MHz – 716 MHz & 777 MHz – 787 MHz 817 MHz – 849 MHz, 1850 MHz – 1915 MHz 1710 MHz – 1755 MHz	
Loss to antenna port	0.5 dB max 0.3 dB desired	From External RF In to Antenna port
Inband ripple	0.1 dB per band	
Group delay variation	10 nsec	On any band
Leakage of 2350 – 2360 MHz signal to External RF In	-7 dBm max	40 dB isolation from WCS DL output to External RF In (towards HX4)

Item	Specification	Comment
Noise leakage to External RF In	-104 dBm/MHz max @ 698 MHz – 2170 MHz	
Rejection of 2305-2315 MHz at the External RF IN port	> 40 dB min > 50 dB desired	1. From External RF In (from HX4) to WCS UL input 2. To avoid PIM/IMD from HX4 to WCS (AWS DL (2120), PCS DL (1930) => WCS UL 2310)
5. DL optical repeater		
Optical Wavelength	1310 nm ± 10 nm	TX & RX
DL optical input level range	-10 dBm to +3 dBm (optical)	At DL optical in connector
DL expected optical input level for min fiber loss	-1 dBm ±1 dBm (optical)	At DL optical in connector
DL expected optical input level for 3 dBo fiber loss	-4 dBm ± 1 dBm (optical)	At DL optical in connector
DL Optical output level	0.5 dBm ~ 3 dBm (optical)	At DL optical out connector towards HX4, including 2 dBo optical pad
DL broadband RF signal (Post photo diode) shall be split for the WCS narrow band and for the wide band repeater		
The repeater shall include RF stage gain block followed by a Laser diode		
The repeater RF stage gain block shall include gain control circuit (DCA) to enable gain setting		
Repeater RF signal BW	698 MHz - 2170 MHz	
Repeater rejection BW	The repeater shall reject FSK signals (~400 MHz) by at least 35 dB, in order not to interfere with the FSK communication to the HX4.	
Repeater gain definition	The RF gain from 1st Photo Diode output to the HX4 (i.e. 2nd photo diode output)	Can be measured with external photo diode
Repeater gain Range	TBD to optimize HX4 performance (Optimized with optical loss 22 dB and RF Gain 24 dB - 38 dB (total 2 dB - 16 dB)	Higher gain improves HX4 NF but too high gain may decrease OIP3
Repeater Nominal Gain setting	On the commissioning process the repeater will be set for a pre-defined Nominal Gain	
Nominal Gain condition	The nominal gain shall be defined for minimum fiber optic loss (typically 10 dB total gain)	

Item	Specification	Comment												
Repeater Nominal Gain	TBD dB (Note: the repeater gain shall be compensated at the HX4 gain setting)	Shall be optimized for minimum HX4 performance degradation, Optimized with optical loss 22 dB and RF Gain 24-38 dB (total 2-16 dB)												
Repeater gain setting target	To optimized the HX4 NF and OIP3	See HX4 SysCalc model, HX4 output noise shall be < -23 dBm/MHz												
Optical RX level detection	The repeater shall detect the received DL optical level													
Optical RX level calibration	The optical RX level detector shall be calibrated on the production line for nominal RX level from BU (-1 dBm optical) with minimum fiber optic loss (minimum length).	Calibrated with BU												
Calibration accuracy	±1 dB													
optical level report	The received DL optical level shall be reported on the Engineering Gui.													
Fiber optics loss compensation	On the commissioning process, the DL repeater shall set the DL gain to compensate for the DL fiber optic loss as follow (relative to repeater Nominal Gain): <table border="1" data-bbox="523 1055 1082 1294"> <thead> <tr> <th>opt. loss[dB]</th> <th>RF Gain compensation[dB]</th> </tr> </thead> <tbody> <tr> <td>0</td> <td>0</td> </tr> <tr> <td>1</td> <td>2</td> </tr> <tr> <td>2</td> <td>4</td> </tr> <tr> <td>3</td> <td>6</td> </tr> <tr> <td>4</td> <td>8</td> </tr> </tbody> </table>	opt. loss[dB]	RF Gain compensation[dB]	0	0	1	2	2	4	3	6	4	8	
opt. loss[dB]	RF Gain compensation[dB]													
0	0													
1	2													
2	4													
3	6													
4	8													
Fiber optics loss compensation resolution	0.5 dB													
Wavelength	1310 nm ± 10 nm	TX & RX												
UL expected optical input level	2.5 dBm ~ 5 dBm													
UL Optical output level to BU	2.5 dBm ~ 5 dBm													
The UL repeater	The UL repeater shall include Photo Diode followed by RF stage gain block													
Repeater UL wideband combiner	The repeater UL output signal shall be combined with the WCS narrow band signal. The combined signal shall be delivered to the Laser Diode.													
Repeater gain control	The repeater RF stage gain block shall include gain control circuit (DCA) to enable gain setting													
Repeater RF signal BW	698 MHz - 2170 MHz													
Repeater rejection BW	The repeater shall reject FSK signals (~400 MHz) by at least 45 dB.	To prevent HX4 interfere to the HX2300 internal FSK signal												

Item	Specification	Comment
Repeater gain definition	The RF gain from the HX Laser Diode Input (or equivalent laser diode) to the input of the Laser Diode of the combined signal	Can be measured with external Laser diode
Repeater gain Range	-6 to 9 dB adjustable by Engineering GUI	
Repeater Nominal Gain setting	TBD dB to optimize HX4 performance	Higher gain improves HX4 NF but too high gain may decrease IIP3
Repeater gain setting target	To optimized the HX4 NF and OIP3	See HX4 SysCalc model
Repeater NF	Shall be design to prevent HX4 NF increase. Expected HX4 system NF shall be <10 dB (at nominal gain)	See HX4 SysCalc model
Repeater IIP3	Shall be design to prevent HX4 IIP3 reduction Expected HX4 system IIP3 shall be >-12 dBm (at nominal gain)	See HX4 SysCalc model
Optical RX level detection	The repeater shall detect the received UL optical level	
optical level report	The received UL optical level shall be reported on the Engineering GUI	
	A Low Optical Level alarm message shall be sent to the Engineering GUI	
6. UL optical repeater		
Connector type	SMA female 50 ohm	
Return loss	-14 dB max	
Frequency	300 MHz to 2700 MHz (wide band signal received on the photo diode from the BU)	
Gain from photo diode output to Ext. port output	20 dB \pm 1 dB	
NF of the gain block following the photo diode	3 dB max	In order not to degrade the DL system NF of the external unit
Ripple	3 dB p-p max from 550 to 2700 MHz 5 dB p-p max from 300 to 2700 MHz	
OIP3	TBD	
Connector type	SMA female 50 ohm	
Return loss	-14 dB max	
Frequency	300 MHz to 2700 MHz (wide band signal received on the photo diode from the BU)	To enable combining of UL narrow band signal at any band
Gain from Ext. port input to Laser photo diode input	Switchable :15 dB \pm 1 dB / 20 dB \pm 1 dB	
NF of the gain block following the photo diode	3 dB max @ 20 dB Gain 5 dB max @ 15 dB Gain	In order not to degrade the UL system NF of the external unit
IIP3	TBD	
Ripple	3 dB p-p max from 550 MHz to 2700 MHz 5 dB p-p max from 300 MHz to 2700 MHz	

2. General information of test

2.1 Test standards and results

Applied Standards : FCC CFR47 Part 27			
FCC part	Section	Description of Test	Result
Part 2.1049 Part 27.53	(a)(1)	Occupied Bandwidth	Pass
Part 2.1051 Part 27.53	(a)(1)	Spurious RF conducted emissions at the edges	Pass
Part 2.1051 Part 27.53	(a)(1)	Conducted Spurious Emission	Pass
Part 2.1046 Part 27.50	(a)(1)(i)	Output Power	Pass
Part 2.1053 Part 27.53	(a)(1)	Radiated Spurious Emission	Pass
Part 2.1055 Part 27.54	(a)(1),(d)	Frequency Stability / Temperature Variation	Pass
935210 D02	935210 D02	Out of band Rejection	Pass

2.2 Description of EUT modification

During the test, there was no mechanical or circuitry modification to improve RF and spurious characteristic, and any RF and spurious suppression device(s) was not added against the device tested.

2.3 Test configuration

• Type of peripheral equipment used

Model	Manufacturer	Description	Connected to
HX-WCS-SISO	Corning Optical Communications Wireless Inc.	EUT	HX-WCS-MHU & Spectrum analyzer (thru ATTN)-
HX-WCS-MHU	Corning Optical Communications Wireless Inc.	Master Hub Unit	EUT & Signal generator
N5182A	Agilent	Signal Generator	HX-WCS-MHU
PE7019-20	Pasternack	Attenuator	EUT
N9020A	Agilent	Spectrum Analyzer	Attenuator

• Type of cable used

Device from	Device to	Type of Cable	Length (m)	Shielded
Signal Generator	HX-WCS-MHU	N-Type	2.0	Y
HX-WCS-MHU	EUT	Optical fiber	2.0	-
EUT	Attenuator	N-Type	0.5	Y
Attenuator	Spectrum analyzer	N-Type	2.0	Y

2.4 Test setup

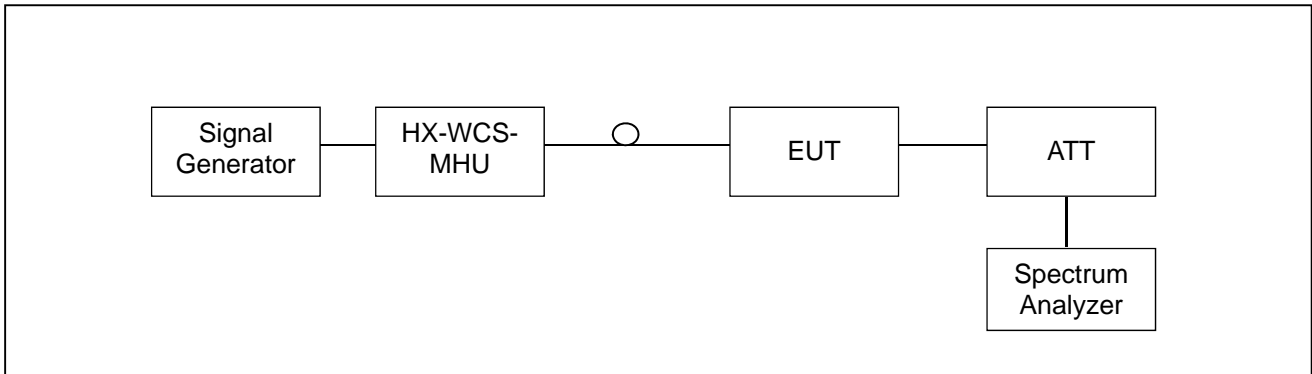

2.5 Measurement Uncertainty

- Conducted Emission (CISPR 11, EN 55011, CISPR 22, EN 55022, ANSI C63.4)

0.15 ~ 30 MHz

Expanded Uncertainty (95% , K=2) : ± 3.08 dB

- Radiated Emission (CISPR 11, EN 55011, CISPR 22, EN 55022, ANSI C63.4)

For open site 30 ~ 1000 MHz

Expanded Uncertainty (95% , K=2) : ± 4.28 dB

3. Measurement data

3.1 Occupied Bandwidth / 26 dB Emission Bandwidth

3.1.1 Specification

- FCC Part 2.1049
- FCC Part 27.53

3.1.2 Test Description

The occupied bandwidth was measured using a spectrum analyzer's 26 dB bandwidth function.

The measurements are repeated for the other channels.

The EUT's occupied bandwidth is measured as the width of the signal between two points, one below the carrier center frequency and one above the carrier frequency, outside of which all emissions are attenuated at least 26 dB below the transmitter power.

Occupied Bandwidth and 26 dB Emission Bandwidth were measured on port 1 and port 2 under the three types of modulation mode which are QPSK, 16QAM and 64QAM, and resource block was 50.

3.1.3 Test Procedure

The method used is as detailed in FCC KDB 971168.

The EUT was set up to the applicable test frequency with modulation. The EUT antenna terminal was conducted to the spectrum analyzer through an external attenuator (at the output test) and an appropriate coaxial cable.

The OBW function (99% , 26 dB) was using for these evaluation.

Occupied bandwidth measured was repeated for each modulation.

3.1.4 Test equipment list

Equipment	Model Name	Manufacturer
EUT	HX-WCS-MIMO	Corning Optical Communications Wireless, Inc.
Signal Generator	N5182A	Agilent
Spectrum Analyzer	N9020A	Agilent
Attenuator	PE7019-20	Pasternack
DC Power Supply	6674A	Agilent

3.1.5 Test condition

- Test place: Shield Room
- Test environment: 23.0 °C, 43 % R.H.

3.1.6 Test results

- Port1

WCS Block	Bandwidth [MHz]	Frequency [MHz]	Modulation	Occupied Bandwidth [MHz]	26 dB Emission Bandwidth [MHz]
A+B	10	2 355.0	QPSK	8.954	9.487
			16QAM	8.954	9.490
			64QAM	8.965	9.481
A	5	2 352.5	QPSK	4.496	4.807
			16QAM	4.501	4.885
			64QAM	4.494	4.835
B	5	2 357.5	QPSK	4.515	4.843
			16QAM	4.491	4.808
			64QAM	4.495	4.830

- Port2

WCS Block	Bandwidth [MHz]	Frequency [MHz]	Modulation	Occupied Bandwidth [MHz]	26 dB Emission Bandwidth [MHz]
A+B	10	2 355.0	QPSK	8.952	9.514
			16QAM	8.957	9.581
			64QAM	8.950	9.502
A	5	2 352.5	QPSK	4.497	4.853
			16QAM	4.504	4.868
			64QAM	4.496	4.837
B	5	2 357.5	QPSK	4.491	4.857
			16QAM	4.495	4.836
			64QAM	4.493	4.834

3.1.7 Test Plots

- Port1 / LTE 10 MHz / 2 355 MHz / QPSK

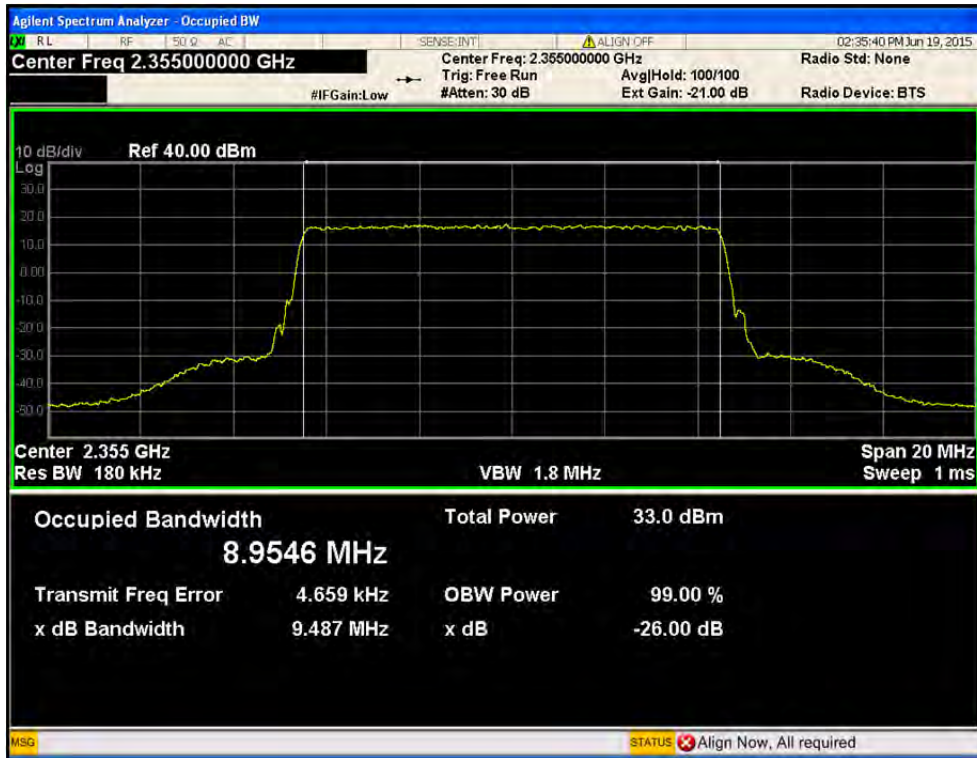

- Port1 / LTE 10 MHz / 2 355 MHz / 16QAM

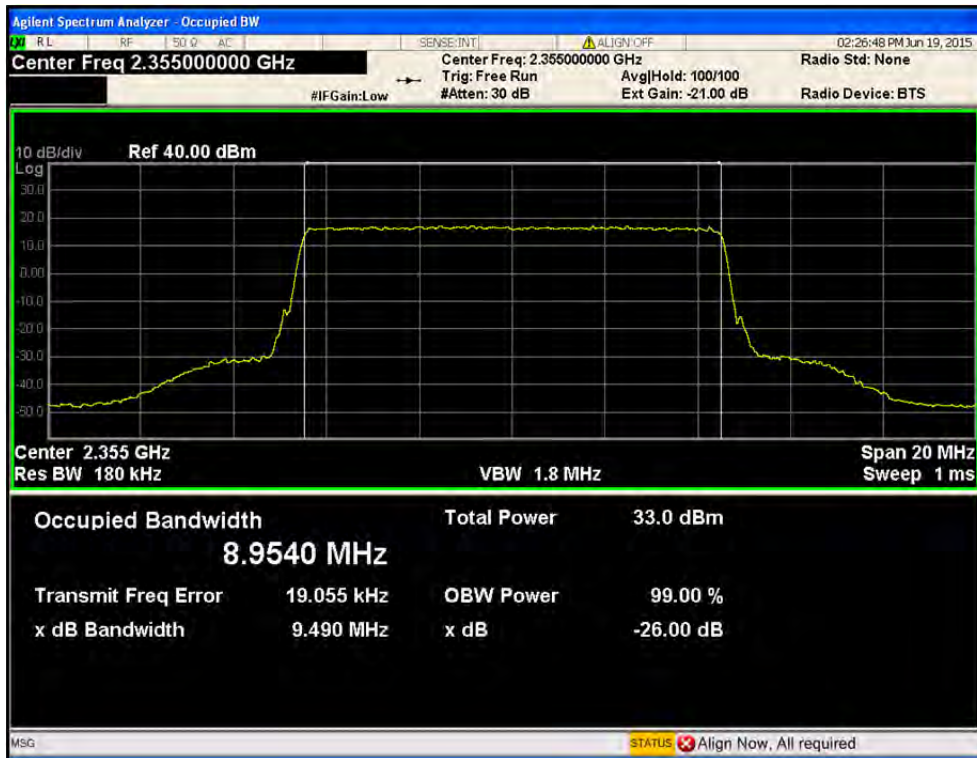

• Port1 / LTE 10 MHz / 2 355 MHz / 64QAM

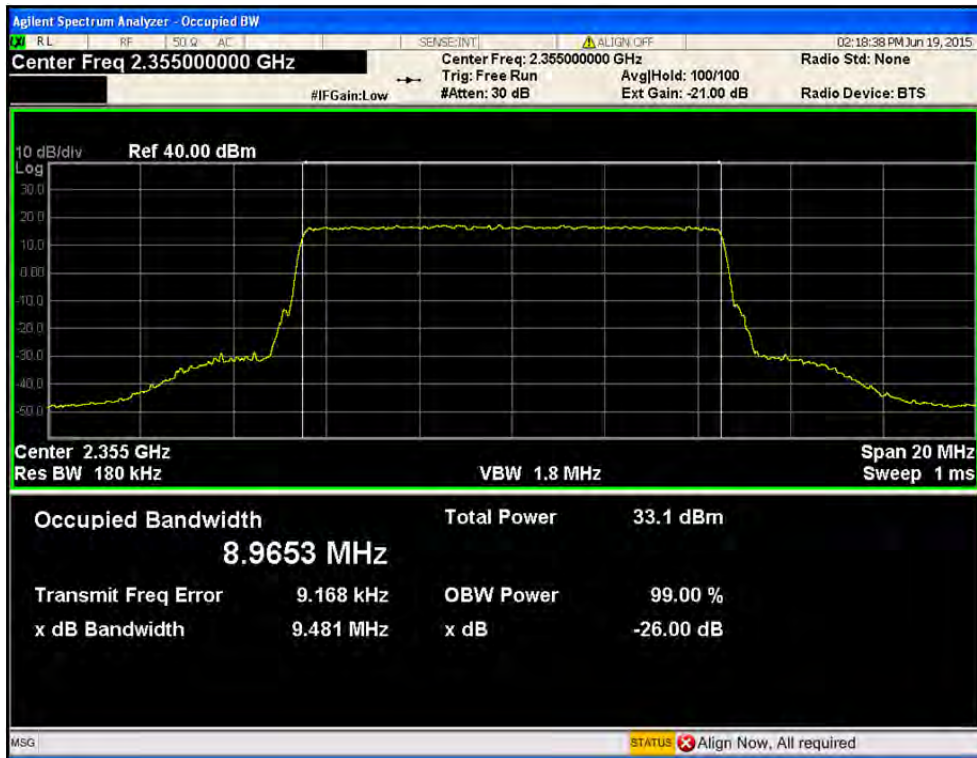

• Port1 / LTE 5 MHz / 2 352.5 MHz / QPSK

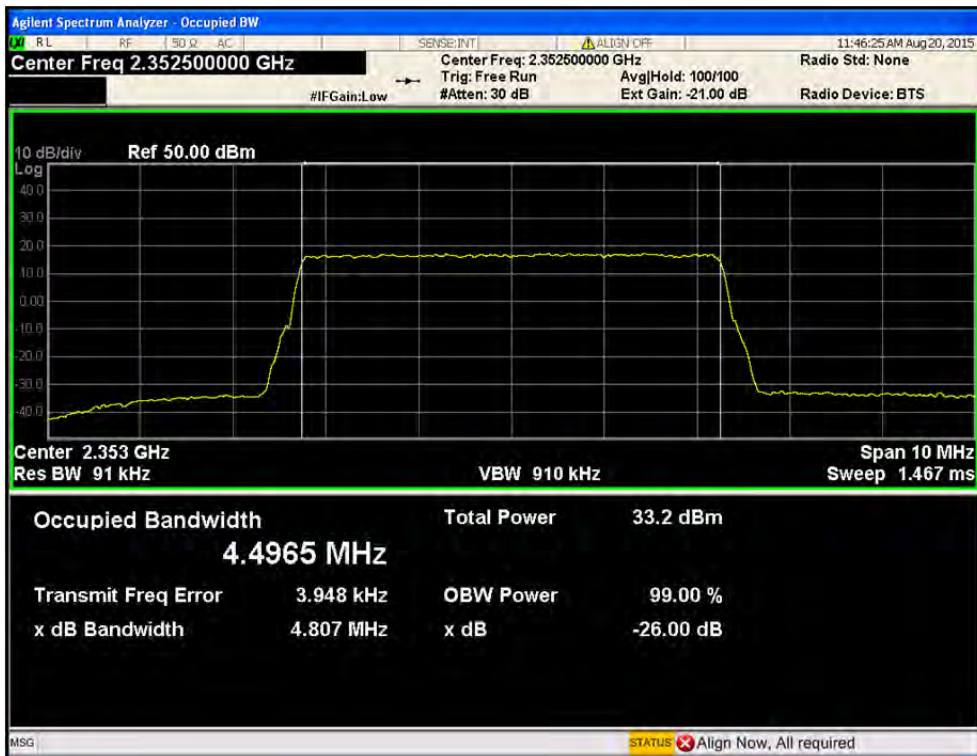

- Port1 / LTE 5 MHz / 2 352.5 MHz / 16QAM

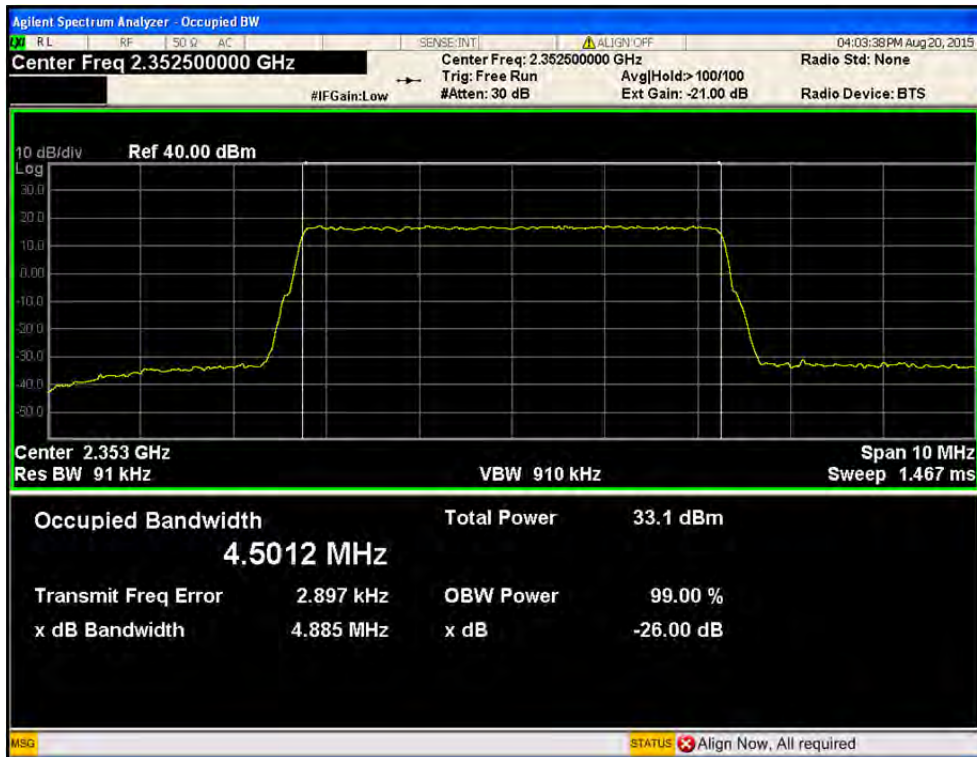

- Port1 / LTE 5 MHz / 2 352.5 MHz / 64QAM

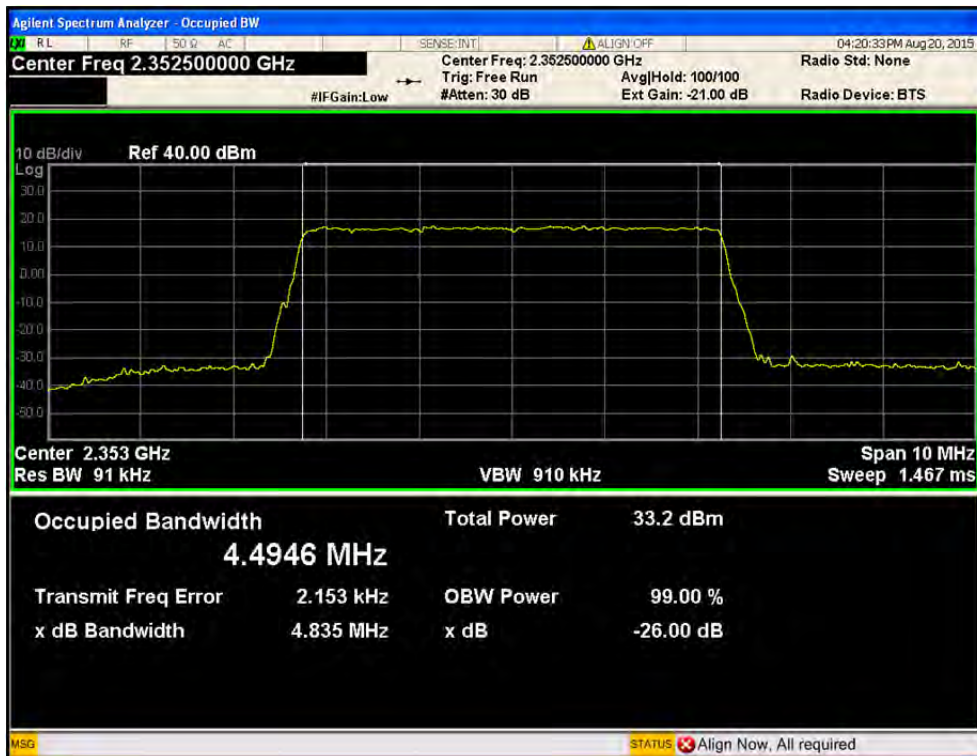

• Port1 / LTE 5 MHz / 2 357.5 MHz / QPSK

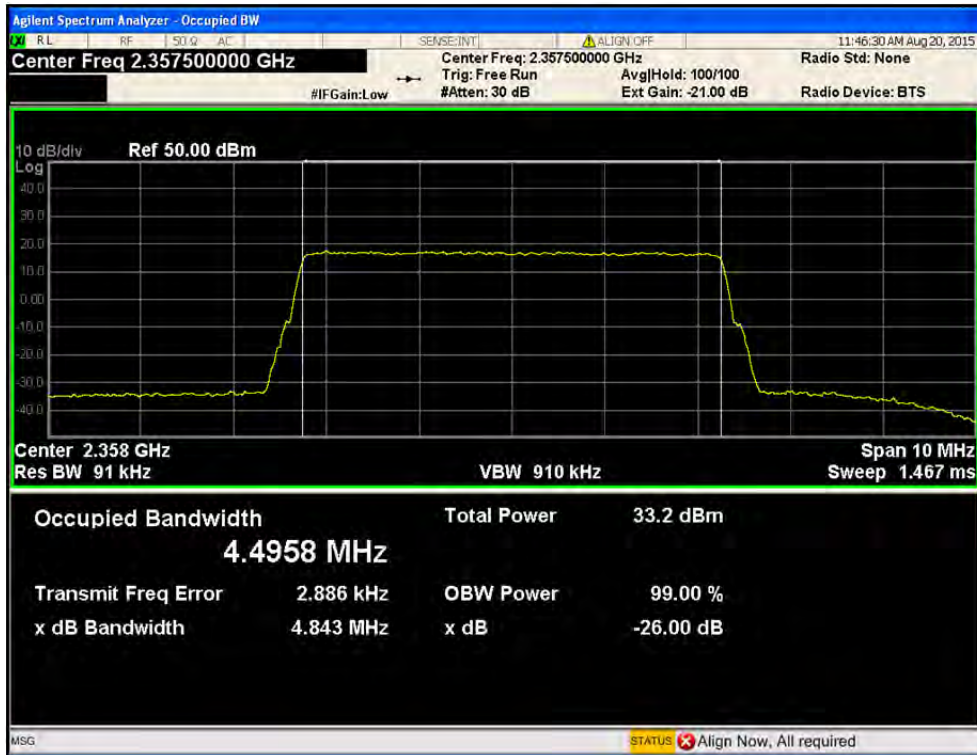

• Port1 / LTE 5 MHz / 2 357.5 MHz / 16QAM

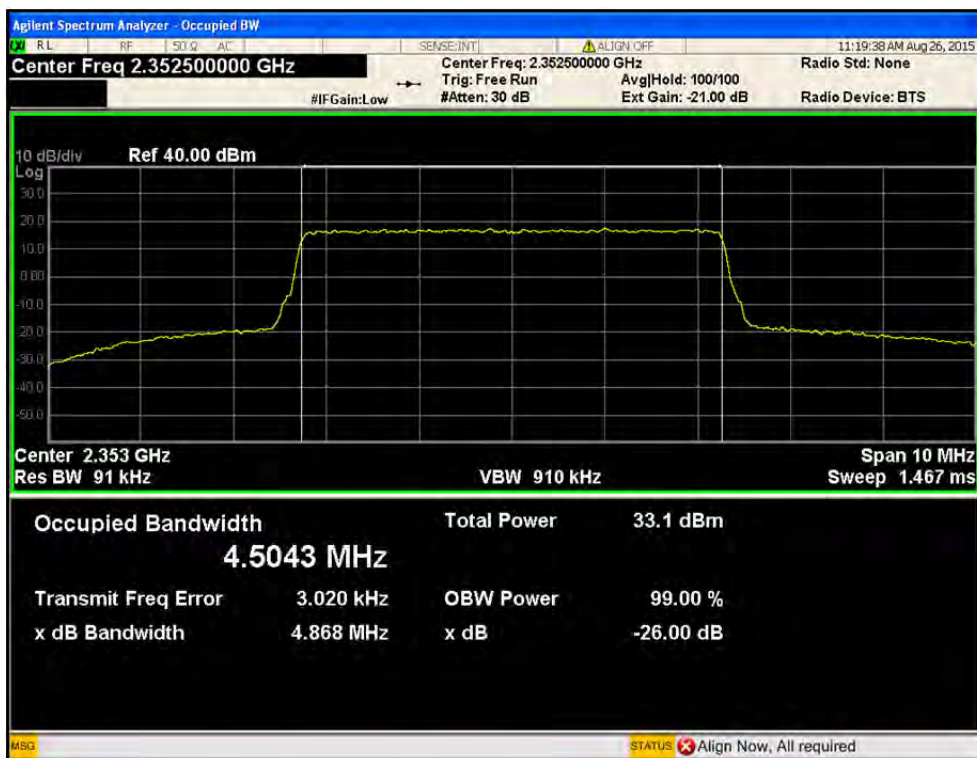

- Port1 / LTE 5 MHz / 2 357.5 MHz / 64QAM

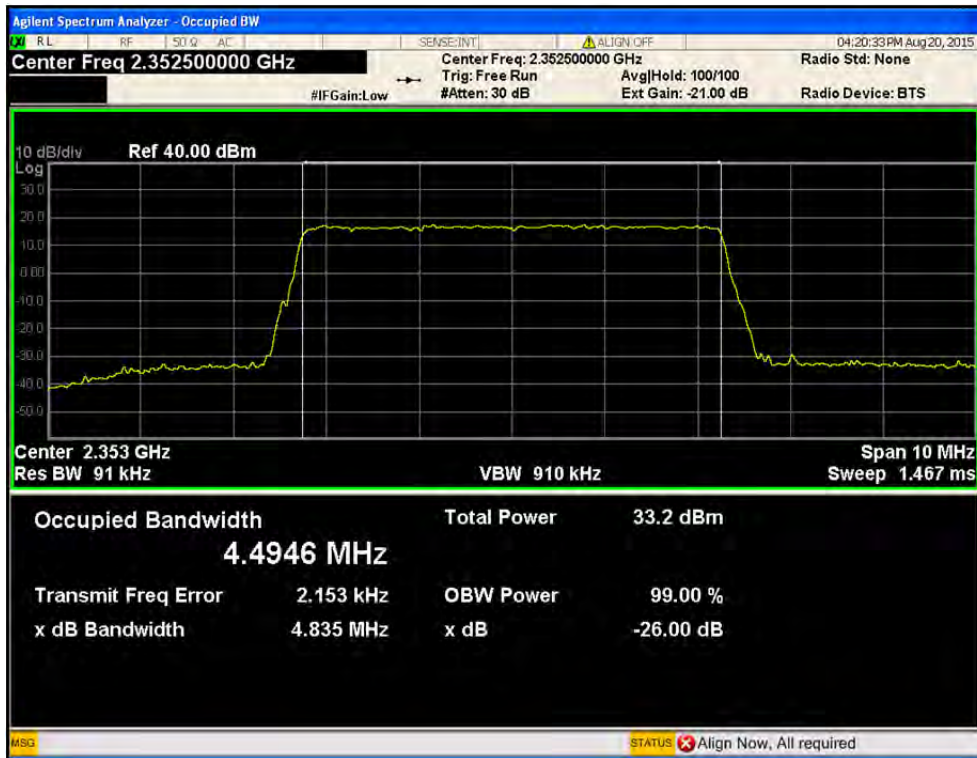

- Port2 / LTE 10 MHz / 2 355 MHz / QPSK

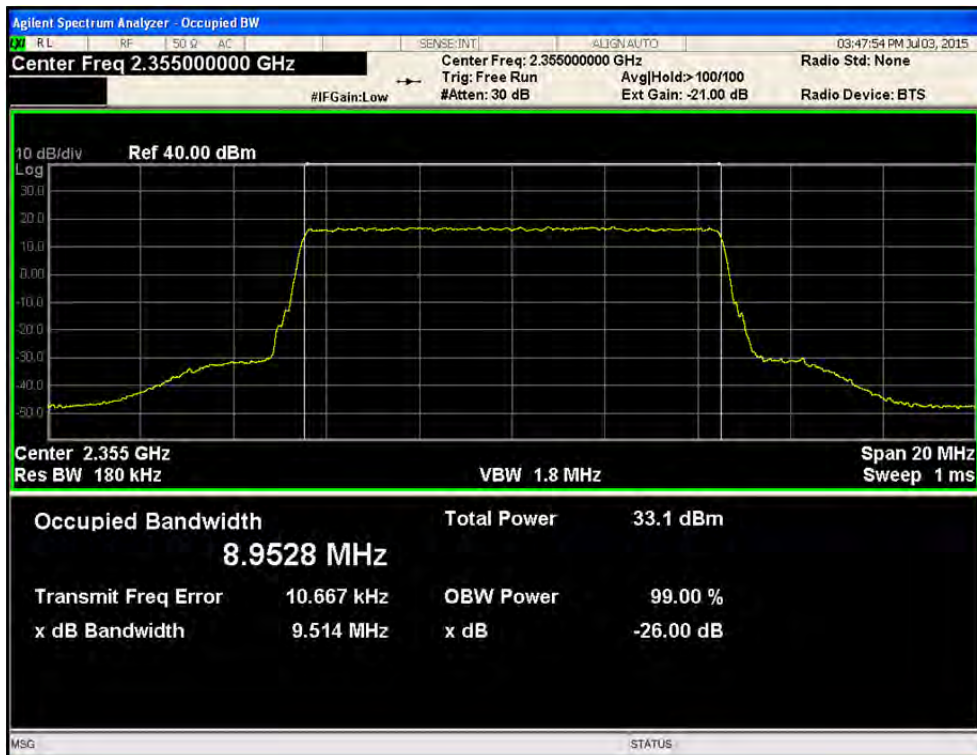

• Port2 / LTE 10 MHz / 2 355 MHz / 16QAM

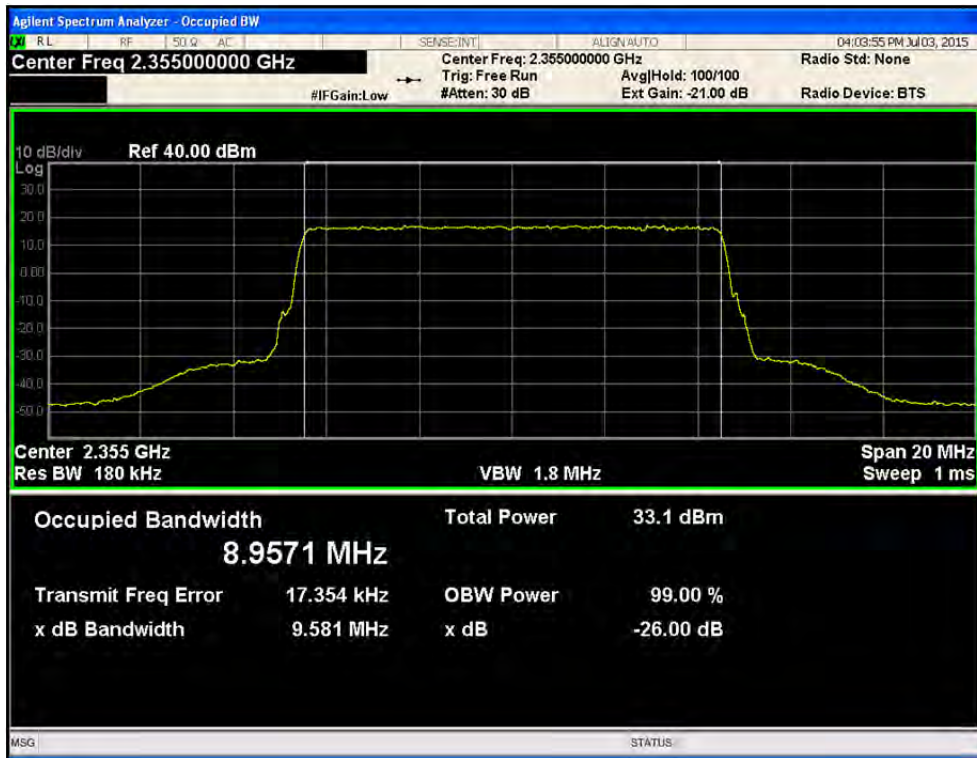

• Port2 / LTE 10 MHz / 2 355 MHz / 64QAM

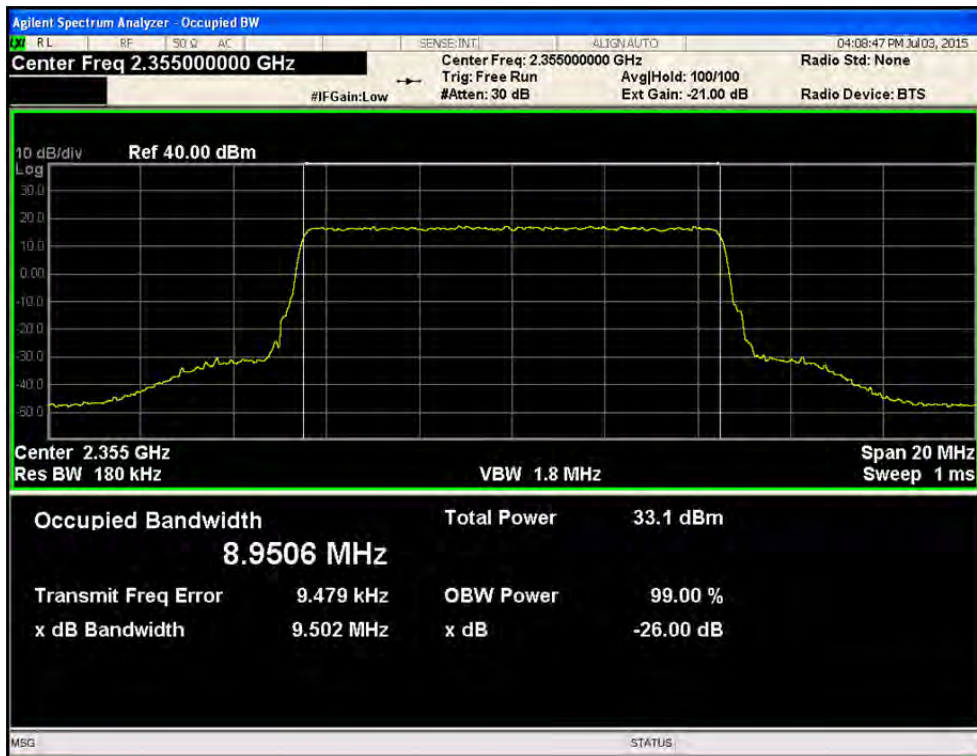

- Port2 / LTE 5 MHz / 2 352.5 MHz / QPSK

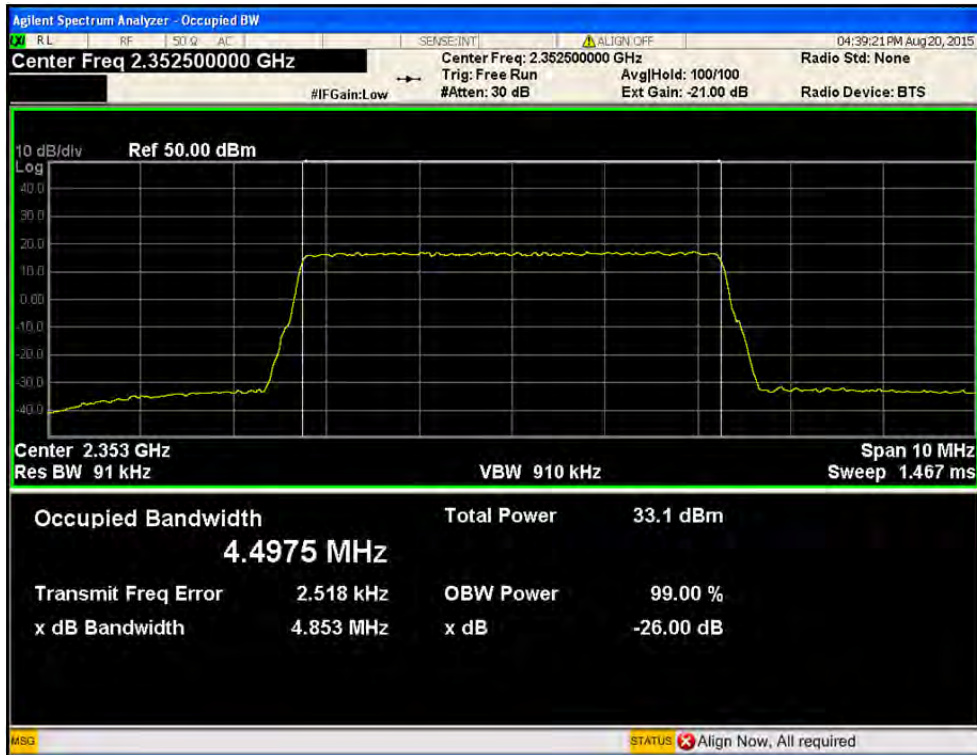

- Port2 / LTE 5 MHz / 2 352.5 MHz / 16QAM

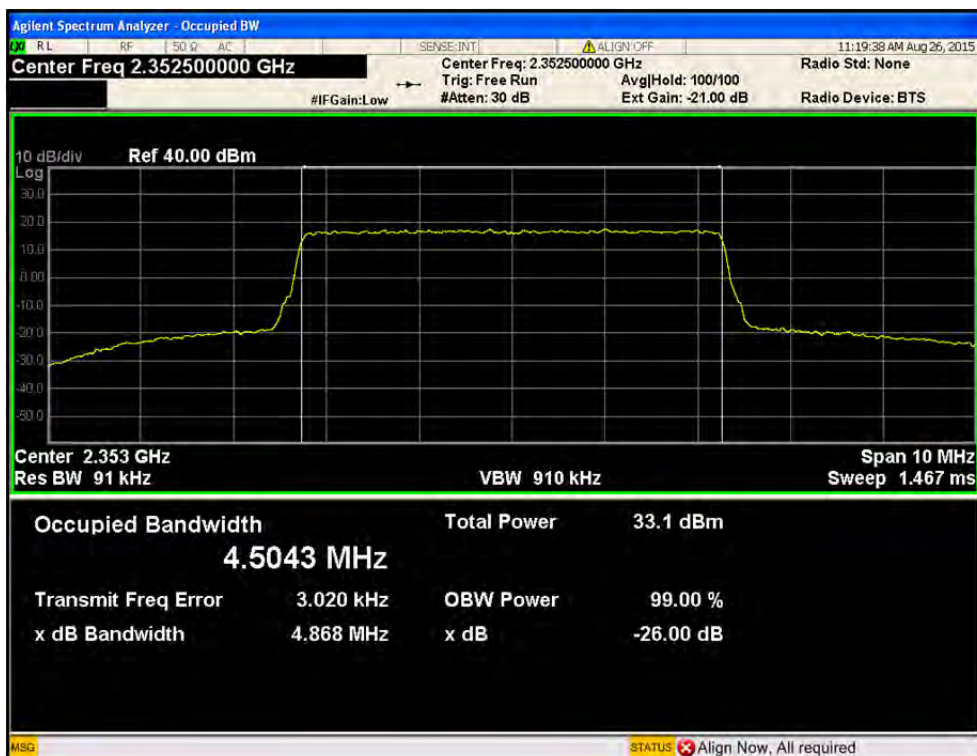

- Port2 / LTE 5 MHz / 2 352.5 MHz / 64QAM

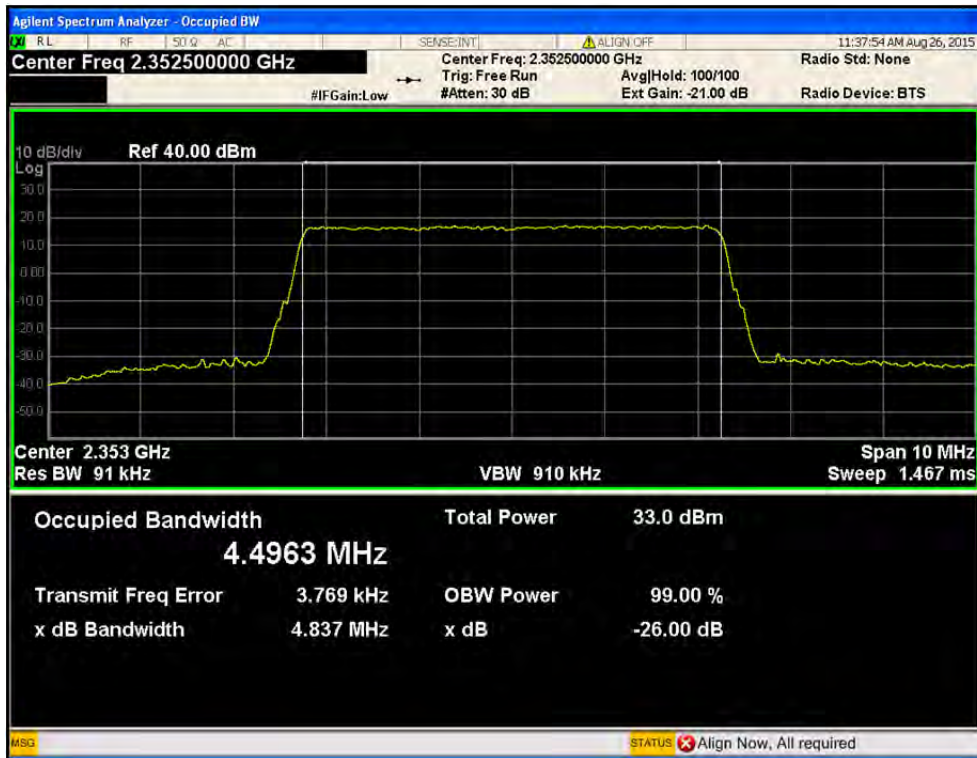

- Port2 / LTE 5 MHz / 2 357.5 MHz / QPSK

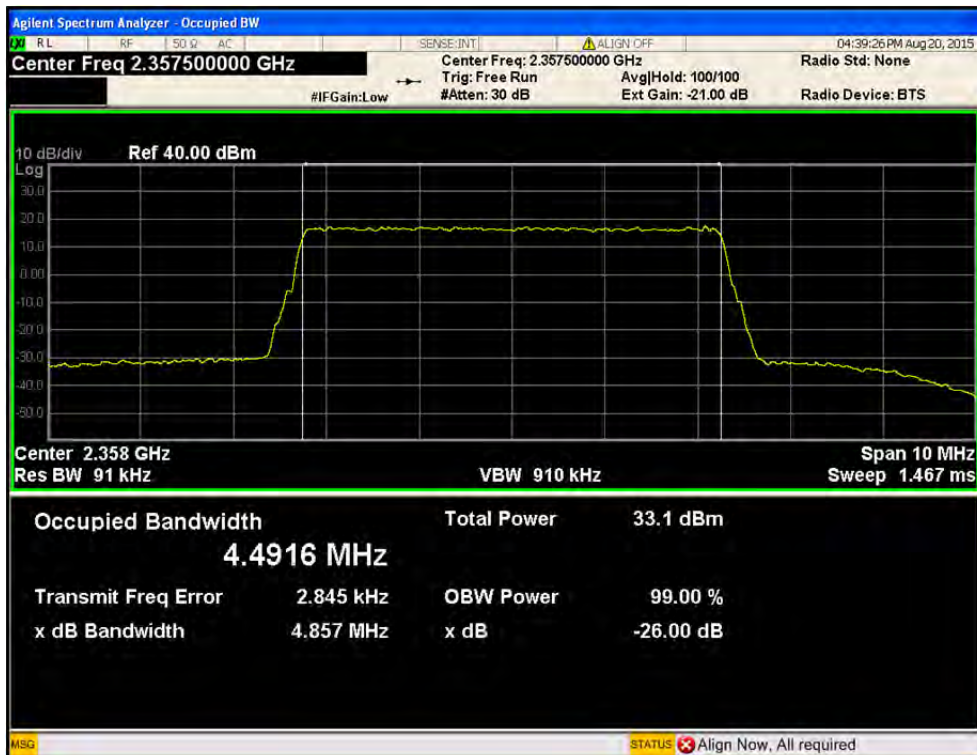

• Port2 / LTE 5 MHz / 2 357.5 MHz / 16QAM

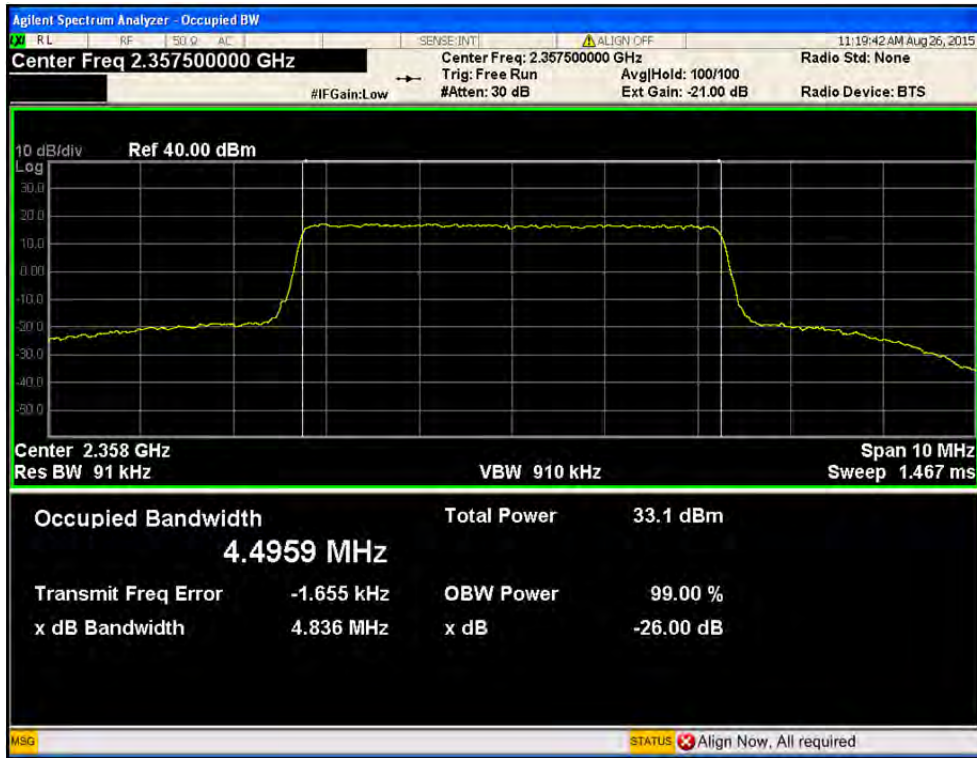

• Port2 / LTE 5 MHz / 2 357.5 MHz / 64QAM

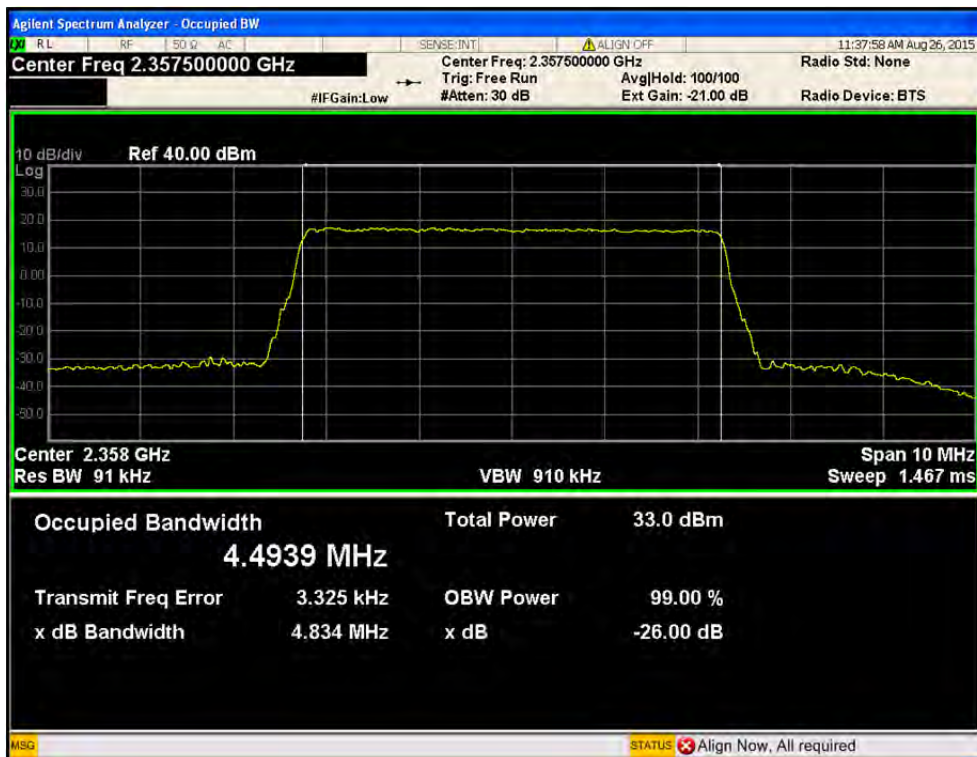

3.2 Band Edge

3.2.1 Specification

- FCC Rules Part 2.1051
- FCC Rules Part 27.53 (a)(1)

3.2.2 Test Description

The spurious RF conducted emissions at the edges of the authorized bands were measured with the EUT set to low and high transmit frequencies in the available band. The channels closest to the band edges were selected. The measurement was made using a direct connection between the RF output of the EUT and the spectrum analyzer.

The spectrum was scanned below the lower band edge and above the higher band edge. The resolution bandwidth was set to approximately 1% of the measured emissions bandwidth within the first 1 MHz block adjacent to the transmit band. An average RMS detector was used match the method used during Output Power.

The spurious RF conducted emissions at the edges were measured on port1 and port 2 under the three types of modulation mode which are QPSK, 16QAM and 64QAM, and resource block was 50.

3.2.3 Test Procedure

The power of any emission in the 1 MHz bands immediately outside and adjacent to the channel blocks (2350 ~ 2360 MHz) was attenuated below the transmitting power (P) by a factor as specified in this section.

The EUT antenna terminal was connected to the spectrum analyzer through an external attenuator and an appropriate coaxial cable

The evaluation was repeated for all modulations.

3.2.4 Test equipment list

Equipment	Model Name	Manufacturer
EUT	HX-WCS-MIMO	Corning Optical Communications Wireless Inc.
MHU	HX-WCS-MHU	Corning Optical Communications Wireless Inc.
Signal Generator	N5182A	Agilent
Spectrum Analyzer	N9020A	Agilent
Attenuator	PE7019-20	Pasternack
DC Power Supply	6674A	Agilent

3.2.5 Test condition

- Test place: Shield Room
- Test environment: 23.0 °C, 43 % R.H.

3.2.6 Test Results

- Port1

WCS Block	Bandwidth [MHz]	Frequency [MHz]	Modulation	Band Edge	Operation Frequency [MHz]	Emission Level [dBm]	Emission Limit [dBm]	Result
A+B	10	2 355.0	QPSK	Lower	2 349.8	-32.16	-13.0	Pass
				Upper	2 360.2	-32.07		
			16QAM	Lower	2 349.8	-32.35		
				Upper	2 360.2	-31.97		
			64QAM	Lower	2 349.8	-31.73		
				Upper	2 360.2	-31.94		
A	5	2 352.5	QPSK	Lower	2 349.8	-31.41	-13.0	Pass
				Upper	2 355.1	-30.91		
			16QAM	Lower	2 349.8	-30.27		
				Upper	2 355.1	-30.35		
			64QAM	Lower	2 349.8	-30.04		
				Upper	2 355.1	-28.92		
B	5	2 357.5	QPSK	Lower	2 354.8	-31.19	-13.0	Pass
				Upper	2 360.1	-31.04		
			16QAM	Lower	2 354.8	-30.26		
				Upper	2 360.1	-30.45		
			64QAM	Lower	2 354.8	-29.82		
				Upper	2 360.1	-30.11		

- Port2

WCS Block	Bandwidth [MHz]	Frequency [MHz]	Modulation	Band Edge	Operation Frequency [MHz]	Emission Level [dBm]	Emission Limit [dBm]	Result
A+B	10	2 355	QPSK	Lower	2 349.8	-32.54	-13.0	Pass
				Upper	2 360.2	-32.32		
			16QAM	Lower	2 349.8	-33.32		
				Upper	2 360.2	-32.77		
			64QAM	Lower	2 349.8	-32.57		
				Upper	2 360.2	-32.95		
A	5	2 352.5	QPSK	Lower	2 349.8	-31.17	-13.0	Pass
				Upper	2 355.1	-30.72		
			16QAM	Lower	2 349.8	-18.63		
				Upper	2 355.1	-18.20		
			64QAM	Lower	2 349.8	-30.86		
				Upper	2 355.1	-30.46		
B	5	2 357.5	QPSK	Lower	2 354.8	-30.24	-13.0	Pass
				Upper	2 360.1	-30.42		
			16QAM	Lower	2 354.8	-17.86		
				Upper	2 360.1	-18.59		
			64QAM	Lower	2 354.8	-29.86		
				Upper	2 360.1	-30.03		

3.2.7 Test Plots

- Port1 / LTE 10 MHz / 2 355 MHz / QPSK

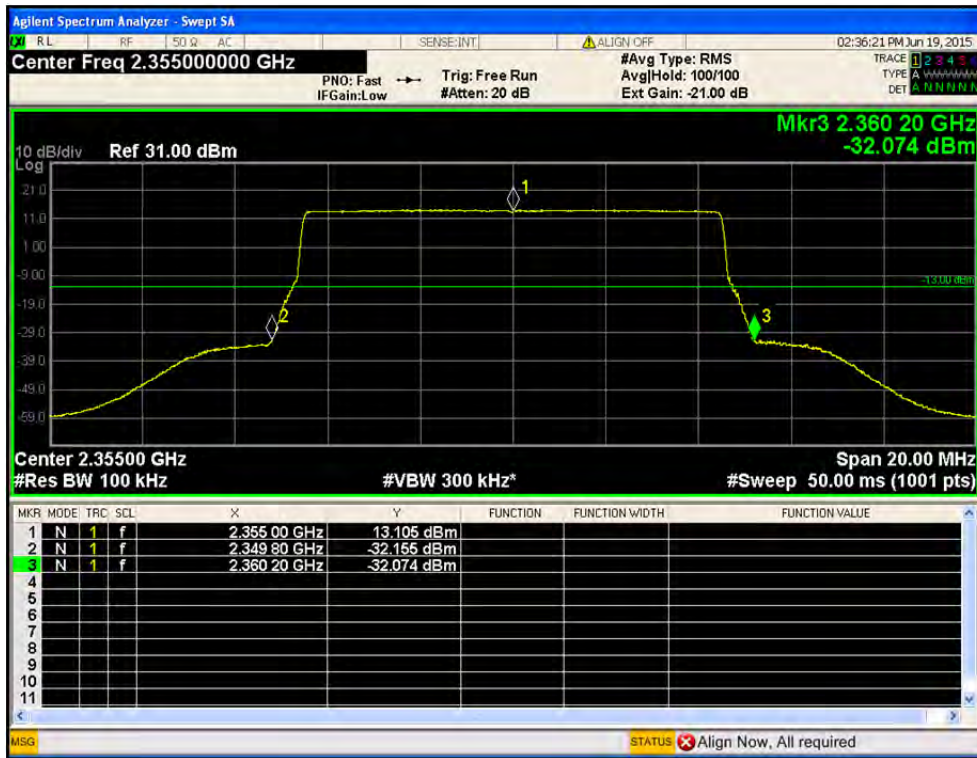

- Port1 / LTE 10 MHz / 2 355 MHz / 16QAM

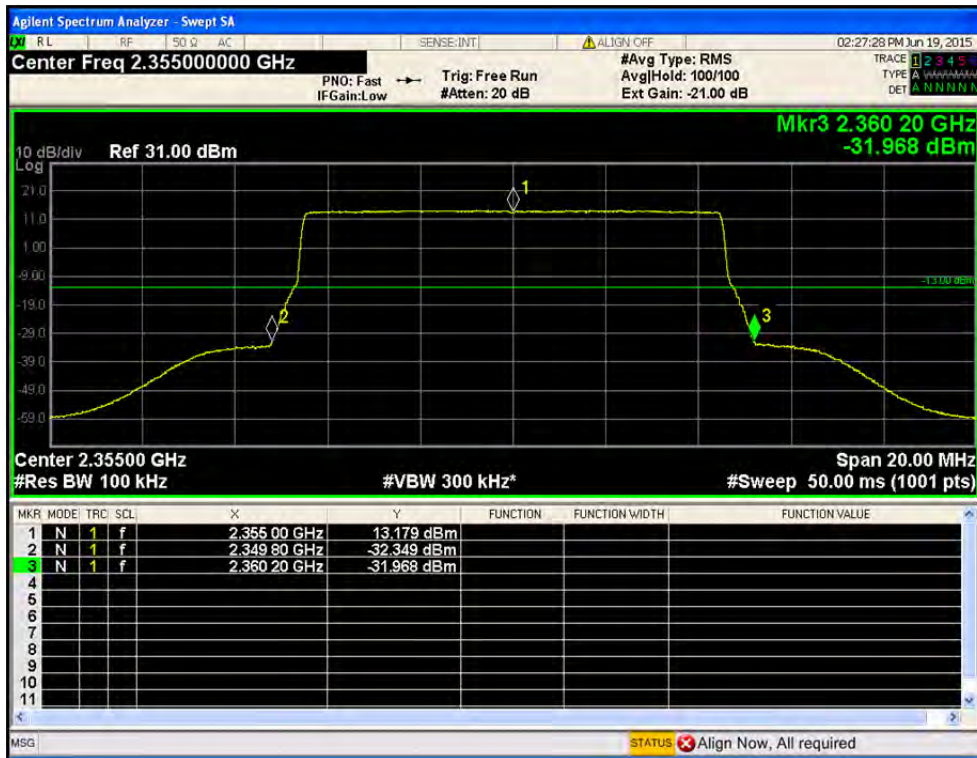

• Port1 / LTE 10 MHz / 2 355 MHz / 64QAM

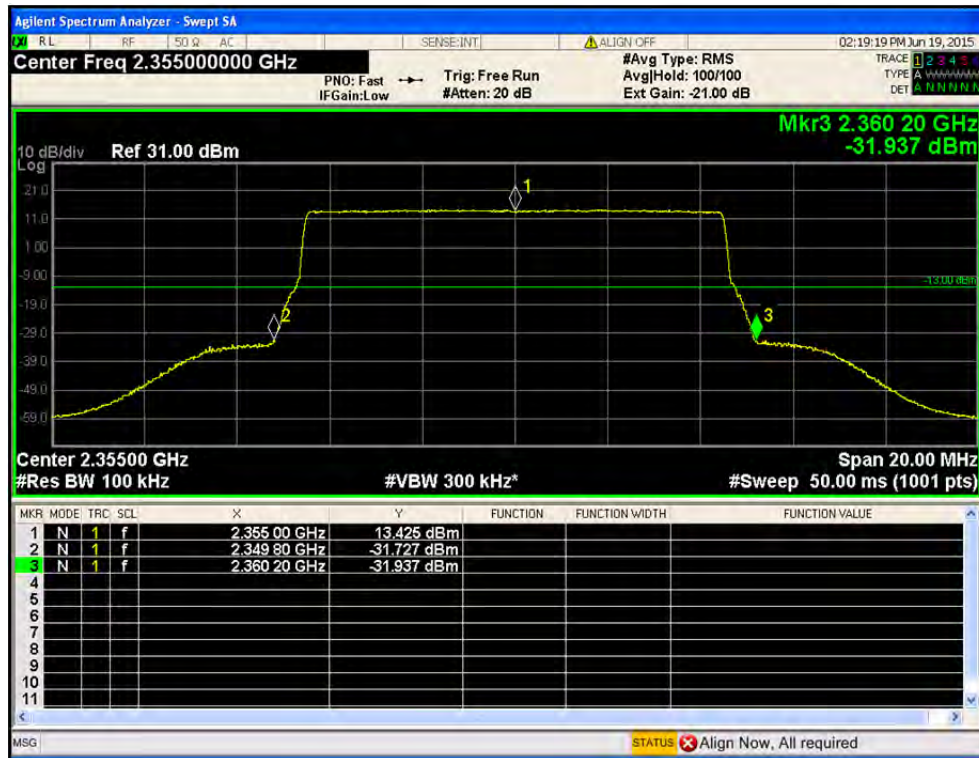

• Port1 / LTE 5 MHz / 2 352.5 MHz / QPSK

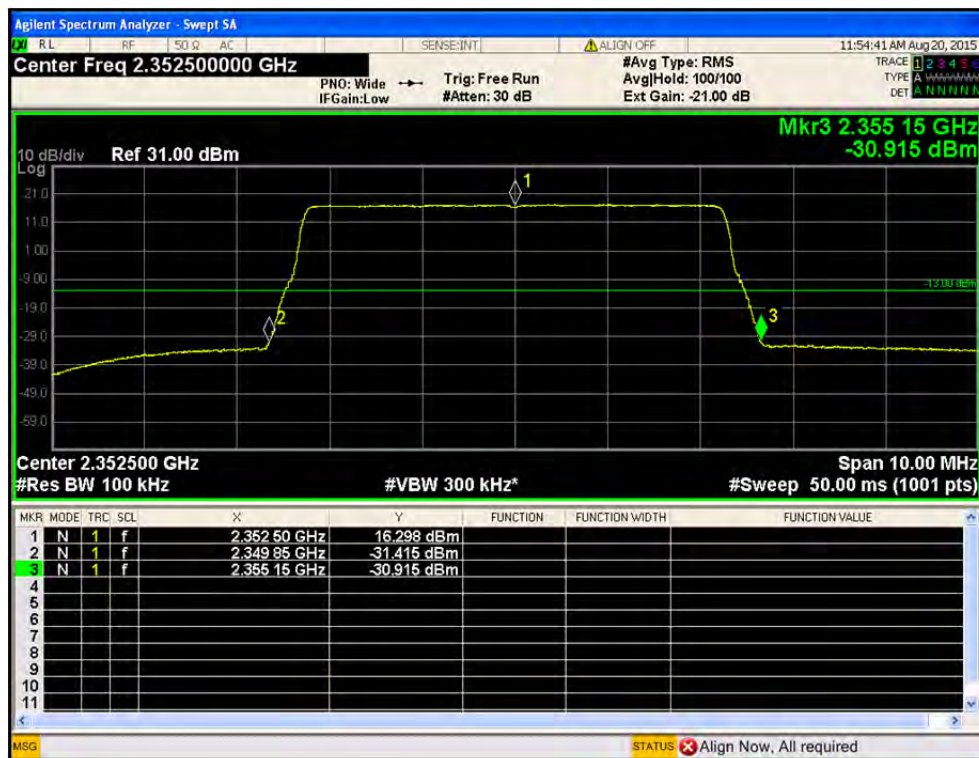

• Port1 / LTE 5 MHz / 2 352.5 MHz / 16QAM

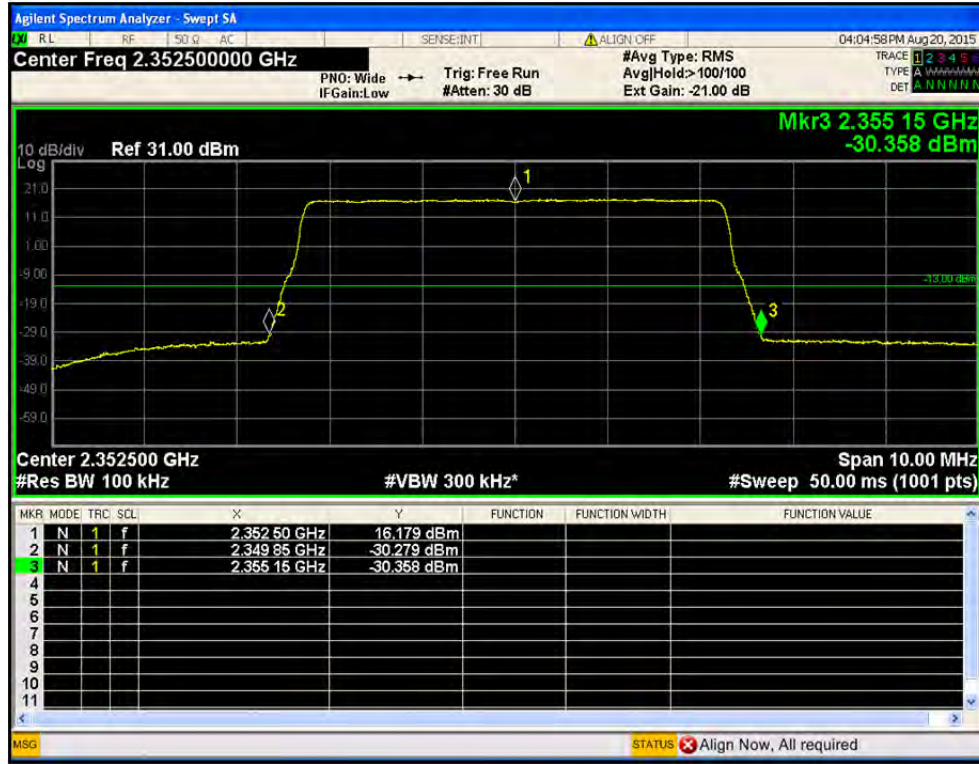

• Port1 / LTE 5 MHz / 2 352.5 MHz / 64QAM

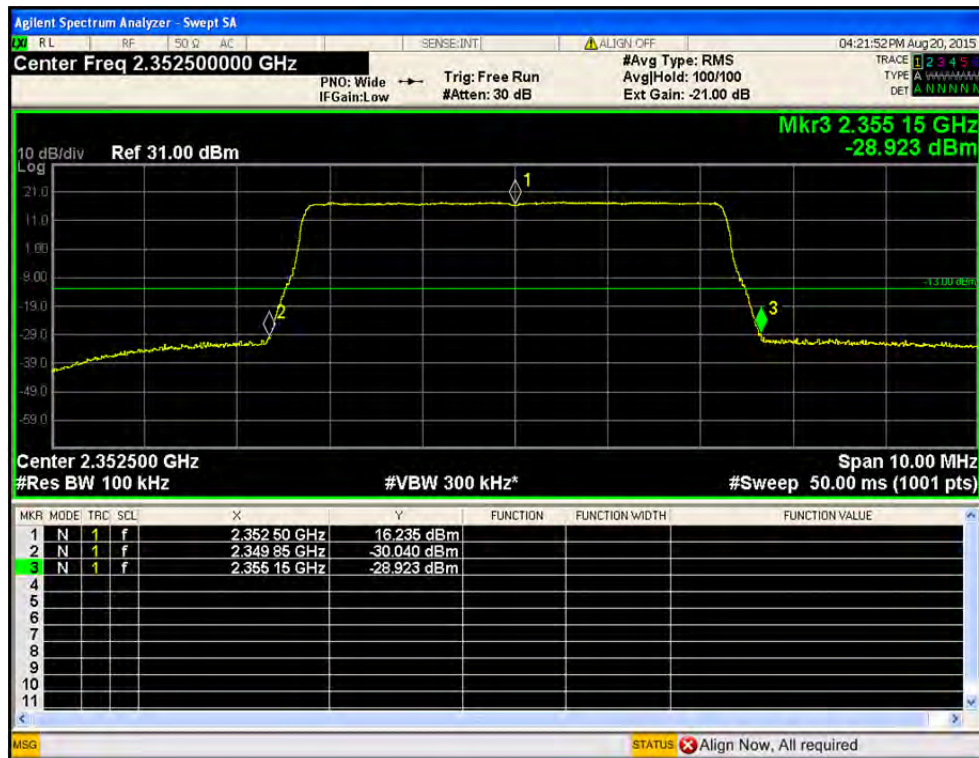

• Port1 / LTE 5 MHz / 2 357.5 MHz / QPSK

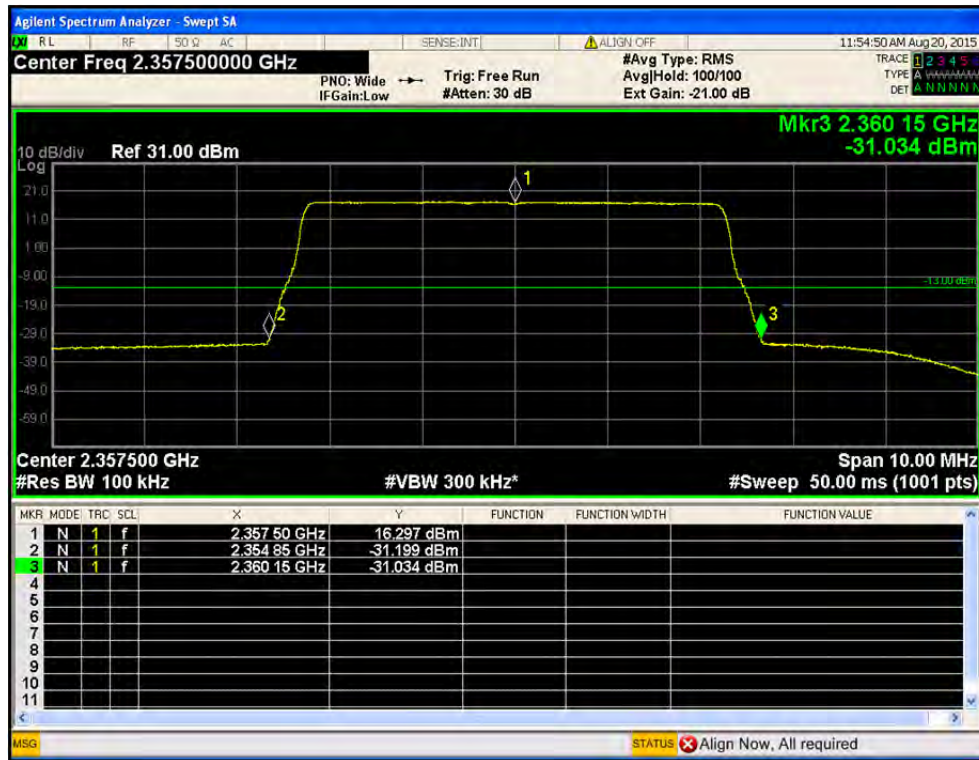

• Port1 / LTE 5 MHz / 2 357.5MHz / 16QAM

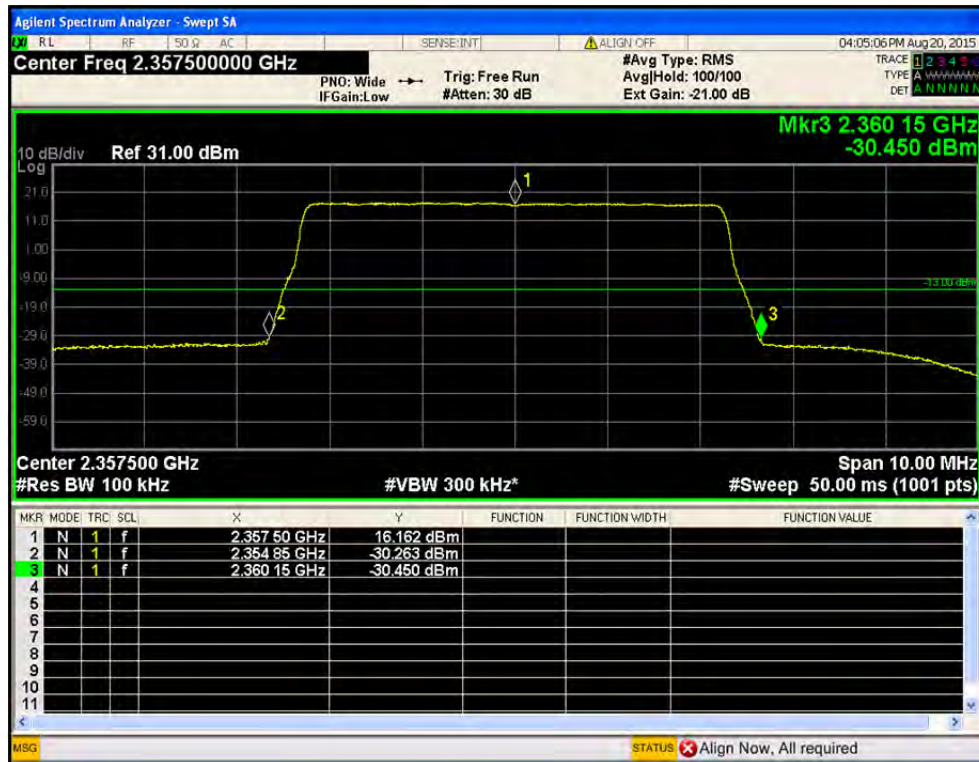

• Port1 / LTE 5 MHz / 2 357.5 MHz / 64QAM

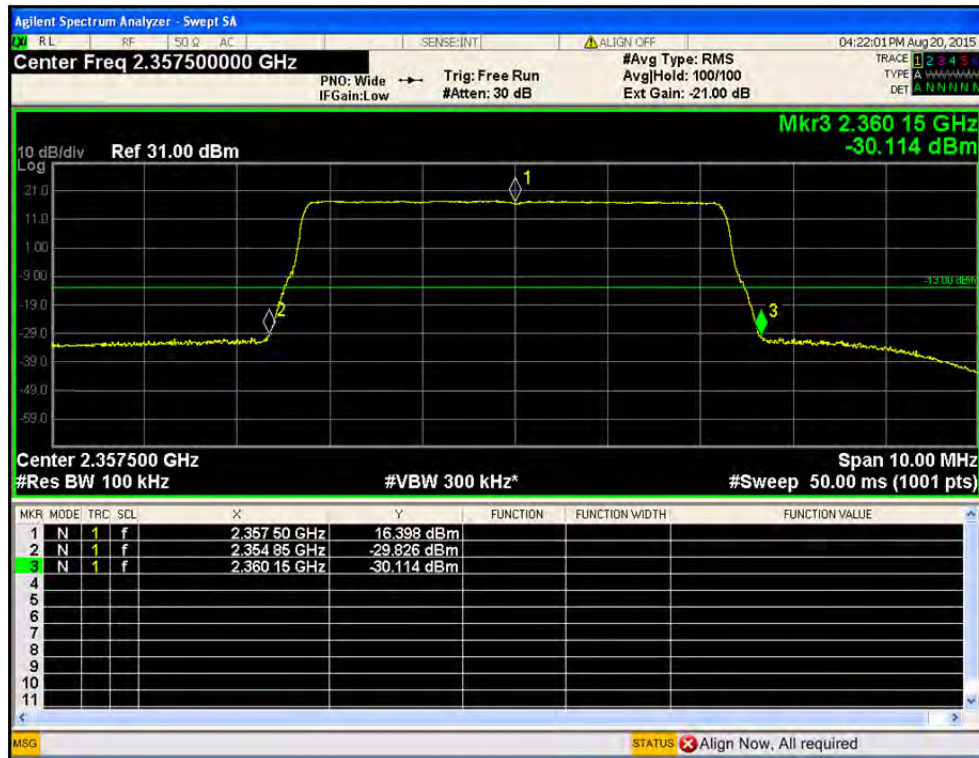

• Port2 / LTE 10 MHz / 2 355 MHz / QPSK

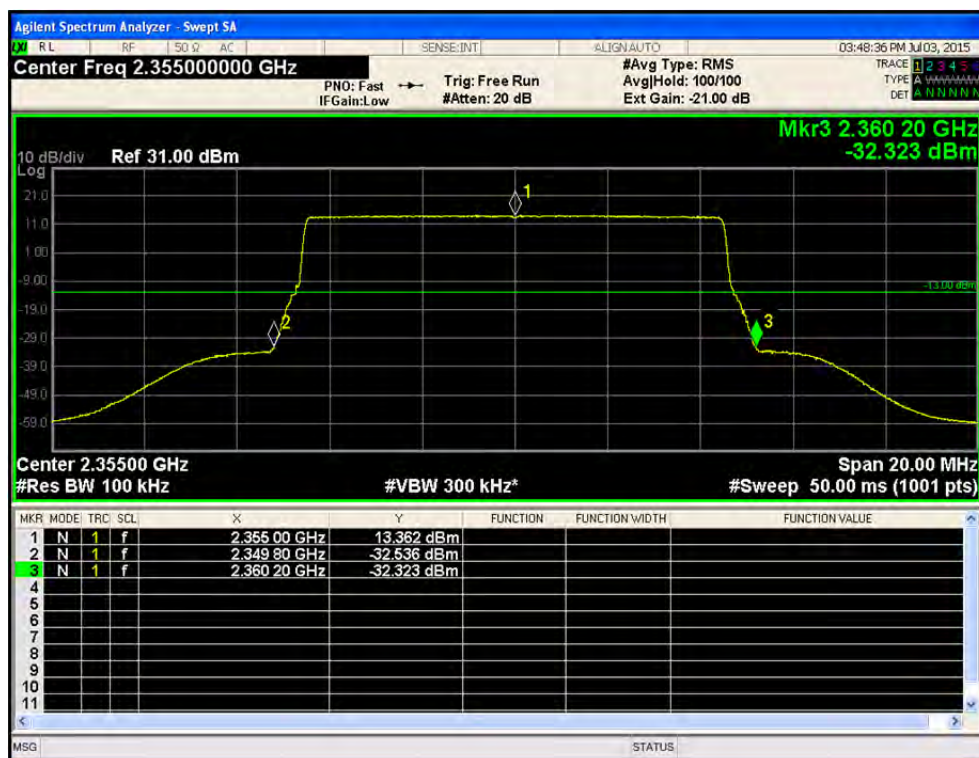

• Port2 / LTE 10 MHz / 2 355 MHz / 16QAM

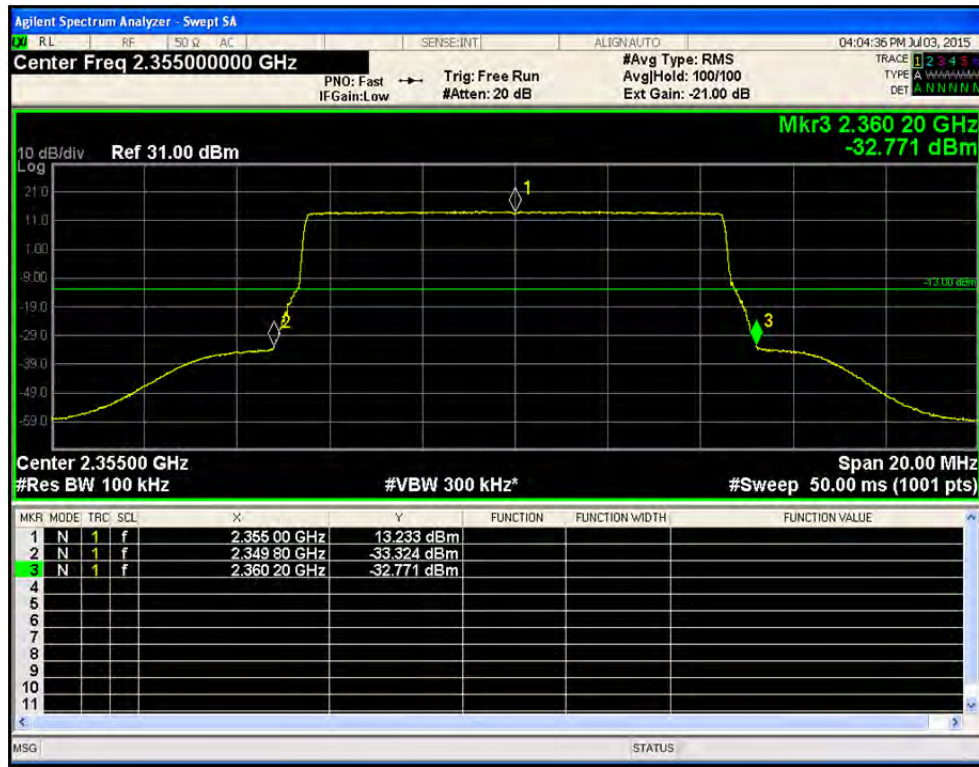

• Port1 / LTE 10 MHz / 2 355 MHz / 64QAM

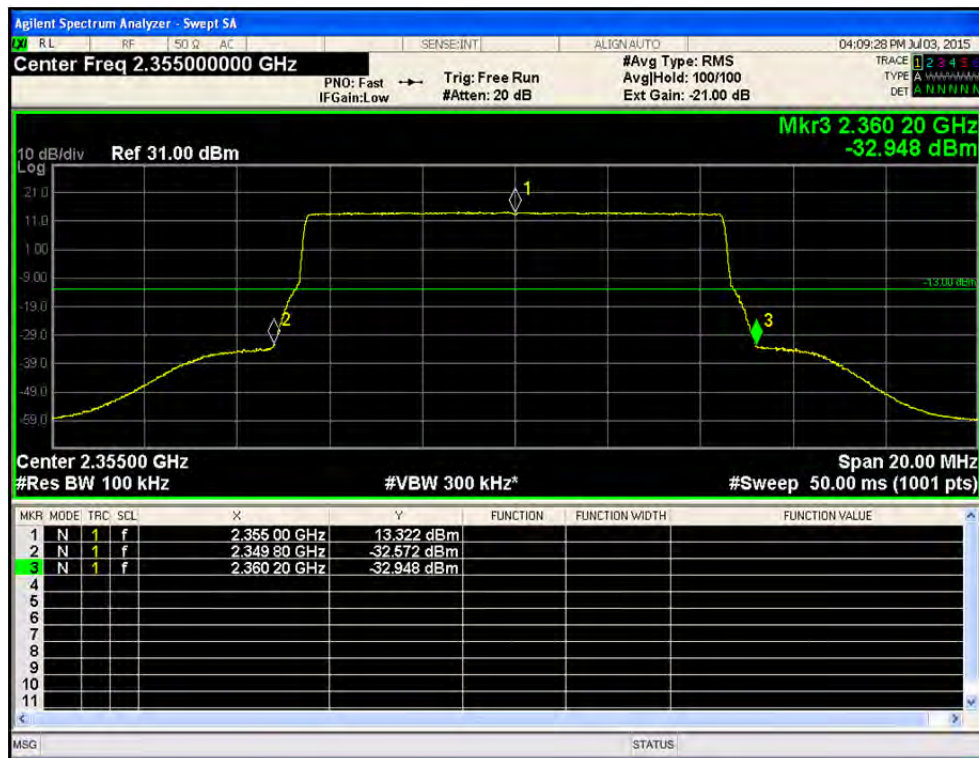

• Port2 / LTE 5 MHz / 2 352.5 MHz / QPSK

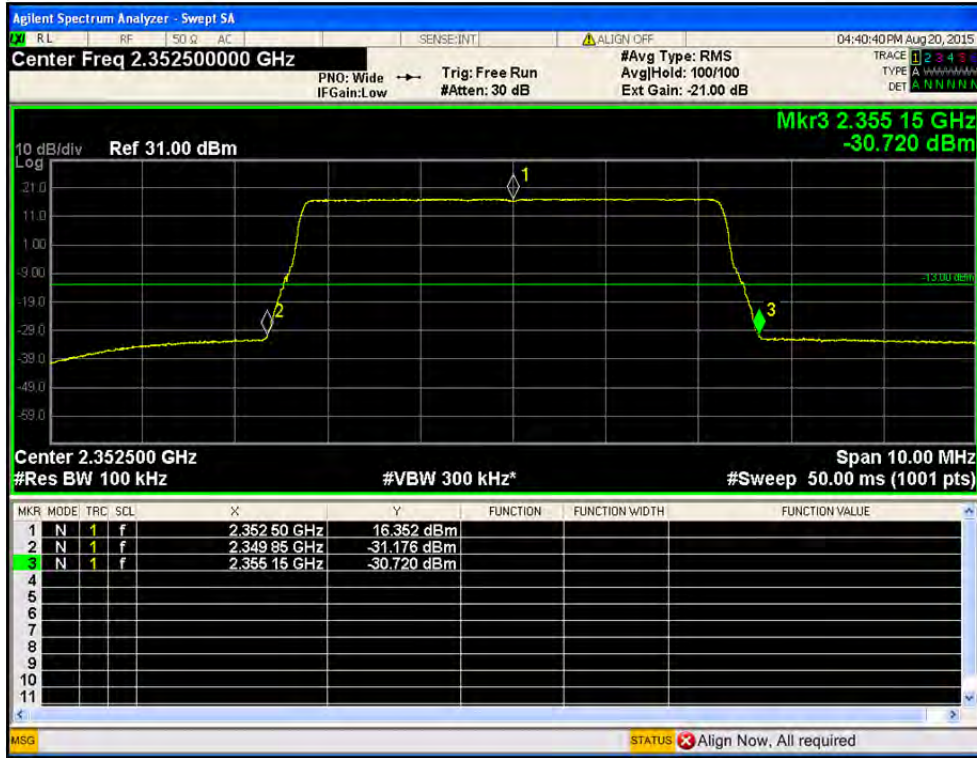

• Port2 / LTE 5 MHz / 2 352.5 MHz / 16QAM

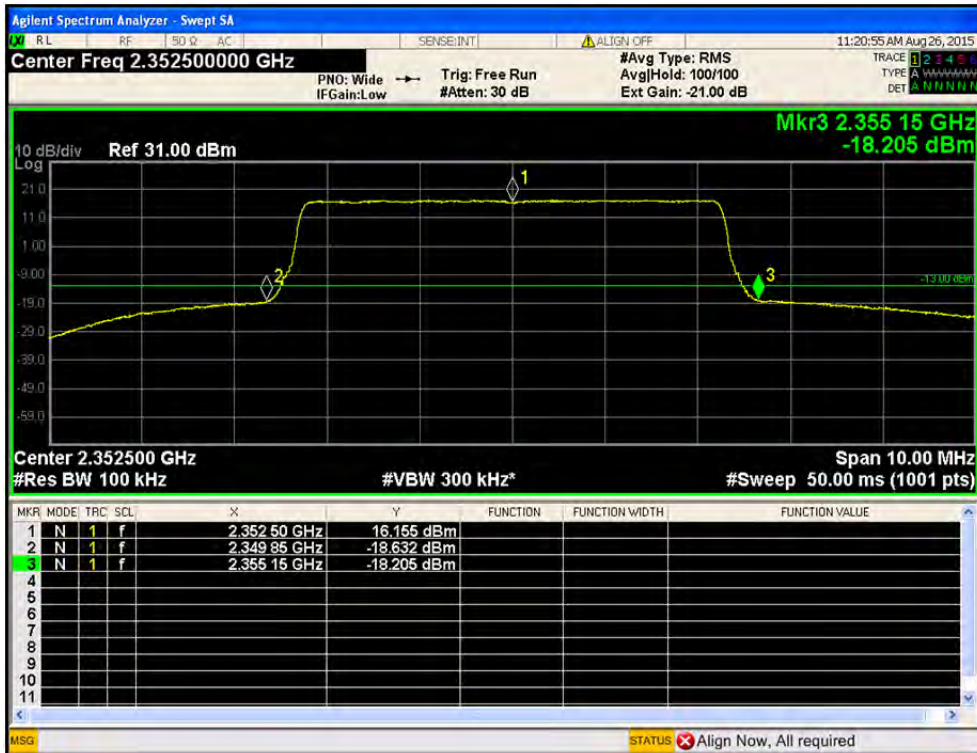

• Port2 / LTE 5 MHz / 2 352.5 MHz / 64QAM

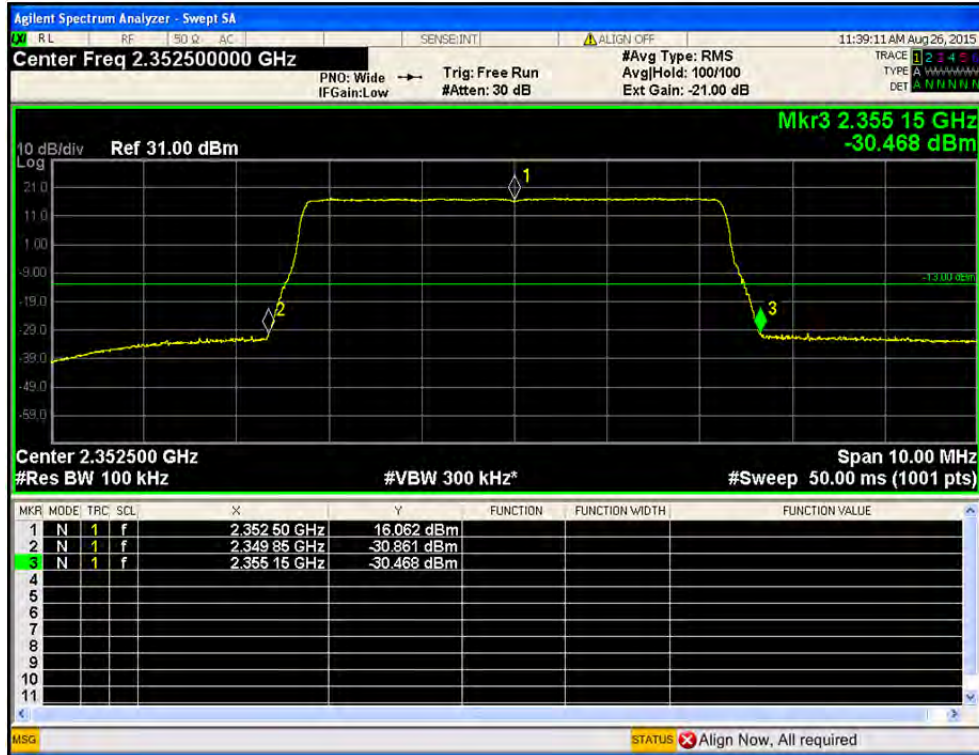

• Port2 / LTE 5 MHz / 2 357.5 MHz / QPSK

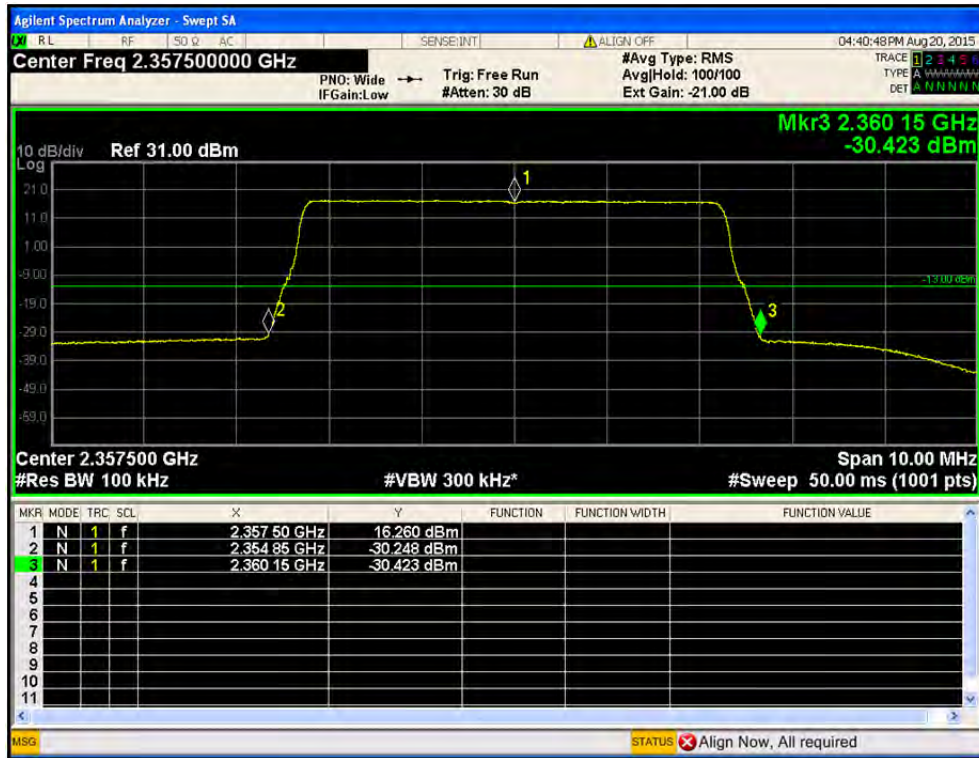

• Port2 / LTE 5 MHz / 2 357.5MHz / 16QAM

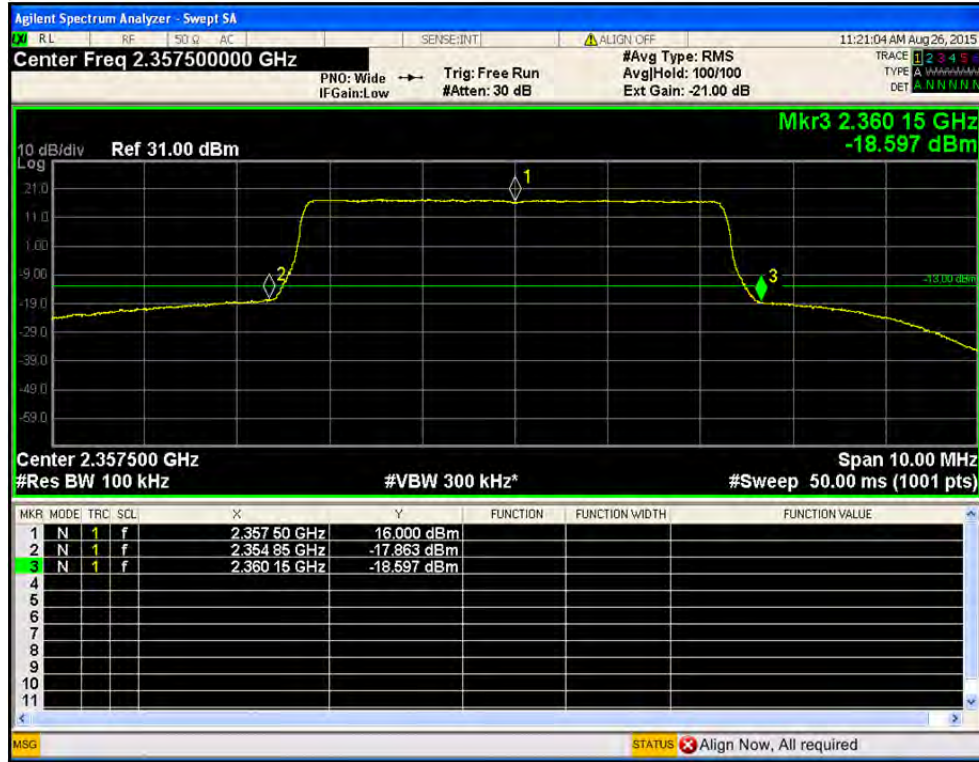

• Port2 / LTE 5 MHz / 2 357.5 MHz / 64QAM

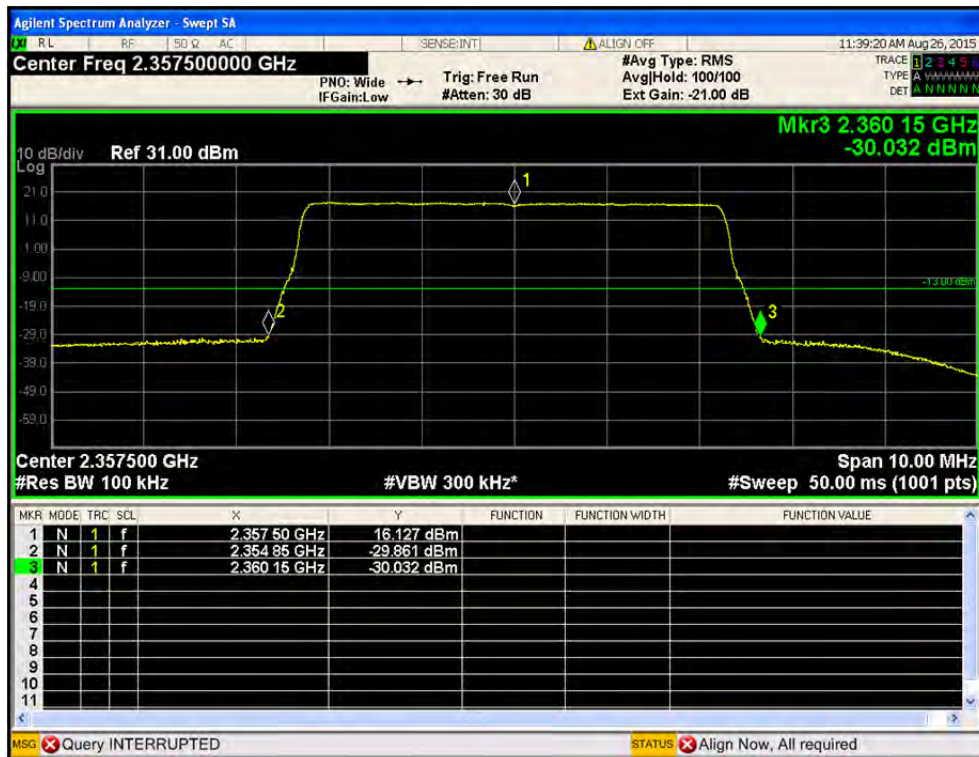

3.3 Conducted spurious emission

3.3.1 Specification

- FCC Rules Part 2.1051
- FCC Rules Part 27.53 (a)(1)

3.3.2 Test Description

The antenna port spurious emissions were measured at the RF output terminal of the EUT with external attenuation on the RF input of the spectrum analyzer. Analyzer plots utilizing a 1 MHz resolution bandwidth and no video filtering were made for each modulation type from 30 MHz to 26.5 GHz

The peak conducted power of spurious emissions, up to the 10th harmonic of the transmit frequency, were investigated to ensure they were less than or equal to the limit. Emissions close to the limit were measured using an RMS detector.

The antenna port spurious emissions were measured on port 1 and port 2 under the three types of modulation mode which are QPSK, 16QAM and 64QAM, and resource block was 50.

3.3.3 Test Procedure

The power of any emission outside of the authorized operating frequency ranges (2345 ~ 2360 MHz) must be attenuated below the transmitting power (P) by a factor of at least as specified in this section.

The EUT antenna terminal was connected to the spectrum analyzer through an external attenuator and an appropriate coaxial cable.

The evaluation was repeated for all modulations.

The evaluation was done in frequency band from 30MHz ~ 26.5GHz without band edges test.

If the DUT used in MIMO configuration according to KDB 662911, the summed emission (MIMO Max. Level) is calculated (Max. Level) of the output port plus 10 log (N_{ANT}). With (N_{ANT} =2) the MIMO Max.

Level (dBm) equals Max. Level (dBm) plus 3dB.

3.3.4 Test equipment list

Equipment	Model Name	Manufacturer
EUT	HX-WCS-MIMO	Corning Optical Communications Wireless, Inc.
Signal Generator	N5182A	Agilent
Spectrum Analyzer	N9020A	Agilent
Attenuator	PE7019-20	Pasternack
DC Power Supply	6674A	Agilent

3.3.5 Test condition

- Test place: Shield Room
- Test environment: 23.0 °C, 43 % R.H.

3.3.6 Test results

• Port1 / Spurious emissions (30 MHz ~ 26.5 GHz)

Bandwidth [MHz]	Operation frequency [MHz]	Modulation	Frequency range of spurious emission [MHz]	Level of spurious emission [dBm]	Limit [dBm]	Result
10	2 355.0	QPSK	30 to 26 500	-37.30	-13.0	Pass
		16QAM		-36.89		
		64QAM		-37.01		
5	2 352.5	QPSK	30 to 26 500	-36.93		
		16QAM		-36.93		
		64QAM		-35.91		
5	2 357.5	QPSK	30 to 26 500	-36.69		
		16QAM		-37.19		
		64QAM		-36.66		

• Port2 / Spurious emissions (30 MHz ~ 26.5 GHz)

Bandwidth [MHz]	Modulation	Operation frequency [MHz]	Frequency range of spurious emission [MHz]	Level of spurious emission [dBm]	Limit [dBm]	Result
10	2 355.0	QPSK	30 to 26 500	-36.02	-13.0	Pass
		16QAM		-36.52		
		64QAM		-36.23		
5	2 352.5	QPSK	30 to 26 500	-37.32		
		16QAM		-36.40		
		64QAM		-36.82		
5	2 357.5	QPSK	30 to 26 500	-36.93		
		16QAM		-36.79		
		64QAM		-36.74		

• Port1 / Spurious emissions

Bandwidth [MHz]	Operation frequency [MHz]	Modulation	Frequency range of spurious emission [MHz]	Level of spurious emission [dBm]	Limit [dBm]	Result
10	2 355	QPSK	2 360.0 ~ 2362.5	-23.09	-13.0	Pass
			2 362.5 ~ 2 365.0	-28.46	-25.0	
			2 365.0 ~ 2 367.5	-47.68	-40.0	
			2 367.5 ~ 2 370.0	-48.87	-42.0	
			above 2 370.0	-48.96	-45.0	
			2 320.0 ~ 2345.0	-47.59	-45.0	
			2 305.0 ~ 2 320.0	-49.06	-13.0	
			2 300.0 ~ 2 305.0	-49.09	-13.0	
			2 287.5 ~ 2 300.0	-48.67	-40.0	
			2 285.0 ~ 2 287.5	-48.96	-42.0	
		Below 2 285.0	-48.96	-45.0		
		16QAM	2 360.0 ~ 2362.5	-21.55	-13.0	
			2 362.5 ~ 2 365.0	-30.12	-25.0	
			2 365.0 ~ 2 367.5	-47.78	-40.0	
			2 367.5 ~ 2 370.0	-48.88	-42.0	
			above 2 370.0	-49.11	-45.0	
			2 320.0 ~ 2345.0	-48.13	-45.0	
			2 305.0 ~ 2 320.0	-49.01	-13.0	
			2 300.0 ~ 2 305.0	-49.07	-13.0	
			2 287.5 ~ 2 300.0	-49.00	-40.0	
			2 285.0 ~ 2 287.5	-48.86	-42.0	
		Below 2 285.0	-48.88	-45.0		
		64QAM	2 360.0 ~ 2362.5	-21.58	-13.0	
			2 362.5 ~ 2 365.0	-28.88	-25.0	
			2 365.0 ~ 2 367.5	-48.07	-40.0	
			2 367.5 ~ 2 370.0	-49.11	-42.0	
			above 2 370.0	-49.12	-45.0	
			2 320.0 ~ 2345.0	-47.87	-45.0	
			2 305.0 ~ 2 320.0	-48.93	-13.0	
			2 300.0 ~ 2 305.0	-49.00	-13.0	
2 287.5 ~ 2 300.0	-49.02		-40.0			
2 285.0 ~ 2 287.5	-48.87		-42.0			
Below 2 285.0	-48.75	-45.0				

• Port1 / Spurious emissions

Bandwidth [MHz]	Operation frequency [MHz]	Modulation	Frequency range of spurious emission [MHz]	Level of spurious emission [dBm]	Limit [dBm]	Result
5	2 352.5	QPSK	2 360.0 ~ 2362.5	-35.36	-13.0	Pass
			2 362.5 ~ 2 365.0	-33.48	-25.0	
			2 365.0 ~ 2 367.5	-48.69	-40.0	
			2 367.5 ~ 2 370.0	-48.92	-42.0	
			above 2 370.0	-48.82	-45.0	
			2 320.0 ~ 2345.0	-48.18	-45.0	
			2 305.0 ~ 2 320.0	-48.91	-13.0	
			2 300.0 ~ 2 305.0	-48.89	-13.0	
			2 287.5 ~ 2 300.0	-48.90	-40.0	
			2 285.0 ~ 2 287.5	-49.17	-42.0	
		Below 2 285.0	-49.04	-45.0		
		16QAM	2 360.0 ~ 2362.5	-34.43	-13.0	
			2 362.5 ~ 2 365.0	-33.09	-25.0	
			2 365.0 ~ 2 367.5	-48.81	-40.0	
			2 367.5 ~ 2 370.0	-48.99	-42.0	
			above 2 370.0	-49.00	-45.0	
			2 320.0 ~ 2345.0	-48.34	-45.0	
			2 305.0 ~ 2 320.0	-49.03	-13.0	
			2 300.0 ~ 2 305.0	-49.00	-13.0	
			2 287.5 ~ 2 300.0	-48.94	-40.0	
			2 285.0 ~ 2 287.5	-48.90	-42.0	
		Below 2 285.0	-48.94	-45.0		
		64QAM	2 360.0 ~ 2362.5	-34.53	-13.0	
			2 362.5 ~ 2 365.0	-32.79	-25.0	
			2 365.0 ~ 2 367.5	-48.76	-40.0	
			2 367.5 ~ 2 370.0	-49.06	-42.0	
			above 2 370.0	-49.11	-45.0	
			2 320.0 ~ 2345.0	-48.15	-45.0	
			2 305.0 ~ 2 320.0	-48.98	-13.0	
			2 300.0 ~ 2 305.0	-48.88	-13.0	
			2 287.5 ~ 2 300.0	-49.02	-40.0	
			2 285.0 ~ 2 287.5	-49.14	-42.0	
		Below 2 285.0	-49.15	-45.0		

• Port1 / Spurious emissions

Bandwidth [MHz]	Operation frequency [MHz]	Modulation	Frequency range of spurious emission [MHz]	Level of spurious emission [dBm]	Limit [dBm]	Result
5	2 357.5	QPSK	2 360.0 ~ 2362.5	-15.44	-13.0	Pass
			2 362.5 ~ 2 365.0	-30.95	-25.0	
			2 365.0 ~ 2 367.5	-48.51	-40.0	
			2 367.5 ~ 2 370.0	-48.79	-42.0	
			above 2 370.0	-48.91	-45.0	
			2 320.0 ~ 2345.0	-48.69	-45.0	
			2 305.0 ~ 2 320.0	-49.00	-13.0	
			2 300.0 ~ 2 305.0	-48.97	-13.0	
			2 287.5 ~ 2 300.0	-49.02	-40.0	
			2 285.0 ~ 2 287.5	-49.19	-42.0	
		Below 2 285.0	-49.15	-45.0		
		16QAM	2 360.0 ~ 2362.5	-16.32	-13.0	
			2 362.5 ~ 2 365.0	-33.09	-25.0	
			2 365.0 ~ 2 367.5	-48.81	-40.0	
			2 367.5 ~ 2 370.0	-48.99	-42.0	
			above 2 370.0	-49.00	-45.0	
			2 320.0 ~ 2345.0	-48.34	-45.0	
			2 305.0 ~ 2 320.0	-49.03	-13.0	
			2 300.0 ~ 2 305.0	-49.00	-13.0	
			2 287.5 ~ 2 300.0	-48.94	-40.0	
			2 285.0 ~ 2 287.5	-48.90	-42.0	
		Below 2 285.0	-48.94	-45.0		
		64QAM	2 360.0 ~ 2362.5	-13.86	-13.0	
			2 362.5 ~ 2 365.0	-26.91	-25.0	
			2 365.0 ~ 2 367.5	-48.14	-40.0	
			2 367.5 ~ 2 370.0	-48.78	-42.0	
			above 2 370.0	-48.96	-45.0	
			2 320.0 ~ 2345.0	-48.48	-45.0	
			2 305.0 ~ 2 320.0	-48.93	-13.0	
			2 300.0 ~ 2 305.0	-49.06	-13.0	
2 287.5 ~ 2 300.0	-48.92		-40.0			
2 285.0 ~ 2 287.5	-49.11		-42.0			
Below 2 285.0	-49.29	-45.0				

• Port2 / Spurious emissions

Bandwidth [MHz]	Operation frequency [MHz]	Modulation	Frequency range of spurious emission [MHz]	Level of spurious emission [dBm]	Limit [dBm]	Result
10	2 355	QPSK	2 360.0 ~ 2362.5	-23.23	-13.0	Pass
			2 362.5 ~ 2 365.0	-30.75	-25.0	
			2 365.0 ~ 2 367.5	-48.24	-40.0	
			2 367.5 ~ 2 370.0	-48.66	-42.0	
			above 2 370.0	-48.90	-45.0	
			2 320.0 ~ 2345.0	-47.51	-45.0	
			2 305.0 ~ 2 320.0	-48.91	-13.0	
			2 300.0 ~ 2 305.0	-48.82	-13.0	
			2 287.5 ~ 2 300.0	-48.74	-40.0	
			2 285.0 ~ 2 287.5	-48.85	-42.0	
		Below 2 285.0	-49.02	-45.0		
		16QAM	2 360.0 ~ 2362.5	-22.02	-13.0	
			2 362.5 ~ 2 365.0	-31.63	-25.0	
			2 365.0 ~ 2 367.5	-48.04	-40.0	
			2 367.5 ~ 2 370.0	-48.55	-42.0	
			above 2 370.0	-48.44	-45.0	
			2 320.0 ~ 2345.0	-47.91	-45.0	
			2 305.0 ~ 2 320.0	-48.67	-13.0	
			2 300.0 ~ 2 305.0	-48.71	-13.0	
			2 287.5 ~ 2 300.0	-48.75	-40.0	
			2 285.0 ~ 2 287.5	-48.82	-42.0	
		Below 2 285.0	-48.75	-45.0		
		64QAM	2 360.0 ~ 2362.5	-21.94	-13.0	
			2 362.5 ~ 2 365.0	-29.75	-25.0	
			2 365.0 ~ 2 367.5	-47.89	-40.0	
			2 367.5 ~ 2 370.0	-48.52	-42.0	
			above 2 370.0	-48.71	-45.0	
			2 320.0 ~ 2345.0	-47.87	-45.0	
			2 305.0 ~ 2 320.0	-48.84	-13.0	
			2 300.0 ~ 2 305.0	-48.74	-13.0	
2 287.5 ~ 2 300.0	-48.77		-40.0			
2 285.0 ~ 2 287.5	-48.70		-42.0			
Below 2 285.0	-48.84	-45.0				

• Port2 / Spurious emissions

Bandwidth [MHz]	Operation frequency [MHz]	Modulation	Frequency range of spurious emission [MHz]	Level of spurious emission [dBm]	Limit [dBm]	Result
5	2 352.5	QPSK	2 360.0 ~ 2362.5	-33.76	-13.0	Pass
			2 362.5 ~ 2 365.0	-32.82	-25.0	
			2 365.0 ~ 2 367.5	-48.80	-40.0	
			2 367.5 ~ 2 370.0	-48.91	-42.0	
			above 2 370.0	-49.08	-45.0	
			2 320.0 ~ 2345.0	-47.43	-45.0	
			2 305.0 ~ 2 320.0	-49.09	-13.0	
			2 300.0 ~ 2 305.0	-49.01	-13.0	
			2 287.5 ~ 2 300.0	-48.74	-40.0	
			2 285.0 ~ 2 287.5	-49.14	-42.0	
		Below 2 285.0	-49.16	-45.0		
		16QAM	2 360.0 ~ 2362.5	-31.01	-13.0	
			2 362.5 ~ 2 365.0	-32.31	-25.0	
			2 365.0 ~ 2 367.5	-48.95	-40.0	
			2 367.5 ~ 2 370.0	-49.01	-42.0	
			above 2 370.0	-49.17	-45.0	
			2 320.0 ~ 2345.0	-46.40	-45.0	
			2 305.0 ~ 2 320.0	-49.05	-13.0	
			2 300.0 ~ 2 305.0	-48.97	-13.0	
			2 287.5 ~ 2 300.0	-48.76	-40.0	
			2 285.0 ~ 2 287.5	-49.17	-42.0	
		Below 2 285.0	-49.19	-45.0		
		64QAM	2 360.0 ~ 2362.5	-34.26	-13.0	
			2 362.5 ~ 2 365.0	-33.33	-25.0	
			2 365.0 ~ 2 367.5	-48.76	-40.0	
			2 367.5 ~ 2 370.0	-49.02	-42.0	
			above 2 370.0	-49.06	-45.0	
			2 320.0 ~ 2345.0	-47.65	-45.0	
			2 305.0 ~ 2 320.0	-48.99	-13.0	
			2 300.0 ~ 2 305.0	-48.98	-13.0	
			2 287.5 ~ 2 300.0	-49.06	-40.0	
			2 285.0 ~ 2 287.5	-49.07	-42.0	
		Below 2 285.0	-48.93	-45.0		

• Port2 / Spurious emissions

Bandwidth [MHz]	Operation frequency [MHz]	Modulation	Frequency range of spurious emission [MHz]	Level of spurious emission [dBm]	Limit [dBm]	Result
5	2 357.5	QPSK	2 360.0 ~ 2362.5	-14.74	-13.0	Pass
			2 362.5 ~ 2 365.0	-32.10	-25.0	
			2 365.0 ~ 2 367.5	-48.55	-40.0	
			2 367.5 ~ 2 370.0	-48.91	-42.0	
			above 2 370.0	-49.00	-45.0	
			2 320.0 ~ 2345.0	-48.00	-45.0	
			2 305.0 ~ 2 320.0	-48.98	-13.0	
			2 300.0 ~ 2 305.0	-49.07	-13.0	
			2 287.5 ~ 2 300.0	-49.02	-40.0	
			2 285.0 ~ 2 287.5	-49.16	-42.0	
		Below 2 285.0	-49.06	-45.0		
		16QAM	2 360.0 ~ 2362.5	-14.69	-13.0	
			2 362.5 ~ 2 365.0	-28.45	-25.0	
			2 365.0 ~ 2 367.5	-48.45	-40.0	
			2 367.5 ~ 2 370.0	-48.69	-42.0	
			above 2 370.0	-49.05	-45.0	
			2 320.0 ~ 2345.0	-48.23	-45.0	
			2 305.0 ~ 2 320.0	-49.08	-13.0	
			2 300.0 ~ 2 305.0	-48.93	-13.0	
			2 287.5 ~ 2 300.0	-49.04	-40.0	
			2 285.0 ~ 2 287.5	-49.09	-42.0	
		Below 2 285.0	-49.19	-45.0		
		64QAM	2 360.0 ~ 2362.5	-16.93	-13.0	
			2 362.5 ~ 2 365.0	-31.11	-25.0	
			2 365.0 ~ 2 367.5	-48.52	-40.0	
			2 367.5 ~ 2 370.0	-48.76	-42.0	
			above 2 370.0	-48.92	-45.0	
			2 320.0 ~ 2345.0	-48.28	-45.0	
			2 305.0 ~ 2 320.0	-49.05	-13.0	
			2 300.0 ~ 2 305.0	-48.97	-13.0	
			2 287.5 ~ 2 300.0	-49.17	-40.0	
			2 285.0 ~ 2 287.5	-49.04	-42.0	
		Below 2 285.0	-49.24	-45.0		

3.3.7 Plots of spurious emissions

- Port1 / LTE 10 MHz / 2 355 MHz / QPSK / 30 MHz ~ 26.5 GHz



- Port1 / LTE 10MHz / 2 355 MHz / 16QAM / 30 MHz ~ 26.5 GHz



- Port1 / LTE 10 MHz / 2 355 MHz / 64QAM / 30 MHz ~ 26.5 GHz

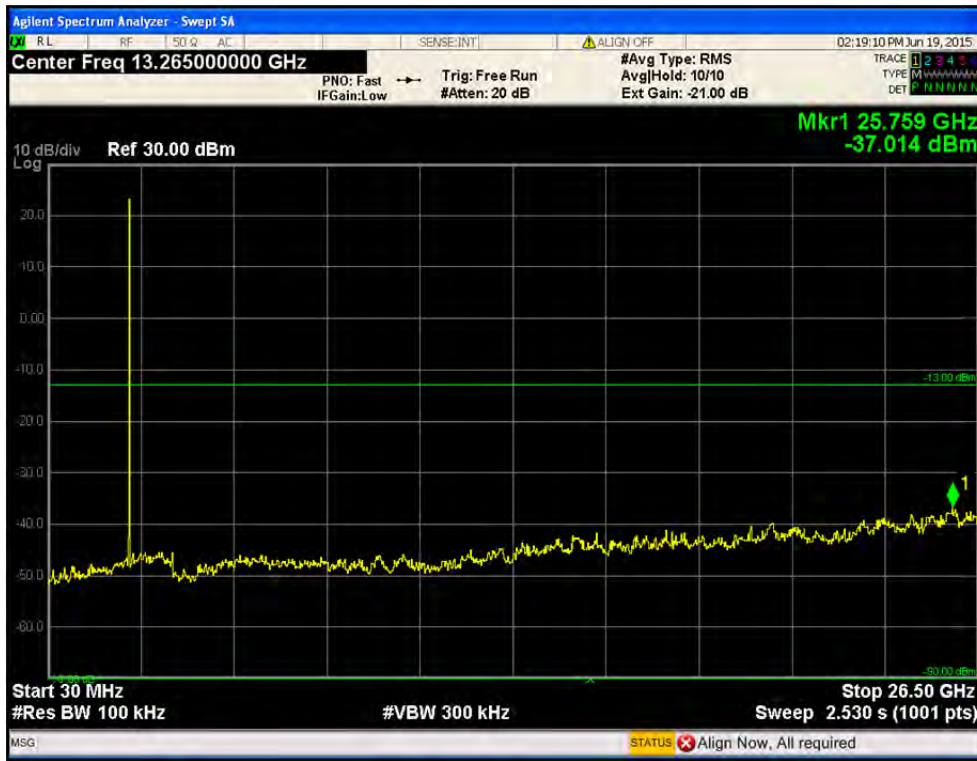

- Port1 / LTE 5 MHz / 2 352.5 MHz / QPSK / 30 MHz ~ 26.5 GHz



- Port1 / LTE 5 MHz / 2 352.5 MHz / 16QAM / 30 MHz ~ 26.5 GHz

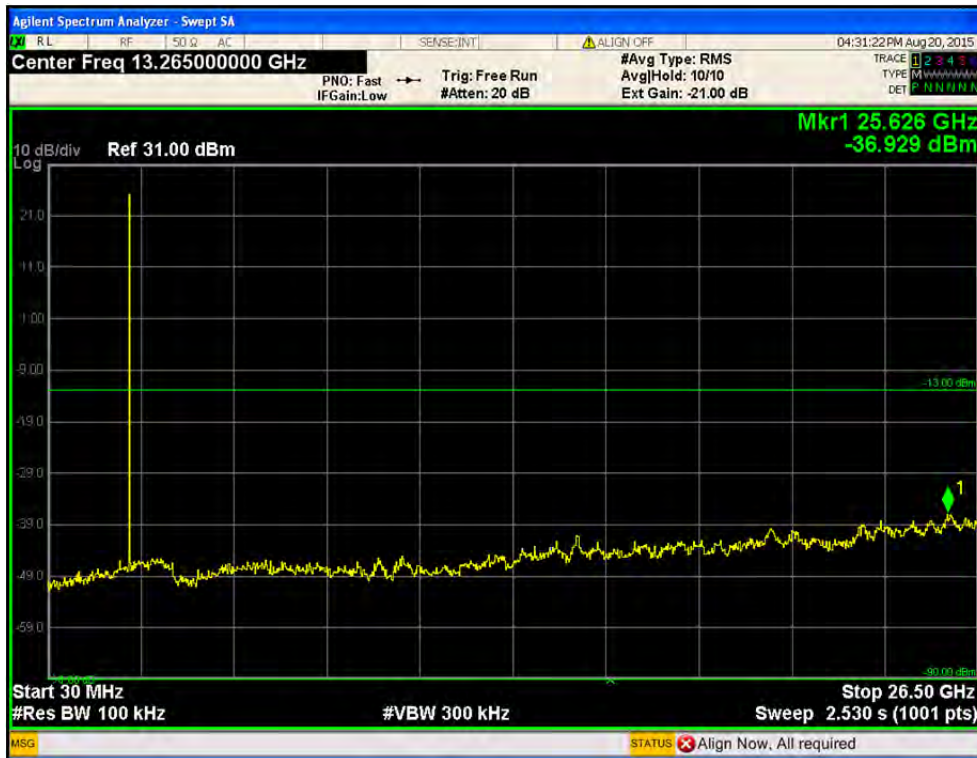

- Port1 / LTE 5 MHz / 2 352.5 MHz / 64QAM / 30 MHz ~ 26.5 GHz



- Port1 / LTE 5 MHz / 2 357.5 MHz / QPSK / 30 MHz ~ 26.5 GHz



- Port1 / LTE 5 MHz / 2 357.5 MHz / 16QAM / 30 MHz ~ 26.5 GHz

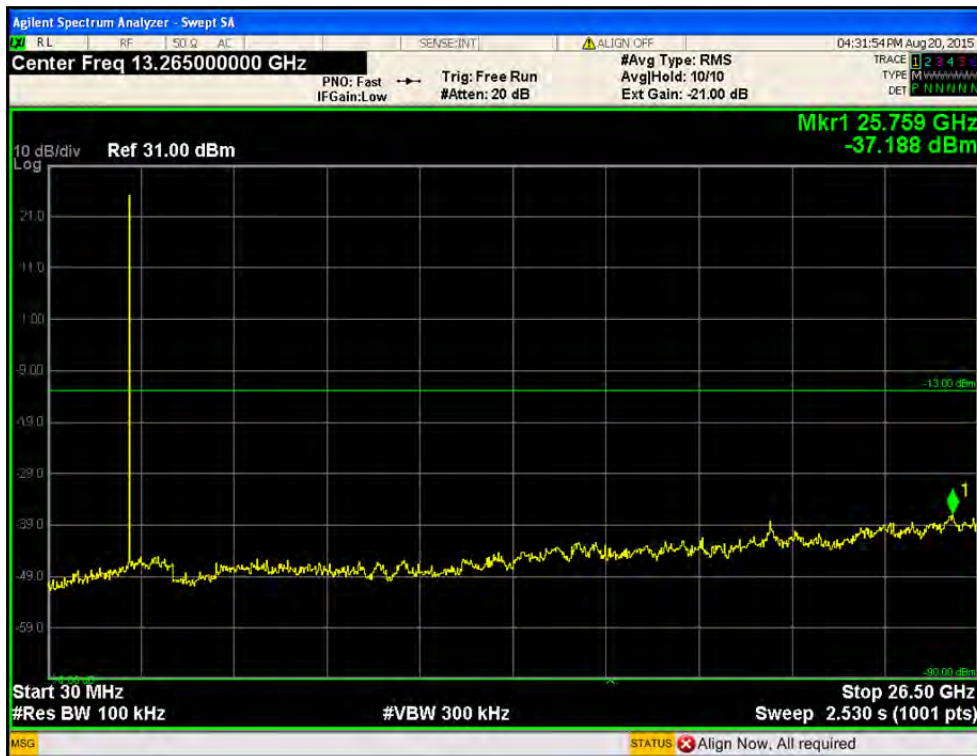

- Port1 / LTE 5 MHz / 2 357.5 MHz / 64QAM / 30 MHz ~ 26.5 GHz

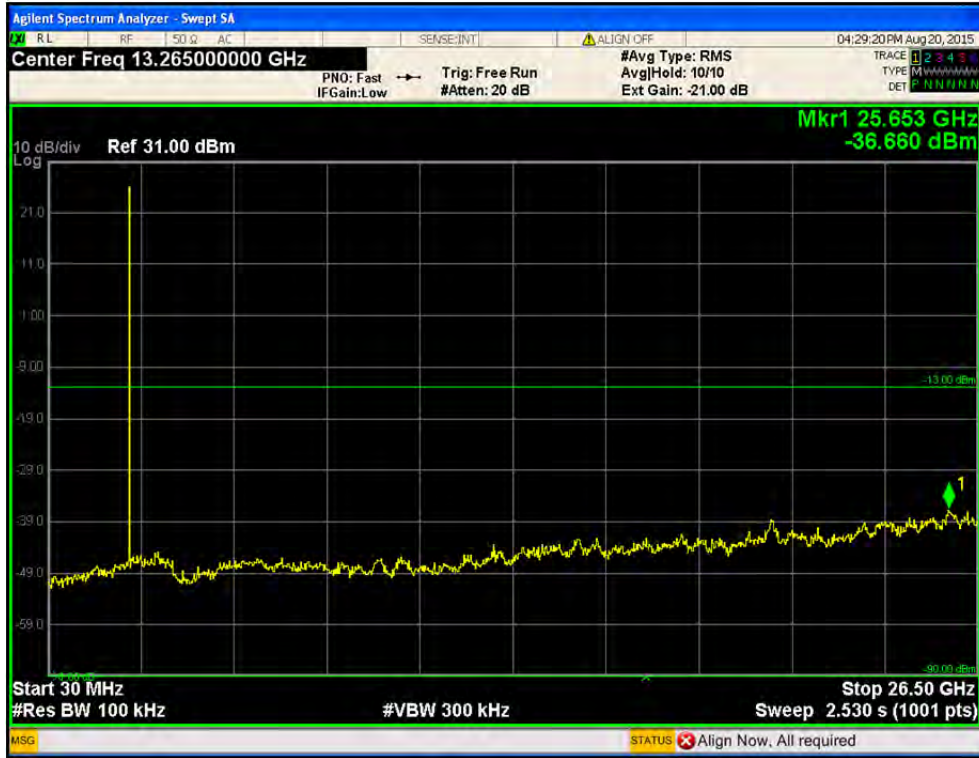

- Port1 / LTE 10 MHz / 2 355 MHz / QPSK / 2360.0 MHz ~ 2362.5 MHz



- Port1 / LTE 10 MHz / 2 355 MHz / QPSK / 2 362.5 MHz ~ 2365.0 MHz



- Port1 / LTE 10 MHz / 2 355 MHz / QPSK / 2365.0 MHz ~ 2367.5 MHz

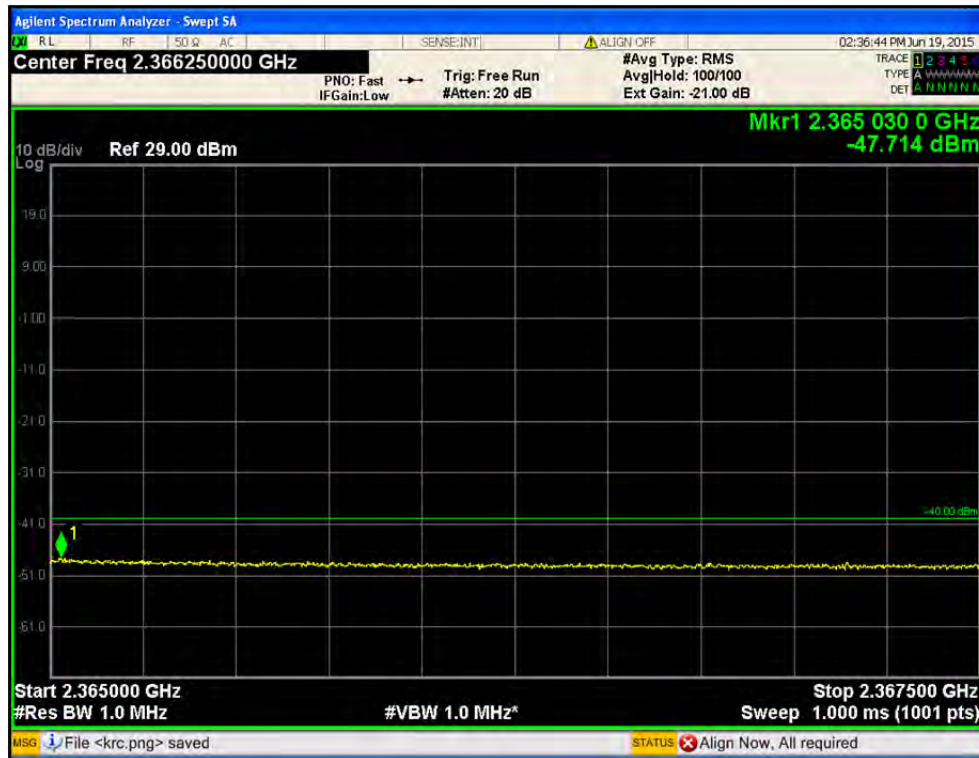

- Port1 / LTE 10 MHz / 2 355 MHz / QPSK / 2 367.5 MHz ~ 2370.0 MHz

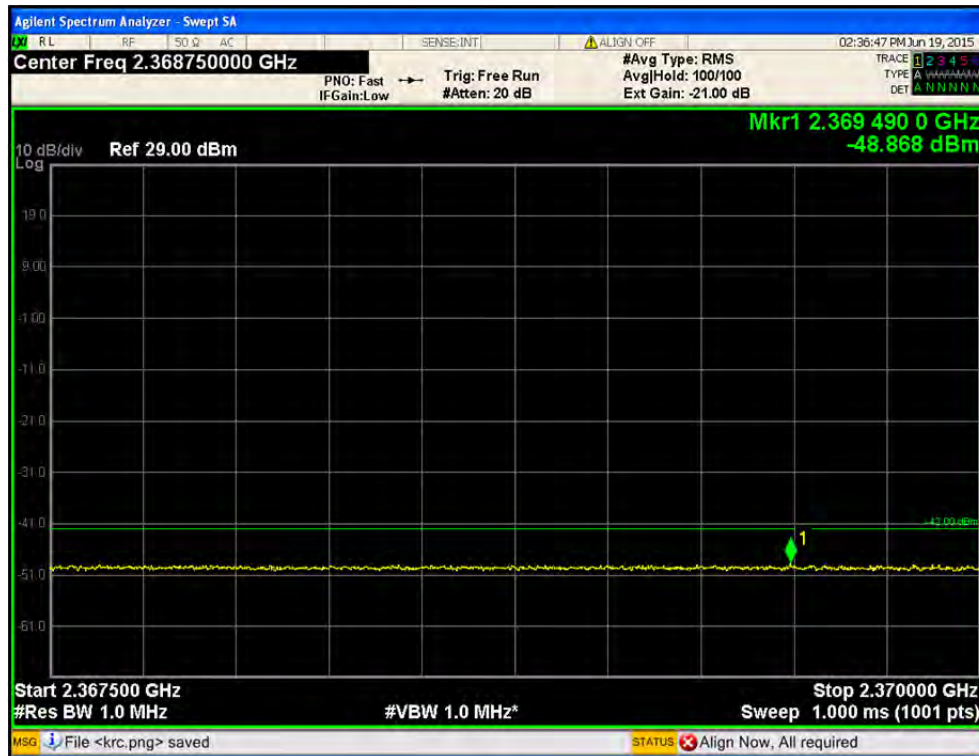

- Port1 / LTE 10 MHz / 2 355 MHz / QPSK / above 2 370.0 MHz

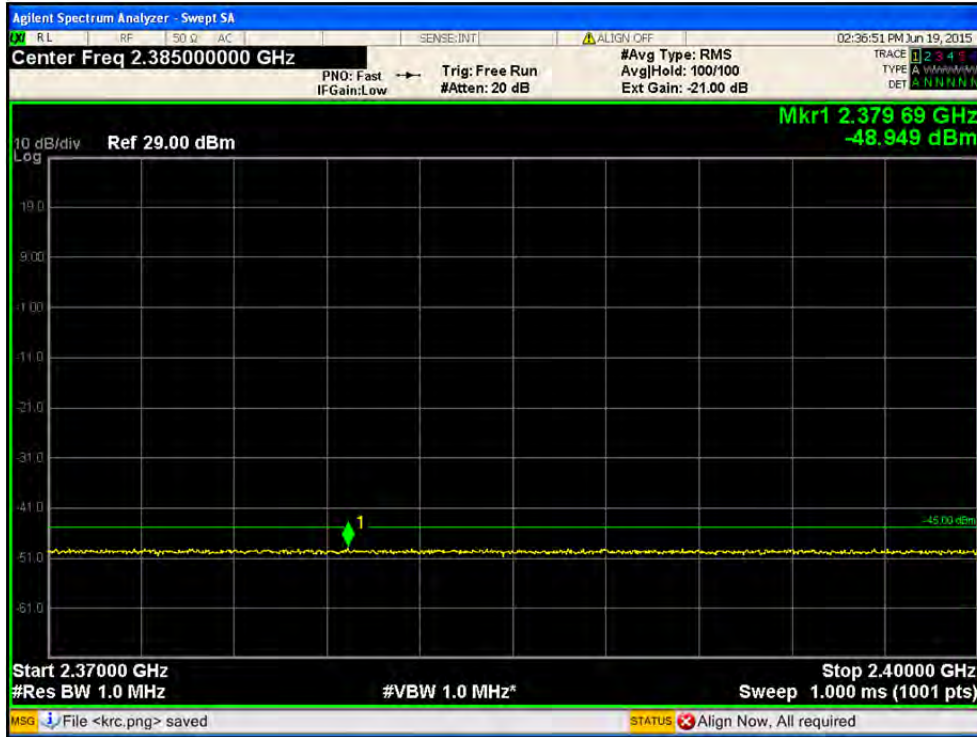

- Port1 / LTE 10 MHz / 2 355 MHz / QPSK / 2 320.0 MHz ~ 2345.0 MHz

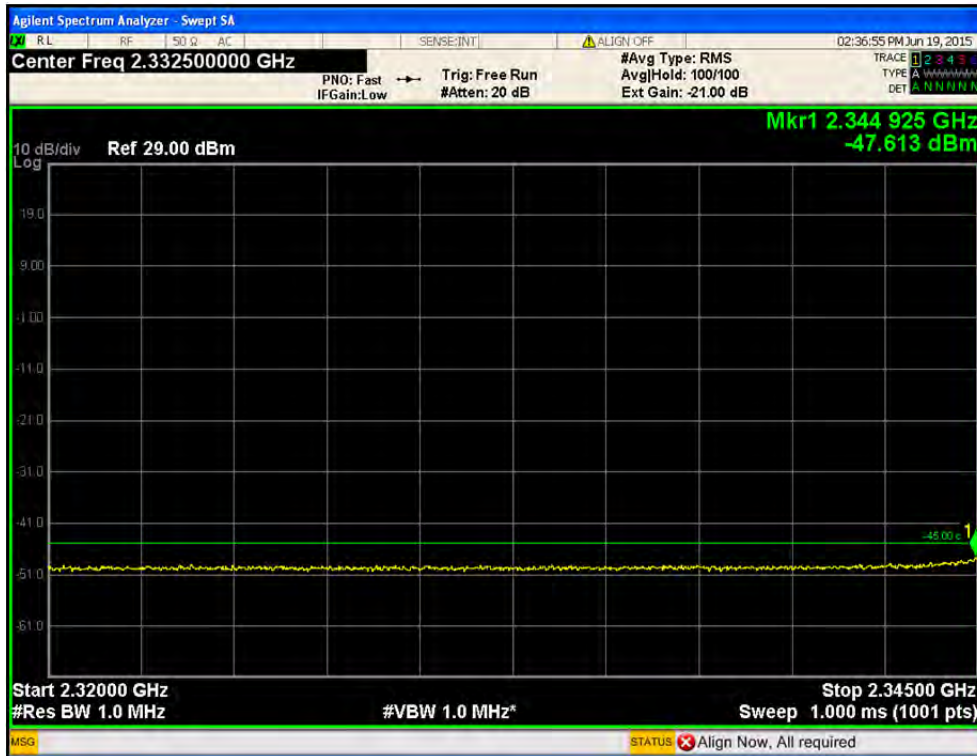

- Port1 / LTE 10 MHz / 2 355 MHz / QPSK / 2 305.0 MHz ~ 2 320.0 MHz

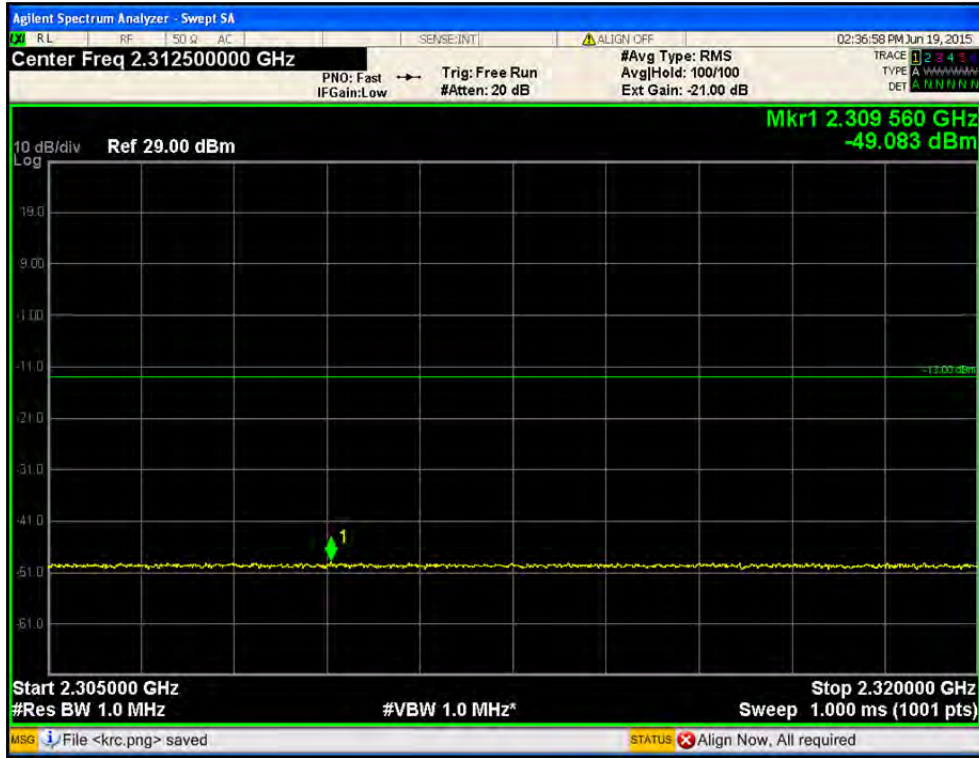

- Port1 / LTE 10 MHz / 2 355 MHz / QPSK / 2 300.0 MHz ~ 2305.0 MHz

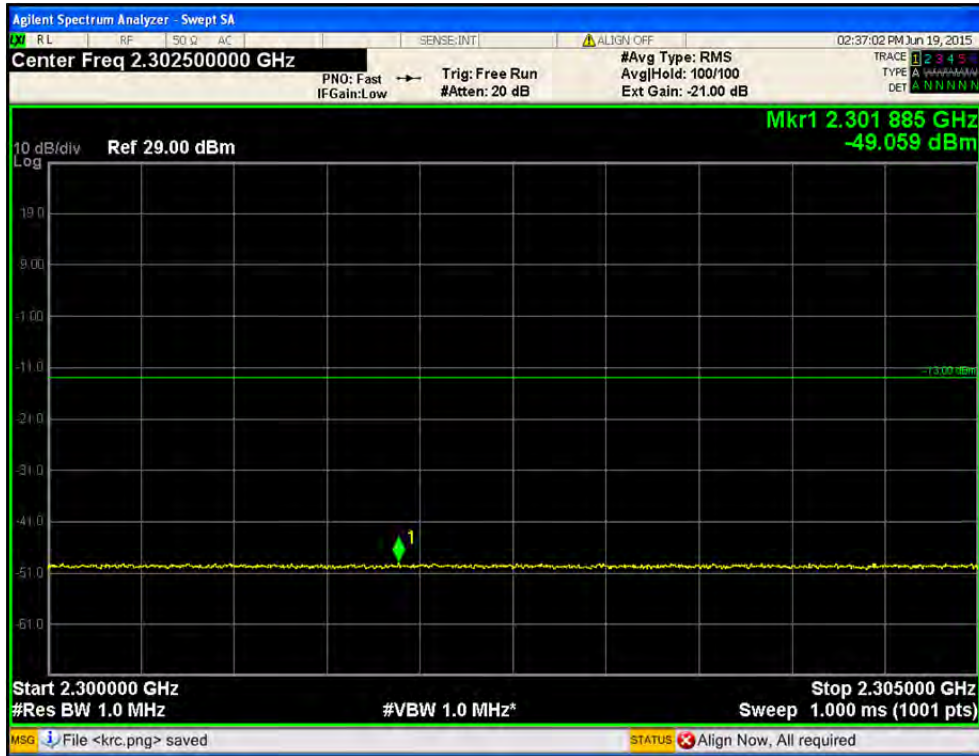

- Port1 / LTE 10 MHz / 2 355 MHz / QPSK / 2 287.5 MHz ~ 2 300.0 MHz

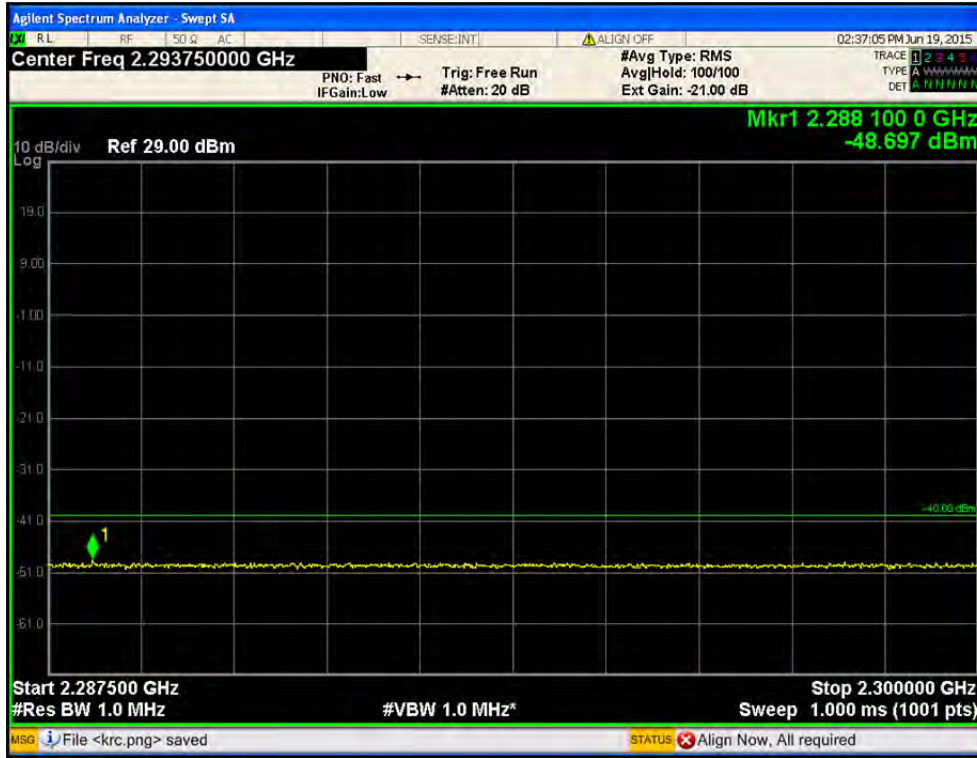

- Port1 / LTE 10 MHz / 2 355 MHz / QPSK / 2 285.0 MHz ~ 2 287.5 MHz

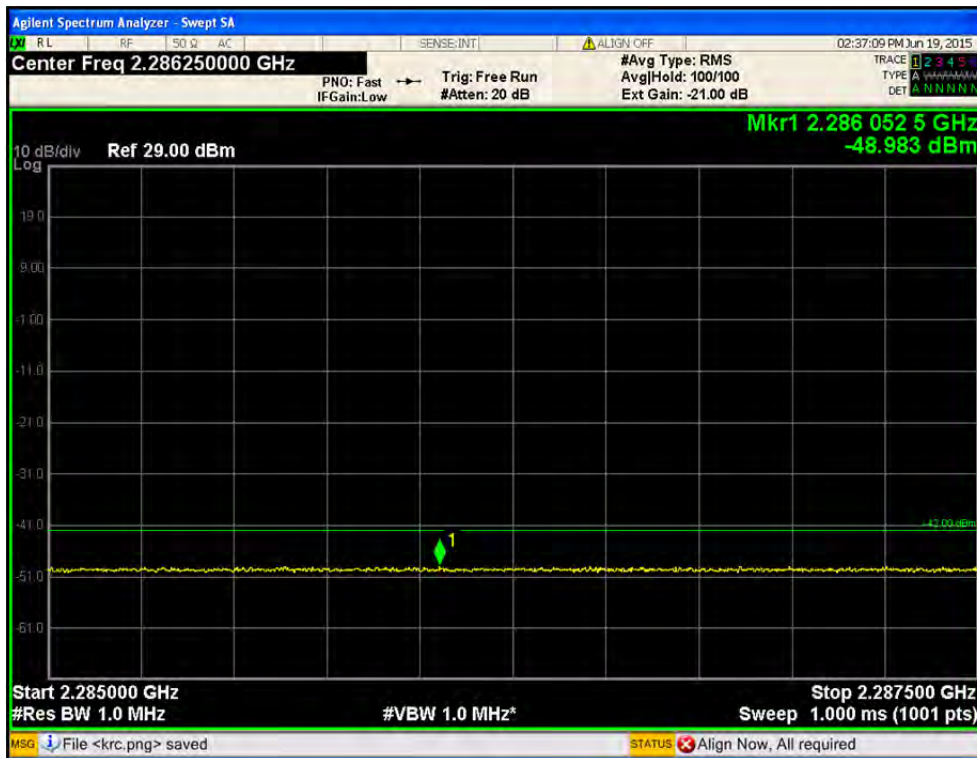

- Port1 / LTE 10 MHz / 2 355 MHz / QPSK / below 2 285.0 MHz

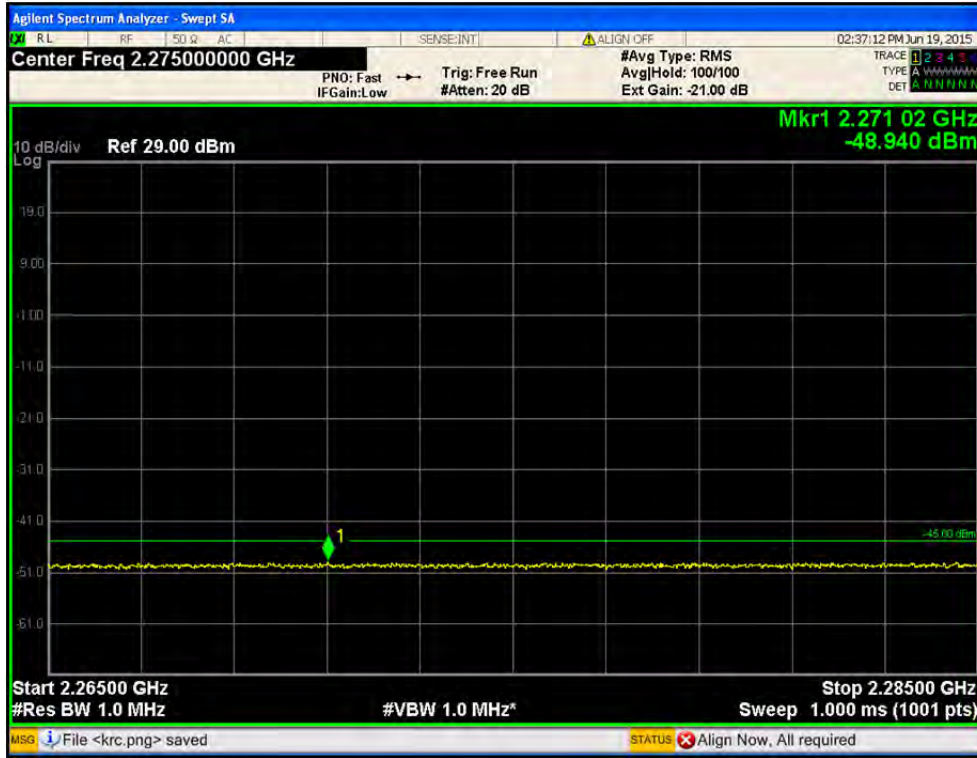

- Port1 / LTE 10 MHz / 2 355 MHz / 16QAM / 2360.0 MHz ~ 2362.5 MHz



- Port1 / LTE 10 MHz / 2 355 MHz / 16QAM / 2 362.5 MHz ~ 2365.0 MHz



- Port1 / LTE 10 MHz / 2 355 MHz / 16QAM / 2365.0 MHz ~ 2367.5 MHz

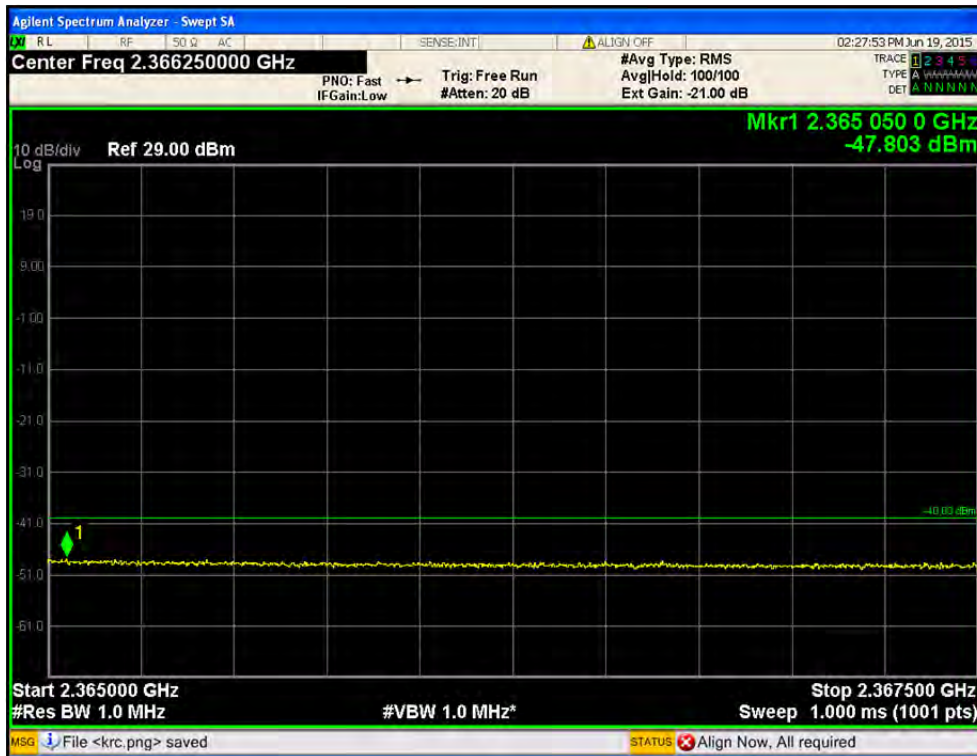

- Port1 / LTE 10 MHz / 2 355 MHz / 16QAM / 2 367.5 MHz ~ 2370.0 MHz

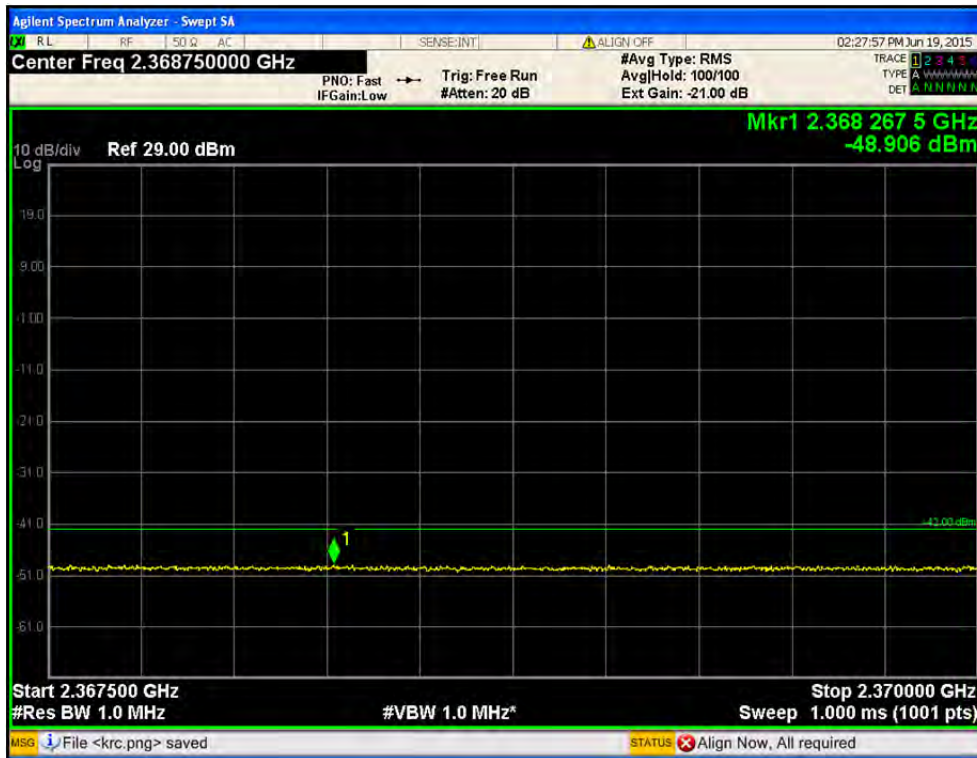

- Port1 / LTE 10 MHz / 2 355 MHz / 16QAM / above 2 370.0 MHz

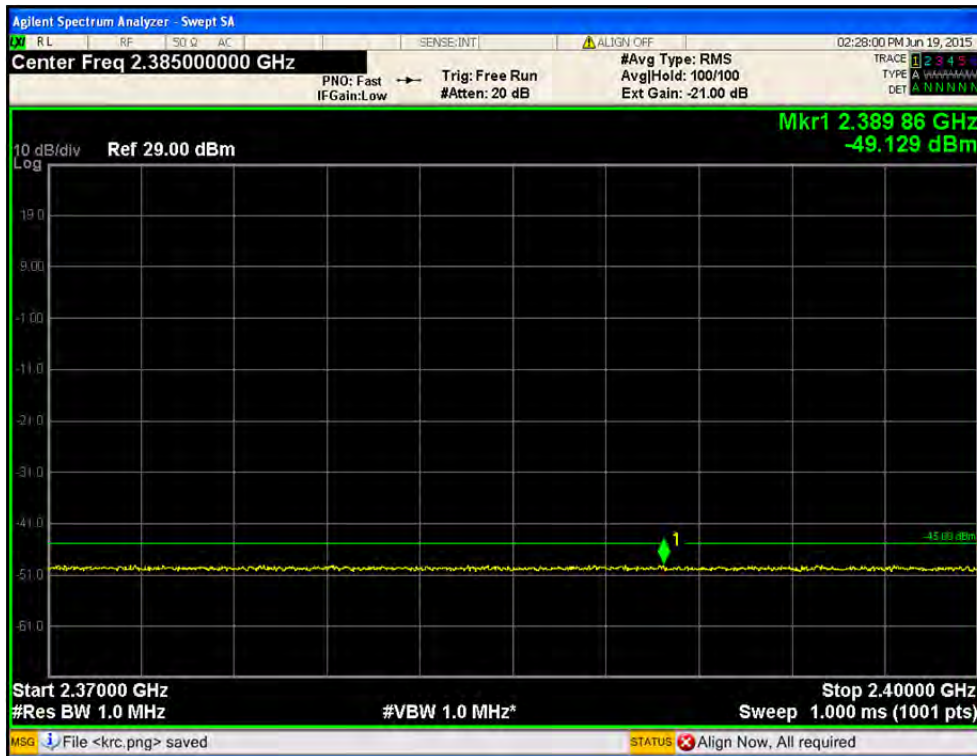

- Port1 / LTE 10 MHz / 2 355 MHz / 16QAM / 2 320.0 MHz ~ 2345.0 MHz

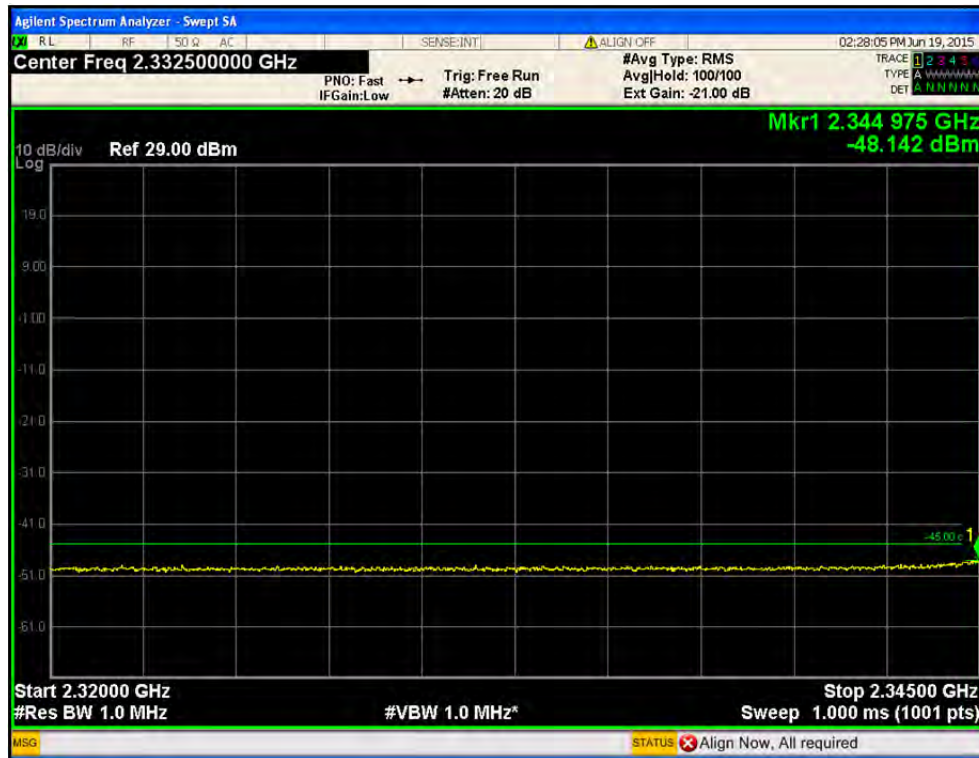

- Port1 / LTE 10 MHz / 2 355 MHz / 16QAM / 2 305.0 MHz ~ 2 320.0 MHz

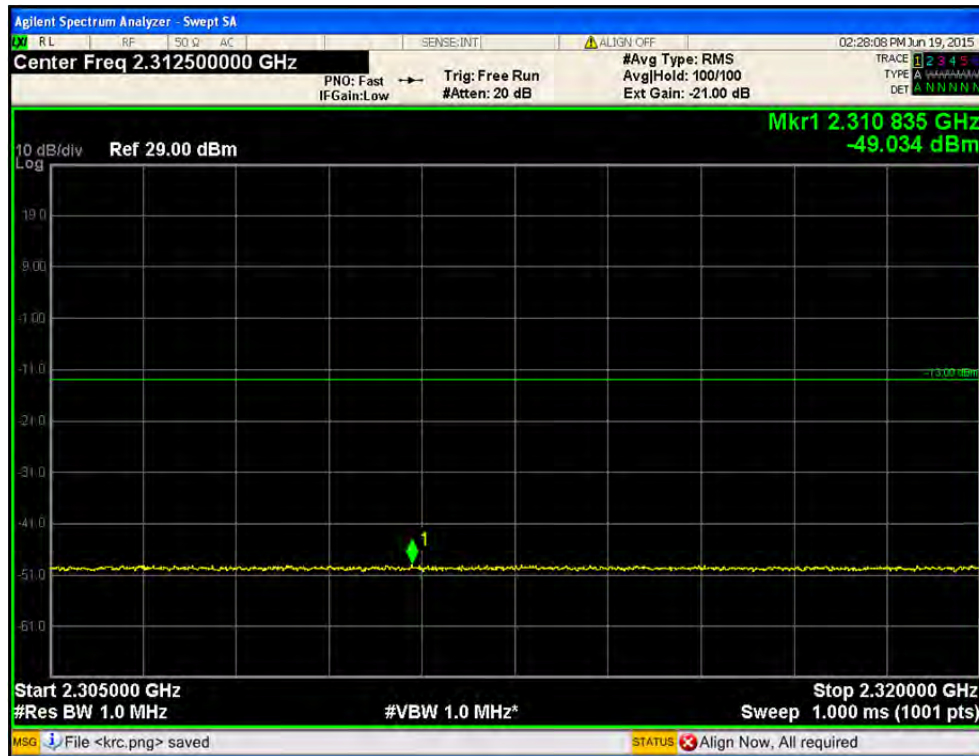

- Port1 / LTE 10 MHz / 2 355 MHz / 16QAM / 2 300.0 MHz ~ 2305.0 MHz

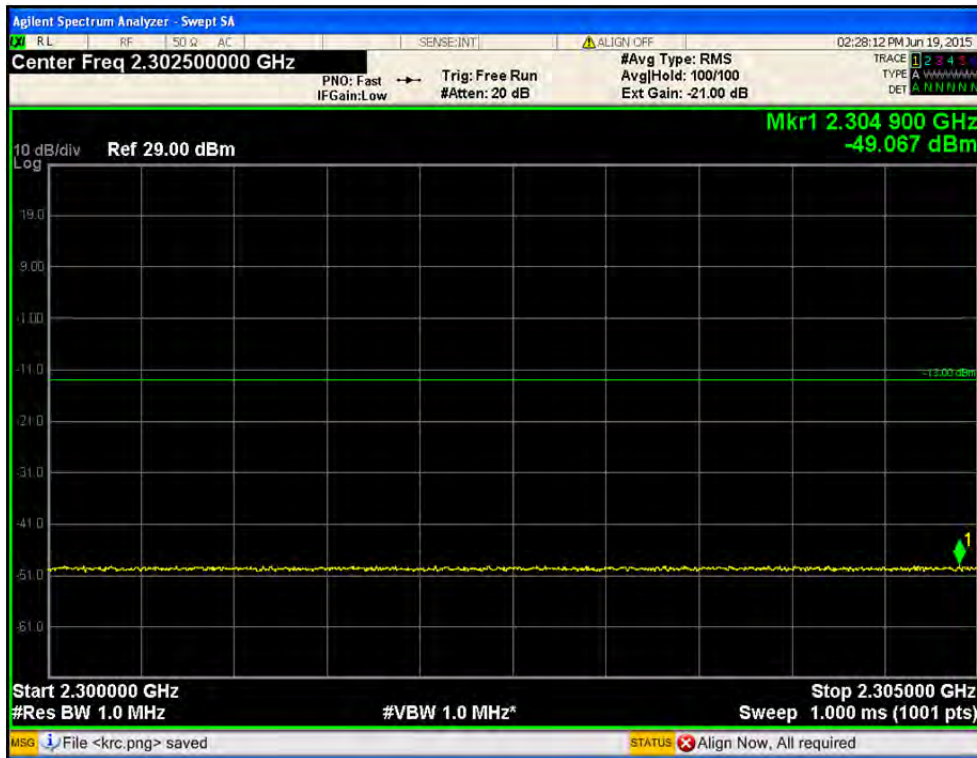

- Port1 / LTE 10 MHz / 2 355 MHz / 16QAM / 2 287.5 MHz ~ 2 300.0 MHz

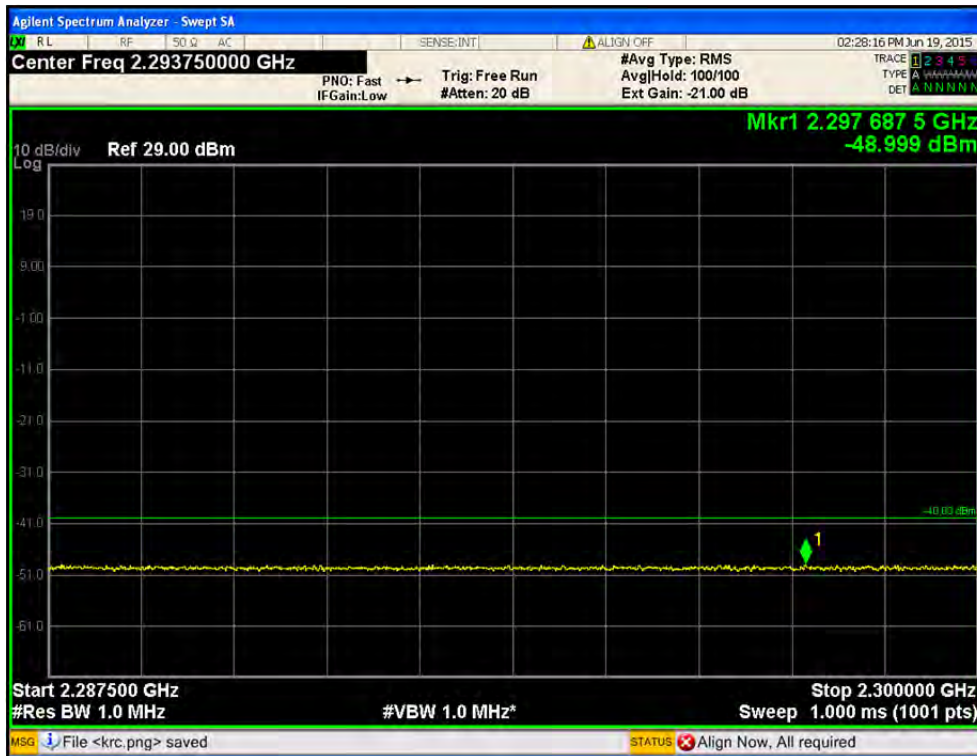

- Port1 / LTE 10 MHz / 2 355 MHz / 16QAM / 2 285.0 MHz ~ 2 287.5 MHz

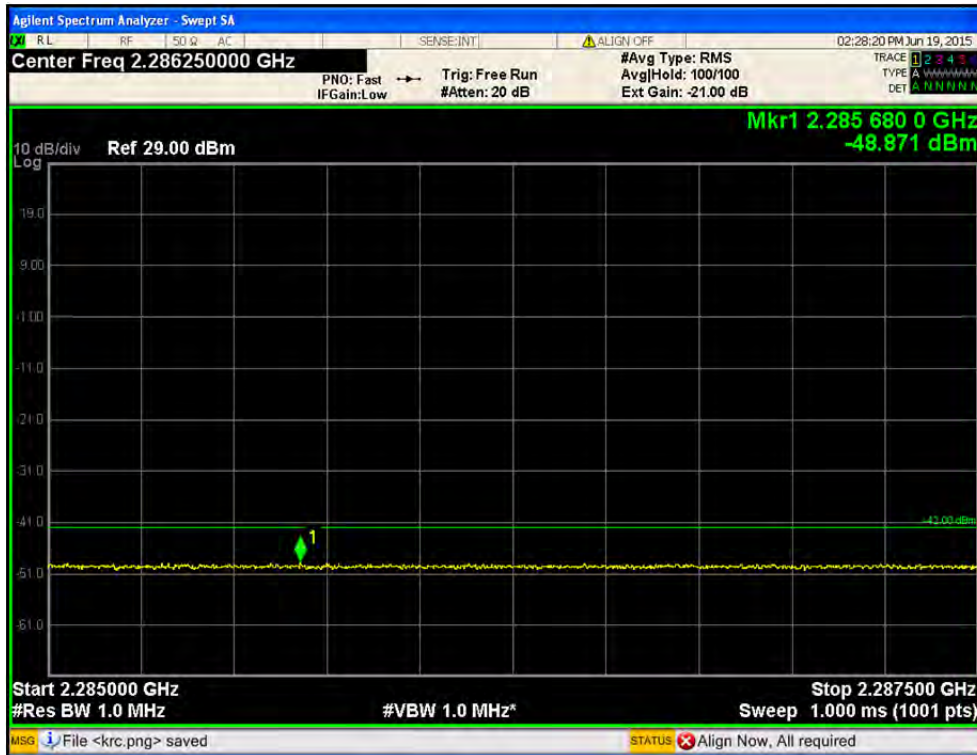

- Port1 / LTE 10 MHz / 2 355 MHz / 16QAM / below 2 285.0 MHz

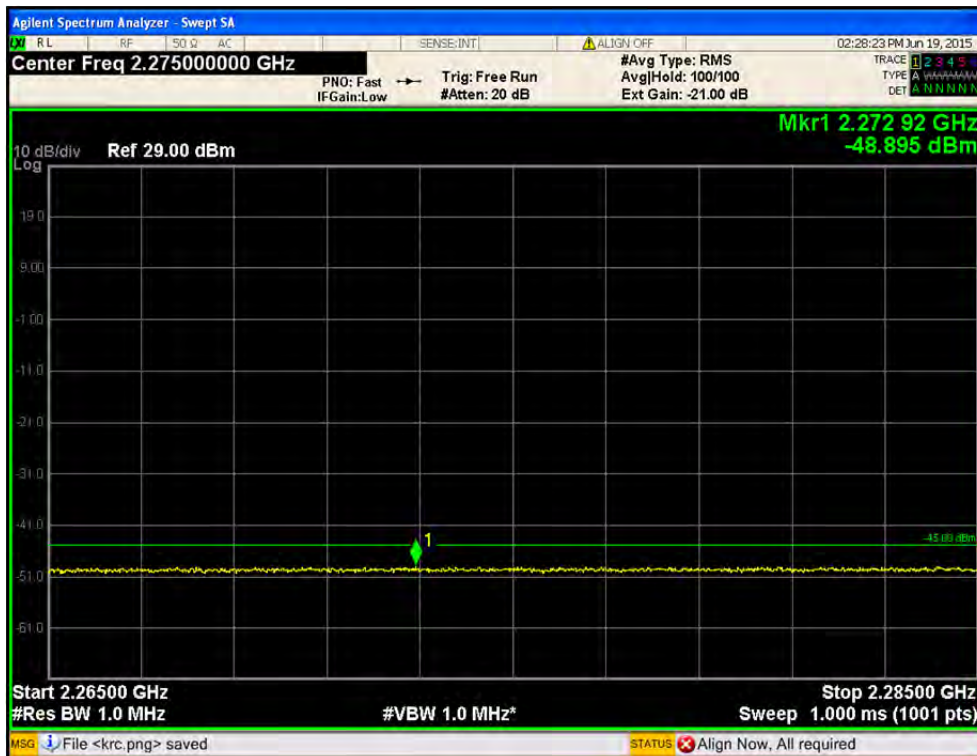

- Port1 / LTE 10 MHz / 2 355 MHz / 64QAM / 2360.0 MHz ~ 2362.5 MHz



- Port1 / LTE 10 MHz / 2 355 MHz / 64QAM / 2 362.5 MHz ~ 2365.0 MHz



- Port1 / LTE 10 MHz / 2 355 MHz / 64QAM / 2365.0 MHz ~ 2367.5 MHz

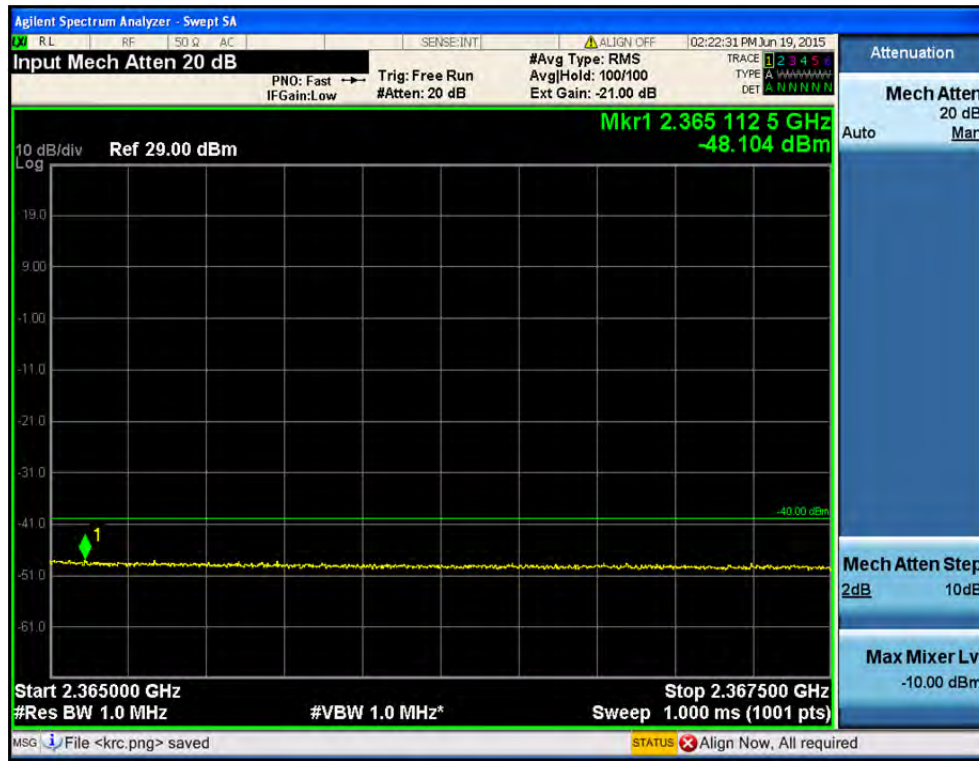

- Port1 / LTE 10 MHz / 2 355 MHz / 64QAM / 2 367.5 MHz ~ 2370.0 MHz

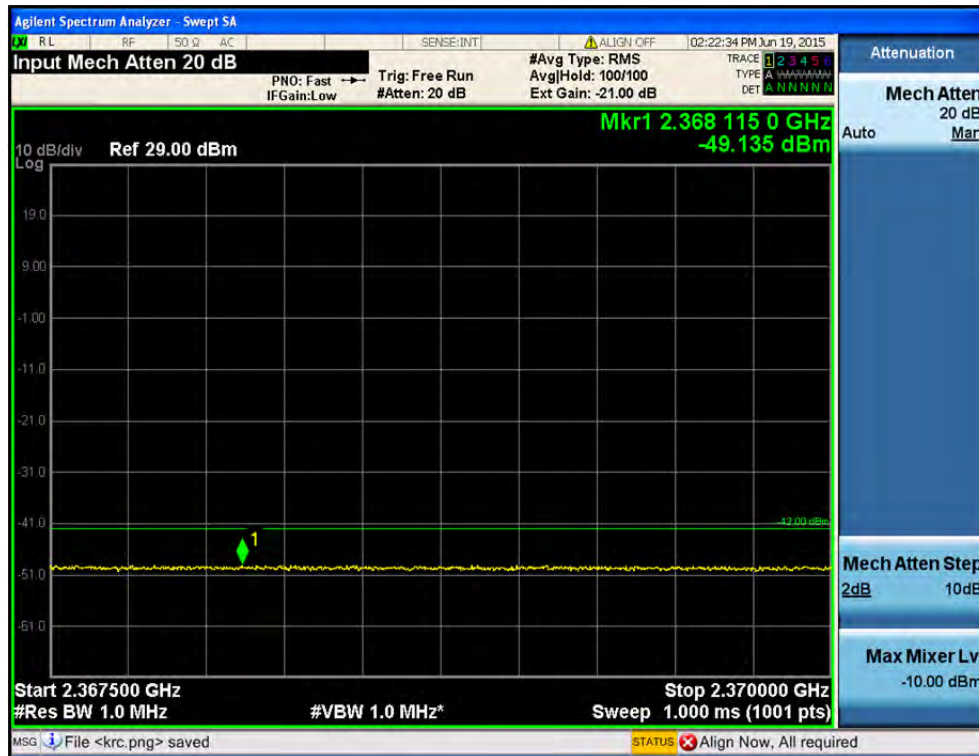

- Port1 / LTE 10 MHz / 2 355 MHz / 64QAM / above 2 370.0 MHz

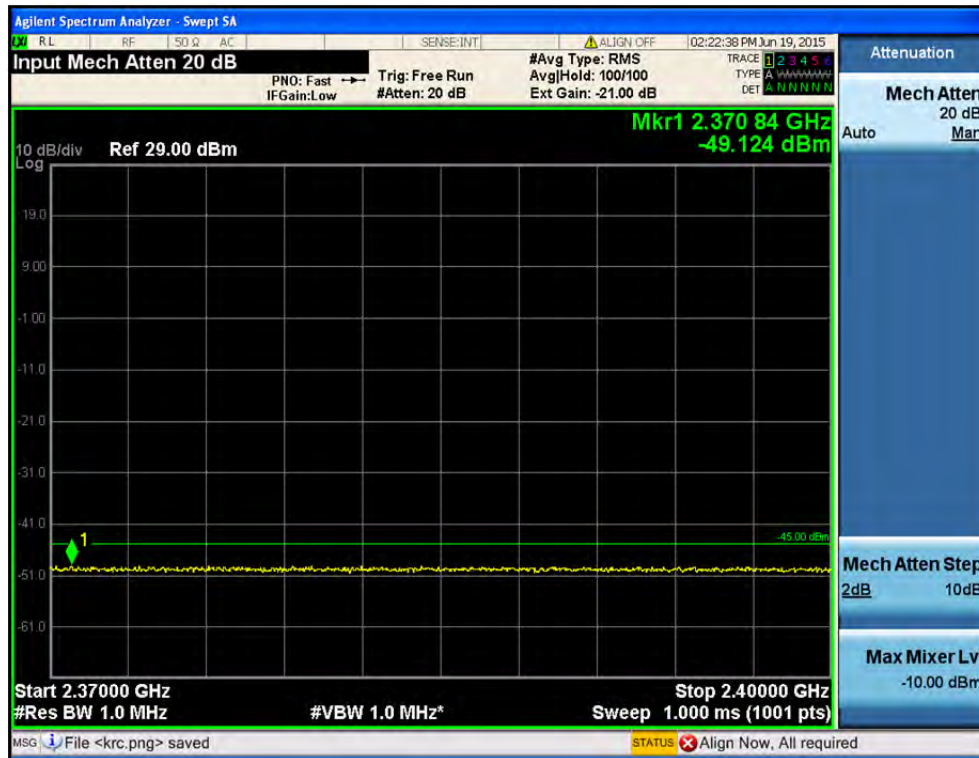

- Port1 / LTE 10 MHz / 2 355 MHz / 64QAM / 2 320.0 MHz ~ 2345.0 MHz

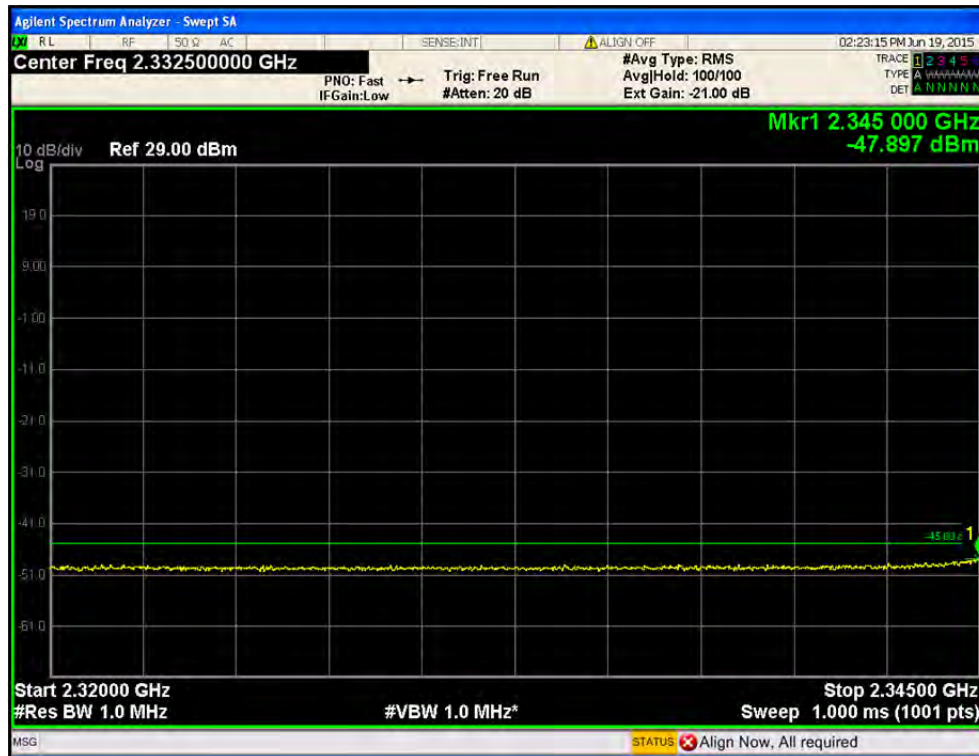

- Port1 / LTE 10 MHz / 2 355 MHz / 64QAM / 2 305.0 MHz ~ 2 320.0 MHz

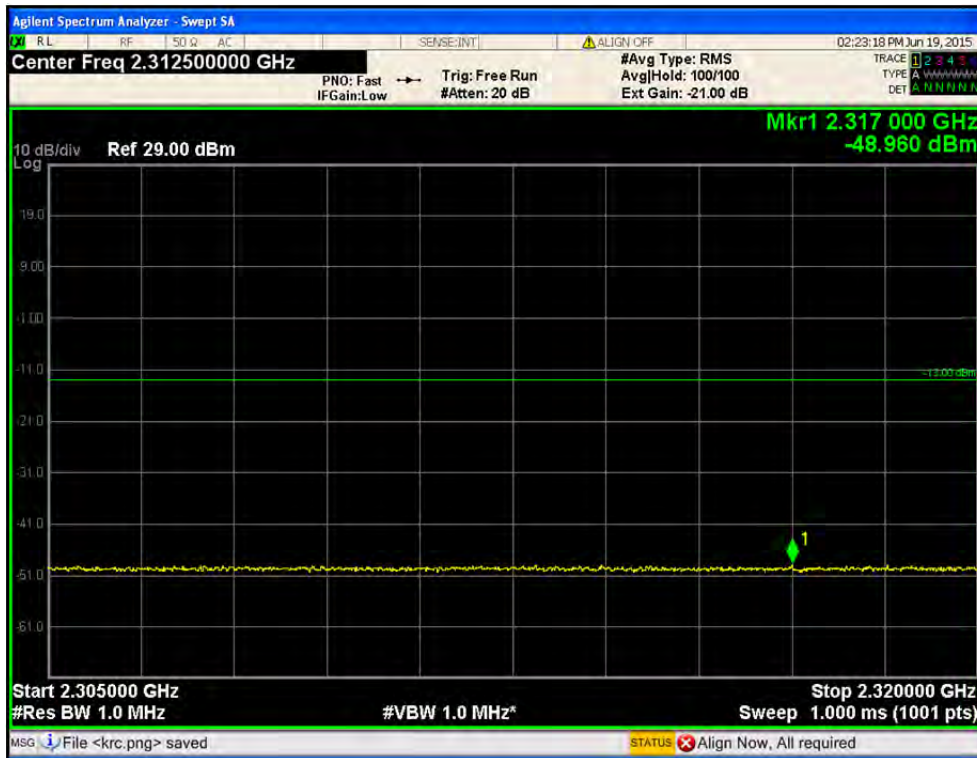

- Port1 / LTE 10 MHz / 2 355 MHz / 64QAM / 2 300.0 MHz ~ 2305.0 MHz

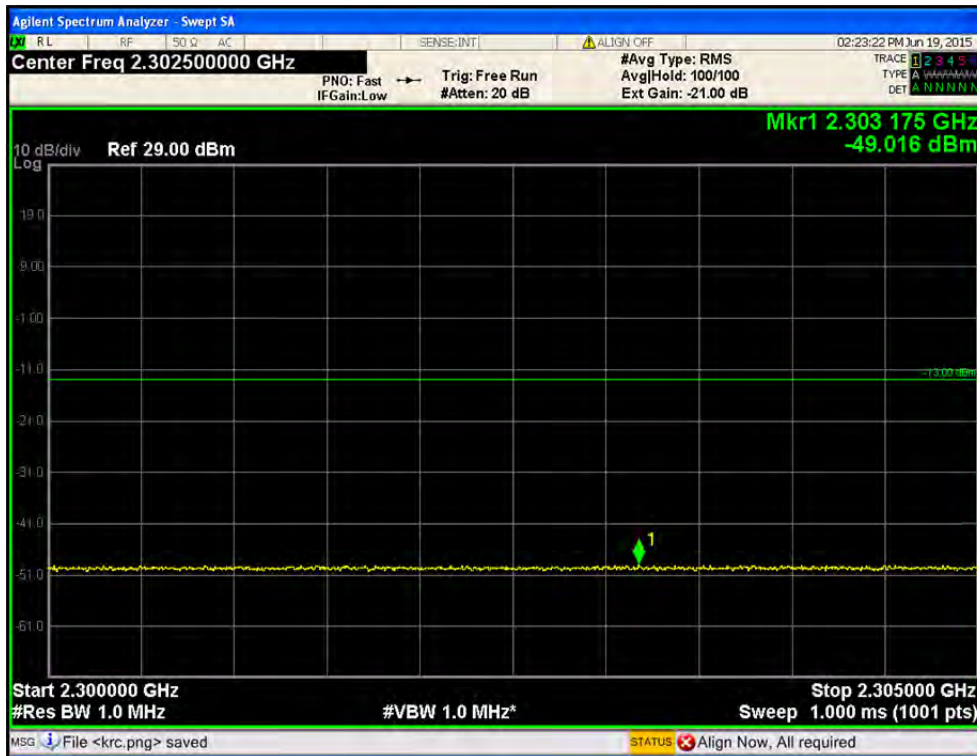

- Port1 / LTE 10 MHz / 2 355 MHz / 64QAM / 2 287.5 MHz ~ 2 300.0 MHz

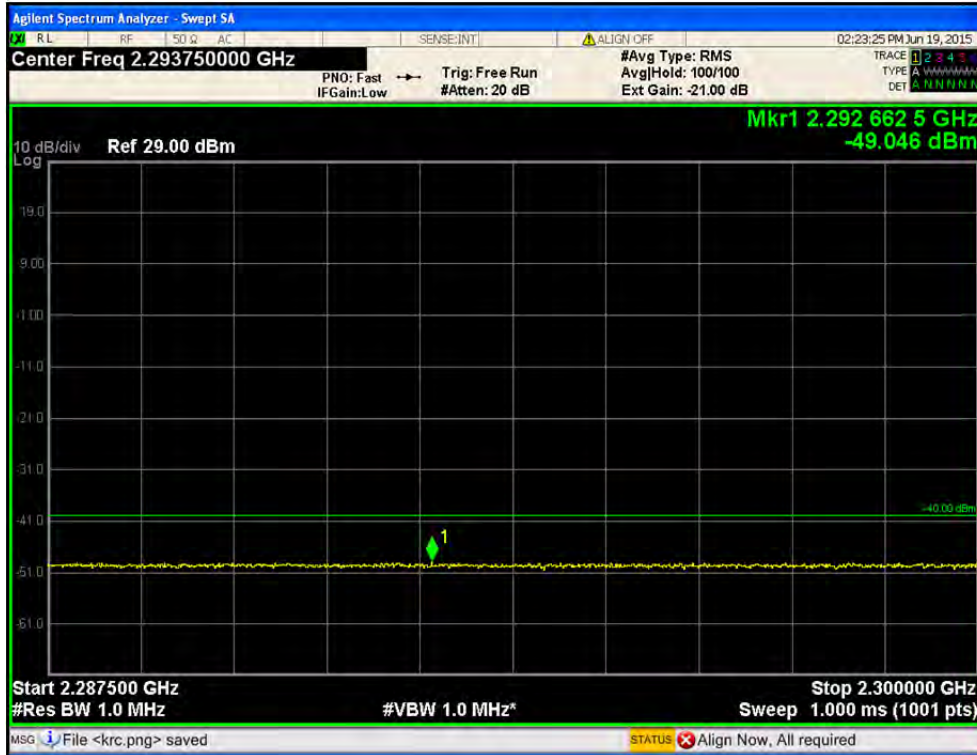

- Port1 / LTE 10 MHz / 2 355 MHz / 64QAM / 2 285.0 MHz ~ 2 287.5 MHz

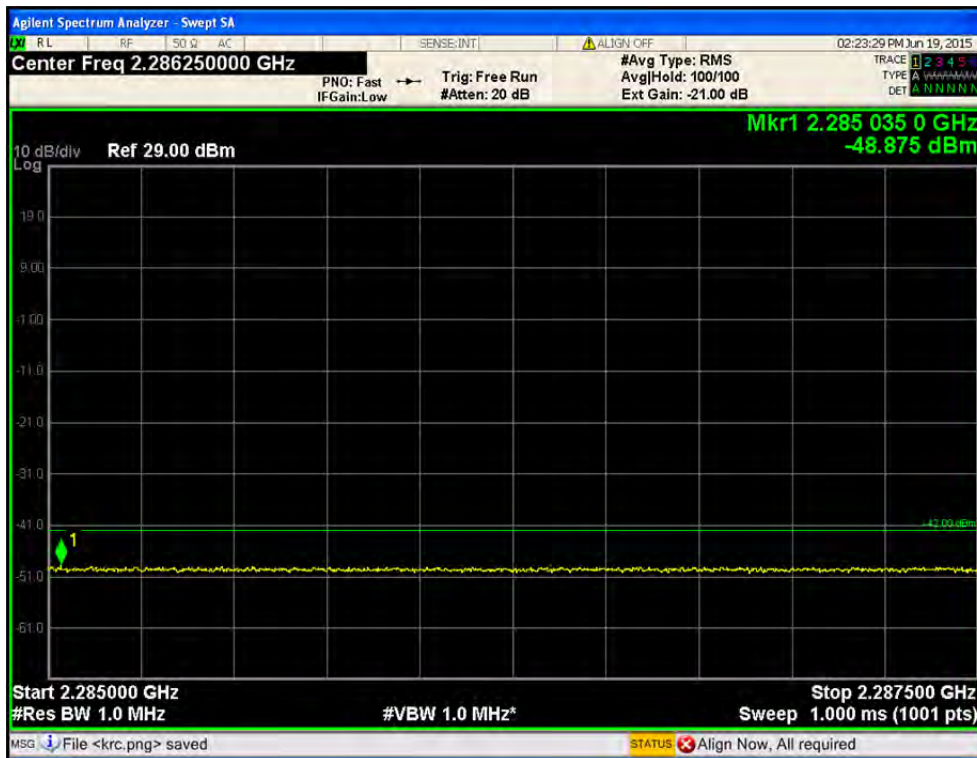

- Port1 / LTE 10 MHz / 2 355 MHz / 64QAM / below 2 285.0 MHz

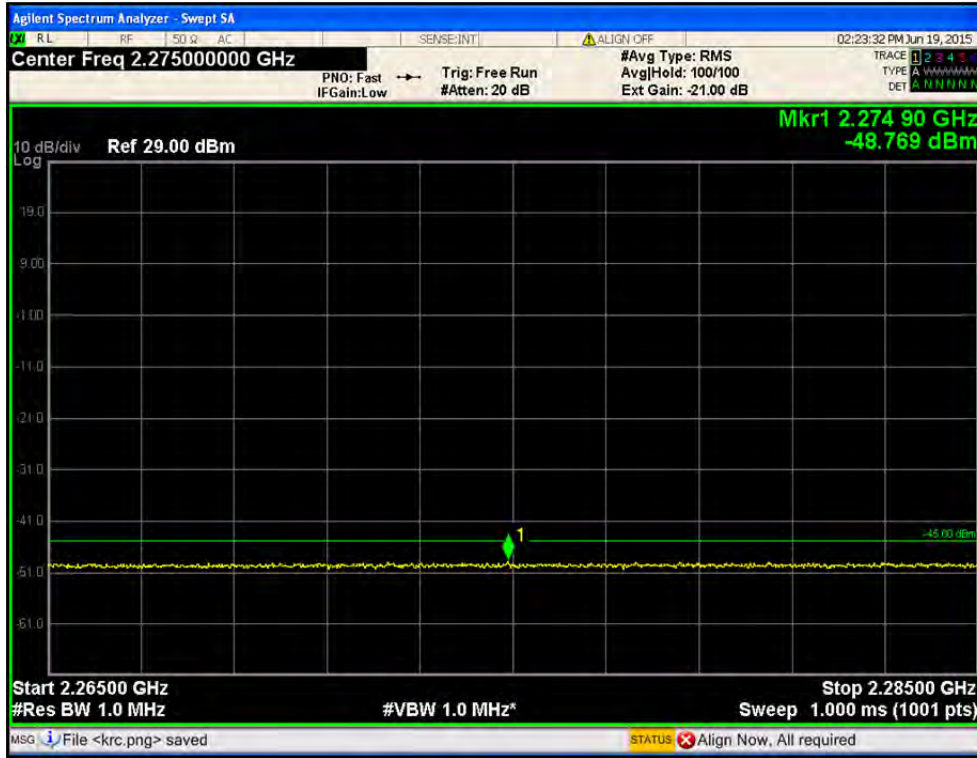

- Port1 / LTE 5 MHz / 2 352.5 MHz / QPSK / 2360.0 MHz ~ 2362.5 MHz



- Port1 / LTE 5 MHz / 2 352.5 MHz / QPSK / 2 362.5 MHz ~ 2365.0 MHz



- Port1 / LTE 5 MHz / 2 352.5 MHz / QPSK / 2365.0 MHz ~ 2367.5 MHz



- Port1 / LTE 5 MHz / 2 352.5 MHz / QPSK / 2 367.5 MHz ~ 2370.0 MHz

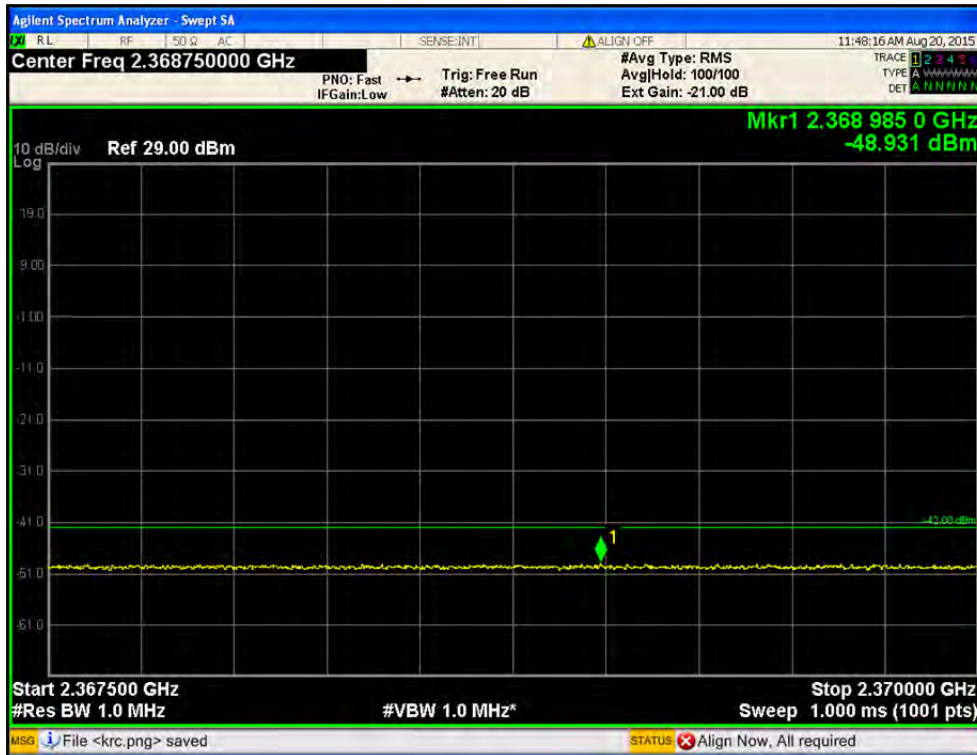

- Port1 / LTE 5 MHz / 2 352.5 MHz / QPSK / above 2 370.0 MHz

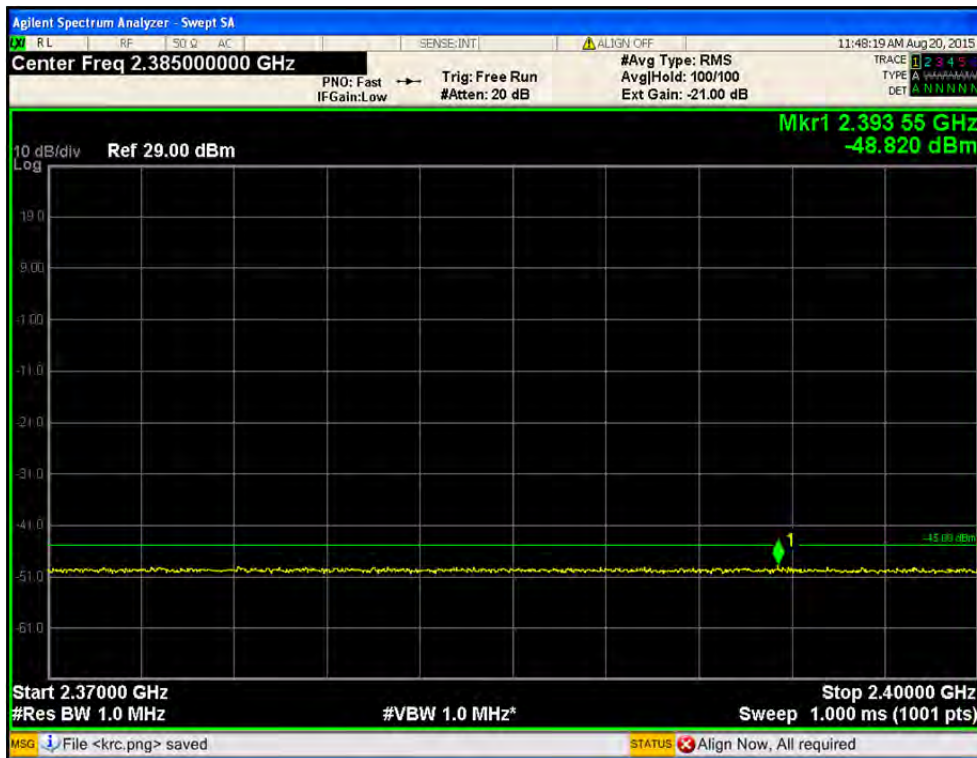

- Port1 / LTE 5 MHz / 2 352.5 MHz / QPSK / 2 320.0 MHz ~ 2345.0 MHz

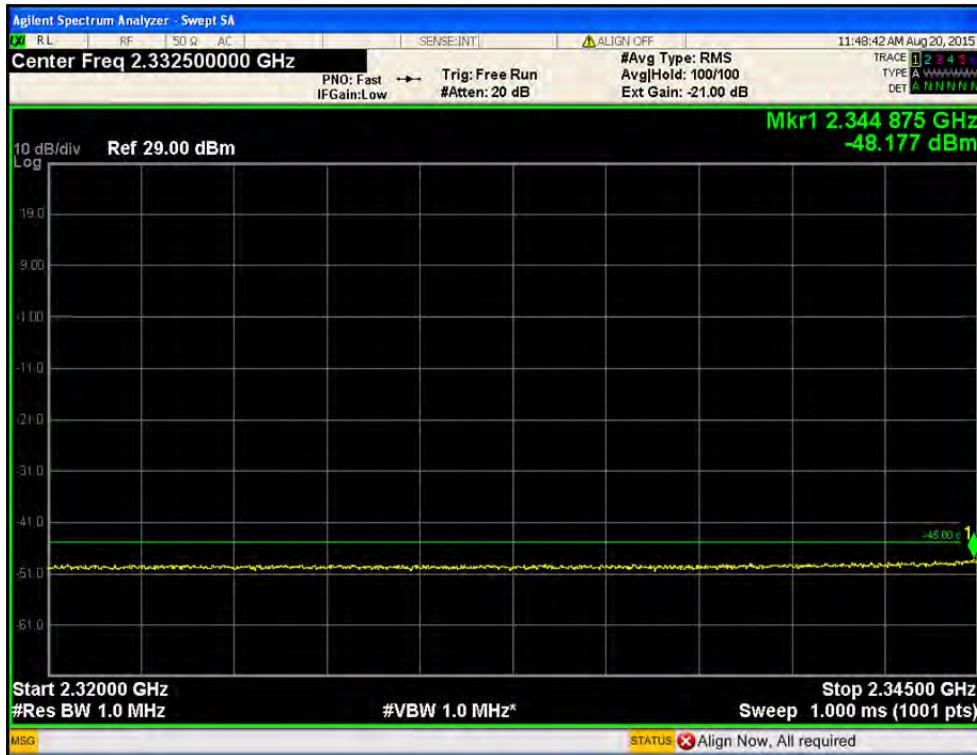

- Port1 / LTE 5 MHz / 2 352.5 MHz / QPSK / 2 305.0 MHz ~ 2 320.0 MHz

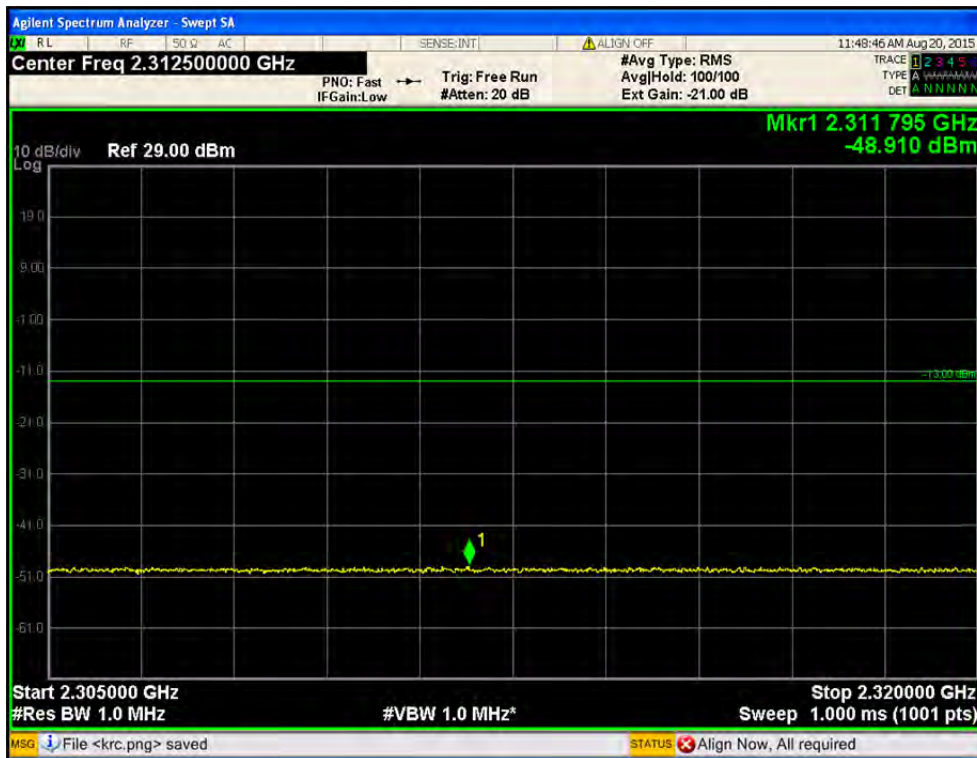

- Port1 / LTE 5 MHz / 2 352.5 MHz / QPSK / 2 300.0 MHz ~ 2305.0 MHz

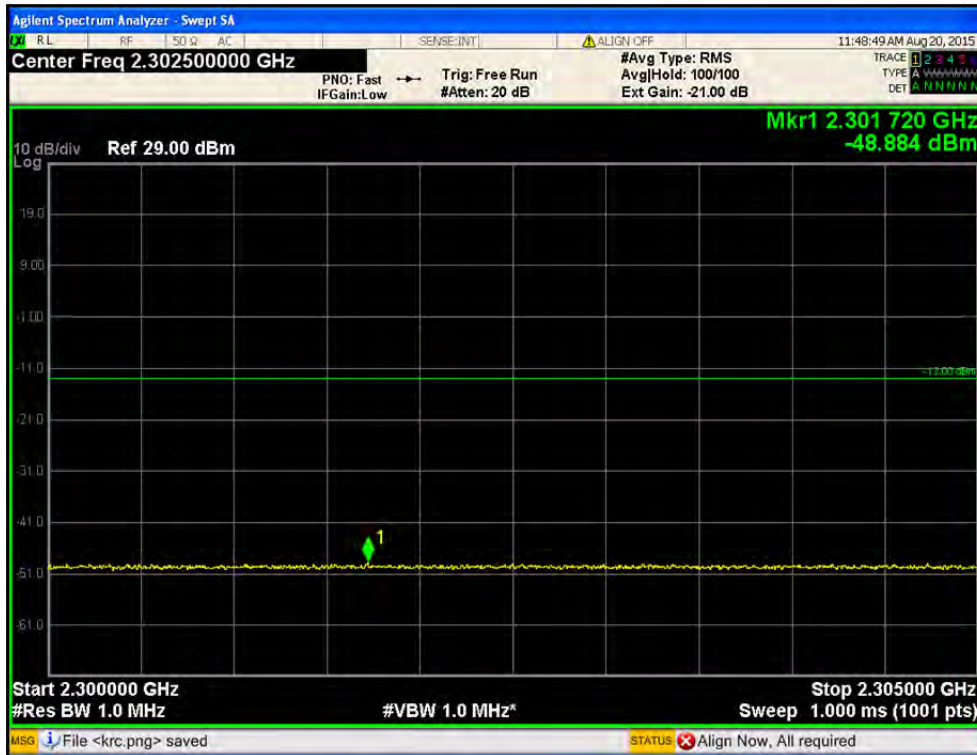

- Port1 / LTE 5 MHz / 2 352.5 MHz / QPSK / 2 287.5 MHz ~ 2 300.0 MHz

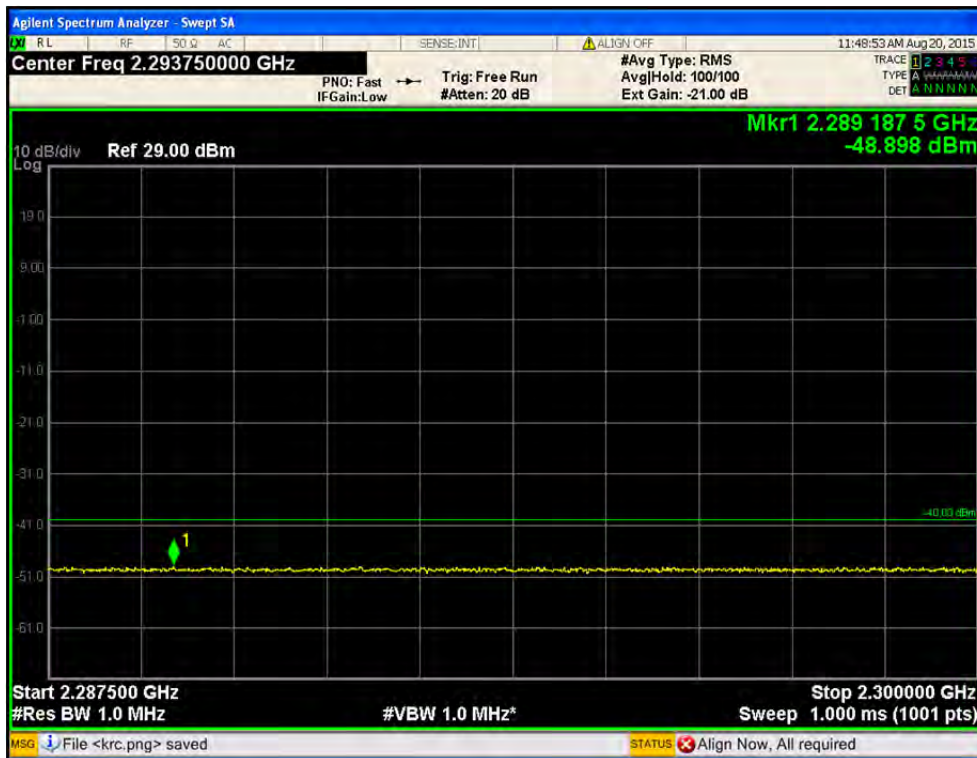

- Port1 / LTE 5 MHz / 2 352.5 MHz / QPSK / 2 285.0 MHz ~ 2 287.5 MHz

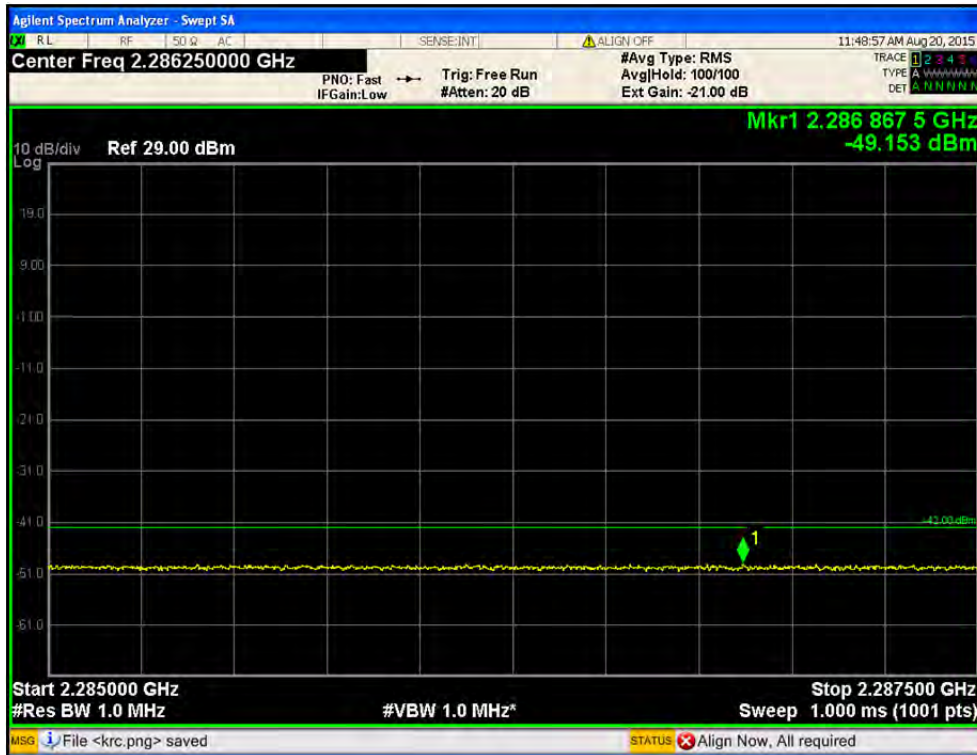

- Port1 / LTE 5 MHz / 2 352.5 MHz / QPSK / below 2 285.0 MHz

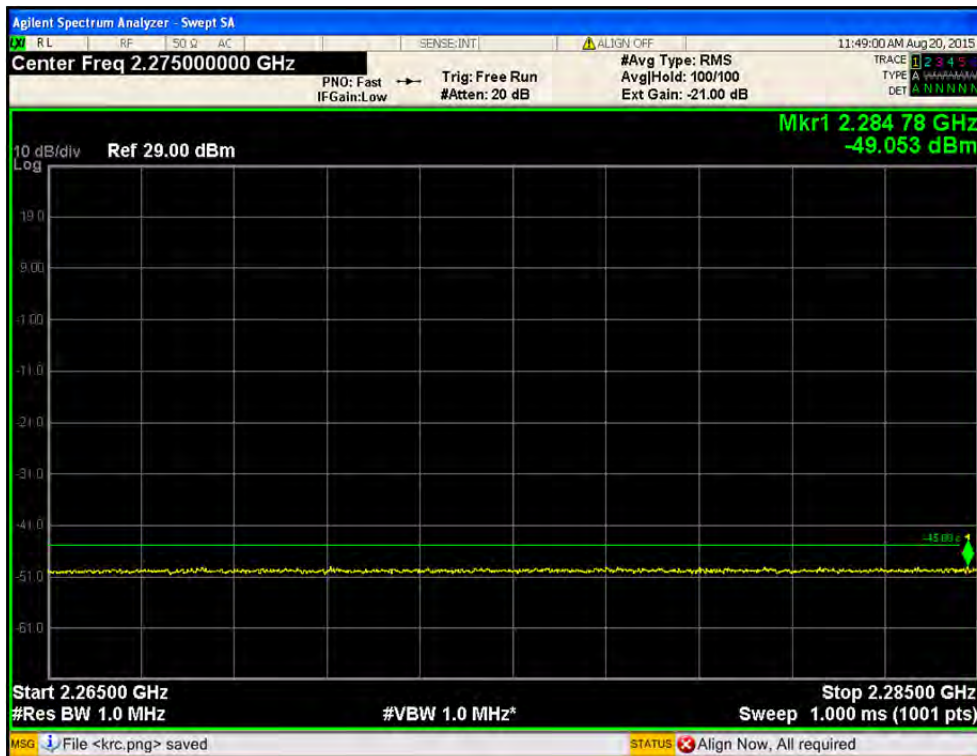

- Port1 / LTE 5 MHz / 2 352.5 MHz / 16QAM / 2360.0 MHz ~ 2362.5 MHz



- Port1 / LTE 5 MHz / 2 352.5 MHz / 16QAM / 2 362.5 MHz ~ 2365.0 MHz



- Port1 / LTE 5 MHz / 2 352.5 MHz / 16QAM / 2365.0 MHz ~ 2367.5 MHz

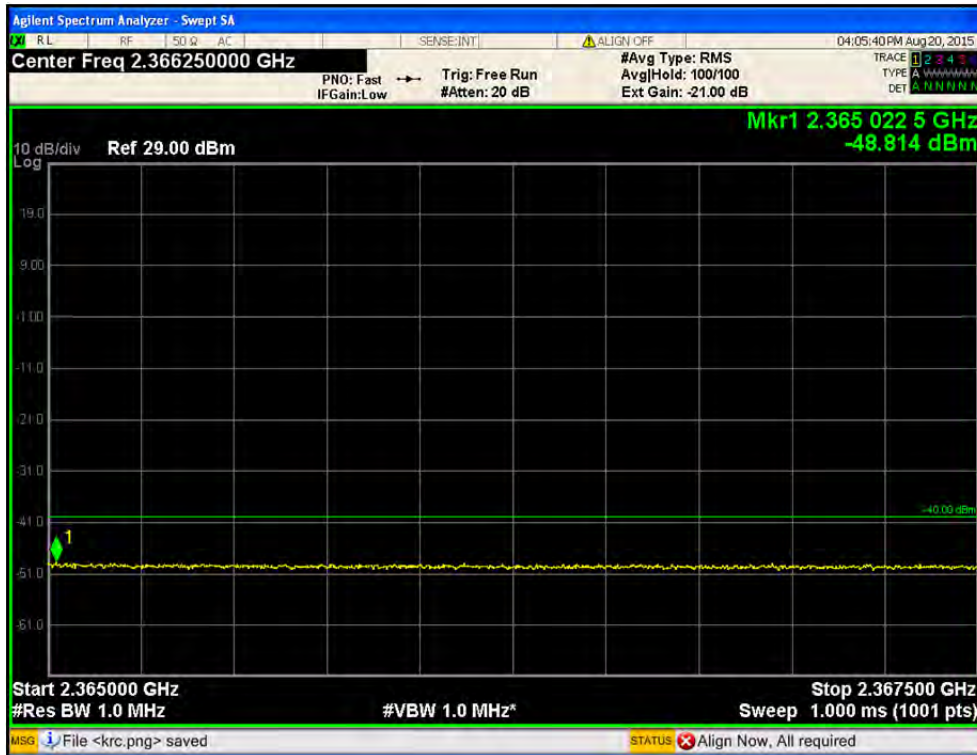

- Port1 / LTE 5 MHz / 2 352.5 MHz / 16QAM / 2 367.5 MHz ~ 2370.0 MHz

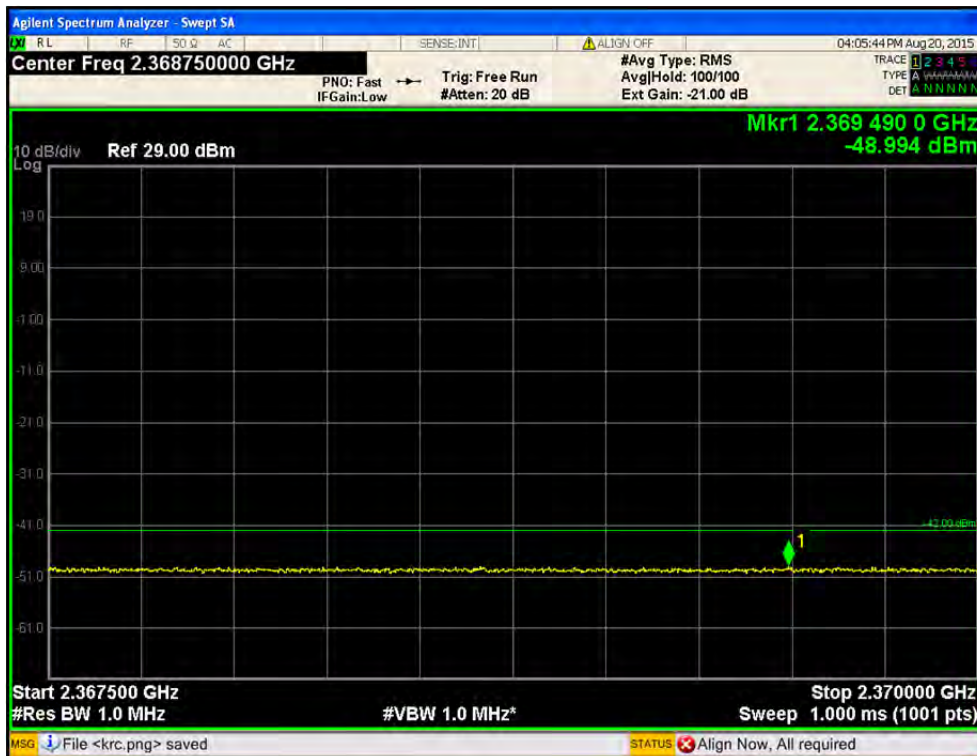

- Port1 / LTE 5 MHz / 2 352.5 MHz / 16QAM / above 2 370.0 MHz

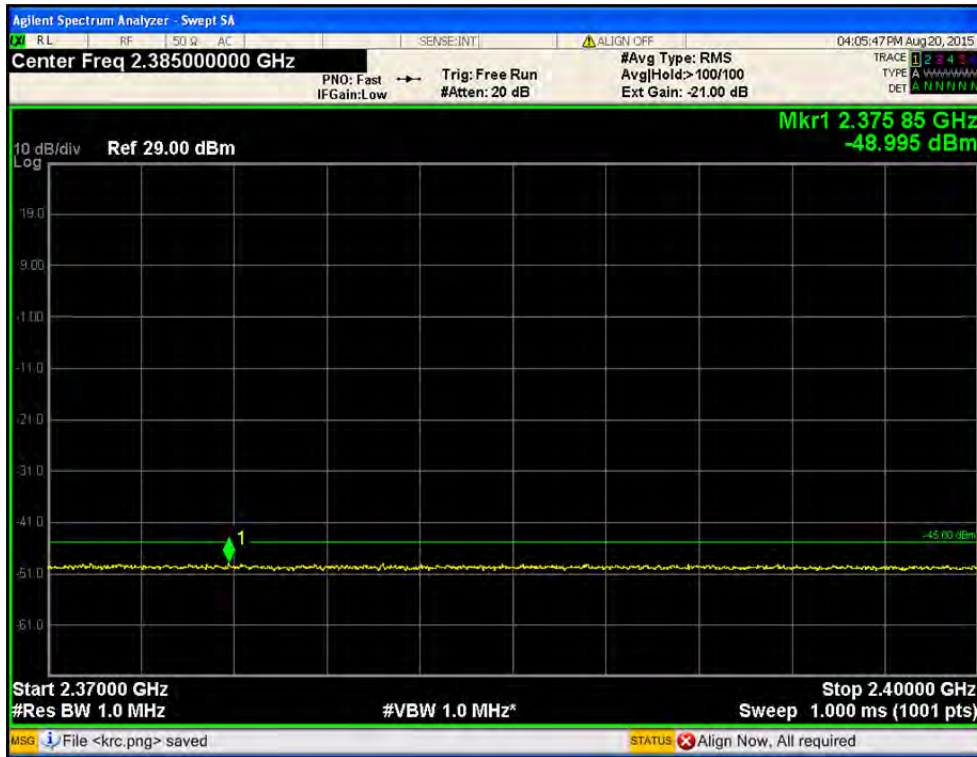

- Port1 / LTE 5 MHz / 2 352.5 MHz / 16QAM / 2 320.0 MHz ~ 2345.0 MHz

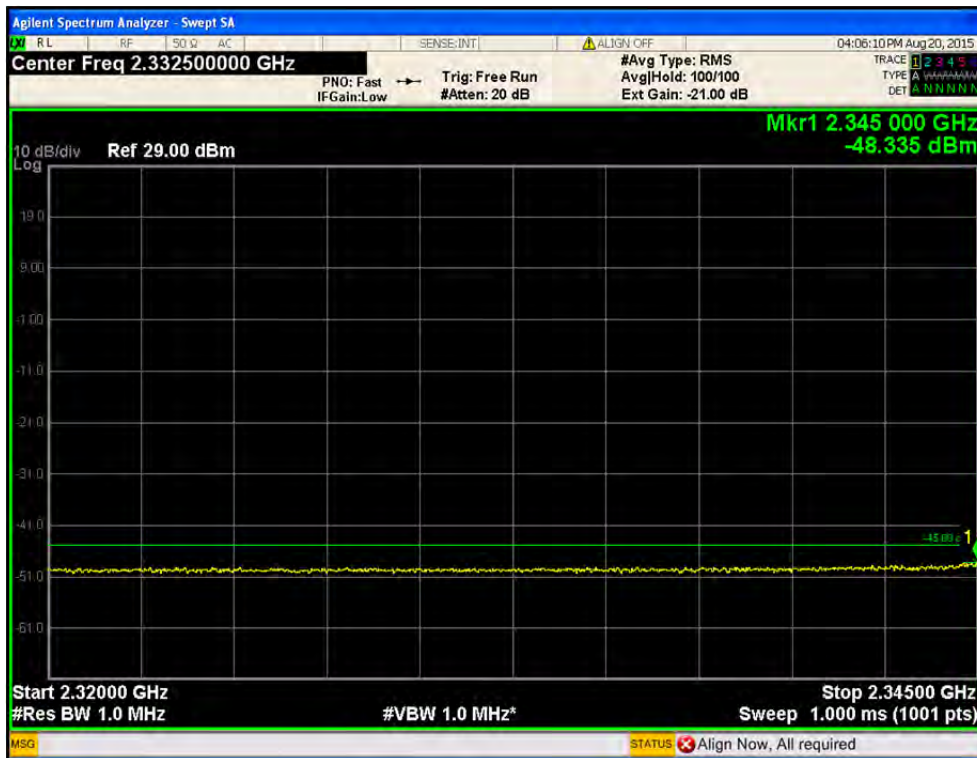

- Port1 / LTE 5 MHz / 2 352.5 MHz / 16QAM / 2 305.0 MHz ~ 2 320.0 MHz

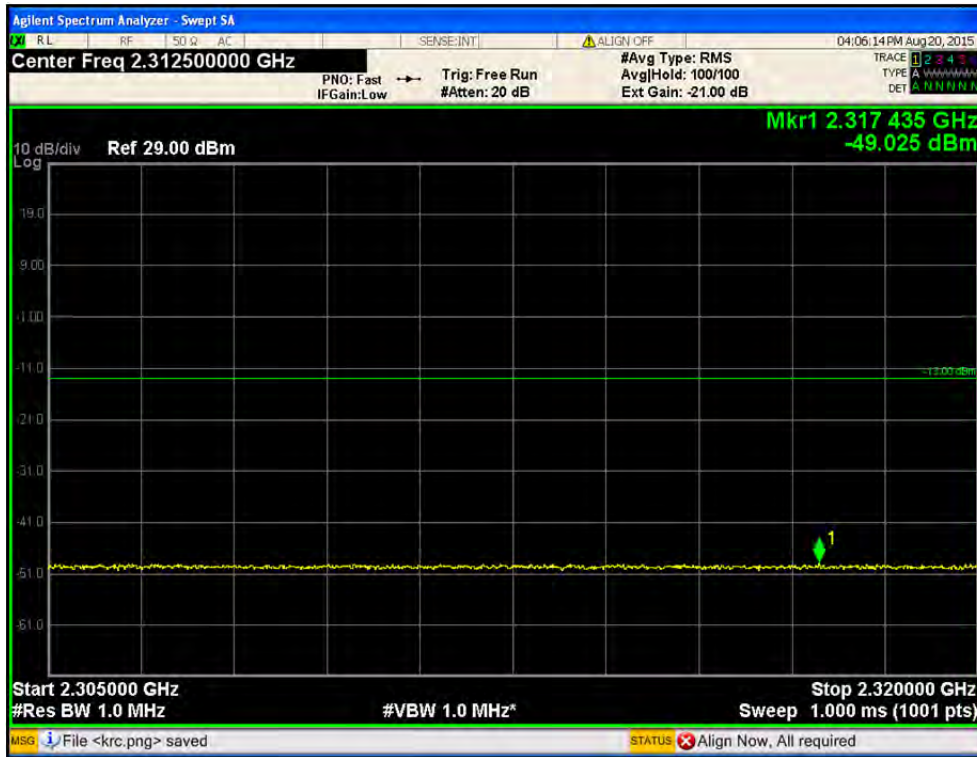

- Port1 / LTE 5 MHz / 2 352.5 MHz / 16QAM / 2 300.0 MHz ~ 2305.0 MHz

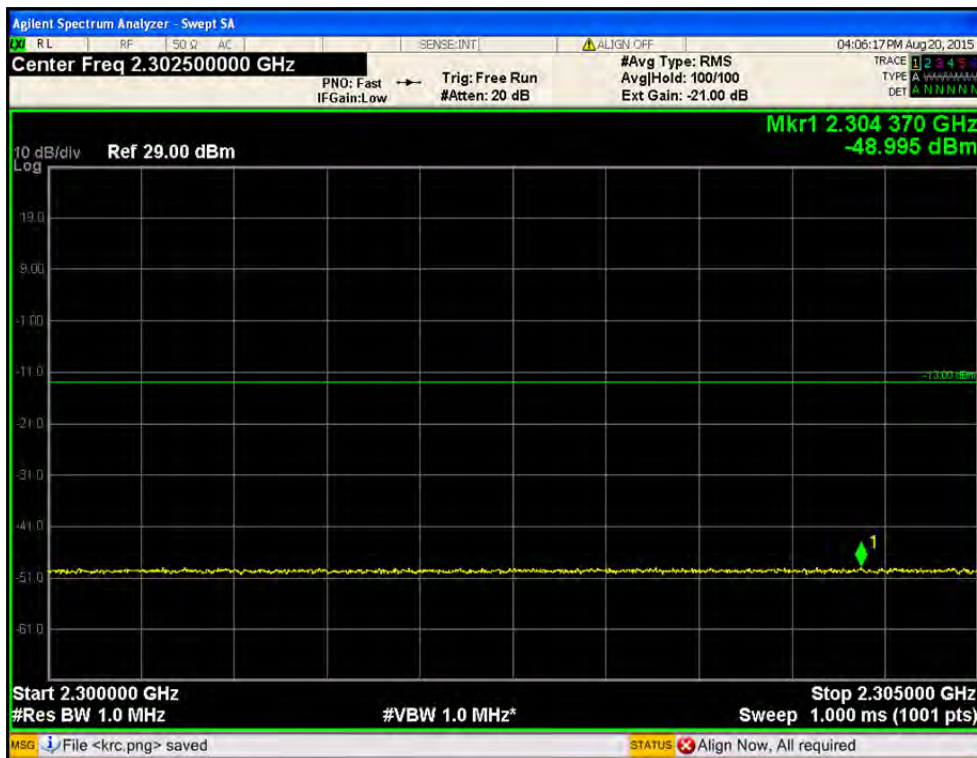

- Port1 / LTE 5 MHz / 2 352.5 MHz / 16QAM / 2 287.5 MHz ~ 2 300.0 MHz

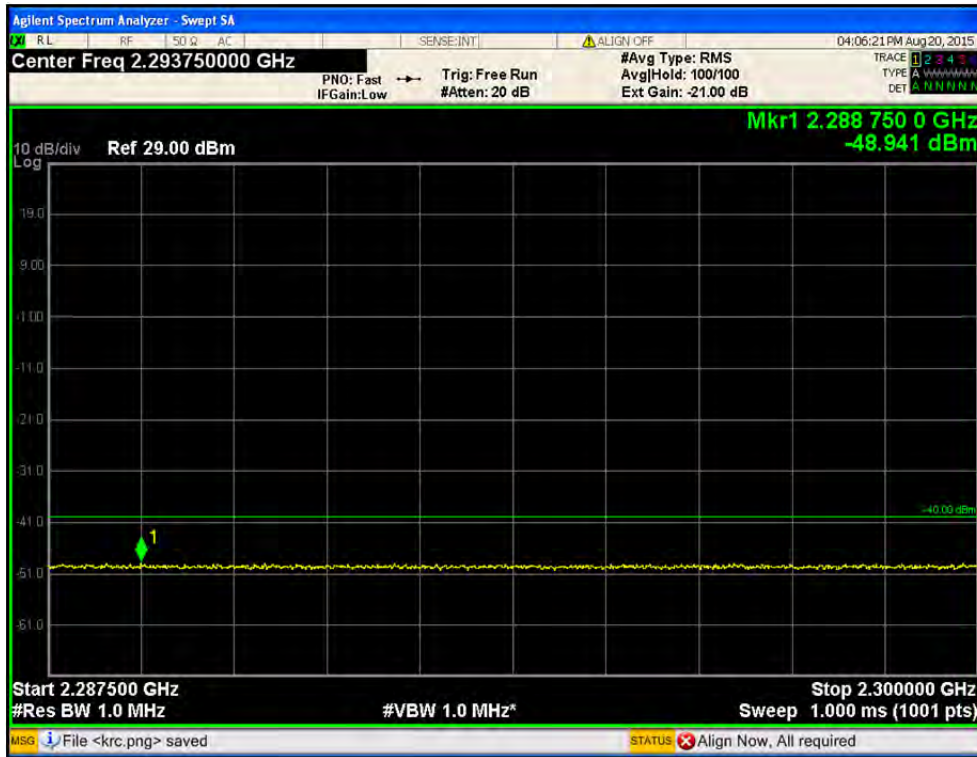

- Port1 / LTE 5 MHz / 2 352.5 MHz / 16QAM / 2 285.0 MHz ~ 2 287.5 MHz

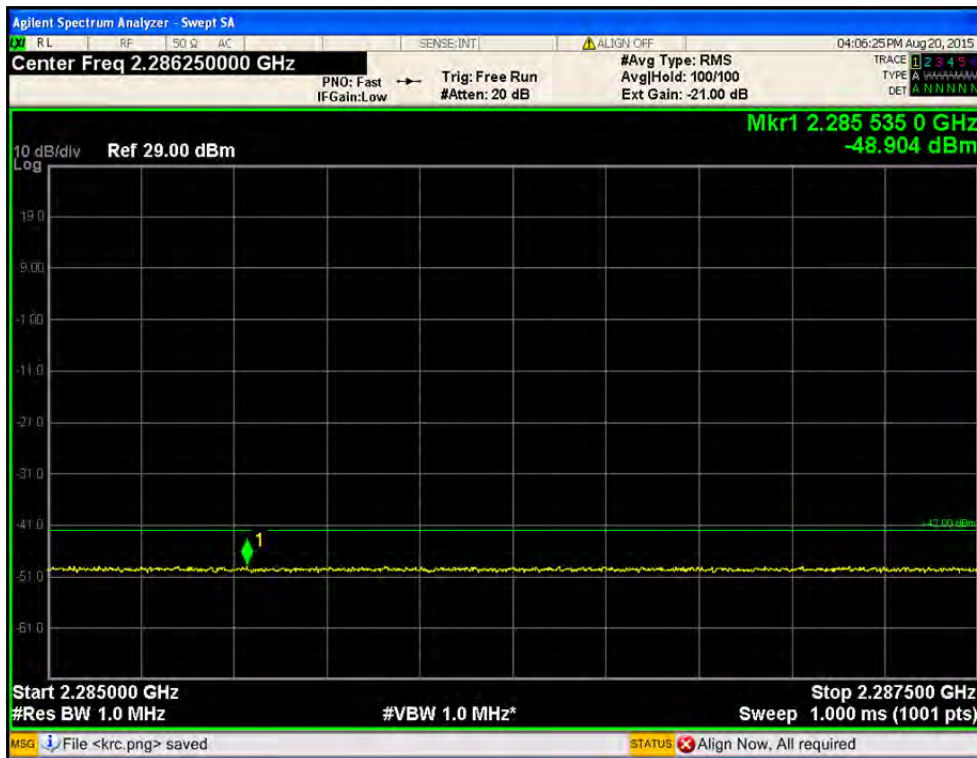

- Port1 / LTE 5 MHz / 2 352.5 MHz / 16QAM / below 2 285.0 MHz

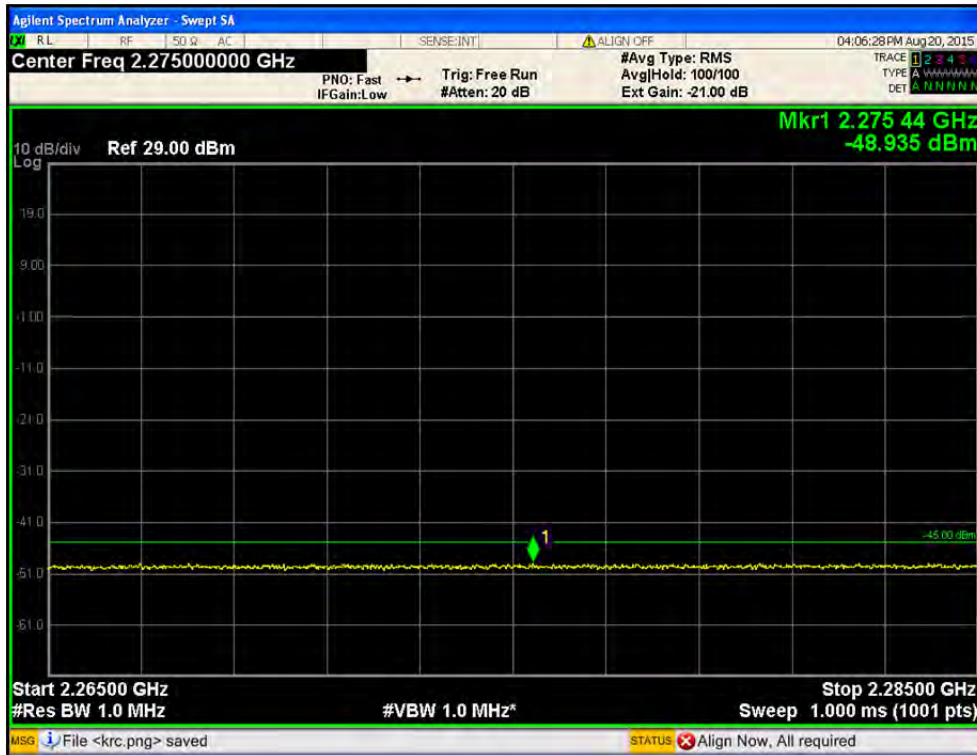

- Port1 / LTE 5 MHz / 2 352.5 MHz / 64QAM / 2360.0 MHz ~ 2362.5 MHz

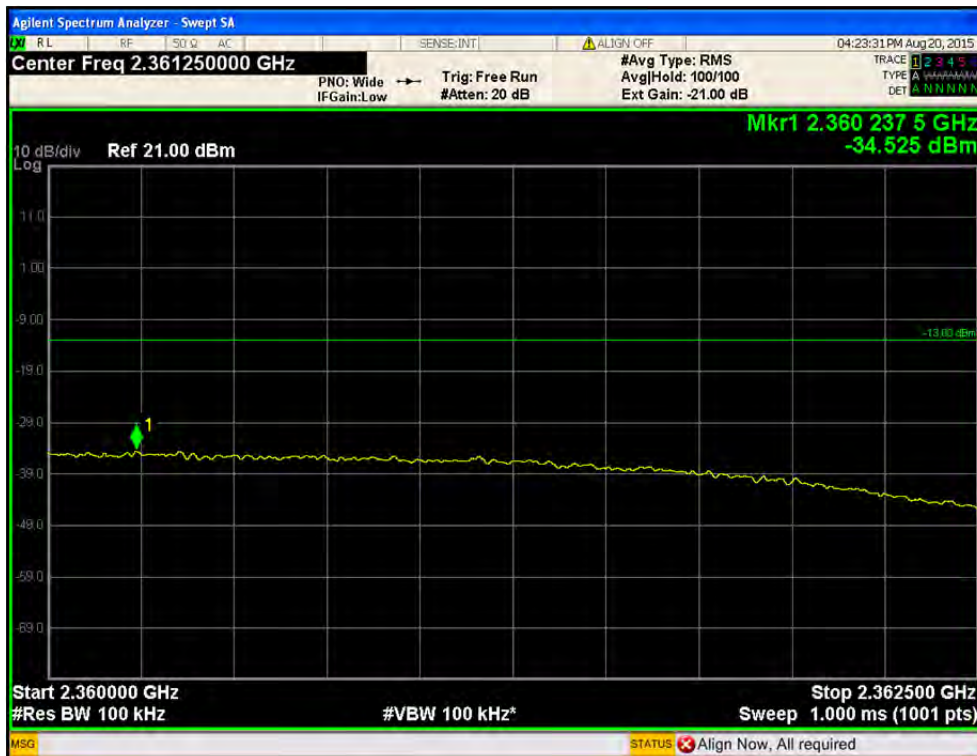

- Port1 / LTE 5 MHz / 2 352.5 MHz / 64QAM / 2 362.5 MHz ~ 2365.0 MHz



- Port1 / LTE 5 MHz / 2 352.5 MHz / 64QAM / 2365.0 MHz ~ 2367.5 MHz

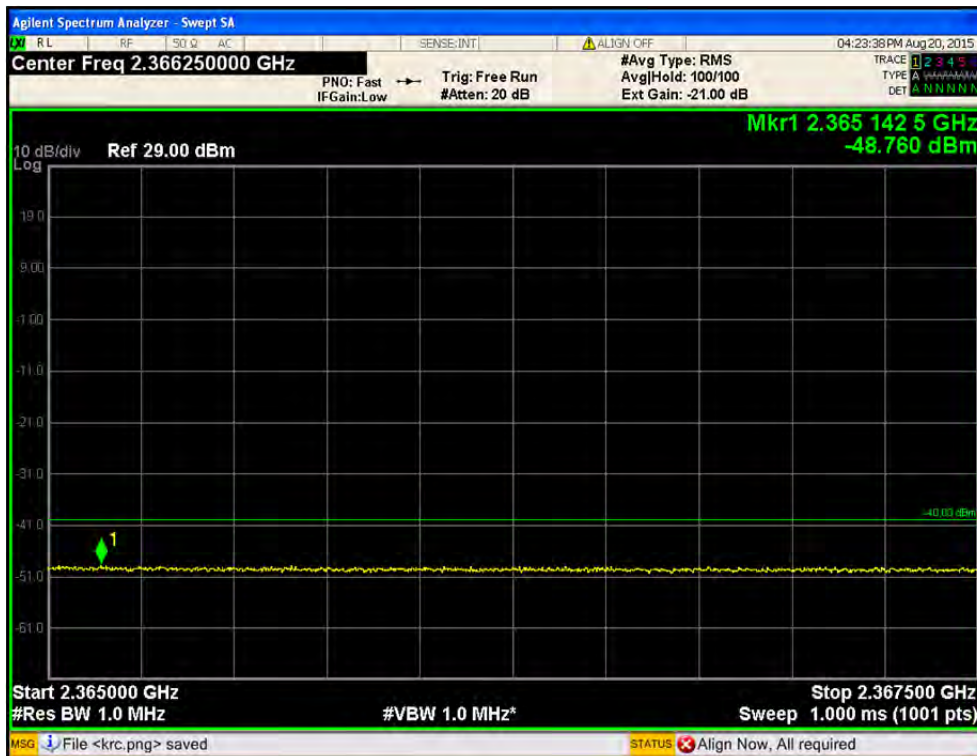

- Port1 / LTE 5 MHz / 2 352.5 MHz / 64QAM / 2 367.5 MHz ~ 2370.0 MHz

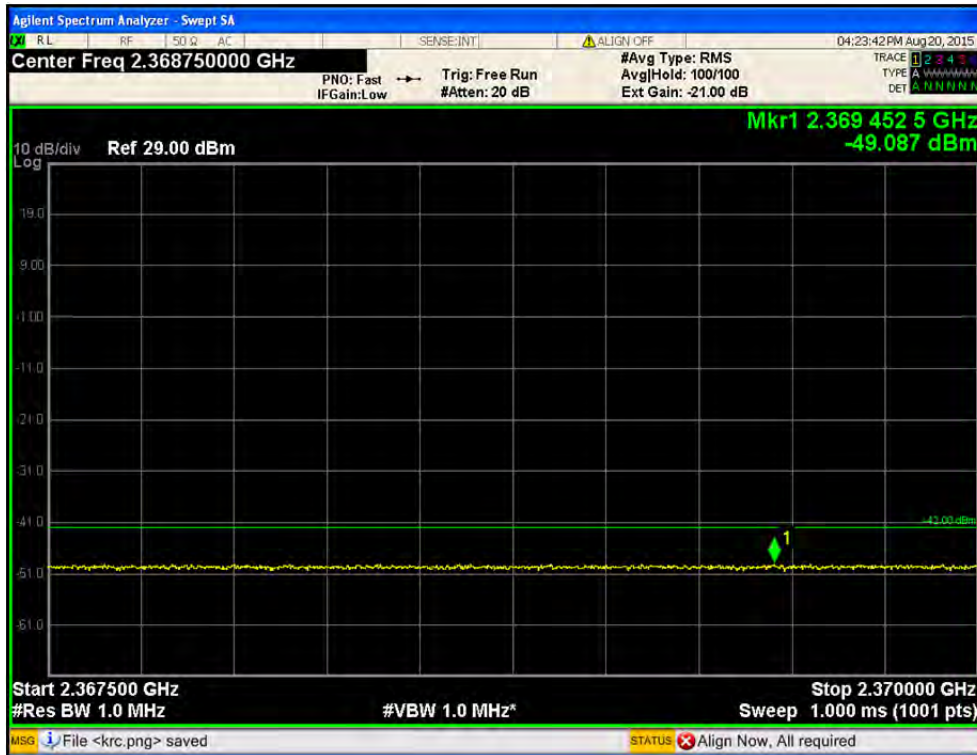

- Port1 / LTE 5 MHz / 2 352.5 MHz / 64QAM / above 2 370.0 MHz

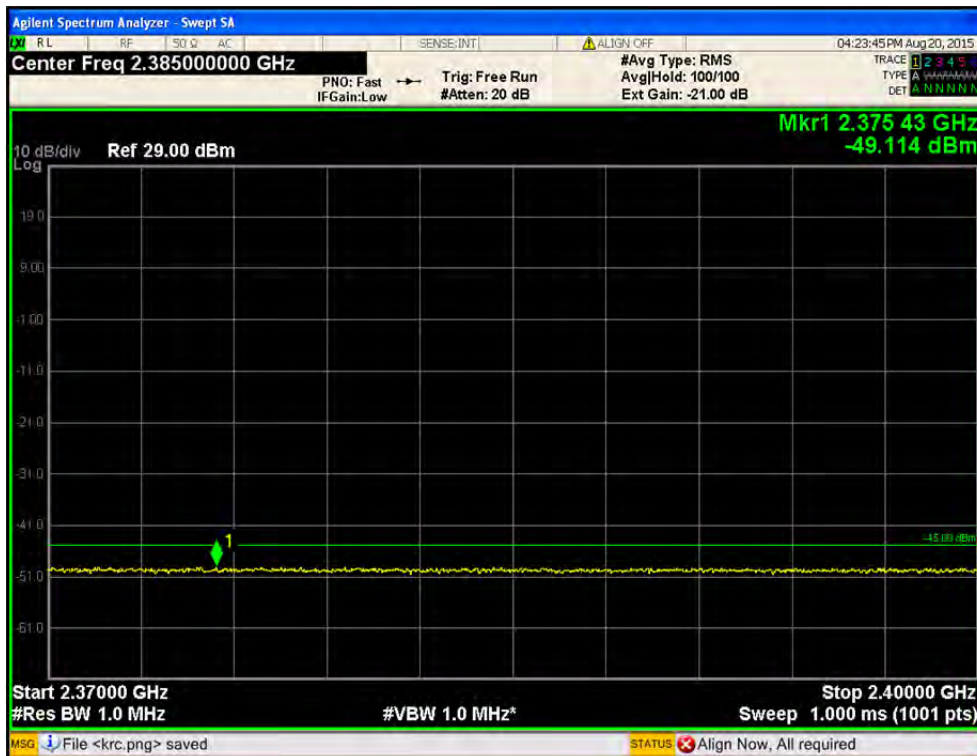

- Port1 / LTE 5 MHz / 2 352.5 MHz / 64QAM / 2 320.0 MHz ~ 2345.0 MHz

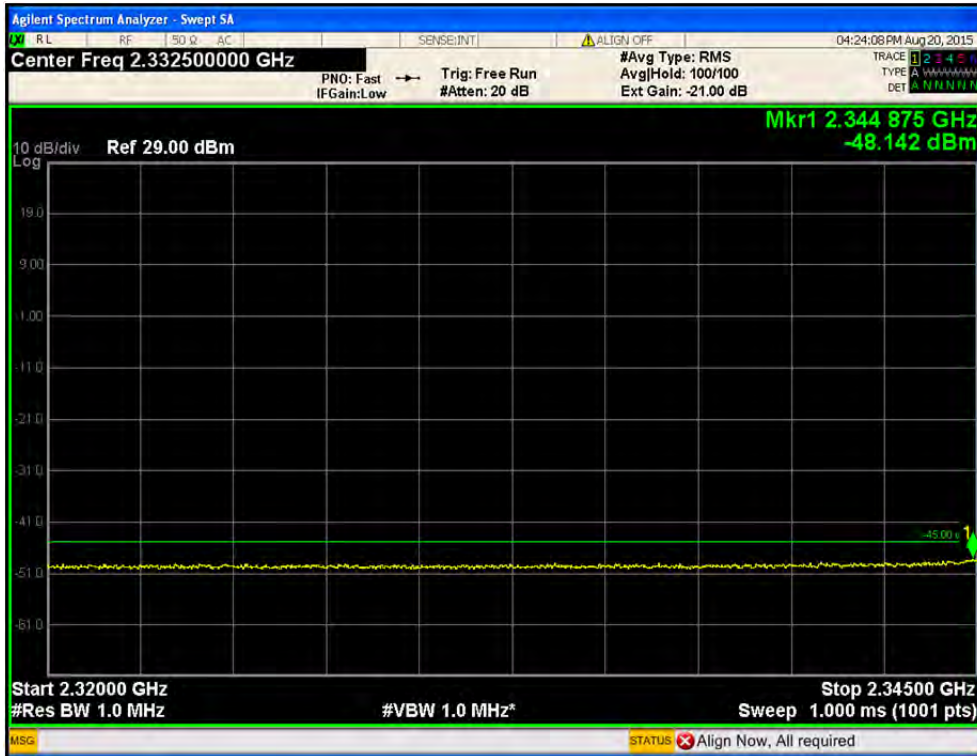

- Port1 / LTE 5 MHz / 2 352.5 MHz / 64QAM / 2 305.0 MHz ~ 2 320.0 MHz

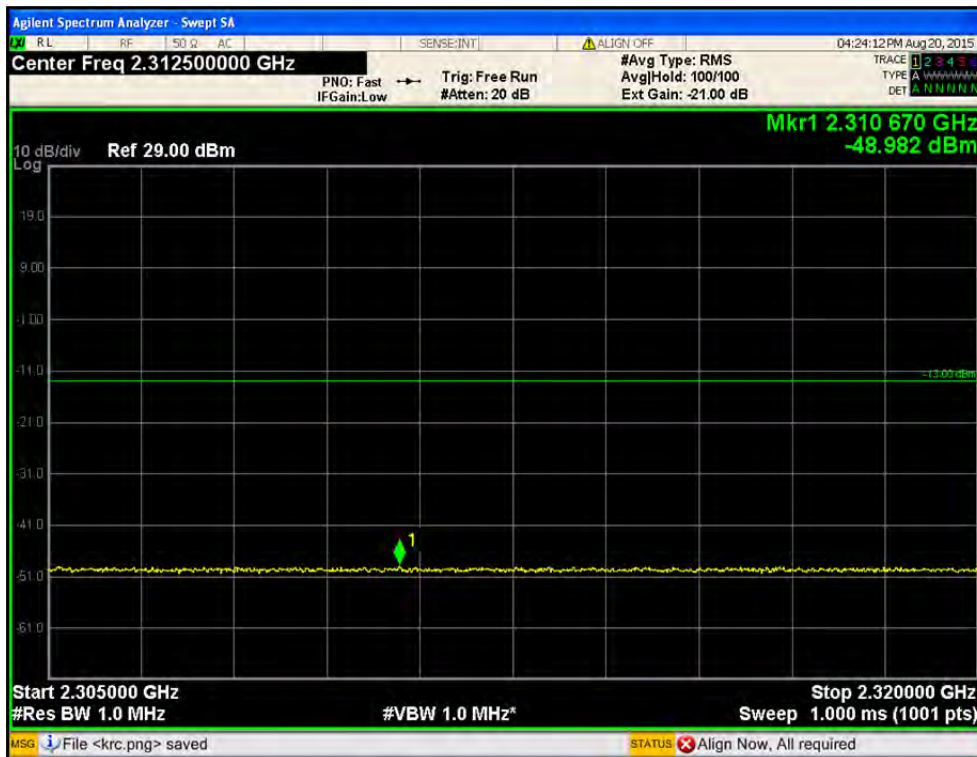

- Port1 / LTE 5 MHz / 2 352.5 MHz / 64QAM / 2 300.0 MHz ~ 2305.0 MHz

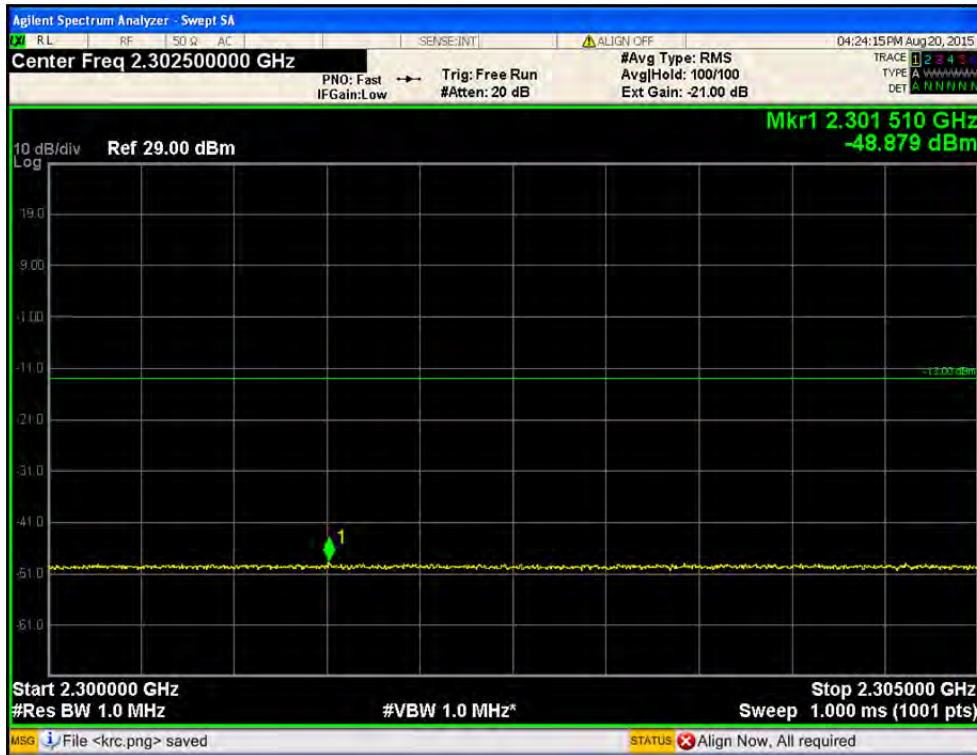

- Port1 / LTE 5 MHz / 2 352.5 MHz / 64QAM / 2 287.5 MHz ~ 2 300.0 MHz

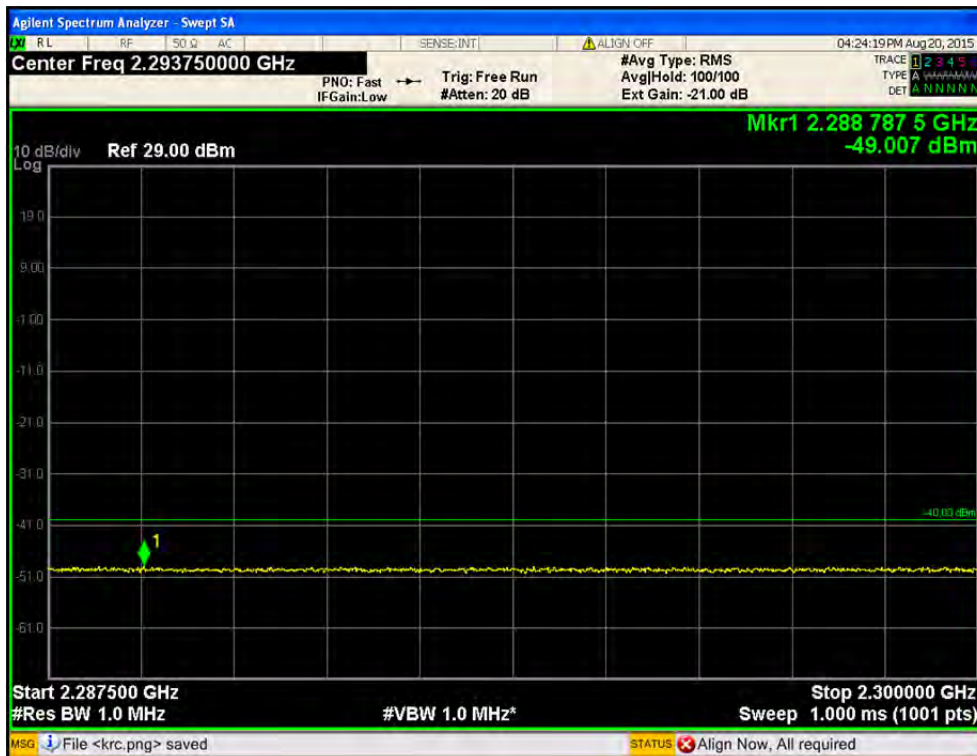

- Port1 / LTE 5 MHz / 2 352.5 MHz / 64QAM / 2 285.0 MHz ~ 2 287.5 MHz



- Port1 / LTE 5 MHz / 2 352.5 MHz / 64QAM / below 2 285.0 MHz

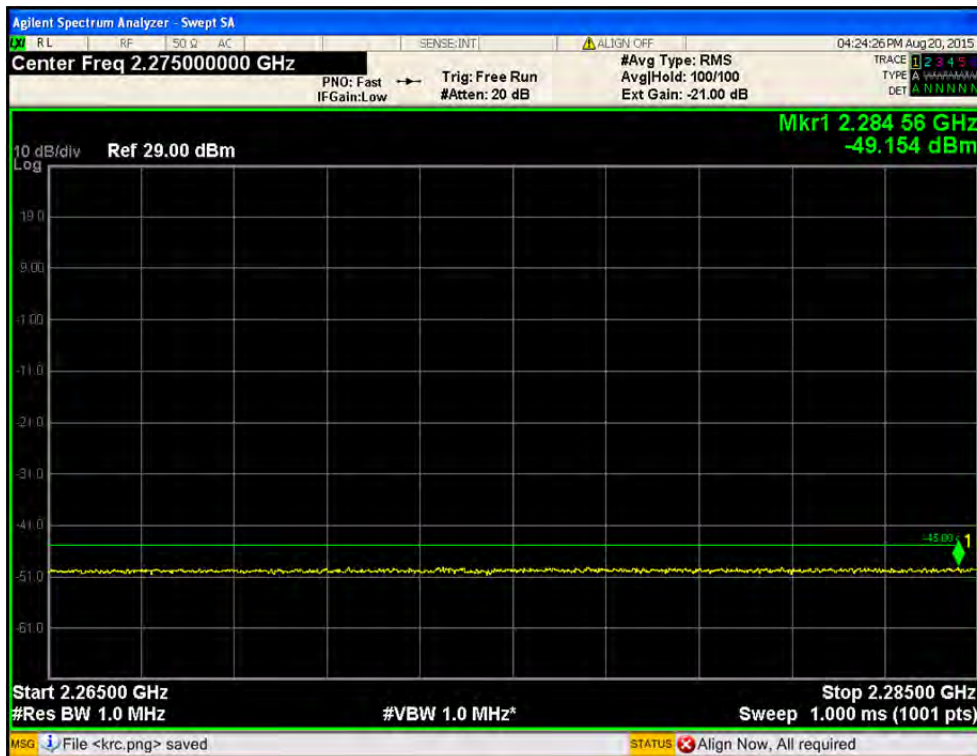

- Port1 / LTE 5 MHz / 2 357.5 MHz / QPSK / 2360.0 MHz ~ 2362.5 MHz



- Port1 / LTE 5 MHz / 2 357.5 MHz / QPSK / 2 362.5 MHz ~ 2365.0 MHz



- Port1 / LTE 5 MHz / 2 357.5 MHz / QPSK / 2365.0 MHz ~ 2367.5 MHz

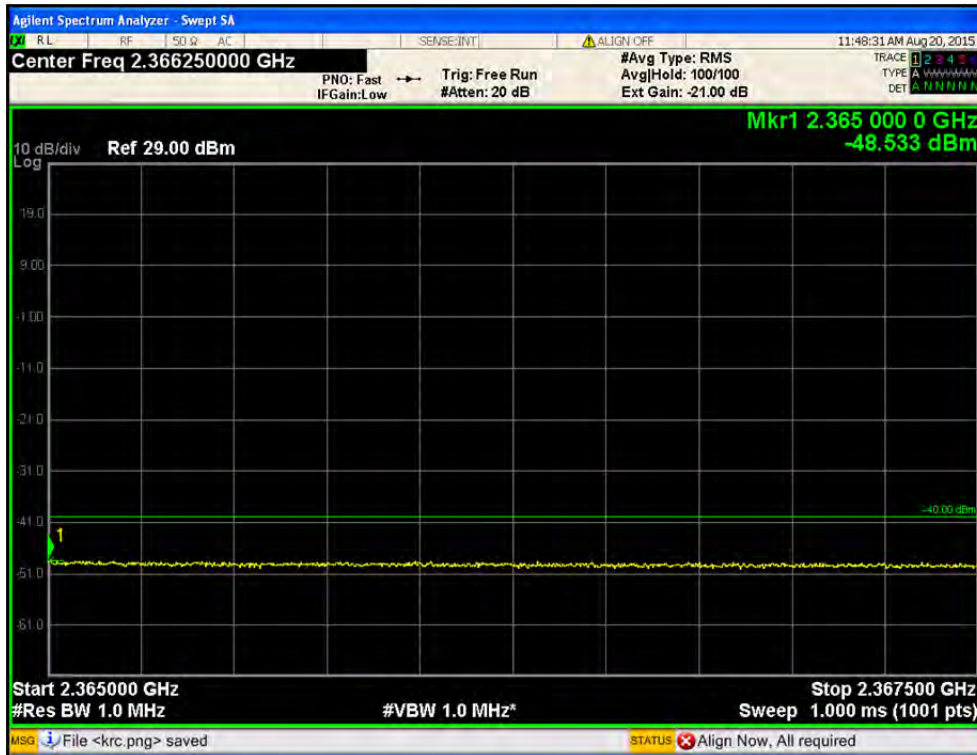

- Port1 / LTE 5 MHz / 2 357.5 MHz / QPSK / 2 367.5 MHz ~ 2370.0 MHz

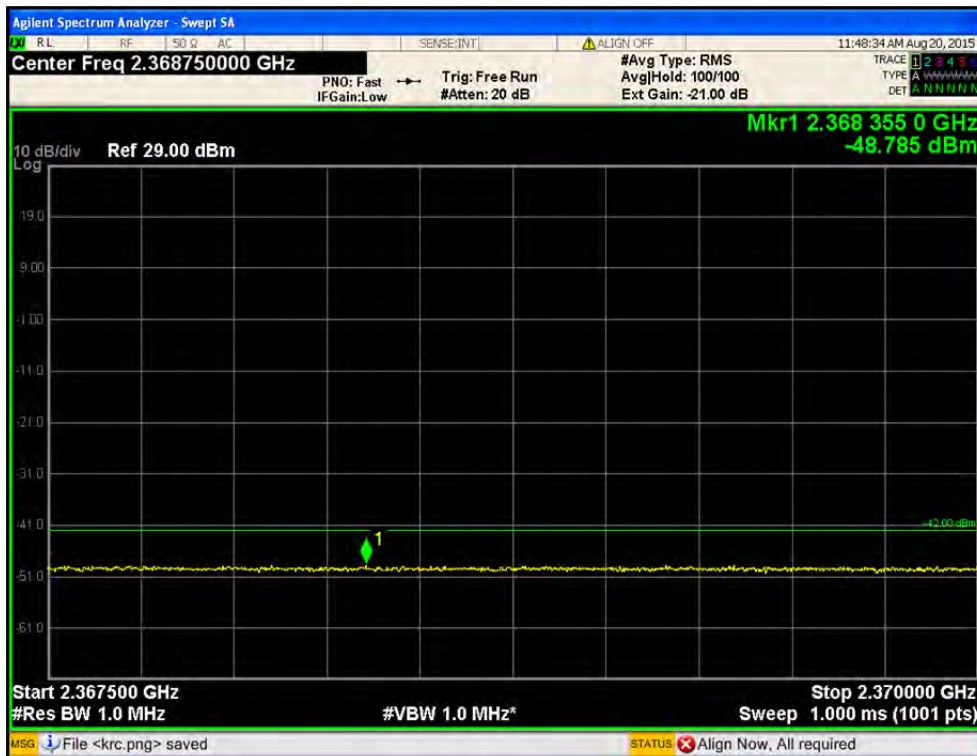

- Port1 / LTE 5 MHz / 2 357.5 MHz / QPSK / above 2 370.0 MHz

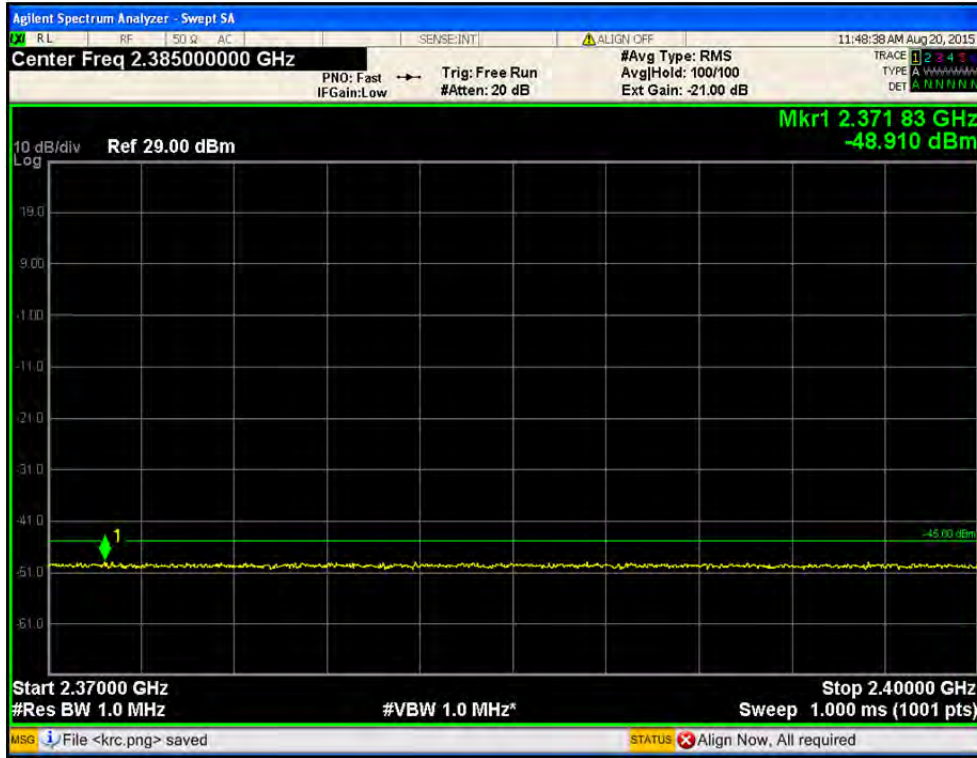

- Port1 / LTE 5 MHz / 2 357.5 MHz / QPSK / 2 320.0 MHz ~ 2345.0 MHz

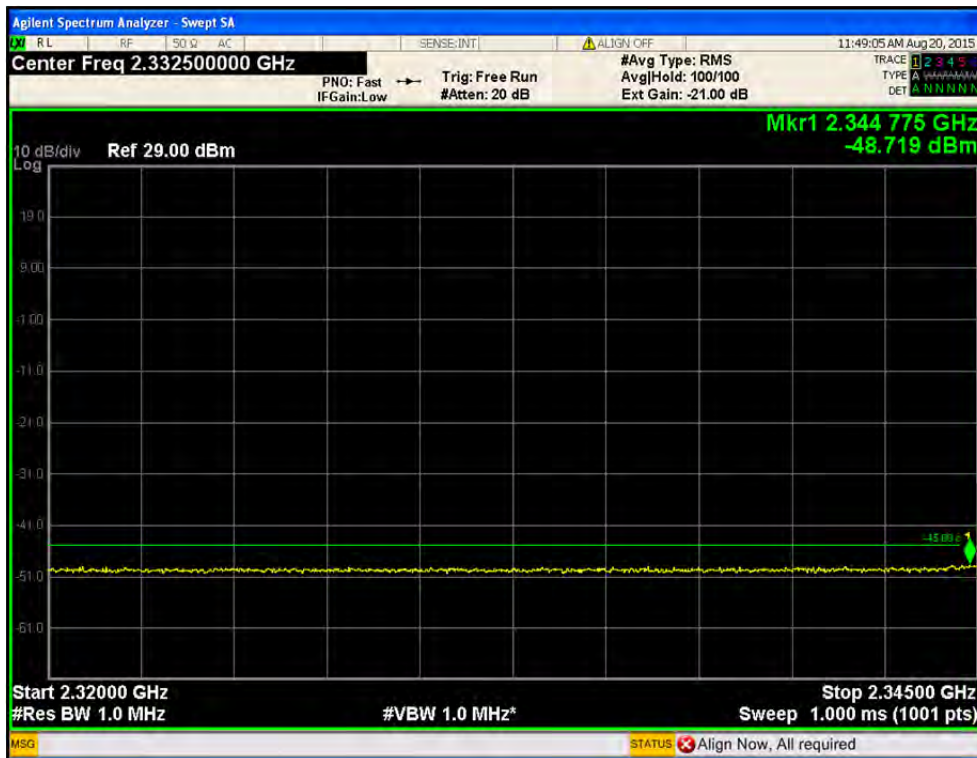

- Port1 / LTE 5 MHz / 2 357.5 MHz / QPSK / 2 305.0 MHz ~ 2 320.0 MHz

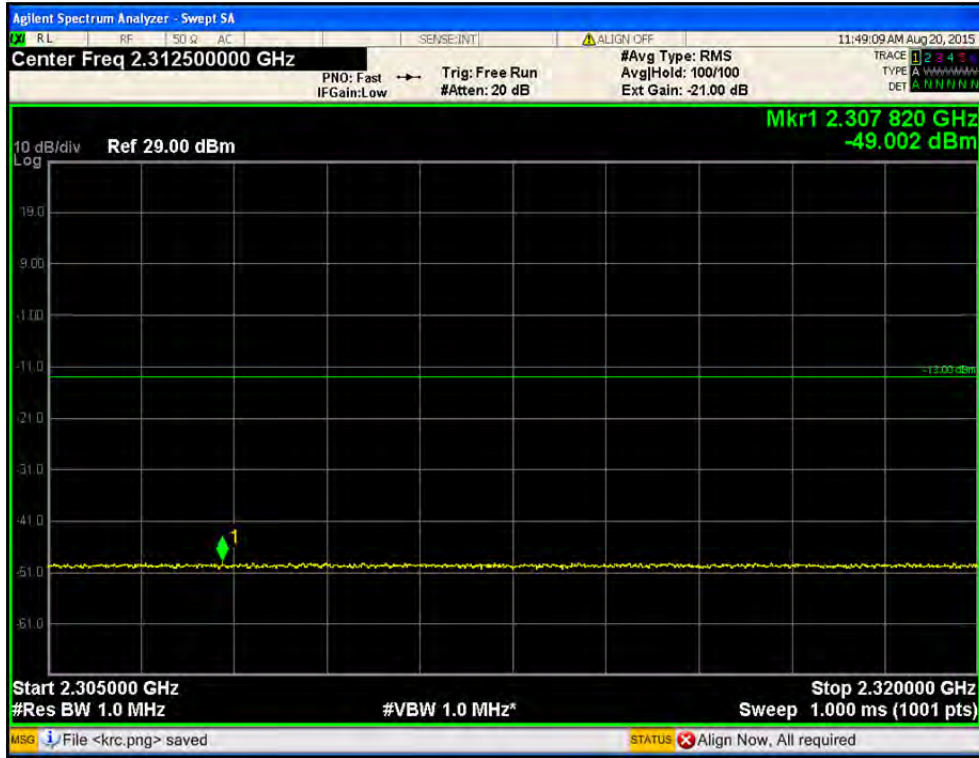

- Port1 / LTE 5 MHz / 2 357.5 MHz / QPSK / 2 300.0 MHz ~ 2305.0 MHz

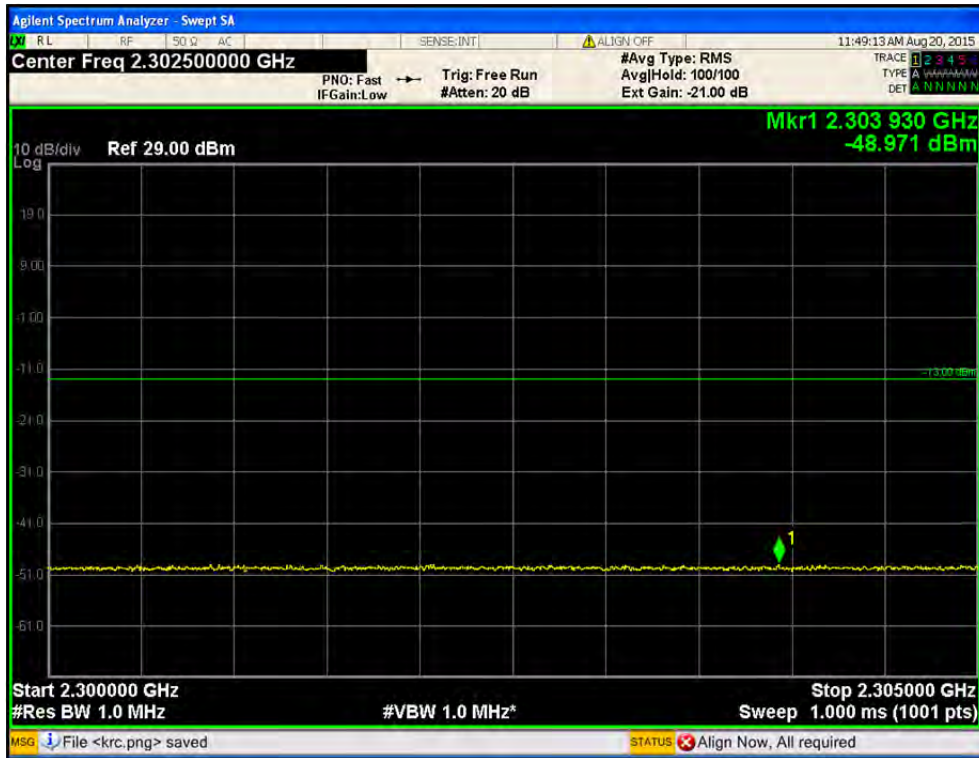

- Port1 / LTE 5 MHz / 2 357.5 MHz / QPSK / 2 287.5 MHz ~ 2 300.0 MHz



- Port1 / LTE 5 MHz / 2 357.5 MHz / QPSK / 2 285.0 MHz ~ 2 287.5 MHz

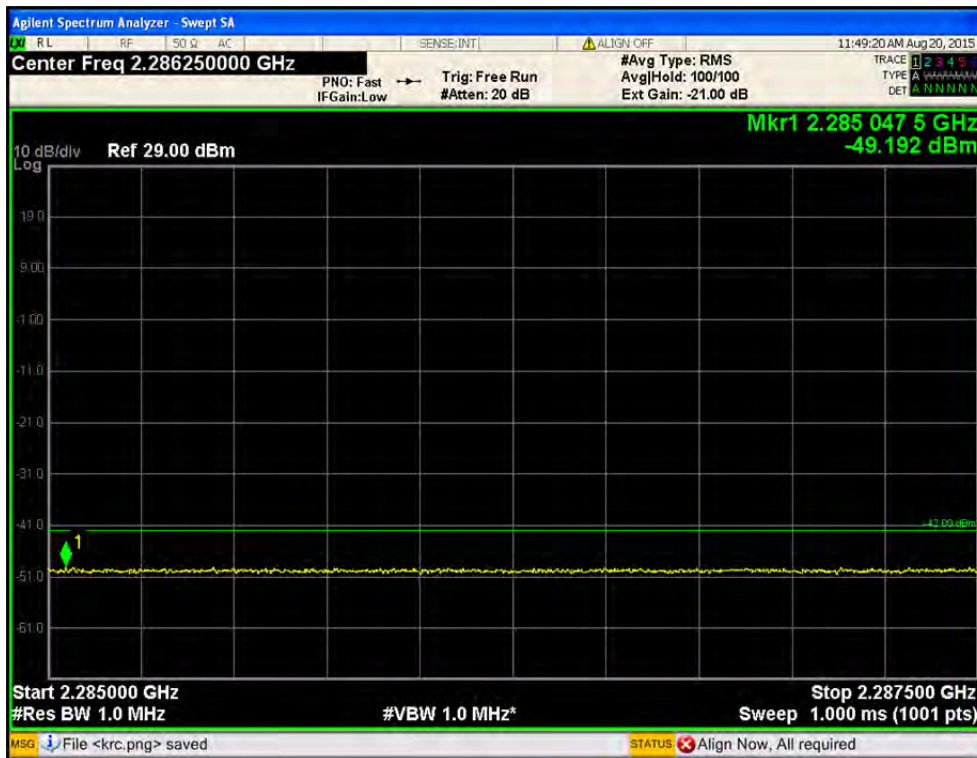

- Port1 / LTE 5 MHz / 2 357.5 MHz / QPSK / below 2 285.0 MHz

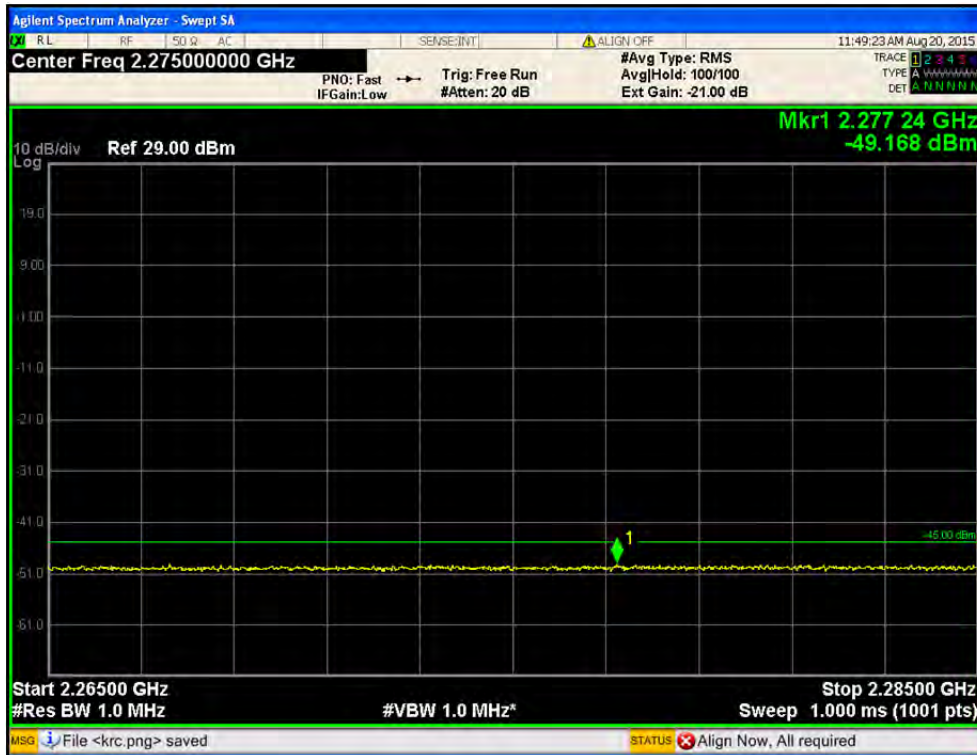

- Port1 / LTE 5 MHz / 2 357.5 MHz / 16QAM / 2360.0 MHz ~ 2362.5 MHz



- Port1 / LTE 5 MHz / 2 357.5 MHz / 16QAM / 2 362.5 MHz ~ 2365.0 MHz



- Port1 / LTE 5 MHz / 2 357.5 MHz / 16QAM / 2365.0 MHz ~ 2367.5 MHz

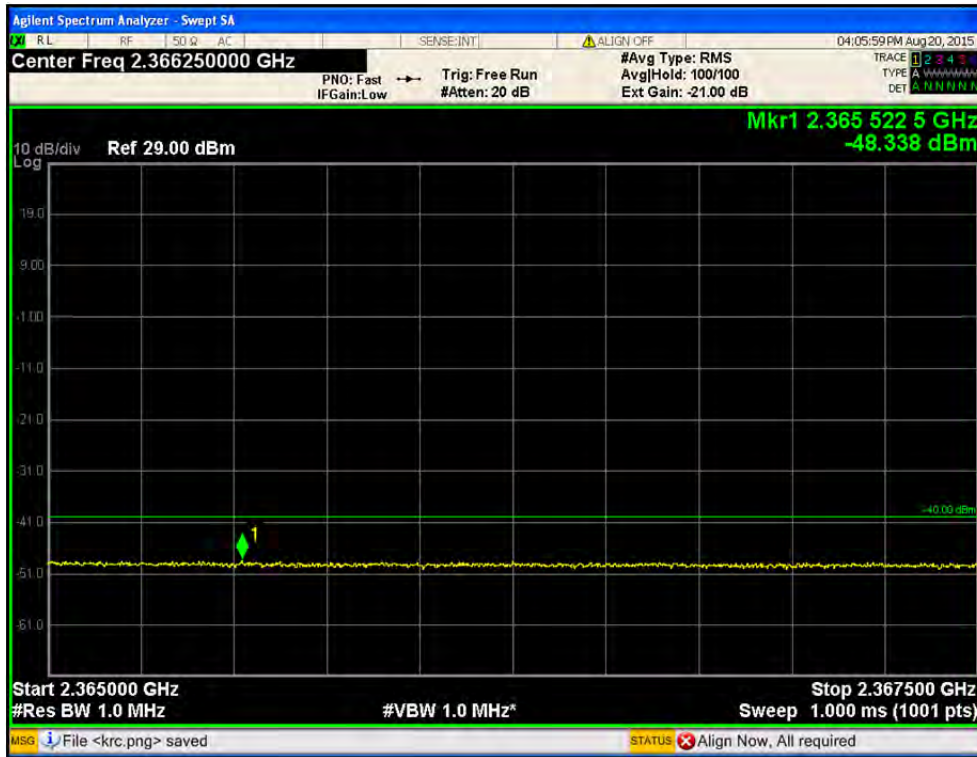

- Port1 / LTE 5 MHz / 2 357.5 MHz / 16QAM / 2 367.5 MHz ~ 2370.0 MHz

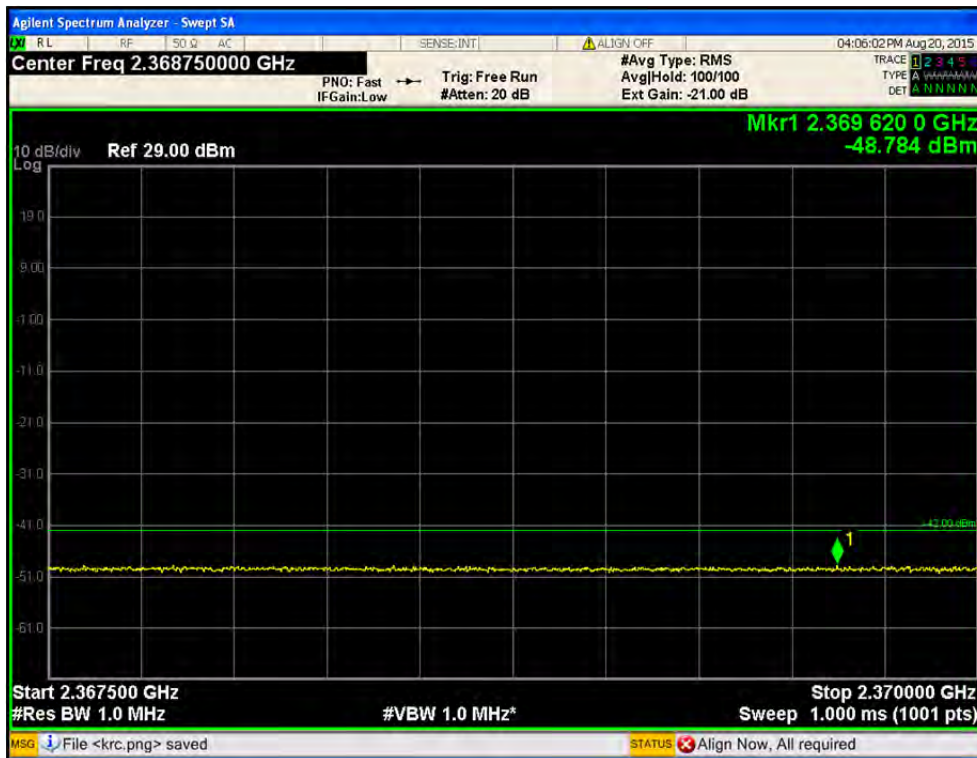

- Port1 / LTE 5 MHz / 2 357.5 MHz / 16QAM / above 2 370.0 MHz

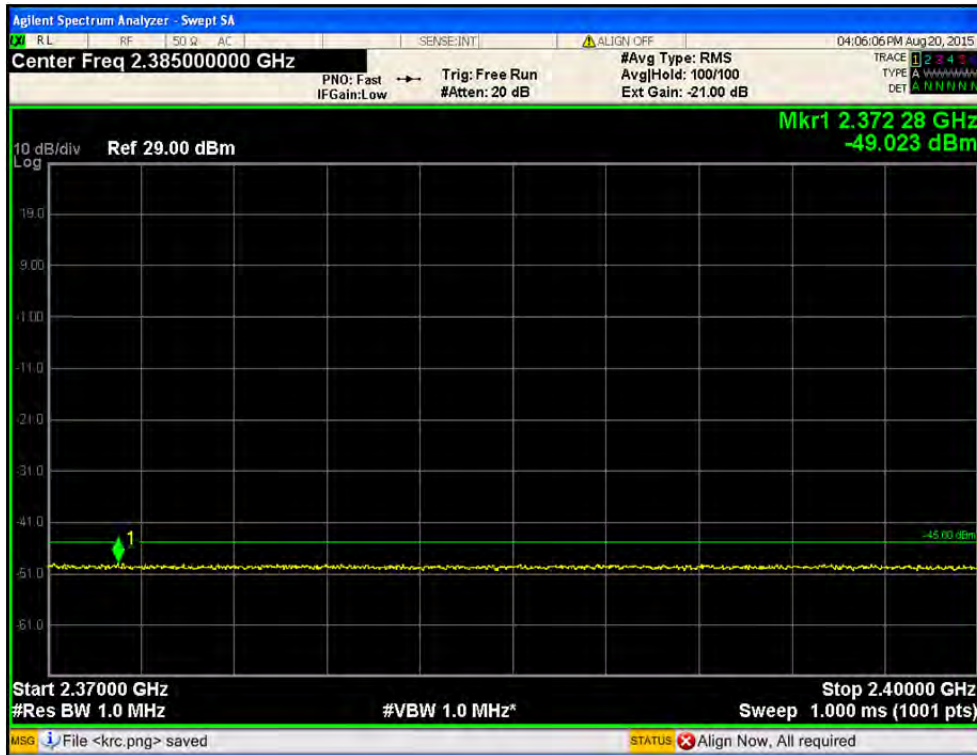

- Port1 / LTE 5 MHz / 2 357.5 MHz / 16QAM / 2 320.0 MHz ~ 2345.0 MHz

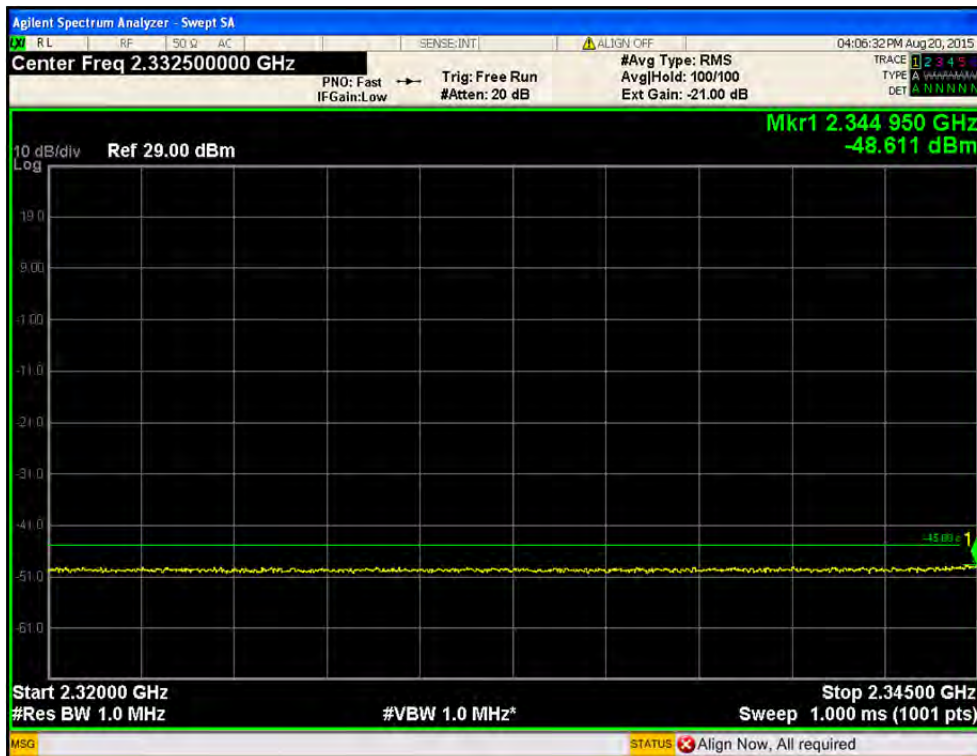

- Port1 / LTE 5 MHz / 2 357.5 MHz / 16QAM / 2 305.0 MHz ~ 2 320.0 MHz

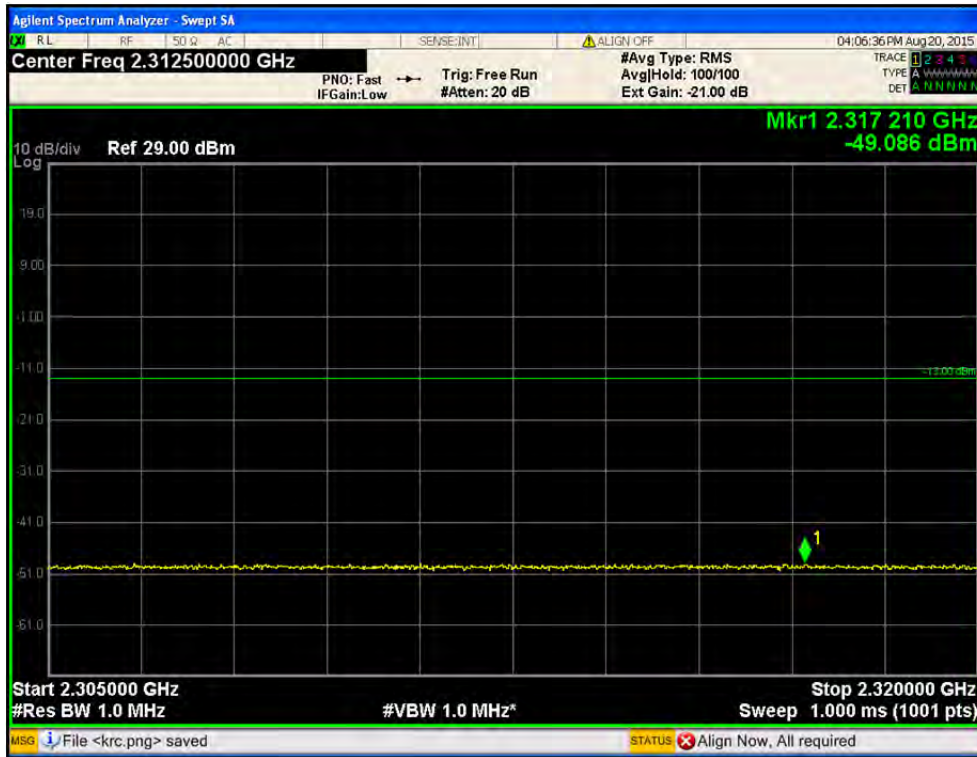

- Port1 / LTE 5 MHz / 2 357.5 MHz / 16QAM / 2 300.0 MHz ~ 2305.0 MHz

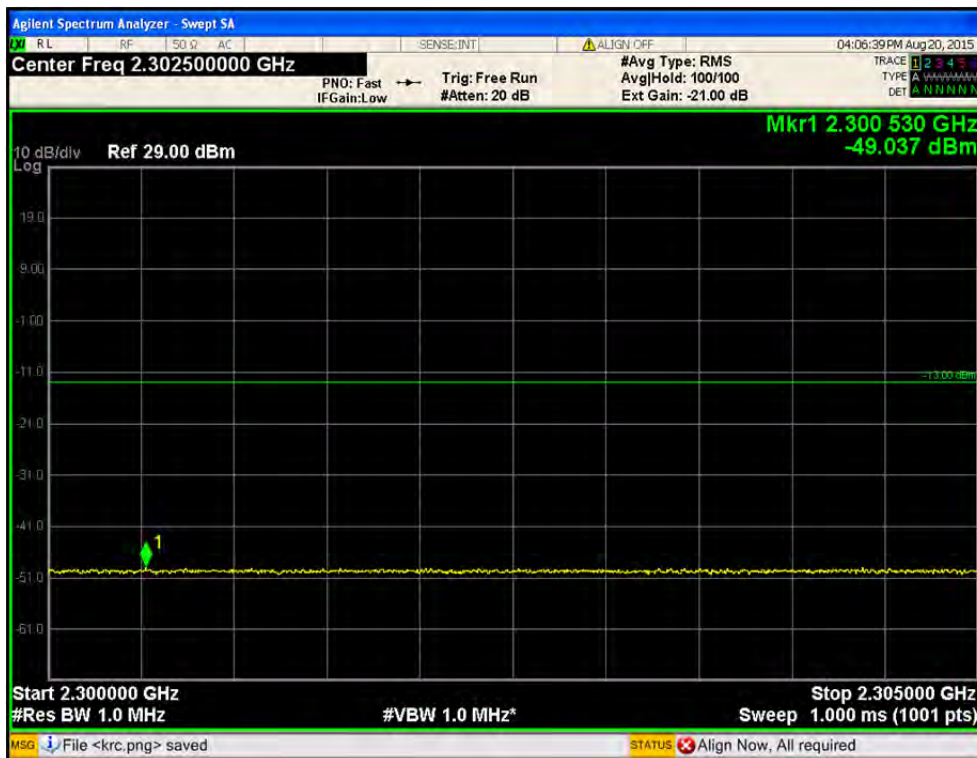

- Port1 / LTE 5 MHz / 2 357.5 MHz / 16QAM / 2 287.5 MHz ~ 2 300.0 MHz

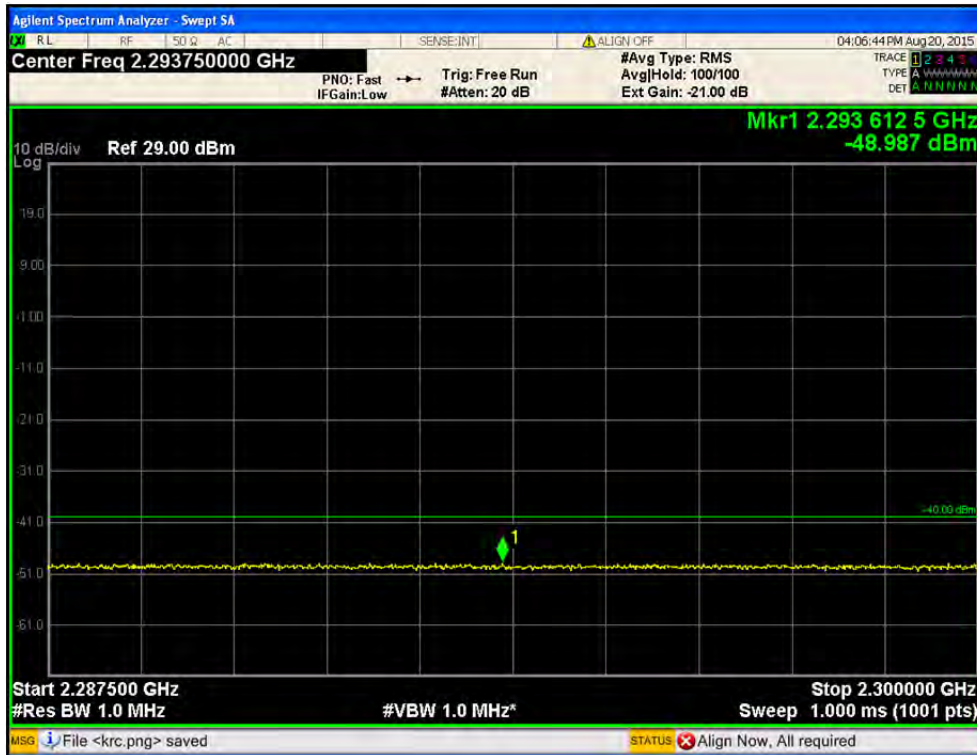

- Port1 / LTE 5 MHz / 2 357.5 MHz / 16QAM / 2 285.0 MHz ~ 2 287.5 MHz

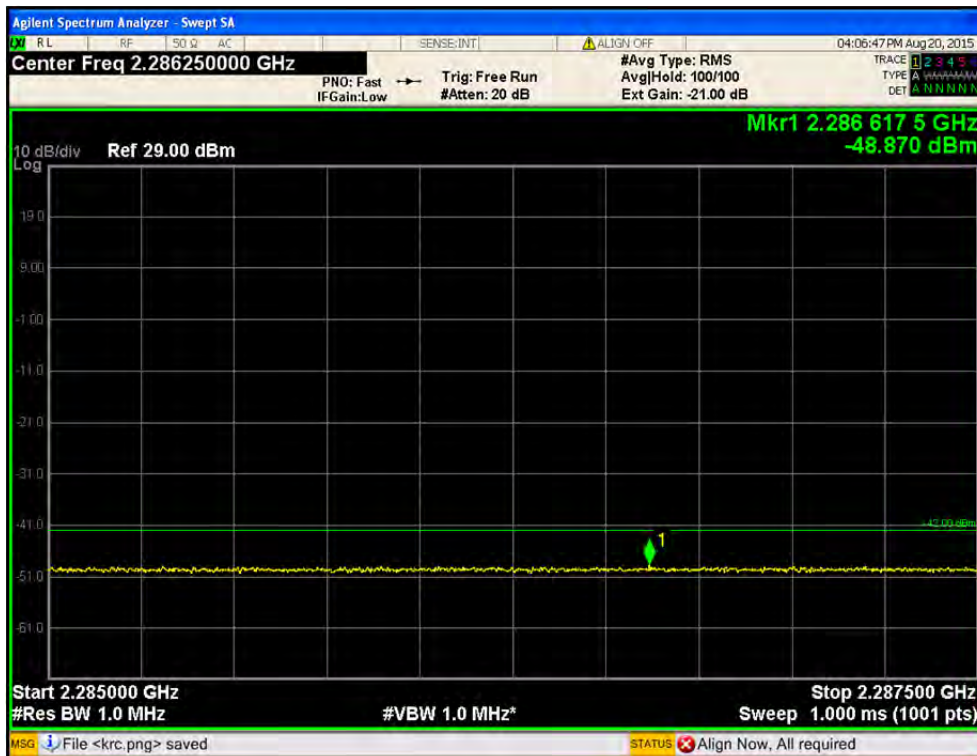

- Port1 / LTE 5 MHz / 2 357.5 MHz / 16QAM / below 2 285.0 MHz

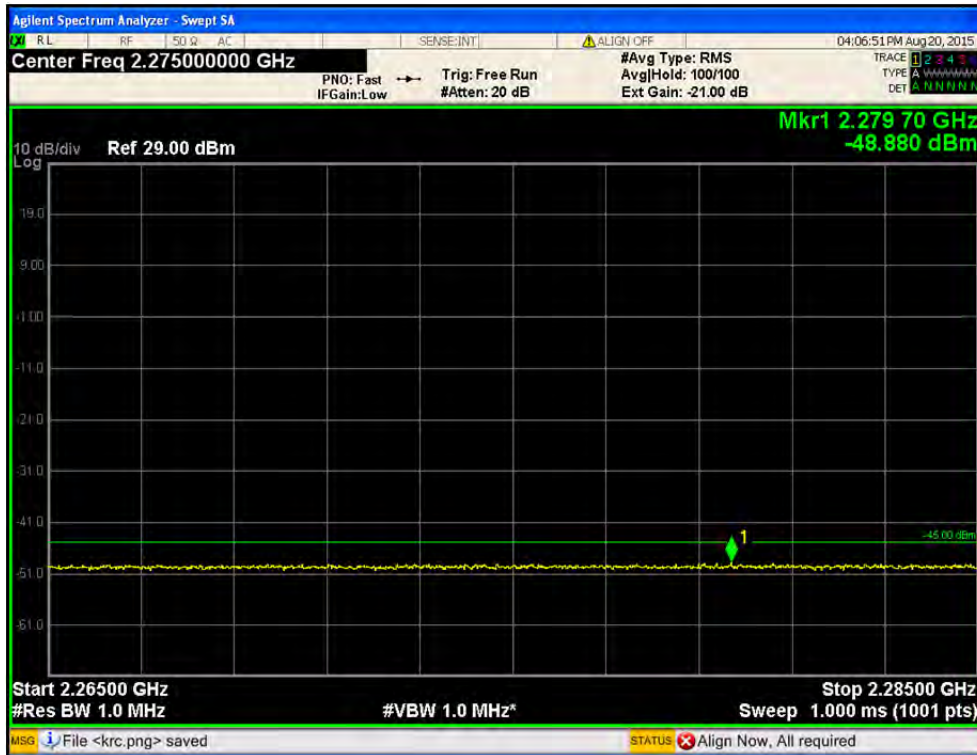

- Port1 / LTE 5 MHz / 2 357.5 MHz / 64QAM / 2360.0 MHz ~ 2362.5 MHz



- Port1 / LTE 5 MHz / 2 357.5 MHz / 64QAM / 2 362.5 MHz ~ 2365.0 MHz



- Port1 / LTE 5 MHz / 2 357.5 MHz / 64QAM / 2365.0 MHz ~ 2367.5 MHz

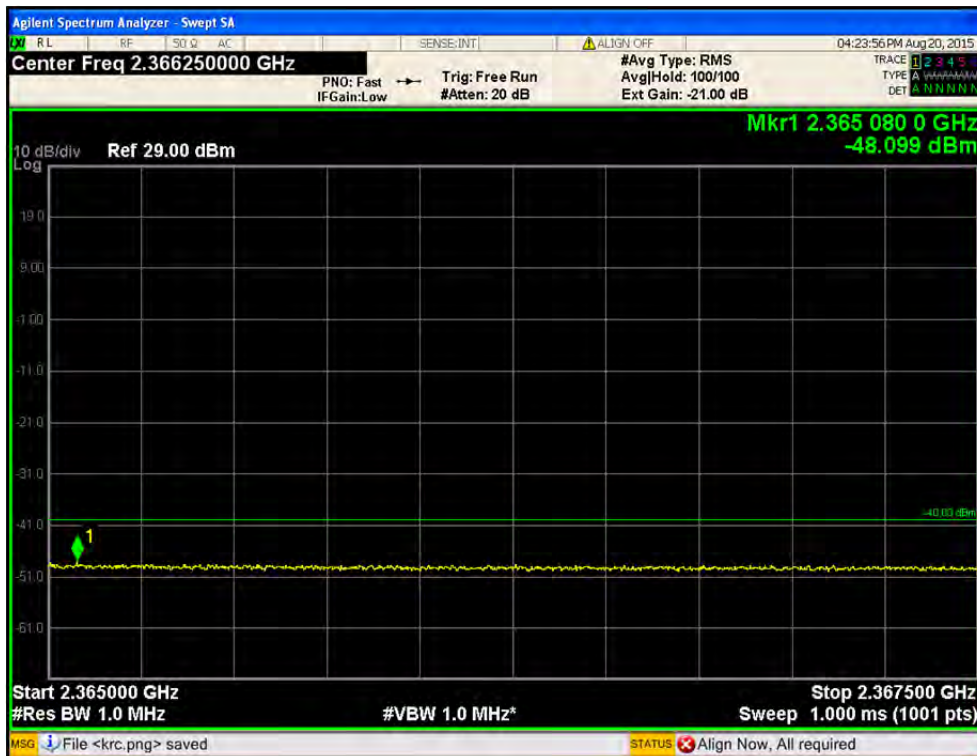

- Port1 / LTE 5 MHz / 2 357.5 MHz / 64QAM / 2 367.5 MHz ~ 2370.0 MHz

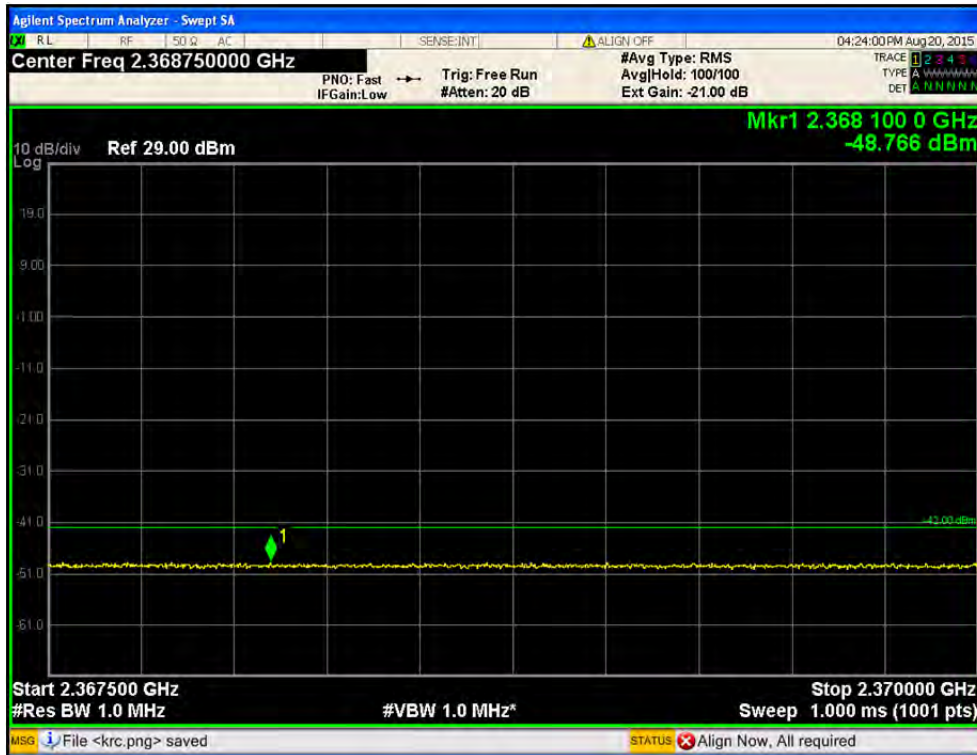

- Port1 / LTE 5 MHz / 2 357.5 MHz / 64QAM / above 2 370.0 MHz

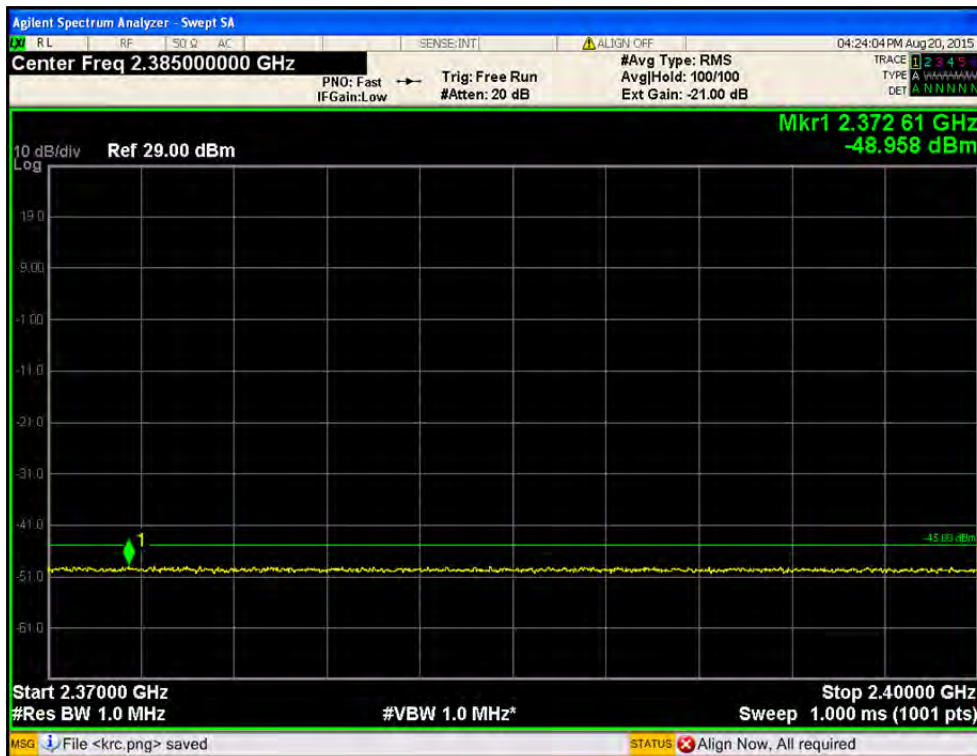

- Port1 / LTE 5 MHz / 2 357.5 MHz / 64QAM / 2 320.0 MHz ~ 2345.0 MHz

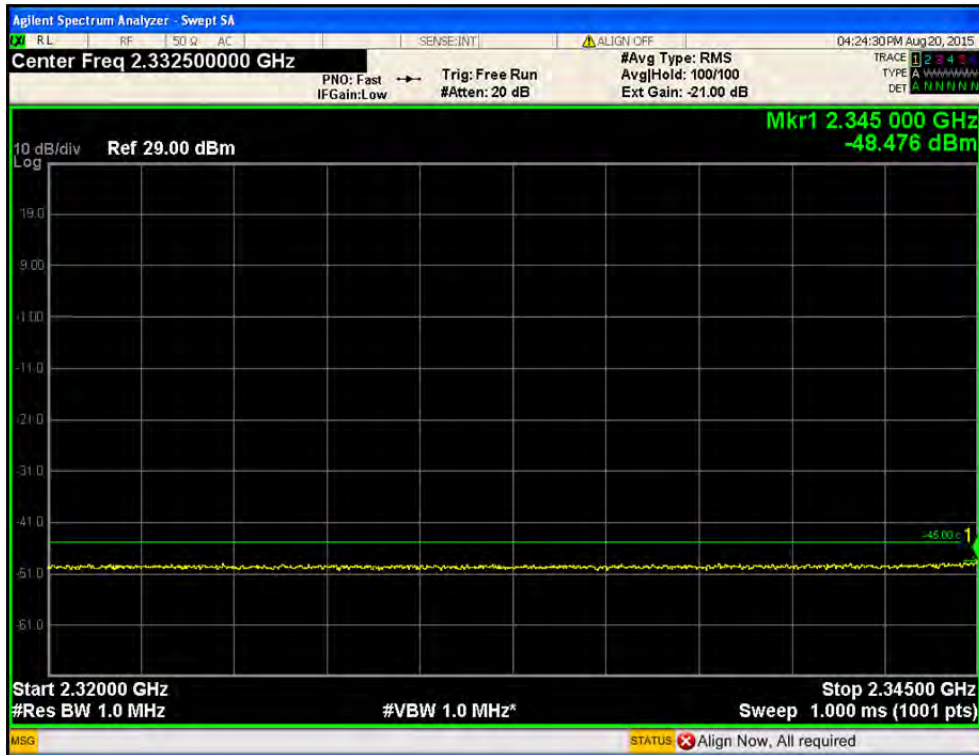

- Port1 / LTE 5 MHz / 2 357.5 MHz / 64QAM / 2 305.0 MHz ~ 2 320.0 MHz

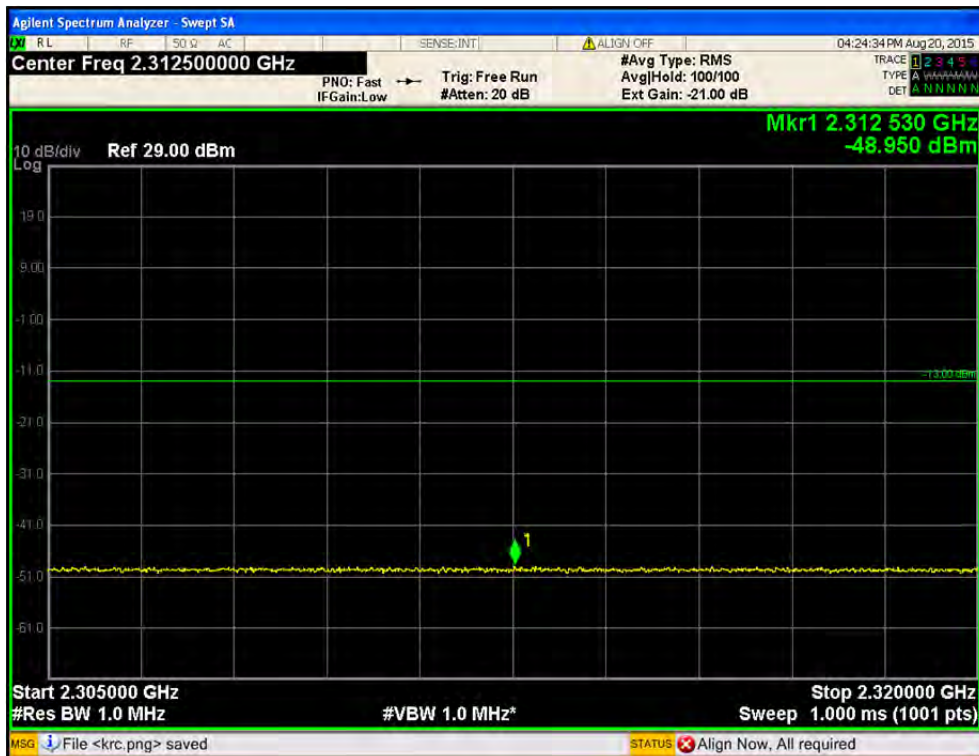

- Port1 / LTE 5 MHz / 2 357.5 MHz / 64QAM / 2 300.0 MHz ~ 2305.0 MHz

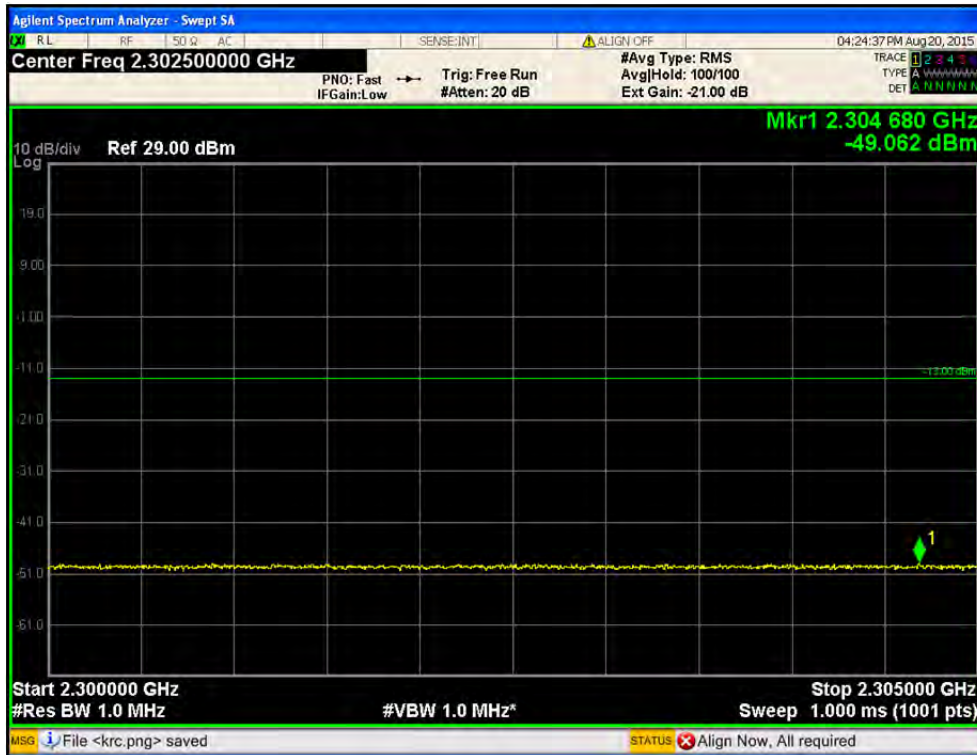

- Port1 / LTE 5 MHz / 2 357.5 MHz / 64QAM / 2 287.5 MHz ~ 2 300.0 MHz

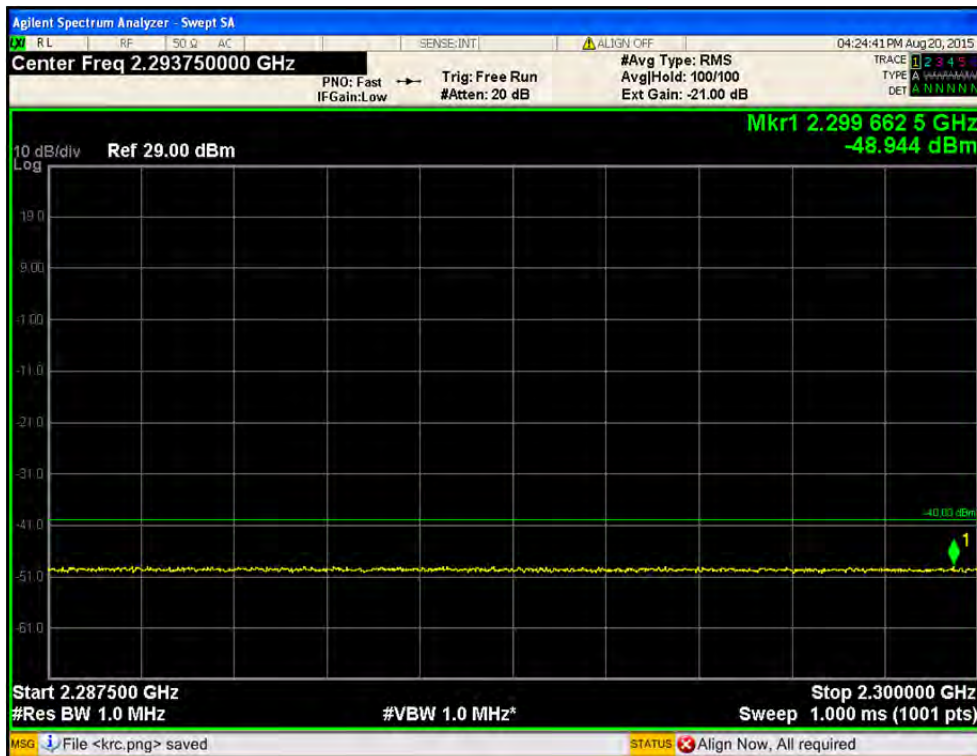

- Port1 / LTE 5 MHz / 2 357.5 MHz / 64QAM / 2 285.0 MHz ~ 2 287.5 MHz

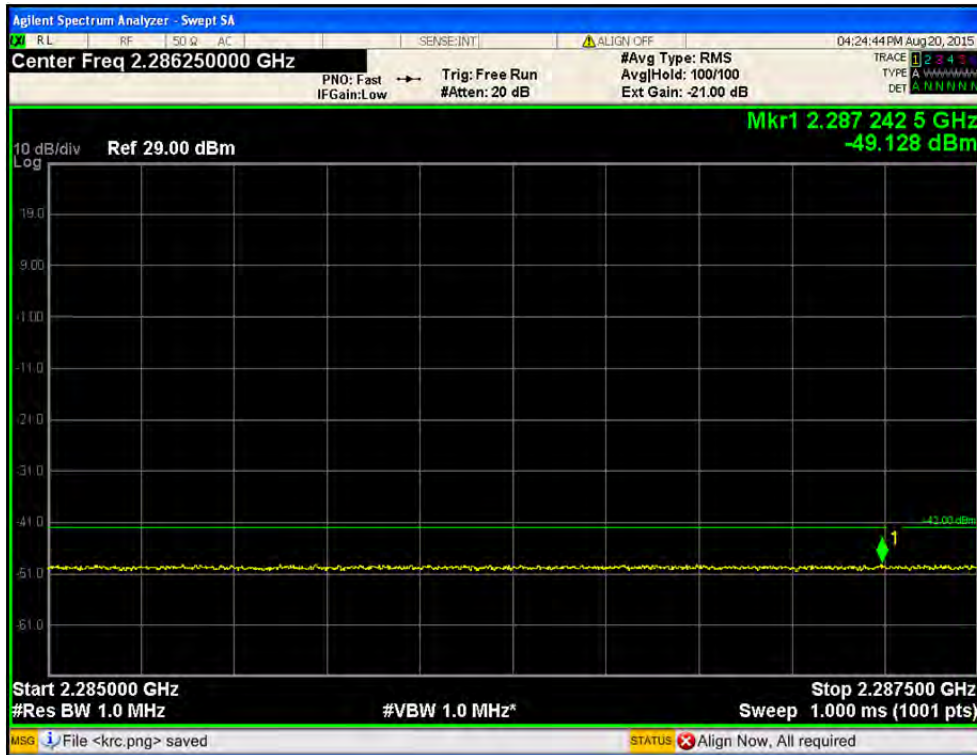

- Port1 / LTE 5 MHz / 2 357.5 MHz / 64QAM / below 2 285.0 MHz

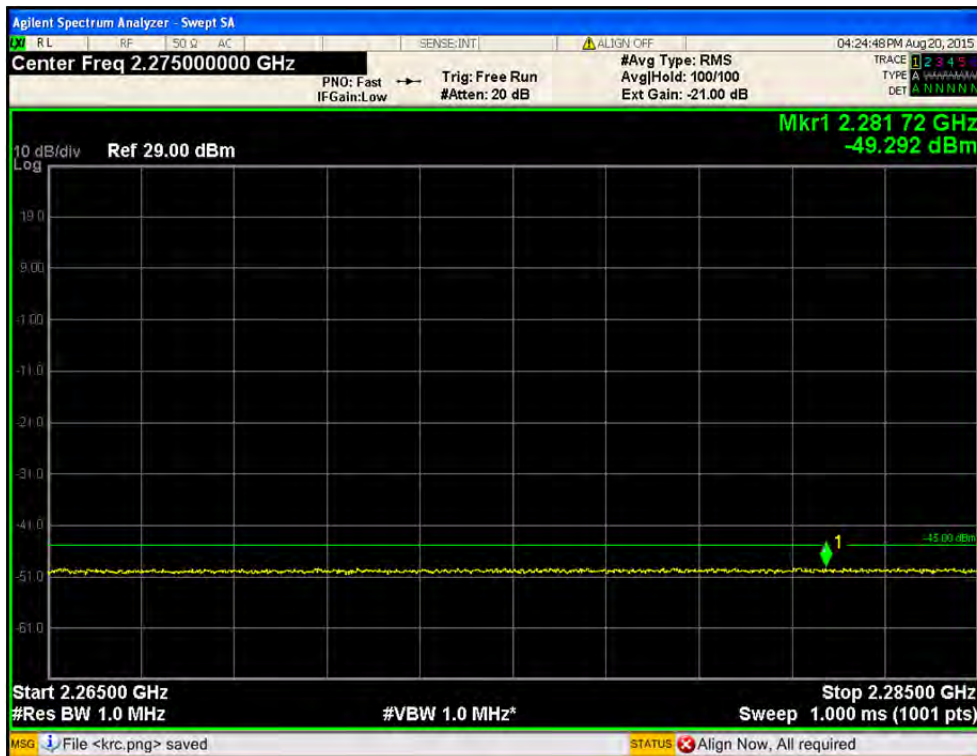

• Port1 / LTE 10 MHz / Emission Mask / QPSK

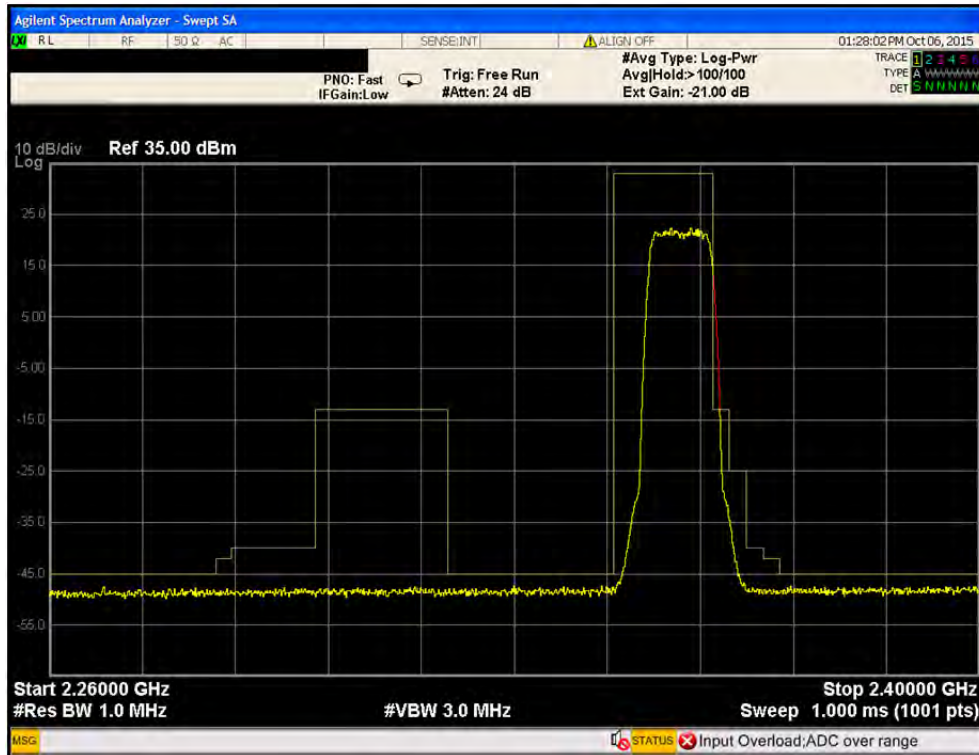

• Port1 / LTE 10 MHz / Emission Mask / 16QAM

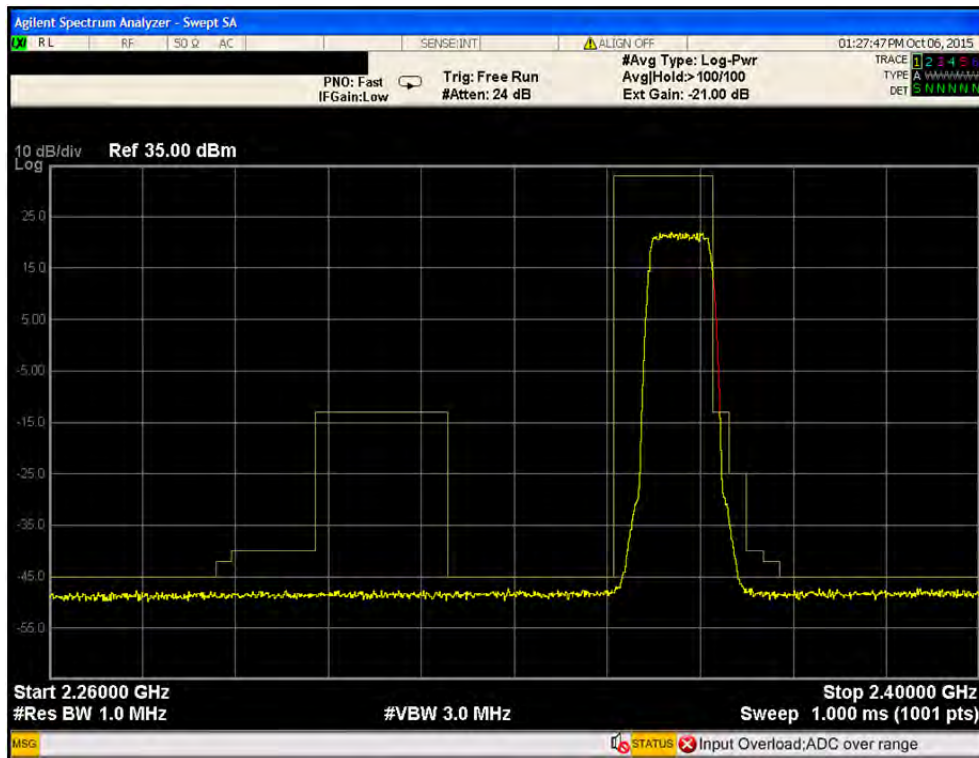

• Port1 / LTE 10 MHz / Emission Mask / 64QAM

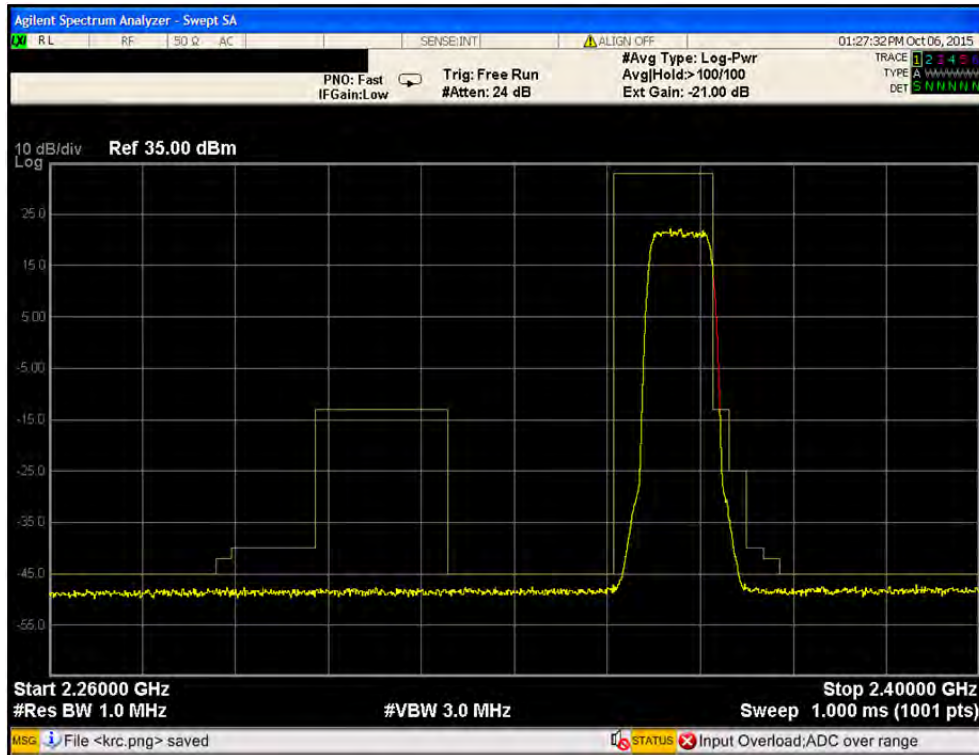

• Port1 / LTE 5 MHz / 2 352.5MHz Emission Mask / QPSK

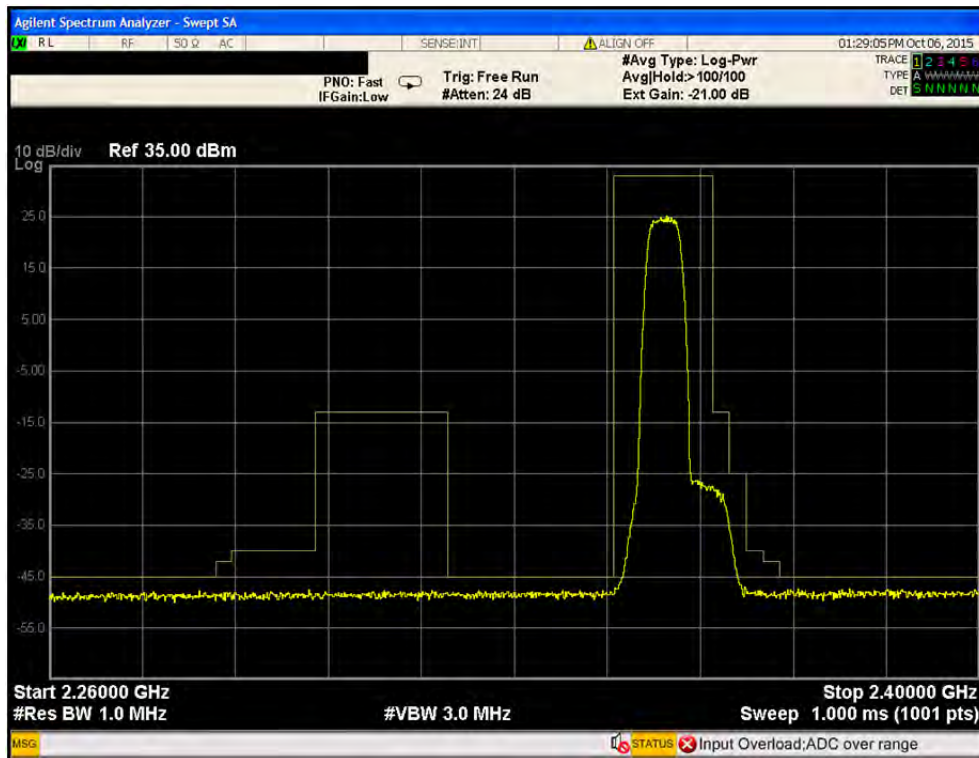

• Port1 / LTE 5 MHz / 2 352.5MHz/ Emission Mask / 16QAM

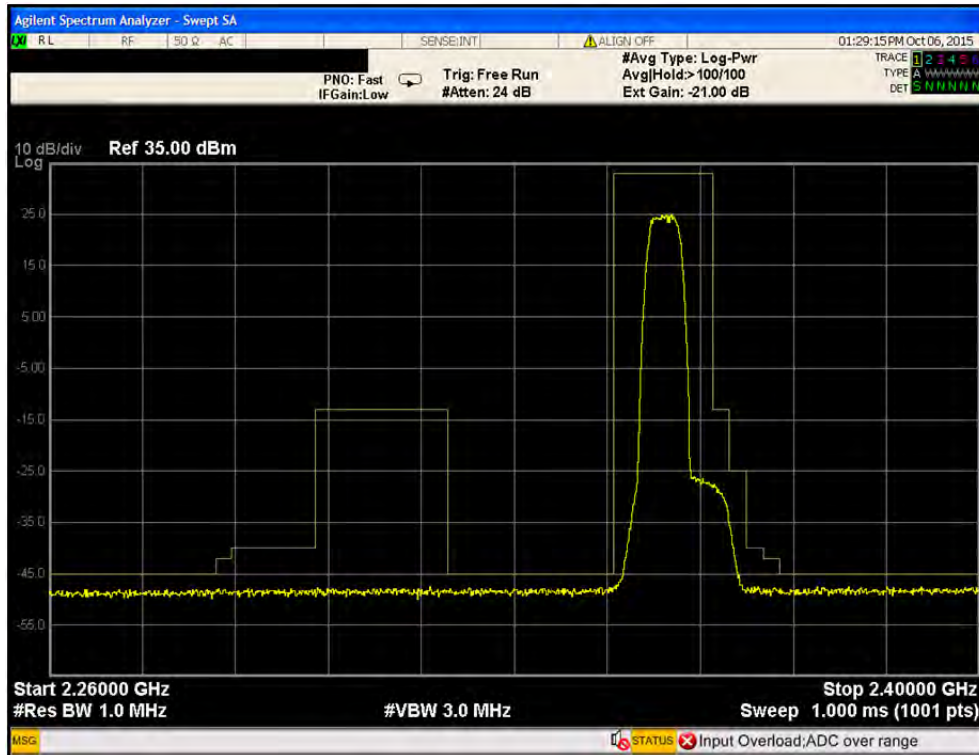

• Port1 / LTE 5 MHz / 2 352.5 MHz/ Emission Mask / 64QAM

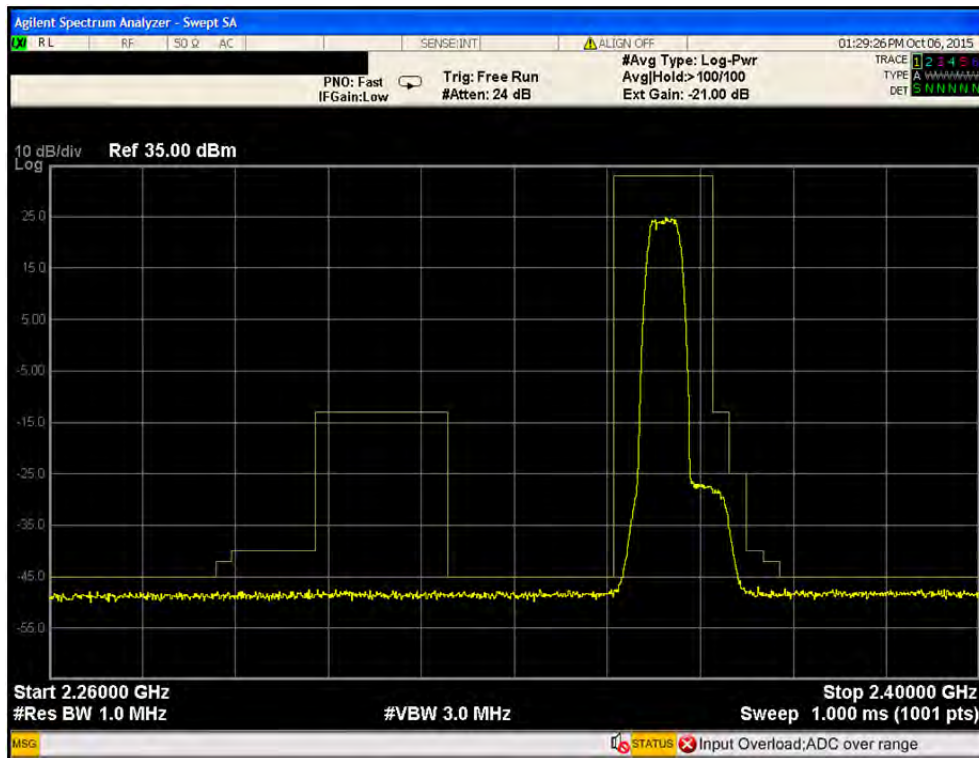

• Port1 / LTE 5 MHz / 2357.5 MHz / Emission Mask / QPSK

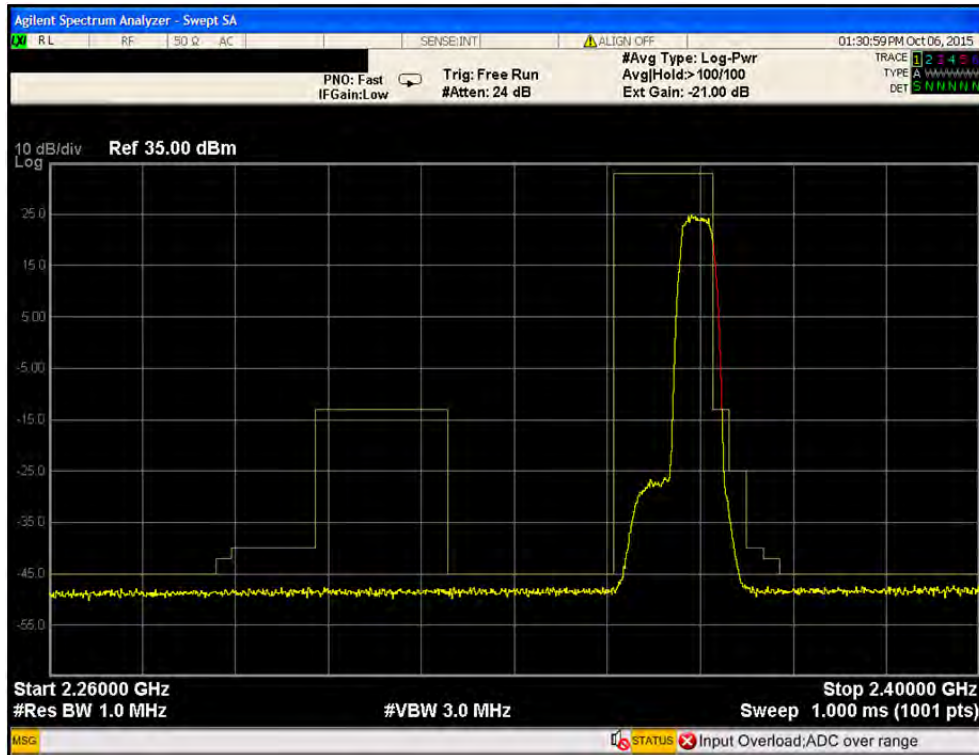

• Port1 / LTE 5 MHz / 2357.5 MHz / Emission Mask / 16QAM

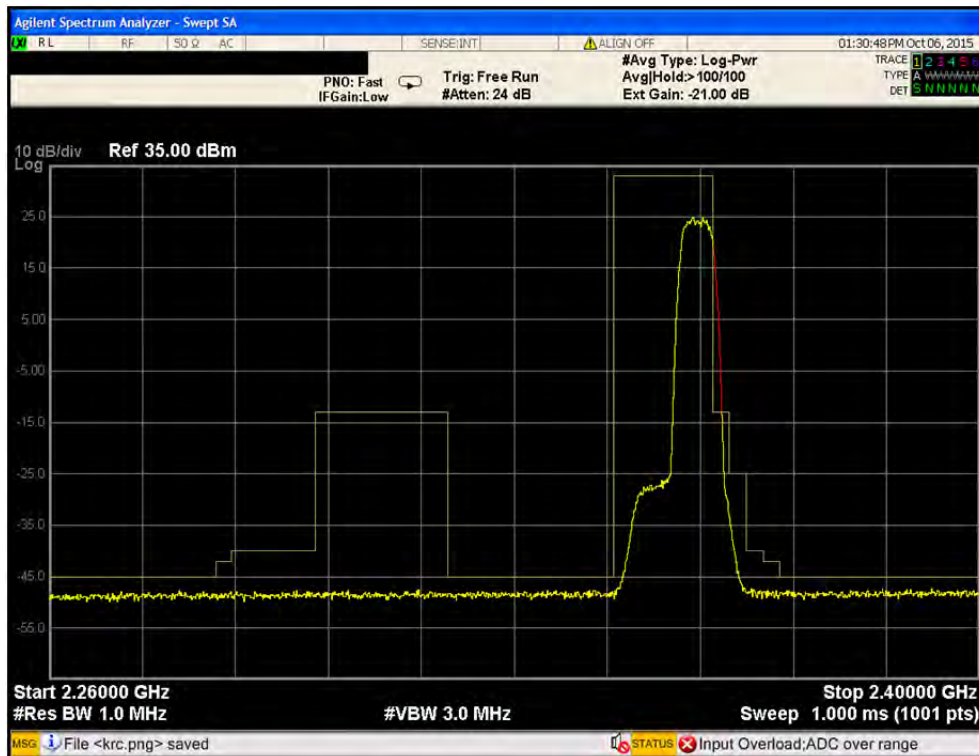

• Port1 / LTE 5 MHz / 2357.5 MHz / Emission Mask / 64QAM

