

3.3.3 two signal input —Lower Edge

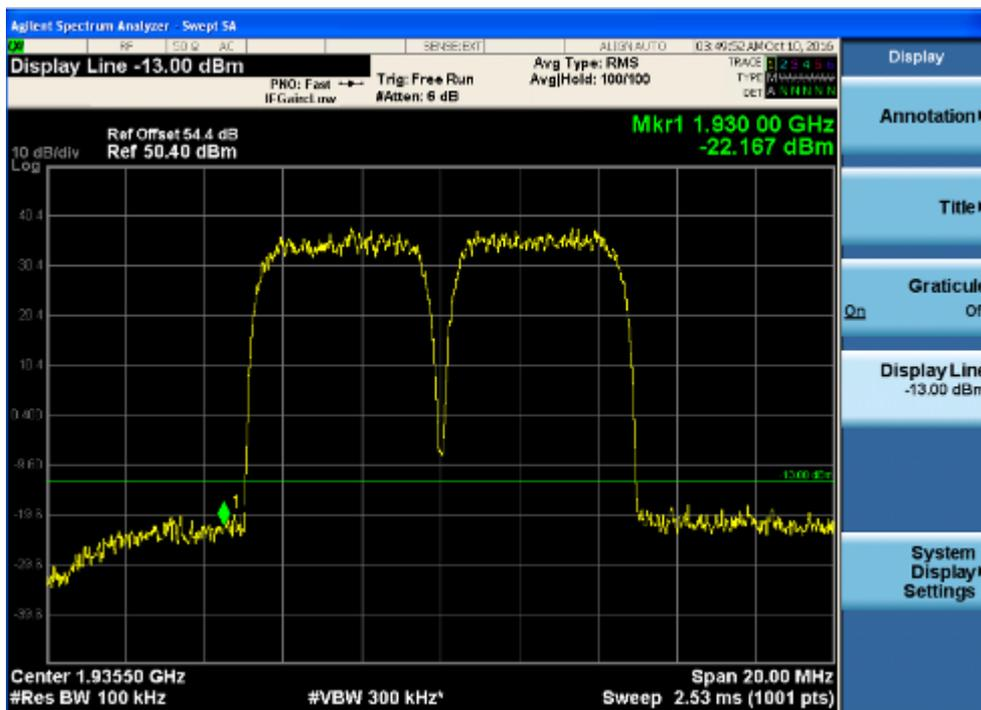

3.3.4 two signal input —Upper Edge

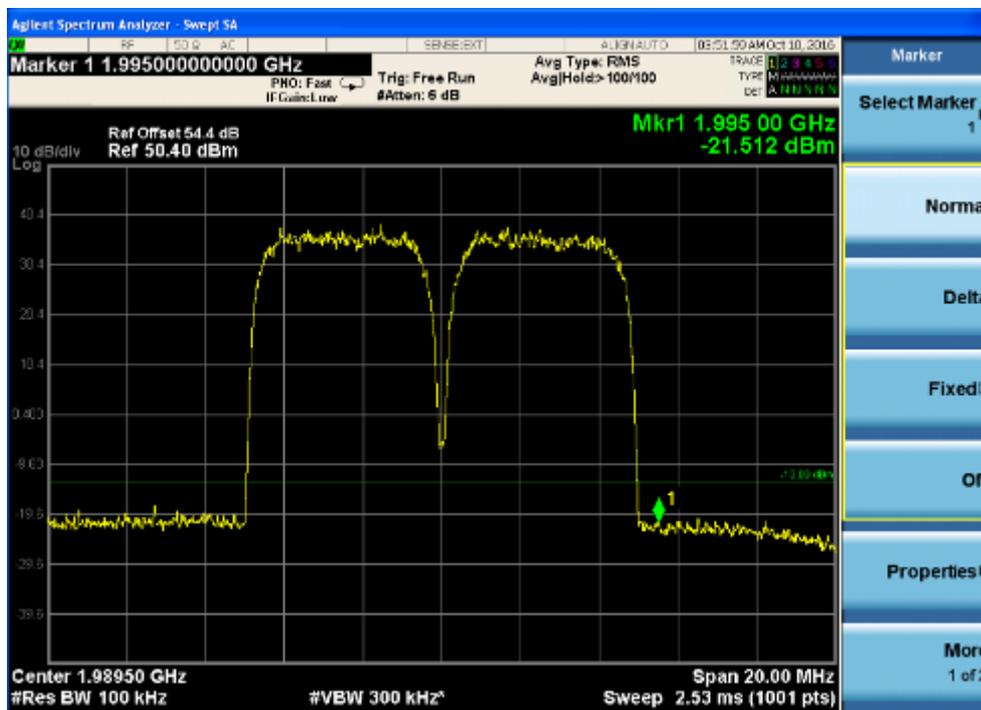



3.4 LTE Mode:

3.4.1 one signal input —Lower Edge

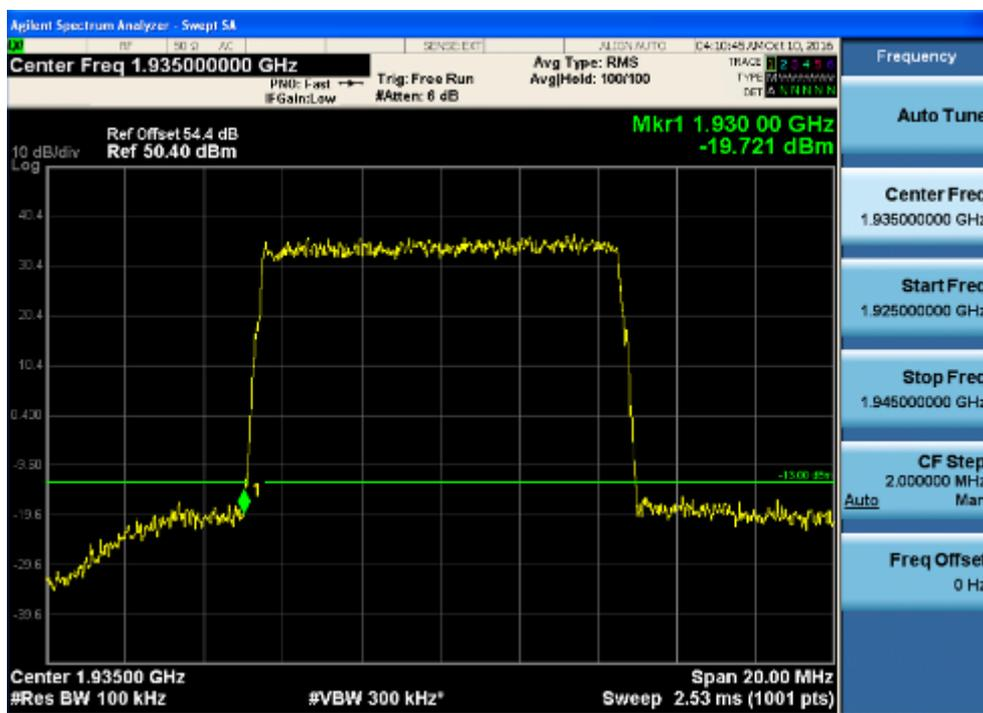

3.4.2 one signal input — Upper Edge

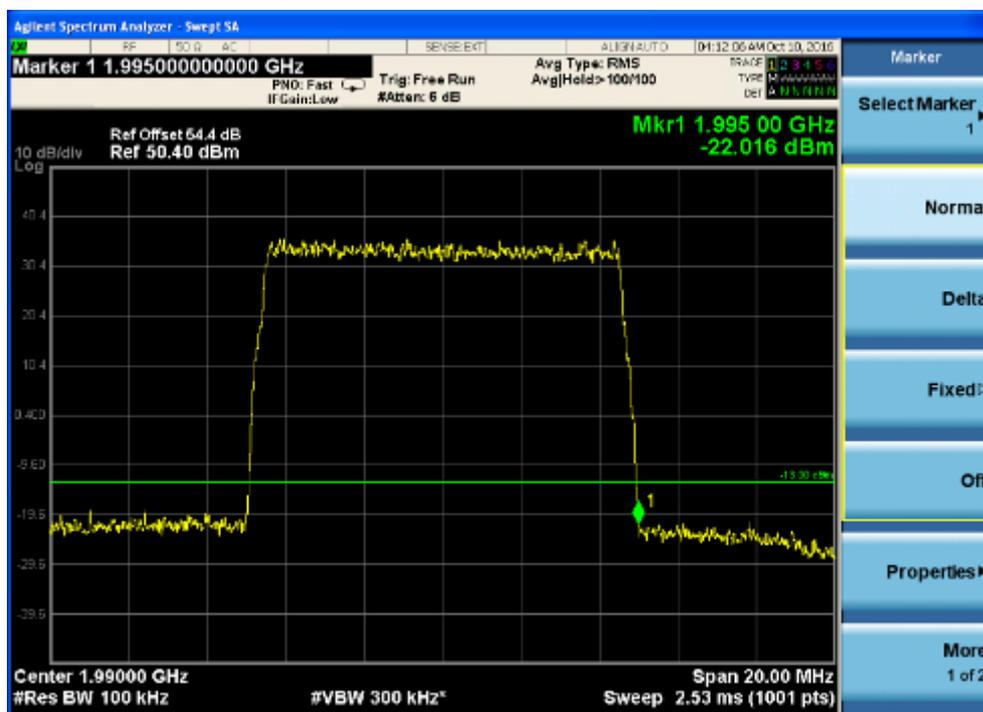

3.4.3 two signal input —Lower Edge

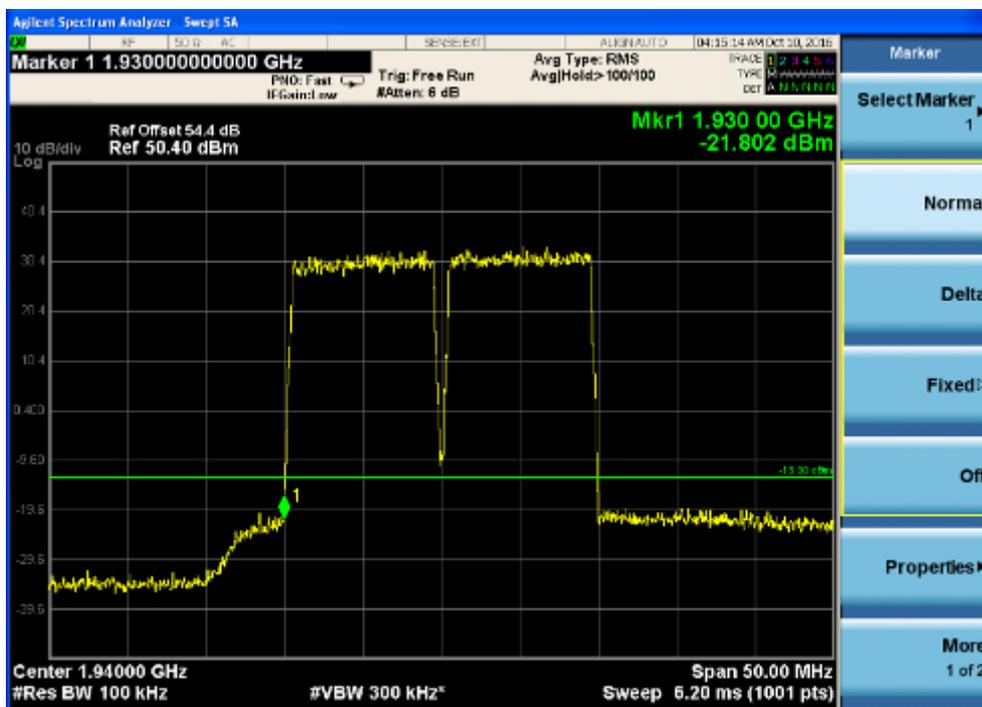

3.4.4 two signal input —Upper Edge

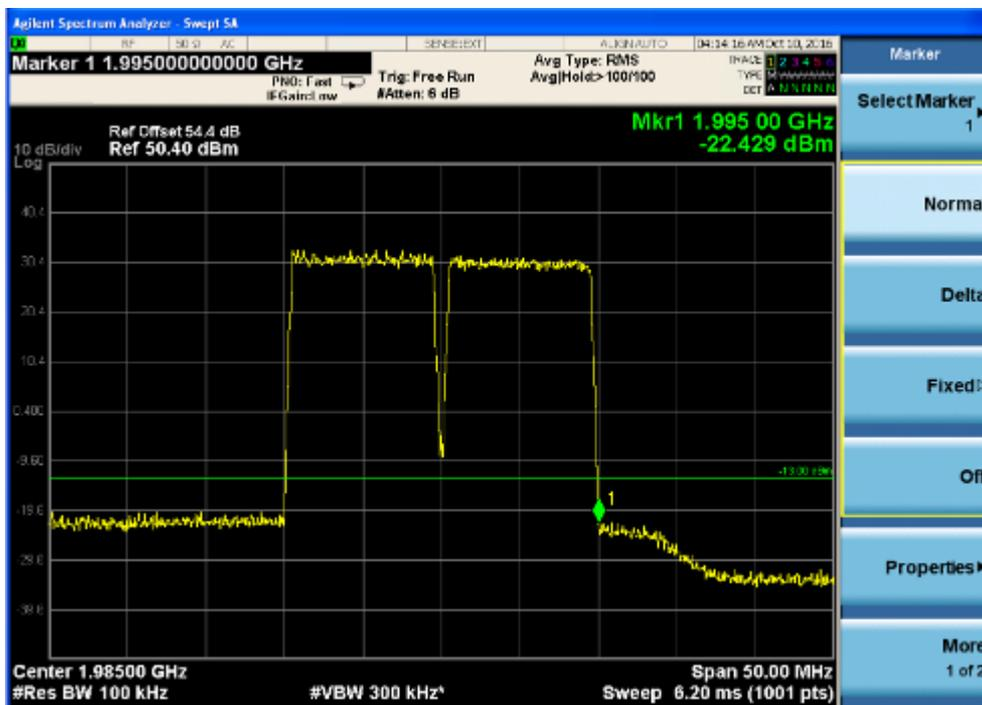



3.5 intermodulation spurious emissions

For GSM mode:

3.5.1 Input frequency:

1)in lower edge test:f1 is the lower edge frequency +1 channel frequency, and f2 is +2 channel frequency

f1=1930.6MHz,f2=1931.2MHz

2)in higher edge test:f1 is the higher edge frequency -2 channel frequency, and f2 is -1 channel frequency

f1=1994MHz,f2=1994.6MHz

base the 3rd product frequency F1= 2f1-f2 and F2=2f2-f1, when the f1 and f2 frequency select above,

m) in lower edge test, F1=2f1-(f1+Δf)=f1-Δf=lower edge frequency;

n) in higher edge test, F2=2f2-(f2-Δf)=f2+Δf=higher edge frequency.

F1=1930MHz,F2=1995MHz

base the 5th product frequency F1= 3f1-2f2 and F2=3f2-2f1, when the f1 and f2 frequency select above,

m) in lower edge test, F1=3f1-2(f1+Δf)=f1-2Δf=lower edge frequency;

n) in higher edge test, F2=3f2-2(f2-Δf)=f2+2Δf=higher edge frequency.

F1=1929.4MHz,F2=1995.6MHz

base the 7th product frequency F1= 4f1-3f2 and F2=4f2-3f1, when the f1 and f2 frequency select above,

m) in lower edge test, F1=4f1-3(f1+Δf)=f1-3Δf=lower edge frequency;

n) in higher edge test, F2=4f2-3(f2-Δf)=f2+3Δf=higher edge frequency.

F1=1928.8MHz,F2=1996.2MHz

3.5.2 Input power:-20dBm

measure frequency		product Value (dBm)	Limit (dBm)	Margin (dB)
3 rd	Lower:1930MHz	-17.06	-13dBm	-4.06
	Higher:1995MHz	-20.60		-7.6
5 th	Lower:1929.4MHz	-21.25	-13dBm	-8.25
	Higher:1995.6MHz	-21.96		-8.96
7 th	Lower:1928.8MHz	-24.67	-13dBm	-11.67
	Higher:1996.2MHz	-23.83		-10.83



For CDMA mode:

3.5.3 Input frequency:

1) in lower edge test: f1 is the lower edge frequency +1 channel frequency, and f2 is +2 channel frequency

f1=1930MHz, f2=1932MHz

2) in higher edge test: f1 is the higher edge frequency -2 channel frequency, and f2 is -1 channel frequency

f1=1991MHz, f2=1993MHz

base the 3rd product frequency F1= 2f1-f2 and F2=2f2-f1, when the f1 and f2 frequency select above,

o) in lower edge test, F1=2f1-(f1+Δf)=f1-Δf=lower edge frequency;

p) in higher edge test, F2=2f2-(f2-Δf)=f2+Δf=higher edge frequency.

F1=1930MHz, F2=1995MHz

base the 5th product frequency F1= 3f1-2f2 and F2=3f2-2f1, when the f1 and f2 frequency select above,

o) in lower edge test, F1=3f1-2(f1+Δf)=f1-2Δf=lower edge frequency;

p) in higher edge test, F2=3f2-2(f2-Δf)=f2+2Δf=higher edge frequency.

F1=1928MHz, F2=1997MHz

base the 7th product frequency F1= 4f1-3f2 and F2=4f2-3f1, when the f1 and f2 frequency select above,

o) in lower edge test, F1=4f1-3(f1+Δf)=f1-3Δf=lower edge frequency;

p) in higher edge test, F2=4f2-3(f2-Δf)=f2+3Δf=higher edge frequency.

F1=1926MHz, F2=1999MHz

3.5.4 Input power:-20dBm

measure frequency		product Value (dBm)	Limit (dBm)	Magin (dB)
3 rd	Lower:1930MHz	-26.28	-13dBm	-13.28
	Higher:1995MHz	-23.30		-10.3
5 rd	Lower:1928MHz	-29.56	-13dBm	-16.56
	Higher:1997MHz	-27.72		-14.72
7 rd	Lower:1926MHz	-32.21	-13dBm	-19.21
	Higher:1999MHz	-31.89		-18.89



For WCDMA mode:

3.5.5 Input frequency:

1) in lower edge test: f1 is the lower edge frequency +1 channel frequency, and f2 is +2 channel frequency

f1=1933MHz, f2=1936MHz

2) in higher edge test: f1 is the higher edge frequency -2 channel frequency, and f2 is -1 channel frequency

f1=1989MHz, f2=1992MHz

base the 3rd product frequency F1= 2f1-f2 and F2=2f2-f1, when the f1 and f2 frequency select above,

q) in lower edge test, F1=2f1-(f1+Δf)=f1-Δf=lower edge frequency;

r) in higher edge test, F2=2f2-(f2-Δf)=f2+Δf=higher edge frequency.

F1=1930MHz, F2=1995MHz

base the 5th product frequency F1= 3f1-2f2 and F2=3f2-2f1, when the f1 and f2 frequency select above,

q) in lower edge test, F1=3f1-2(f1+Δf)=f1-2Δf=lower edge frequency;

r) in higher edge test, F2=3f2-2(f2-Δf)=f2+2Δf=higher edge frequency.

F1=1927MHz, F2=1998MHz

base the 7th product frequency F1= 4f1-3f2 and F2=4f2-3f1, when the f1 and f2 frequency select above,

q) in lower edge test, F1=4f1-3(f1+Δf)=f1-3Δf=lower edge frequency;

r) in higher edge test, F2=4f2-3(f2-Δf)=f2+3Δf=higher edge frequency.

F1=1924MHz, F2=2001MHz

3.5.6 Input power:-20dBm

measure frequency		product Value (dBm)	Limit (dBm)	Magin (dB)
3 rd	Lower:1930MHz	-22.17	-13dBm	-9.17
	Higher:1995MHz	-21.51		-8.51
5 rd	Lower:1927MHz	-26.89	-13dBm	-13.89
	Higher:1998MHz	-27.23		-14.23
7 rd	Lower:1924MHz	-29.47	-13dBm	-16.47
	Higher:2001MHz	-29.92		-16.92



For LTE mode:

3.5.7 Input frequency:

1)in lower edge test:f1 is the lower edge frequency +1 channel frequency, and f2 is +2 channel frequency

$$f1=1935\text{MHz}, f2=1945\text{MHz}$$

2)in higher edge test:f1 is the higher edge frequency -2 channel frequency, and f2 is -1 channel frequency

$$f1=1980\text{MHz}, f2=1990\text{MHz}$$

base the 3rd product frequency $F1=2f1-f2$ and $F2=2f2-f1$, when the f1 and f2 frequency select above,

s) in lower edge test, $F1=2f1-(f1+\Delta f)=f1-\Delta f$ =lower edge frequency;

t) in higher edge test, $F2=2f2-(f2-\Delta f)=f2+\Delta f$ =higher edge frequency.

$$F1=1930\text{MHz}, F2=1995\text{MHz}$$

base the 5rd product frequency $F1=3f1-2f2$ and $F2=3f2-2f1$, when the f1 and f2 frequency select above,

s) in lower edge test, $F1=3f1-2(f1+\Delta f)=f1-2\Delta f$ =lower edge frequency;

t) in higher edge test, $F2=3f2-2(f2-\Delta f)=f2+2\Delta f$ =higher edge frequency.

$$F1=1920\text{MHz}, F2=2005\text{MHz}$$

base the 7rd product frequency $F1=4f1-3f2$ and $F2=4f2-3f1$, when the f1 and f2 frequency select above,

s) in lower edge test, $F1=4f1-3(f1+\Delta f)=f1-3\Delta f$ =lower edge frequency;

t) in higher edge test, $F2=4f2-3(f2-\Delta f)=f2+3\Delta f$ =higher edge frequency.

$$F1=1910\text{MHz}, F2=2015\text{MHz}$$

3.5.8 Input power:-20dBm

measure frequency		product Value (dBm)	Limit (dBm)	Magin (dB)
3 rd	Lower:1930MHz	-21.80	-13dBm	-8.8
	Higher:1995MHz	-22.43		-9.43
5 rd	Lower:1920MHz	-24.72	-13dBm	-11.72
	Higher:2005MHz	-25.21		-12.21
7 rd	Lower:1920MHz	-27.67	-13dBm	-14.67
	Higher:2015MHz	-27.19		-14.19

Remark:



SGS-CSTC Standards Technical Services Co., Ltd.

Report No.: GZEM160900667101

Page: 88 of 163

FCC ID: OJFGXCPLA3

No other intermodulation spurious emissions of above 7rd have been found,so only record the test data about the 3rd, 5rdand 7rd



4. Downlink: 2110MHz to 2180MHz(CDMA,WCDMA,LTE)

4.1 CDMA Mode:

4.1.1 one signal input —Lower Edge

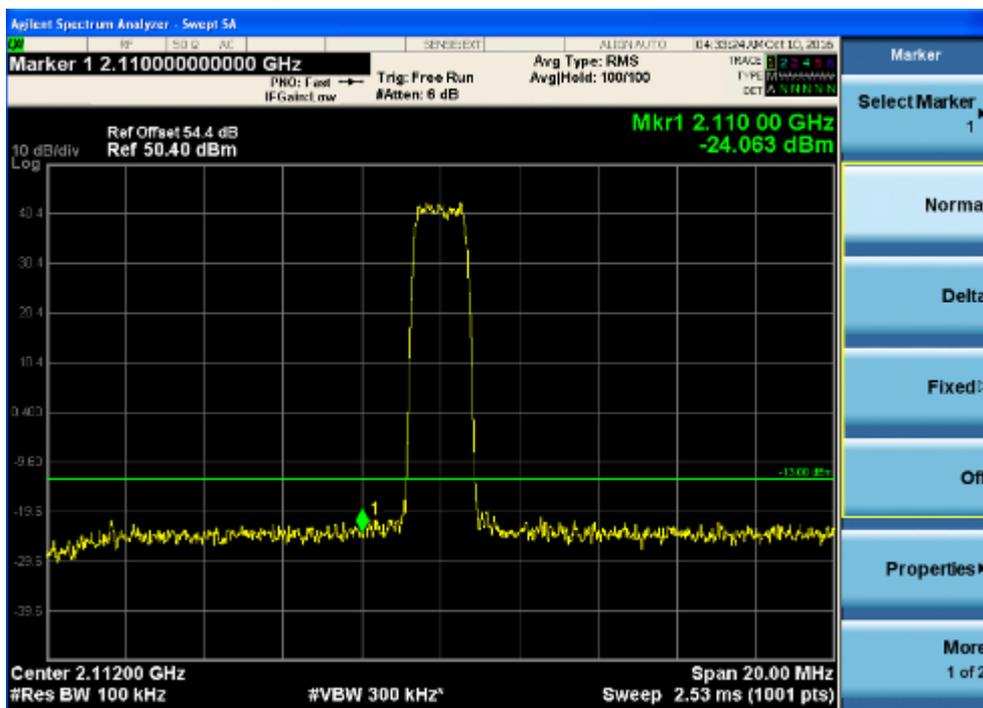

4.1.2 one signal input — Upper Edge

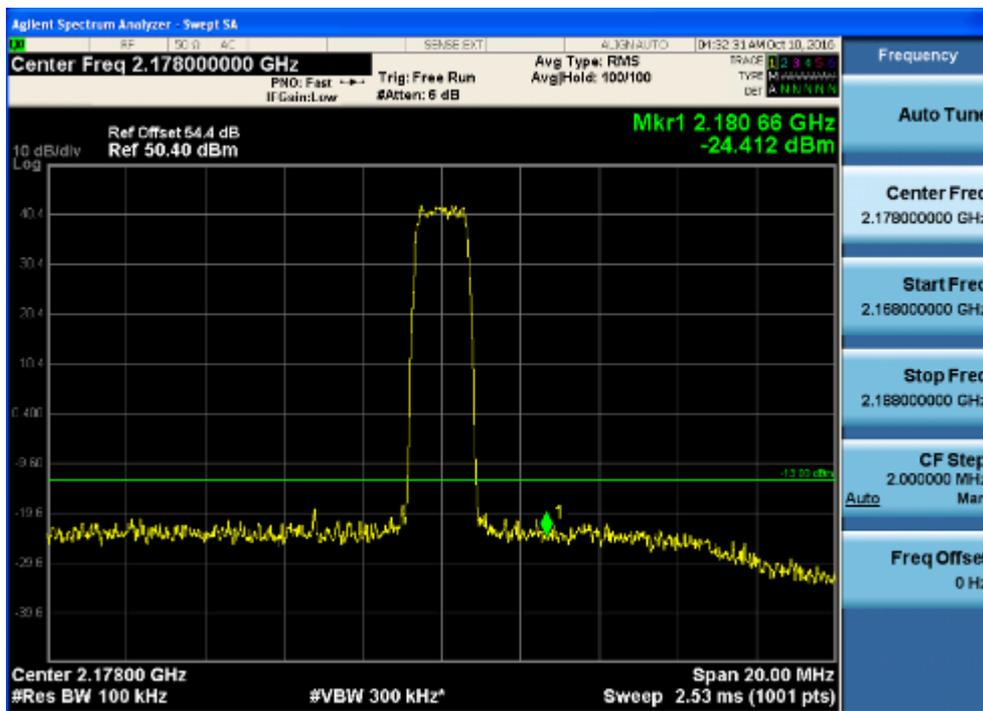



4.1.3 two signal input—Lower Edge

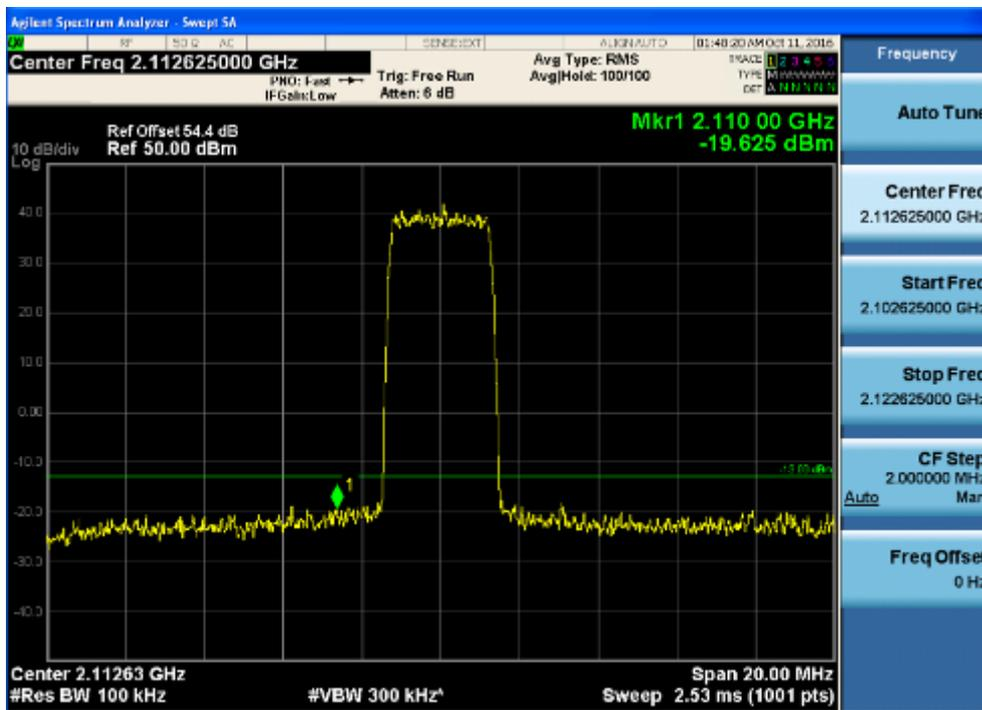

4.1.4 two signal input—Upper Edge

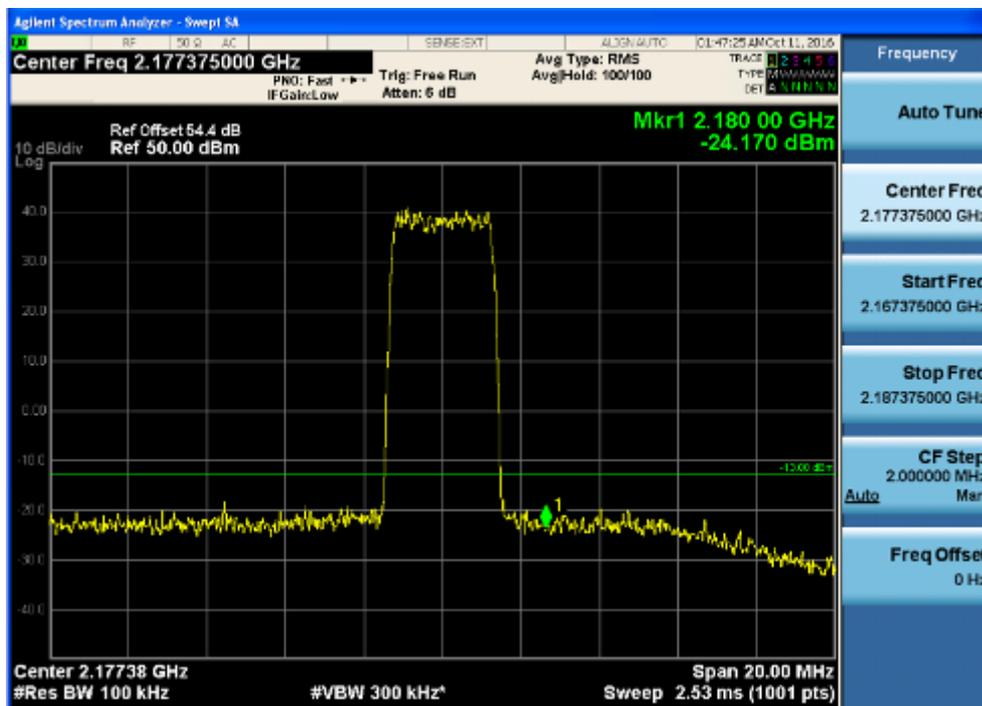



4.2 WDMA Mode:

4.2.1 one signal input —Lower Edge

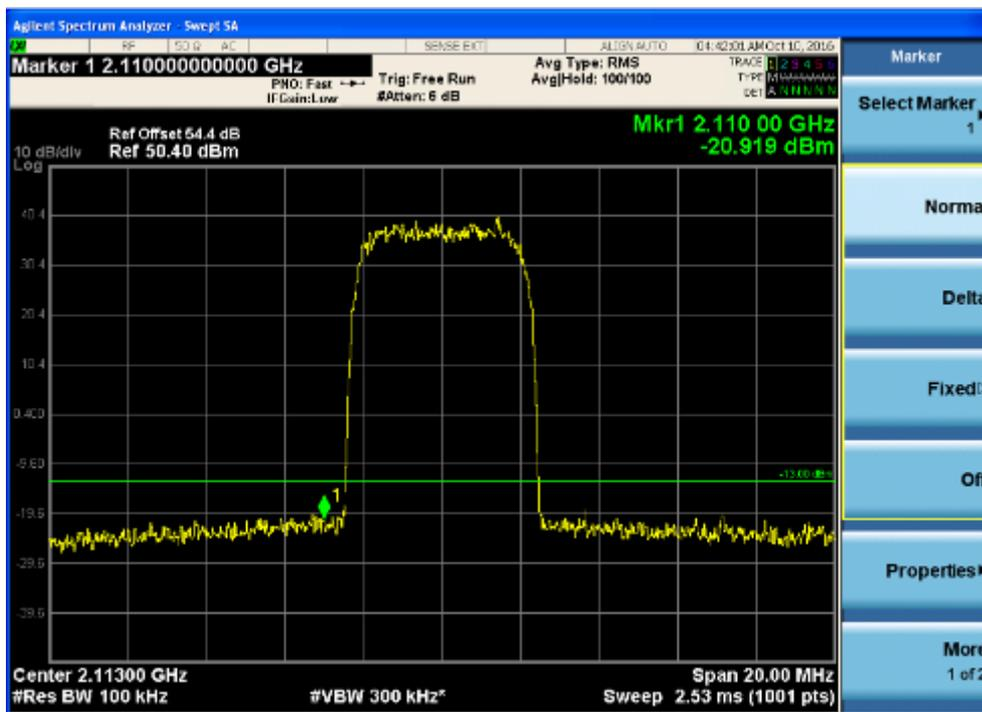

4.2.2 one signal input — Upper Edge

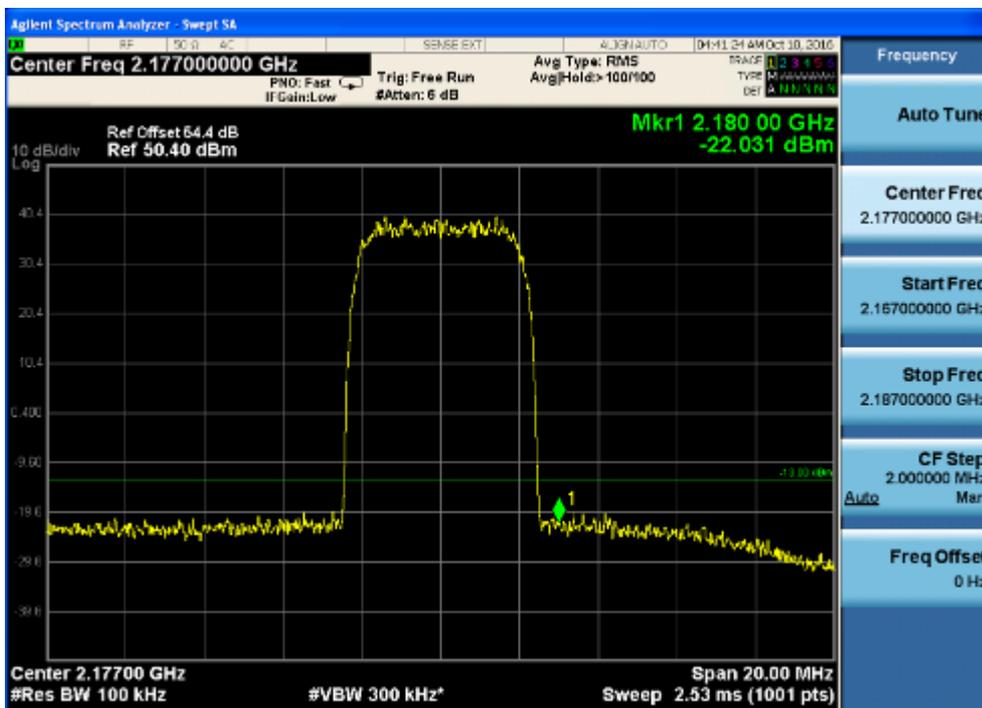

4.2.3 two signal input —Lower Edge

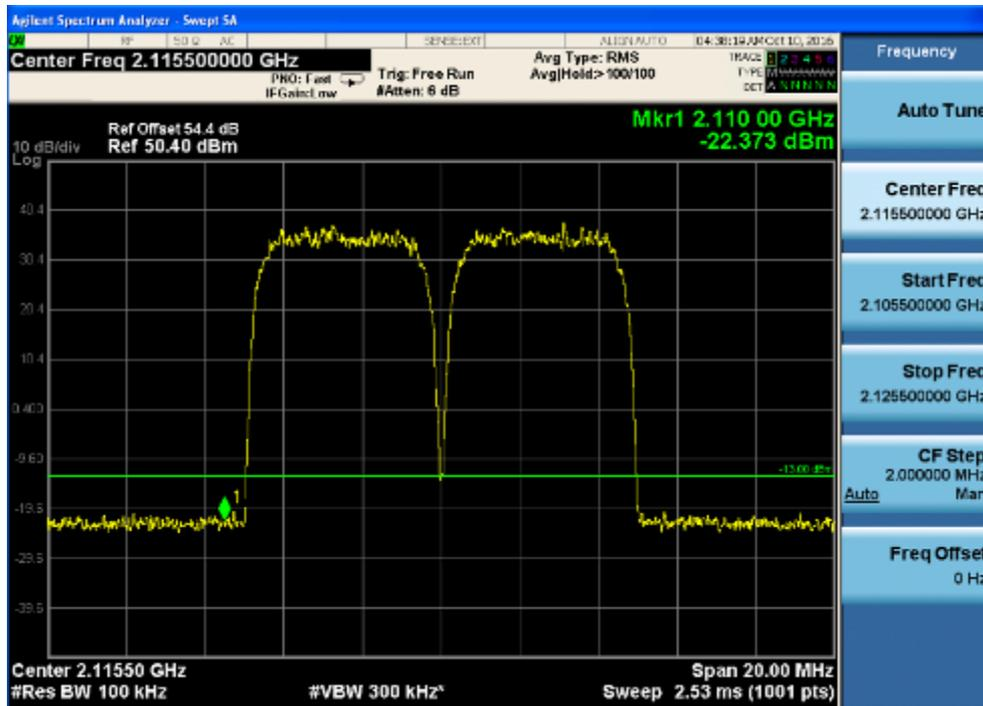

4.2.4 two signal input —Upper Edge

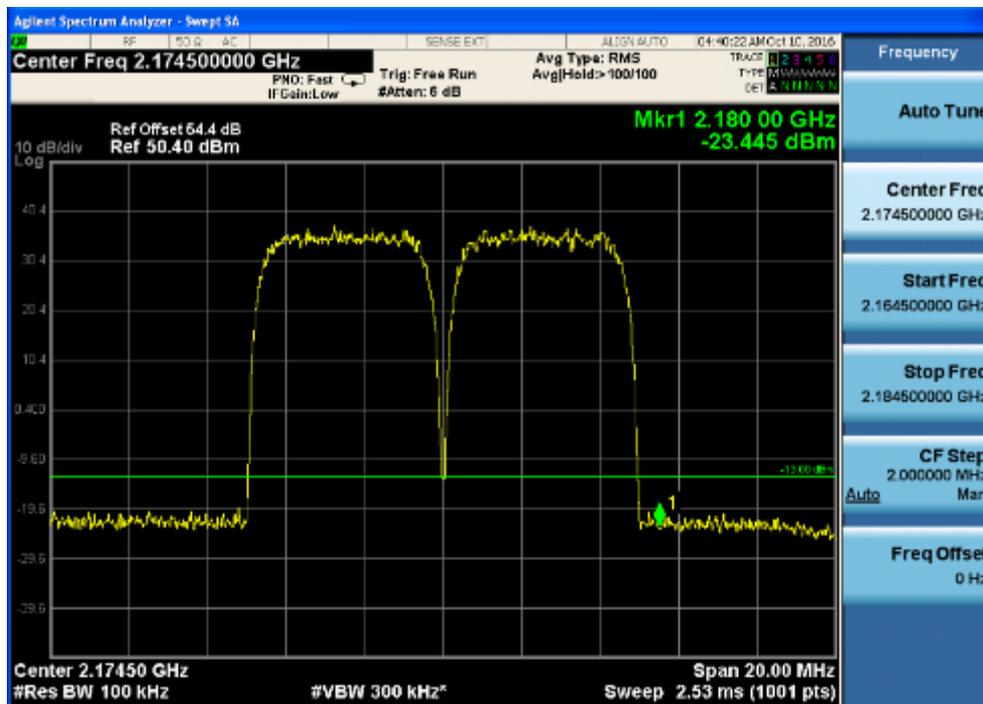



4.3 LTE Mode:

4.3.1 one signal input —Lower Edge

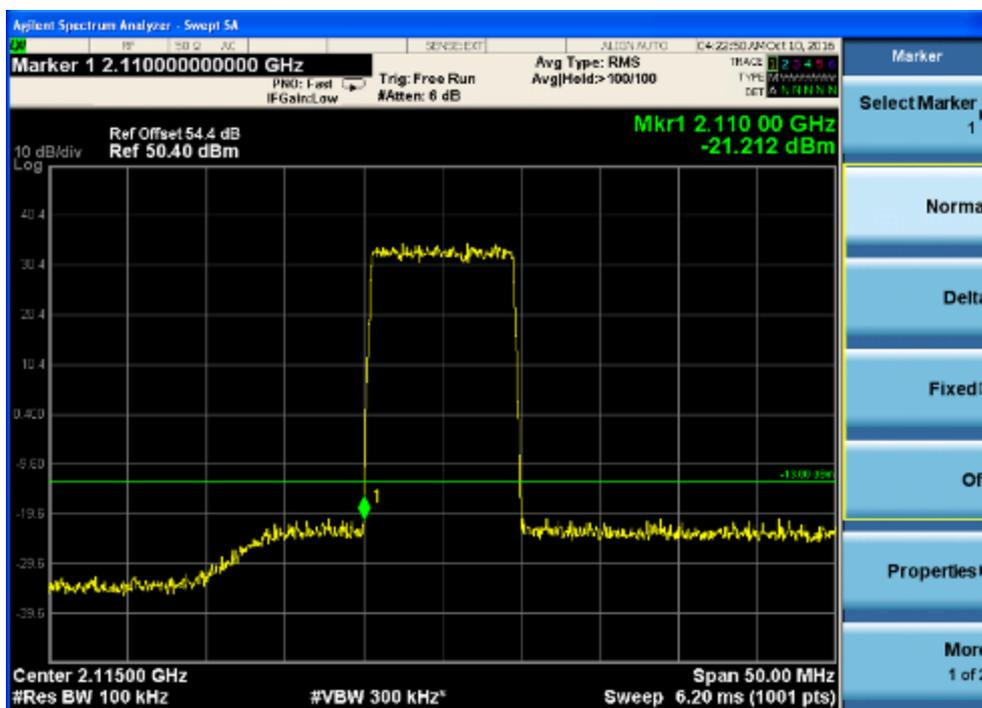

4.3.2 one signal input — Upper Edge

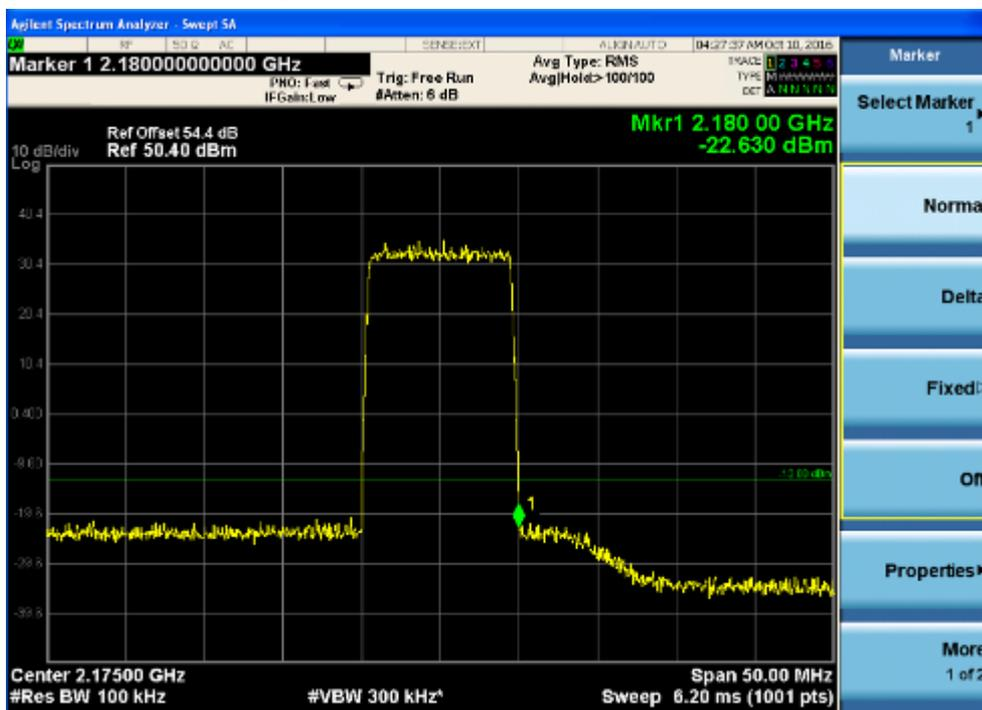

4.3.3 two signal input —Lower Edge

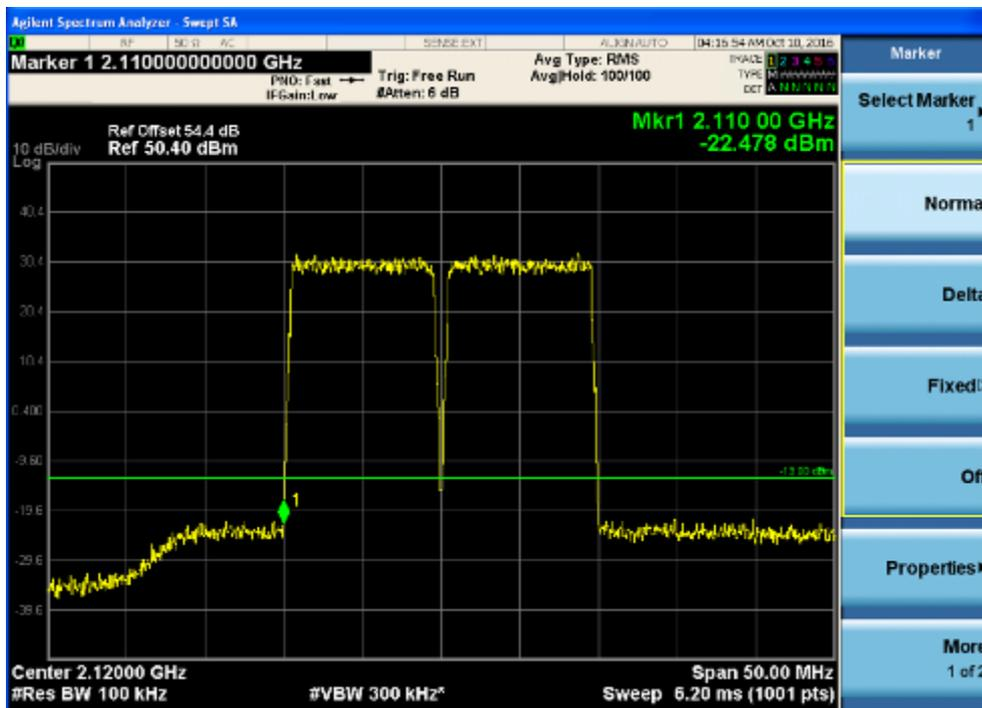

4.3.4 two signal input —Upper Edge

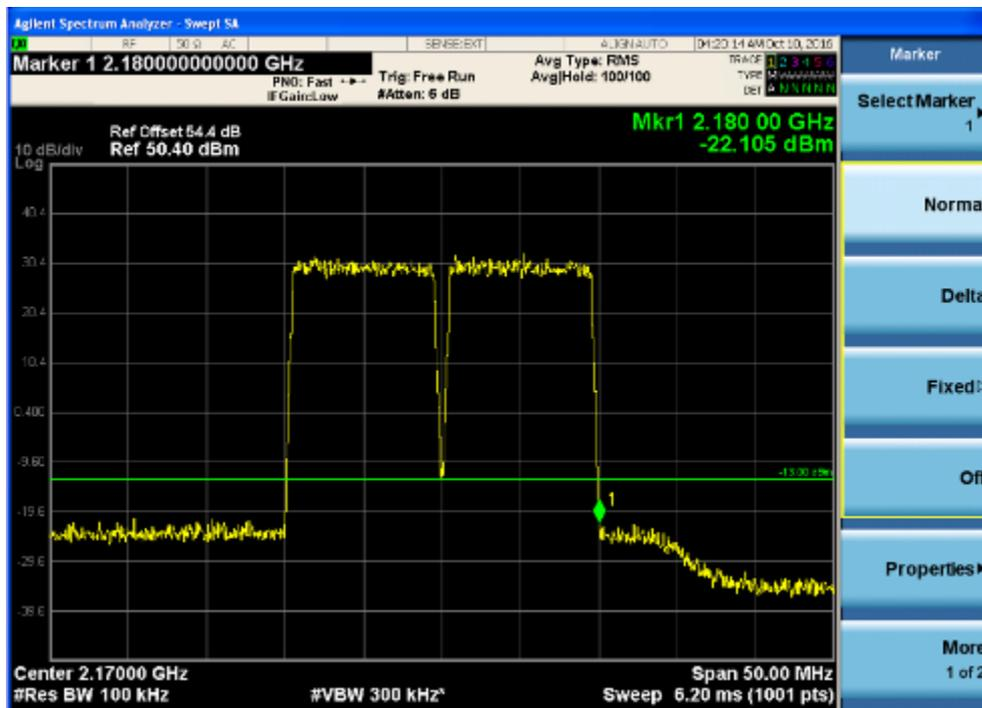



4.4 intermodulation spurious emissions

For CDMA mode:

4.5.1 Input frequency:

1) in lower edge test: f1 is the lower edge frequency +1 channel frequency, and f2 is +2 channel frequency

$$f1=2112\text{MHz}, f2=2114\text{MHz}$$

2) in higher edge test: f1 is the higher edge frequency -2 channel frequency, and f2 is -1 channel frequency

$$f1=2151\text{MHz}, f2=2153\text{MHz}$$

base the 3rd product frequency $F1=2f1-f2$ and $F2=2f2-f1$, when the f1 and f2 frequency select above,

u) in lower edge test, $F1=2f1-(f1+\Delta f)=f1-\Delta f$ =lower edge frequency;

v) in higher edge test, $F2=2f2-(f2-\Delta f)=f2+\Delta f$ =higher edge frequency.

$$F1=2110\text{MHz}, F2=2155\text{MHz}$$

base the 5rd product frequency $F1=3f1-2f2$ and $F2=3f2-2f1$, when the f1 and f2 frequency select above,

u) in lower edge test, $F1=3f1-2(f1+\Delta f)=f1-2\Delta f$ =lower edge frequency;

v) in higher edge test, $F2=3f2-2(f2-\Delta f)=f2+2\Delta f$ =higher edge frequency.

$$F1=2108\text{MHz}, F2=2157\text{MHz}$$

base the 7rd product frequency $F1=4f1-3f2$ and $F2=4f2-3f1$, when the f1 and f2 frequency select above,

u) in lower edge test, $F1=4f1-3(f1+\Delta f)=f1-3\Delta f$ =lower edge frequency;

v) in higher edge test, $F2=4f2-3(f2-\Delta f)=f2+3\Delta f$ =higher edge frequency.

$$F1=2106\text{MHz}, F2=2159\text{MHz}$$

4.5.2 Input power:-20dBm

measure frequency		product Value (dBm)	Limit (dBm)	Margin (dB)
3 rd	Lower:2110MHz	-26.88	-13dBm	-13.88
	Higher:2155MHz	-26.74		-13.74
5 rd	Lower:2108MHz	-28.95	-13dBm	-15.95
	Higher:2157MHz	-28.87		-15.87
7 rd	Lower:2106MHz	-29.43	-13dBm	-16.43
	Higher:2159MHz	-29.92		-16.92



For WCDMA mode:

4.5.3 Input frequency:

1) in lower edge test: f1 is the lower edge frequency +1 channel frequency, and f2 is +2 channel frequency

$f1=2113\text{MHz}, f2=2116\text{MHz}$

2) in higher edge test: f1 is the higher edge frequency -2 channel frequency, and f2 is -1 channel frequency

$f1=2149\text{MHz}, f2=2152\text{MHz}$

base the 3rd product frequency $F1=2f1-f2$ and $F2=2f2-f1$, when the f1 and f2 frequency select above,

w) in lower edge test, $F1=2f1-(f1+\Delta f)=f1-\Delta f$ =lower edge frequency;

x) in higher edge test, $F2=2f2-(f2-\Delta f)=f2+\Delta f$ =higher edge frequency.

$F1=2110\text{MHz}, F2=2155\text{MHz}$

base the 5th product frequency $F1=3f1-2f2$ and $F2=3f2-2f1$, when the f1 and f2 frequency select above,

w) in lower edge test, $F1=3f1-2(f1+\Delta f)=f1-2\Delta f$ =lower edge frequency;

x) in higher edge test, $F2=3f2-2(f2-\Delta f)=f2+2\Delta f$ =higher edge frequency.

$F1=2107\text{MHz}, F2=2158\text{MHz}$

base the 7th product frequency $F1=4f1-3f2$ and $F2=4f2-3f1$, when the f1 and f2 frequency select above,

w) in lower edge test, $F1=4f1-3(f1+\Delta f)=f1-3\Delta f$ =lower edge frequency;

x) in higher edge test, $F2=4f2-3(f2-\Delta f)=f2+3\Delta f$ =higher edge frequency.

$F1=2104\text{MHz}, F2=2161\text{MHz}$

4.5.4 Input power:-20dBm

measure frequency		product Value (dBm)	Limit (dBm)	Magin (dB)
3 rd	Lower:2110MHz	-22.37	-13dBm	-9.37
	Higher:2155MHz	-23.45		-10.45
5 th	Lower:2107MHz	-24.72	-13dBm	-11.72
	Higher:2158MHz	-25.61		-12.61
7 th	Lower:2104MHz	-26.98	-13dBm	-13.98
	Higher:2161MHz	-27.23		-14.23



For LTE mode:

4.5.5 Input frequency:

1) in lower edge test: f1 is the lower edge frequency +1 channel frequency, and f2 is +2 channel frequency

$$f1=2115\text{MHz}, f2=2125\text{MHz}$$

2) in higher edge test: f1 is the higher edge frequency -2 channel frequency, and f2 is -1 channel frequency

$$f1=2140\text{MHz}, f2=2150\text{MHz}$$

base the 3rd product frequency $F1=2f1-f2$ and $F2=2f2-f1$, when the f1 and f2 frequency select above,

y) in lower edge test, $F1=2f1-(f1+\Delta f)=f1-\Delta f$ =lower edge frequency;

z) in higher edge test, $F2=2f2-(f2-\Delta f)=f2+\Delta f$ =higher edge frequency.

$$F1=2110\text{MHz}, F2=2155\text{MHz}$$

base the 5th product frequency $F1=3f1-2f2$ and $F2=3f2-2f1$, when the f1 and f2 frequency select above,

y) in lower edge test, $F1=3f1-2(f1+\Delta f)=f1-2\Delta f$ =lower edge frequency;

z) in higher edge test, $F2=3f2-2(f2-\Delta f)=f2+2\Delta f$ =higher edge frequency.

$$F1=2100\text{MHz}, F2=2165\text{MHz}$$

base the 7th product frequency $F1=4f1-3f2$ and $F2=4f2-3f1$, when the f1 and f2 frequency select above,

y) in lower edge test, $F1=4f1-3(f1+\Delta f)=f1-3\Delta f$ =lower edge frequency;

z) in higher edge test, $F2=4f2-3(f2-\Delta f)=f2+3\Delta f$ =higher edge frequency.

$$F1=2090\text{MHz}, F2=2175\text{MHz}$$

4.5.6 Input power:-20dBm

measure frequency		product Value (dBm)	Limit (dBm)	Margin (dB)
3 rd	Lower:2110MHz	-22.48	-13dBm	-9.48
	Higher:2155MHz z	-22.11		-9.11
5 th	Lower:2100MHz	-25.99	-13dBm	-12.99
	Higher:2165MHz z	-26.21		-13.21
7 th	Lower:2090MHz	-27.32	-13dBm	-14.32
	Higher:2175MHz z	-27.63		-14.63

Remark:



SGS-CSTC Standards Technical Services Co., Ltd.

Report No.: GZEM160900667101

Page: 98 of 163

FCC ID: OJFGXCPLA3

No other intermodulation spurious emissions of above 7rd have been found,so only record the test data about the 3rd, 5rdand 7rd



Remark:

For the test in two signal input or intermodulation, test input signal f1 and f2 will consider as follows conditions:

- 2) EUT frequency band span and the amount of channels;
- 3) f1 is the frequency lower, f2 is the frequency higher, Δf is the channel spacing;
- 4) in lower edge test, f1 is the lower edge frequency +1 channel frequency, and f2 is +2 channel frequency;
- 5) in higher edge test, f1 is the higher edge frequency -2 channel frequency, and f2 is -1 channel frequency;
- 6) according to the amplifier characteristic, the 3rd product will appear when two signals input;
- 7) base the 3rd product frequency $F1=2f1-f2$ and $F2=2f2-f1$, when the f1 and f2 frequency select above,
 - a) in lower edge test, $F1=2f1-(f1+\Delta f)=f1-\Delta f$ =lower edge frequency;
 - b) in higher edge test, $F2=2f2-(f2-\Delta f)=f2+\Delta f$ =higher edge frequency.
- 8) base the 5rd product frequency $F1=3f1-2f2$ and $F2=3f2-2f1$, when the f1 and f2 frequency select above,
 - a) in lower edge test, $F1=3f1-2(f1+\Delta f)=f1-2\Delta f$ =lower edge frequency;
 - b) in higher edge test, $F2=3f2-2(f2-\Delta f)=f2+2\Delta f$ =higher edge frequency.
- 9) base the 7rd product frequency $F1=4f1-3f2$ and $F2=4f2-3f1$, when the f1 and f2 frequency select above,
 - a) in lower edge test, $F1=4f1-3(f1+\Delta f)=f1-3\Delta f$ =lower edge frequency;
 - b) in higher edge test, $F2=4f2-3(f2-\Delta f)=f2+3\Delta f$ =higher edge frequency.



7.2.4 Radiated Spurious Emissions

Test Date: 2016-10-13

Test Requirement: FCC part 90.210 & FCC part 22.917(a) & FCC part 24.238(a) & FCC part 27.53(h)
90.210, table "Application Emission Mask"

Frequency Band(MHz)	Mask for equipment with Audio Low pass filter	Mask for equipment without Audio Low pass filter
806-809/851-854	B	H
809-824/854-869 ³	B	G

(g)Emission Mask G. For transmitters that are not equipped with an audio low-pass filter, the power of an emission must be attenuated below the unmodulated carrier power(P) as follows:

(2) On any frequency removed from the center of the authorized bandwidth by more than 250 percent of the authorized bandwidth: At least 43 + 10 log (P) dB.

22.917(a) Out of band emissions. The power of any emission outside of the authorized operating frequency ranges must be attenuated below the transmitting power (P) by a factor of at least 43 + 10 log(P) dB.

24.238(a) Out of band emissions. The power of any emission outside of the authorized operating frequency ranges must be attenuated below the transmitting power (P) by a factor of at least 43 + 10 log(P) dB.

27.53(h) For operations in the 1710–1755 MHz and 2110–2155 MHz bands, the power of any emission outside a licensee's frequency block shall be attenuated below the transmitter power (P) by at least 43 + 10 log₁₀(P) dB.

Test Method: FCC part 2.1053
ANSI/TIA-603-C-2004

EUT Operation:
Status: Drive the EUT to maximum output power.
Conditions: Normal conditions
Application: Enclosure

Test Configuration:

9 kHz to 30 MHz emissions:

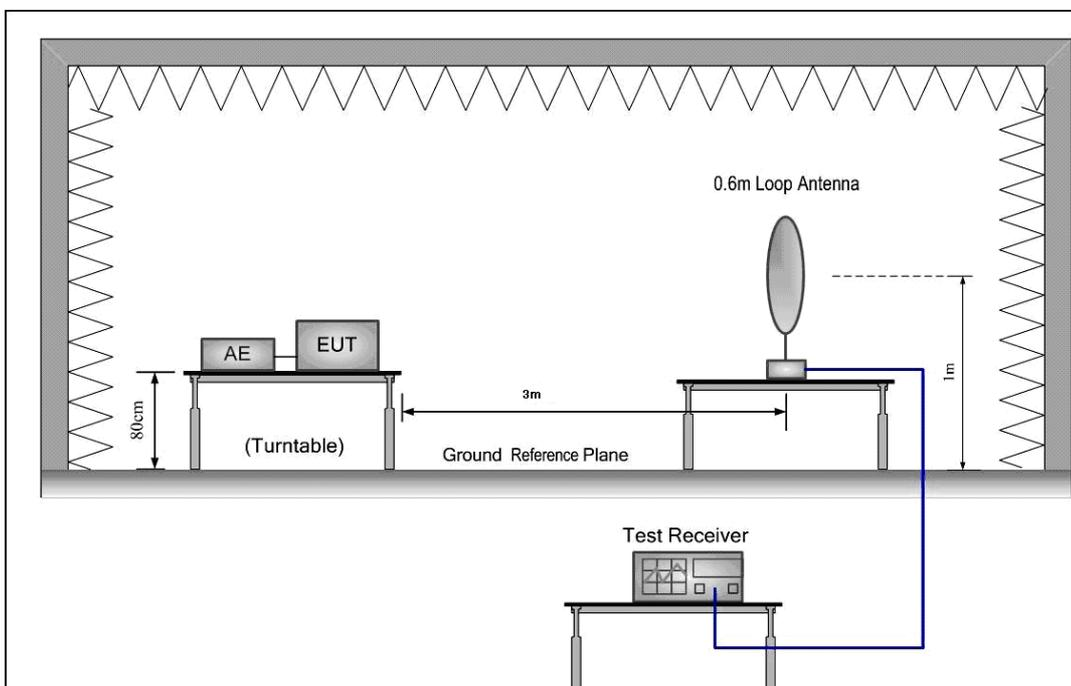

30MHz to 1GHz emissions:

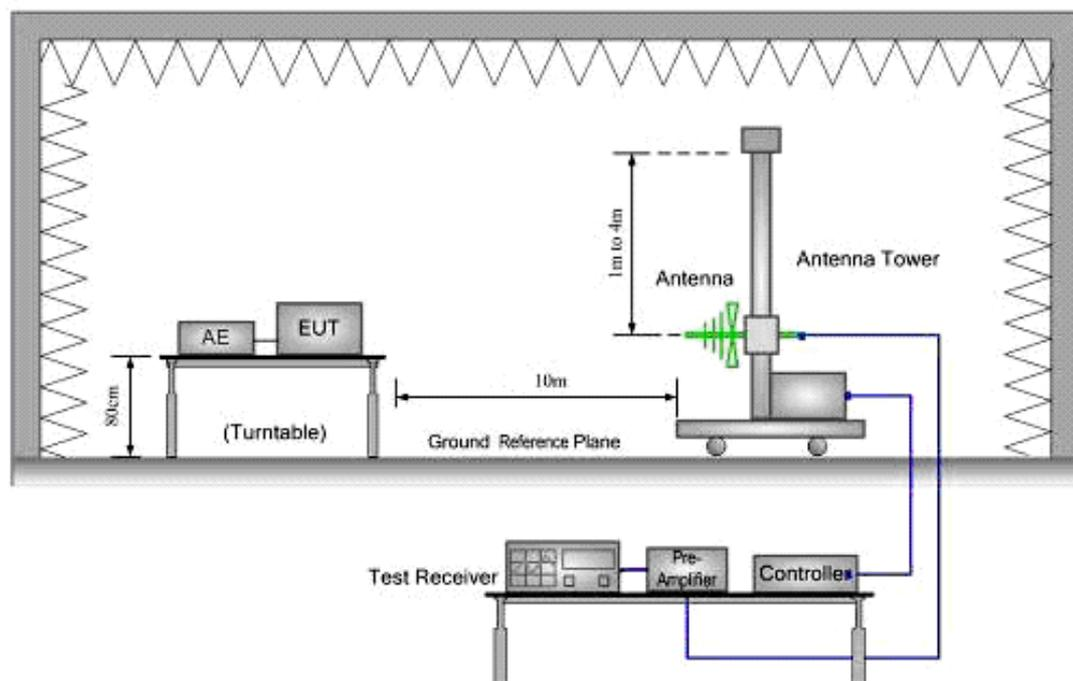

1GHz to 40GHz emissions:

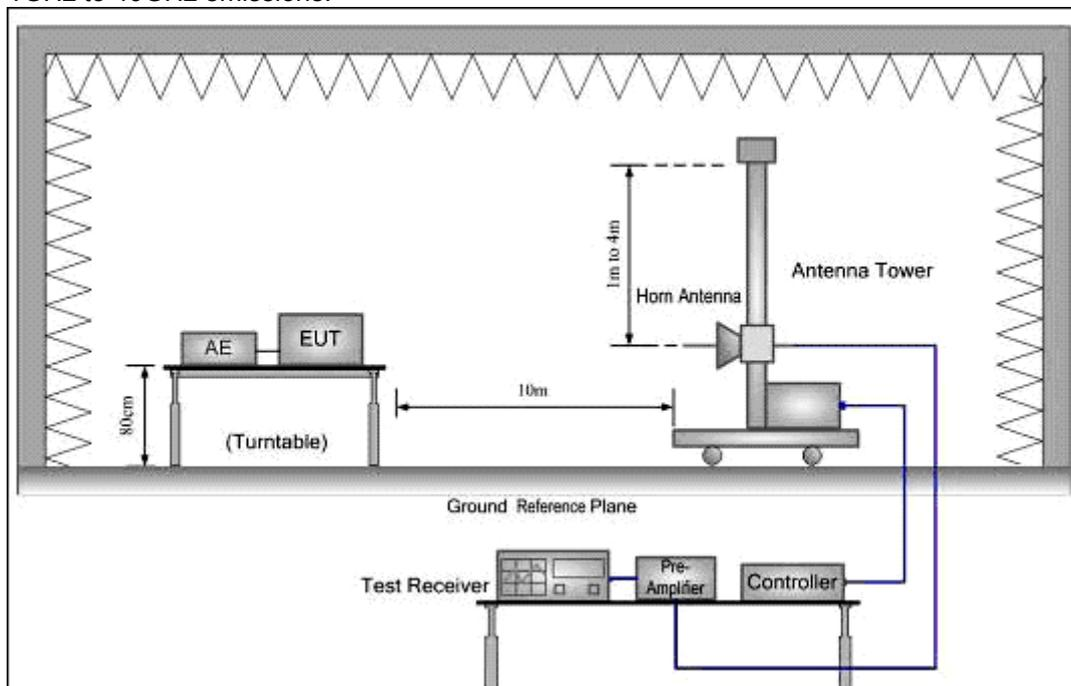

Test Procedure:

1. Test the background noise level with all the test facilities;
2. Keep one transmitting path, all other connectors shall be connected by normal power or RF leads;
3. Select the suitable RF notch filter to avoid the test receiver or spectrum analyzer produce unwanted spurious emissions;
4. Keep the EUT continuously transmitting in max power;
5. Read the radiated emissions of the EUT enclosure.

Radiated Emissions Test Procedure:

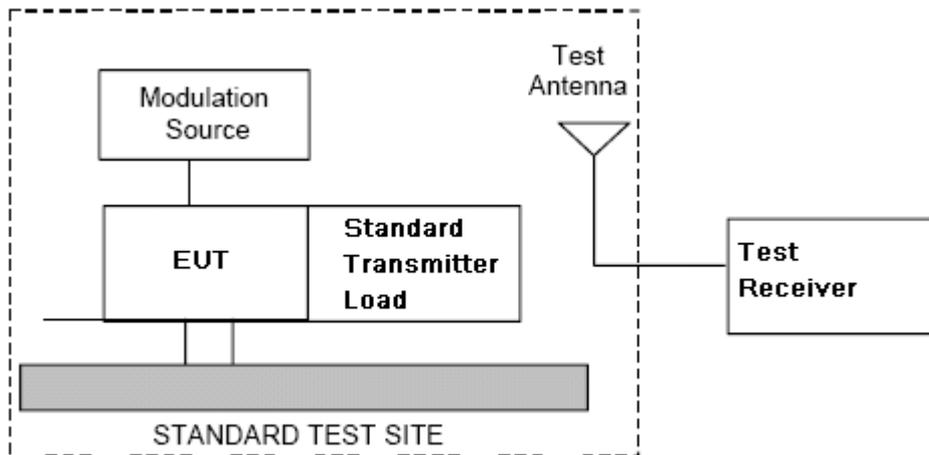

- a) Connect the equipment as illustrated.
- b) Adjust the spectrum analyzer for the following settings:
 - 1) Resolution Bandwidth = 100 kHz for spurious emissions below 1 GHz, and 1 MHz for spurious emissions above 1GHz.
 - 2) Video Bandwidth = 300 kHz for spurious emissions below 1 GHz, and 3 MHz for spurious emissions above 1 GHz.
 - 3) Sweep Speed slow enough to maintain measurement calibration.
 - 4) Detector Mode = Positive Peak.
- c) Place the transmitter to be tested on the turntable in the standard test site, The transmitter is transmitting into a nonradiating load that is placed on the turntable. The RF cable to this load should be of minimum length.
- d) Measurements shall be made from 30MHz to 10 times of fundamental carrier, except for the region close to the carrier equal to \pm the carrier bandwidth.
- e) Key the transmitter without modulation or normal modulation base the standard.
- f) For each spurious frequency, raise and lower the test antenna from 1 m to 4 m to obtain a maximum reading on the spectrum analyzer with the test antenna at horizontal polarity. Then the turntable should be rotated 360° to determine the maximum reading. Repeat this procedure to obtain the highest possible reading. Record this maximum reading.
- g) Repeat step f) for each spurious frequency with the test antenna polarized vertically.

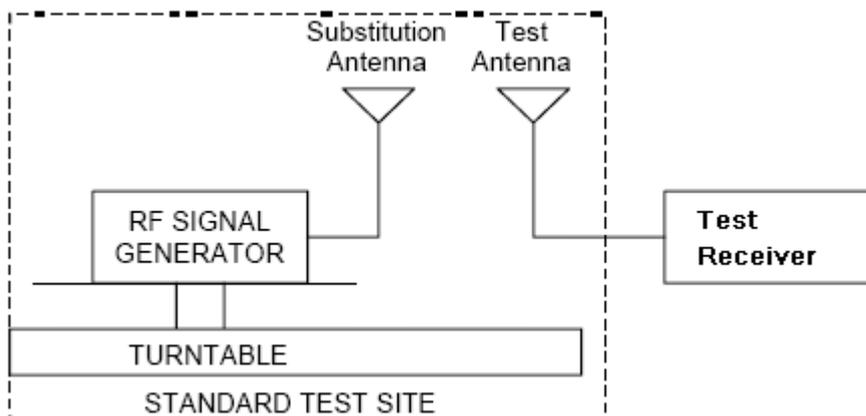

- h) Reconnect the equipment as illustrated.
- i) Keep the spectrum analyzer adjusted as in step b).
- j) Remove the transmitter and replace it with a substitution antenna (the antenna should be half-wavelength for each frequency involved). The center of the substitution antenna should be approximately at the same location as the center of the transmitter. At the lower frequencies, where the substitution antenna is very long, this will be impossible to achieve when the antenna is polarized vertically. In such case the lower end of the antenna should be 0.3 m above the ground.
- k) Feed the substitution antenna at the transmitter end with a signal generator connected to the antenna by means of a nonradiating cable. With the antennas at both ends horizontally polarized, and with the signal generator tuned to a particular spurious frequency, raise and lower the test antenna to obtain a maximum reading at the spectrum analyzer. Adjust the level of the signal generator output until the previously recorded maximum reading for this set of conditions is obtained. This should be done carefully repeating the adjustment of the test antenna and generator output.
- l) Repeat step k) with both antennas vertically polarized for each spurious frequency.

m) Calculate power in dBm into a reference ideal half-wave dipole antenna by reducing the readings obtained in steps k) and l) by the power loss in the cable between the generator and the antenna, and further corrected for the gain of the substitution antenna used relative to an ideal half-wave dipole

antenna by the following formula:

$$Pd(\text{dBm}) = Pg(\text{dBm}) - \text{cable loss (dB)} + \text{antenna gain (dB)}$$

where:

Pd is the dipole equivalent power and

Pg is the generator output power into the substitution antenna.

NOTE: It is permissible to use other antennas provided they can be referenced to a dipole.

NOTE: Effective radiated power (e.r.p) refers to the radiation of a half wave tuned dipole instead of an isotropic antenna. There is a constant difference of 2.15 dB between e.i.r.p. and e.r.p.

$$\text{e.r.p (dBm)} = \text{e.i.r.p. (dBm)} - 2.15$$



7.2.4.1 Measurement Record:

No emissions were detected within 20dB below the limit for the Downlink direction.

Test Result:

9KHz~1000 MHz Field Strength of Unwanted Emissions. Quasi-Peak Measurement

9KHz~1000 MHz Field Strength of Unwanted Emissions. Quasi-Peak Measurement

The measurements with Loop and Log antennas were greater than 20dB below the limit, so the test data were only recorded one worst mode test graph in the test report.

Test at Frequency (742MHz) in transmitting status

30 MHz~1 GHz Spurious Emissions .Quasi-Peak Measurement

Vertical:

Peak scan

Level (dB μ V/m)

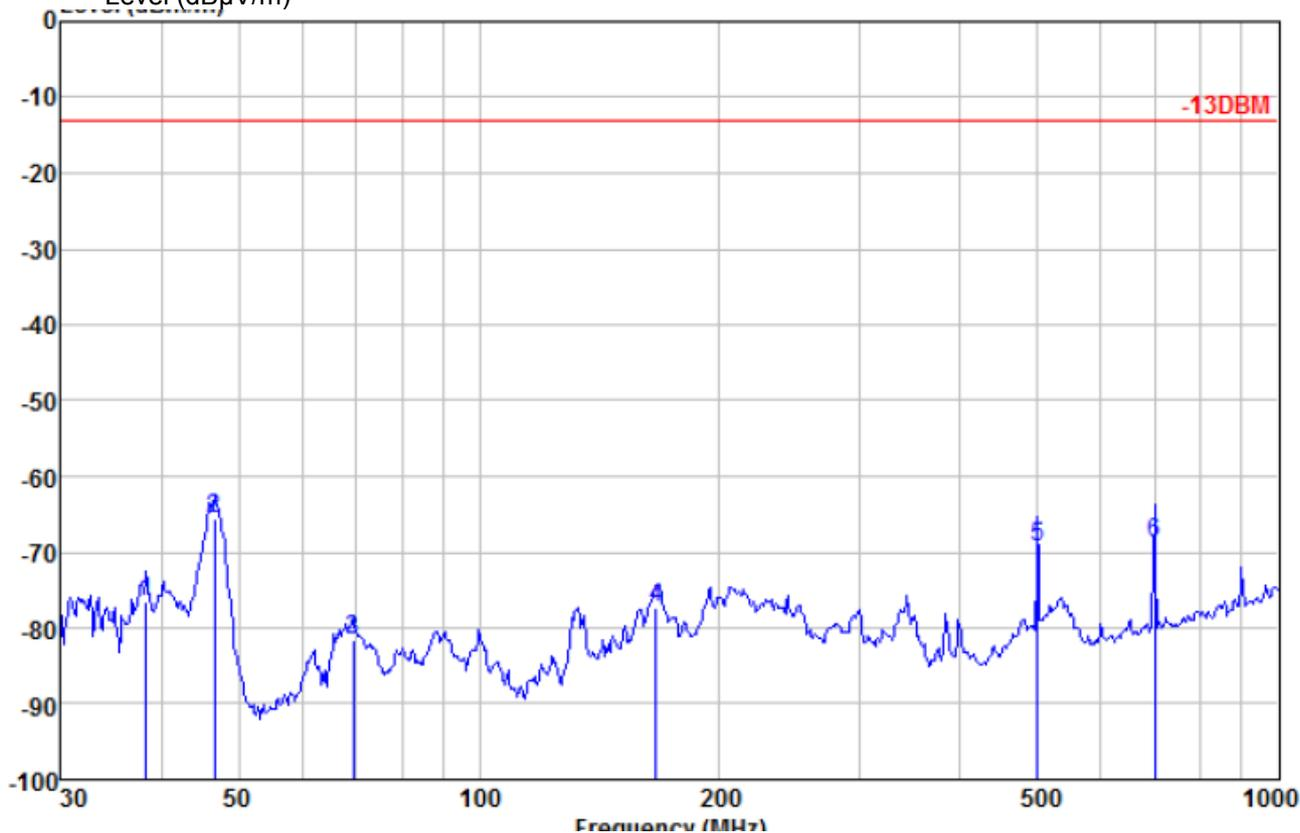

Quasi-peak measurement



SGS-CSTC Standards Technical Services Co., Ltd.

Report No.: GZEM160900667101

Page: 106 of 163

FCC ID: OJFGXCPLA3

	Freq	ReadAntenna Level	Antenna Factor	Cable Loss	Preamplifier Factor	Level	Limit Line	Over Limit	Remark
	MHz	dBm	dB/m	dB	dB	dBm/m	dBm/m	dB	
1	38.346	-64.40	13.73	1.10	27.00	-76.57	-12.99	-63.58	QP
2	46.666	-54.26	14.32	1.23	27.00	-65.71	-12.99	-52.72	QP
3	69.600	-68.97	12.74	1.50	27.00	-81.73	-12.99	-68.74	QP
4	166.651	-66.38	13.40	2.43	26.75	-77.30	-12.99	-64.31	QP
5	499.425	-64.07	18.10	4.40	27.80	-69.37	-12.99	-56.38	QP
6	699.305	-67.23	21.30	5.20	28.00	-68.73	-12.99	-55.74	QP



Horizontal:

Peak scan

Level (dBμV/m)

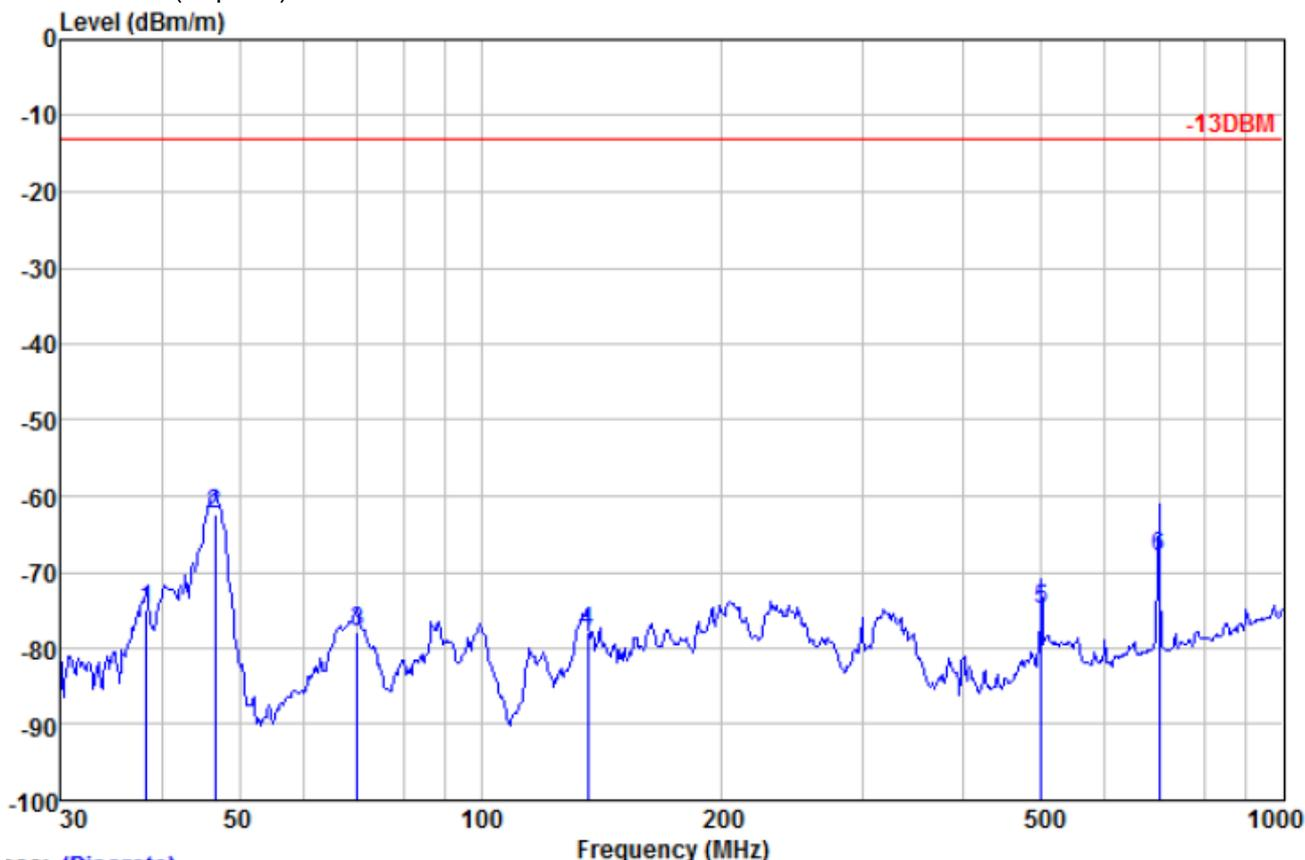

Quasi-peak

measurement

	Read	Antenna	Cable	Preamp	Limit	Over		
	Freq	Level	Factor	Loss	Factor	Level	Line	Limit
	MHz	dBm	dB/m	dB	dB	dBm/m	dBm/m	dB
1	38.346	-62.73	13.73	1.10	27.00	-74.90	-12.99	-61.91
2	46.666	-51.00	14.32	1.23	27.00	-62.45	-12.99	-49.46
3	70.090	-65.07	12.70	1.50	27.00	-77.87	-12.99	-64.88
4	135.982	-65.91	12.75	2.20	26.84	-77.80	-12.99	-64.81
5	499.425	-69.53	18.10	4.40	27.80	-74.83	-12.99	-61.84
6	699.305	-66.58	21.30	5.20	28.00	-68.08	-12.99	-55.09



Above 1GHz Field Strength of Unwanted Emissions. Quasi-Peak Measurement

Peak Measurement:

Frequency (MHz)	Antenna factors (dB/m)	Cable loss (dB)	Preamp factor (dB)	Reading Level (dBm)	Emission Level (dBm/m)	Limit (dBm/m)	Over limit (dB)	Antenna polarization
1484	24.99	5.48	38.93	-60.84	-69.3	-13	-56.3	Vertical
2226	25.86	6.65	39.05	-57.2	-63.74	-13	-50.74	V
2980.327	27.88	7.7	39.4	-48.2	-52.02	-13	-39.02	V
4455.89	30.07	9.57	40.16	-63.22	-63.74	-13	-50.74	V
6730.187	34.7	12.1	39.41	-65.9	-58.51	-13	-45.51	Horizontal
10833.22	39.66	14.93	37.93	-73.38	-56.72	-13	-43.72	H

Remark:

The cabinet radiation was measured with the equipment transmitting a CW signal into a non-radiating 50 Ohm load at maximum output power on a signal frequency .

Measured were performed in the lowest, middle and highest frequency for the Downlink of products which included AC and DC Unit.

The spectrum was searched from 9KHz to 26GHz (10th Harmonic) for downlink;

7.2.5 Occupied Bandwidth

Test Date: 2016-10-09
 Test Requirement: KDB935210 D02;2-11-04/EAB/RF
 Test Method: FCC part 2.1049, 2-11-04/EAB/RF

The spectral shape of the output should look similar to input for all modulations.

EUT Operation:
 Status: Drive the EUT to maximum output power. .
 Conditions: Normal conditions
 Application: Cellular Band RF output ports

Test Configuration:

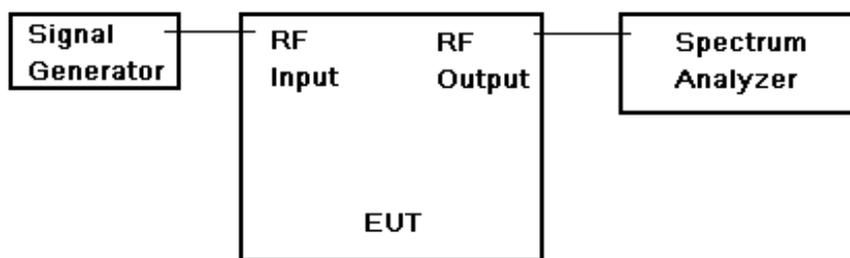

Fig.2. Conducted Spurious Emissions test configuration

- Test Procedure:
- a) Set the spectrum analyzer RBW 300 Hz or >1%&<2% emission bandwidth of carrier.
 - b) Capture the trace of input signal;
 - c) Connect the equipment as illustrated;
 - d) Capture the trace of output signal;



7.2.5.1 Measurement Record:

1. Downlink: 728MHz to 757MHz(LTE mode)

1.1 lowest frequency – Input

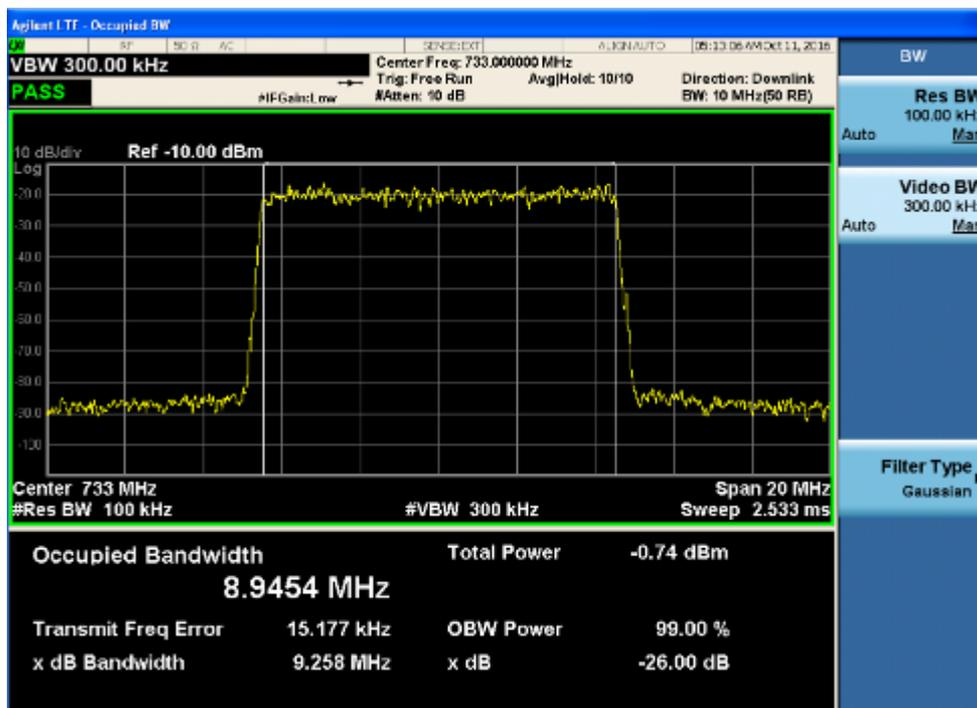

1.2 lowest frequency—Output

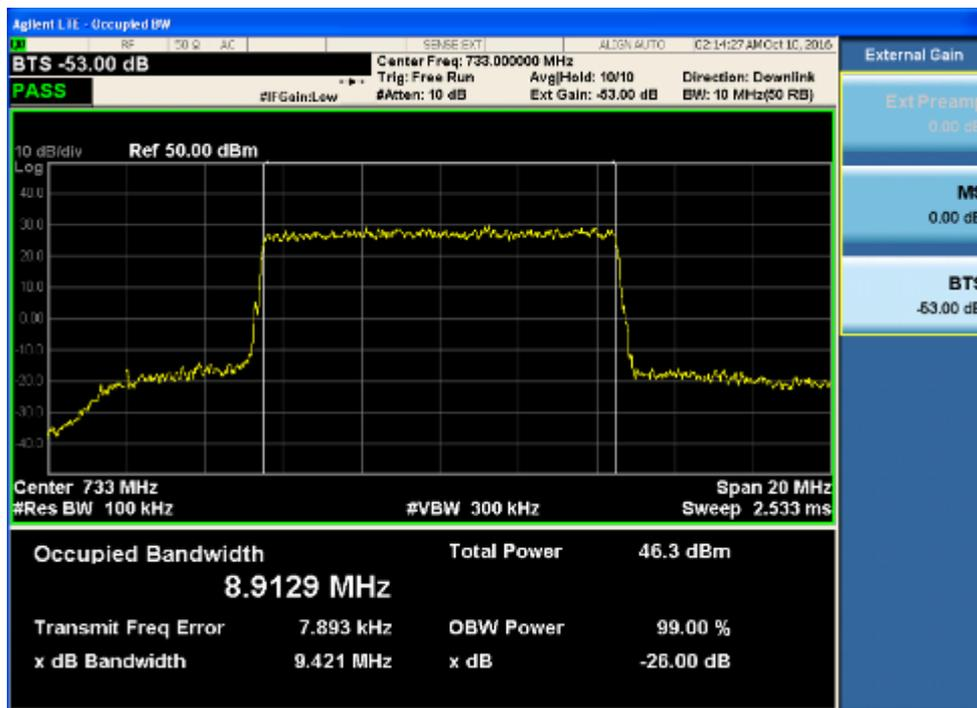



1.3 middle frequency—Input

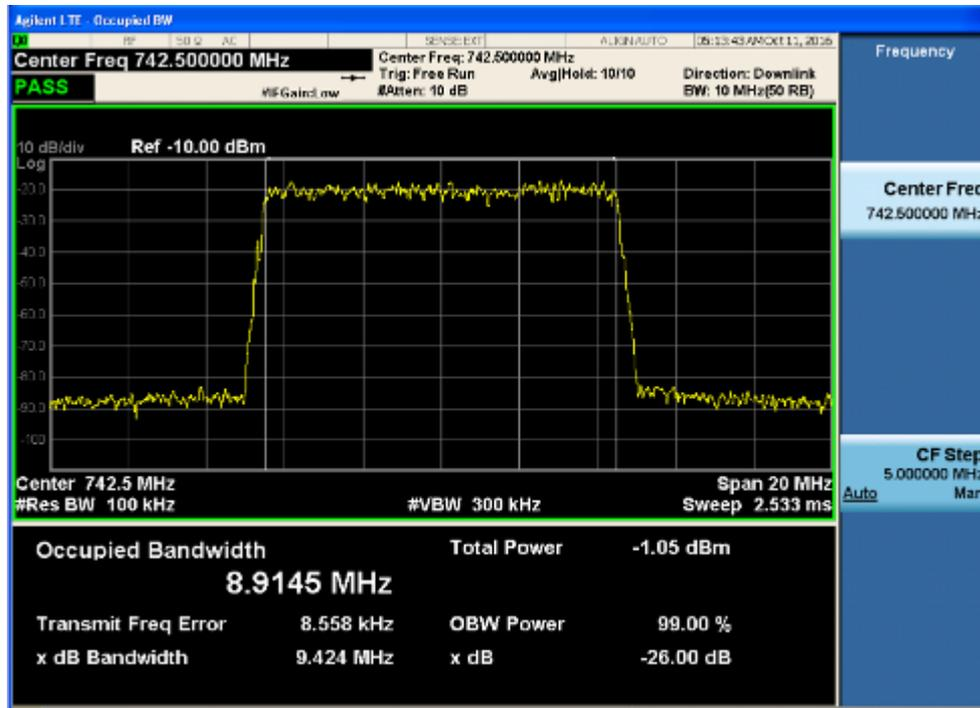

1.4 middle frequency—Output

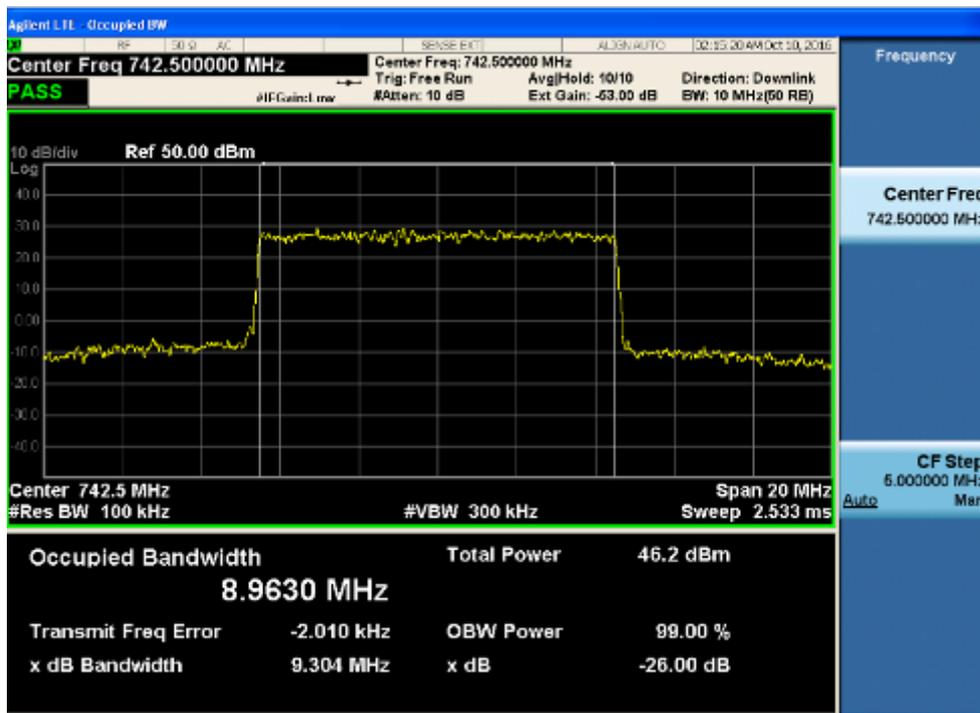



1.5 highest frequency—Input

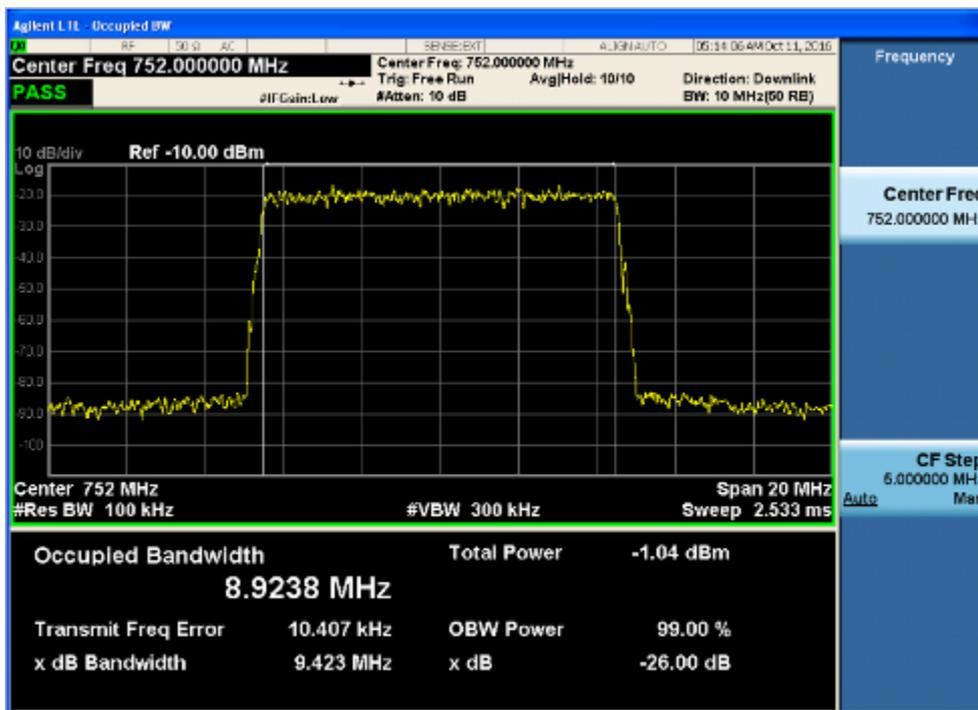

1.6 highest frequency—Output

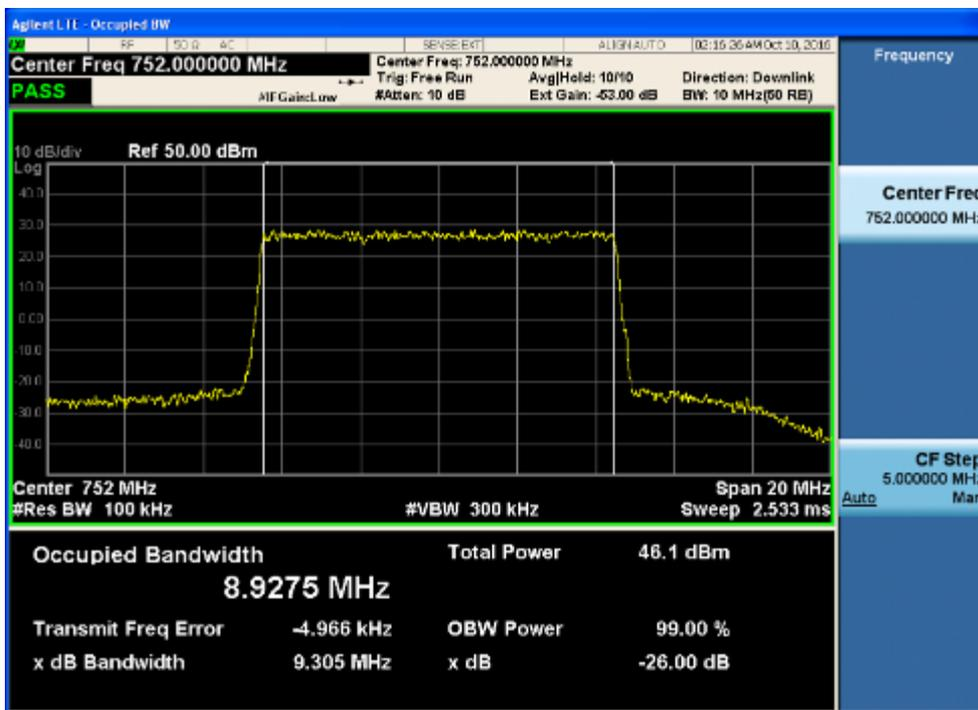

7.2.5.2 Measurement Record:

1.Downlink: 862MHz to 869MHz(CDMA,WCDMA,LTE)

1.1 CDMA Mode:

1.1.1 lowest frequency— Input

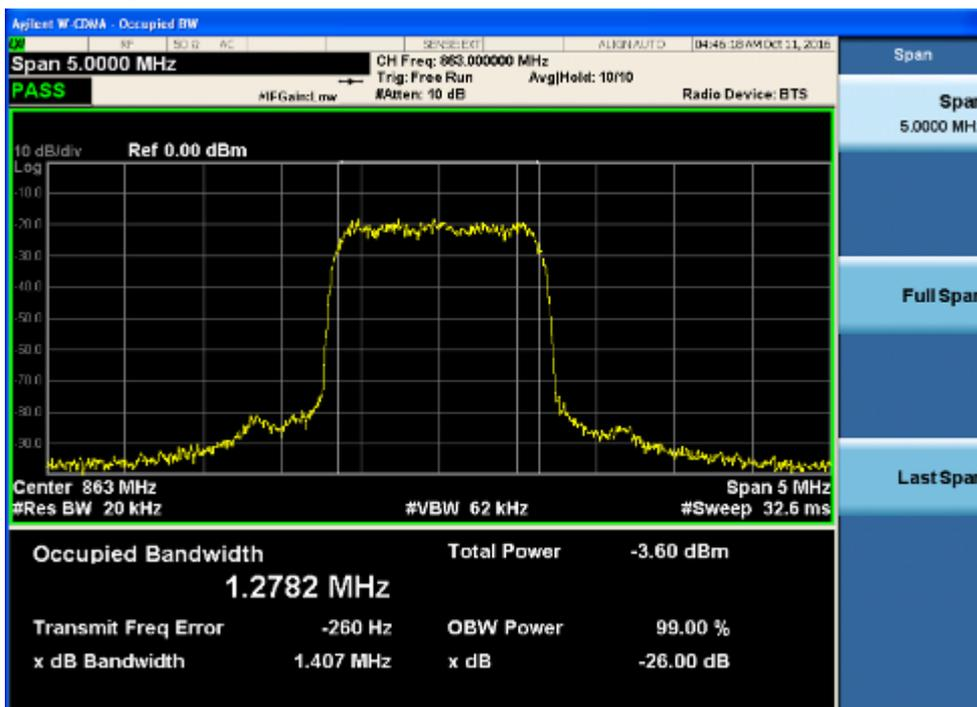

1.1.2 lowest frequency—Output

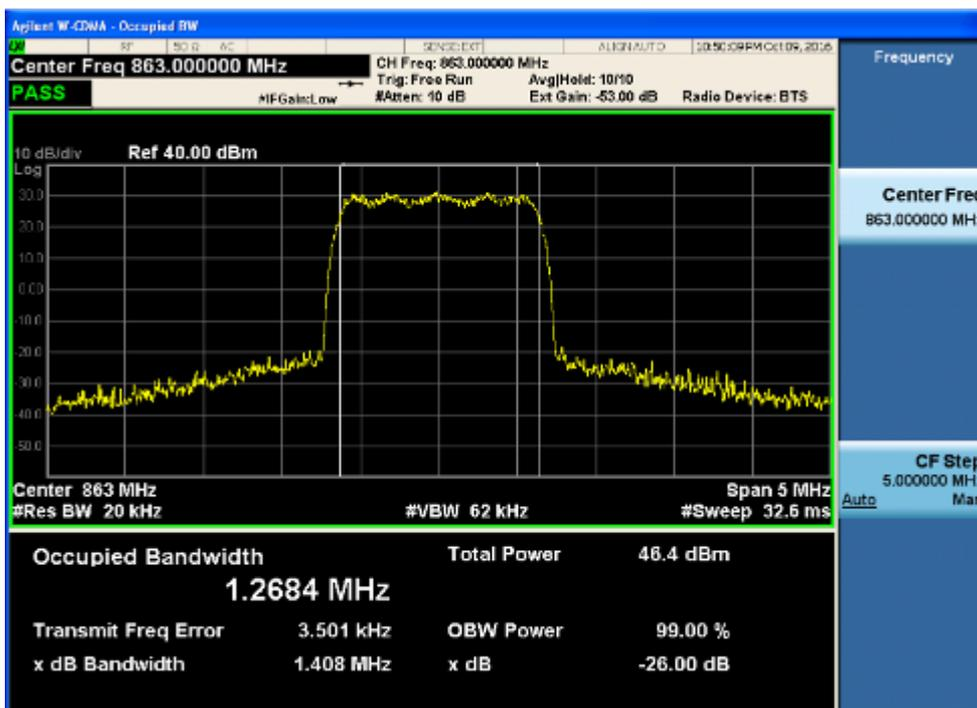

1.1.3 middle frequency—Input

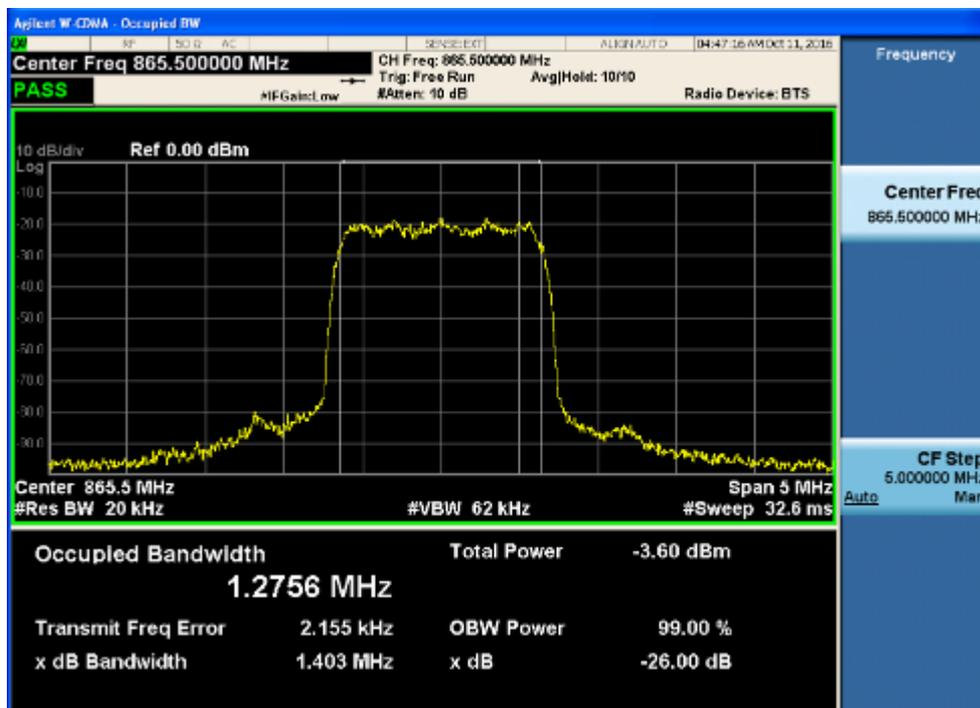

1.1.4 middle frequency—Output

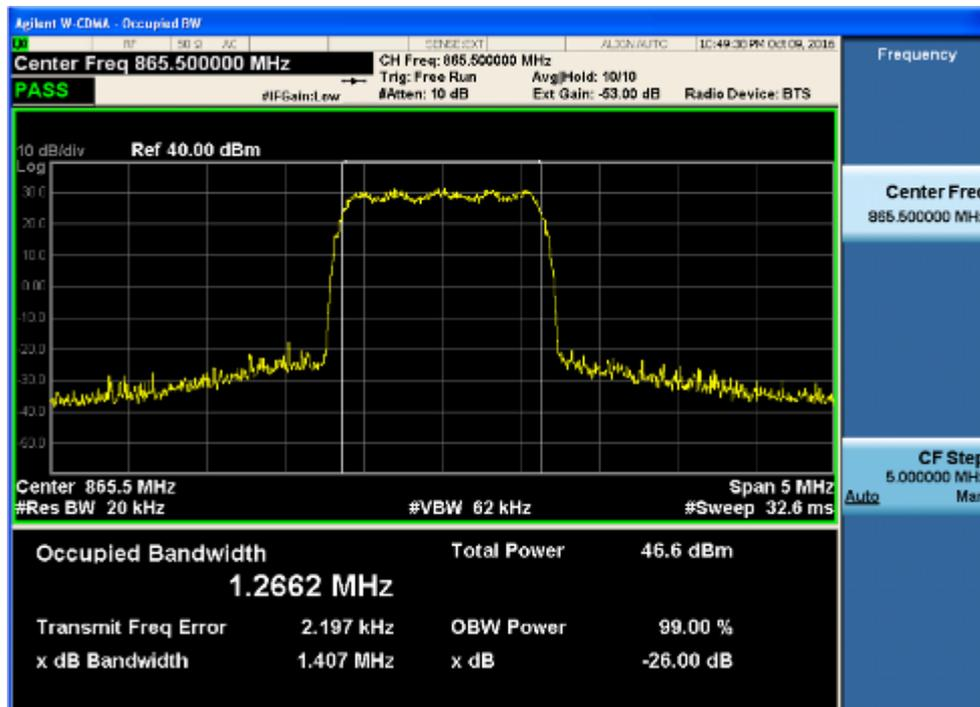

1.1.5 highest frequency—Input

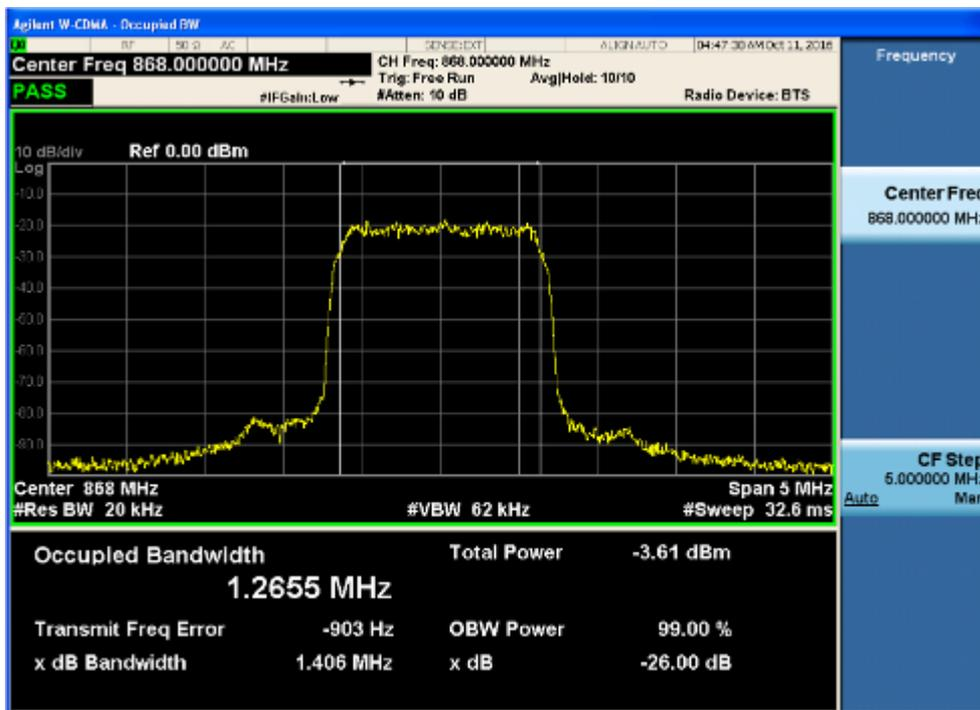

1.1.6 highest frequency—Output

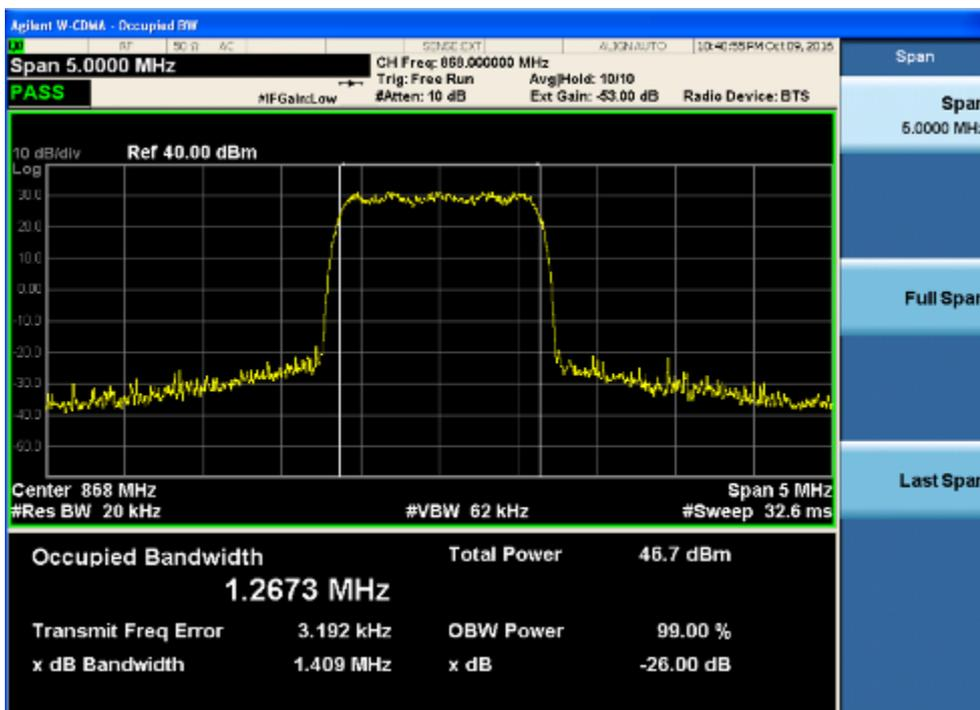

1.2 WCDMA Mode:

1.2.1 Lowest frequency—Input

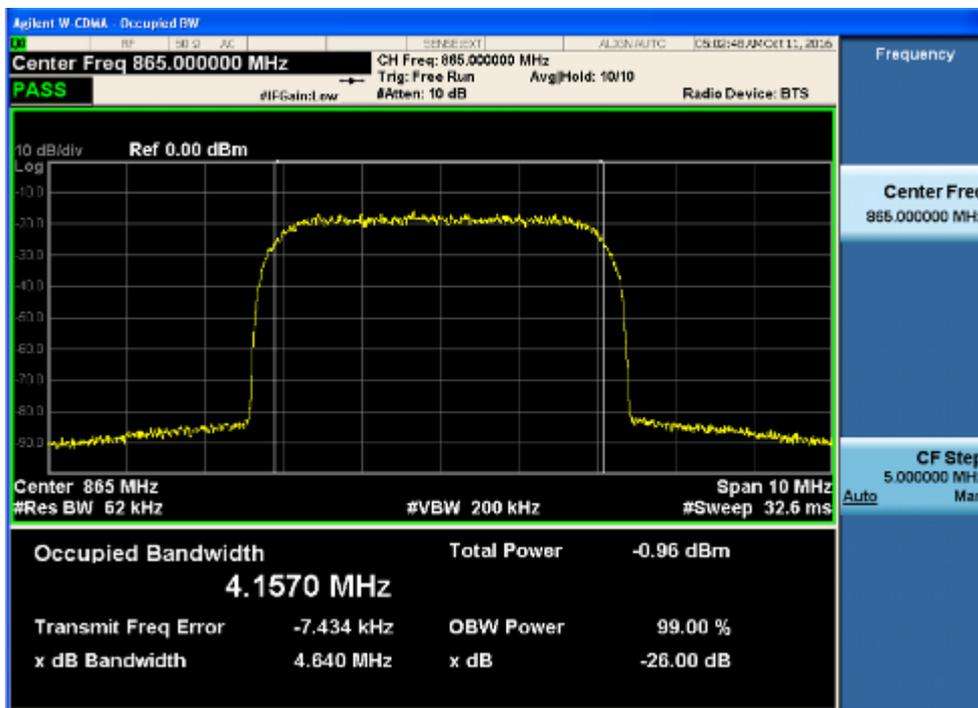

1.2.2 Lowest frequency—Output

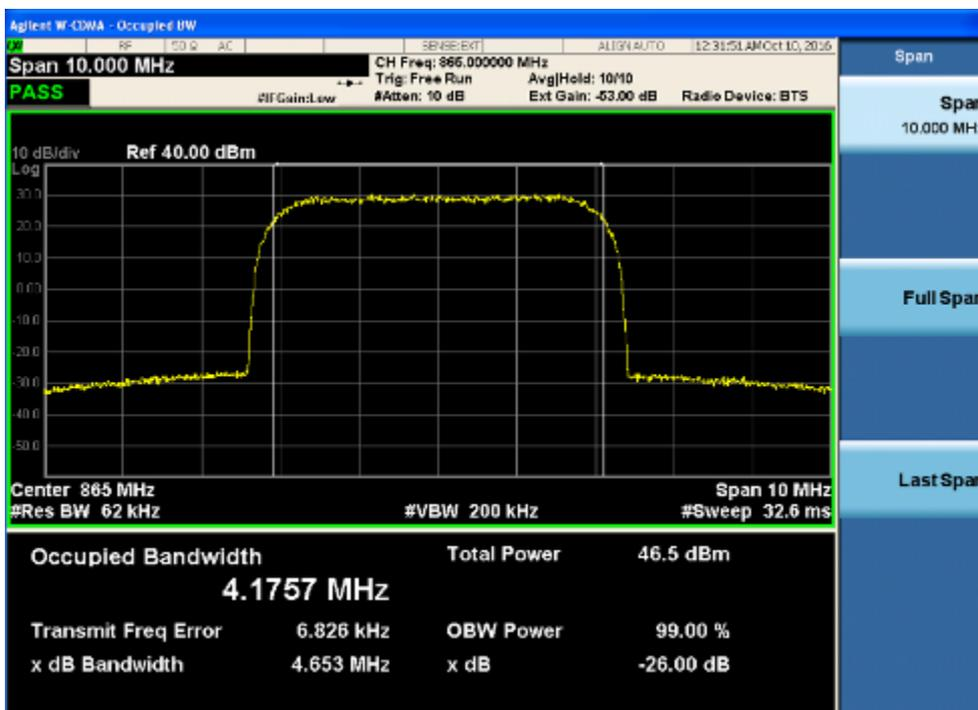

1.2.3 middle frequency—Input

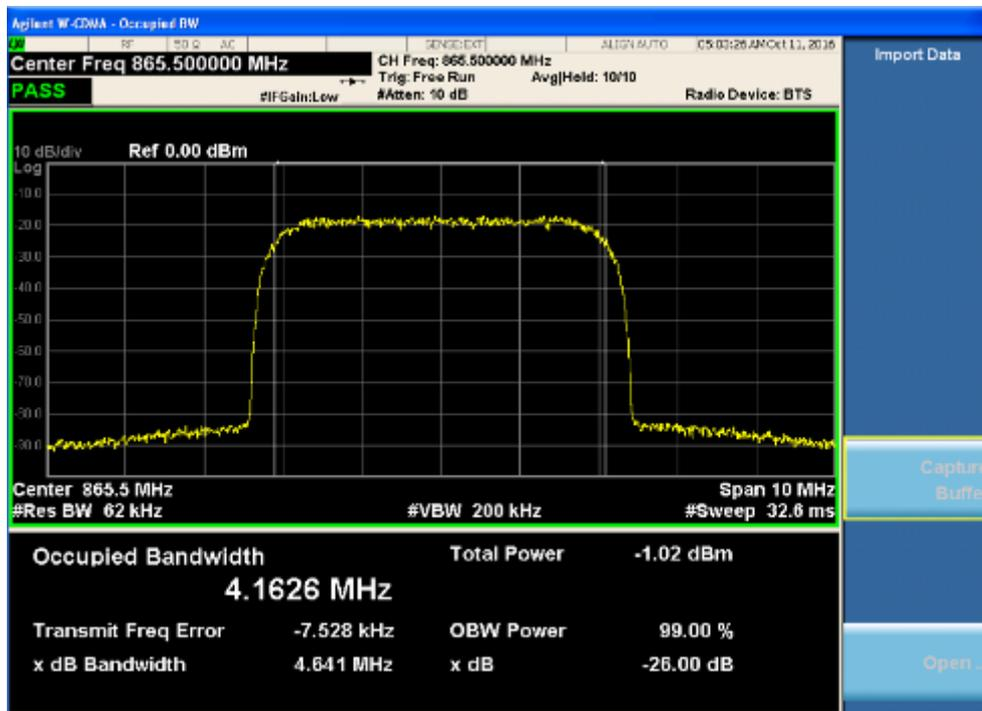

1.2.4 middle frequency—Output

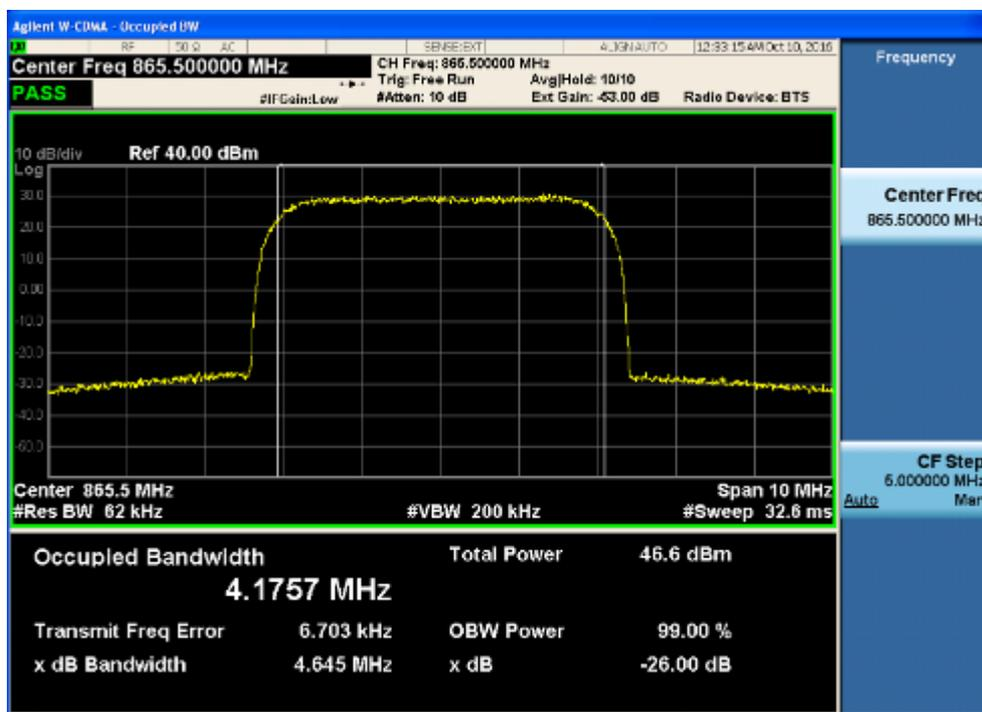



1.2.5 highest frequency—Input

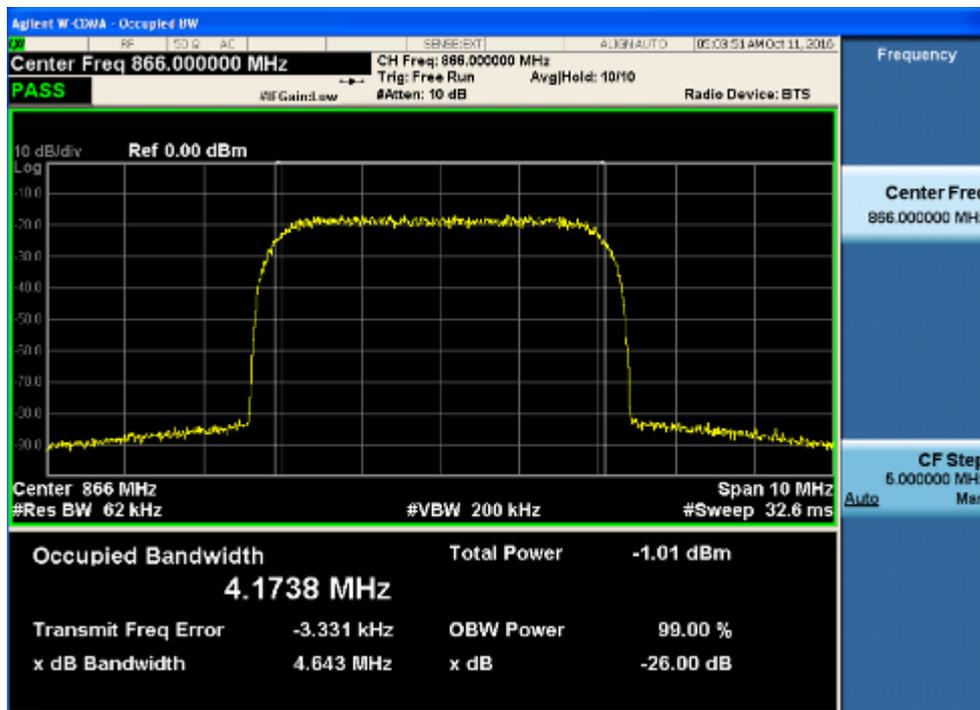

1.2.6 highest frequency—Output

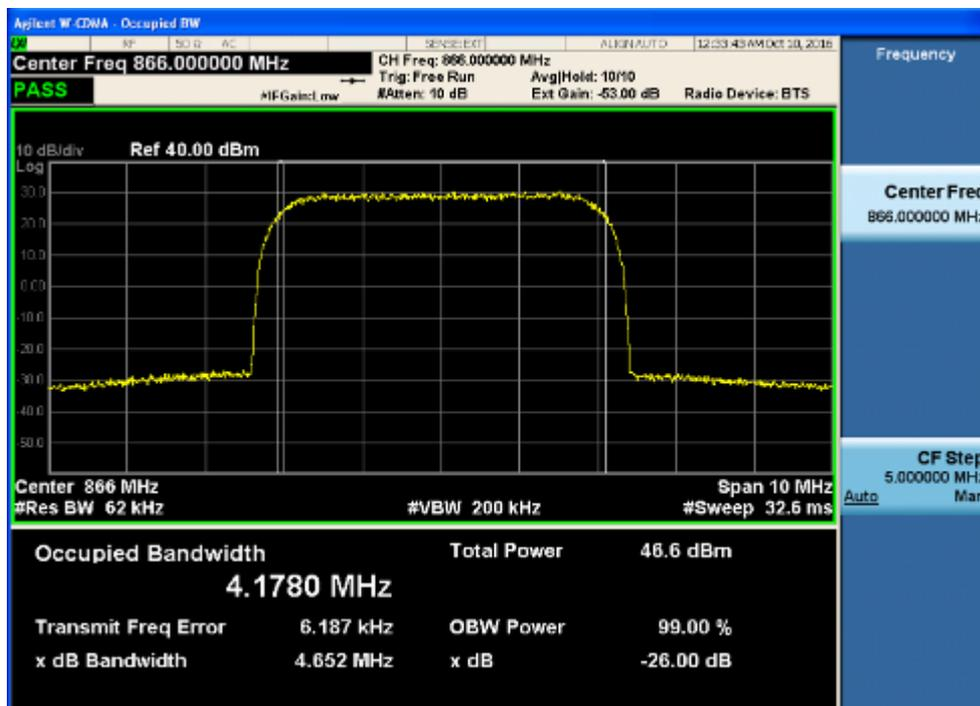



1.3 LTE Mode:

1.3.1 Lowest frequency—Input

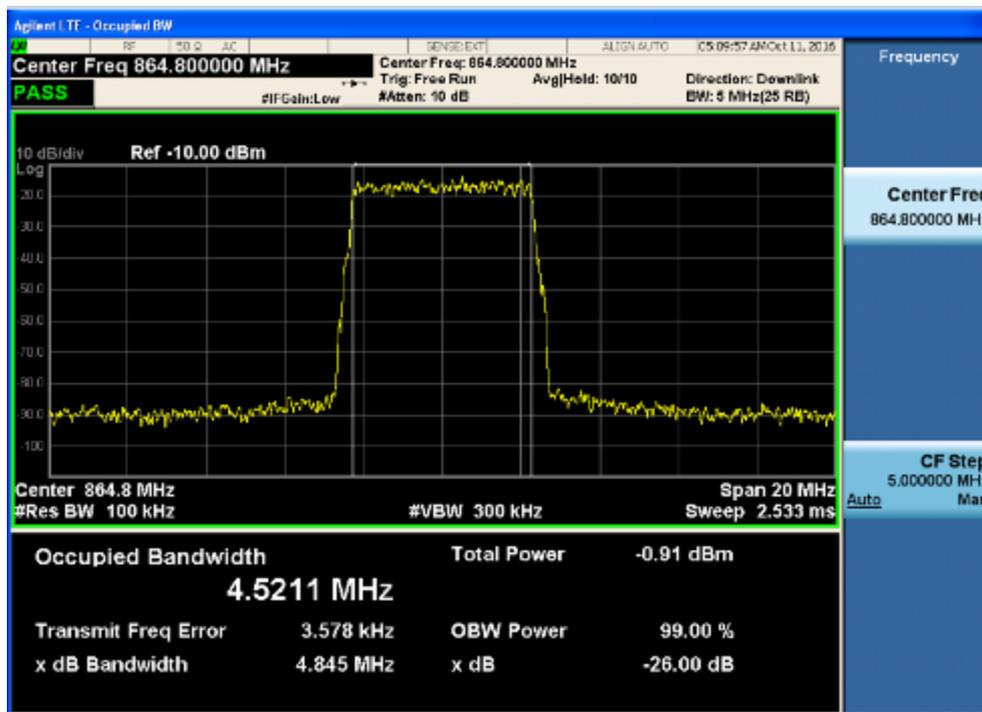

1.3.2 Lowest frequency—Output

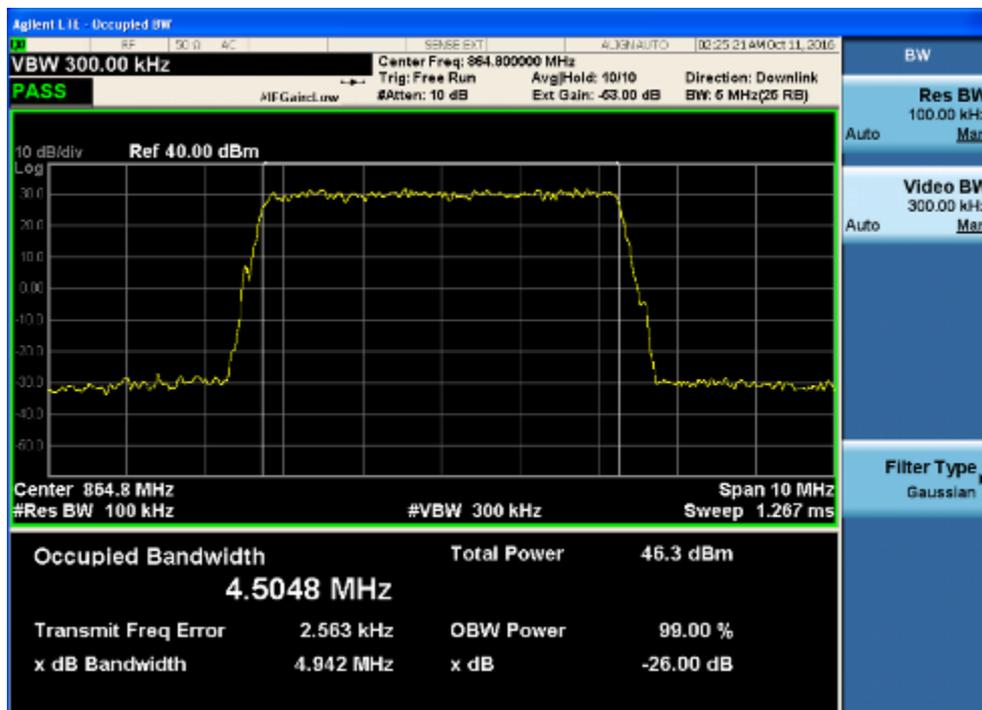



1.3.3 middle frequency-- Input

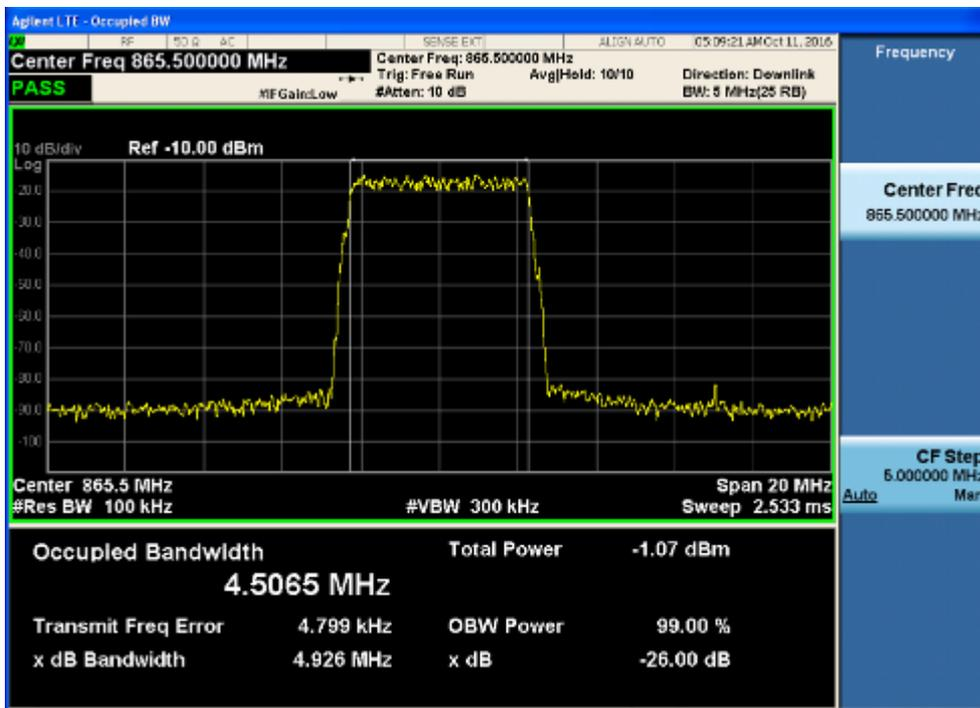

1.3.4 middle frequency-- Output

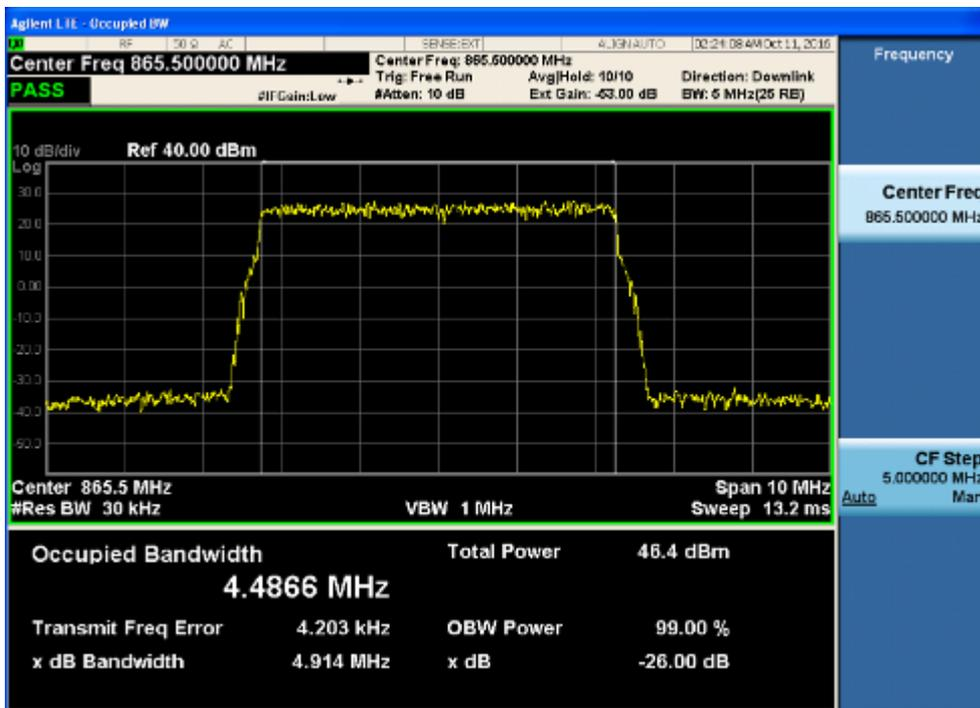



1.3.5 highest frequency-- Input

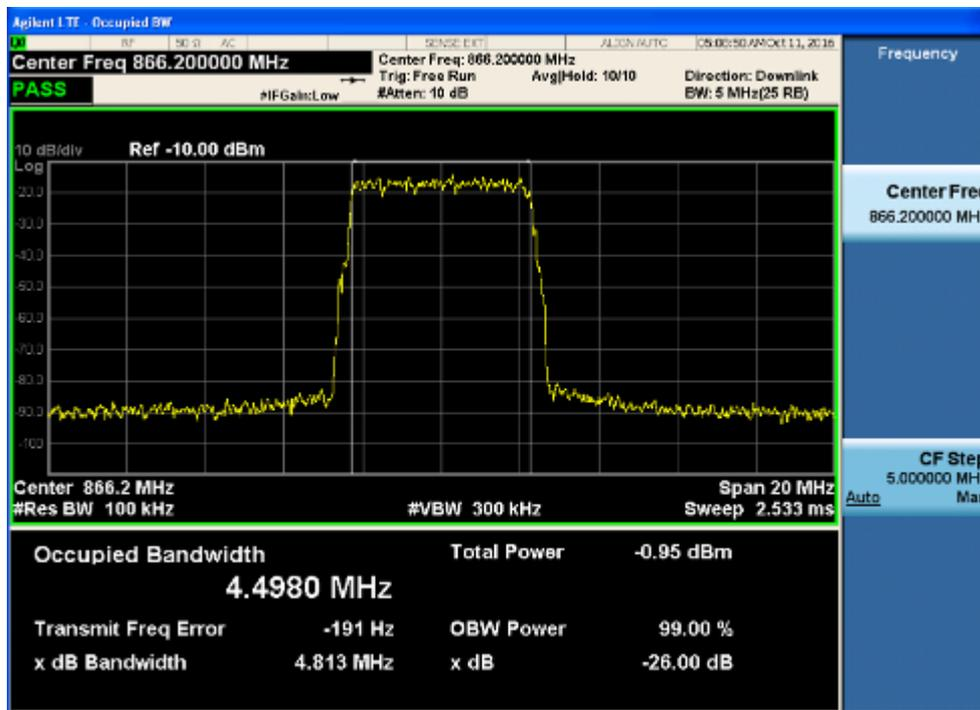

1.3.6 highest frequency-- Output

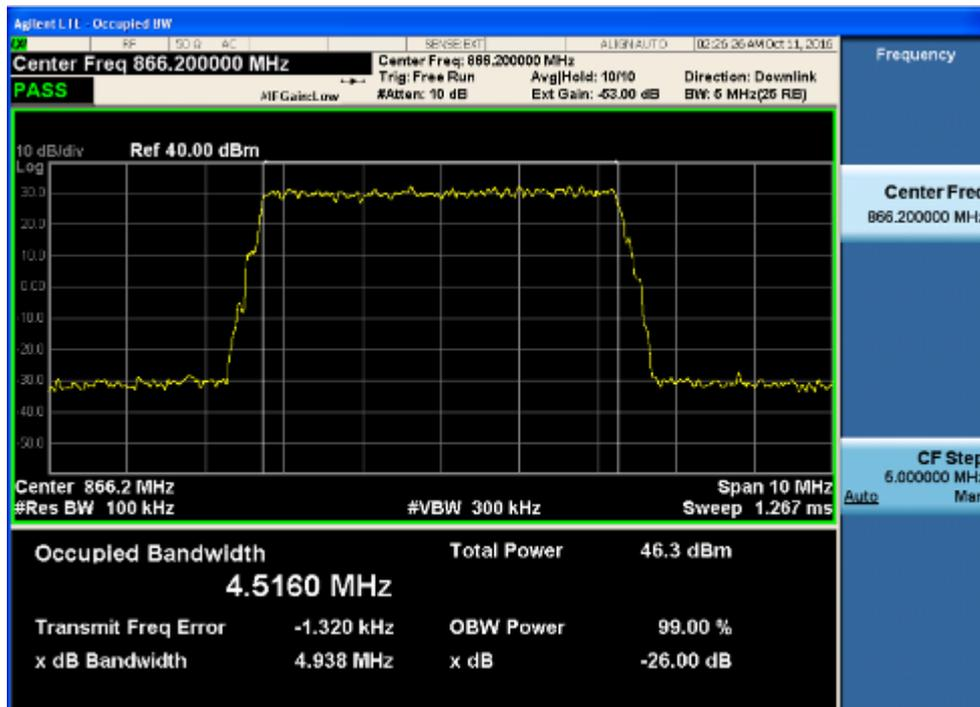



2. Downlink: 869MHz to 894MHz(GSM,CDMA,WCDMA,LTE)

2.1 GSM Mode:

2.1.1 lowest frequency— Input

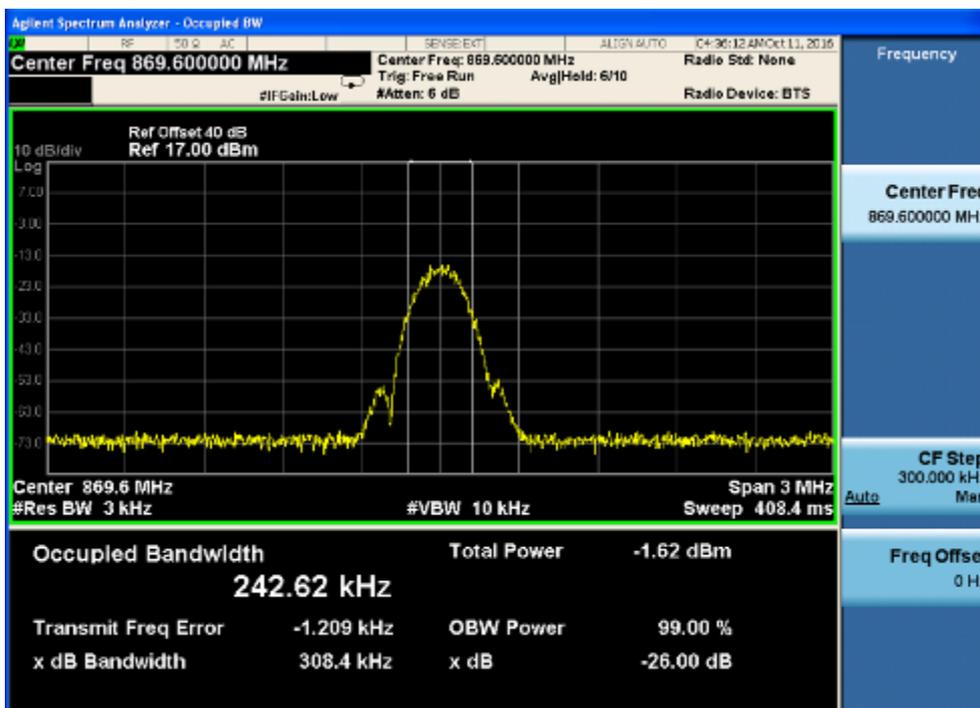

2.1.2 lowest frequency—Output

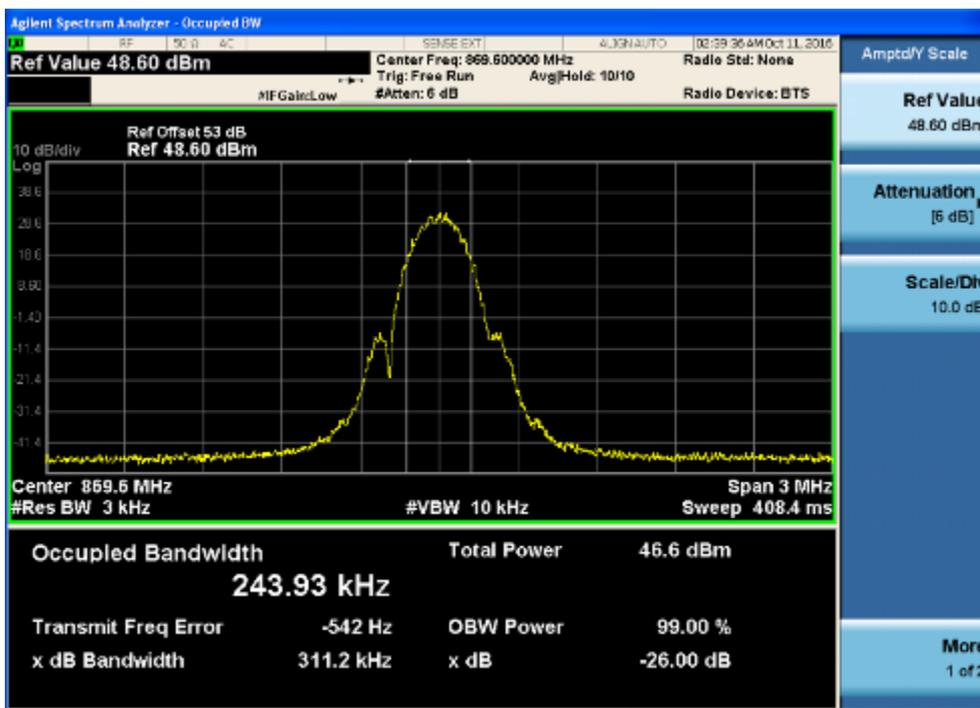



2.1.3 middle frequency—Input

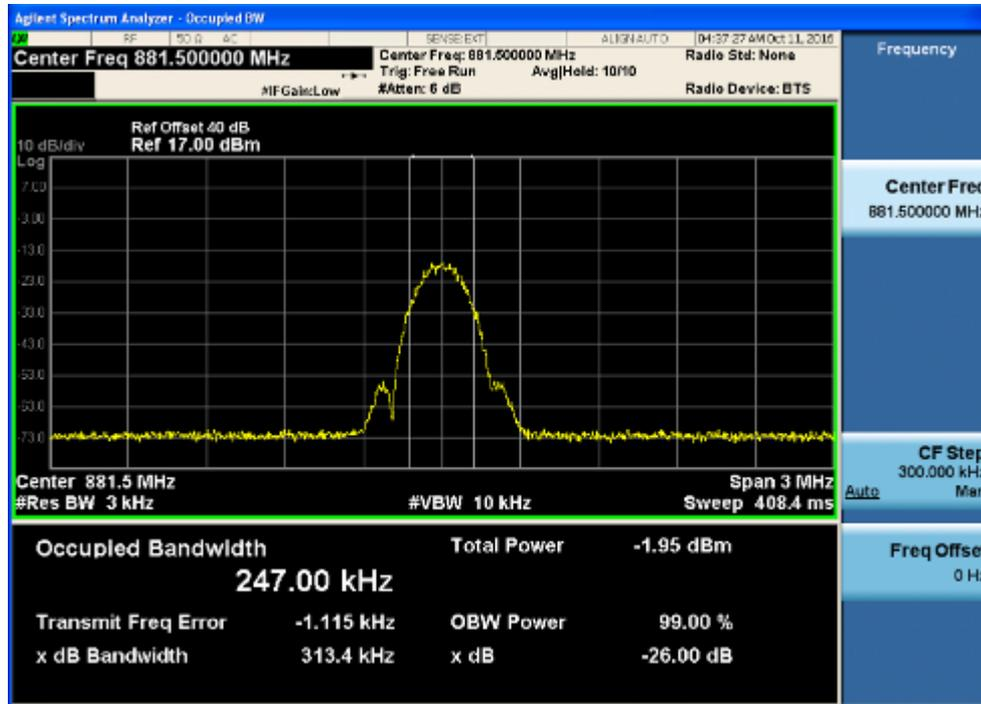

2.1.4 middle frequency—Output

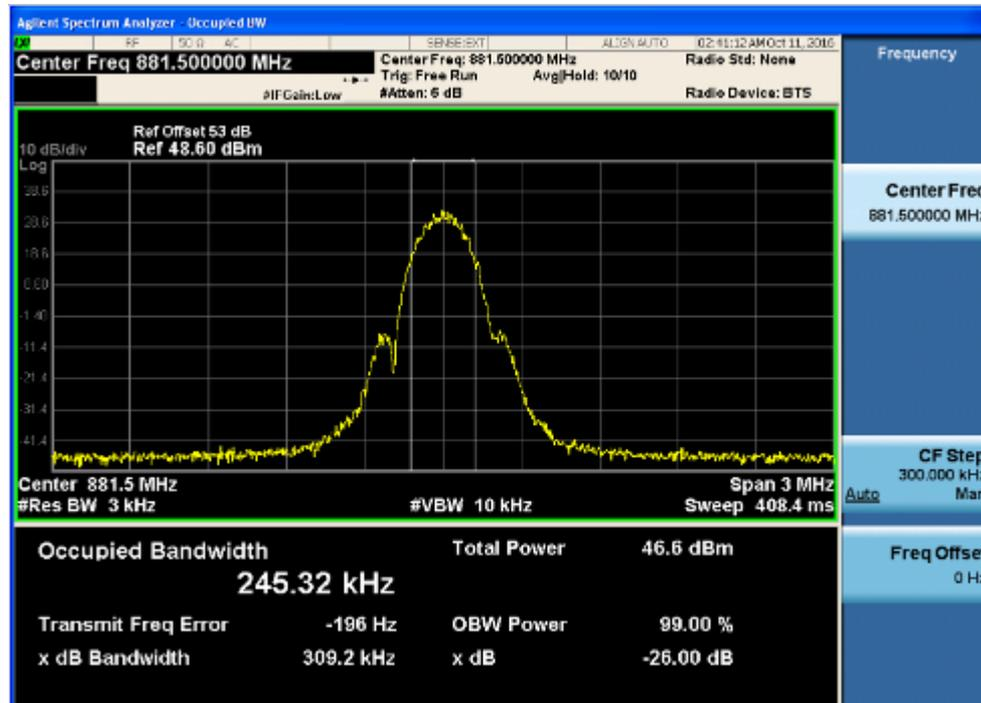



2.1.5 highest frequency—Input

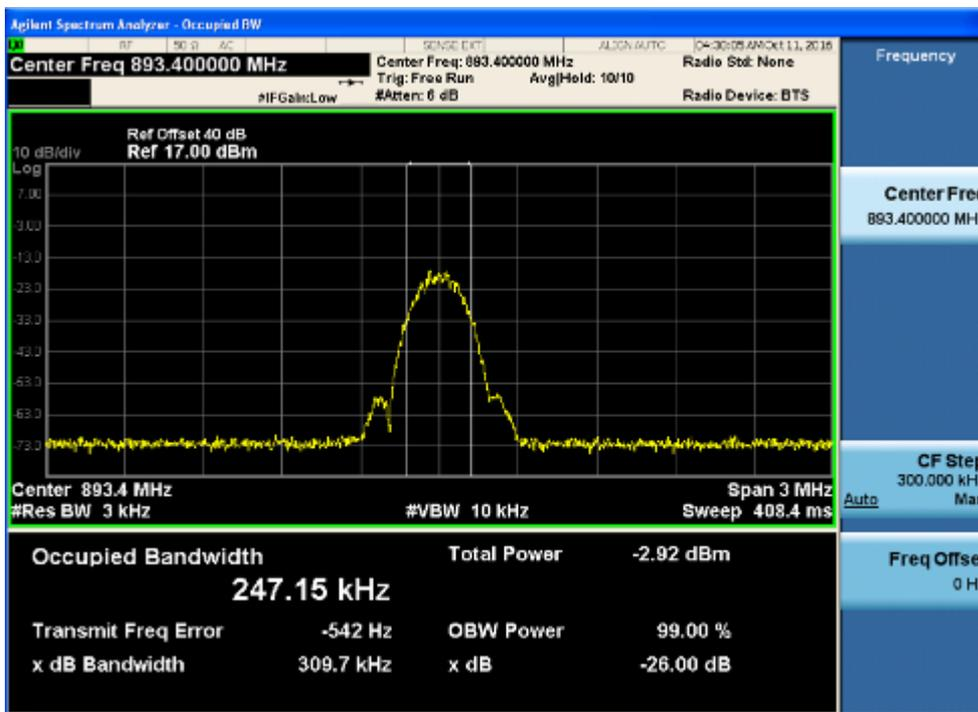

2.1.6 highest frequency—Output

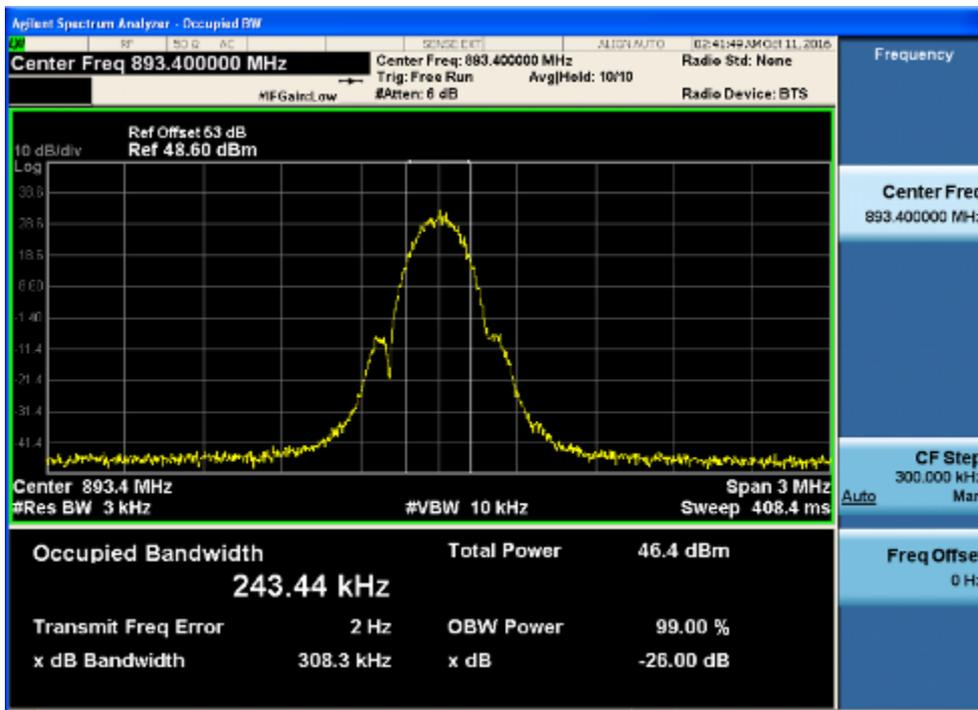



2.2 CDMA Mode:

2.2.1 lowest frequency— Input

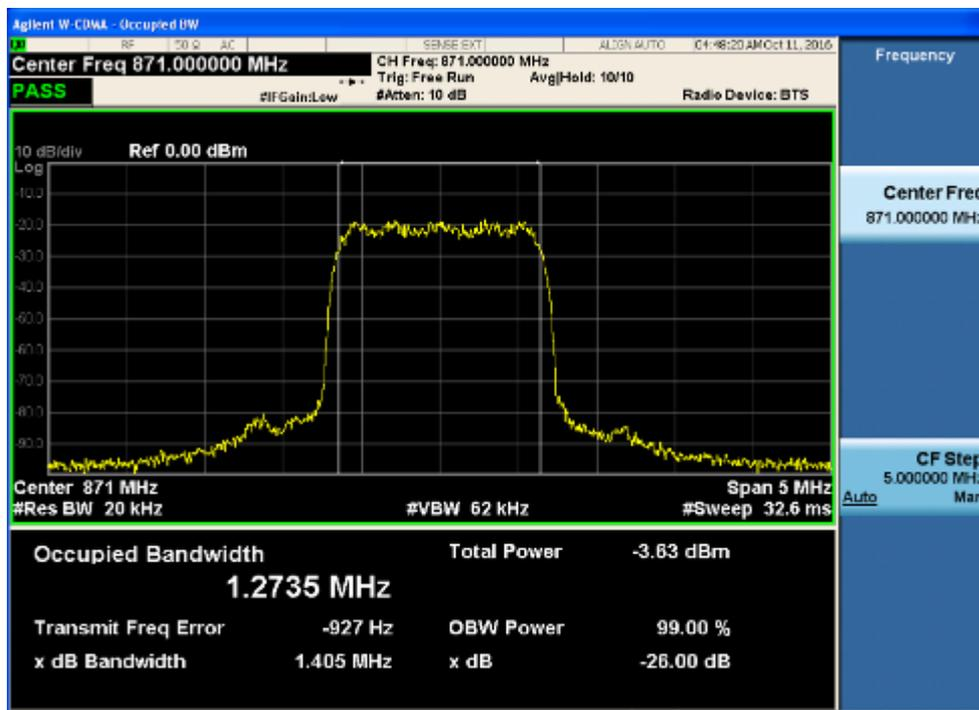

2.2.2 lowest frequency—Output

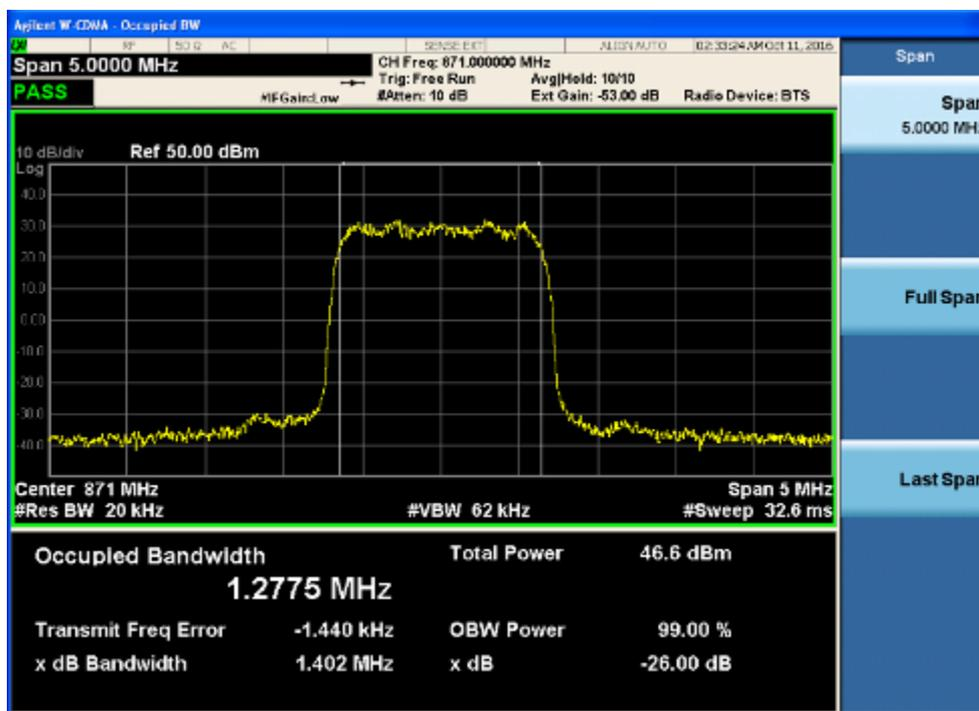

2.2.3 middle frequency—Input

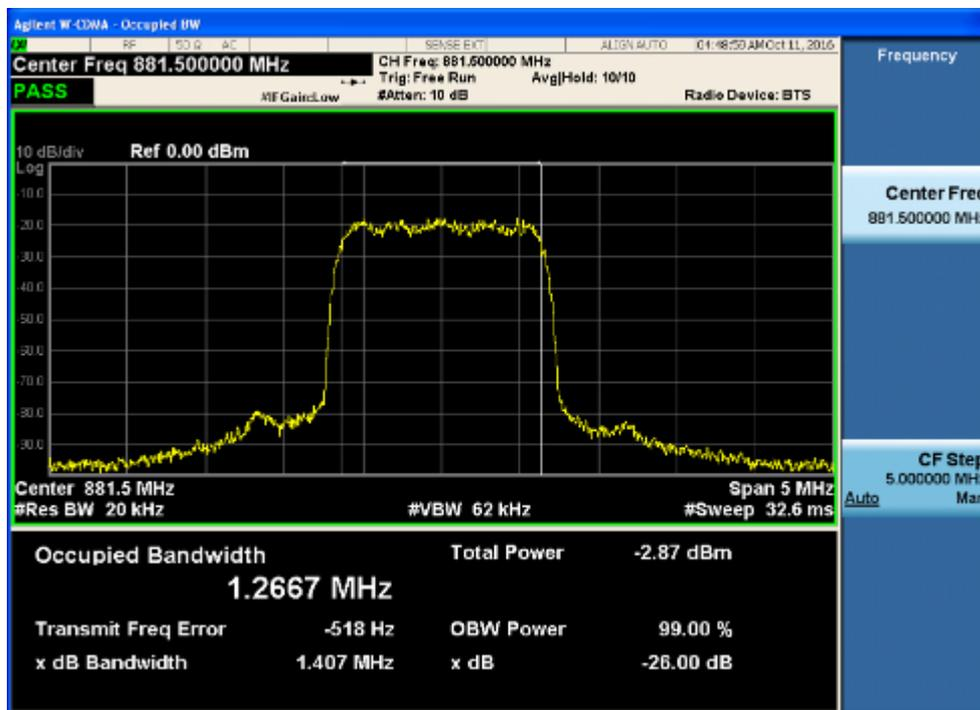

2.2.4 middle frequency—Output

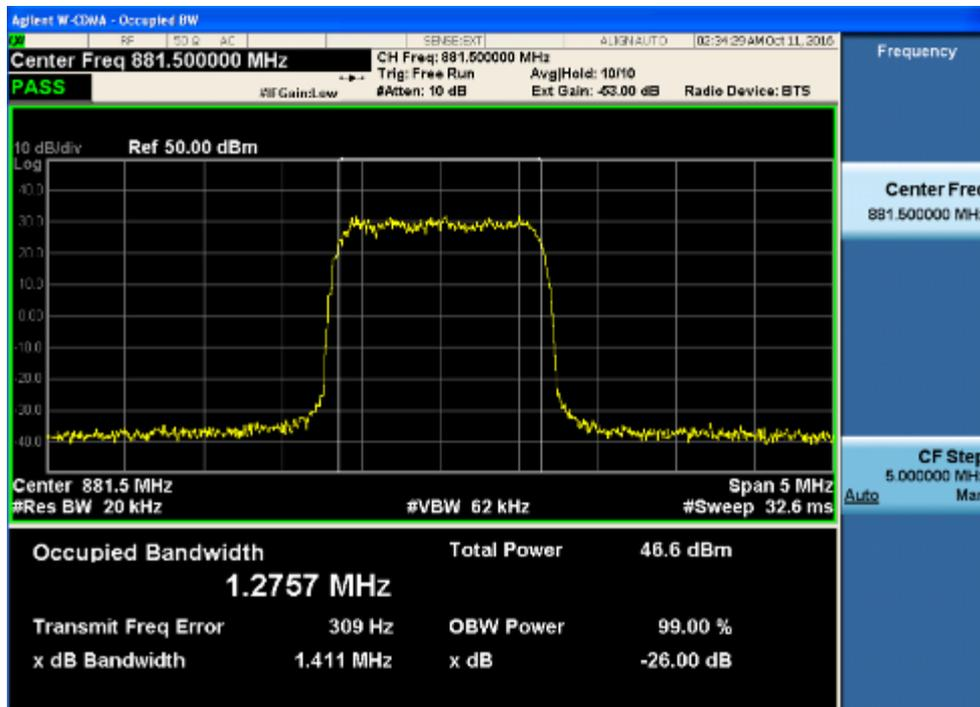

2.2.5 highest frequency—Input

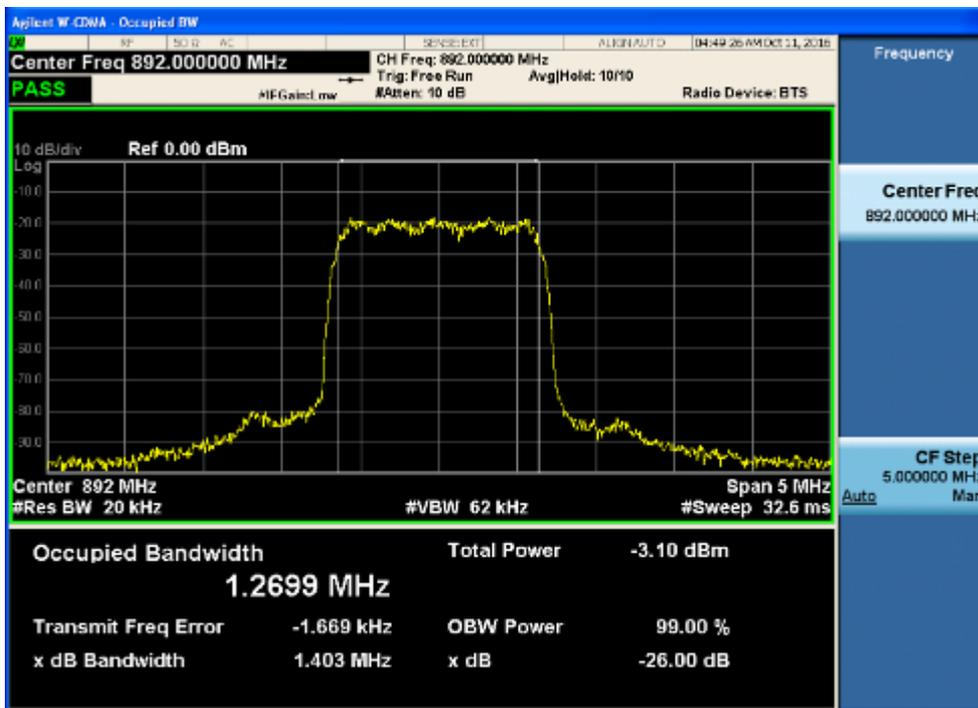

2.2.6 highest frequency—Output

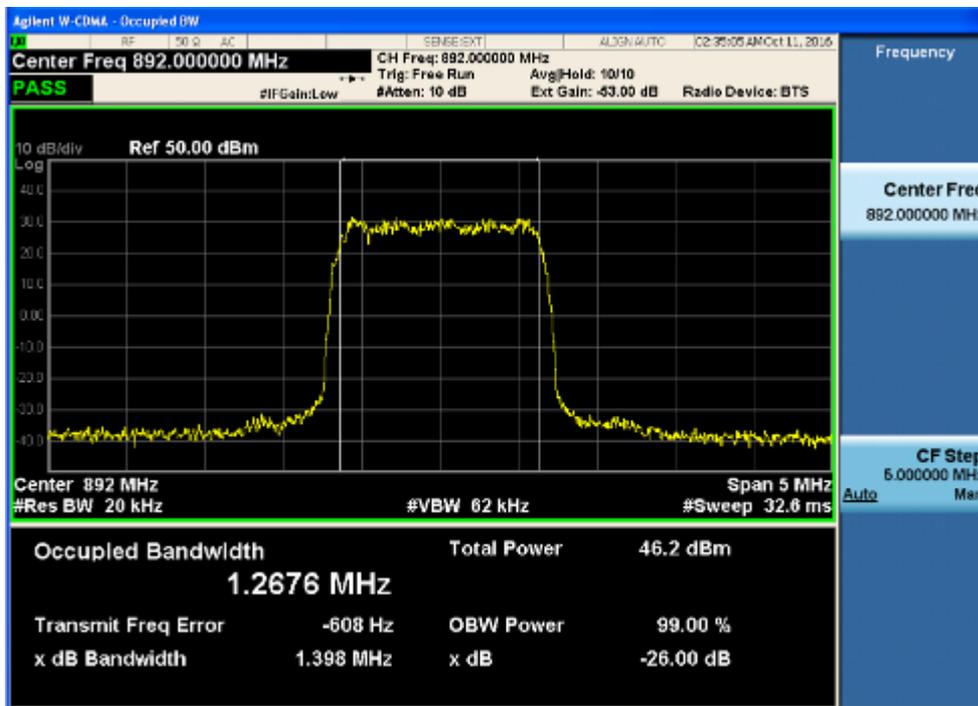

2.3 WCDMA Mode:

2.3.1 lowest frequency-- Input

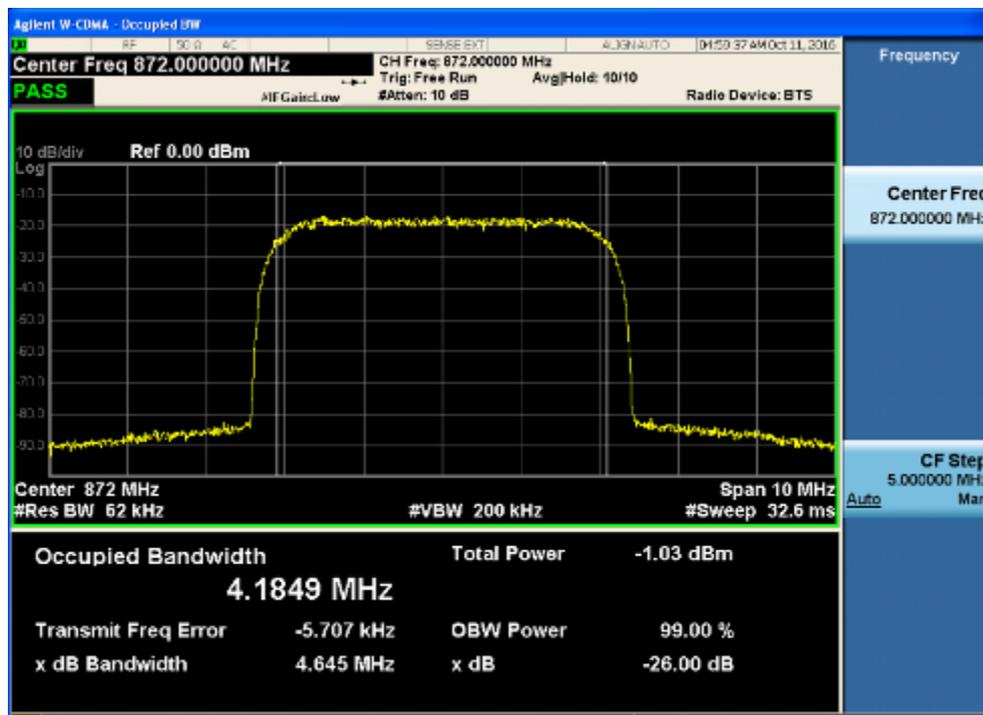

2.3.2 lowest frequency-- Output

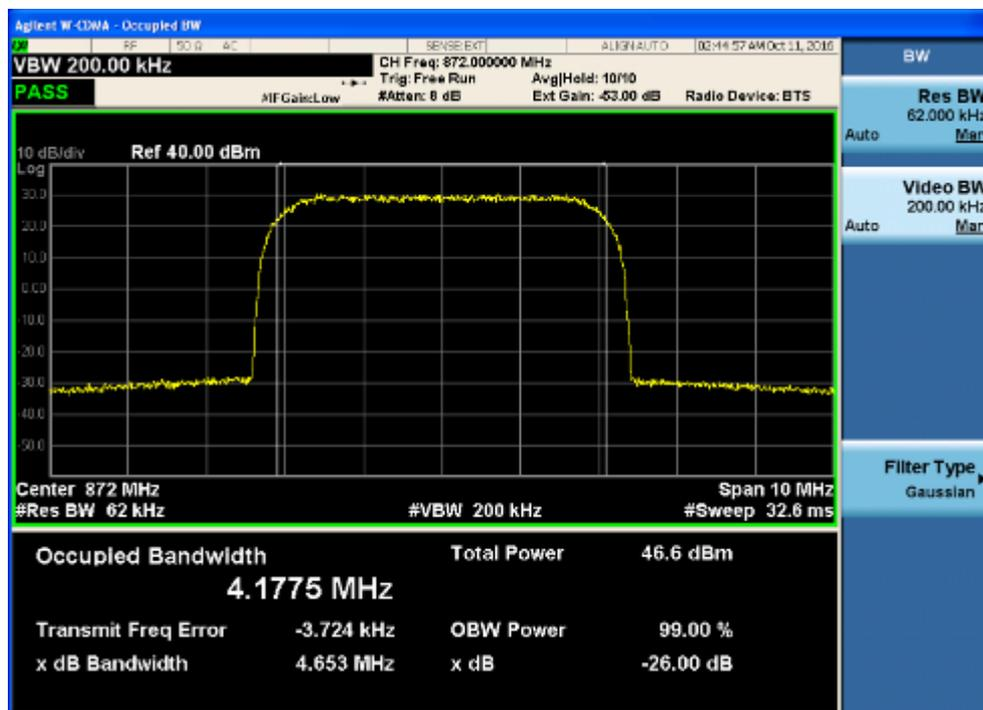

2.3.3 middle frequency-- Input

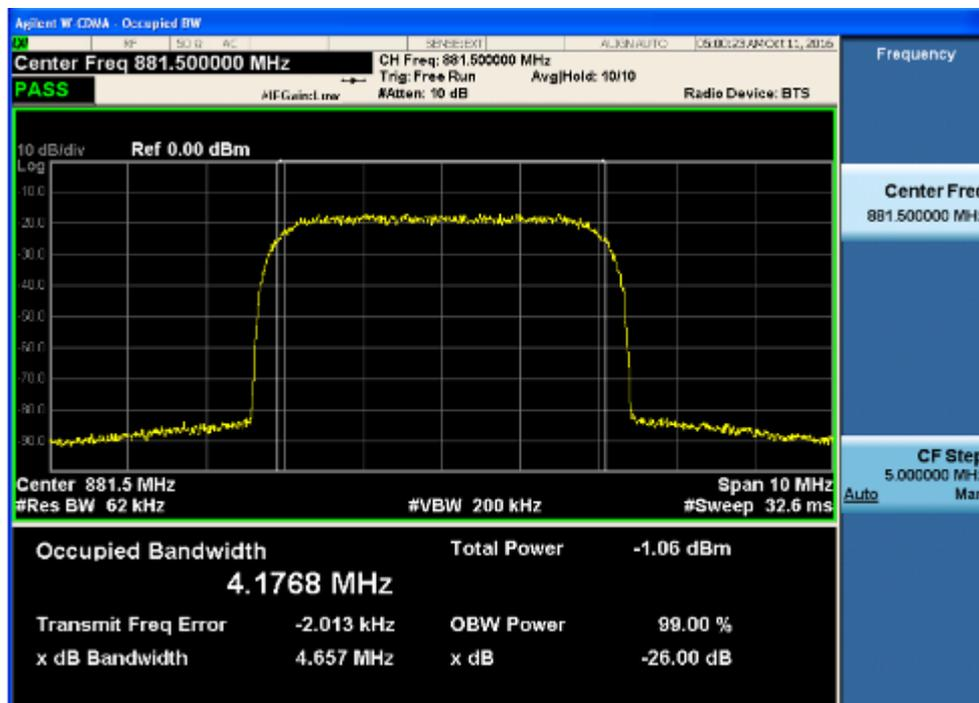

2.3.4 middle frequency-- Output

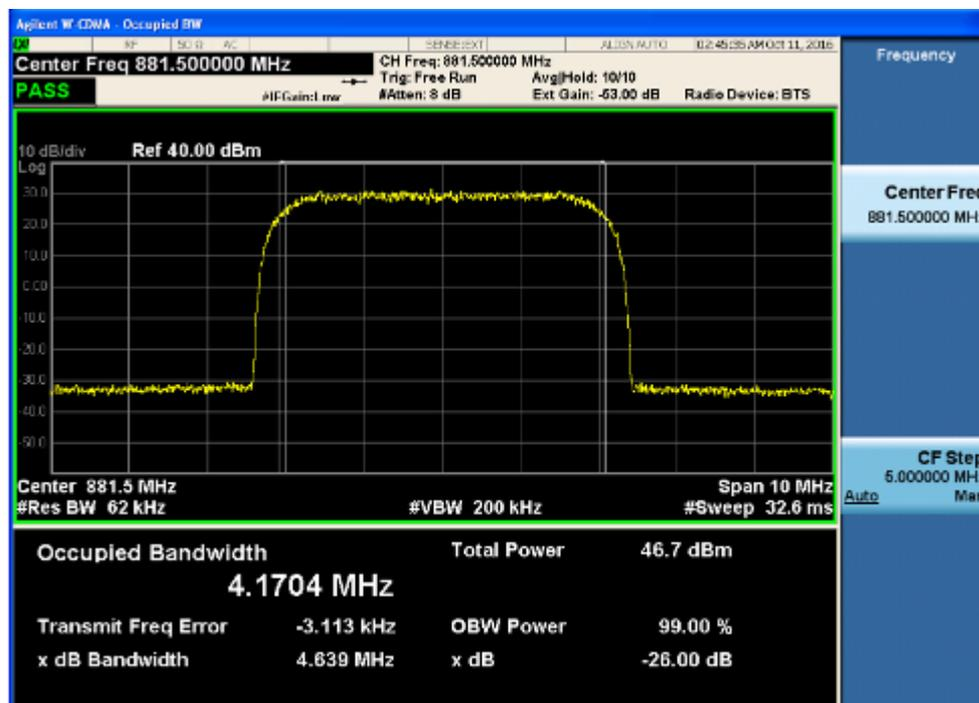

2.3.5 highest frequency—Input

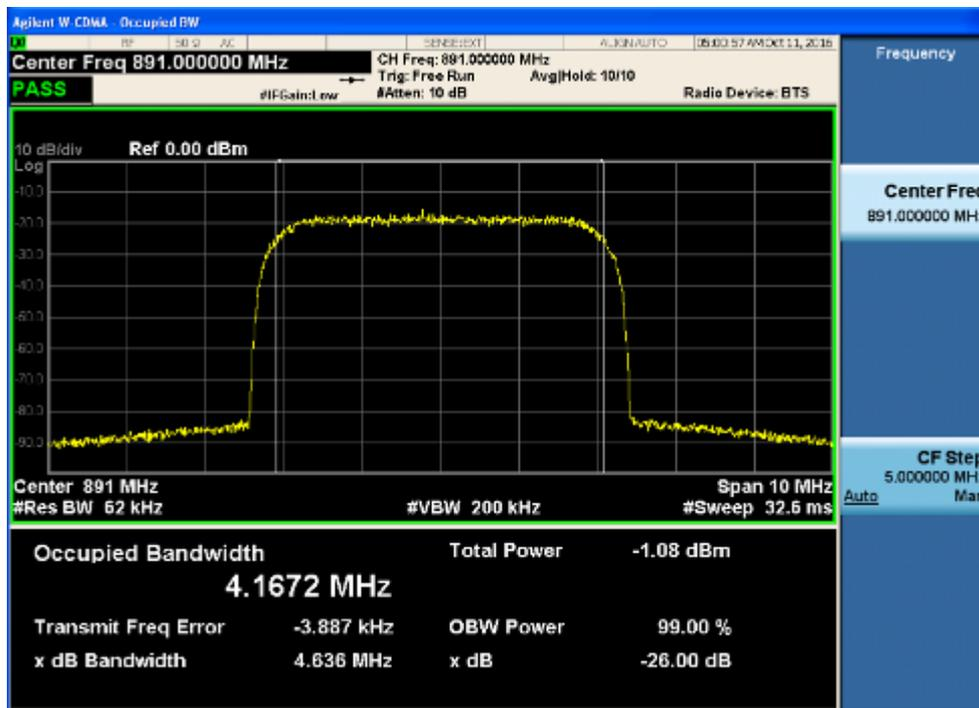

2.3.6 highest frequency--Output

