



SGS-CSTC Standards Technical Services Co., Ltd.

198 Kezhu Road, Sciencetech Park, Guangzhou Economic & Technological
 Development District, Guangzhou, China 510663
 Telephone: +86 (0) 20 82155555
 Fax: +86 (0) 20 82075059
 Email: ee.guangzhou@sgs.com
FEDERAL COMMUNICATIONS COMMISSION
 Registration number: 282399

Report No.: GZEM160900667102
 Page: 1 of 163
 FCC ID: OJFGXCPLA3

TEST REPORT

Application No.:	GZEM160906671RF
Applicant:	Corning Optical Communication Wireless
FCC ID:	OJFGXCPLA3
Product Description:	GX 40W Quad-Band Remote Unit
Model No.:	GX-E17E85P19L70-40 and GX-E17E85P19L70-40-DC ♣
♣	Please refer to section 3 of this report for further details.
Trade Mark:	GX
Standards:	FCC Part 22, FCC Part 24, FCC Part 27, FCC Part 2, FCC Part 90
Date of Receipt:	2016-10-08
Date of Test:	2016-10-08 and 2016-10-13
Date of Issue:	2016-11-03
Test Result :	Pass*



The manufacturer should ensure that all products in series production are in conformity with the product sample detailed in this report. If the product in this report is used in any configuration other than that detailed in the report, the manufacturer must ensure the new system complies with all relevant standards.



The report must not be used by the client to claim product certification, approval, or endorsement by NVLAP, NIST, or any agency of the federal government. All test results in this report can be traceable to National or International Standards.

This document is issued by the Company subject to its General Conditions of Service printed overleaf, available on request or accessible at <http://www.sgs.com/en/Terms-and-Conditions.aspx> and, for electronic format documents, subject to Terms and Conditions for Electronic Documents at <http://www.sgs.com/en/Terms-and-Conditions/Terms-e-Document.aspx>. Attention is drawn to the limitation of liability, indemnification and jurisdiction issues defined therein. Any holder of this document is advised that information contained hereon reflects the Company's findings at the time of its intervention only and within the limits of Client's instructions, if any. The Company's sole responsibility is to its Client and this document does not exonerate parties to a transaction from exercising all their rights and obligations under the transaction documents. This document cannot be reproduced except in full, without prior written approval of the Company. Any unauthorized alteration, forgery or falsification of the content or appearance of this document is unlawful and offenders may be prosecuted to the fullest extent of the law. Unless otherwise stated the results shown in this test report refer only to the sample(s) tested and such sample(s) are retained for 30 days only.

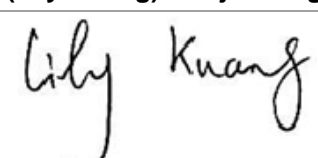

2 Version

Revision Record				
Version	Chapter	Date	Modifier	Remark
00		2016-11-03		Original

Authorized for issue by:			
Tested By			2016-10-08 and 2016-10-13 Date
	(Lily Kuang) /Project Engineer		
Prepared By			2016-10-16 Date
	(Lily Kuang) /Project Engineer		
Checked By			2016-10-16 Date
	(Ricky Liu) / Reviewer		



3 Test Summary

Test Item	Test Requirement	Test Method	Result
Output Power	FCC part90.635 FCC part 22.913 FCC part 24.232 FCC part 27.50	FCC part 2.1046 2-11-04/EAB/RF KDB935210 D05	PASS
Conducted Spurious Emissions	FCC part90.210 FCC part 22.917 FCC part 24.238 FCC part 27.53	FCC part 2.1051 2-11-04/EAB/RF KDB935210 D05	PASS
Band Edge& Intermodulation	FCC part90.210 FCC part 22.917 FCC part 24.238 FCC part 27.53	FCC part 2.1051 2-11-04/EAB/RF KDB935210 D05	PASS
Radiated Spurious Emissions	FCC part90.210 FCC part 22.917 FCC part 24.238 FCC part 27.53	FCC part 2.1053 2-11-04/EAB/RF KDB935210 D05	PASS
Occupied Bandwidth	FCC part 2.1049	FCC part 2.1049 2-11-04/EAB/RF KDB935210 D05	PASS
Out of Band Rejection	2-11-04/EAB/RF	2-11-04/EAB/RF KDB935210 D05	PASS
Frequency Stability	FCC part90.213 FCC part 22.355 FCC part 24.235 FCC part 27.54	FCC part 2.1055	PASS
Remark: Tx: In this whole report Tx (or tx) means Transmitter. Rx: In this whole report Rx (or rx) means Receiver.			
No need to implement uplink test as it is cable connect to BTS (No air radiation), then the test about Uplink would be ignored.			



✦ **Model No:** GX-E17E85P19L70-40 and GX-E17E85P19L70-40-DC

According to the confirmation from the applicant, the only difference between above two models is the power supply unit(PSU).

GX-E17E85P19L70-40 is with 100-240VAC power supply, while GX-E17E85P19L70-40-DC is with -48VDC power supply. The electrical circuit design, RF modules and optical module used for above models are all identical, the output power and other RF specifications are the same.

According to the above differences , the GX-E17E85P19L70-40 was performed full tests and the new model GX-E17E85P19L70-40-DC was tested the Radiated Emission test in this report.



4 Contents

	Page
1 COVER PAGE	1
2 VERSION	2
3 TEST SUMMARY	3
4 CONTENTS	5
5 GENERAL INFORMATION	6
5.1 CLIENT INFORMATION	6
5.2 GENERAL DESCRIPTION OF E.U.T.	6
5.3 DETAILS OF E.U.T.	6
5.4 PRODUCT DESCRIPTION	7
5.5 STANDARDS APPLICABLE FOR TESTING	7
5.6 TEST LOCATION	7
5.7 OTHER INFORMATION REQUESTED BY THE CUSTOMER	7
5.8 TEST FACILITY	8
6 EQUIPMENT USED DURING TEST	9
7 TEST RESULTS	11
7.1 E.U.T. TEST CONDITIONS	11
7.2 TEST PROCEDURE & MEASUREMENT DATA	13
7.2.1 RF Output Power	15
7.2.2 Conducted Spurious Emissions	20
7.2.3 Band Edge & Intermodulation	53
7.2.4 Radiated Spurious Emissions	100
7.2.5 Occupied Bandwidth	109
7.2.6 Out of Band Rejection	155
7.2.7 Frequency Stability	159



5 General Information

5.1 Client Information

Applicant Name: Corning Optical Communication Wireless
Applicant Address: 13221 Woodland Park Rd, Suite 400 Herndon VA, 20171, USA
Manufacturer: Comba Telecom Systems(China) Ltd.
Address of Manufacturer: No.10 Shenzhou Road, Guangzhou Science City, Guangzhou 510663, Guangdong, P.R. China

5.2 General Description of E.U.T.

Product Name: GX 40W Quad-Band Remote Unit
Model No.: GX-E17E85P19L70-40 and GX-E17E85P19L70-40-DC
Power Supply: AC 100-240V 50/60Hz or DC -48V
Test power: AC 120V 60Hz and DC -48V
Operating Temperature: -40 °C to +70°C
Operating Humidity: ≤ 95%

5.3 Details of E.U.T.

Type of Modulation CDMA & WCDMA & GSM & LTE
GXW(GSM)
Emission Designator: F9W(CDMA),
F9W (WCDMA)
G7D(LTE)
Frequency Band: Downlink 728MHz to 757MHz include the Modulation:LTE
Downlink: 862MHz to 869MHz
include the Modulation: CDMA, WCDMA,LTE
Downlink 869MHz to 894MHz include the Modulation:
GSM, CDMA, WCDMA, LTE
Downlink 1930MHz to 1995MHz include the Modulation:
GSM, CDMA, WCDMA, LTE
Downlink 2110MHz to 2180MHz include the Modulation:
CDMA, WCDMA, LTE
Nominal Power Output: 46dBm for downlink
Nominal System Gain: 68dB for downlink



5.4 Product Description

MobileAccessGX offers a scalable, cost-effective 40W (46dBm) high power remote outdoor coverage solution for Corning MobileAccess Distributed Antenna Systems (DAS). It is a fiber-fed, compact, multi-service, multi-operator remote designed to complement the MobileAccess1000 and MobileAccess2000 lower power, standard remotes or installable as a dedicated deployment solution in a new site, providing complete RF coverage options for open indoor, tunnel and adjacent outdoor spaces in larger venues such as stadiums, convention centers, metro-rails and malls.

5.5 Standards Applicable for Testing

The standard used was FCC part 2 & FCC part 22 & FCC part 24 & FCC part 27 & FCC part 90

5.6 Test Location

All tests were performed at:
SGS-CSTC Standards Technical Services Co., Ltd., Guangzhou Branch EMC Laboratory,
198 Kezhu Road, Sciencetech Park, Guangzhou Economic & Technology Development District,
Guangzhou, China 510663
Tel: +86 20 82155555 Fax: +86 20 82075059
No tests were sub-contracted.

5.7 Other Information Requested by the Customer

None.



5.8 Test Facility

The test facility is recognized, certified, or accredited by the following organizations:

- **NVLAP (Lab Code: 200611-0)**

SGS-CSTC Standards Technical Services Co., Ltd., Guangzhou EMC Laboratory is accredited by the National Voluntary Laboratory Accreditation Program (NVLAP/NIST). NVLAP Code: 200611-0.

The report must not be used by the client to claim product certification, approval, or endorsement by NVLAP, NIST, or any agency of the Federal Government.
- **ACMA**

SGS-CSTC Standards Technical Services Co., Ltd., EMC Laboratory can also perform testing for the Australian C-Tick mark as a result of our NVLAP accreditation.
- **SGS UK(Certificate No.: 32), SGS-TUV SAARLAND and SGS-FIMKO**

Have approved SGS-CSTC Standards Technical Services Co., Ltd., EMC Laboratory as a supplier of EMC TESTING SERVICES and SAFETY TESTING SERVICES.
- **CNAS (Lab Code: L0167)**

SGS-CSTC Standards Technical Services Co., Ltd., EMC Laboratory has been assessed and in compliance with CNAS-CL01:2006 accreditation criteria for testing laboratories (identical to ISO/IEC 17025:2005 General Requirements) for the Competence of Testing Laboratories.
- **FCC (Registration No.: 282399)**

SGS-CSTC Standards Technical Services Co., Ltd., EMC Laboratory has been registered and fully described in a report filed with the (FCC) Federal Communications Commission. The acceptance letter from the FCC is maintained in our files. Registration 282399, May 31, 2002.
- **Industry Canada (Registration No.: 4620B-1)**

The 3m/10m Alternate Semi-anechoic chamber of SGS-CSTC Standards Technical Services Co., Ltd., has been registered by Certification and Engineering of Industry Canada for radio equipment testing with Registration No. 4620B-1.
- **VCCI (Registration No.: R-2460, C-2584, G-449 and T-1179)**

The 10m Semi-anechoic chamber and Shielded Room of SGS-CSTC Standards Technical Services Co. Ltd. have been registered in accordance with the Regulations for Voluntary Control Measures with Registration No.: R-2460, C-2584, G-449 and T-1179 respectively.
- **CBTL (Lab Code: TL129)**

SGS-CSTC Standards Technical Services Co., Ltd., E&E Laboratory has been assessed and fully comply with the requirements of ISO/IEC 17025:2005, the Basic Rules, IEC 01 and Rules of procedure IEC 02, and the relevant IEC CB-Scheme Operational documents.



6 Equipment Used during Test

RE in Chamber						
No.	Test Equipment	Manufacturer	Model No.	Serial No.	Cal. date	Cal. Due date
					(YYYY-MM-DD)	(YYYY-MM-DD)
EMC0525	Compact Semi-Anechoic Chamber	ChangZhou ZhongYu	N/A	N/A	2014-12-05	2016-12-04
EMC0522	EMI Test Receiver	Rohde & Schwarz	ESIB26	100283	2016-02-01	2017-01-31
EMC0056	EMI Test Receiver	Rohde & Schwarz	ESCI	100236	2016-02-01	2017-01-31
EMC0528	RI High frequency Cable	SGS	20 m	N/A	2016-04-19	2018-04-18
EMC2025	Trilog Broadband Antenna 30-1000MHz	SCHWARZBECK MESS-ELEKTRONIK	VULB 9160	9160-3372	2016-09-08	2019-09-07
SEM003-18	Trilog Broadband Antenna 25-2000MHz	SCHWARZBECK MESS-ELEKTRONIK	VULB 9168	665	2016-06-29	2019-06-28
EMC0524	Bi-log Type Antenna	Schaffner -Chase	CBL6112B	2966	2016-09-08	2019-09-07
EMC0519	Bilog Type Antenna	Schaffner -Chase	CBL6143	5070	2014-05-04	2017-05-03
EMC2026	Horn Antenna 1-18GHz	SCHWARZBECK MESS-ELEKTRONIK	BBHA 9120D	9120D-841	2016-09-09	2019-09-08
EMC0521	1-26.5 GHz Pre-Amplifier	Agilent	8449B	3008A01649	2016-01-25	2017-01-24
EMC2065	Amplifier	HP	8447F	N/A	2016-07-04	2017-07-03
EMC2086	PRE AMPLIFIER MH648A	ANRITSU CORP	MH648A	N/A	2015-12-19	2016-12-18
EMC2063	Pre-amplifier 1GHz-26GHz	Compliance Direction Systems Lnc.	PAP-1G26-48	6279.628	2016-01-06	2017-01-05
EMC0523	Active Loop Antenna	EMCO	6502	42963	2016-02-27	2018-02-26
EMC2041	Broad-Band Horn Antenna (14)15-26.5(40)GHz	SCHWARZBECK MESS-ELEKTRONIK	BBHA 9170	9170-375	2014-05-26	2017-05-25
EMC2079	High Pass Filter(915MHz)	FSY MICROWAVE	HM1465-9SS	009	2016-01-25	2017-01-24
EMC2069	2.4GHz Filter	Micro-Tronics	BRM 50702	149	2016-01-25	2017-01-24
EMC0530	10m Semi-Anechoic Chamber	ETS	N/A	N/A	2016-04-30	2018-04-29



SGS-CSTC Standards Technical Services Co., Ltd.

Report No.: GZEM160900667101

Page: 10 of 163

FCC ID: OJFGXCPLA3

Other Equipment						
No:	Test Equipment	Manufacturer	Model No.	Serial No.	Cal. Date (dd-mm-yy)	Cal. Due Date (dd-mm-yy)
NA	Power Meter	Agilent	E4419B	MY45100856	2016-06-12	2017-06-11
NA	Signal Generator	Agilent	E4437B	US39260800	2016-6-17	2017-06-16
NA	Signal Generator	Agilent	E4438C	US39260800	2016-6-14	2017-06-13
NA	Spectrum Analyzer	Agilent	N9020A	MY48011385	2016-06-14	2017-06-13
NA	Spectrum Analyzer	Rohde&Schwarz	FSQ 8	SN0805772	2016-06-14	2017-06-13
NA	Attenuator	SHX manufacturer	30dB/50W	09031816	----	----
NA	Attenuator	SHX manufacturer	40dB/50W	09031312	----	----
NA	Attenuator	SHX manufacturer	50dB/50W	09053023	----	----
NA	Signal Generator	Rohde&Schwarz	SMU 200A	08103303	2016-06-12	2016-06-11

General used equipment						
No.	Test Equipment	Manufacturer	Model No.	Serial No.	Cal. date	Cal. Due date
					(YYYY-MM-DD)	(YYYY-MM-DD)
EMC0006	DMM	Fluke	73	70681569	2016-09-01	2017-08-31
EMC0007	DMM	Fluke	73	70671122	2016-08-22	2017-08-21



7 Test Results

7.1 E.U.T. test conditions

Input Voltage:	AC 120V and DC -48V
Operating Environment:	
Temperature:	22°C ~26°C
Humidity:	46%~56% RH
Atmospheric Pressure:	990~1005mbar
Test Requirement:	The RF output power of the EUT was measured at the antenna port, by adjusting the input power of signal generator to drive the EUT to get to maximum output power point and keep the EUT at maximum gain setting for all tests. The device should be tested on downlink. For detail test Modulation and Frequency, please refer to 7.2.

Remark:

FIBER-OPTIC AND OTHER SIMILAR RF DISTRIBUTION SYSTEMS

Fiber-optic distribution systems are a type of in-building radiation system that receives RF signals from an antenna, distributes the signal over fiber-optic cable, and then retransmits at another location for example within a building or tunnel. Most fiber-optic systems are signal boosters; however, some may be repeaters. These systems generally have two enclosures typically called host (or local or donor unit) and remote. Some systems may also have an optional expander box for fan-out to multiple remotes. The system transmits downlink signals from the remote unit to handsets, portables, or clients, and transmits uplink signals via from the host unit. Usually but not always the uplink goes through an intermediate amplifier to a "donor" antenna. Therefore both uplink and downlink must be tested, unless filing effectively documents how connection of uplink to donor antenna with or without an intermediate amplifier will be prevented, such as for always only a cabled connection to a base station. Fiber-optic systems are not amplifiers (AMP equipment class) – they are equipment class TNB or PCB. The same approval procedures also apply for multiple-enclosure systems connected by coax cable.

Synonyms and related terms: in-building radiation system, coverage enhancer, distributed antenna system, fiber-optic distribution system, converter, donor anten

Typical in-building or distributed antenna systems can consist of five different components (enclosures), not counting antennas:

1) host unit

- a) transmits uplink to base station via antenna thru coax, **passive interface unit**, or **active interface unit** (amplifier)
- b) sends base-station downlink via fiber-optic or coax to **remote**
- c) receives handset uplink via fiber-optic or coax from **remote**
- d) optional connection to **expansion unit** via fiber-optic
- e) separate FCC ID from **remote**, unless electrically identical
- f) **non-transmitting host unit**
- i) connects directly to a base station via coax cable but does not connect to antenna or amplifier
- ii) Part 15 digital device subject to Verification, no FCC ID

2) remote unit

- a) receives base-station downlink via fiber-optic or coax from **host**, transmits via antenna to handsets
- b) returns handset uplink via fiber-optic or coax to **host**
- c) separate FCC ID from **remote**, unless electrically identical



3) expansion unit

- a) fiber-optic or coax from **host**
- b) fiber-optic or coax fan-out to **remote(s)**
- c) Part 15 digital device subject to Verification, no FCC ID

4) passive interface unit

- a) contains attenuators, splitters, combiners
- b) coax cable connection between **host** and base-station
- c) passive device, no FCC ID

5) active interface unit

- a) amplifies uplink signal from **host unit** for transmit by donor antenna
- b) attenuates downlink from donor antenna
- c) coax cable connection between **host** and **active interface unit**
- d) usually has separate FCC ID; in some cases could be combined/included with **host** as one enclosure

GENERAL DEFINITIONS FOR CERTIFICATION PURPOSES:

The following three general definitions follow from those stated in the Part 22, 24, and 90 rule sections as listed above. Two of the definitions replace previous EAB internal definitions given for booster, repeater and extender. The general term "extender" is the same as booster, but booster should be used rather than extender. The general term "translator" is the same as repeater, but repeater should be used rather than translator.

External radio frequency power amplifier (ERFPA) - any device which, (1) when used in conjunction with a radio transmitter signal source, is capable of amplification of that signal, and (2) is not an integral part of a radio transmitter as manufactured. The EAS equipment class AMP is used only for an ERFPA device inserted between a transmitter (TNB/PCB) and an antenna (has only one antenna port)

Booster is a device that automatically reradiates signals from base transmitters without channel translation, for the purpose of improving the reliability of existing service by increasing the signal strength in dead spots. An "in-building radiation system" is a signal booster. These devices are not intended to extend the size of coverage from the originating base station. A booster can be either single or multiple channels.

Repeater is a device that retransmits the signals of other stations. Repeaters are different from boosters in that they can include frequency translation and can extend coverage beyond the design of the original base station. A repeater is typically single channel but can also be multiple channels.

ERFPA (AMP) and boosters/repeaters (TNB/PCB) can generally be authorized for all rule parts except 15 and 18.

Tests should be done with each typical signal. e.g., for F3E emissions use 2500 Hz with 2.5 or 5 kHz deviation. Use of CW signal for some tests is acceptable in lieu of actual emission, in some cases when CW signal gives worst case.

The GX system working principle: the RF signal coupled from BTS is transferred into optical signal, and then transmitted via a fiber to remote unit. the remote re-transfers the optical signal back to RF signal, through the frequency translation and after power amplifiers, can extend the BTS coverage to another desired area, the GX system is compliant with the description about repeater in FCC rules, So **the Equipment belongs to the repeater and TNB class.**

7.2 Test Procedure & Measurement Data

Test Modulation and Frequency

Downlink: 728MHz to 757MHz

Modulation	Lowest frequency	Middle frequency	Highest frequency
LTE	733	742.5	752

Downlink: 862MHz to 869MHz

Modulation	Lowest frequency	Middle frequency	Highest frequency
CDMA	863	865.5	868
WCDMA	865	865.5	866
LTE	864.8,	865.5	866.2

Downlink: 869MHz to 894MHz

Modulation	Lowest frequency	Middle frequency	Highest frequency
GSM	869.6.	881.5	893.4
CDMA	871	881.5	892
WCDMA	872	881.5	891
LTE	874	881.5	889

Downlink: 1930MHz to 1995MHz

Modulation	Lowest frequency	Middle frequency	Highest frequency
GSM	1930.6	1962.5	1994.4
CDMA	1932	1962.5	1993
WCDMA	1933	1962.5	1992
LTE	1935	1962.5	1990

Downlink: 2110 MHzto 2180MHz

Modulation	Lowest frequency	Middle frequency	Highest frequency
CDMA	2112	2145	2178
WCDMA	2113	2145	2177
LTE	2115	2145	2175

Remark:

- 1) We test the downlink in the lowest band; the middle band; the highest band and test the respective frequency as above table;

General Test Setup:

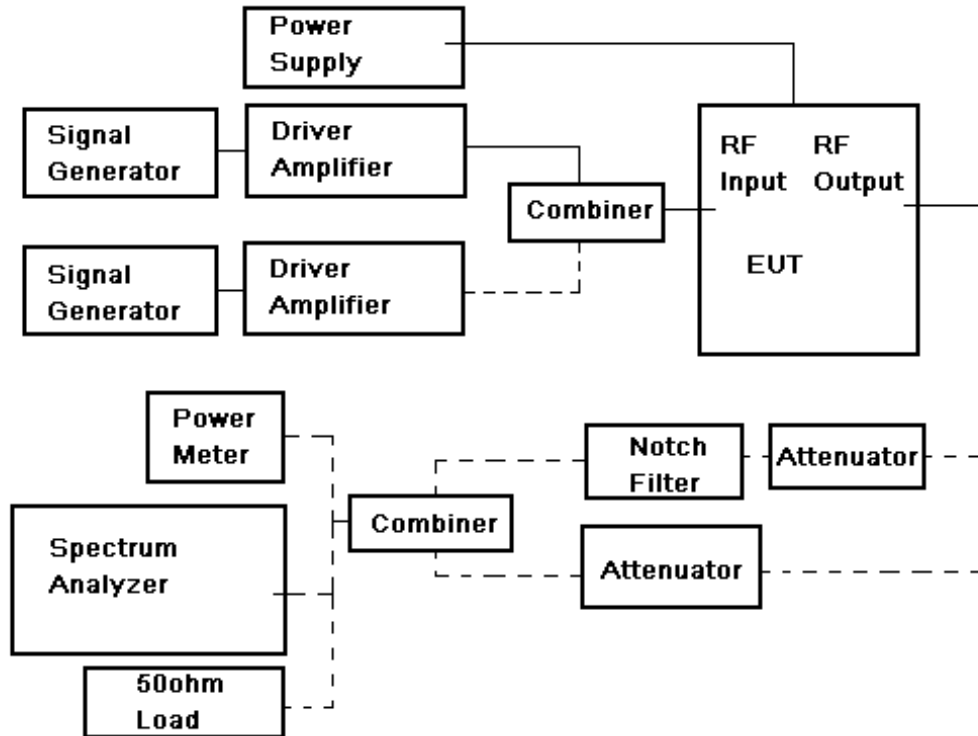



7.2.1 RF Output Power

Test Date: 2016-10-09

Test Requirement: FCC part 90.635 & FCC part 22.913(a) & FCC part 24.232(a)&(b) & FCC part 27.50(d)

90.635(a) The effective radiated power and antenna height for base stations may not exceed 1 kilowatt(30dBW) and 304m.(1,000ft.) above average terrain(AAT),respectively,or the equivalent thereof as determined from the Table. These are maximum values,and applicants will be required to justify power levels and antenna heights requested.

22.913(a):Maximum ERP. In general, the effective radiated power (ERP) of base transmitters and cellular repeaters must not exceed 500 Watts.

24.232(a) Base stations are limited to 1640 watts peak equivalent isotropically radiated power (EIRP) with an antenna height up to 300 meters HAAT, except as described in paragraph (b) below. See §24.53 for HAAT calculation method. Base station antenna heights may exceed 300 meters with a corresponding reduction in power; see Table 1 of this section. The service area boundary limit and microwave protection criteria specified in §§24.236 and 24.237 apply.

Para. No.27.50(b)(2), (c)(1)(3)

(b) The following power and antenna height limits apply to transmitters operating in the 746-763 MHz, 775-793 MHz and 805-806 MHz bands:

(2) Fixed and base stations transmitting a signal in the 746-757 MHz, 758-763 MHz, 776-787 MHz, and 788-793 MHz bands with an emission bandwidth of 1 MHz or less must not exceed an ERP of 1000 watts and an antenna height of 305 m HAAT, except that antenna heights greater than 305 m HAAT are permitted if power levels are reduced below 1000 watts ERP in accordance with Table 1 of this section.

(c) The following power and antenna height requirements apply to stations transmitting in the 698-746 MHz band:

(1) Fixed and base stations transmitting a signal with an emission bandwidth of 1 MHz or less must not exceed an effective radiated power (ERP) of 1000 watts and an antenna height of 305 m height above average terrain (HAAT), except that antenna heights greater than 305 m HAAT are permitted if power levels are reduced below 1000 watts ERP in accordance with Table 1 of this section;

(3) Fixed and base stations transmitting a signal with an emission bandwidth greater than 1 MHz must not exceed an ERP of 1000 watts/MHz and an antenna height of 305 m HAAT, except that antenna heights greater than 305 m HAAT are permitted if power levels are reduced below 1000 watts/MHz ERP in accordance with Table 3 of this section;

Para. No.27.50(d)(1). The power of each fixed or base station transmitting in the 2110-2155 MHz band and located in any county with population density of

100 or fewer persons per square mile, based upon the most recently available population statistics from the Bureau of the Census, is limited to a peak equivalent isotropically radiated power (EIRP) of 3280 watts. The power of each fixed or base station transmitting in the 2110-2155 MHz band from any other location is limited to a peak EIRP of 1640 watts. A licensee operating a base or fixed station utilizing a power of more than 1640 watts EIRP must coordinate such operations in advance with all Government and non-Government satellite entities in the 2025-2110 MHz band.

Operations above 1640 watts EIRP must also be coordinated in advance with the following licensees within 120 kilometers (75 miles) of the base or fixed station: all Broadband Radio Service (BRS) licensees authorized under Part 27 in the 2155-2160 MHz band and all AWS licensees in the 2110-2155 MHz band.

Test Method: FCC part 2.1046
 EUT Operation:
 Status: Drive the EUT to maximum output power.
 Conditions: Normal conditions
 Application: Cellular Band RF output ports
 Test Configuration:

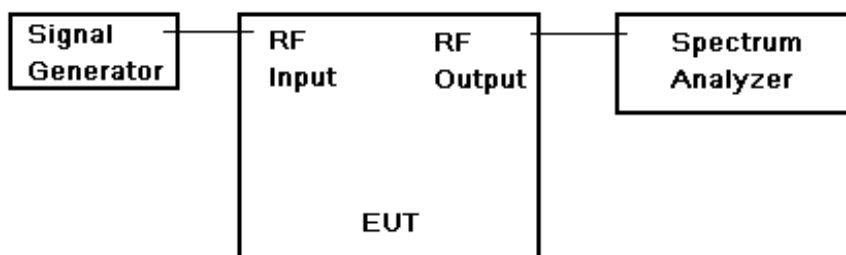

Fig.1 RF Output Power test configuration



Test Procedure:

RF output power test procedure:

1.
 - a) Connect the equipment as illustrated, when the output power is over the max value of the Spectrum Analyzer, add the attenuator to avoid destroying the facility.
 - b) Set the center frequency of the spectrum analyzer to the assigned transmitter frequency, key the transmitter, and set the level of the carrier to the full scale reference line.
 - c) do not apply any tone to modulate the EUT.
 - d1) Adjust the spectrum analyzer for the following settings:
 - 1) Resolution Bandwidth >> the carrier bandwidth,
 - 2) Video Bandwidth refer to standard requirement.
 - d2) Use spectrum analyzer channel power measurement function;
 - e) Record the frequencies and levels of carrier power;
 - f) Calculate the signal link way loss and final power value.
- Or 2.
 - a) Connect the equipment as illustrated;
 - b) Read the value from the power meter;
 - c) Calculate the signal link way loss and final power value.

Remark:

Output power –

Power on Form 731 should be clearly understood as either composite of multichannels or per carrier. If power is composite include in comments field: "Power output listed is composite for multi-channel operation."

Check that the input drive level is at maximum input rating and maximum gain settings for all tests. Check both uplink and downlink input levels. See manual or brochures/technical description for maximum rating. May need to check FCC identifier of transmitter used for tests.

Confirm device can not operate in saturation. Are there means to control maximum power and to assure linear operation (use in system configuration may be necessary)? How is saturation or over-modulation prevented for pulsed signal inputs?



7.2.1.1 Measurement Record:

Downlink: 728MHz ~ 757MHz

Per channel Power Input=-20dBm for downlink			
Modulation	Lowest frequency	Middle frequency	Highest frequency
LTE	46.3dBm (42657.9518mW)	46.2dBm (41686.9383mW)	46.1dBm (40738.0277mW)

Downlink: 862MHz ~ 869MHz

Per channel Power Input=-20dBm for downlink			
Modulation	Lowest frequency	Middle frequency	Highest frequency
CDMA	46.4dBm (43651.5832mW)	46.6dBm (45708.8189mW)	46.7dBm (46773.5141mW)
WCDMA	46.5dBm (44668.3592mW)	46.6dBm (45708.8189mW)	46.6dBm (45708.8189mW)
LTE	46.3dBm (42657.9518mW)	46.4dBm (43651.5832mW)	46.3dBm (42657.9518mW)

Downlink: 869MHz ~ 894MHz

Per channel Power Input=-20dBm for downlink			
Modulation	Lowest frequency	Middle frequency	Highest frequency
GSM	46.6dBm (45708.8189mW)	46.6dBm (45708.8189mW)	46.4dBm (43651.5832mW)
CDMA	46.6dBm (45708.8189mW)	46.6dBm (45708.8189mW)	46.2dBm (41686.9383mW)
WCDMA	46.6dBm (45708.8189mW)	46.7dBm (46773.5141mW)	46.5dBm (44668.3592mW)
LTE	46.3dBm (42657.9518mW)	46.5dBm (44668.3592mW)	46.3dBm (42657.9518mW)

Downlink: 1930MHz ~ 1995MHz

Per channel Power Input=-20dBm for downlink			
Modulation	Lowest frequency	Middle frequency	Highest frequency
GSM	46.1dBm (40738.0277mW)	47.0dBm (50118.7233mW)	46.4dBm (43651.5832mW)
CDMA	46.2dBm	46.7dBm	46.2dBm

This document is issued by the Company subject to its General Conditions of Service printed overleaf, available on request or accessible at <http://www.sgs.com/en/Terms-and-Conditions.aspx> and, for electronic format documents, subject to Terms and Conditions for Electronic Documents at <http://www.sgs.com/en/Terms-and-Conditions/Terms-e-Documents.aspx>. Attention is drawn to the limitation of liability, indemnification and jurisdiction issues defined therein. Any holder of this document is advised that information contained hereon reflects the Company's findings at the time of its intervention only and within the limits of Client's instructions, if any. The Company's sole responsibility is to its Client and this document does not exonerate parties to a transaction from exercising all their rights and obligations under the transaction documents. This document cannot be reproduced except in full, without prior written approval of the Company. Any unauthorized alteration, forgery or falsification of the content or appearance of this document is unlawful and offenders may be prosecuted to the fullest extent of the law. Unless otherwise stated the results shown in this test report refer only to the sample(s) tested and such sample(s) are retained for 30 days only.



SGS-CSTC Standards Technical Services Co., Ltd.

Report No.: GZEM160900667101

Page: 19 of 163

FCC ID: OJFGXCPLA3

	(41686.9383mW)	(46773.5141mW)	(41686.9383mW)
WCDMA	46.3dBm (42657.9518mW)	46.8dBm (47863.0092mW)	46.2dBm (41686.9383mW)
LTE	46.4dBm (43651.5832mW)	46.7dBm (46773.5141mW)	46.4dBm (43651.5832mW)

Downlink: 2110MHz ~ 2180MHz

Per channel Power Input=-20dBm for downlink			
Modulation	Lowest frequency	Middle frequency	Highest frequency
CDMA	46.1dBm (40738.0277mW)	46.5dBm (44668.3592mW)	46.5dBm (44668.3592mW)
WCDMA	46.1dBm (40738.0277mW)	46.5dBm (44668.3592mW)	46.4dBm (43651.5832mW)
LTE	46.1dBm (40738.0277mW)	46.4dBm (43651.5832mW)	46.4dBm (43651.5832mW)

7.2.2 Conducted Spurious Emissions

Test Date: 2016-10-09

Test Requirement: FCC part 90.210 & FCC part 22.917(a) FCC part 90.210 & & FCC part 24.238(a) & FCC part 27.53(h)
90.210, table "Application Emission Mask"

Frequency Band(MHz)	Mask for equipment with Audio Low pass filter	Mask for equipment without Audio Low pass filter
806-809/851-854	B	H
809-824/854-869 ³	B	G

(g)Emission Mask G. For transmitters that are not equipped with an audio low-pass filter, the power of an emission must be attenuated below the unmodulated carrier power (P) as follows:

(2) On any frequency removed from the center of the authorized bandwidth by more than 250 percent of the authorized bandwidth: At least $43 + 10 \log(P)$ dB.

22.917(a) Out of band emissions. The power of any emission outside of the authorized operating frequency ranges must be attenuated below the transmitting power (P) by a factor of at least $43 + 10 \log(P)$ dB.

24.238(a) Out of band emissions. The power of any emission outside of the authorized operating frequency ranges must be attenuated below the transmitting power (P) by a factor of at least $43 + 10 \log(P)$ dB.

27.53(h) For operations in the 1710–1755 MHz and 2110–2155 MHz bands, the power of any emission outside a licensee's frequency block shall be attenuated below the transmitter power (P) by at least $43 + 10 \log(P)$ dB.

Test Method: FCC part 2.1051

EUT Operation:

Status: Drive the EUT to maximum output power.

Conditions: Normal conditions

Application: Cellular Band RF output ports

Test Configuration:

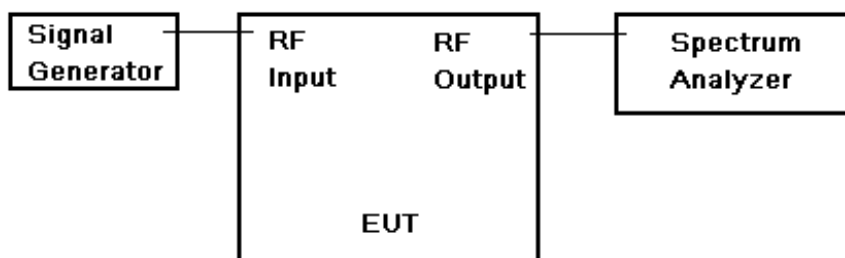
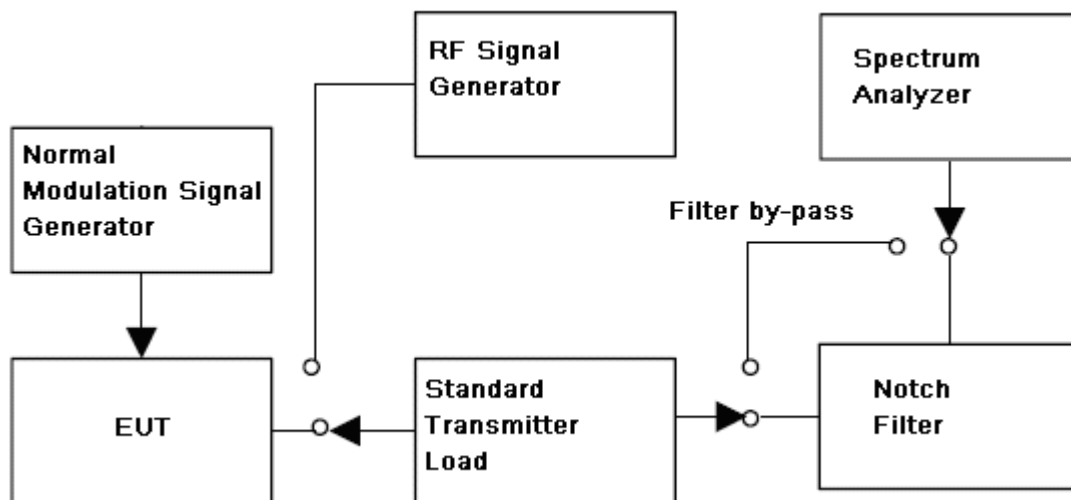

Fig.2. Conducted Spurious Emissions test configuration



Test Procedure:

Conducted Emissions test procedure:

- a) Connect the equipment as illustrated, with the notch filter by-passed, when the output power is over the max value of the Spectrum Analyzer, add the attenuator to avoid destroying the facility.
- b) Set the center frequency of the spectrum analyzer to the assigned transmitter frequency, key the transmitter, and set the level of the carrier to the full scale reference line.
- c) do not apply any tone to modulate the EUT.
- d) Adjust the spectrum analyzer for the following settings:
 - 1) Resolution Bandwidth,(base the standard, apply the different set),her is 100KHz for frequency band less than 1GHz, 1MHz for frequency over 1GHz;
 - 2) Video Bandwidth refer to standard requirement.
- e) Adjust the center frequency of the spectrum analyzer for incremental coverage of the range from:
 - 1) the lowest radio frequency generated in the equipment, it can be 9KHz base the test method, here select 30MHz as lowest frequency start point;
 - 2) the highest radion frequency shall higher than 10 times of carrier frequency;
- f) Record the frequencies and levels of spurious emissions from step e)

Remark:

The notch filter is used for avoid the EUT fundamental carrier output power making the spectrum overload and the harmonic spurious brought by it.
 When the EUT fundamental carrier is not enough to make the status, the notch filter could be not used.

7.2.2.1 Measurement Record:

1. Downlink: 728MHz ~ 757MHz
 - 1.1 For LTE mode:
 - 1) Lowest frequency
 - 9KHz to 1GHz

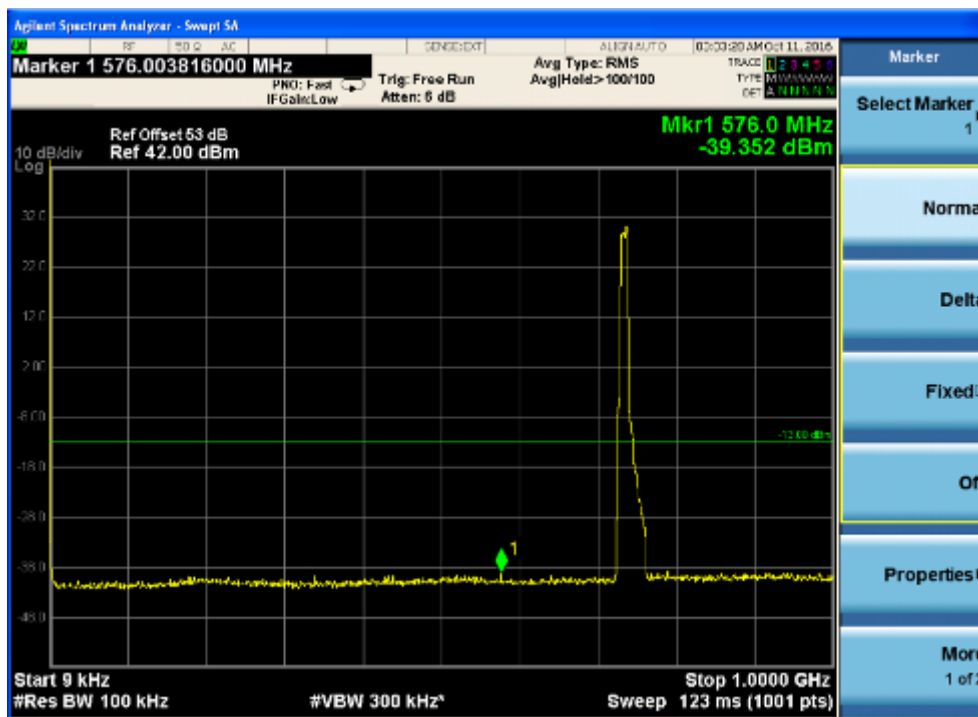

1GHz to 3.7GHz

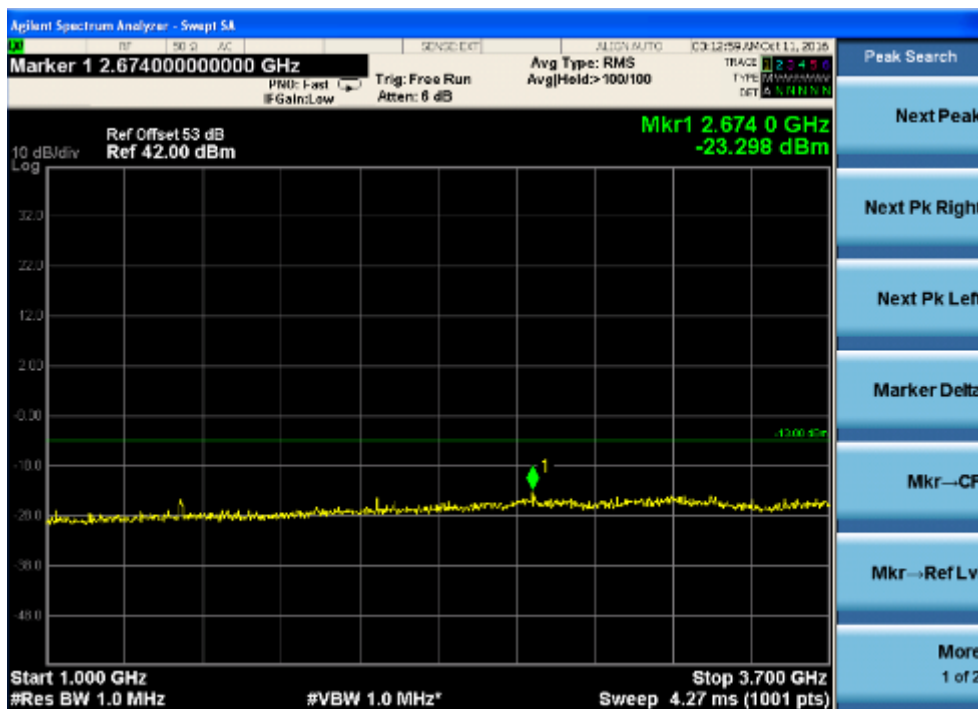



3GHz to 10GHz

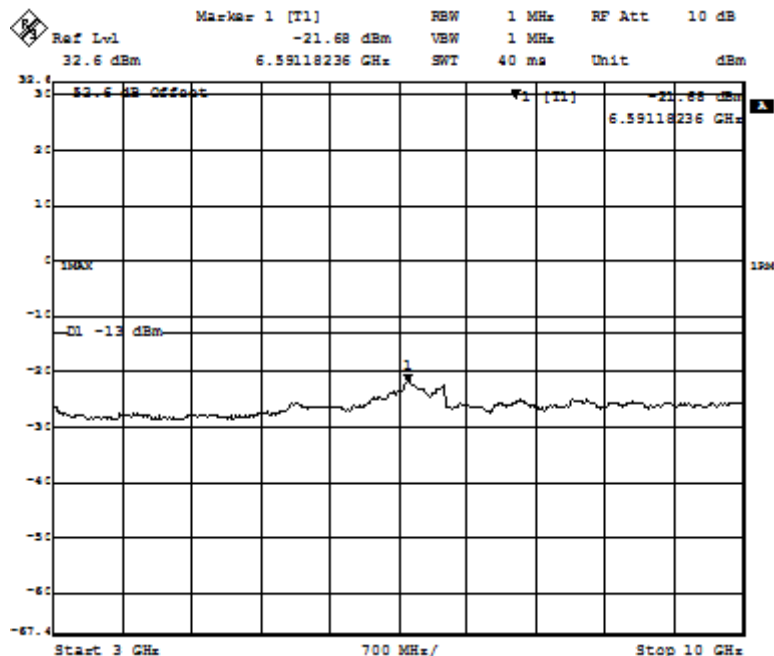

2) Middle frequency

9KHz to 1GHz

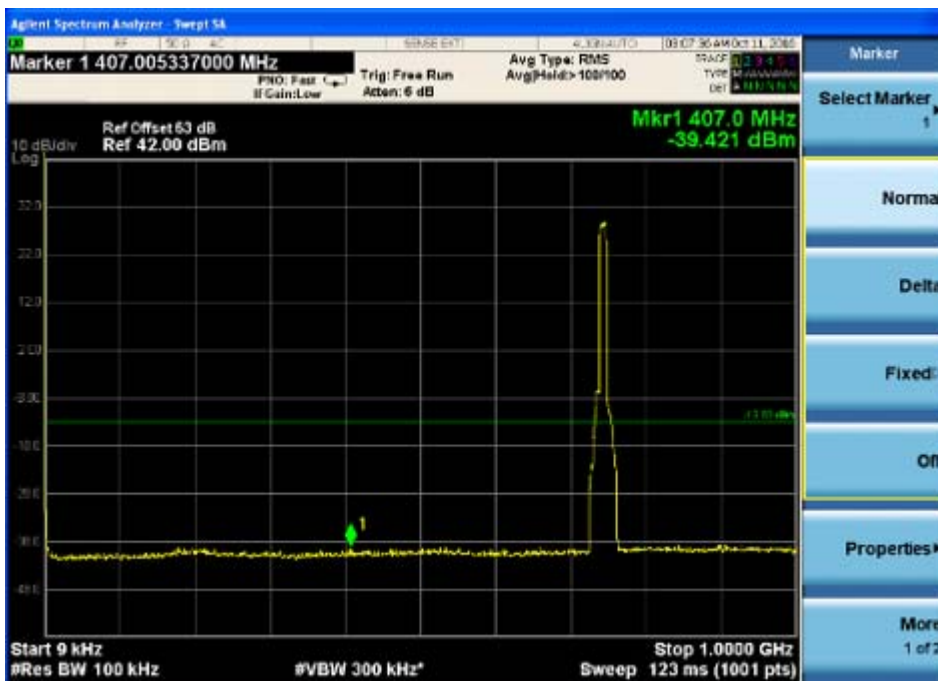



1GHz to 3.7GHz

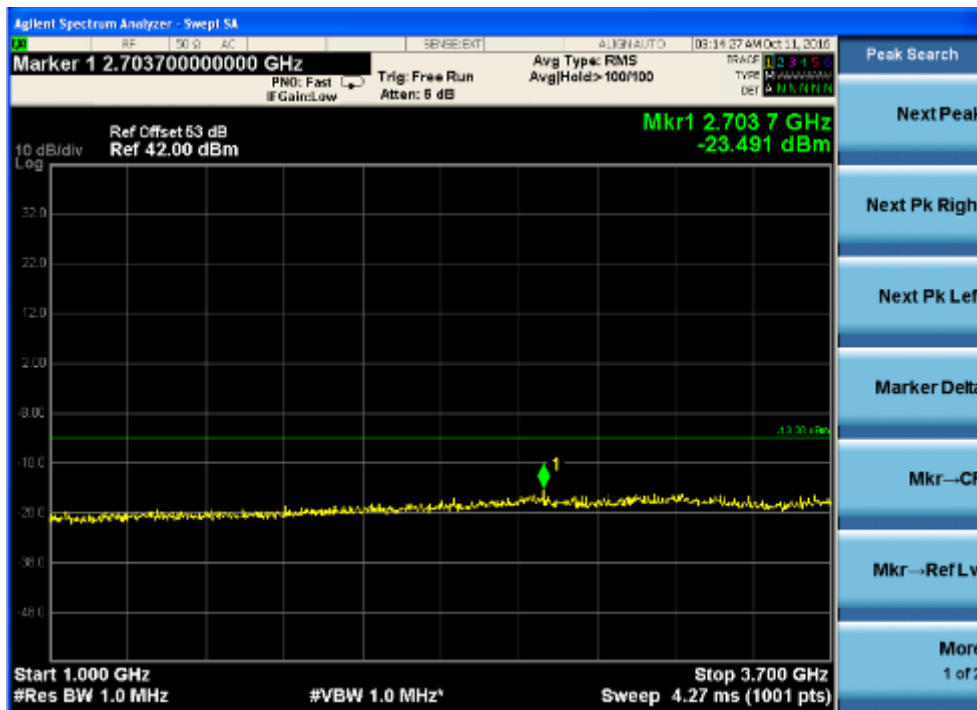

3GHz to 10GHz

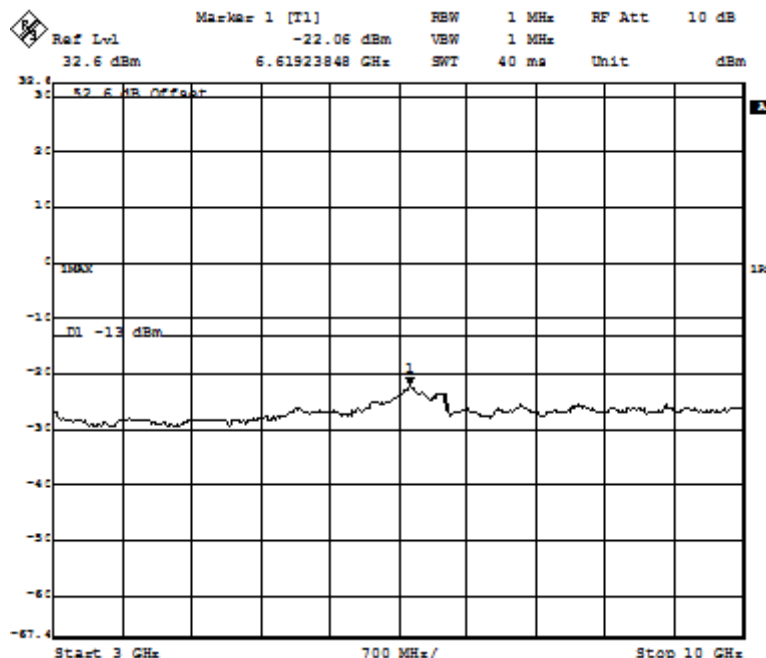



3)highest frequency

9KHz to 1GHz

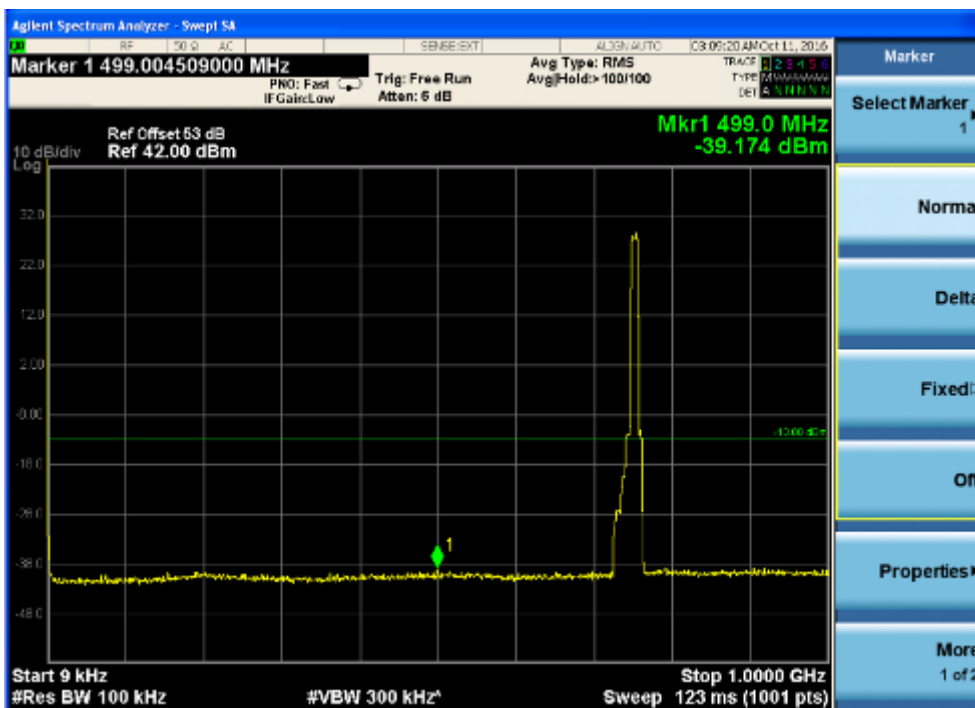

1GHz to 3.7GHz

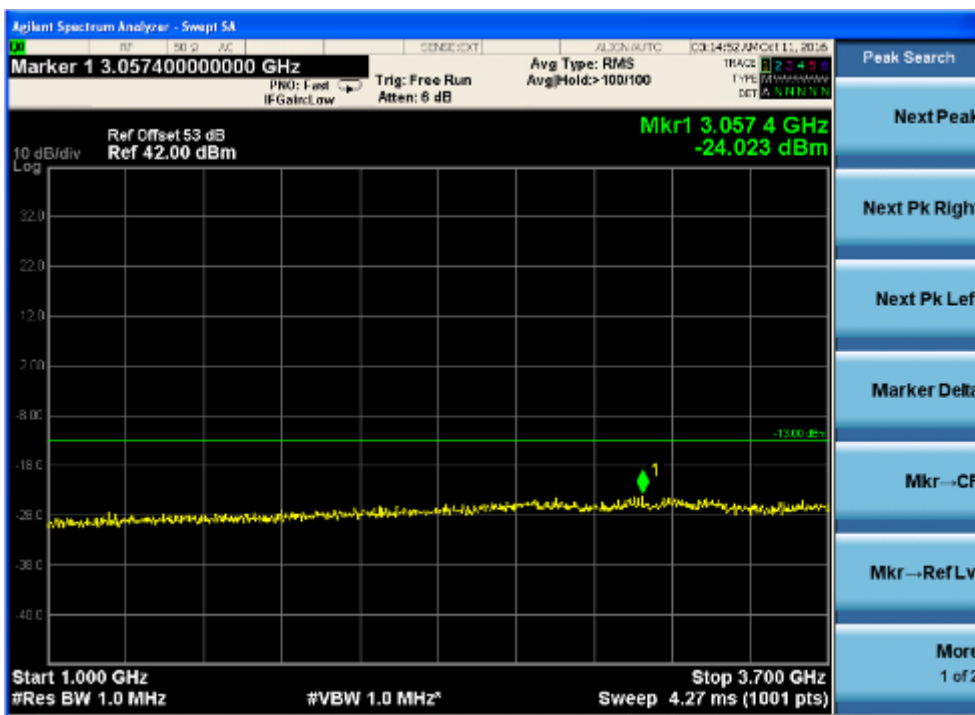



3GHz to 10GHz

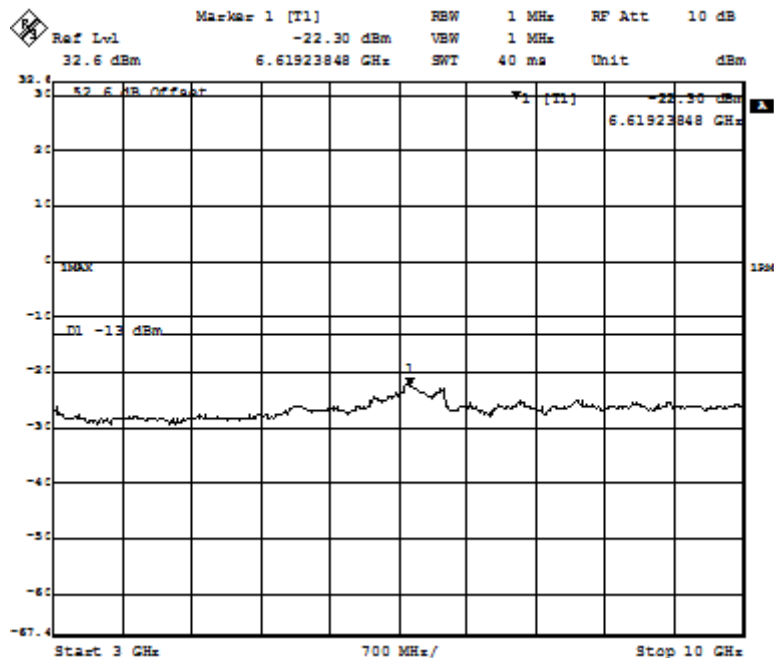

2. Downlink: 862MHz ~ 869MHz

Remark:

The data of the CDMA mode and WCDMA mode is almost the same with LTE mode, so we only show the photo in the LTE mode, others record the data.

1.2 For LTE mode:

1) Lowest frequency

9KHz to 1GHz

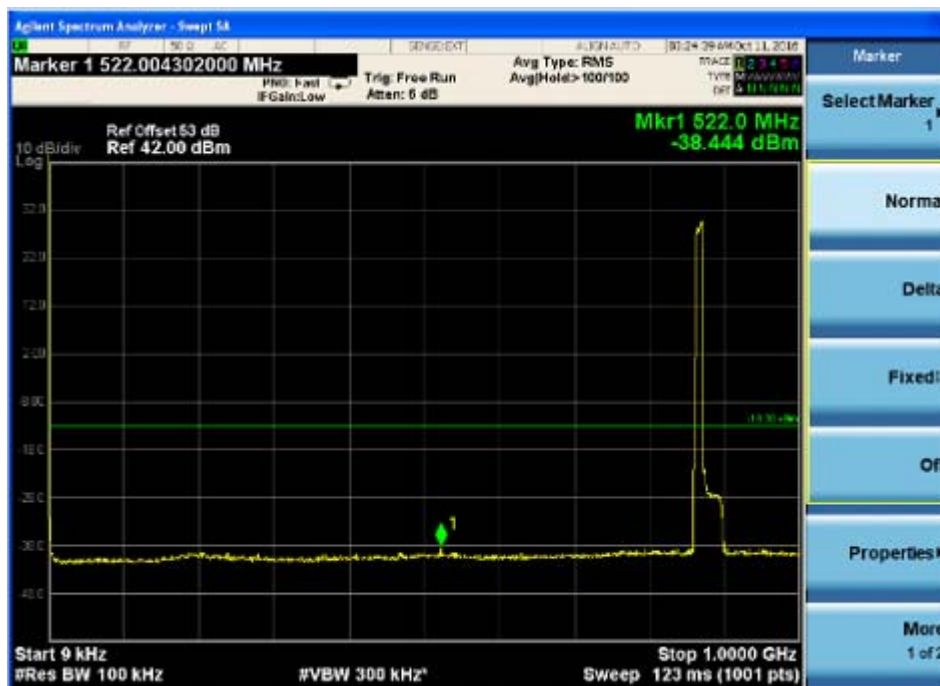

1GHz to 3.7GHz

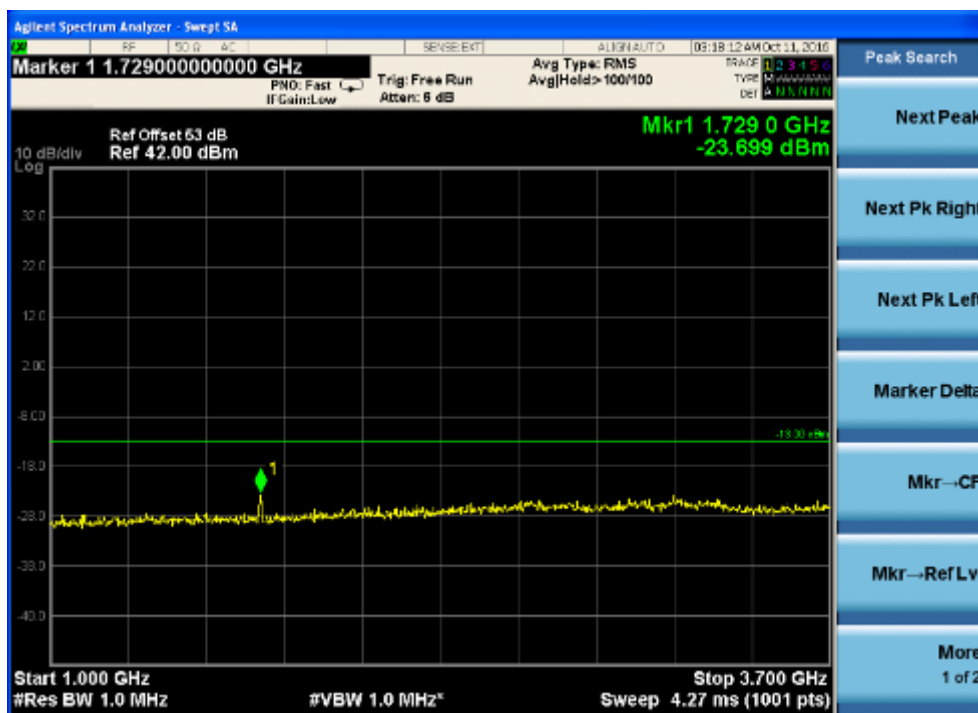



3GHz to 10GHz

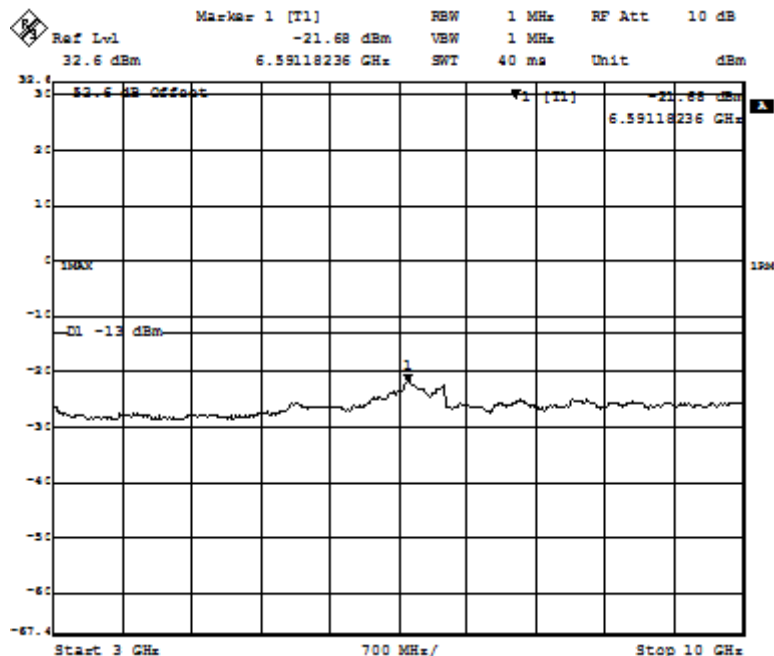

2) Middle frequency

9KHz to 1GHz

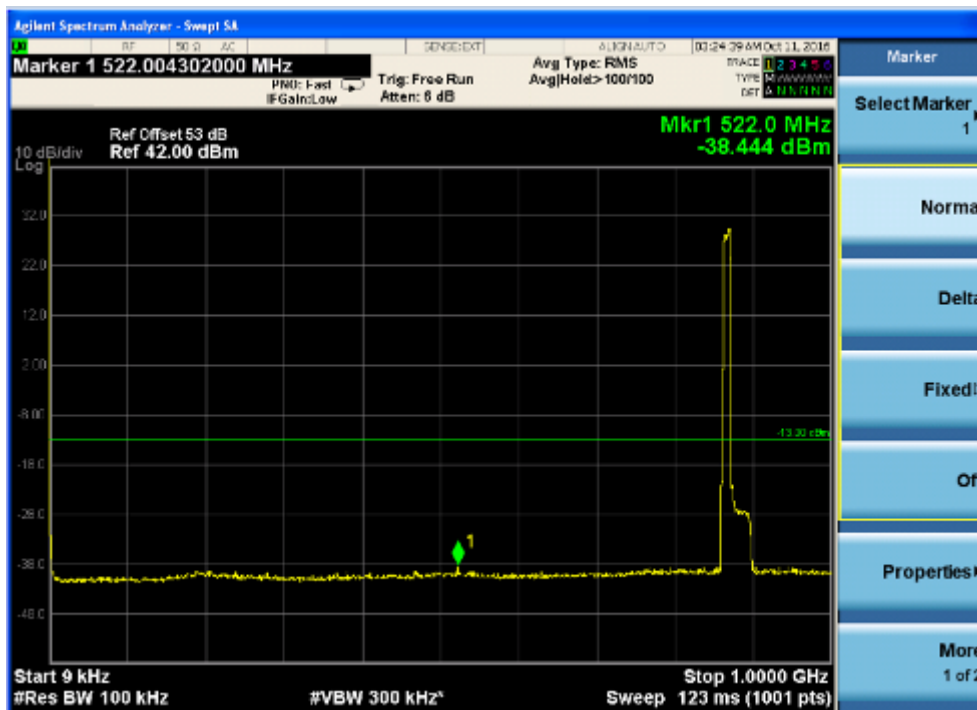



1GHz to 3.7GHz

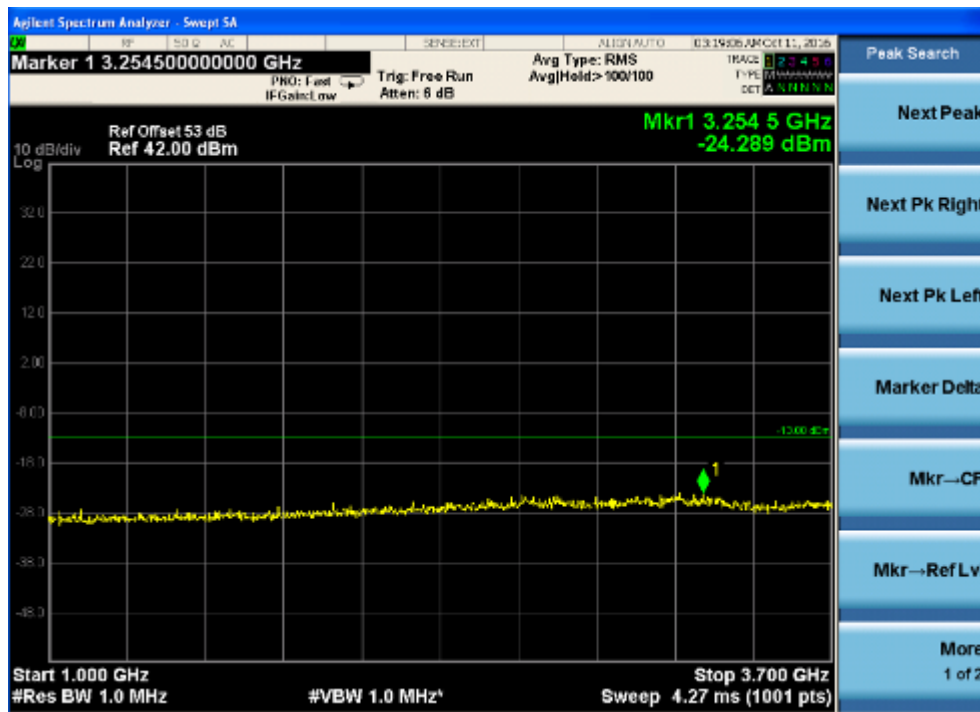

3GHz to 10GHz

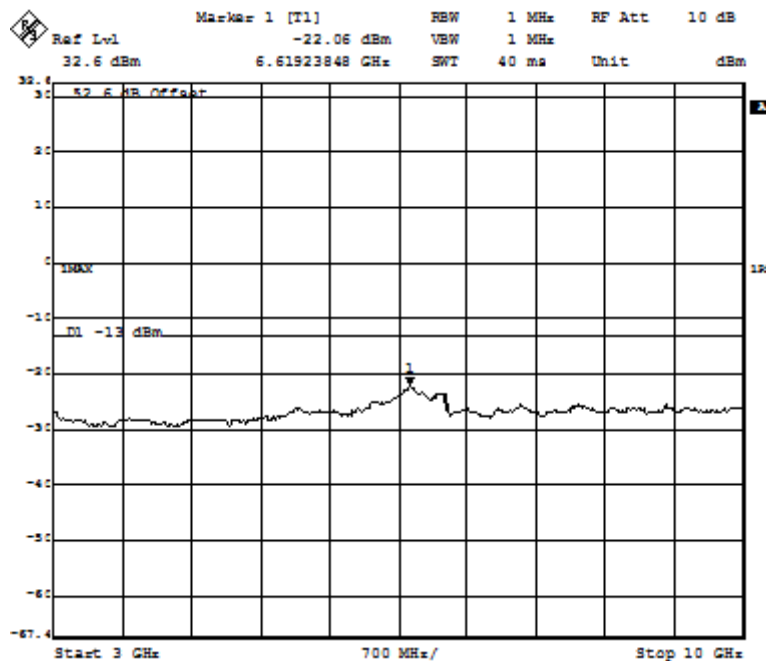



3)highest frequency

9KHz to 1GHz

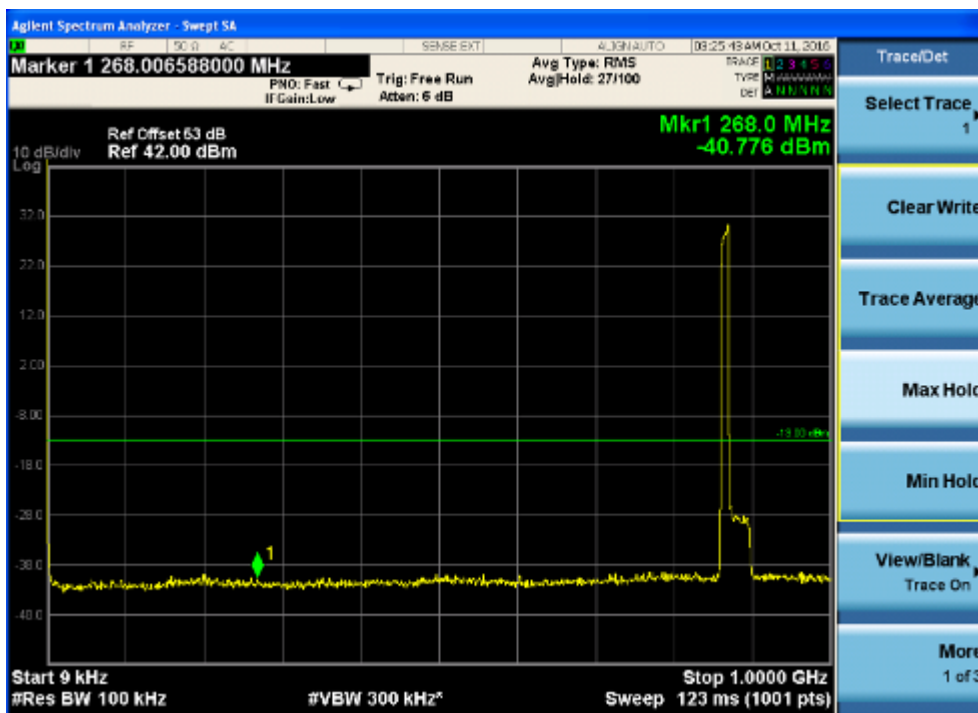

1GHz to 3.7GHz





3GHz to 10GHz

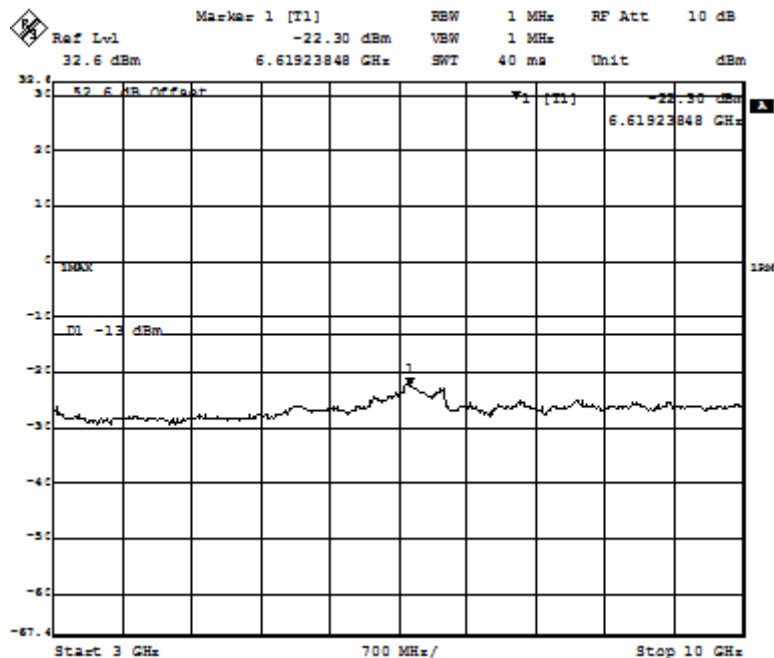



For WCDMA mode:

1)lowest frequency:

Measurement Record:				
Frequency range	Measurement bandwidth	Spurious Emission Level(dBm)	Limit(dBm)	Over Limit(dB)
9KHz to 1GHz	RBW=100KHz	-28.73	-13.0	-15.73
1GHz to 10GHz	RBW=1MHz	-18.96	-13.0	-5.96
3GHz to 10GHz	RBW=1MHz	-23.74	-13.0	-10.74

1)Middle frequency:

Measurement Record:				
Frequency range	Measurement bandwidth	Spurious Emission Level(dBm)	Limit(dBm)	Over Limit(dB)
9KHz to 1GHz	RBW=100KHz	-29.68	-13.0	-16.68
1GHz to 3.7GHz	RBW=1MHz	-19.34	-13.0	-6.34
3GHz to 10GHz	RBW=1MHz	-23.35	-13.0	-10.35

3)highest frequency

Measurement Record:				
Frequency range	Measurement bandwidth	Spurious Emission Level(dBm)	Limit(dBm)	Over Limit(dB)
9KHz to 1GHz	RBW=100KHz	-28.34	-13.0	-15.34
1GHz to 3.7GHz	RBW=1MHz	-19.63	-13.0	-6.63
3GHz to 10GHz	RBW=1MHz	-23.52	-13.0	-10.52



2) Middle frequency

9KHz to 1GHz

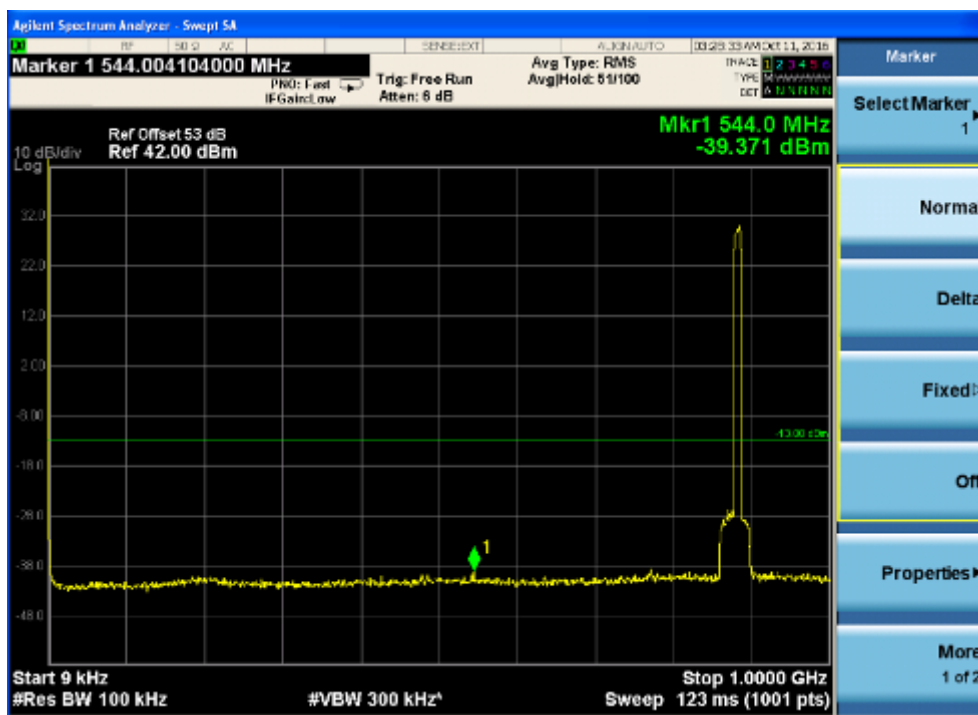

1GHz to 10GHz

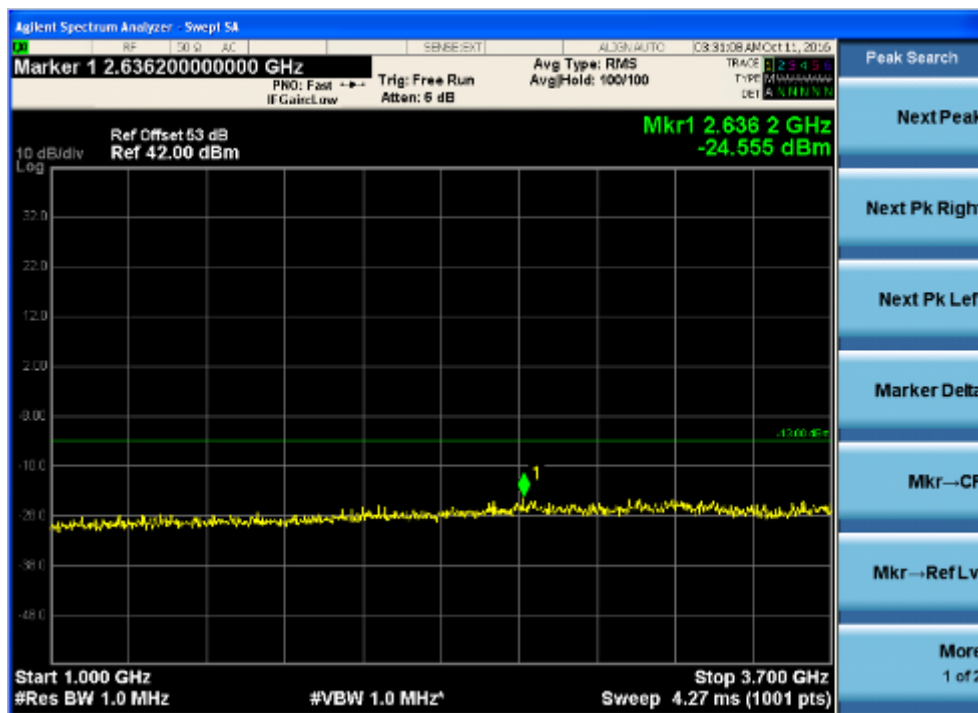

3)highest frequency

9KHz to 1GHz

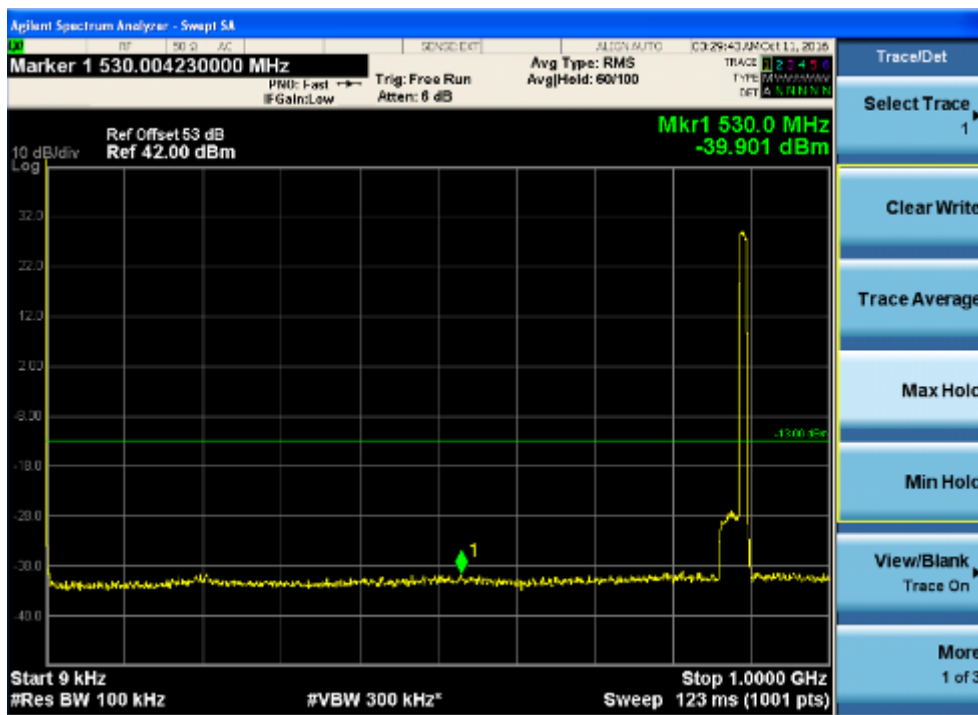

1GHz to 10GHz

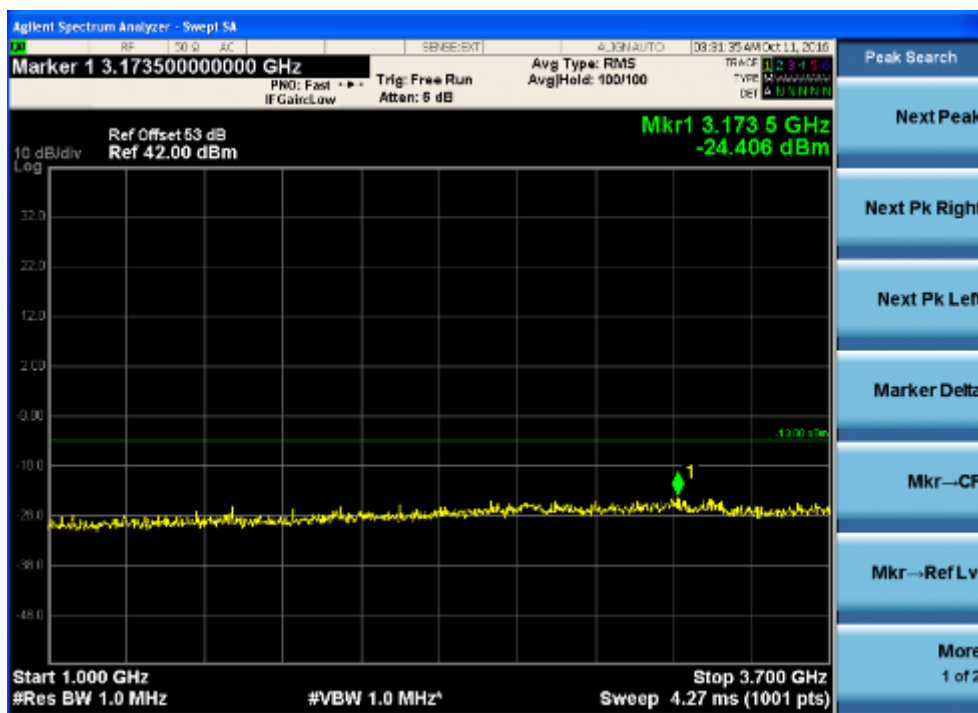



2.2 For GSM mode:

1)lowest frequency:

Measurement Record:				
Frequency range	Measurement bandwidth	Spurious Emission Level(dBm)	Limit(dBm)	Over Limit(dB)
9KHz to 1GHz	RBW=100KHz	-39.98	-13.0	-26.98
1GHz to 10GHz	RBW=1MHz	-26.21	-13.0	-13.21

2)Middle frequency:

Measurement Record:				
Frequency range	Measurement bandwidth	Spurious Emission Level(dBm)	Limit(dBm)	Over Limit(dB)
9KHz to 1GHz	RBW=100KHz	-39.96	-13.0	-26.96
1GHz to 10GHz	RBW=1MHz	-26.34	-13.0	-13.34

3)highest frequency

Measurement Record:				
Frequency range	Measurement bandwidth	Spurious Emission Level(dBm)	Limit(dBm)	Over Limit(dB)
9KHz to 1GHz	RBW=100KHz	-40.01	-13.0	-27.01
1GHz to 10GHz	RBW=1MHz	-26.32	-13.0	-13.32



2.3 For CDMA mode:

1)lowest frequency:

Measurement Record:				
Frequency range	Measurement bandwidth	Spurious Emission Level(dBm)	Limit(dBm)	Over Limit(dB)
9KHz to 1GHz	RBW=100KHz	-39.97	-13.0	-26.97
1GHz to 10GHz	RBW=1MHz	-26.13	-13.0	-13.13

2)Middle frequency:

Measurement Record:				
Frequency range	Measurement bandwidth	Spurious Emission Level(dBm)	Limit(dBm)	Over Limit(dB)
9KHz to 1GHz	RBW=100KHz	-40.12	-13.0	-27.12
1GHz to 10GHz	RBW=1MHz	-26.04	-13.0	-13.04

3)highest frequency

Measurement Record:				
Frequency range	Measurement bandwidth	Spurious Emission Level(dBm)	Limit(dBm)	Over Limit(dB)
9KHz to 1GHz	RBW=100KHz	-39.99	-13.0	-26.99
1GHz to 10GHz	RBW=1MHz	-26.17	-13.0	-13.17



2.4 For WCDMA mode:

1)lowest frequency:

Measurement Record:				
Frequency range	Measurement bandwidth	Spurious Emission Level(dBm)	Limit(dBm)	Over Limit(dB)
9KHz to 1GHz	RBW=100KHz	-40.15	-13.0	-27.15
1GHz to 10GHz	RBW=1MHz	-25.69	-13.0	-12.69

2)Middle frequency:

Measurement Record:				
Frequency range	Measurement bandwidth	Spurious Emission Level(dBm)	Limit(dBm)	Over Limit(dB)
9KHz to 1GHz	RBW=100KHz	-39.97	-13.0	-26.97
1GHz to 10GHz	RBW=1MHz	-26.31	-13.0	-13.31

3)highest frequency

Measurement Record:				
Frequency range	Measurement bandwidth	Spurious Emission Level(dBm)	Limit(dBm)	Over Limit(dB)
9KHz to 1GHz	RBW=100KHz	-40.25	-13.0	-27.25
1GHz to 10GHz	RBW=1MHz	-26.47	-13.0	-13.47



4. Downlink: 1930MHz ~ 1995MHz

Remark:

The data of the GSM mode, CDMA mode and WCDMA mode is almost the same with LTE mode, so we only show the photo in the LTE mode, others record the data.

2.1 For LTE mode:

1) lowest frequency

9KHz to 1GHz

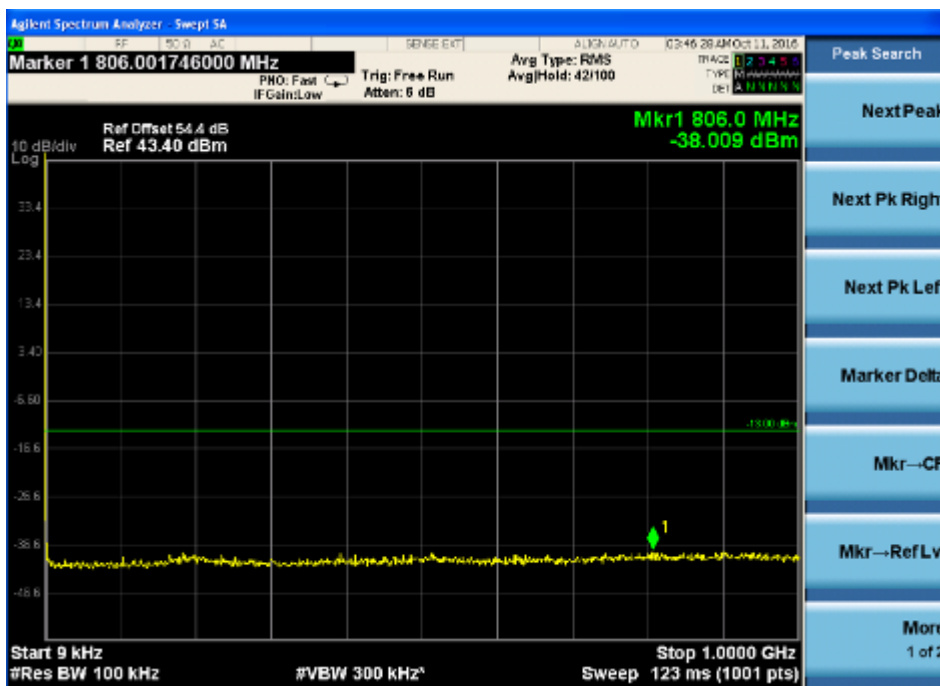

1GHz to 20GHz

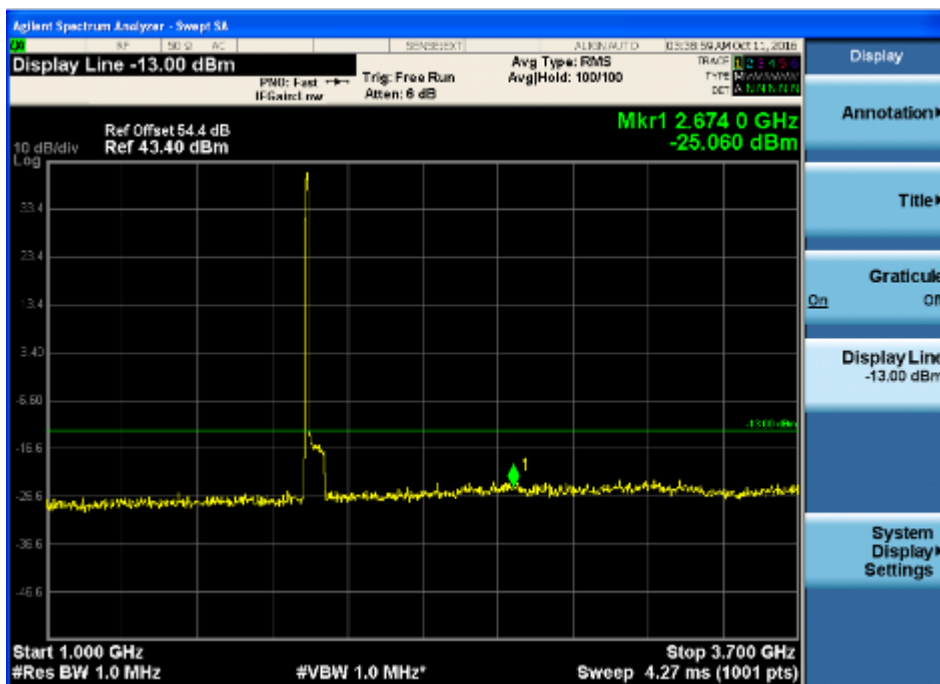



2) Middle frequency

9KHz to 1GHz

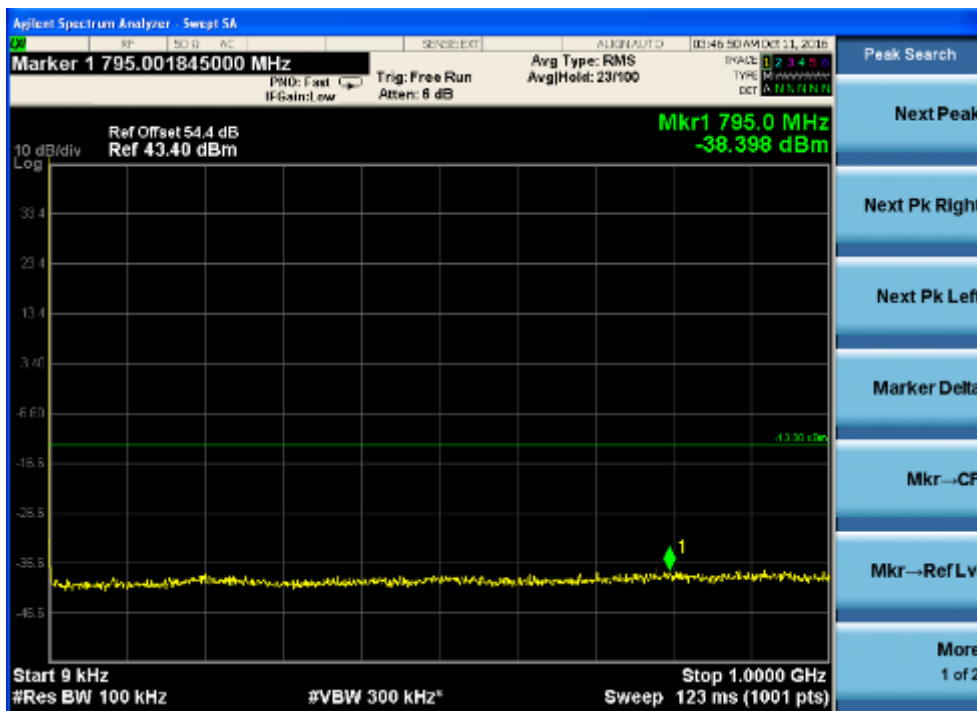

1GHz to 20GHz

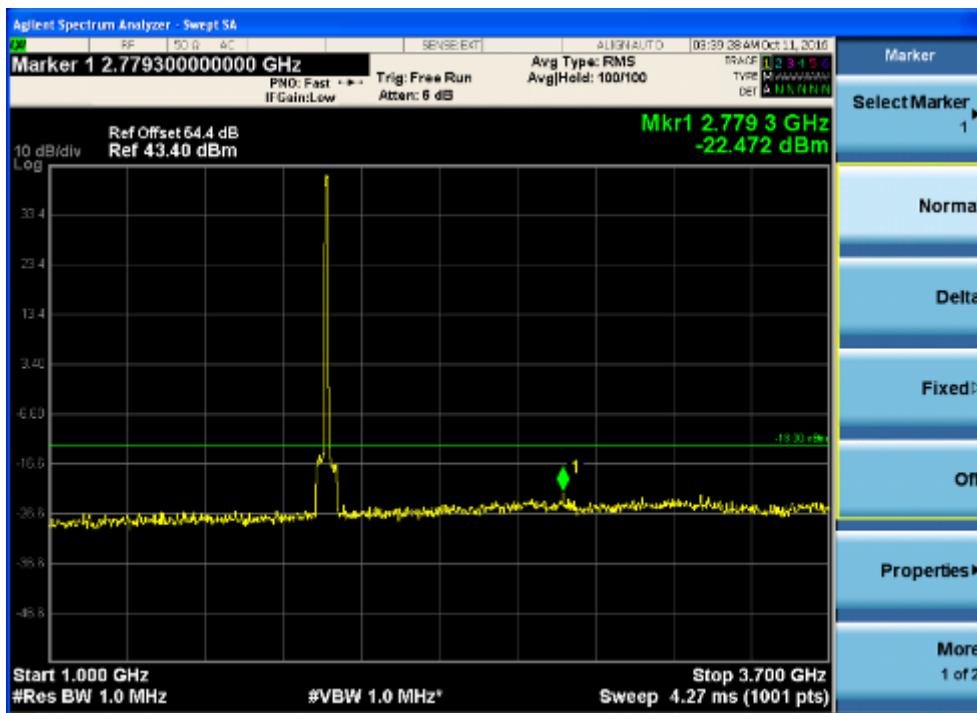



3)highest frequency

9KHz to 1GHz

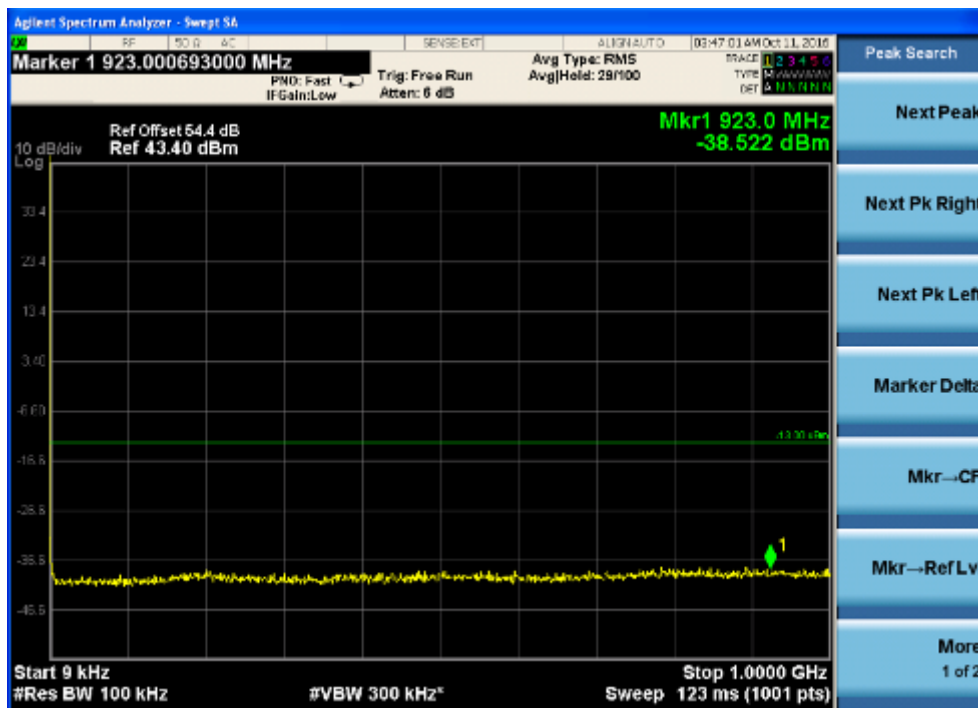

1GHz to 20GHz

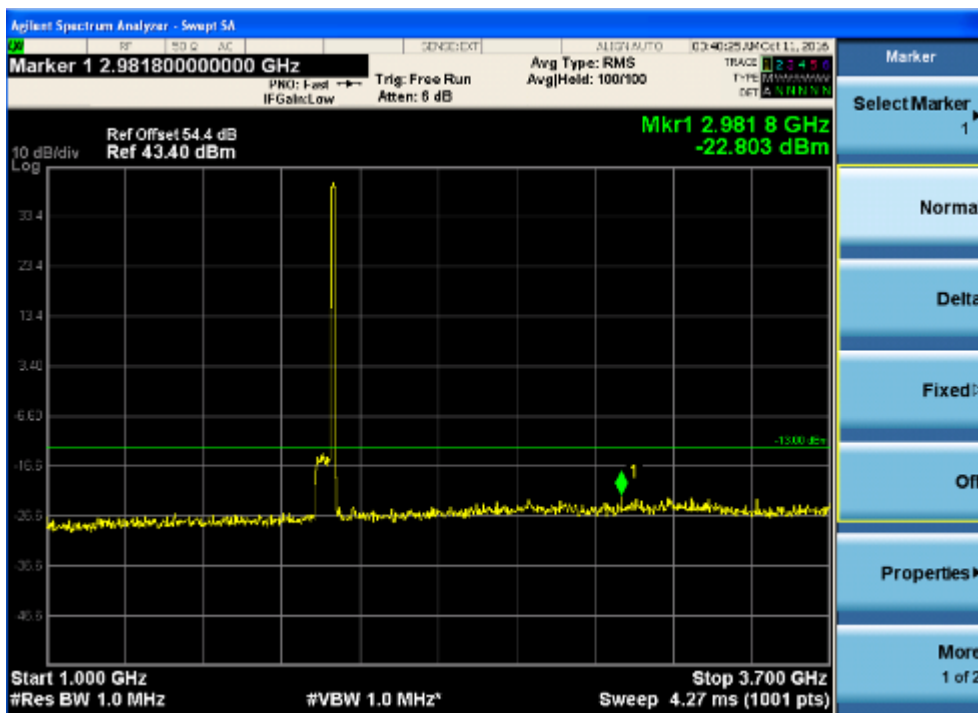



2.2 For GSM mode:

1)lowest frequency:

Measurement Record:				
Frequency range	Measurement bandwidth	Spurious Emission Level(dBm)	Limit(dBm)	Over Limit(dB)
9KHz to 1GHz	RBW=100KHz	-46.12	-13.0	-33.12
1GHz to 20GHz	RBW=1MHz	-35.32	-13.0	-22.32

2)Middle frequency:

Measurement Record:				
Frequency range	Measurement bandwidth	Spurious Emission Level(dBm)	Limit(dBm)	Over Limit(dB)
9KHz to 1GHz	RBW=100KHz	-46.34	-13.0	-33.34
1GHz to 20GHz	RBW=1MHz	-36.79	-13.0	-23.79

3)highest frequency

Measurement Record:				
Frequency range	Measurement bandwidth	Spurious Emission Level(dBm)	Limit(dBm)	Over Limit(dB)
9KHz to 1GHz	RBW=100KHz	-46.48	-13.0	-33.48
1GHz to 20GHz	RBW=1MHz	-35.98	-13.0	-22.98



2.3 For CDMA mode:

1)lowest frequency:

Measurement Record:				
Frequency range	Measurement bandwidth	Spurious Emission Level(dBm)	Limit(dBm)	Over Limit(dB)
9KHz to 1GHz	RBW=100KHz	-46.94	-13.0	-33.94
1GHz to 20GHz	RBW=1MHz	-35.62	-13.0	-22.62

2)Middle frequency:

Measurement Record:				
Frequency range	Measurement bandwidth	Spurious Emission Level(dBm)	Limit(dBm)	Over Limit(dB)
9KHz to 1GHz	RBW=100KHz	-46.48	-13.0	-33.48
1GHz to 20GHz	RBW=1MHz	-35.24	-13.0	-22.24

3)highest frequency

Measurement Record:				
Frequency range	Measurement bandwidth	Spurious Emission Level(dBm)	Limit(dBm)	Over Limit(dB)
9KHz to 1GHz	RBW=100KHz	-46.76	-13.0	-33.76
1GHz to 20GHz	RBW=1MHz	-36.15	-13.0	-23.15



2.4 For WCDMA mode:

1)lowest frequency:

Measurement Record:				
Frequency range	Measurement bandwidth	Spurious Emission Level(dBm)	Limit(dBm)	Over Limit(dB)
9KHz to 1GHz	RBW=100KHz	-46.47	-13.0	-33.47
1GHz to 20GHz	RBW=1MHz	-35.64	-13.0	-22.64

2)Middle frequency:

Measurement Record:				
Frequency range	Measurement bandwidth	Spurious Emission Level(dBm)	Limit(dBm)	Over Limit(dB)
9KHz to 1GHz	RBW=100KHz	-46.98	-13.0	-33.98
1GHz to 20GHz	RBW=1MHz	-36.21	-13.0	-23.21

3)highest frequency

Measurement Record:				
Frequency range	Measurement bandwidth	Spurious Emission Level(dBm)	Limit(dBm)	Over Limit(dB)
9KHz to 1GHz	RBW=100KHz	-46.89	-13.0	-33.89
1GHz to 20GHz	RBW=1MHz	-36.79	-13.0	-23.79



3.2 For GSM mode:

1)lowest frequency:

Measurement Record:				
Frequency range	Measurement bandwidth	Spurious Emission Level(dBm)	Limit(dBm)	Over Limit(dB)
9KHz to 1GHz	RBW=100KHz	-46.12	-13.0	-33.12
1GHz to 20GHz	RBW=1MHz	-35.32	-13.0	-22.32

2)Middle frequency:

Measurement Record:				
Frequency range	Measurement bandwidth	Spurious Emission Level(dBm)	Limit(dBm)	Over Limit(dB)
9KHz to 1GHz	RBW=100KHz	-46.34	-13.0	-33.34
1GHz to 20GHz	RBW=1MHz	-36.79	-13.0	-23.79

3)highest frequency

Measurement Record:				
Frequency range	Measurement bandwidth	Spurious Emission Level(dBm)	Limit(dBm)	Over Limit(dB)
9KHz to 1GHz	RBW=100KHz	-46.48	-13.0	-33.48
1GHz to 20GHz	RBW=1MHz	-35.98	-13.0	-22.98



3.3 For CDMA mode:

1)lowest frequency:

Measurement Record:				
Frequency range	Measurement bandwidth	Spurious Emission Level(dBm)	Limit(dBm)	Over Limit(dB)
9KHz to 1GHz	RBW=100KHz	-46.94	-13.0	-33.94
1GHz to 20GHz	RBW=1MHz	-35.62	-13.0	-22.62

2)Middle frequency:

Measurement Record:				
Frequency range	Measurement bandwidth	Spurious Emission Level(dBm)	Limit(dBm)	Over Limit(dB)
9KHz to 1GHz	RBW=100KHz	-46.48	-13.0	-33.48
1GHz to 20GHz	RBW=1MHz	-35.24	-13.0	-22.24

3)highest frequency

Measurement Record:				
Frequency range	Measurement bandwidth	Spurious Emission Level(dBm)	Limit(dBm)	Over Limit(dB)
9KHz to 1GHz	RBW=100KHz	-46.76	-13.0	-33.76
1GHz to 20GHz	RBW=1MHz	-36.15	-13.0	-23.15



3.4 For WCDMA mode:

1)lowest frequency:

Measurement Record:				
Frequency range	Measurement bandwidth	Spurious Emission Level(dBm)	Limit(dBm)	Over Limit(dB)
9KHz to 1GHz	RBW=100KHz	-46.47	-13.0	-33.47
1GHz to 20GHz	RBW=1MHz	-35.64	-13.0	-22.64

2)Middle frequency:

Measurement Record:				
Frequency range	Measurement bandwidth	Spurious Emission Level(dBm)	Limit(dBm)	Over Limit(dB)
9KHz to 1GHz	RBW=100KHz	-46.98	-13.0	-33.98
1GHz to 20GHz	RBW=1MHz	-36.21	-13.0	-23.21

3)highest frequency

Measurement Record:				
Frequency range	Measurement bandwidth	Spurious Emission Level(dBm)	Limit(dBm)	Over Limit(dB)
9KHz to 1GHz	RBW=100KHz	-46.89	-13.0	-33.89
1GHz to 20GHz	RBW=1MHz	-36.79	-13.0	-23.79



4. Downlink: 2110MHz ~ 2180MHz

4.1 For LTE mode:

1) lowest frequency

9KHz to 1GHz

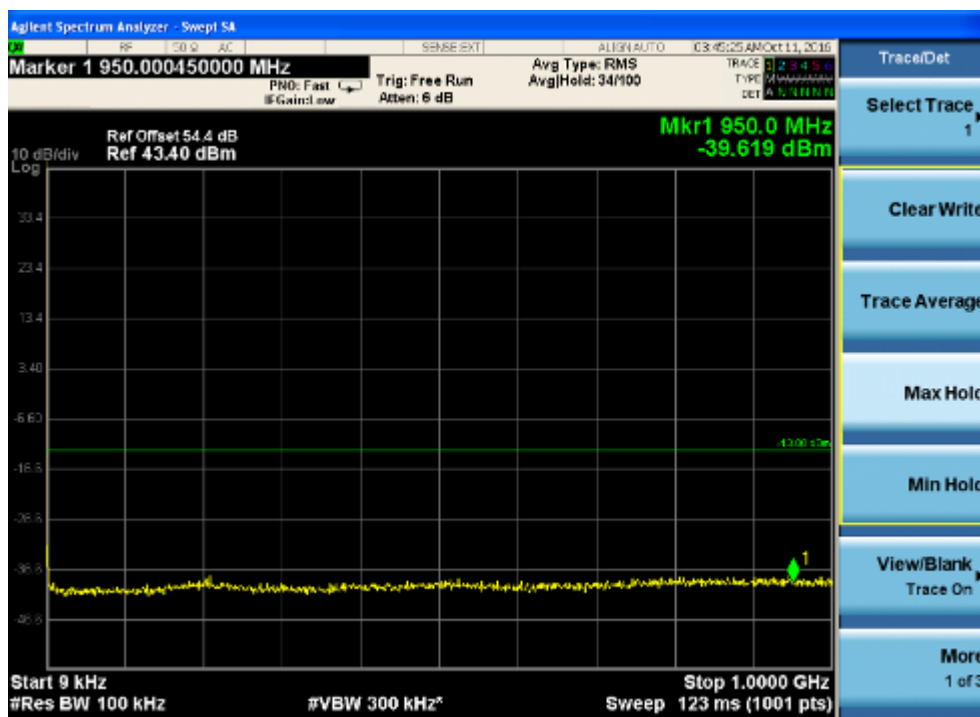

1GHz to 22GHz

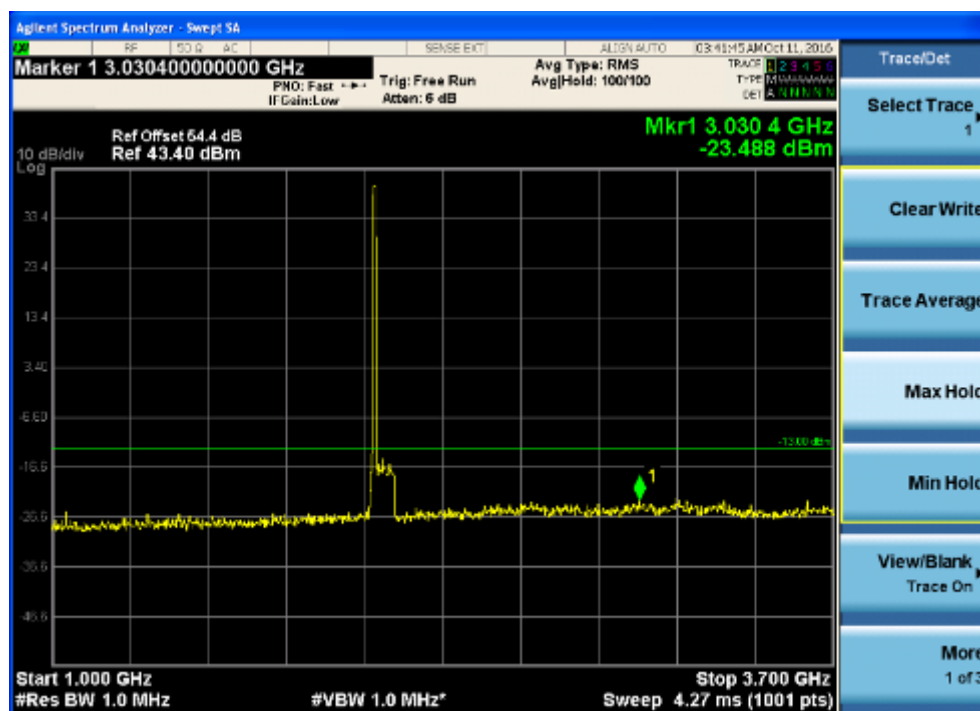



2) Middle frequency

9KHz to 1GHz

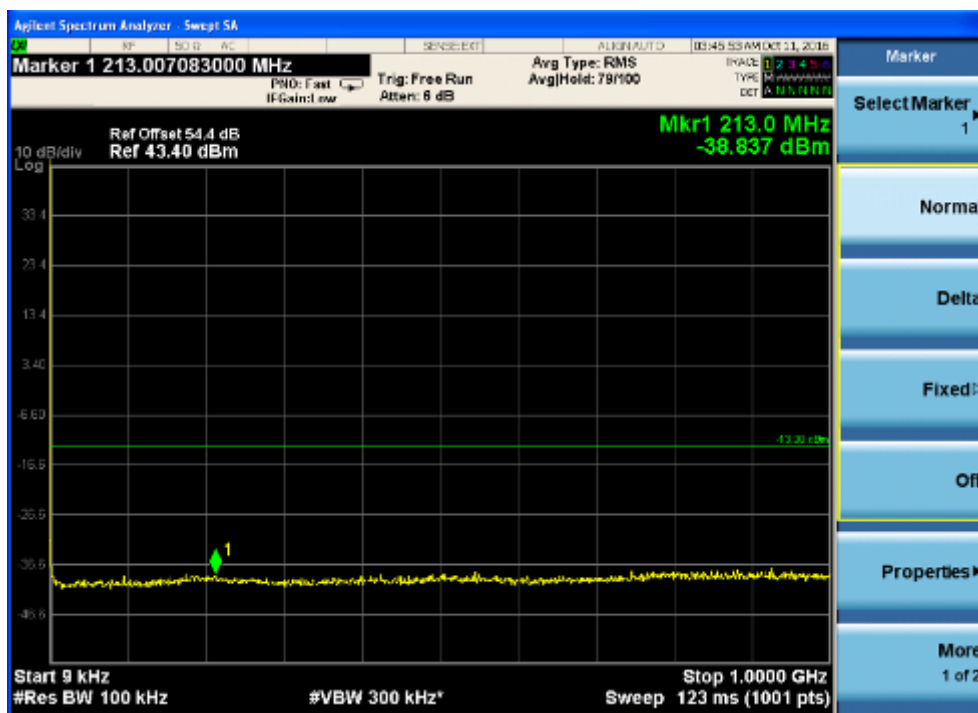

1GHz to 22GHz

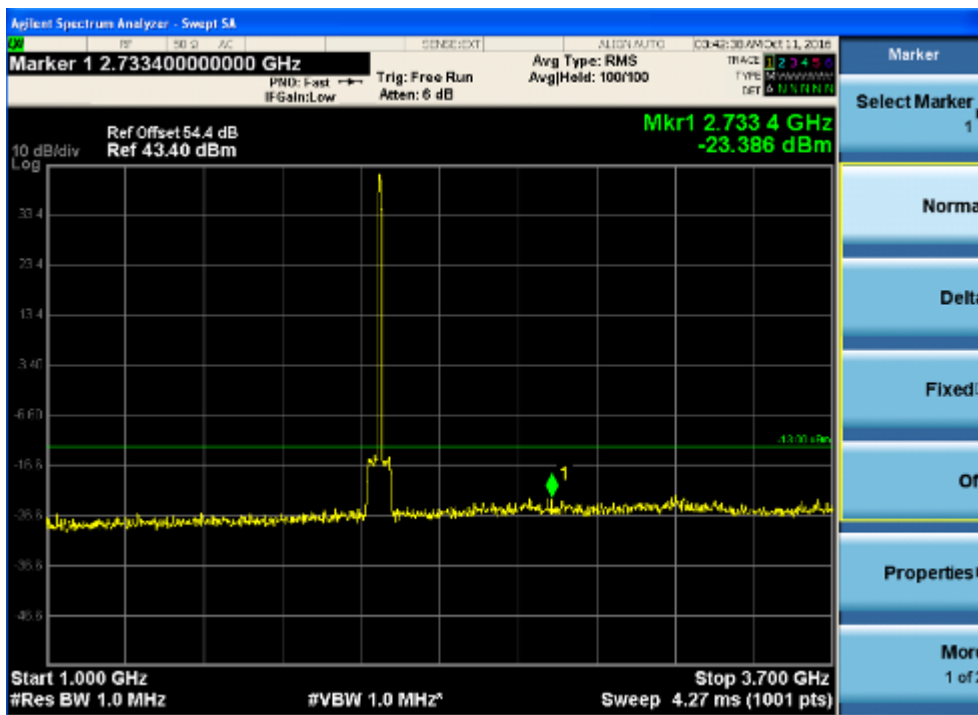



3)highest frequency

9KHz to 1GHz

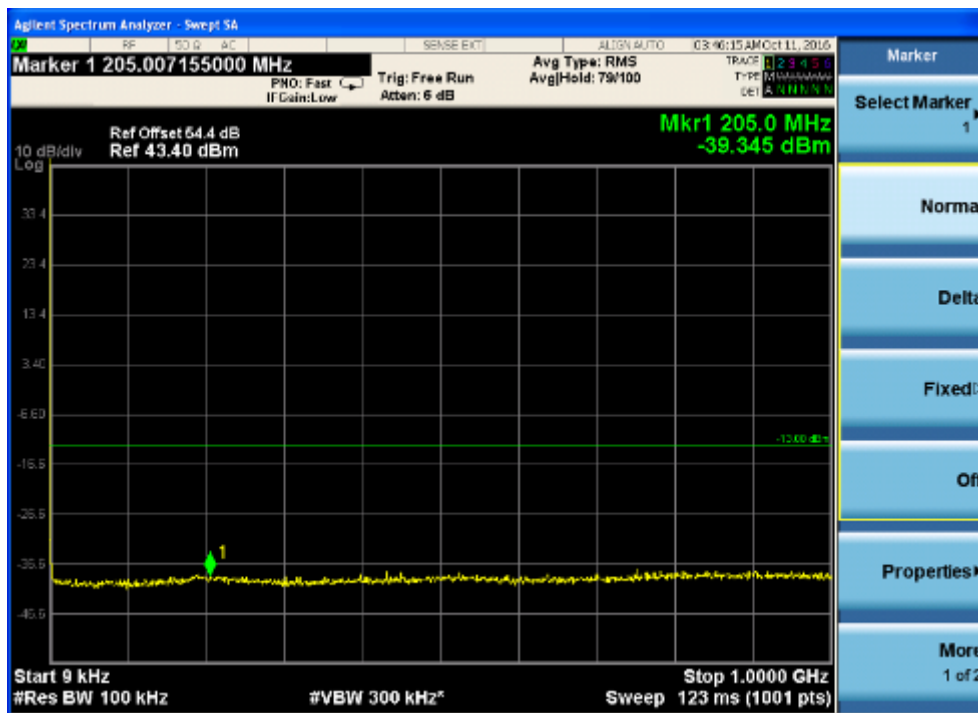

1GHz to 22GHz

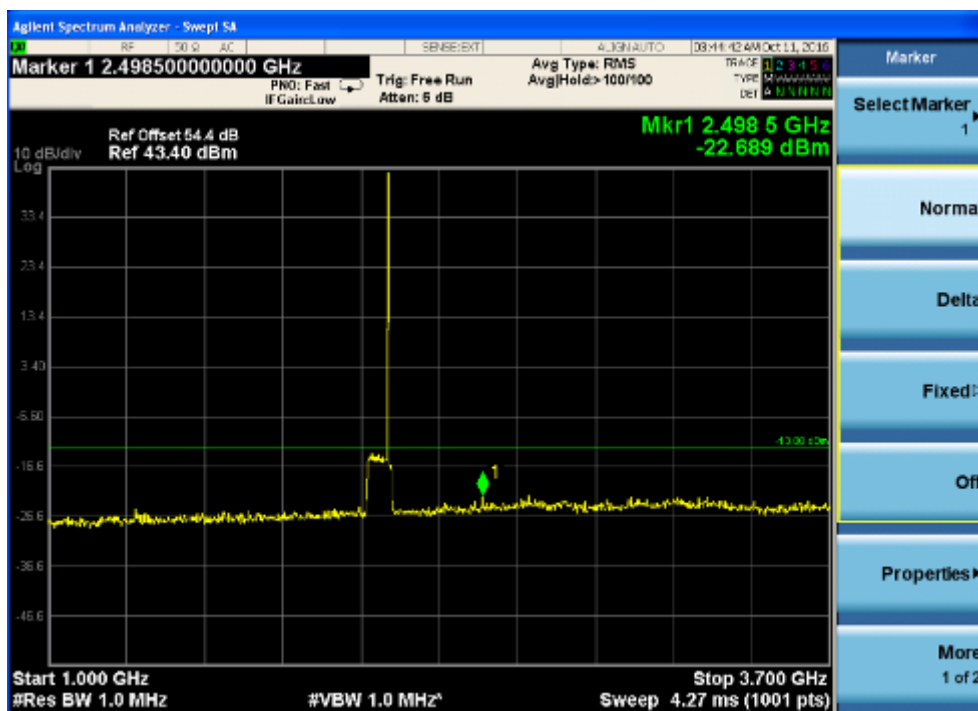



4.2 For CDMA mode:

1)lowest frequency:

Measurement Record:				
Frequency range	Measurement bandwidth	Spurious Emission Level(dBm)	Limit(dBm)	Over Limit(dB)
9KHz to 1GHz	RBW=100KHz	-45.76	-13.0	-32.76
1GHz to 22GHz	RBW=1MHz	-33.45	-13.0	-20.45

2)Middle frequency:

Measurement Record:				
Frequency range	Measurement bandwidth	Spurious Emission Level(dBm)	Limit(dBm)	Over Limit(dB)
9KHz to 1GHz	RBW=100KHz	-46.29	-13.0	-33.29
1GHz to 22GHz	RBW=1MHz	-34.21	-13.0	-21.21

3)highest frequency

Measurement Record:				
Frequency range	Measurement bandwidth	Spurious Emission Level(dBm)	Limit(dBm)	Over Limit(dB)
9KHz to 1GHz	RBW=100KHz	-46.93	-13.0	-33.93
1GHz to 22GHz	RBW=1MHz	-34.18	-13.0	-21.18



4.3 For WCDMA mode:

1)lowest frequency:

Measurement Record:				
Frequency range	Measurement bandwidth	Spurious Emission Level(dBm)	Limit(dBm)	Over Limit(dB)
9KHz to 1GHz	RBW=100KHz	-45.96	-13.0	-32.96
1GHz to 22GHz	RBW=1MHz	-34.52	-13.0	-21.52

2)Middle frequency:

Measurement Record:				
Frequency range	Measurement bandwidth	Spurious Emission Level(dBm)	Limit(dBm)	Over Limit(dB)
9KHz to 1GHz	RBW=100KHz	-46.75	-13.0	-33.75
1GHz to 22GHz	RBW=1MHz	-35.21	-13.0	-22.21

3)highest frequency

Measurement Record:				
Frequency range	Measurement bandwidth	Spurious Emission Level(dBm)	Limit(dBm)	Over Limit(dB)
9KHz to 1GHz	RBW=100KHz	-46.35	-13.0	-33.35
1GHz to 22GHz	RBW=1MHz	-36.34	-13.0	-23.34



7.2.3 Band Edge & Intermodulation

Test Date: 2016-10-09

Test Requirement: FCC part 90.210 & FCC part 22.917(b) & FCC part 24.238(b) & FCC part 27.53(h)

90.210, table "Application Emission Mask"

Frequency Band(MHz)	Mask for equipment with Audio Low pass filter	Mask for equipment without Audio Low pass filter
806-809/851-854	B	H
809-824/854-869 ³	B	G

(g) Emission Mask G. For transmitters that are not equipped with an audio low-pass filter, the power of an emission must be attenuated below the unmodulated carrier power (P) as follows:

(2) On any frequency removed from the center of the authorized bandwidth by more than 250 percent of the authorized bandwidth: At least 43 + 10 log (P) dB.

22.917(b) Measurement procedure. Compliance with these rules is based on the use of measurement instrumentation employing a resolution bandwidth of 100 kHz or greater. In the 1 MHz bands immediately outside and adjacent to the frequency block a resolution bandwidth of at least one percent of the emission bandwidth of the fundamental emission of the transmitter may be employed. A narrower resolution bandwidth is permitted in all cases to improve measurement accuracy provided the measured power is integrated over the full required measurement bandwidth (i.e. 100 kHz or 1 percent of emission bandwidth, as specified). The emission bandwidth is defined as the width of the signal between two points, one below the carrier center frequency and one above the carrier center frequency, outside of which all emissions are attenuated at least 26 dB below the transmitter power.

24.238(b) Measurement procedure. Compliance with these rules is based on the use of measurement instrumentation employing a resolution bandwidth of 1 MHz or greater. However, in the 1 MHz bands immediately outside and adjacent to the frequency block a resolution bandwidth of at least one percent of the emission bandwidth of the fundamental emission of the transmitter may be employed. A narrower resolution bandwidth is permitted in all cases to improve measurement accuracy provided the measured power is integrated over the full required measurement bandwidth (i.e. 1 MHz or 1 percent of emission bandwidth, as specified). The emission bandwidth is defined as the width of the signal between two points, one below the carrier center frequency and one above the carrier center frequency, outside of which all emissions are attenuated at least 26 dB below the transmitter power.

27.53(h) Compliance with this provision is based on the use of measurement instrumentation employing a resolution bandwidth of 1 megahertz or greater. However, in the 1 megahertz bands immediately outside and adjacent to the licensee's frequency block, a resolution bandwidth of at least one percent of the emission bandwidth of the fundamental emission of the transmitter may be employed. The emission bandwidth is defined as the width of the signal between two points, one below the carrier center frequency and one above the carrier center frequency, outside of which all emissions are attenuated at least 26 dB below the transmitter power.

Test Method: FCC part 2.1051&2-11-04/EAB/RF
 EUT Operation:
 Status: Drive the EUT to maximum output power.
 Conditions: Normal conditions
 Application: Cellular Band RF output ports
 Test Configuration:

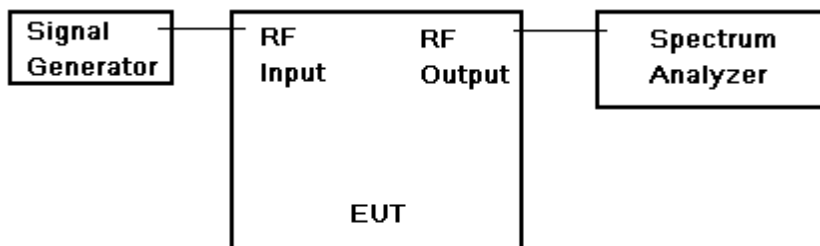
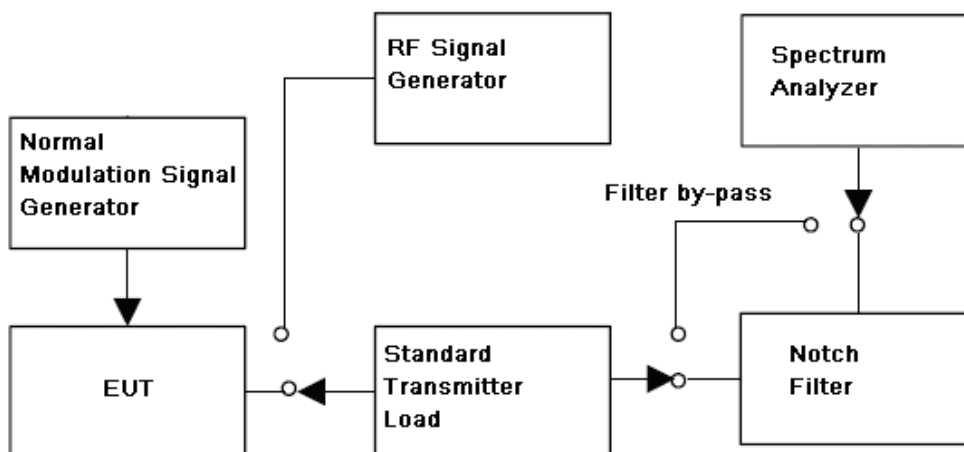

Fig.3. Band edge and Intermodulation test configuration





- Test Procedure: Conducted Emissions test procedure:
- a) Connect the equipment as illustrated, with the notch filter by-passed, when the output power is over the max value of the Spectrum Analyzer, add the attenuator to avoid destroying the facility.
 - b) Set the center frequency of the spectrum analyzer to the assigned transmitter frequency, key the transmitter, and set the level of the carrier to the full scale reference line.
 - c) do not apply any tone to modulate the EUT.
 - d) Adjust the spectrum analyzer for the following settings:
 - 1) Resolution Bandwidth,(base the standard, apply the different set),here is 100KHz for frequency band less than 1GHz, 1MHz for frequency over 1GHz;
 - 2) Video Bandwidth refer to standard requirement.
 - e) Adjust the center frequency of the spectrum analyzer for incremental coverage of the range from:
 - 1) the lowest radio frequency generated in the equipment, it can be 9KHz base the test method, here select 30MHz as lowest frequency start point;
 - 2) the highest radion frequency shall higher than 10 times of carrier frequency;
 - f) Record the frequencies and levels of spurious emissions from step e)

Remark:

The notch filter is used for avoid the EUT fundamental carrier output power making the spectrum overload and the harmonic spurious brought by it.

When the EUT fundamental carrier is not enough to make the status, the notch filter could be not used.

- Intermodulation Test Procedure:
- 1. Connect the equipment as illustrated;
 - 2. Test the background noise level with all the test facilities;
 - 3. Keep one transmitting path, all other connectors shall be connected by normal power or RF leads;
 - 4. Select the attenuator to avoid the test receiver or spectrum analyzer being destroyed;
 - 5. Keep the EUT continuously transmitting in max power;
 - 6. Keep two signals are same in modulation type and level;
 - 7. Measure the 3 order intermodulated product by the EUT(the sum of the two unwanted signal should be rated power);
 - 8. Correct for all losses in the RF path;
 - 9. Read the conducted spurious emissioins of the EUT antenna port.

Remark:

CW signal rather than typical signal is acceptable (for FM).

- At maximum drive level, for each modulation: one test with three tones, or two tests (high-, low-band edge) with two tones
- Limit usually is -13dBm conducted.
- Not needed for Single Channel systems.

7.2.3.1 Measurement Record:

Downlink: 728MHz to 757MHz(LTE Mode)

1.1 one signal input —Lower Edge

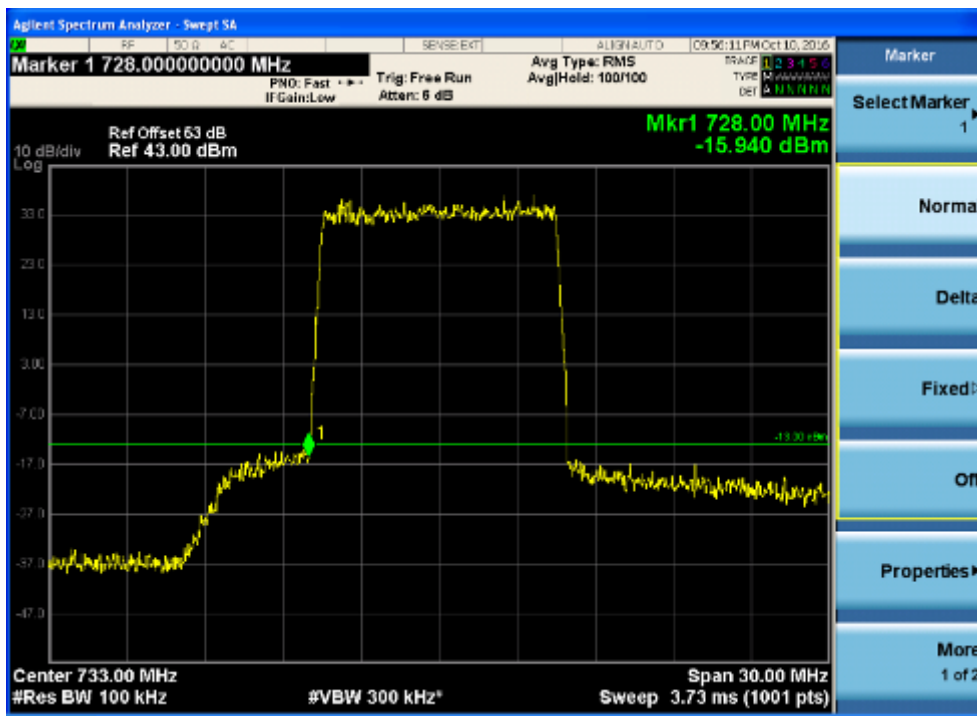

1.2 one signal input —Upper Edge

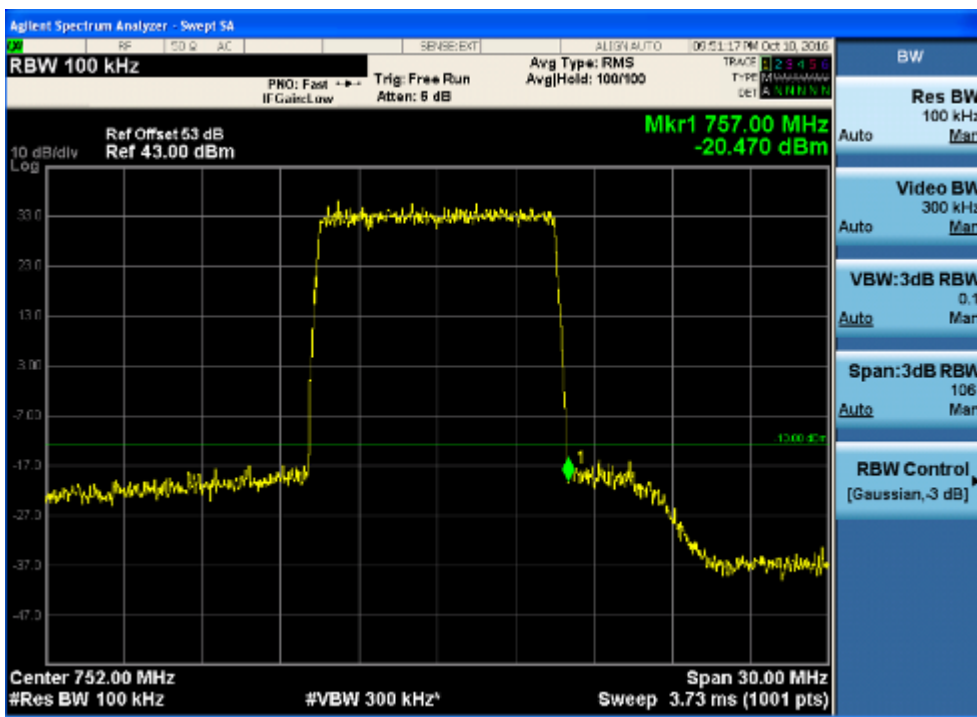



1.3 two signal input —Lower Edge

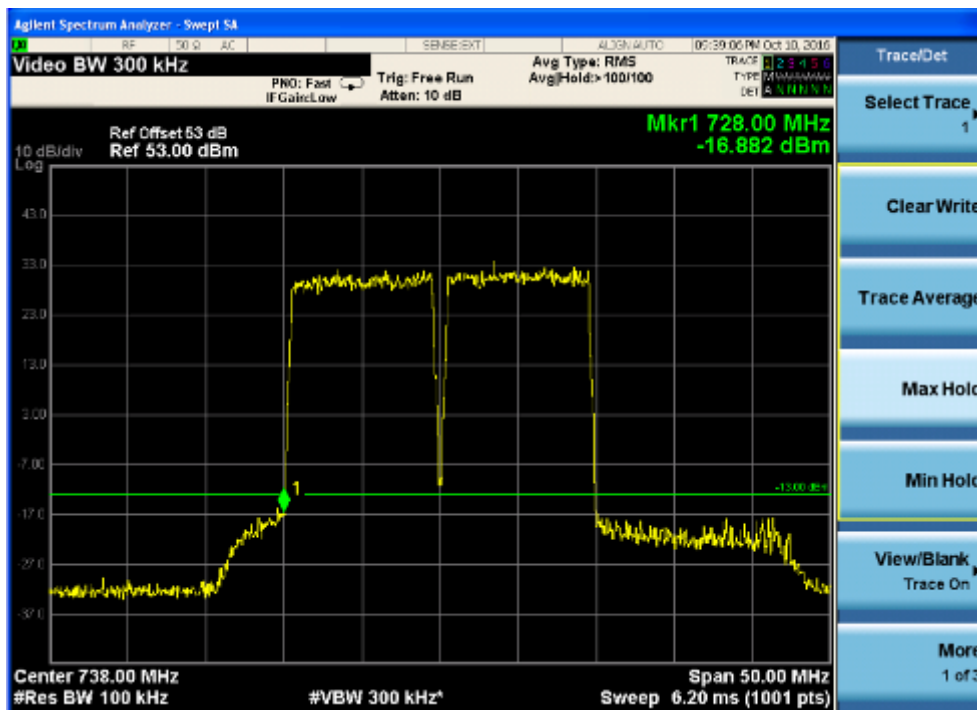

1.4 two signal input —Upper Edge

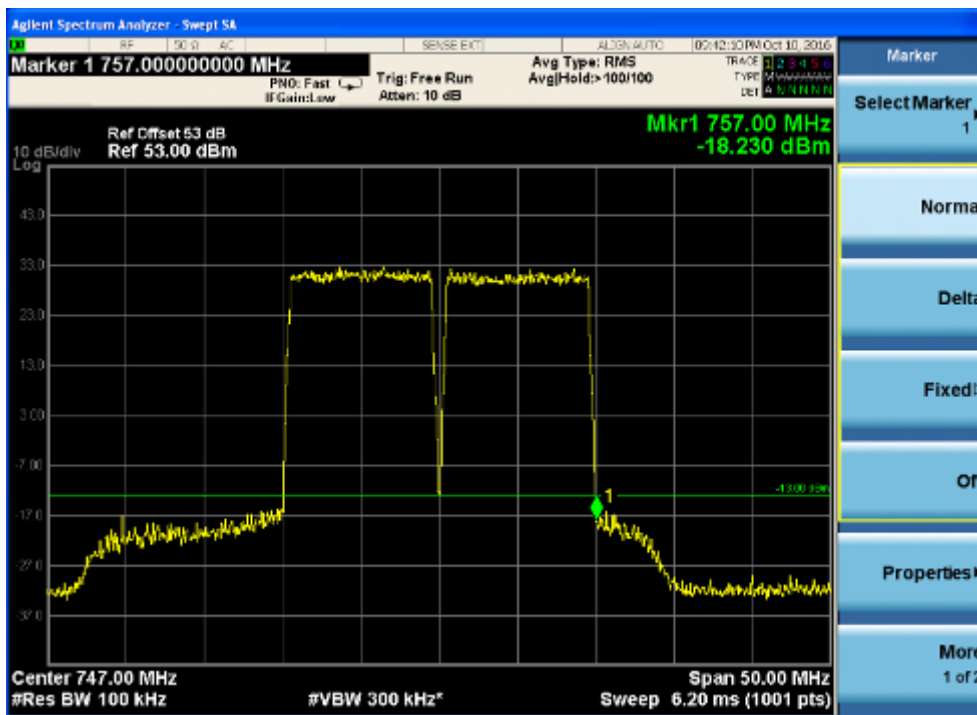



1.5 intermodulation spurious emissions

1.5.1 Input frequency:

1)in lower edge test:f1 is the lower edge frequency +1 channel frequency, and f2 is +2 channel frequency

f1=733MHz,f2=738MHz

2)in higher edge test:f1 is the higher edge frequency -2 channel frequency, and f2 is -1 channel frequency

f1=747MHz,f2=752MHz

base the 3rd product frequency F1= 2f1-f2 and F2=2f2-f1, when the f1 and f2 frequency select above,

- a) in lower edge test, F1=2f1-(f1+Δf)=f1-Δf=lower edge frequency;
b) in higher edge test, F2=2f2-(f2-Δf)=f2+Δf=higher edge frequency.

F1=728MHz,F2=757MHz

base the 5th product frequency F1= 3f1-2f2 and F2=3f2-2f1, when the f1 and f2 frequency select above,

- a) in lower edge test, F1=3f1-2(f1+Δf)=f1-2Δf=lower edge frequency;
b) in higher edge test, F2=3f2-2(f2-Δf)=f2+2Δf=higher edge frequency.

F1=723MHz,F2=762MHz

base the 7th product frequency F1= 4f1-3f2 and F2=4f2-3f1, when the f1 and f2 frequency select above,

- a) in lower edge test, F1=4f1-3(f1+Δf)=f1-3Δf=lower edge frequency;
b) in higher edge test, F2=4f2-3(f2-Δf)=f2+3Δf=higher edge frequency.

F1=718MHz,F2=767MHz

1.5.2 Input power:-20dBm

Table with 4 columns: measure frequency, product Value (dBm), Limit (dBm), and Margin (dB). Rows include 3rd, 5th, and 7th order products with lower and higher edge test results.

Remark:

No other intermodulation spurious emissions of above 7th have been found,so only record the test data about the 3rd, 5th and 7th



7.2.3.2 Measurement Record:

1. Downlink: 862MHz to 869MHz(CDMA,WCDMA,LTE)

1.1 CDMA Mode:

1.1.1 one signal input —Lower Edge

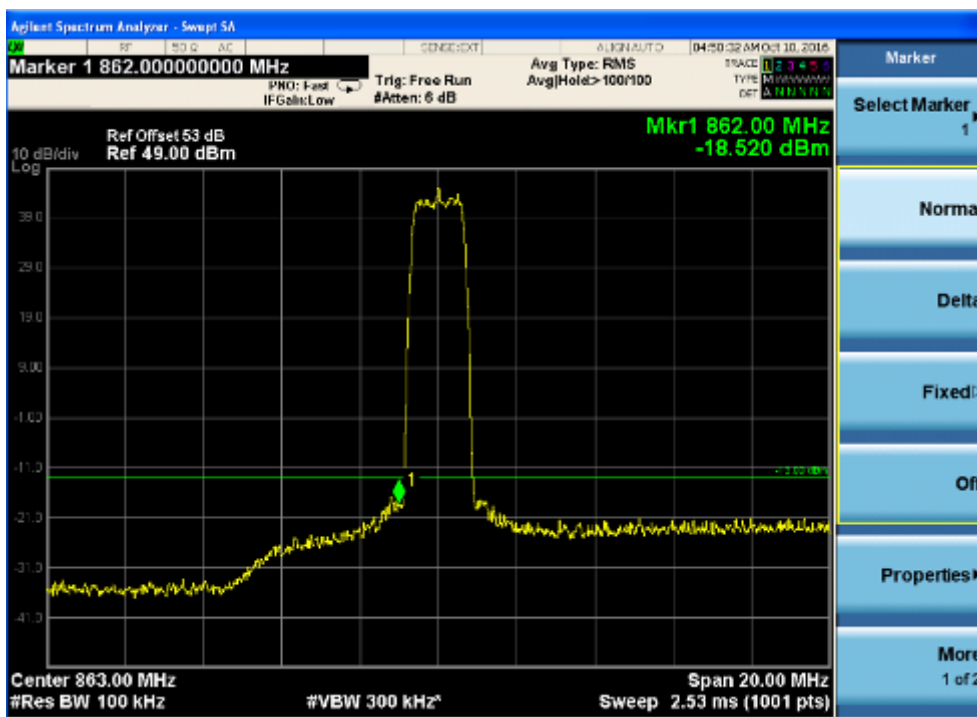

1.1.2 one signal input — Upper Edge

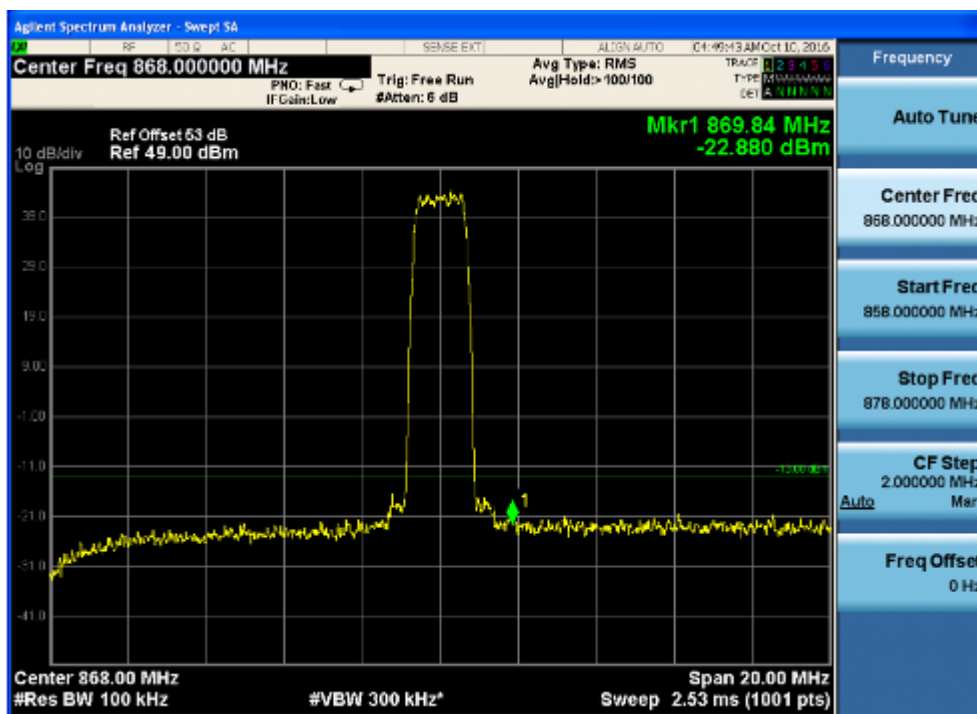



1.1.3 two signal input—Lower Edge

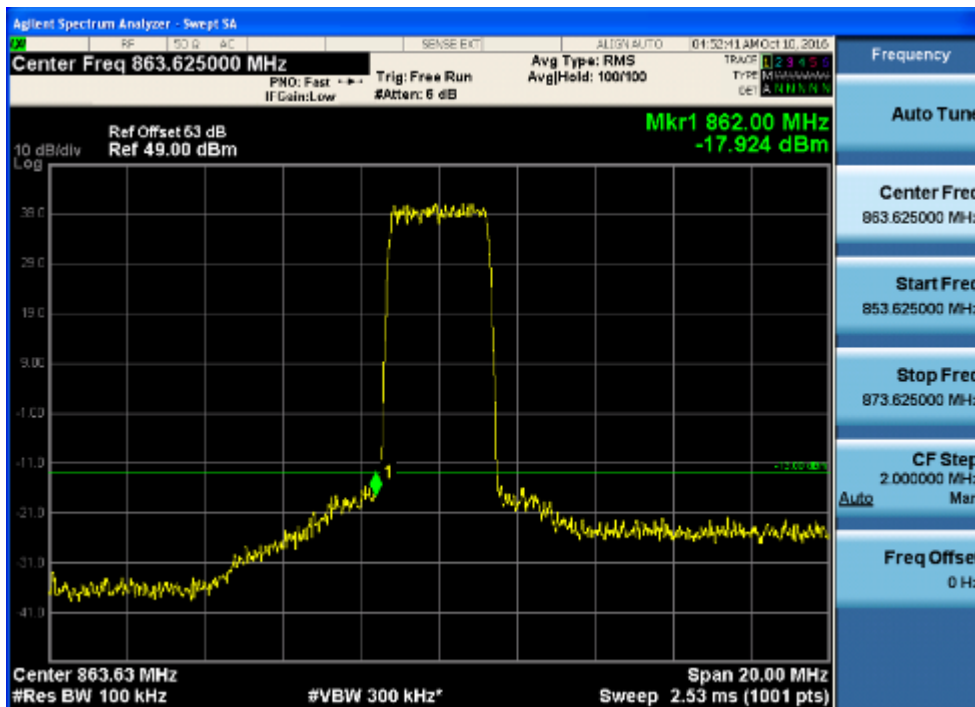

1.1.4 two signal input—Upper Edge

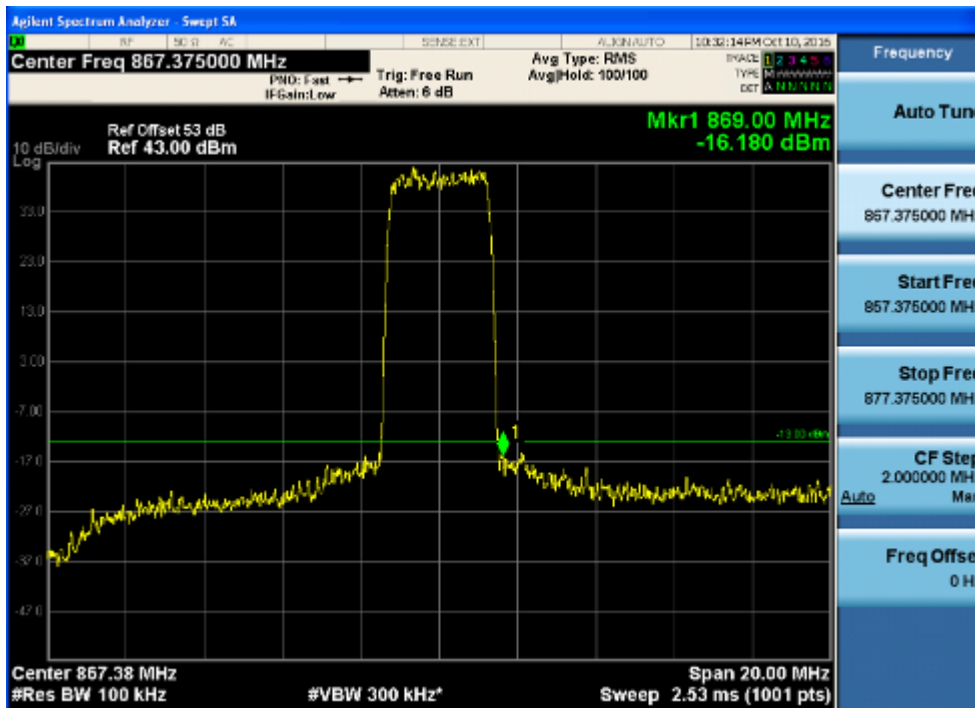



1.2 WDMA Mode:

1.2.1 one signal input —Lower Edge

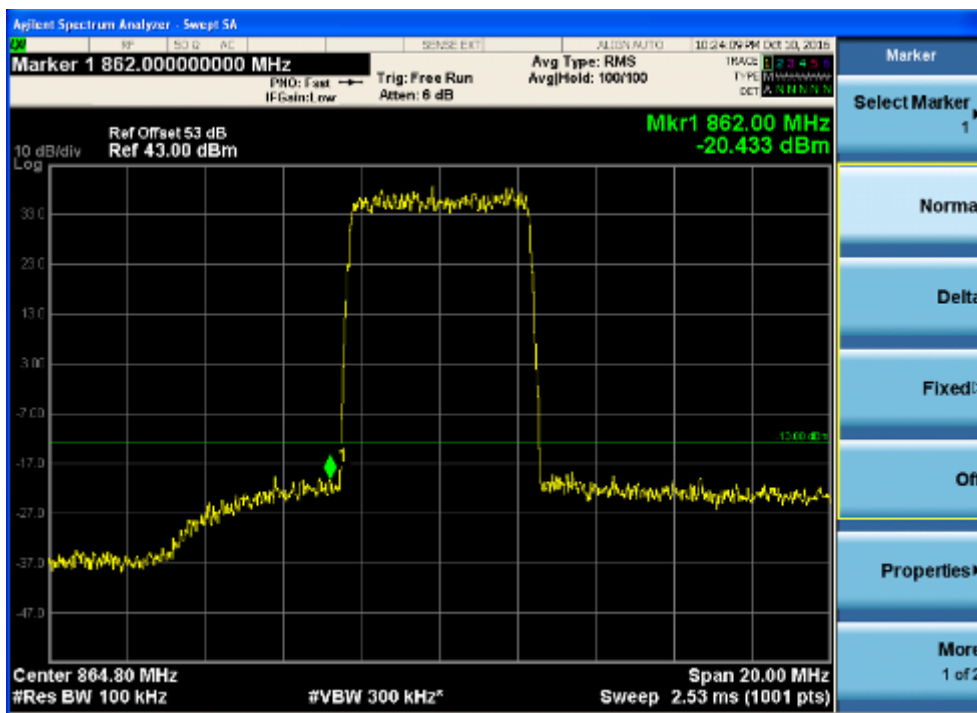

1.2.2 one signal input — Upper Edge

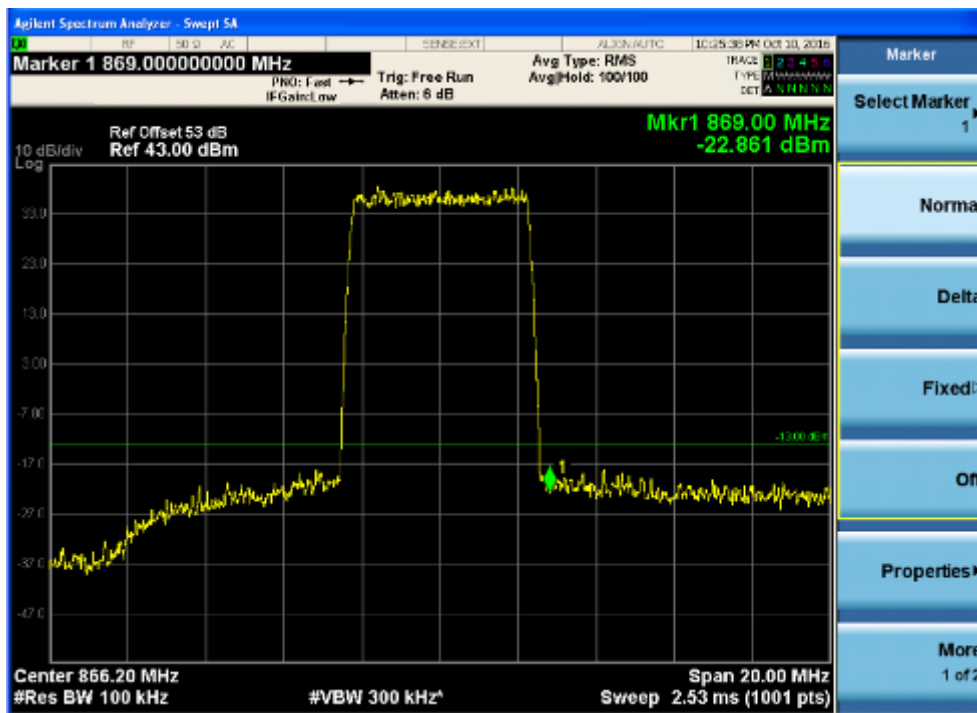



1.3 LTE Mode:

1.3.1 one signal input —Lower Edge

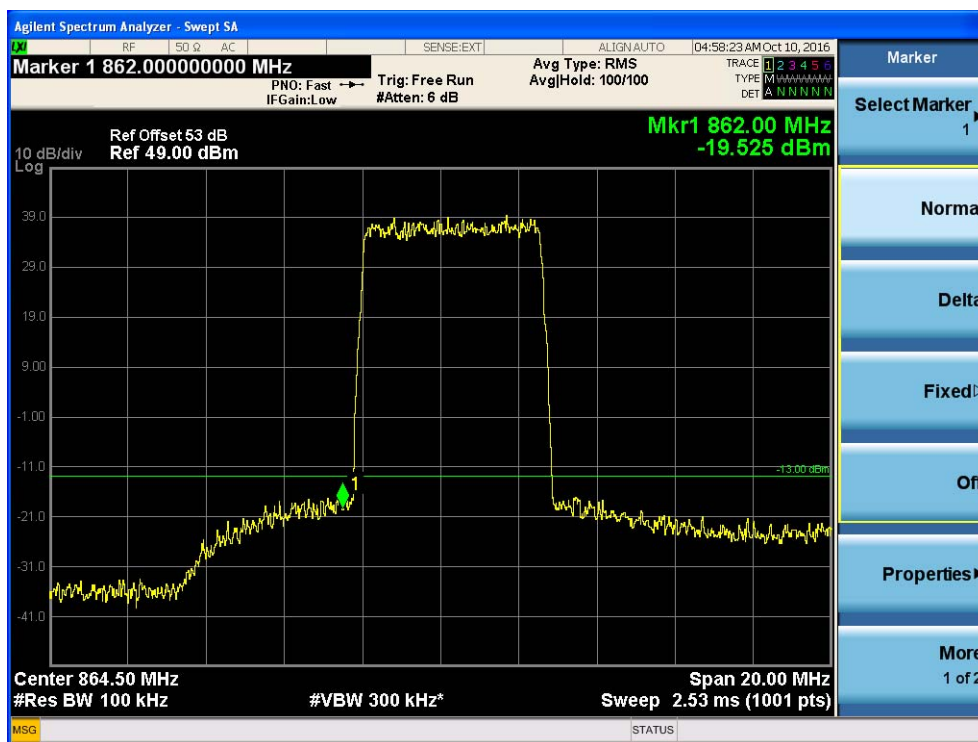

1.3.2 one signal input — Upper Edge

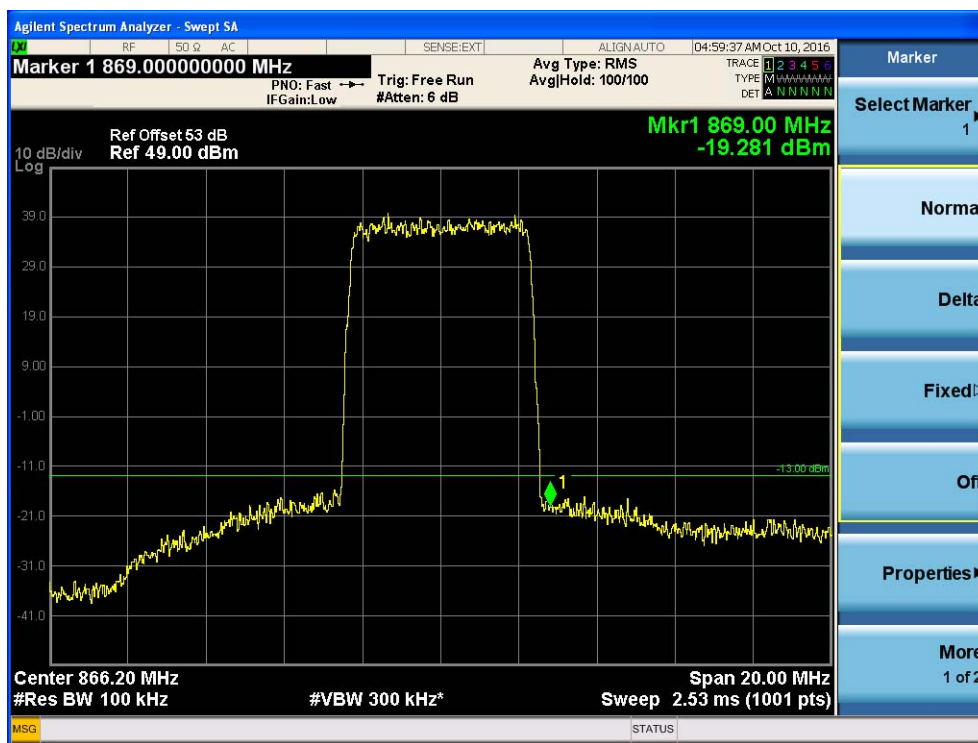



1.4 intermodulation spurious emissions

1.4.1 For CDMA mode:

Input frequency:

1)in lower edge test:f1 is the lower edge frequency +1 channel frequency, and f2 is +2 channel frequency

f1=863MHz,f2=864MHz

2)in higher edge test:f1 is the higher edge frequency -2 channel frequency, and f2 is -1 channel frequency

f1=868MHz,f2=867MHz

base the 3rd product frequency F1= 2f1-f2 and F2=2f2-f1, when the f1 and f2 frequency select above,

c) in lower edge test, F1=2f1-(f1+Δf)=f1-Δf=lower edge frequency;

d) in higher edge test, F2=2f2-(f2-Δf)=f2+Δf=higher edge frequency.

F1=862MHz,F2=869MHz

base the 5rd product frequency F1= 3f1-2f2 and F2=3f2-2f1, when the f1 and f2 frequency select above,

c) in lower edge test, F1=3f1-2(f1+Δf)=f1-2Δf=lower edge frequency;

d) in higher edge test, F2=3f2-2(f2-Δf)=f2+2Δf=higher edge frequency.

F1=861MHz,F2=870MHz

base the 7rd product frequency F1= 4f1-3f2 and F2=4f2-3f1, when the f1 and f2 frequency select above,

c) in lower edge test, F1=4f1-3(f1+Δf)=f1-3Δf=lower edge frequency;

d) in higher edge test, F2=4f2-3(f2-Δf)=f2+3Δf=higher edge frequency.

F1=860MHz,F2=871MHz

Input power:-20dBm

measure frequency		product Value (dBm)	Limit (dBm)	Over Limit(dB)
3 rd	Lower:862MHz	-17.92	-13dBm	-4.92
	Higher:869MHz	-16.18		-3.18
5 rd	Lower:861MHz	-23.45	-13dBm	-10.45
	Higher:870MHz	-23.67		-10.67
7 rd	Lower:860MHz	-26.29	-13dBm	-13.29
	Higher:871MHz	-27.23		-14.23



2. Downlink: 869MHz to 894MHz(GSM,CDMA,WCDMA,LTE)

2.1 GSM Mode:

2.1.1 one signal input —Lower Edge

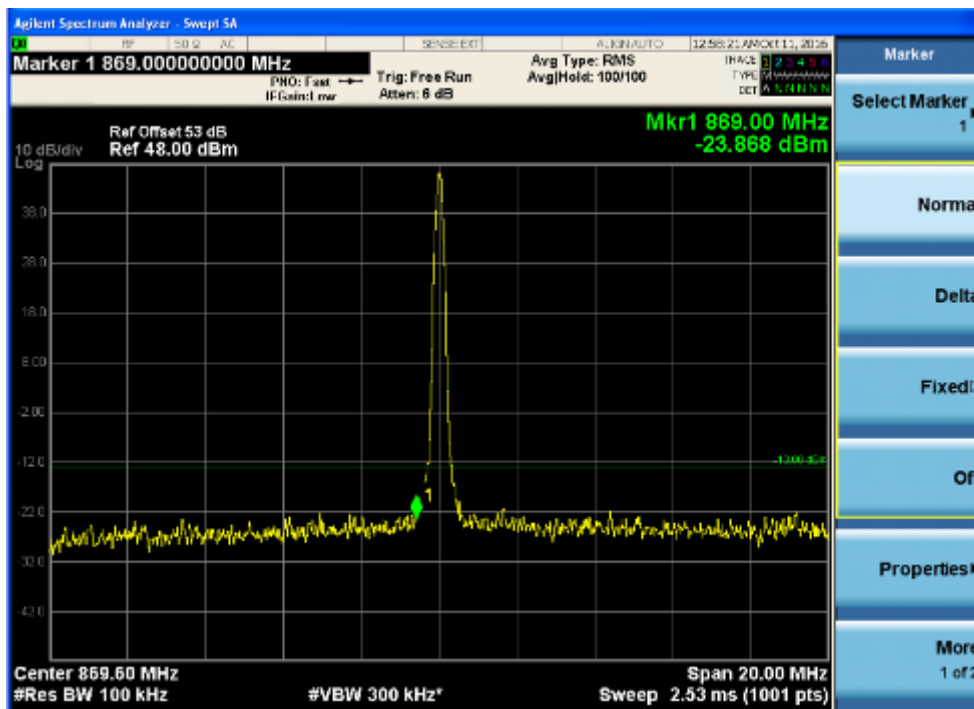

2.1.2 one signal input — Upper Edge

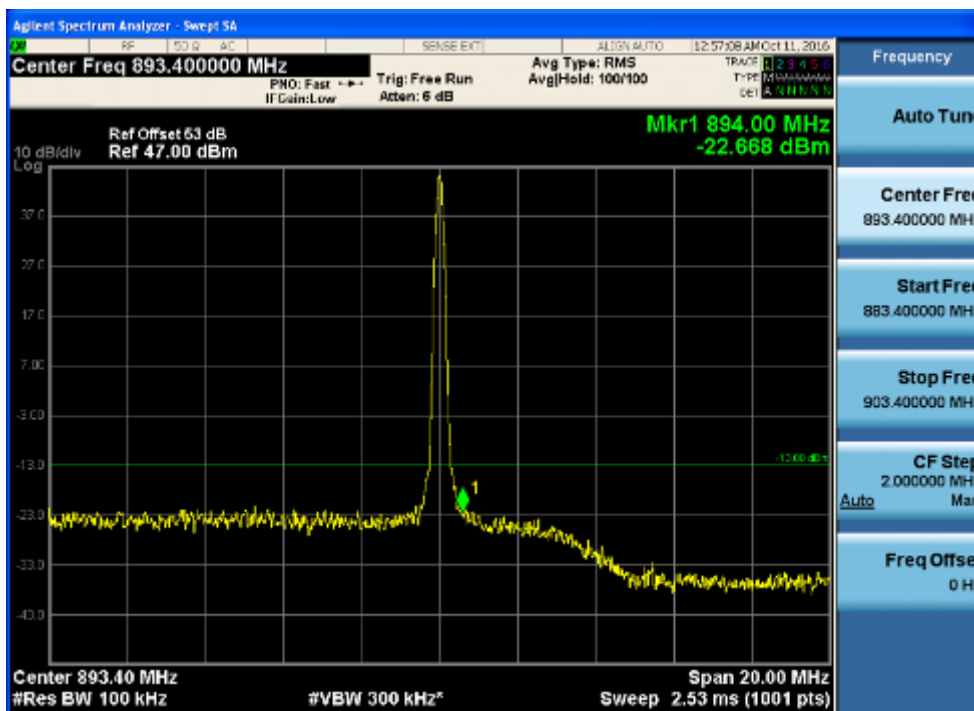



2.1.3 two signal input—Lower Edge

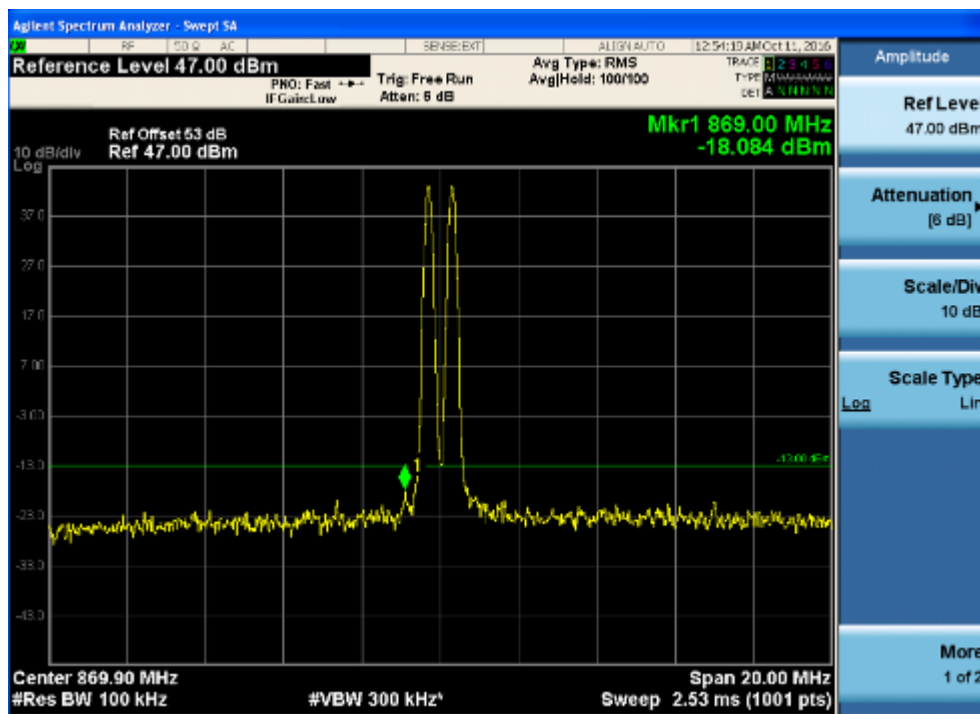

2.1.4 two signal input—Upper Edge

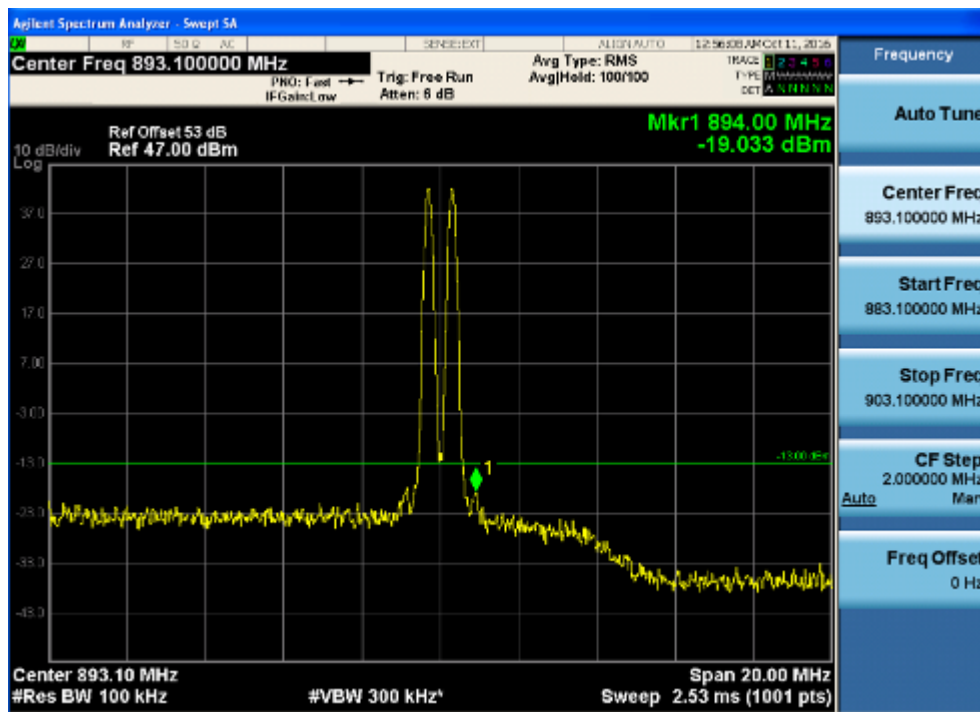



2.2 CDMA Mode:

2.2.1 one signal input —Lower Edge

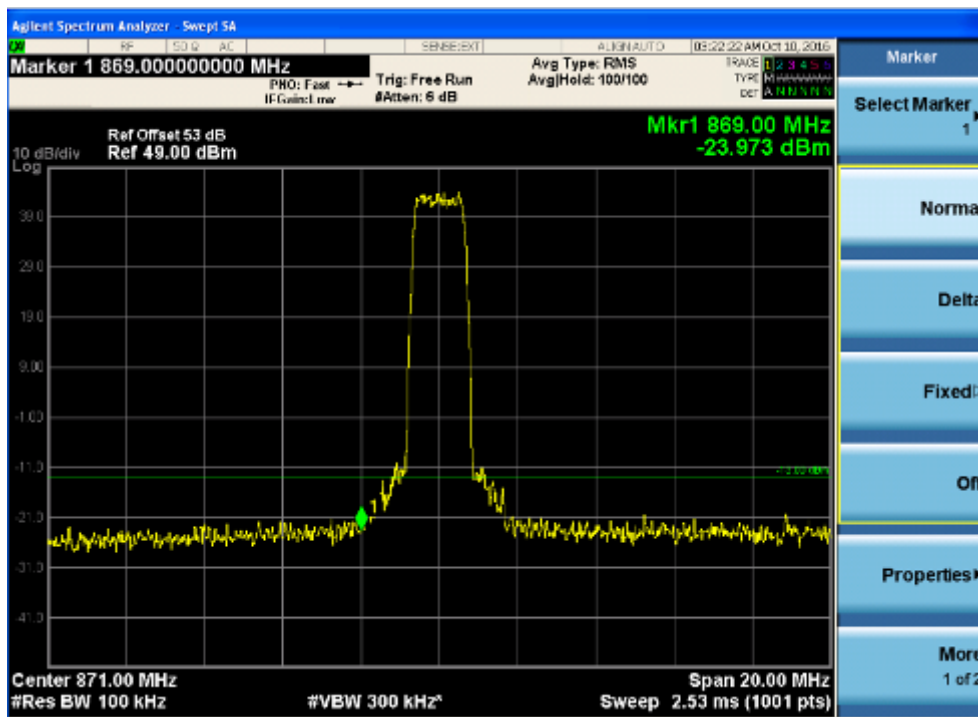

2.2.2 one signal input — Upper Edge

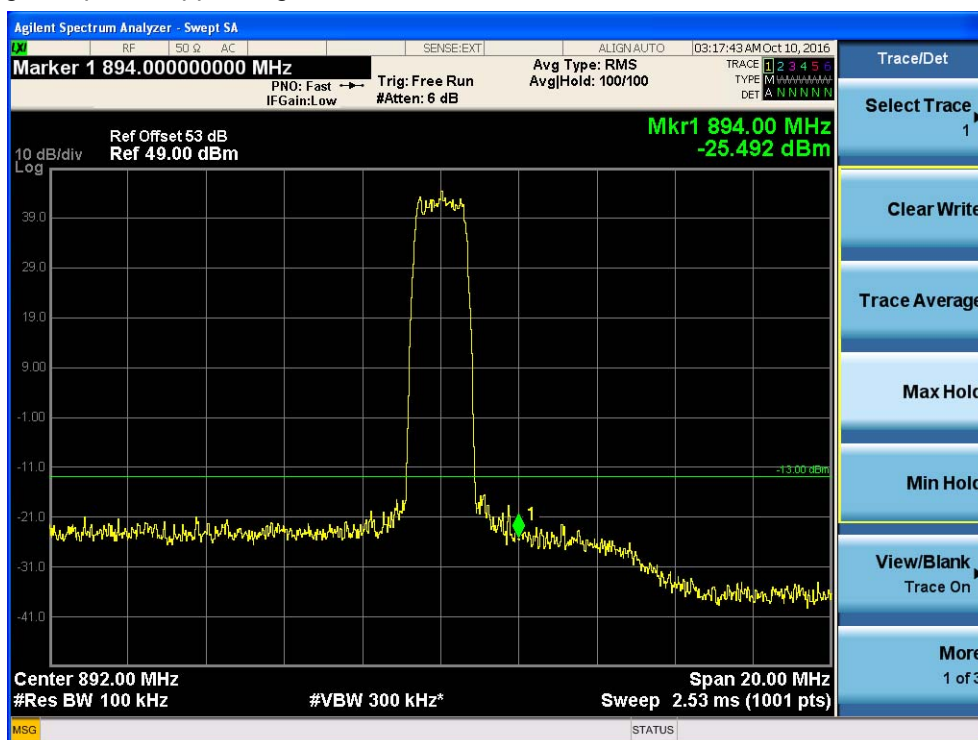



2.2.3 two signal input —Lower Edge

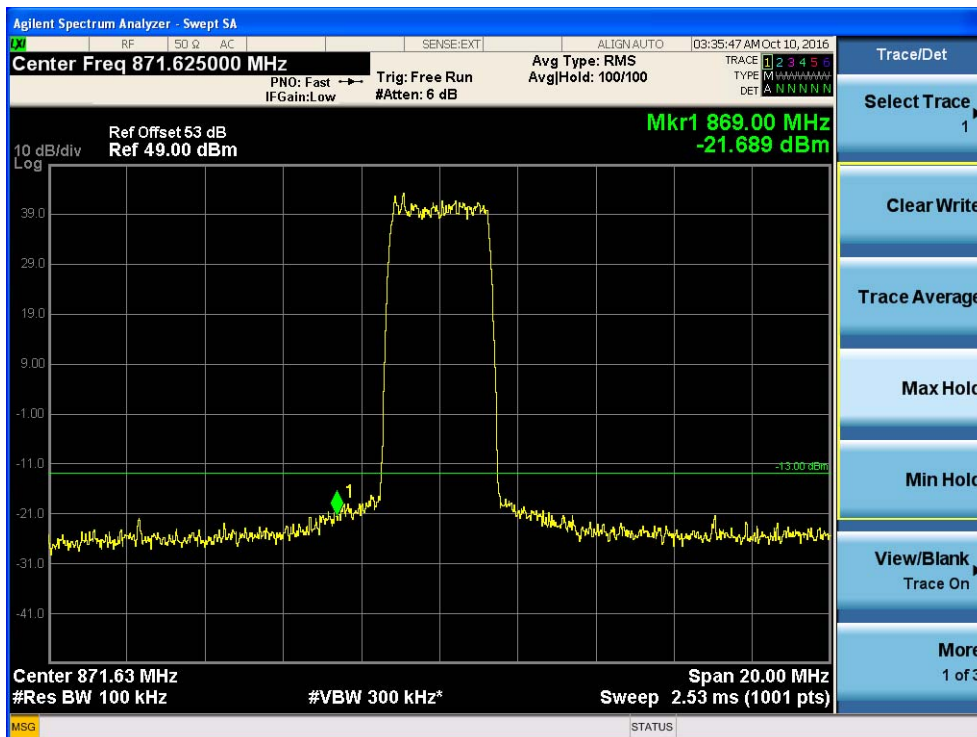

2.2.4 two signal input —Upper Edge

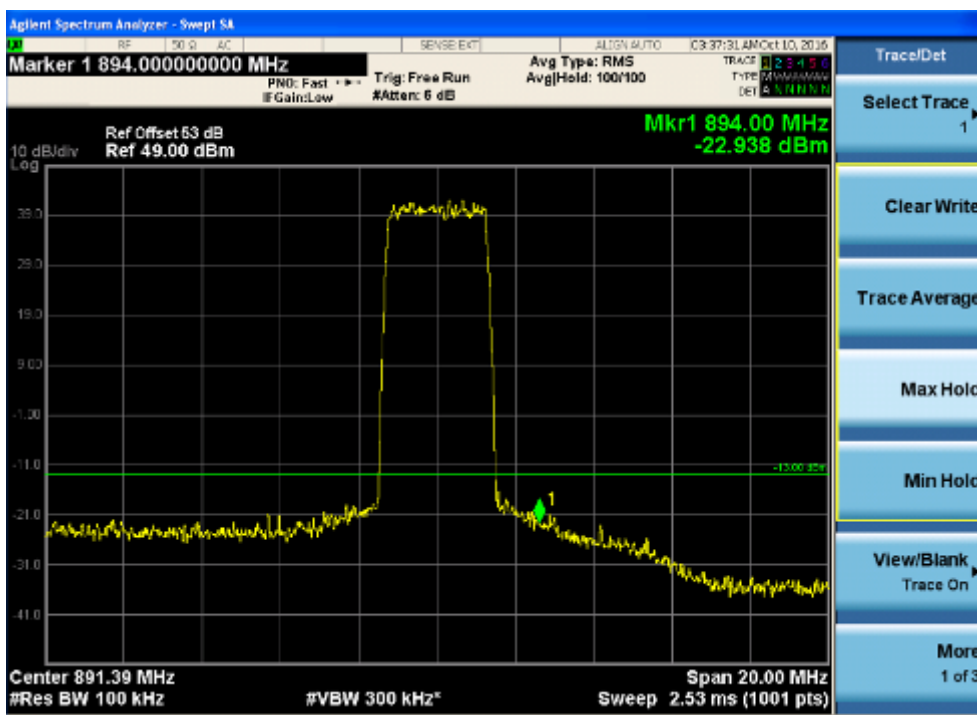



2.3 WDMA Mode:

2.3.1 one signal input —Lower Edge

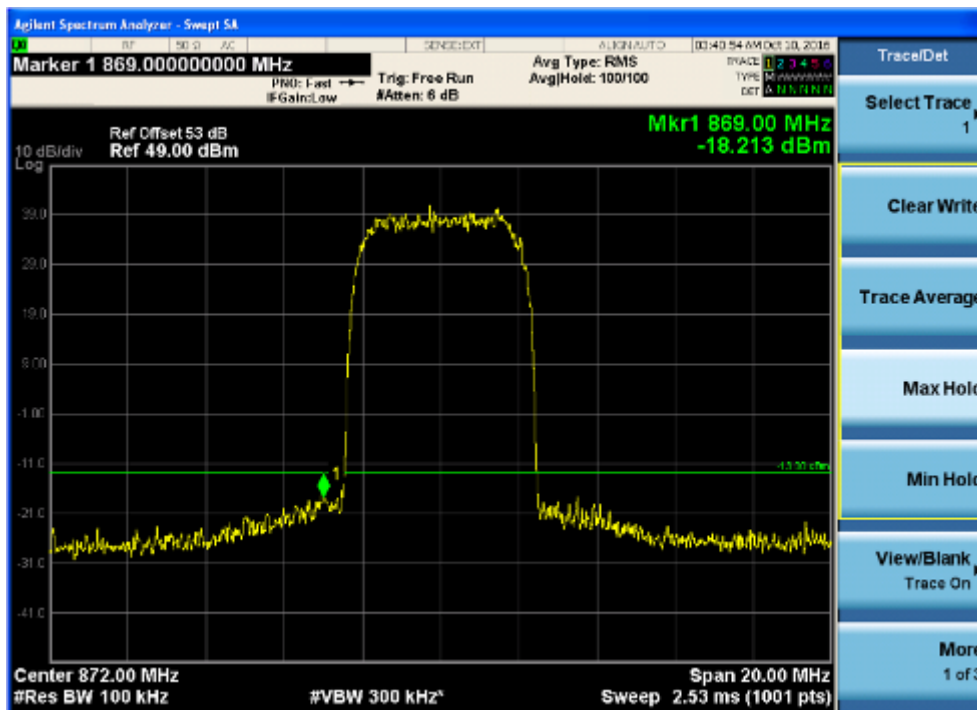

2.3.2 one signal input — Upper Edge

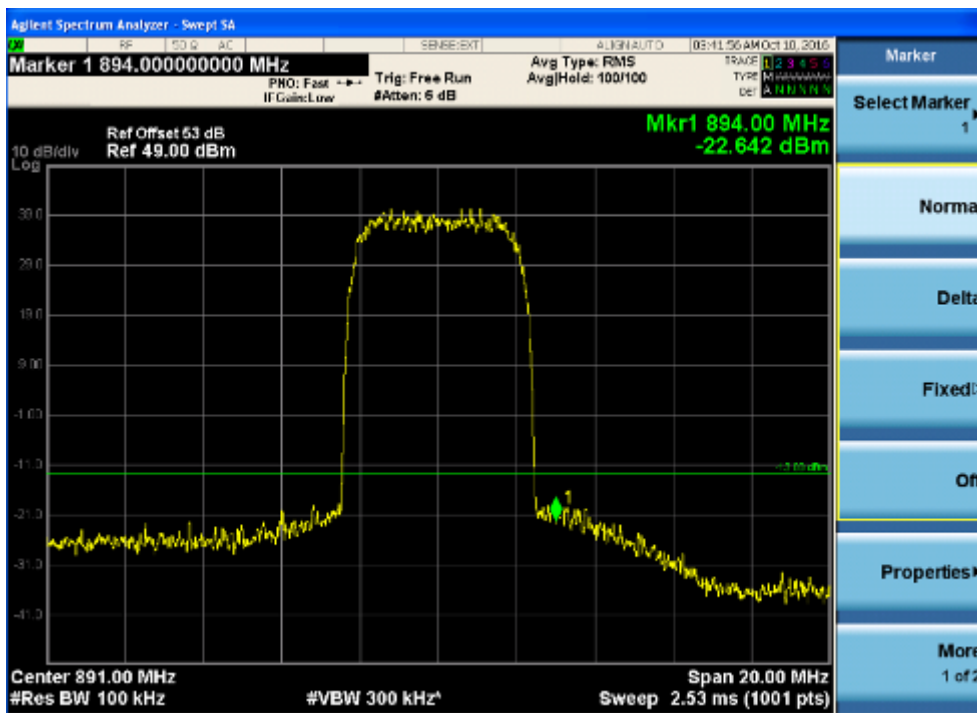

2.3.3 two signal input —Lower Edge

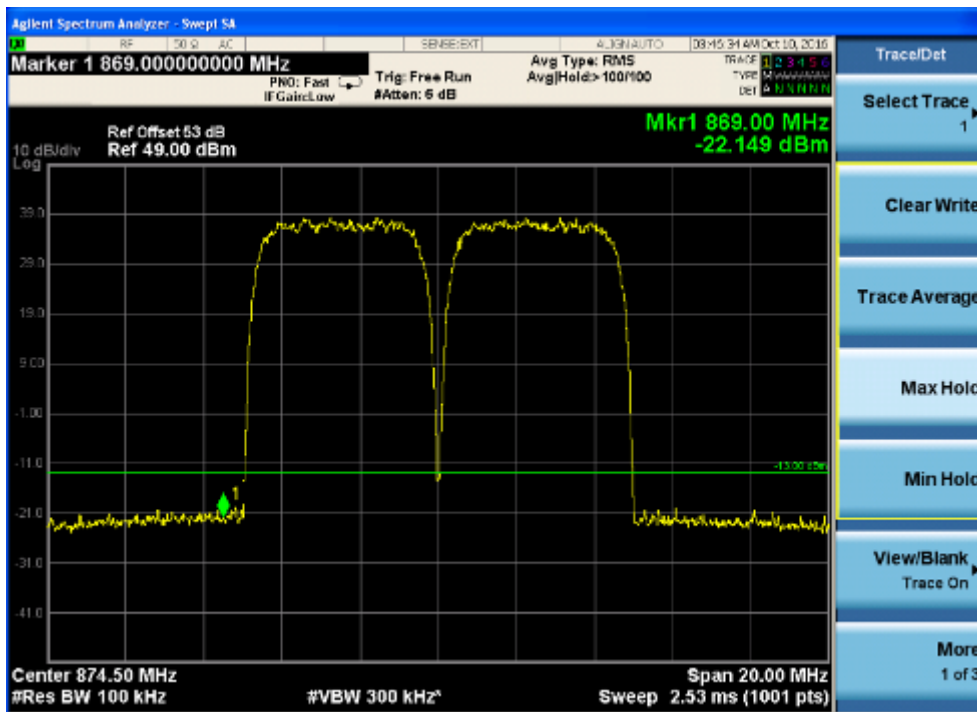

2.3.4 two signal input —Upper Edge

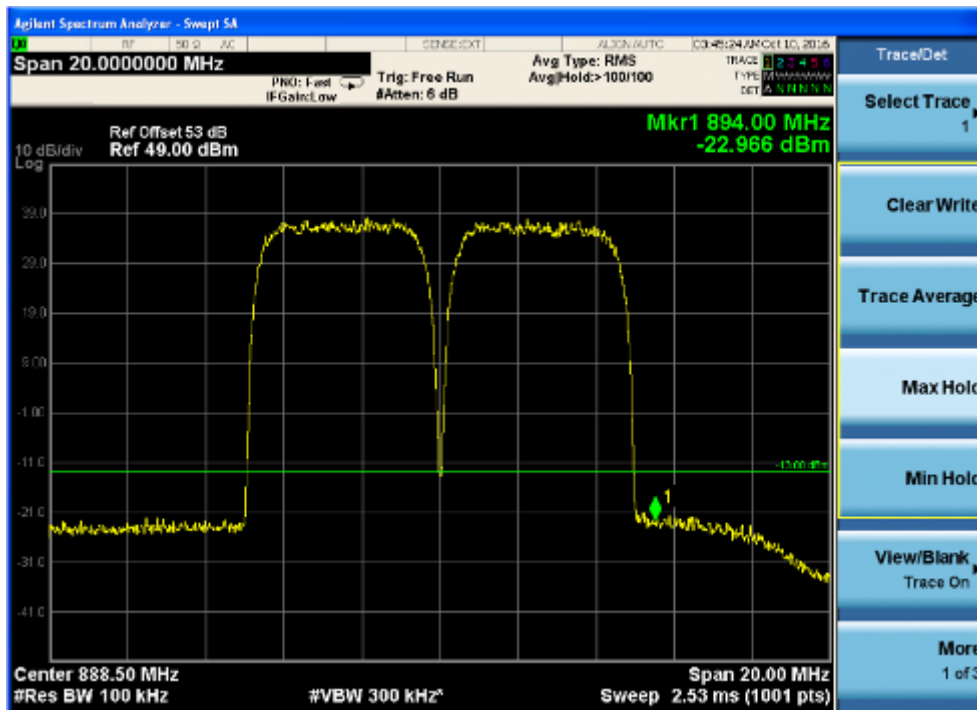



2.4 LTE Mode:

2.4.1 one signal input —Lower Edge

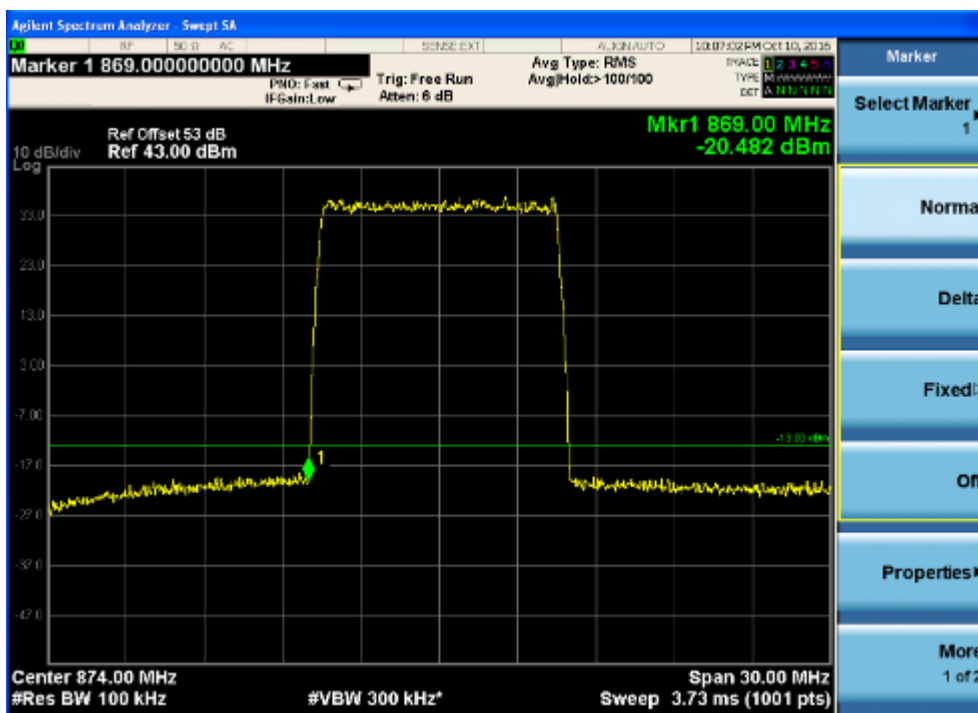

2.4.2 one signal input — Upper Edge

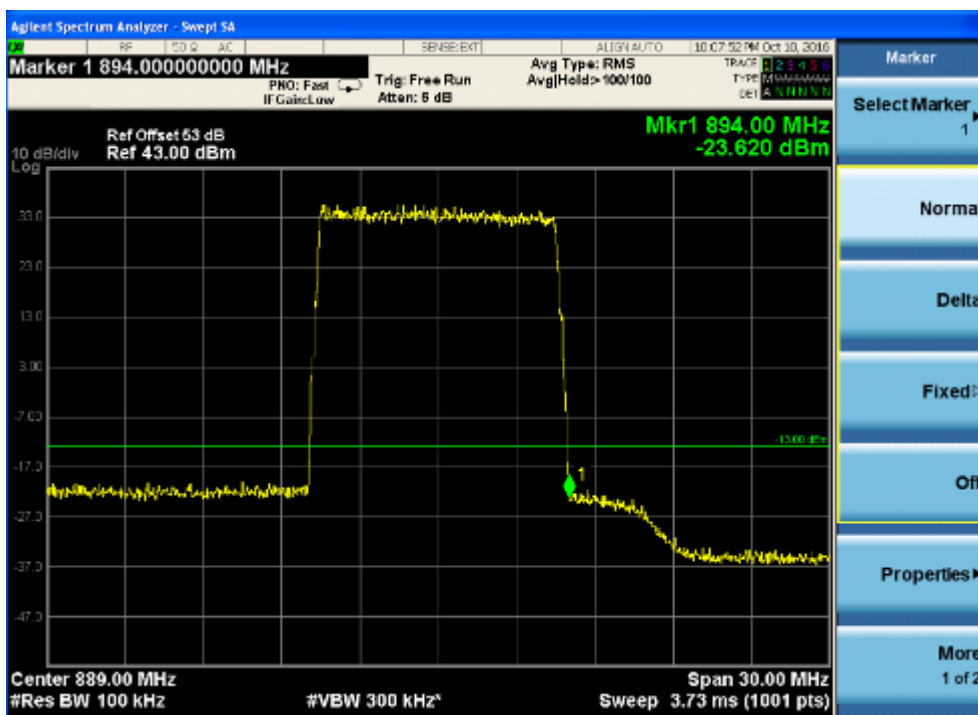



2.4.3 two signal input —Lower Edge

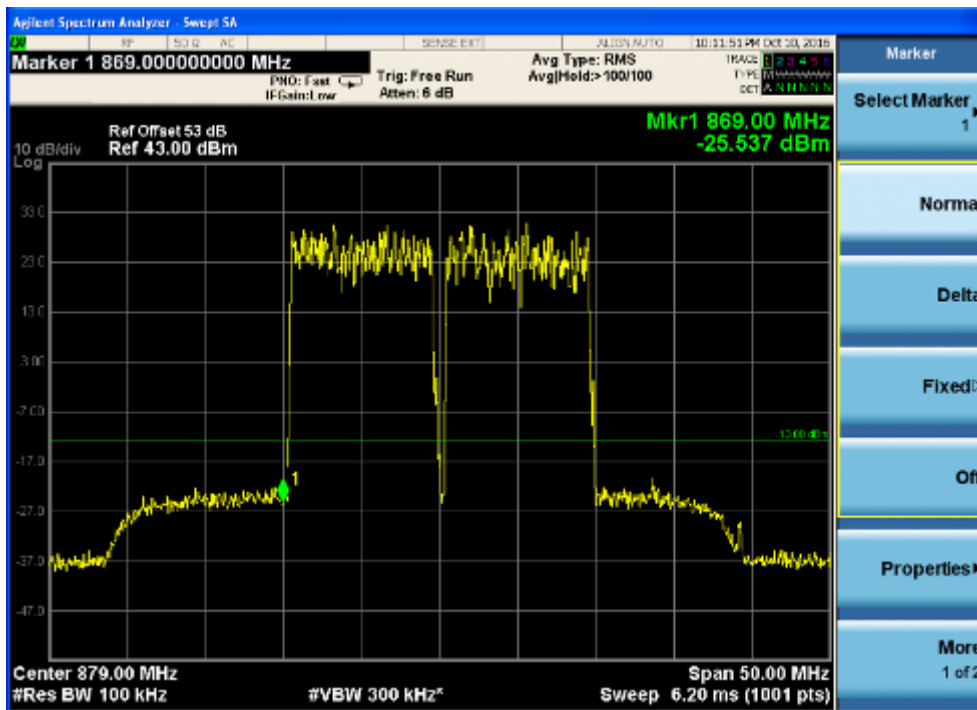

2.4.4 two signal input —Upper Edge

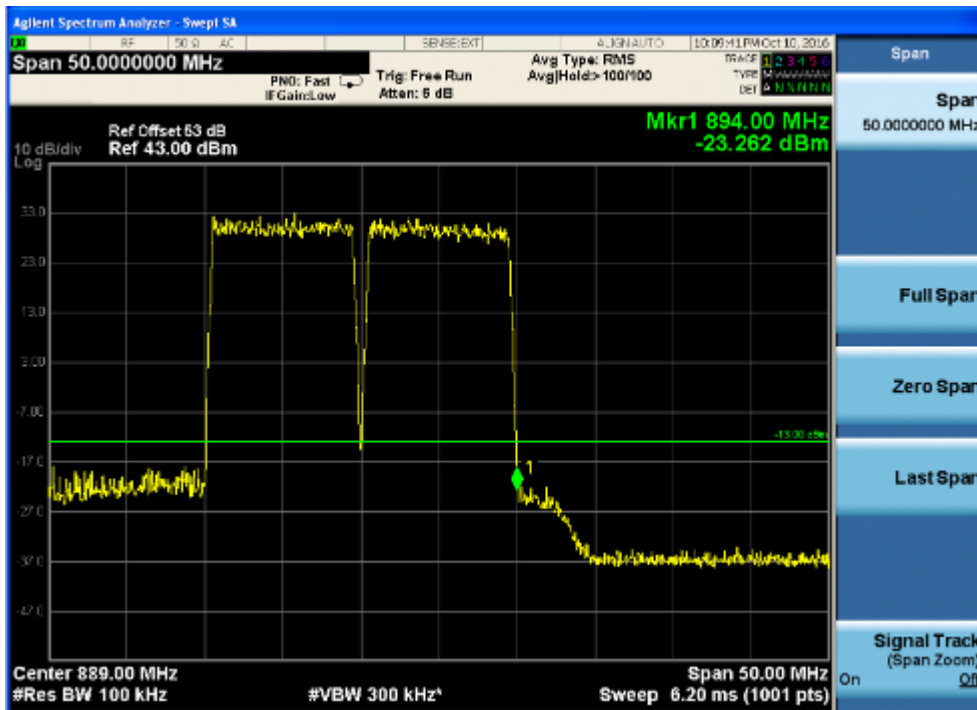



2.5 intermodulation spurious emissions

For GSM mode:

2.5.1 Input frequency:

1) in lower edge test: f1 is the lower edge frequency +1 channel frequency, and f2 is +2 channel frequency

$$f1=869.6\text{MHz}, f2=870.2\text{MHz}$$

2) in higher edge test: f1 is the higher edge frequency -2 channel frequency, and f2 is -1 channel frequency

$$f1=892.8\text{MHz}, f2=893.4\text{MHz}$$

base the 3rd product frequency $F1=2f1-f2$ and $F2=2f2-f1$, when the f1 and f2 frequency select above,

e) in lower edge test, $F1=2f1-(f1+\Delta f)=f1-\Delta f$ =lower edge frequency;

f) in higher edge test, $F2=2f2-(f2-\Delta f)=f2+\Delta f$ =higher edge frequency.

$$F1=869\text{MHz}, F2=894\text{MHz}$$

base the 5th product frequency $F1=3f1-2f2$ and $F2=3f2-2f1$, when the f1 and f2 frequency select above,

e) in lower edge test, $F1=3f1-2(f1+\Delta f)=f1-2\Delta f$ =lower edge frequency;

f) in higher edge test, $F2=3f2-2(f2-\Delta f)=f2+2\Delta f$ =higher edge frequency.

$$F1=868.4\text{MHz}, F2=894.6\text{MHz}$$

base the 7th product frequency $F1=4f1-3f2$ and $F2=4f2-3f1$, when the f1 and f2 frequency select above,

e) in lower edge test, $F1=4f1-3(f1+\Delta f)=f1-3\Delta f$ =lower edge frequency;

f) in higher edge test, $F2=4f2-3(f2-\Delta f)=f2+3\Delta f$ =higher edge frequency.

$$F1=867.8\text{MHz}, F2=895.2\text{MHz}$$

2.5.2 Input power:-20dBm

measure frequency		product Value (dBm)	Limit (dBm)	Margin (dB)
3 rd	Lower:869MHz	-18.08	-13dBm	-5.08
	Higher:894MHz	-19.03		-6.03
5 th	Lower:868.4MHz	-20.65	-13dBm	-7.65
	Higher:894.6MHz	-21.07		-8.07
7 th	Lower:867.8MHz	-21.58	-13dBm	-8.58
	Higher:895.2MHz	-21.76		-8.76



For CDMA mode:

2.5.3 Input frequency:

1)in lower edge test:f1 is the lower edge frequency +1 channel frequency, and f2 is +2 channel frequency

f1=871MHz,f2=873MHz

2)in higher edge test:f1 is the higher edge frequency -2 channel frequency, and f2 is -1 channel frequency

f1=890MHz,f2=892MHz

base the 3rd product frequency F1= 2f1-f2 and F2=2f2-f1, when the f1 and f2 frequency select above,

g) in lower edge test, F1=2f1-(f1+Δf)=f1-Δf=lower edge frequency;

h) in higher edge test, F2=2f2-(f2-Δf)=f2+Δf=higher edge frequency.

F1=869MHz,F2=894MHz

base the 5th product frequency F1= 3f1-2f2 and F2=3f2-2f1, when the f1 and f2 frequency select above,

g) in lower edge test, F1=3f1-2(f1+Δf)=f1-2Δf=lower edge frequency;

h) in higher edge test, F2=3f2-2(f2-Δf)=f2+2Δf=higher edge frequency.

F1=867MHz,F2=896MHz

base the 7th product frequency F1= 4f1-3f2 and F2=4f2-3f1, when the f1 and f2 frequency select above,

g) in lower edge test, F1=4f1-3(f1+Δf)=f1-3Δf=lower edge frequency;

h) in higher edge test, F2=4f2-3(f2-Δf)=f2+3Δf=higher edge frequency.

F1=865MHz,F2=898MHz

2.5.4 Input power:-20dBm

measure frequency		product Value (dBm)	Limit (dBm)	Magin (dB)
3 rd	Lower:869MHz	-21.69	-13dBm	-8.69
	Higher:894MHz	-24.29		-11.29
5 rd	Lower:867MHz	-25.37	-13dBm	-12.37
	Higher:896MHz	-25.45		-12.45
7 rd	Lower:865MHz	-26.53	-13dBm	-13.53
	Higher:898MHz	-26.62		-13.62



For WCDMA mode:

2.5.5 Input frequency:

1)in lower edge test:f1 is the lower edge frequency +1 channel frequency, and f2 is +2 channel frequency

f1=872MHz,f2=875MHz

2)in higher edge test:f1 is the higher edge frequency -2 channel frequency, and f2 is -1 channel frequency

f1=888MHz,f2=891MHz

base the 3rd product frequency F1= 2f1-f2 and F2=2f2-f1, when the f1 and f2 frequency select above,

i) in lower edge test, F1=2f1-(f1+Δf)=f1-Δf=lower edge frequency;

j) in higher edge test, F2=2f2-(f2-Δf)=f2+Δf=higher edge frequency.

F1=869MHz,F2=894MHz

base the 5th product frequency F1= 3f1-2f2 and F2=3f2-2f1, when the f1 and f2 frequency select above,

i) in lower edge test, F1=3f1-2(f1+Δf)=f1-2Δf=lower edge frequency;

j) in higher edge test, F2=3f2-2(f2-Δf)=f2+2Δf=higher edge frequency.

F1=866MHz,F2=897MHz

base the 7th product frequency F1= 4f1-3f2 and F2=4f2-3f1, when the f1 and f2 frequency select above,

i) in lower edge test, F1=4f1-3(f1+Δf)=f1-3Δf=lower edge frequency;

j) in higher edge test, F2=4f2-3(f2-Δf)=f2+3Δf=higher edge frequency.

F1=863MHz,F2=900MHz

2.5.6 Input power:-20dBm

measure frequency		product Value (dBm)	Limit (dBm)	Margin (dB)
3 rd	Lower:869MHz	-22.15	-13dBm	-9.15
	Higher:894MHz	-22.97		-9.97
5 rd	Lower:866MHz	-22.54	-13dBm	-9.54
	Higher:897MHz	-22.65		-9.65
7 rd	Lower:863MHz	-22.59	-13dBm	-9.59
	Higher:900MHz	-22.62		-9.62



For LTE mode:

2.5.7 Input frequency:

1)in lower edge test:f1 is the lower edge frequency +1 channel frequency, and f2 is +2 channel frequency

f1=874MHz,f2=884MHz

2)in higher edge test:f1 is the higher edge frequency -2 channel frequency, and f2 is -1 channel frequency

f1=879MHz,f2=889MHz

base the 3rd product frequency F1= 2f1-f2 and F2=2f2-f1, when the f1 and f2 frequency select above,

k) in lower edge test, F1=2f1-(f1+Δf)=f1-Δf=lower edge frequency;

l) in higher edge test, F2=2f2-(f2-Δf)=f2+Δf=higher edge frequency.

F1=869MHz,F2=894MHz

base the 5rd product frequency F1= 3f1-2f2 and F2=3f2-2f1, when the f1 and f2 frequency select above,

k) in lower edge test, F1=3f1-2(f1+Δf)=f1-2Δf=lower edge frequency;

l) in higher edge test, F2=3f2-2(f2-Δf)=f2+2Δf=higher edge frequency.

F1=859MHz,F2=904MHz

base the 7rd product frequency F1= 4f1-3f2 and F2=4f2-3f1, when the f1 and f2 frequency select above,

k) in lower edge test, F1=4f1-3(f1+Δf)=f1-3Δf=lower edge frequency;

l) in higher edge test, F2=4f2-3(f2-Δf)=f2+3Δf=higher edge frequency.

F1=849MHz,F2=914MHz

2.5.8 Input power:-20dBm

measure frequency		product Value (dBm)	Limit (dBm)	Magin (dB)
3 rd	Lower:869MHz	-25.54	-13dBm	-12.54
	Higher:894MHz	-23.26		-10.26
5 rd	Lower:859MHz	-25.69	-13dBm	-12.69
	Higher:904MHz	-26.35		-13.35
7 rd	Lower:849MHz	-27.75	-13dBm	-14.75
	Higher:914MHz	-27.61		-14.61

Remark:

No other intermodulation spurious emissioins of above 7rd have been found,so only record the test data about the 3rd, 5rdand 7rd



3. Downlink: 1930MHz to 1995MHz(GSM,CDMA,WCDMA,LTE)

3.1 GSM Mode

3.1.1 one signal input —Lower Edge

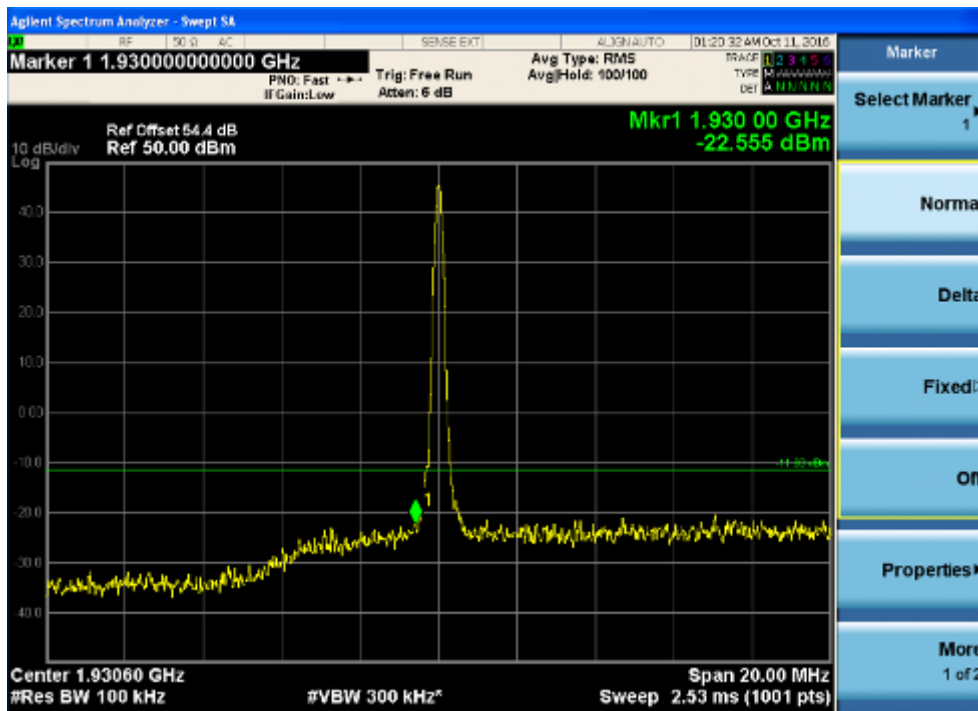

3.1.2 one signal input — Upper Edge

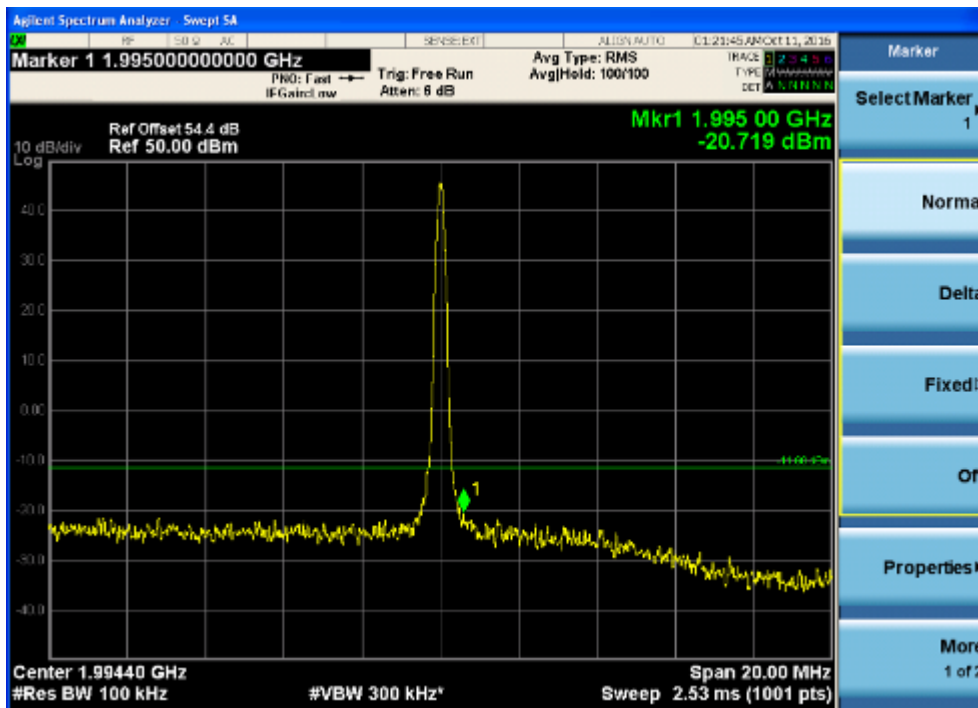

3.1.3 two signal input —Lower Edge

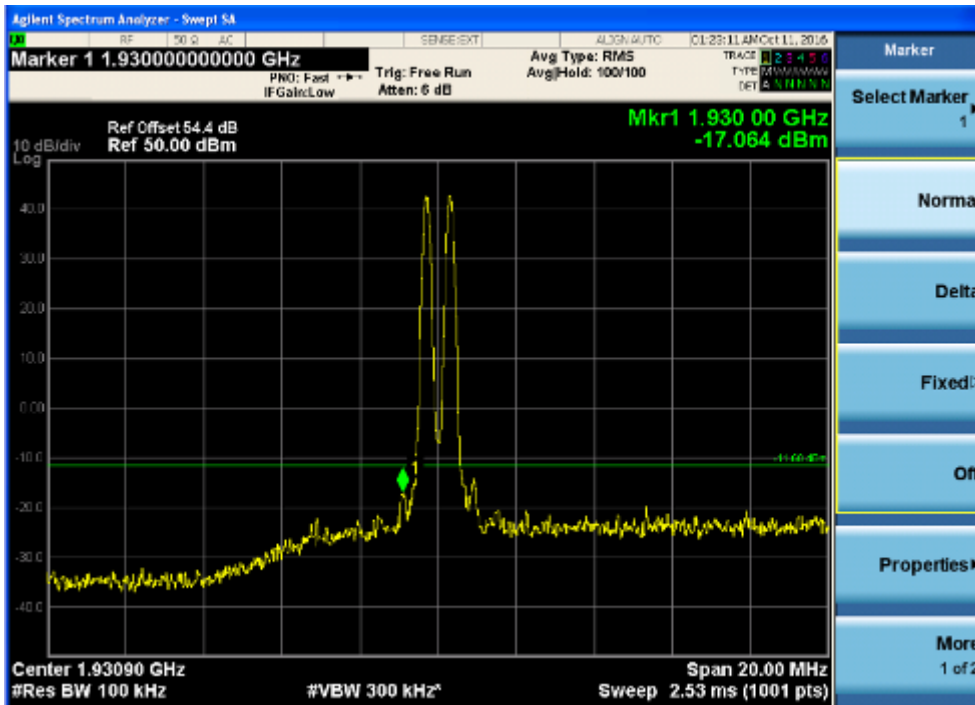

3.1.4 two signal input —Upper Edge

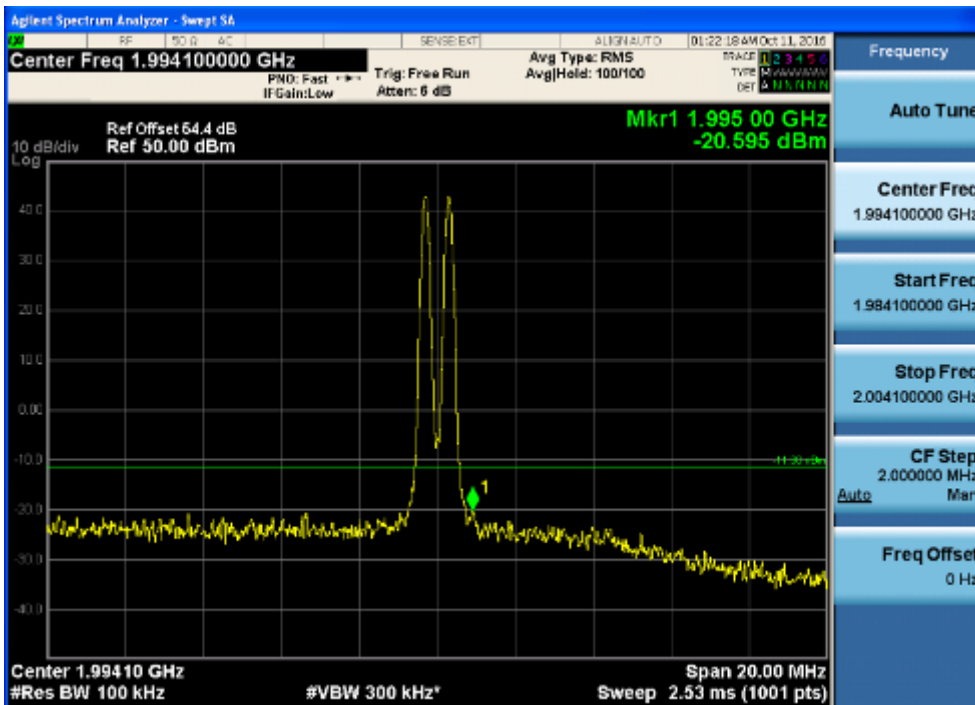



3.2 CDMA Mode:

3.2.1 one signal input —Lower Edge

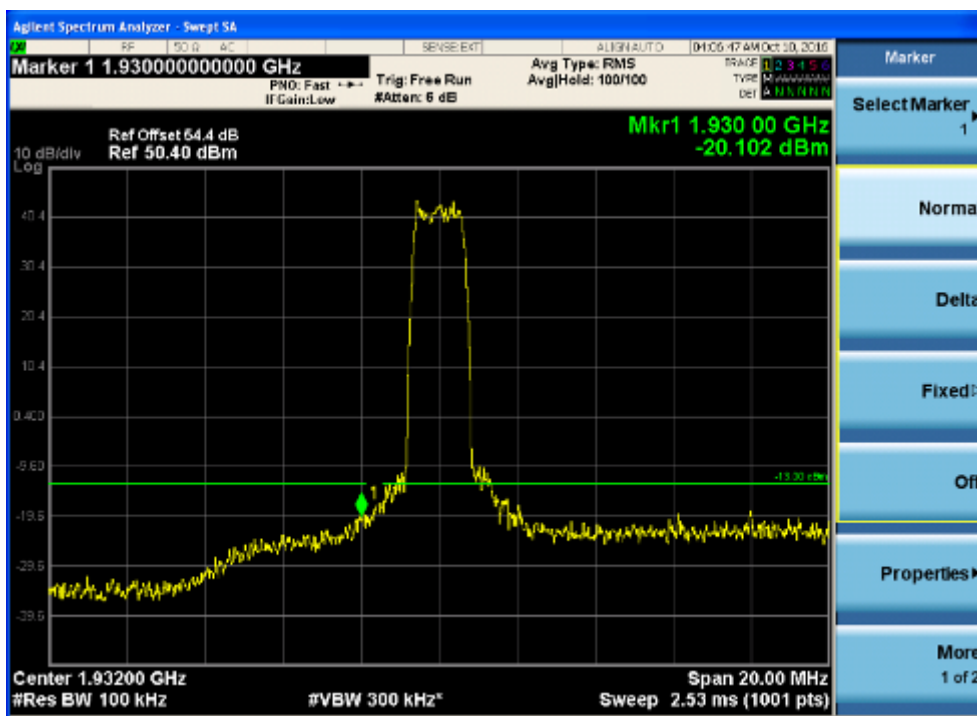

3.2.2 one signal input — Upper Edge

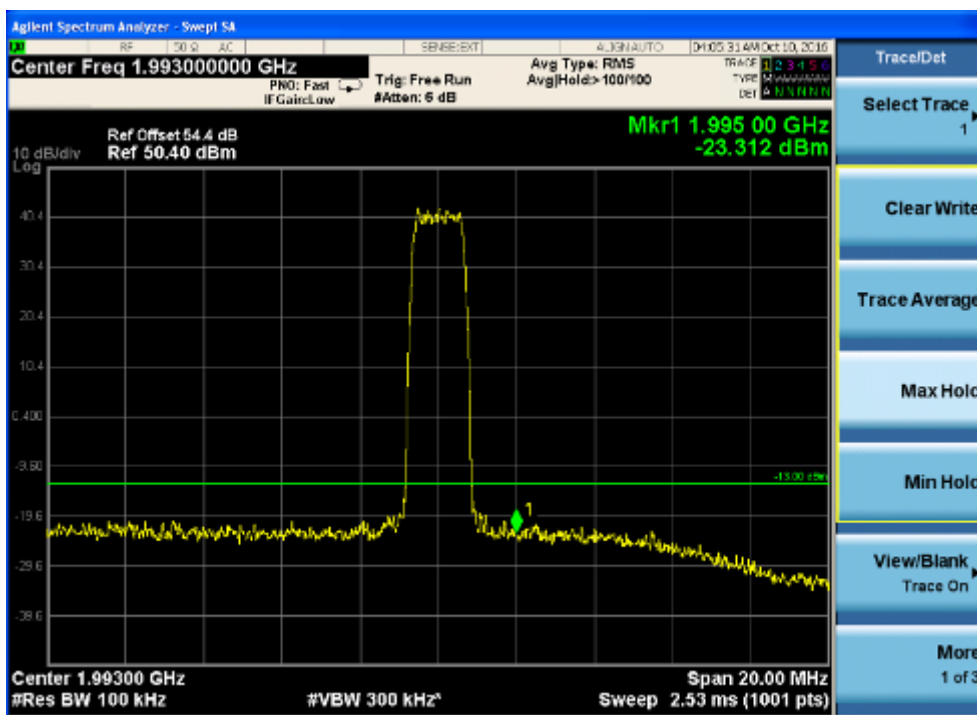

3.2.3 two signal input —Lower Edge

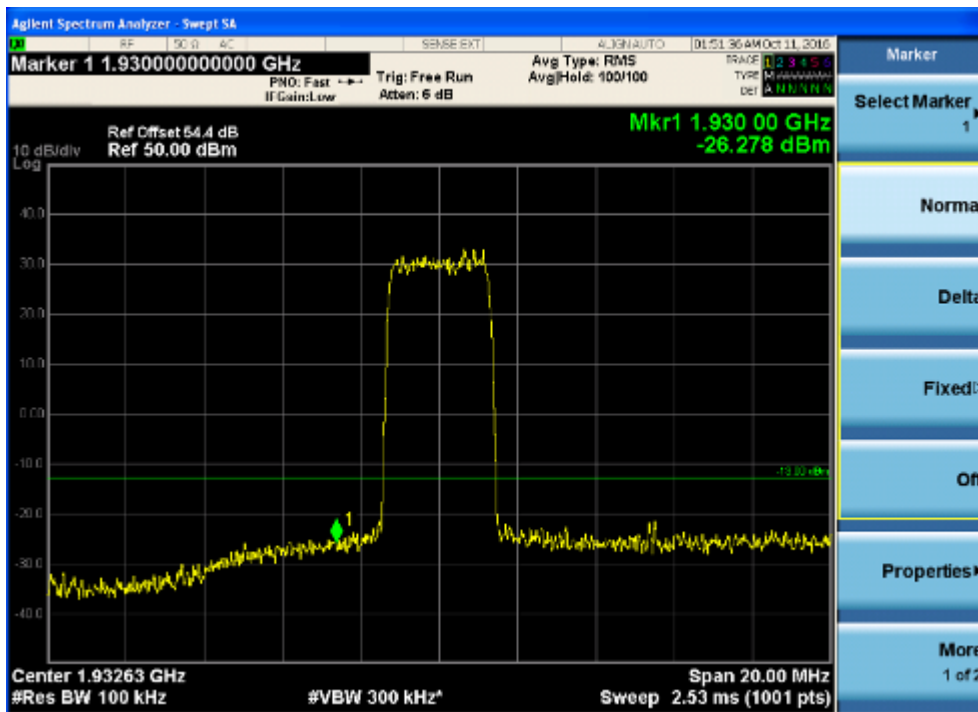

3.2.4 two signal input —Upper Edge

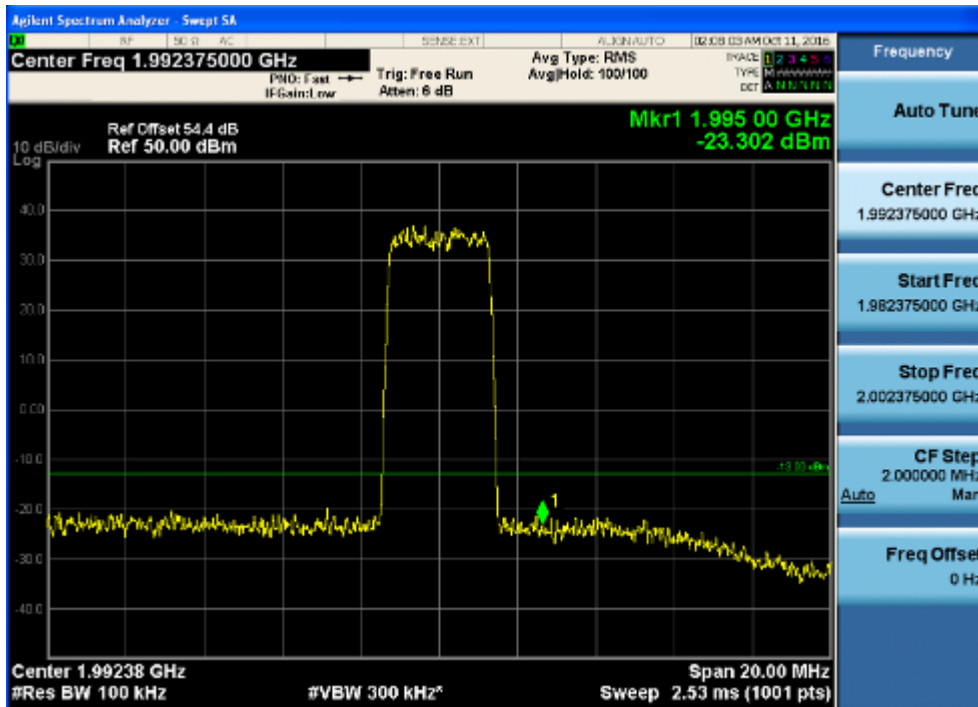



3.3 WDMA Mode:

3.3.1 one signal input —Lower Edge

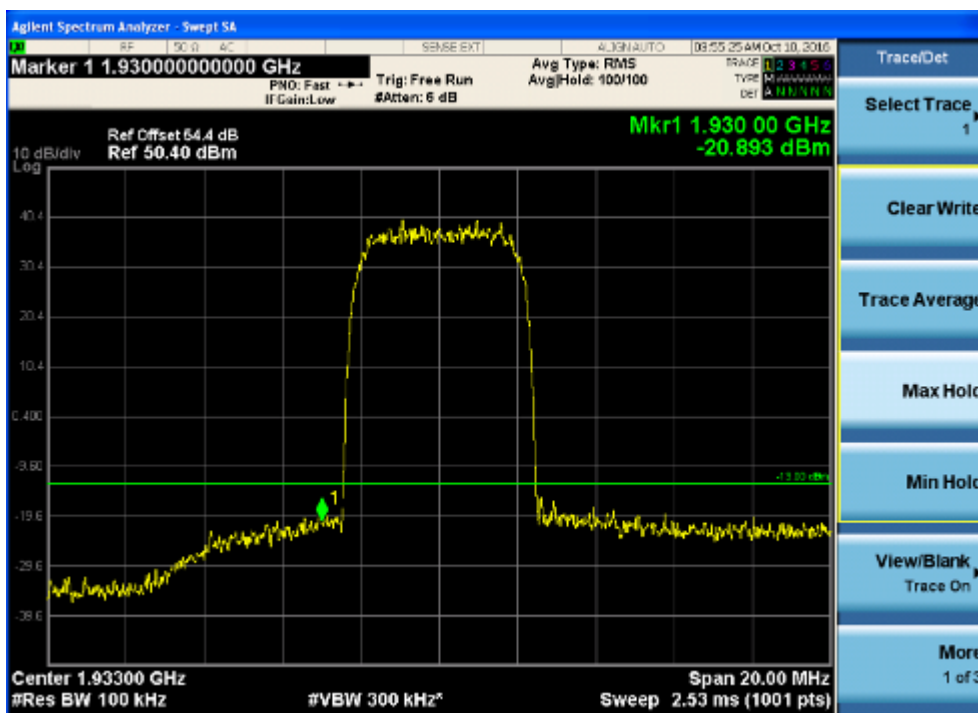

3.3.2 one signal input — Upper Edge

